

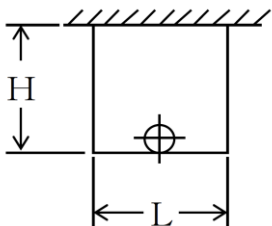

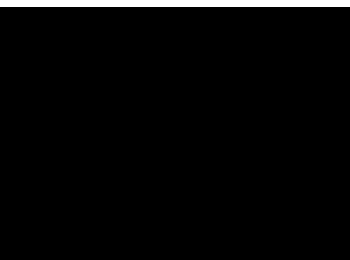
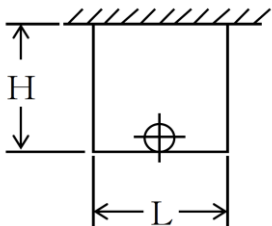
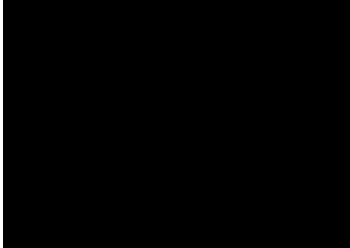
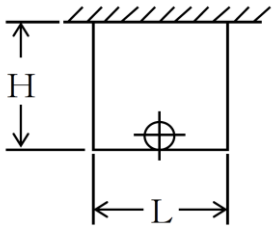

再処理施設	発電炉	備考																																																																																																																																																																																																																																																																																																																																																																																																	
添付書類IV-1-1	添付書類IV-1-1-11-1	添付書類V-2-1-12-1																																																																																																																																																																																																																																																																																																																																																																																																	
	<p style="text-align: center;">第3.1-9表(7/18) 支持架構の耐震計算結果</p> <table border="1" style="width: 100%; border-collapse: collapse;"> <thead> <tr> <th colspan="2">支持架構寸法</th> <th colspan="2">荷重(kN)</th> <th rowspan="2">鋼材サイズ</th> <th rowspan="2">組合せ応力(MPa) 発生応力</th> </tr> <tr> <th>H(mm)</th> <th>L(mm)</th> <th>水平</th> <th>鉛直</th> </tr> </thead> <tbody> <tr><td></td><td></td><td></td><td></td><td></td><td>30</td></tr> <tr><td></td><td></td><td></td><td></td><td></td><td>60</td></tr> <tr><td></td><td></td><td></td><td></td><td></td><td>148</td></tr> <tr><td></td><td></td><td></td><td></td><td></td><td>171</td></tr> <tr><td></td><td></td><td></td><td></td><td></td><td>107</td></tr> <tr><td></td><td></td><td></td><td></td><td></td><td>128</td></tr> <tr><td></td><td></td><td></td><td></td><td></td><td>135</td></tr> <tr><td></td><td></td><td></td><td></td><td></td><td>113</td></tr> <tr><td></td><td></td><td></td><td></td><td></td><td>34</td></tr> <tr><td></td><td></td><td></td><td></td><td></td><td>68</td></tr> <tr><td></td><td></td><td></td><td></td><td></td><td>170</td></tr> <tr><td></td><td></td><td></td><td></td><td></td><td>145</td></tr> <tr><td></td><td></td><td></td><td></td><td></td><td>114</td></tr> <tr><td></td><td></td><td></td><td></td><td></td><td>132</td></tr> <tr><td></td><td></td><td></td><td></td><td></td><td>137</td></tr> <tr><td></td><td></td><td></td><td></td><td></td><td>111</td></tr> <tr><td></td><td></td><td></td><td></td><td></td><td>48</td></tr> <tr><td></td><td></td><td></td><td></td><td></td><td>94</td></tr> <tr><td></td><td></td><td></td><td></td><td></td><td>133</td></tr> <tr><td></td><td></td><td></td><td></td><td></td><td>51</td></tr> <tr><td></td><td></td><td></td><td></td><td></td><td>150</td></tr> <tr><td></td><td></td><td></td><td></td><td></td><td>106</td></tr> <tr><td></td><td></td><td></td><td></td><td></td><td>147</td></tr> <tr><td></td><td></td><td></td><td></td><td></td><td>141</td></tr> <tr><td></td><td></td><td></td><td></td><td></td><td>65</td></tr> <tr><td></td><td></td><td></td><td></td><td></td><td>127</td></tr> <tr><td></td><td></td><td></td><td></td><td></td><td>179</td></tr> <tr><td></td><td></td><td></td><td></td><td></td><td>68</td></tr> <tr><td></td><td></td><td></td><td></td><td></td><td>117</td></tr> <tr><td></td><td></td><td></td><td></td><td></td><td>143</td></tr> <tr><td></td><td></td><td></td><td></td><td></td><td>118</td></tr> <tr><td></td><td></td><td></td><td></td><td></td><td>104</td></tr> <tr><td></td><td></td><td></td><td></td><td></td><td>86</td></tr> <tr><td></td><td></td><td></td><td></td><td></td><td>164</td></tr> <tr><td></td><td></td><td></td><td></td><td></td><td>174</td></tr> <tr><td></td><td></td><td></td><td></td><td></td><td>88</td></tr> <tr><td></td><td></td><td></td><td></td><td></td><td>149</td></tr> <tr><td></td><td></td><td></td><td></td><td></td><td>89</td></tr> <tr><td></td><td></td><td></td><td></td><td></td><td>147</td></tr> <tr><td></td><td></td><td></td><td></td><td></td><td>129</td></tr> </tbody> </table> <div style="text-align: center; margin-top: 20px;">  <p>基本形状：タイプ3 許容値：235MPa</p> </div>	支持架構寸法		荷重(kN)		鋼材サイズ	組合せ応力(MPa) 発生応力	H(mm)	L(mm)	水平	鉛直						30						60						148						171						107						128						135						113						34						68						170						145						114						132						137						111						48						94						133						51						150						106						147						141						65						127						179						68						117						143						118						104						86						164						174						88						149						89						147						129	<p style="text-align: center;">表5-10-7 支持架構の耐震計算結果</p> <table border="1" style="width: 100%; border-collapse: collapse;"> <thead> <tr> <th colspan="2">支持架構寸法</th> <th colspan="2">荷重(kN)</th> <th rowspan="2">鋼材サイズ</th> <th colspan="2">組合せ応力(MPa)</th> <th rowspan="2">評価</th> </tr> <tr> <th>H(mm)</th> <th>L(mm)</th> <th>水平</th> <th>鉛直</th> <th>発生 応力</th> <th>許容 応力</th> </tr> </thead> <tbody> <tr><td></td><td></td><td></td><td></td><td>L-50×50×6</td><td>82</td><td>234</td><td>○</td></tr> <tr><td></td><td></td><td></td><td></td><td>L-100×100×10</td><td>66</td><td>234</td><td>○</td></tr> <tr><td></td><td></td><td></td><td></td><td>L-100×100×10</td><td>129</td><td>234</td><td>○</td></tr> <tr><td></td><td></td><td></td><td></td><td>□125×125×6</td><td>112</td><td>216</td><td>○</td></tr> <tr><td></td><td></td><td></td><td></td><td>□175×175×6</td><td>124</td><td>216</td><td>○</td></tr> <tr><td></td><td></td><td></td><td></td><td>L-50×50×6</td><td>85</td><td>234</td><td>○</td></tr> <tr><td></td><td></td><td></td><td></td><td>L-100×100×10</td><td>65</td><td>234</td><td>○</td></tr> <tr><td></td><td></td><td></td><td></td><td>L-100×100×10</td><td>129</td><td>234</td><td>○</td></tr> <tr><td></td><td></td><td></td><td></td><td>□125×125×6</td><td>106</td><td>216</td><td>○</td></tr> <tr><td></td><td></td><td></td><td></td><td>□175×175×6</td><td>114</td><td>216</td><td>○</td></tr> <tr><td></td><td></td><td></td><td></td><td>L-50×50×6</td><td>96</td><td>234</td><td>○</td></tr> <tr><td></td><td></td><td></td><td></td><td>L-100×100×10</td><td>72</td><td>234</td><td>○</td></tr> <tr><td></td><td></td><td></td><td></td><td>L-100×100×10</td><td>141</td><td>234</td><td>○</td></tr> <tr><td></td><td></td><td></td><td></td><td>□125×125×6</td><td>110</td><td>216</td><td>○</td></tr> <tr><td></td><td></td><td></td><td></td><td>□175×175×6</td><td>113</td><td>216</td><td>○</td></tr> </tbody> </table> <div style="text-align: center; margin-top: 20px;">  <p>基本形状：タイプ3</p> </div>	支持架構寸法		荷重(kN)		鋼材サイズ	組合せ応力(MPa)		評価	H(mm)	L(mm)	水平	鉛直	発生 応力	許容 応力					L-50×50×6	82	234	○					L-100×100×10	66	234	○					L-100×100×10	129	234	○					□125×125×6	112	216	○					□175×175×6	124	216	○					L-50×50×6	85	234	○					L-100×100×10	65	234	○					L-100×100×10	129	234	○					□125×125×6	106	216	○					□175×175×6	114	216	○					L-50×50×6	96	234	○					L-100×100×10	72	234	○					L-100×100×10	141	234	○					□125×125×6	110	216	○					□175×175×6	113	216	○	<p>・2項で示している支持構造物の耐震評価結果を型式ごとに記載しており、記載の差異により新たな論点が生じるものではない。</p>
支持架構寸法		荷重(kN)		鋼材サイズ	組合せ応力(MPa) 発生応力																																																																																																																																																																																																																																																																																																																																																																																														
H(mm)	L(mm)	水平	鉛直																																																																																																																																																																																																																																																																																																																																																																																																
					30																																																																																																																																																																																																																																																																																																																																																																																														
					60																																																																																																																																																																																																																																																																																																																																																																																														
					148																																																																																																																																																																																																																																																																																																																																																																																														
					171																																																																																																																																																																																																																																																																																																																																																																																														
					107																																																																																																																																																																																																																																																																																																																																																																																														
					128																																																																																																																																																																																																																																																																																																																																																																																														
					135																																																																																																																																																																																																																																																																																																																																																																																														
					113																																																																																																																																																																																																																																																																																																																																																																																														
					34																																																																																																																																																																																																																																																																																																																																																																																														
					68																																																																																																																																																																																																																																																																																																																																																																																														
					170																																																																																																																																																																																																																																																																																																																																																																																														
					145																																																																																																																																																																																																																																																																																																																																																																																														
					114																																																																																																																																																																																																																																																																																																																																																																																														
					132																																																																																																																																																																																																																																																																																																																																																																																														
					137																																																																																																																																																																																																																																																																																																																																																																																														
					111																																																																																																																																																																																																																																																																																																																																																																																														
					48																																																																																																																																																																																																																																																																																																																																																																																														
					94																																																																																																																																																																																																																																																																																																																																																																																														
					133																																																																																																																																																																																																																																																																																																																																																																																														
					51																																																																																																																																																																																																																																																																																																																																																																																														
					150																																																																																																																																																																																																																																																																																																																																																																																														
					106																																																																																																																																																																																																																																																																																																																																																																																														
					147																																																																																																																																																																																																																																																																																																																																																																																														
					141																																																																																																																																																																																																																																																																																																																																																																																														
					65																																																																																																																																																																																																																																																																																																																																																																																														
					127																																																																																																																																																																																																																																																																																																																																																																																														
					179																																																																																																																																																																																																																																																																																																																																																																																														
					68																																																																																																																																																																																																																																																																																																																																																																																														
					117																																																																																																																																																																																																																																																																																																																																																																																														
					143																																																																																																																																																																																																																																																																																																																																																																																														
					118																																																																																																																																																																																																																																																																																																																																																																																														
					104																																																																																																																																																																																																																																																																																																																																																																																														
					86																																																																																																																																																																																																																																																																																																																																																																																														
					164																																																																																																																																																																																																																																																																																																																																																																																														
					174																																																																																																																																																																																																																																																																																																																																																																																														
					88																																																																																																																																																																																																																																																																																																																																																																																														
					149																																																																																																																																																																																																																																																																																																																																																																																														
					89																																																																																																																																																																																																																																																																																																																																																																																														
					147																																																																																																																																																																																																																																																																																																																																																																																														
					129																																																																																																																																																																																																																																																																																																																																																																																														
支持架構寸法		荷重(kN)		鋼材サイズ	組合せ応力(MPa)		評価																																																																																																																																																																																																																																																																																																																																																																																												
H(mm)	L(mm)	水平	鉛直		発生 応力	許容 応力																																																																																																																																																																																																																																																																																																																																																																																													
				L-50×50×6	82	234	○																																																																																																																																																																																																																																																																																																																																																																																												
				L-100×100×10	66	234	○																																																																																																																																																																																																																																																																																																																																																																																												
				L-100×100×10	129	234	○																																																																																																																																																																																																																																																																																																																																																																																												
				□125×125×6	112	216	○																																																																																																																																																																																																																																																																																																																																																																																												
				□175×175×6	124	216	○																																																																																																																																																																																																																																																																																																																																																																																												
				L-50×50×6	85	234	○																																																																																																																																																																																																																																																																																																																																																																																												
				L-100×100×10	65	234	○																																																																																																																																																																																																																																																																																																																																																																																												
				L-100×100×10	129	234	○																																																																																																																																																																																																																																																																																																																																																																																												
				□125×125×6	106	216	○																																																																																																																																																																																																																																																																																																																																																																																												
				□175×175×6	114	216	○																																																																																																																																																																																																																																																																																																																																																																																												
				L-50×50×6	96	234	○																																																																																																																																																																																																																																																																																																																																																																																												
				L-100×100×10	72	234	○																																																																																																																																																																																																																																																																																																																																																																																												
				L-100×100×10	141	234	○																																																																																																																																																																																																																																																																																																																																																																																												
				□125×125×6	110	216	○																																																																																																																																																																																																																																																																																																																																																																																												
				□175×175×6	113	216	○																																																																																																																																																																																																																																																																																																																																																																																												

再処理施設	発電炉	備考																																																																																																																																																																																																																																																																																																																																																																																																																																												
添付書類IV-1-1	添付書類IV-1-1-11-1	添付書類V-2-1-12-1																																																																																																																																																																																																																																																																																																																																																																																																																																												
	<p>第3.1-9表(8/18) 支持架構の耐震計算結果</p> <table border="1"> <thead> <tr> <th colspan="2">支持架構寸法</th> <th colspan="2">荷重(kN)</th> <th rowspan="2">鋼材サイズ</th> <th colspan="2">組合せ応力(MPa)</th> </tr> <tr> <th>H(mm)</th> <th>L(mm)</th> <th>水平</th> <th>鉛直</th> <th>発生</th> <th>許容</th> </tr> </thead> <tbody> <tr><td></td><td></td><td></td><td></td><td></td><td>44</td><td></td></tr> <tr><td></td><td></td><td></td><td></td><td></td><td>88</td><td></td></tr> <tr><td></td><td></td><td></td><td></td><td></td><td>127</td><td></td></tr> <tr><td></td><td></td><td></td><td></td><td></td><td>52</td><td></td></tr> <tr><td></td><td></td><td></td><td></td><td></td><td>155</td><td></td></tr> <tr><td></td><td></td><td></td><td></td><td></td><td>116</td><td></td></tr> <tr><td></td><td></td><td></td><td></td><td></td><td>100</td><td></td></tr> <tr><td></td><td></td><td></td><td></td><td></td><td>161</td><td></td></tr> <tr><td></td><td></td><td></td><td></td><td></td><td>49</td><td></td></tr> <tr><td></td><td></td><td></td><td></td><td></td><td>96</td><td></td></tr> <tr><td></td><td></td><td></td><td></td><td></td><td>138</td><td></td></tr> <tr><td></td><td></td><td></td><td></td><td></td><td>53</td><td></td></tr> <tr><td></td><td></td><td></td><td></td><td></td><td>158</td><td></td></tr> <tr><td></td><td></td><td></td><td></td><td></td><td>114</td><td></td></tr> <tr><td></td><td></td><td></td><td></td><td></td><td>96</td><td></td></tr> <tr><td></td><td></td><td></td><td></td><td></td><td>154</td><td></td></tr> <tr><td></td><td></td><td></td><td></td><td></td><td>60</td><td></td></tr> <tr><td></td><td></td><td></td><td></td><td></td><td>120</td><td></td></tr> <tr><td></td><td></td><td></td><td></td><td></td><td>170</td><td></td></tr> <tr><td></td><td></td><td></td><td></td><td></td><td>62</td><td></td></tr> <tr><td></td><td></td><td></td><td></td><td></td><td>105</td><td></td></tr> <tr><td></td><td></td><td></td><td></td><td></td><td>127</td><td></td></tr> <tr><td></td><td></td><td></td><td></td><td></td><td>103</td><td></td></tr> <tr><td></td><td></td><td></td><td></td><td></td><td>165</td><td></td></tr> <tr><td></td><td></td><td></td><td></td><td></td><td>74</td><td></td></tr> <tr><td></td><td></td><td></td><td></td><td></td><td>144</td><td></td></tr> <tr><td></td><td></td><td></td><td></td><td></td><td>152</td><td></td></tr> <tr><td></td><td></td><td></td><td></td><td></td><td>74</td><td></td></tr> <tr><td></td><td></td><td></td><td></td><td></td><td>126</td><td></td></tr> <tr><td></td><td></td><td></td><td></td><td></td><td>152</td><td></td></tr> <tr><td></td><td></td><td></td><td></td><td></td><td>123</td><td></td></tr> <tr><td></td><td></td><td></td><td></td><td></td><td>107</td><td></td></tr> <tr><td></td><td></td><td></td><td></td><td></td><td>92</td><td></td></tr> <tr><td></td><td></td><td></td><td></td><td></td><td>177</td><td></td></tr> <tr><td></td><td></td><td></td><td></td><td></td><td>46</td><td></td></tr> <tr><td></td><td></td><td></td><td></td><td></td><td>90</td><td></td></tr> <tr><td></td><td></td><td></td><td></td><td></td><td>152</td><td></td></tr> <tr><td></td><td></td><td></td><td></td><td></td><td>88</td><td></td></tr> <tr><td></td><td></td><td></td><td></td><td></td><td>146</td><td></td></tr> <tr><td></td><td></td><td></td><td></td><td></td><td>128</td><td></td></tr> </tbody> </table>  <p>基本形状：タイプ3 許容値：235MPa</p>	支持架構寸法		荷重(kN)		鋼材サイズ	組合せ応力(MPa)		H(mm)	L(mm)	水平	鉛直	発生	許容						44							88							127							52							155							116							100							161							49							96							138							53							158							114							96							154							60							120							170							62							105							127							103							165							74							144							152							74							126							152							123							107							92							177							46							90							152							88							146							128		<p>表5-10-8 支持架構の耐震計算結果</p> <table border="1"> <thead> <tr> <th colspan="2">支持架構寸法</th> <th colspan="2">荷重(kN)</th> <th rowspan="2">鋼材サイズ</th> <th colspan="2">組合せ応力(MPa)</th> <th rowspan="2">評価</th> </tr> <tr> <th>H(mm)</th> <th>L(mm)</th> <th>水平</th> <th>鉛直</th> <th>発生</th> <th>許容</th> </tr> </thead> <tbody> <tr><td></td><td></td><td></td><td></td><td>L-65×65×6</td><td>131</td><td>234</td><td>○</td></tr> <tr><td></td><td></td><td></td><td></td><td>□100×100×6</td><td>69</td><td>216</td><td>○</td></tr> <tr><td></td><td></td><td></td><td></td><td>□125×125×6</td><td>84</td><td>216</td><td>○</td></tr> <tr><td></td><td></td><td></td><td></td><td>□175×175×6</td><td>125</td><td>216</td><td>○</td></tr> <tr><td></td><td></td><td></td><td></td><td>□200×200×9</td><td>135</td><td>216</td><td>○</td></tr> <tr><td></td><td></td><td></td><td></td><td>L-65×65×6</td><td>162</td><td>234</td><td>○</td></tr> <tr><td></td><td></td><td></td><td></td><td>□100×100×6</td><td>85</td><td>216</td><td>○</td></tr> <tr><td></td><td></td><td></td><td></td><td>□125×125×6</td><td>104</td><td>216</td><td>○</td></tr> <tr><td></td><td></td><td></td><td></td><td>□200×200×9</td><td>84</td><td>216</td><td>○</td></tr> <tr><td></td><td></td><td></td><td></td><td>□250×250×12</td><td>84</td><td>216</td><td>○</td></tr> <tr><td></td><td></td><td></td><td></td><td>L-75×75×6</td><td>144</td><td>234</td><td>○</td></tr> <tr><td></td><td></td><td></td><td></td><td>□100×100×6</td><td>101</td><td>216</td><td>○</td></tr> <tr><td></td><td></td><td></td><td></td><td>□125×125×6</td><td>122</td><td>216</td><td>○</td></tr> <tr><td></td><td></td><td></td><td></td><td>□200×200×9</td><td>98</td><td>216</td><td>○</td></tr> <tr><td></td><td></td><td></td><td></td><td>□250×250×12</td><td>97</td><td>216</td><td>○</td></tr> </tbody> </table>  <p>基本形状：タイプ4</p>	支持架構寸法		荷重(kN)		鋼材サイズ	組合せ応力(MPa)		評価	H(mm)	L(mm)	水平	鉛直	発生	許容					L-65×65×6	131	234	○					□100×100×6	69	216	○					□125×125×6	84	216	○					□175×175×6	125	216	○					□200×200×9	135	216	○					L-65×65×6	162	234	○					□100×100×6	85	216	○					□125×125×6	104	216	○					□200×200×9	84	216	○					□250×250×12	84	216	○					L-75×75×6	144	234	○					□100×100×6	101	216	○					□125×125×6	122	216	○					□200×200×9	98	216	○					□250×250×12	97	216	○	<p>・2項で示している支持構造物の耐震評価結果を型式ごとに記載しており、記載の差異により新たな論点が生じるものではない。</p>
支持架構寸法		荷重(kN)		鋼材サイズ	組合せ応力(MPa)																																																																																																																																																																																																																																																																																																																																																																																																																																									
H(mm)	L(mm)	水平	鉛直		発生	許容																																																																																																																																																																																																																																																																																																																																																																																																																																								
					44																																																																																																																																																																																																																																																																																																																																																																																																																																									
					88																																																																																																																																																																																																																																																																																																																																																																																																																																									
					127																																																																																																																																																																																																																																																																																																																																																																																																																																									
					52																																																																																																																																																																																																																																																																																																																																																																																																																																									
					155																																																																																																																																																																																																																																																																																																																																																																																																																																									
					116																																																																																																																																																																																																																																																																																																																																																																																																																																									
					100																																																																																																																																																																																																																																																																																																																																																																																																																																									
					161																																																																																																																																																																																																																																																																																																																																																																																																																																									
					49																																																																																																																																																																																																																																																																																																																																																																																																																																									
					96																																																																																																																																																																																																																																																																																																																																																																																																																																									
					138																																																																																																																																																																																																																																																																																																																																																																																																																																									
					53																																																																																																																																																																																																																																																																																																																																																																																																																																									
					158																																																																																																																																																																																																																																																																																																																																																																																																																																									
					114																																																																																																																																																																																																																																																																																																																																																																																																																																									
					96																																																																																																																																																																																																																																																																																																																																																																																																																																									
					154																																																																																																																																																																																																																																																																																																																																																																																																																																									
					60																																																																																																																																																																																																																																																																																																																																																																																																																																									
					120																																																																																																																																																																																																																																																																																																																																																																																																																																									
					170																																																																																																																																																																																																																																																																																																																																																																																																																																									
					62																																																																																																																																																																																																																																																																																																																																																																																																																																									
					105																																																																																																																																																																																																																																																																																																																																																																																																																																									
					127																																																																																																																																																																																																																																																																																																																																																																																																																																									
					103																																																																																																																																																																																																																																																																																																																																																																																																																																									
					165																																																																																																																																																																																																																																																																																																																																																																																																																																									
					74																																																																																																																																																																																																																																																																																																																																																																																																																																									
					144																																																																																																																																																																																																																																																																																																																																																																																																																																									
					152																																																																																																																																																																																																																																																																																																																																																																																																																																									
					74																																																																																																																																																																																																																																																																																																																																																																																																																																									
					126																																																																																																																																																																																																																																																																																																																																																																																																																																									
					152																																																																																																																																																																																																																																																																																																																																																																																																																																									
					123																																																																																																																																																																																																																																																																																																																																																																																																																																									
					107																																																																																																																																																																																																																																																																																																																																																																																																																																									
					92																																																																																																																																																																																																																																																																																																																																																																																																																																									
					177																																																																																																																																																																																																																																																																																																																																																																																																																																									
					46																																																																																																																																																																																																																																																																																																																																																																																																																																									
					90																																																																																																																																																																																																																																																																																																																																																																																																																																									
					152																																																																																																																																																																																																																																																																																																																																																																																																																																									
					88																																																																																																																																																																																																																																																																																																																																																																																																																																									
					146																																																																																																																																																																																																																																																																																																																																																																																																																																									
					128																																																																																																																																																																																																																																																																																																																																																																																																																																									
支持架構寸法		荷重(kN)		鋼材サイズ	組合せ応力(MPa)		評価																																																																																																																																																																																																																																																																																																																																																																																																																																							
H(mm)	L(mm)	水平	鉛直		発生	許容																																																																																																																																																																																																																																																																																																																																																																																																																																								
				L-65×65×6	131	234	○																																																																																																																																																																																																																																																																																																																																																																																																																																							
				□100×100×6	69	216	○																																																																																																																																																																																																																																																																																																																																																																																																																																							
				□125×125×6	84	216	○																																																																																																																																																																																																																																																																																																																																																																																																																																							
				□175×175×6	125	216	○																																																																																																																																																																																																																																																																																																																																																																																																																																							
				□200×200×9	135	216	○																																																																																																																																																																																																																																																																																																																																																																																																																																							
				L-65×65×6	162	234	○																																																																																																																																																																																																																																																																																																																																																																																																																																							
				□100×100×6	85	216	○																																																																																																																																																																																																																																																																																																																																																																																																																																							
				□125×125×6	104	216	○																																																																																																																																																																																																																																																																																																																																																																																																																																							
				□200×200×9	84	216	○																																																																																																																																																																																																																																																																																																																																																																																																																																							
				□250×250×12	84	216	○																																																																																																																																																																																																																																																																																																																																																																																																																																							
				L-75×75×6	144	234	○																																																																																																																																																																																																																																																																																																																																																																																																																																							
				□100×100×6	101	216	○																																																																																																																																																																																																																																																																																																																																																																																																																																							
				□125×125×6	122	216	○																																																																																																																																																																																																																																																																																																																																																																																																																																							
				□200×200×9	98	216	○																																																																																																																																																																																																																																																																																																																																																																																																																																							
				□250×250×12	97	216	○																																																																																																																																																																																																																																																																																																																																																																																																																																							

再処理施設	発電炉	備考																																																																																																																																																																																																																																																																																																																																																																																																	
添付書類IV-1-1	添付書類IV-1-1-11-1	添付書類V-2-1-12-1																																																																																																																																																																																																																																																																																																																																																																																																	
	<p style="text-align: center;">第3.1-9表(9/18) 支持架構の耐震計算結果</p> <table border="1" style="width: 100%; border-collapse: collapse;"> <thead> <tr> <th colspan="2">支持架構寸法</th> <th colspan="2">荷重(kN)</th> <th rowspan="2">鋼材サイズ</th> <th rowspan="2">組合せ応力(MPa) 発生応力</th> </tr> <tr> <th>H(mm)</th> <th>L(mm)</th> <th>水平</th> <th>鉛直</th> </tr> </thead> <tbody> <tr><td></td><td></td><td></td><td></td><td></td><td>81</td></tr> <tr><td></td><td></td><td></td><td></td><td></td><td>161</td></tr> <tr><td></td><td></td><td></td><td></td><td></td><td>174</td></tr> <tr><td></td><td></td><td></td><td></td><td></td><td>93</td></tr> <tr><td></td><td></td><td></td><td></td><td></td><td>164</td></tr> <tr><td></td><td></td><td></td><td></td><td></td><td>106</td></tr> <tr><td></td><td></td><td></td><td></td><td></td><td>182</td></tr> <tr><td></td><td></td><td></td><td></td><td></td><td>137</td></tr> <tr><td></td><td></td><td></td><td></td><td></td><td>84</td></tr> <tr><td></td><td></td><td></td><td></td><td></td><td>167</td></tr> <tr><td></td><td></td><td></td><td></td><td></td><td>178</td></tr> <tr><td></td><td></td><td></td><td></td><td></td><td>90</td></tr> <tr><td></td><td></td><td></td><td></td><td></td><td>156</td></tr> <tr><td></td><td></td><td></td><td></td><td></td><td>96</td></tr> <tr><td></td><td></td><td></td><td></td><td></td><td>160</td></tr> <tr><td></td><td></td><td></td><td></td><td></td><td>141</td></tr> <tr><td></td><td></td><td></td><td></td><td></td><td>95</td></tr> <tr><td></td><td></td><td></td><td></td><td></td><td>189</td></tr> <tr><td></td><td></td><td></td><td></td><td></td><td>48</td></tr> <tr><td></td><td></td><td></td><td></td><td></td><td>96</td></tr> <tr><td></td><td></td><td></td><td></td><td></td><td>163</td></tr> <tr><td></td><td></td><td></td><td></td><td></td><td>96</td></tr> <tr><td></td><td></td><td></td><td></td><td></td><td>160</td></tr> <tr><td></td><td></td><td></td><td></td><td></td><td>139</td></tr> <tr><td></td><td></td><td></td><td></td><td></td><td>108</td></tr> <tr><td></td><td></td><td></td><td></td><td></td><td>122</td></tr> <tr><td></td><td></td><td></td><td></td><td></td><td>54</td></tr> <tr><td></td><td></td><td></td><td></td><td></td><td>106</td></tr> <tr><td></td><td></td><td></td><td></td><td></td><td>108</td></tr> <tr><td></td><td></td><td></td><td></td><td></td><td>103</td></tr> <tr><td></td><td></td><td></td><td></td><td></td><td>194</td></tr> <tr><td></td><td></td><td></td><td></td><td></td><td>149</td></tr> <tr><td></td><td></td><td></td><td></td><td></td><td>121</td></tr> <tr><td></td><td></td><td></td><td></td><td></td><td>136</td></tr> <tr><td></td><td></td><td></td><td></td><td></td><td>59</td></tr> <tr><td></td><td></td><td></td><td></td><td></td><td>117</td></tr> <tr><td></td><td></td><td></td><td></td><td></td><td>118</td></tr> <tr><td></td><td></td><td></td><td></td><td></td><td>112</td></tr> <tr><td></td><td></td><td></td><td></td><td></td><td>100</td></tr> <tr><td></td><td></td><td></td><td></td><td></td><td>147</td></tr> </tbody> </table> <div style="text-align: center; margin-top: 20px;">  <p style="margin: 5px 0;">基本形状：タイプ3 許容値：235MPa</p> </div>	支持架構寸法		荷重(kN)		鋼材サイズ	組合せ応力(MPa) 発生応力	H(mm)	L(mm)	水平	鉛直						81						161						174						93						164						106						182						137						84						167						178						90						156						96						160						141						95						189						48						96						163						96						160						139						108						122						54						106						108						103						194						149						121						136						59						117						118						112						100						147	<p style="text-align: center;">表5-10-9 支持架構の耐震計算結果</p> <table border="1" style="width: 100%; border-collapse: collapse;"> <thead> <tr> <th colspan="2">支持架構寸法</th> <th colspan="2">荷重(kN)</th> <th rowspan="2">鋼材サイズ</th> <th colspan="2">組合せ応力(MPa)</th> <th rowspan="2">評価</th> </tr> <tr> <th>H(mm)</th> <th>L(mm)</th> <th>水平</th> <th>鉛直</th> <th>発生 応力</th> <th>許容 応力</th> </tr> </thead> <tbody> <tr><td></td><td></td><td></td><td></td><td>L-65×65×6</td><td>162</td><td>234</td><td>○</td></tr> <tr><td></td><td></td><td></td><td></td><td>□100×100×6</td><td>85</td><td>216</td><td>○</td></tr> <tr><td></td><td></td><td></td><td></td><td>□125×125×6</td><td>104</td><td>216</td><td>○</td></tr> <tr><td></td><td></td><td></td><td></td><td>□200×200×9</td><td>84</td><td>216</td><td>○</td></tr> <tr><td></td><td></td><td></td><td></td><td>□250×250×12</td><td>84</td><td>216</td><td>○</td></tr> <tr><td></td><td></td><td></td><td></td><td>L-75×75×6</td><td>144</td><td>234</td><td>○</td></tr> <tr><td></td><td></td><td></td><td></td><td>□100×100×6</td><td>101</td><td>216</td><td>○</td></tr> <tr><td></td><td></td><td></td><td></td><td>□125×125×6</td><td>122</td><td>216</td><td>○</td></tr> <tr><td></td><td></td><td></td><td></td><td>□200×200×9</td><td>98</td><td>216</td><td>○</td></tr> <tr><td></td><td></td><td></td><td></td><td>□250×250×12</td><td>97</td><td>216</td><td>○</td></tr> <tr><td></td><td></td><td></td><td></td><td>L-75×75×6</td><td>168</td><td>234</td><td>○</td></tr> <tr><td></td><td></td><td></td><td></td><td>□100×100×6</td><td>117</td><td>216</td><td>○</td></tr> <tr><td></td><td></td><td></td><td></td><td>□150×150×6</td><td>96</td><td>216</td><td>○</td></tr> <tr><td></td><td></td><td></td><td></td><td>□200×200×9</td><td>113</td><td>216</td><td>○</td></tr> <tr><td></td><td></td><td></td><td></td><td>□250×250×12</td><td>112</td><td>216</td><td>○</td></tr> </tbody> </table> <div style="text-align: center; margin-top: 20px;">  <p style="margin: 5px 0;">基本形状：タイプ4</p> </div>	支持架構寸法		荷重(kN)		鋼材サイズ	組合せ応力(MPa)		評価	H(mm)	L(mm)	水平	鉛直	発生 応力	許容 応力					L-65×65×6	162	234	○					□100×100×6	85	216	○					□125×125×6	104	216	○					□200×200×9	84	216	○					□250×250×12	84	216	○					L-75×75×6	144	234	○					□100×100×6	101	216	○					□125×125×6	122	216	○					□200×200×9	98	216	○					□250×250×12	97	216	○					L-75×75×6	168	234	○					□100×100×6	117	216	○					□150×150×6	96	216	○					□200×200×9	113	216	○					□250×250×12	112	216	○	<p>・2項で示している支持構造物の耐震評価結果を型式ごとに記載しており、記載の差異により新たな論点が生じるものではない。</p>
支持架構寸法		荷重(kN)		鋼材サイズ	組合せ応力(MPa) 発生応力																																																																																																																																																																																																																																																																																																																																																																																														
H(mm)	L(mm)	水平	鉛直																																																																																																																																																																																																																																																																																																																																																																																																
					81																																																																																																																																																																																																																																																																																																																																																																																														
					161																																																																																																																																																																																																																																																																																																																																																																																														
					174																																																																																																																																																																																																																																																																																																																																																																																														
					93																																																																																																																																																																																																																																																																																																																																																																																														
					164																																																																																																																																																																																																																																																																																																																																																																																														
					106																																																																																																																																																																																																																																																																																																																																																																																														
					182																																																																																																																																																																																																																																																																																																																																																																																														
					137																																																																																																																																																																																																																																																																																																																																																																																														
					84																																																																																																																																																																																																																																																																																																																																																																																														
					167																																																																																																																																																																																																																																																																																																																																																																																														
					178																																																																																																																																																																																																																																																																																																																																																																																														
					90																																																																																																																																																																																																																																																																																																																																																																																														
					156																																																																																																																																																																																																																																																																																																																																																																																														
					96																																																																																																																																																																																																																																																																																																																																																																																														
					160																																																																																																																																																																																																																																																																																																																																																																																														
					141																																																																																																																																																																																																																																																																																																																																																																																														
					95																																																																																																																																																																																																																																																																																																																																																																																														
					189																																																																																																																																																																																																																																																																																																																																																																																														
					48																																																																																																																																																																																																																																																																																																																																																																																														
					96																																																																																																																																																																																																																																																																																																																																																																																														
					163																																																																																																																																																																																																																																																																																																																																																																																														
					96																																																																																																																																																																																																																																																																																																																																																																																														
					160																																																																																																																																																																																																																																																																																																																																																																																														
					139																																																																																																																																																																																																																																																																																																																																																																																														
					108																																																																																																																																																																																																																																																																																																																																																																																														
					122																																																																																																																																																																																																																																																																																																																																																																																														
					54																																																																																																																																																																																																																																																																																																																																																																																														
					106																																																																																																																																																																																																																																																																																																																																																																																														
					108																																																																																																																																																																																																																																																																																																																																																																																														
					103																																																																																																																																																																																																																																																																																																																																																																																														
					194																																																																																																																																																																																																																																																																																																																																																																																														
					149																																																																																																																																																																																																																																																																																																																																																																																														
					121																																																																																																																																																																																																																																																																																																																																																																																														
					136																																																																																																																																																																																																																																																																																																																																																																																														
					59																																																																																																																																																																																																																																																																																																																																																																																														
					117																																																																																																																																																																																																																																																																																																																																																																																														
					118																																																																																																																																																																																																																																																																																																																																																																																														
					112																																																																																																																																																																																																																																																																																																																																																																																														
					100																																																																																																																																																																																																																																																																																																																																																																																														
					147																																																																																																																																																																																																																																																																																																																																																																																														
支持架構寸法		荷重(kN)		鋼材サイズ	組合せ応力(MPa)		評価																																																																																																																																																																																																																																																																																																																																																																																												
H(mm)	L(mm)	水平	鉛直		発生 応力	許容 応力																																																																																																																																																																																																																																																																																																																																																																																													
				L-65×65×6	162	234	○																																																																																																																																																																																																																																																																																																																																																																																												
				□100×100×6	85	216	○																																																																																																																																																																																																																																																																																																																																																																																												
				□125×125×6	104	216	○																																																																																																																																																																																																																																																																																																																																																																																												
				□200×200×9	84	216	○																																																																																																																																																																																																																																																																																																																																																																																												
				□250×250×12	84	216	○																																																																																																																																																																																																																																																																																																																																																																																												
				L-75×75×6	144	234	○																																																																																																																																																																																																																																																																																																																																																																																												
				□100×100×6	101	216	○																																																																																																																																																																																																																																																																																																																																																																																												
				□125×125×6	122	216	○																																																																																																																																																																																																																																																																																																																																																																																												
				□200×200×9	98	216	○																																																																																																																																																																																																																																																																																																																																																																																												
				□250×250×12	97	216	○																																																																																																																																																																																																																																																																																																																																																																																												
				L-75×75×6	168	234	○																																																																																																																																																																																																																																																																																																																																																																																												
				□100×100×6	117	216	○																																																																																																																																																																																																																																																																																																																																																																																												
				□150×150×6	96	216	○																																																																																																																																																																																																																																																																																																																																																																																												
				□200×200×9	113	216	○																																																																																																																																																																																																																																																																																																																																																																																												
				□250×250×12	112	216	○																																																																																																																																																																																																																																																																																																																																																																																												

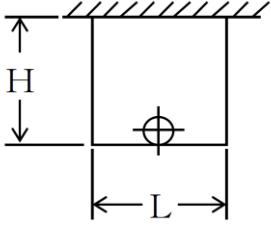
再処理施設	発電炉	備考																																																																																																																																																																																																																																																																																																																																																																																																	
添付書類IV-1-1	添付書類IV-1-1-11-1	添付書類V-2-1-12-1																																																																																																																																																																																																																																																																																																																																																																																																	
	<p>第3.1-9表(10/18) 支持架構の耐震計算結果</p> <table border="1"> <thead> <tr> <th colspan="2">支持架構寸法</th> <th colspan="2">荷重(kN)</th> <th rowspan="2">鋼材サイズ</th> <th rowspan="2">組合せ応力(MPa) 発生応力</th> </tr> <tr> <th>H(mm)</th> <th>L(mm)</th> <th>水平</th> <th>鉛直</th> </tr> </thead> <tbody> <tr><td></td><td></td><td></td><td></td><td></td><td>117</td></tr> <tr><td></td><td></td><td></td><td></td><td></td><td>136</td></tr> <tr><td></td><td></td><td></td><td></td><td></td><td>68</td></tr> <tr><td></td><td></td><td></td><td></td><td></td><td>135</td></tr> <tr><td></td><td></td><td></td><td></td><td></td><td>149</td></tr> <tr><td></td><td></td><td></td><td></td><td></td><td>152</td></tr> <tr><td></td><td></td><td></td><td></td><td></td><td>140</td></tr> <tr><td></td><td></td><td></td><td></td><td></td><td>134</td></tr> <tr><td></td><td></td><td></td><td></td><td></td><td>119</td></tr> <tr><td></td><td></td><td></td><td></td><td></td><td>137</td></tr> <tr><td></td><td></td><td></td><td></td><td></td><td>64</td></tr> <tr><td></td><td></td><td></td><td></td><td></td><td>127</td></tr> <tr><td></td><td></td><td></td><td></td><td></td><td>136</td></tr> <tr><td></td><td></td><td></td><td></td><td></td><td>135</td></tr> <tr><td></td><td></td><td></td><td></td><td></td><td>123</td></tr> <tr><td></td><td></td><td></td><td></td><td></td><td>176</td></tr> <tr><td></td><td></td><td></td><td></td><td></td><td>130</td></tr> <tr><td></td><td></td><td></td><td></td><td></td><td>148</td></tr> <tr><td></td><td></td><td></td><td></td><td></td><td>66</td></tr> <tr><td></td><td></td><td></td><td></td><td></td><td>131</td></tr> <tr><td></td><td></td><td></td><td></td><td></td><td>134</td></tr> <tr><td></td><td></td><td></td><td></td><td></td><td>129</td></tr> <tr><td></td><td></td><td></td><td></td><td></td><td>117</td></tr> <tr><td></td><td></td><td></td><td></td><td></td><td>170</td></tr> <tr><td></td><td></td><td></td><td></td><td></td><td>142</td></tr> <tr><td></td><td></td><td></td><td></td><td></td><td>161</td></tr> <tr><td></td><td></td><td></td><td></td><td></td><td>70</td></tr> <tr><td></td><td></td><td></td><td></td><td></td><td>140</td></tr> <tr><td></td><td></td><td></td><td></td><td></td><td>142</td></tr> <tr><td></td><td></td><td></td><td></td><td></td><td>135</td></tr> <tr><td></td><td></td><td></td><td></td><td></td><td>121</td></tr> <tr><td></td><td></td><td></td><td></td><td></td><td>178</td></tr> <tr><td></td><td></td><td></td><td></td><td></td><td>155</td></tr> <tr><td></td><td></td><td></td><td></td><td></td><td>175</td></tr> <tr><td></td><td></td><td></td><td></td><td></td><td>76</td></tr> <tr><td></td><td></td><td></td><td></td><td></td><td>150</td></tr> <tr><td></td><td></td><td></td><td></td><td></td><td>151</td></tr> <tr><td></td><td></td><td></td><td></td><td></td><td>143</td></tr> <tr><td></td><td></td><td></td><td></td><td></td><td>128</td></tr> <tr><td></td><td></td><td></td><td></td><td></td><td>190</td></tr> </tbody> </table>  <p>基本形状：タイプ-3 許容値：235MPa</p>	支持架構寸法		荷重(kN)		鋼材サイズ	組合せ応力(MPa) 発生応力	H(mm)	L(mm)	水平	鉛直						117						136						68						135						149						152						140						134						119						137						64						127						136						135						123						176						130						148						66						131						134						129						117						170						142						161						70						140						142						135						121						178						155						175						76						150						151						143						128						190	<p>表5-10-10 支持架構の耐震計算結果</p> <table border="1"> <thead> <tr> <th colspan="2">支持架構寸法</th> <th colspan="2">荷重(kN)</th> <th rowspan="2">鋼材サイズ</th> <th colspan="2">組合せ応力(MPa)</th> <th rowspan="2">評価</th> </tr> <tr> <th>H(mm)</th> <th>L(mm)</th> <th>水平</th> <th>鉛直</th> <th>発生 応力</th> <th>許容 応力</th> </tr> </thead> <tbody> <tr><td></td><td></td><td></td><td></td><td>L-75×75×6</td><td>156</td><td>234</td><td>○</td></tr> <tr><td></td><td></td><td></td><td></td><td>□100×100×6</td><td>109</td><td>216</td><td>○</td></tr> <tr><td></td><td></td><td></td><td></td><td>□150×150×6</td><td>89</td><td>216</td><td>○</td></tr> <tr><td></td><td></td><td></td><td></td><td>□200×200×9</td><td>105</td><td>216</td><td>○</td></tr> <tr><td></td><td></td><td></td><td></td><td>□250×250×12</td><td>105</td><td>216</td><td>○</td></tr> <tr><td></td><td></td><td></td><td></td><td>L-100×100×10</td><td>63</td><td>234</td><td>○</td></tr> <tr><td></td><td></td><td></td><td></td><td>□100×100×6</td><td>125</td><td>216</td><td>○</td></tr> <tr><td></td><td></td><td></td><td></td><td>□150×150×6</td><td>103</td><td>216</td><td>○</td></tr> <tr><td></td><td></td><td></td><td></td><td>□200×200×9</td><td>120</td><td>216</td><td>○</td></tr> <tr><td></td><td></td><td></td><td></td><td>□250×250×12</td><td>119</td><td>216</td><td>○</td></tr> <tr><td></td><td></td><td></td><td></td><td>L-100×100×10</td><td>71</td><td>234</td><td>○</td></tr> <tr><td></td><td></td><td></td><td></td><td>□125×125×6</td><td>86</td><td>216</td><td>○</td></tr> <tr><td></td><td></td><td></td><td></td><td>□150×150×6</td><td>116</td><td>216</td><td>○</td></tr> <tr><td></td><td></td><td></td><td></td><td>□200×200×9</td><td>135</td><td>216</td><td>○</td></tr> <tr><td></td><td></td><td></td><td></td><td>□300×300×12</td><td>91</td><td>216</td><td>○</td></tr> </tbody> </table>  <p>基本形状：タイプ-4</p>	支持架構寸法		荷重(kN)		鋼材サイズ	組合せ応力(MPa)		評価	H(mm)	L(mm)	水平	鉛直	発生 応力	許容 応力					L-75×75×6	156	234	○					□100×100×6	109	216	○					□150×150×6	89	216	○					□200×200×9	105	216	○					□250×250×12	105	216	○					L-100×100×10	63	234	○					□100×100×6	125	216	○					□150×150×6	103	216	○					□200×200×9	120	216	○					□250×250×12	119	216	○					L-100×100×10	71	234	○					□125×125×6	86	216	○					□150×150×6	116	216	○					□200×200×9	135	216	○					□300×300×12	91	216	○	<p>・2項で示している支持構造物の耐震評価結果を型式ごとに記載しており、記載の差異により新たな論点が生じるものではない。</p>
支持架構寸法		荷重(kN)		鋼材サイズ	組合せ応力(MPa) 発生応力																																																																																																																																																																																																																																																																																																																																																																																														
H(mm)	L(mm)	水平	鉛直																																																																																																																																																																																																																																																																																																																																																																																																
					117																																																																																																																																																																																																																																																																																																																																																																																														
					136																																																																																																																																																																																																																																																																																																																																																																																														
					68																																																																																																																																																																																																																																																																																																																																																																																														
					135																																																																																																																																																																																																																																																																																																																																																																																														
					149																																																																																																																																																																																																																																																																																																																																																																																														
					152																																																																																																																																																																																																																																																																																																																																																																																														
					140																																																																																																																																																																																																																																																																																																																																																																																														
					134																																																																																																																																																																																																																																																																																																																																																																																														
					119																																																																																																																																																																																																																																																																																																																																																																																														
					137																																																																																																																																																																																																																																																																																																																																																																																														
					64																																																																																																																																																																																																																																																																																																																																																																																														
					127																																																																																																																																																																																																																																																																																																																																																																																														
					136																																																																																																																																																																																																																																																																																																																																																																																														
					135																																																																																																																																																																																																																																																																																																																																																																																														
					123																																																																																																																																																																																																																																																																																																																																																																																														
					176																																																																																																																																																																																																																																																																																																																																																																																														
					130																																																																																																																																																																																																																																																																																																																																																																																														
					148																																																																																																																																																																																																																																																																																																																																																																																														
					66																																																																																																																																																																																																																																																																																																																																																																																														
					131																																																																																																																																																																																																																																																																																																																																																																																														
					134																																																																																																																																																																																																																																																																																																																																																																																														
					129																																																																																																																																																																																																																																																																																																																																																																																														
					117																																																																																																																																																																																																																																																																																																																																																																																														
					170																																																																																																																																																																																																																																																																																																																																																																																														
					142																																																																																																																																																																																																																																																																																																																																																																																														
					161																																																																																																																																																																																																																																																																																																																																																																																														
					70																																																																																																																																																																																																																																																																																																																																																																																														
					140																																																																																																																																																																																																																																																																																																																																																																																														
					142																																																																																																																																																																																																																																																																																																																																																																																														
					135																																																																																																																																																																																																																																																																																																																																																																																														
					121																																																																																																																																																																																																																																																																																																																																																																																														
					178																																																																																																																																																																																																																																																																																																																																																																																														
					155																																																																																																																																																																																																																																																																																																																																																																																														
					175																																																																																																																																																																																																																																																																																																																																																																																														
					76																																																																																																																																																																																																																																																																																																																																																																																														
					150																																																																																																																																																																																																																																																																																																																																																																																														
					151																																																																																																																																																																																																																																																																																																																																																																																														
					143																																																																																																																																																																																																																																																																																																																																																																																														
					128																																																																																																																																																																																																																																																																																																																																																																																														
					190																																																																																																																																																																																																																																																																																																																																																																																														
支持架構寸法		荷重(kN)		鋼材サイズ	組合せ応力(MPa)		評価																																																																																																																																																																																																																																																																																																																																																																																												
H(mm)	L(mm)	水平	鉛直		発生 応力	許容 応力																																																																																																																																																																																																																																																																																																																																																																																													
				L-75×75×6	156	234	○																																																																																																																																																																																																																																																																																																																																																																																												
				□100×100×6	109	216	○																																																																																																																																																																																																																																																																																																																																																																																												
				□150×150×6	89	216	○																																																																																																																																																																																																																																																																																																																																																																																												
				□200×200×9	105	216	○																																																																																																																																																																																																																																																																																																																																																																																												
				□250×250×12	105	216	○																																																																																																																																																																																																																																																																																																																																																																																												
				L-100×100×10	63	234	○																																																																																																																																																																																																																																																																																																																																																																																												
				□100×100×6	125	216	○																																																																																																																																																																																																																																																																																																																																																																																												
				□150×150×6	103	216	○																																																																																																																																																																																																																																																																																																																																																																																												
				□200×200×9	120	216	○																																																																																																																																																																																																																																																																																																																																																																																												
				□250×250×12	119	216	○																																																																																																																																																																																																																																																																																																																																																																																												
				L-100×100×10	71	234	○																																																																																																																																																																																																																																																																																																																																																																																												
				□125×125×6	86	216	○																																																																																																																																																																																																																																																																																																																																																																																												
				□150×150×6	116	216	○																																																																																																																																																																																																																																																																																																																																																																																												
				□200×200×9	135	216	○																																																																																																																																																																																																																																																																																																																																																																																												
				□300×300×12	91	216	○																																																																																																																																																																																																																																																																																																																																																																																												

再処理施設	発電炉	備考																																																																																																																																																																																																																																																																																																																																																																																																																																												
添付書類IV-1-1	添付書類IV-1-1-11-1	添付書類V-2-1-12-1																																																																																																																																																																																																																																																																																																																																																																																																																																												
	<p>第3.1-9表(11/18) 支持架構の耐震計算結果</p> <table border="1"> <thead> <tr> <th colspan="2">支持架構寸法</th> <th colspan="2">荷重(kN)</th> <th rowspan="2">鋼材サイズ</th> <th colspan="2">組合せ応力(MPa)</th> </tr> <tr> <th>H(mm)</th> <th>L(mm)</th> <th>水平</th> <th>鉛直</th> <th>発生</th> <th>許容</th> </tr> </thead> <tbody> <tr><td></td><td></td><td></td><td></td><td></td><td>154</td><td></td></tr> <tr><td></td><td></td><td></td><td></td><td></td><td>178</td><td></td></tr> <tr><td></td><td></td><td></td><td></td><td></td><td>88</td><td></td></tr> <tr><td></td><td></td><td></td><td></td><td></td><td>104</td><td></td></tr> <tr><td></td><td></td><td></td><td></td><td></td><td>100</td><td></td></tr> <tr><td></td><td></td><td></td><td></td><td></td><td>110</td><td></td></tr> <tr><td></td><td></td><td></td><td></td><td></td><td>160</td><td></td></tr> <tr><td></td><td></td><td></td><td></td><td></td><td>171</td><td></td></tr> <tr><td></td><td></td><td></td><td></td><td></td><td>155</td><td></td></tr> <tr><td></td><td></td><td></td><td></td><td></td><td>178</td><td></td></tr> <tr><td></td><td></td><td></td><td></td><td></td><td>83</td><td></td></tr> <tr><td></td><td></td><td></td><td></td><td></td><td>95</td><td></td></tr> <tr><td></td><td></td><td></td><td></td><td></td><td>146</td><td></td></tr> <tr><td></td><td></td><td></td><td></td><td></td><td>188</td><td></td></tr> <tr><td></td><td></td><td></td><td></td><td></td><td>142</td><td></td></tr> <tr><td></td><td></td><td></td><td></td><td></td><td>151</td><td></td></tr> <tr><td></td><td></td><td></td><td></td><td></td><td>164</td><td></td></tr> <tr><td></td><td></td><td></td><td></td><td></td><td>139</td><td></td></tr> <tr><td></td><td></td><td></td><td></td><td></td><td>83</td><td></td></tr> <tr><td></td><td></td><td></td><td></td><td></td><td>94</td><td></td></tr> <tr><td></td><td></td><td></td><td></td><td></td><td>142</td><td></td></tr> <tr><td></td><td></td><td></td><td></td><td></td><td>183</td><td></td></tr> <tr><td></td><td></td><td></td><td></td><td></td><td>147</td><td></td></tr> <tr><td></td><td></td><td></td><td></td><td></td><td>135</td><td></td></tr> <tr><td></td><td></td><td></td><td></td><td></td><td>176</td><td></td></tr> <tr><td></td><td></td><td></td><td></td><td></td><td>148</td><td></td></tr> <tr><td></td><td></td><td></td><td></td><td></td><td>87</td><td></td></tr> <tr><td></td><td></td><td></td><td></td><td></td><td>98</td><td></td></tr> <tr><td></td><td></td><td></td><td></td><td></td><td>147</td><td></td></tr> <tr><td></td><td></td><td></td><td></td><td></td><td>190</td><td></td></tr> <tr><td></td><td></td><td></td><td></td><td></td><td>149</td><td></td></tr> <tr><td></td><td></td><td></td><td></td><td></td><td>136</td><td></td></tr> <tr><td></td><td></td><td></td><td></td><td></td><td>189</td><td></td></tr> <tr><td></td><td></td><td></td><td></td><td></td><td>159</td><td></td></tr> <tr><td></td><td></td><td></td><td></td><td></td><td>92</td><td></td></tr> <tr><td></td><td></td><td></td><td></td><td></td><td>103</td><td></td></tr> <tr><td></td><td></td><td></td><td></td><td></td><td>88</td><td></td></tr> <tr><td></td><td></td><td></td><td></td><td></td><td>200</td><td></td></tr> <tr><td></td><td></td><td></td><td></td><td></td><td>144</td><td></td></tr> <tr><td></td><td></td><td></td><td></td><td></td><td>140</td><td></td></tr> </tbody> </table>  <p>基本形状：タイプ3 許容値：235MPa</p>	支持架構寸法		荷重(kN)		鋼材サイズ	組合せ応力(MPa)		H(mm)	L(mm)	水平	鉛直	発生	許容						154							178							88							104							100							110							160							171							155							178							83							95							146							188							142							151							164							139							83							94							142							183							147							135							176							148							87							98							147							190							149							136							189							159							92							103							88							200							144							140		<p>表5-10-11 支持架構の耐震計算結果</p> <table border="1"> <thead> <tr> <th colspan="2">支持架構寸法</th> <th colspan="2">荷重(kN)</th> <th rowspan="2">鋼材サイズ</th> <th colspan="2">組合せ応力(MPa)</th> <th rowspan="2">評価</th> </tr> <tr> <th>H(mm)</th> <th>L(mm)</th> <th>水平</th> <th>鉛直</th> <th>発生</th> <th>許容</th> </tr> </thead> <tbody> <tr><td></td><td></td><td></td><td></td><td>□75×75×4.5</td><td>8</td><td>216</td><td>○</td></tr> <tr><td></td><td></td><td></td><td></td><td>□75×75×4.5</td><td>34</td><td>216</td><td>○</td></tr> <tr><td></td><td></td><td></td><td></td><td>□75×75×4.5</td><td>67</td><td>216</td><td>○</td></tr> <tr><td></td><td></td><td></td><td></td><td>□100×100×6</td><td>89</td><td>216</td><td>○</td></tr> <tr><td></td><td></td><td></td><td></td><td>□125×125×6</td><td>121</td><td>216</td><td>○</td></tr> <tr><td></td><td></td><td></td><td></td><td>□75×75×4.5</td><td>13</td><td>216</td><td>○</td></tr> <tr><td></td><td></td><td></td><td></td><td>□75×75×4.5</td><td>59</td><td>216</td><td>○</td></tr> <tr><td></td><td></td><td></td><td></td><td>□100×100×6</td><td>54</td><td>216</td><td>○</td></tr> <tr><td></td><td></td><td></td><td></td><td>□125×125×6</td><td>108</td><td>216</td><td>○</td></tr> <tr><td></td><td></td><td></td><td></td><td>□175×175×6</td><td>121</td><td>216</td><td>○</td></tr> <tr><td></td><td></td><td></td><td></td><td>□75×75×4.5</td><td>18</td><td>216</td><td>○</td></tr> <tr><td></td><td></td><td></td><td></td><td>□75×75×4.5</td><td>87</td><td>216</td><td>○</td></tr> <tr><td></td><td></td><td></td><td></td><td>□100×100×6</td><td>80</td><td>216</td><td>○</td></tr> <tr><td></td><td></td><td></td><td></td><td>□150×150×6</td><td>114</td><td>216</td><td>○</td></tr> <tr><td></td><td></td><td></td><td></td><td>□200×200×9</td><td>97</td><td>216</td><td>○</td></tr> </tbody> </table>  <p>基本形状：タイプ5</p>	支持架構寸法		荷重(kN)		鋼材サイズ	組合せ応力(MPa)		評価	H(mm)	L(mm)	水平	鉛直	発生	許容					□75×75×4.5	8	216	○					□75×75×4.5	34	216	○					□75×75×4.5	67	216	○					□100×100×6	89	216	○					□125×125×6	121	216	○					□75×75×4.5	13	216	○					□75×75×4.5	59	216	○					□100×100×6	54	216	○					□125×125×6	108	216	○					□175×175×6	121	216	○					□75×75×4.5	18	216	○					□75×75×4.5	87	216	○					□100×100×6	80	216	○					□150×150×6	114	216	○					□200×200×9	97	216	○	<p>・2項で示している支持構造物の耐震評価結果を型式ごとに記載しており、記載の差異により新たな論点が生じるものではない。</p>
支持架構寸法		荷重(kN)		鋼材サイズ	組合せ応力(MPa)																																																																																																																																																																																																																																																																																																																																																																																																																																									
H(mm)	L(mm)	水平	鉛直		発生	許容																																																																																																																																																																																																																																																																																																																																																																																																																																								
					154																																																																																																																																																																																																																																																																																																																																																																																																																																									
					178																																																																																																																																																																																																																																																																																																																																																																																																																																									
					88																																																																																																																																																																																																																																																																																																																																																																																																																																									
					104																																																																																																																																																																																																																																																																																																																																																																																																																																									
					100																																																																																																																																																																																																																																																																																																																																																																																																																																									
					110																																																																																																																																																																																																																																																																																																																																																																																																																																									
					160																																																																																																																																																																																																																																																																																																																																																																																																																																									
					171																																																																																																																																																																																																																																																																																																																																																																																																																																									
					155																																																																																																																																																																																																																																																																																																																																																																																																																																									
					178																																																																																																																																																																																																																																																																																																																																																																																																																																									
					83																																																																																																																																																																																																																																																																																																																																																																																																																																									
					95																																																																																																																																																																																																																																																																																																																																																																																																																																									
					146																																																																																																																																																																																																																																																																																																																																																																																																																																									
					188																																																																																																																																																																																																																																																																																																																																																																																																																																									
					142																																																																																																																																																																																																																																																																																																																																																																																																																																									
					151																																																																																																																																																																																																																																																																																																																																																																																																																																									
					164																																																																																																																																																																																																																																																																																																																																																																																																																																									
					139																																																																																																																																																																																																																																																																																																																																																																																																																																									
					83																																																																																																																																																																																																																																																																																																																																																																																																																																									
					94																																																																																																																																																																																																																																																																																																																																																																																																																																									
					142																																																																																																																																																																																																																																																																																																																																																																																																																																									
					183																																																																																																																																																																																																																																																																																																																																																																																																																																									
					147																																																																																																																																																																																																																																																																																																																																																																																																																																									
					135																																																																																																																																																																																																																																																																																																																																																																																																																																									
					176																																																																																																																																																																																																																																																																																																																																																																																																																																									
					148																																																																																																																																																																																																																																																																																																																																																																																																																																									
					87																																																																																																																																																																																																																																																																																																																																																																																																																																									
					98																																																																																																																																																																																																																																																																																																																																																																																																																																									
					147																																																																																																																																																																																																																																																																																																																																																																																																																																									
					190																																																																																																																																																																																																																																																																																																																																																																																																																																									
					149																																																																																																																																																																																																																																																																																																																																																																																																																																									
					136																																																																																																																																																																																																																																																																																																																																																																																																																																									
					189																																																																																																																																																																																																																																																																																																																																																																																																																																									
					159																																																																																																																																																																																																																																																																																																																																																																																																																																									
					92																																																																																																																																																																																																																																																																																																																																																																																																																																									
					103																																																																																																																																																																																																																																																																																																																																																																																																																																									
					88																																																																																																																																																																																																																																																																																																																																																																																																																																									
					200																																																																																																																																																																																																																																																																																																																																																																																																																																									
					144																																																																																																																																																																																																																																																																																																																																																																																																																																									
					140																																																																																																																																																																																																																																																																																																																																																																																																																																									
支持架構寸法		荷重(kN)		鋼材サイズ	組合せ応力(MPa)		評価																																																																																																																																																																																																																																																																																																																																																																																																																																							
H(mm)	L(mm)	水平	鉛直		発生	許容																																																																																																																																																																																																																																																																																																																																																																																																																																								
				□75×75×4.5	8	216	○																																																																																																																																																																																																																																																																																																																																																																																																																																							
				□75×75×4.5	34	216	○																																																																																																																																																																																																																																																																																																																																																																																																																																							
				□75×75×4.5	67	216	○																																																																																																																																																																																																																																																																																																																																																																																																																																							
				□100×100×6	89	216	○																																																																																																																																																																																																																																																																																																																																																																																																																																							
				□125×125×6	121	216	○																																																																																																																																																																																																																																																																																																																																																																																																																																							
				□75×75×4.5	13	216	○																																																																																																																																																																																																																																																																																																																																																																																																																																							
				□75×75×4.5	59	216	○																																																																																																																																																																																																																																																																																																																																																																																																																																							
				□100×100×6	54	216	○																																																																																																																																																																																																																																																																																																																																																																																																																																							
				□125×125×6	108	216	○																																																																																																																																																																																																																																																																																																																																																																																																																																							
				□175×175×6	121	216	○																																																																																																																																																																																																																																																																																																																																																																																																																																							
				□75×75×4.5	18	216	○																																																																																																																																																																																																																																																																																																																																																																																																																																							
				□75×75×4.5	87	216	○																																																																																																																																																																																																																																																																																																																																																																																																																																							
				□100×100×6	80	216	○																																																																																																																																																																																																																																																																																																																																																																																																																																							
				□150×150×6	114	216	○																																																																																																																																																																																																																																																																																																																																																																																																																																							
				□200×200×9	97	216	○																																																																																																																																																																																																																																																																																																																																																																																																																																							

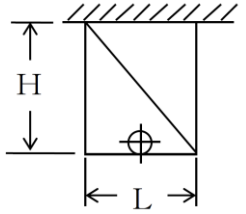
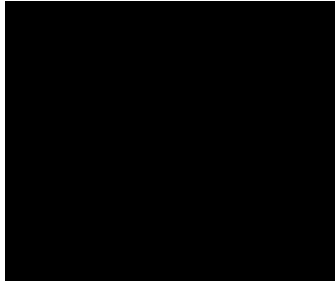
再処理施設	発電炉	備考																																																																																																																																																																																																																																																																																																																																																																																																																																												
添付書類IV-1-1	添付書類IV-1-1-11-1	添付書類V-2-1-12-1																																																																																																																																																																																																																																																																																																																																																																																																																																												
	<p>第3.1-9表(12/18) 支持架構の耐震計算結果</p> <table border="1"> <thead> <tr> <th colspan="2">支持架構寸法</th> <th colspan="2">荷重(kN)</th> <th rowspan="2">鋼材サイズ</th> <th colspan="2">組合せ応力(MPa)</th> </tr> <tr> <th>H(mm)</th> <th>L(mm)</th> <th>水平</th> <th>鉛直</th> <th>発生</th> <th>許容</th> </tr> </thead> <tbody> <tr><td></td><td></td><td></td><td></td><td></td><td>16</td><td></td></tr> <tr><td></td><td></td><td></td><td></td><td></td><td>32</td><td></td></tr> <tr><td></td><td></td><td></td><td></td><td></td><td>78</td><td></td></tr> <tr><td></td><td></td><td></td><td></td><td></td><td>155</td><td></td></tr> <tr><td></td><td></td><td></td><td></td><td></td><td>81</td><td></td></tr> <tr><td></td><td></td><td></td><td></td><td></td><td>161</td><td></td></tr> <tr><td></td><td></td><td></td><td></td><td></td><td>172</td><td></td></tr> <tr><td></td><td></td><td></td><td></td><td></td><td>147</td><td></td></tr> <tr><td></td><td></td><td></td><td></td><td></td><td>24</td><td></td></tr> <tr><td></td><td></td><td></td><td></td><td></td><td>48</td><td></td></tr> <tr><td></td><td></td><td></td><td></td><td></td><td>118</td><td></td></tr> <tr><td></td><td></td><td></td><td></td><td></td><td>137</td><td></td></tr> <tr><td></td><td></td><td></td><td></td><td></td><td>93</td><td></td></tr> <tr><td></td><td></td><td></td><td></td><td></td><td>115</td><td></td></tr> <tr><td></td><td></td><td></td><td></td><td></td><td>125</td><td></td></tr> <tr><td></td><td></td><td></td><td></td><td></td><td>107</td><td></td></tr> <tr><td></td><td></td><td></td><td></td><td></td><td>45</td><td></td></tr> <tr><td></td><td></td><td></td><td></td><td></td><td>87</td><td></td></tr> <tr><td></td><td></td><td></td><td></td><td></td><td>124</td><td></td></tr> <tr><td></td><td></td><td></td><td></td><td></td><td>50</td><td></td></tr> <tr><td></td><td></td><td></td><td></td><td></td><td>147</td><td></td></tr> <tr><td></td><td></td><td></td><td></td><td></td><td>148</td><td></td></tr> <tr><td></td><td></td><td></td><td></td><td></td><td>147</td><td></td></tr> <tr><td></td><td></td><td></td><td></td><td></td><td>141</td><td></td></tr> <tr><td></td><td></td><td></td><td></td><td></td><td>65</td><td></td></tr> <tr><td></td><td></td><td></td><td></td><td></td><td>126</td><td></td></tr> <tr><td></td><td></td><td></td><td></td><td></td><td>179</td><td></td></tr> <tr><td></td><td></td><td></td><td></td><td></td><td>69</td><td></td></tr> <tr><td></td><td></td><td></td><td></td><td></td><td>117</td><td></td></tr> <tr><td></td><td></td><td></td><td></td><td></td><td>143</td><td></td></tr> <tr><td></td><td></td><td></td><td></td><td></td><td>116</td><td></td></tr> <tr><td></td><td></td><td></td><td></td><td></td><td>102</td><td></td></tr> <tr><td></td><td></td><td></td><td></td><td></td><td>87</td><td></td></tr> <tr><td></td><td></td><td></td><td></td><td></td><td>166</td><td></td></tr> <tr><td></td><td></td><td></td><td></td><td></td><td>175</td><td></td></tr> <tr><td></td><td></td><td></td><td></td><td></td><td>88</td><td></td></tr> <tr><td></td><td></td><td></td><td></td><td></td><td>149</td><td></td></tr> <tr><td></td><td></td><td></td><td></td><td></td><td>87</td><td></td></tr> <tr><td></td><td></td><td></td><td></td><td></td><td>145</td><td></td></tr> <tr><td></td><td></td><td></td><td></td><td></td><td>126</td><td></td></tr> </tbody> </table>  <p>基本形状：タイプ-4 許容値：235MPa</p>	支持架構寸法		荷重(kN)		鋼材サイズ	組合せ応力(MPa)		H(mm)	L(mm)	水平	鉛直	発生	許容						16							32							78							155							81							161							172							147							24							48							118							137							93							115							125							107							45							87							124							50							147							148							147							141							65							126							179							69							117							143							116							102							87							166							175							88							149							87							145							126		<p>表5-10-12 支持架構の耐震計算結果</p> <table border="1"> <thead> <tr> <th colspan="2">支持架構寸法</th> <th colspan="2">荷重(kN)</th> <th rowspan="2">鋼材サイズ</th> <th colspan="2">組合せ応力(MPa)</th> <th rowspan="2">評価</th> </tr> <tr> <th>H(mm)</th> <th>L(mm)</th> <th>水平</th> <th>鉛直</th> <th>発生</th> <th>許容</th> </tr> </thead> <tbody> <tr><td></td><td></td><td></td><td></td><td>□75×75×4.5</td><td>9</td><td>216</td><td>○</td></tr> <tr><td></td><td></td><td></td><td></td><td>□75×75×4.5</td><td>34</td><td>216</td><td>○</td></tr> <tr><td></td><td></td><td></td><td></td><td>□75×75×4.5</td><td>67</td><td>216</td><td>○</td></tr> <tr><td></td><td></td><td></td><td></td><td>□100×100×6</td><td>91</td><td>216</td><td>○</td></tr> <tr><td></td><td></td><td></td><td></td><td>□125×125×6</td><td>116</td><td>216</td><td>○</td></tr> <tr><td></td><td></td><td></td><td></td><td>□75×75×4.5</td><td>13</td><td>216</td><td>○</td></tr> <tr><td></td><td></td><td></td><td></td><td>□75×75×4.5</td><td>58</td><td>216</td><td>○</td></tr> <tr><td></td><td></td><td></td><td></td><td>□100×100×6</td><td>52</td><td>216</td><td>○</td></tr> <tr><td></td><td></td><td></td><td></td><td>□125×125×6</td><td>102</td><td>216</td><td>○</td></tr> <tr><td></td><td></td><td></td><td></td><td>□175×175×6</td><td>114</td><td>216</td><td>○</td></tr> <tr><td></td><td></td><td></td><td></td><td>□75×75×4.5</td><td>17</td><td>216</td><td>○</td></tr> <tr><td></td><td></td><td></td><td></td><td>□75×75×4.5</td><td>83</td><td>216</td><td>○</td></tr> <tr><td></td><td></td><td></td><td></td><td>□100×100×6</td><td>77</td><td>216</td><td>○</td></tr> <tr><td></td><td></td><td></td><td></td><td>□150×150×6</td><td>108</td><td>216</td><td>○</td></tr> <tr><td></td><td></td><td></td><td></td><td>□200×200×9</td><td>92</td><td>216</td><td>○</td></tr> </tbody> </table>  <p>基本形状：タイプ-5</p>	支持架構寸法		荷重(kN)		鋼材サイズ	組合せ応力(MPa)		評価	H(mm)	L(mm)	水平	鉛直	発生	許容					□75×75×4.5	9	216	○					□75×75×4.5	34	216	○					□75×75×4.5	67	216	○					□100×100×6	91	216	○					□125×125×6	116	216	○					□75×75×4.5	13	216	○					□75×75×4.5	58	216	○					□100×100×6	52	216	○					□125×125×6	102	216	○					□175×175×6	114	216	○					□75×75×4.5	17	216	○					□75×75×4.5	83	216	○					□100×100×6	77	216	○					□150×150×6	108	216	○					□200×200×9	92	216	○	<p>・2項で示している支持構造物の耐震評価結果を型式ごとに記載しており、記載の差異により新たな論点が生じるものではない。</p>
支持架構寸法		荷重(kN)		鋼材サイズ	組合せ応力(MPa)																																																																																																																																																																																																																																																																																																																																																																																																																																									
H(mm)	L(mm)	水平	鉛直		発生	許容																																																																																																																																																																																																																																																																																																																																																																																																																																								
					16																																																																																																																																																																																																																																																																																																																																																																																																																																									
					32																																																																																																																																																																																																																																																																																																																																																																																																																																									
					78																																																																																																																																																																																																																																																																																																																																																																																																																																									
					155																																																																																																																																																																																																																																																																																																																																																																																																																																									
					81																																																																																																																																																																																																																																																																																																																																																																																																																																									
					161																																																																																																																																																																																																																																																																																																																																																																																																																																									
					172																																																																																																																																																																																																																																																																																																																																																																																																																																									
					147																																																																																																																																																																																																																																																																																																																																																																																																																																									
					24																																																																																																																																																																																																																																																																																																																																																																																																																																									
					48																																																																																																																																																																																																																																																																																																																																																																																																																																									
					118																																																																																																																																																																																																																																																																																																																																																																																																																																									
					137																																																																																																																																																																																																																																																																																																																																																																																																																																									
					93																																																																																																																																																																																																																																																																																																																																																																																																																																									
					115																																																																																																																																																																																																																																																																																																																																																																																																																																									
					125																																																																																																																																																																																																																																																																																																																																																																																																																																									
					107																																																																																																																																																																																																																																																																																																																																																																																																																																									
					45																																																																																																																																																																																																																																																																																																																																																																																																																																									
					87																																																																																																																																																																																																																																																																																																																																																																																																																																									
					124																																																																																																																																																																																																																																																																																																																																																																																																																																									
					50																																																																																																																																																																																																																																																																																																																																																																																																																																									
					147																																																																																																																																																																																																																																																																																																																																																																																																																																									
					148																																																																																																																																																																																																																																																																																																																																																																																																																																									
					147																																																																																																																																																																																																																																																																																																																																																																																																																																									
					141																																																																																																																																																																																																																																																																																																																																																																																																																																									
					65																																																																																																																																																																																																																																																																																																																																																																																																																																									
					126																																																																																																																																																																																																																																																																																																																																																																																																																																									
					179																																																																																																																																																																																																																																																																																																																																																																																																																																									
					69																																																																																																																																																																																																																																																																																																																																																																																																																																									
					117																																																																																																																																																																																																																																																																																																																																																																																																																																									
					143																																																																																																																																																																																																																																																																																																																																																																																																																																									
					116																																																																																																																																																																																																																																																																																																																																																																																																																																									
					102																																																																																																																																																																																																																																																																																																																																																																																																																																									
					87																																																																																																																																																																																																																																																																																																																																																																																																																																									
					166																																																																																																																																																																																																																																																																																																																																																																																																																																									
					175																																																																																																																																																																																																																																																																																																																																																																																																																																									
					88																																																																																																																																																																																																																																																																																																																																																																																																																																									
					149																																																																																																																																																																																																																																																																																																																																																																																																																																									
					87																																																																																																																																																																																																																																																																																																																																																																																																																																									
					145																																																																																																																																																																																																																																																																																																																																																																																																																																									
					126																																																																																																																																																																																																																																																																																																																																																																																																																																									
支持架構寸法		荷重(kN)		鋼材サイズ	組合せ応力(MPa)		評価																																																																																																																																																																																																																																																																																																																																																																																																																																							
H(mm)	L(mm)	水平	鉛直		発生	許容																																																																																																																																																																																																																																																																																																																																																																																																																																								
				□75×75×4.5	9	216	○																																																																																																																																																																																																																																																																																																																																																																																																																																							
				□75×75×4.5	34	216	○																																																																																																																																																																																																																																																																																																																																																																																																																																							
				□75×75×4.5	67	216	○																																																																																																																																																																																																																																																																																																																																																																																																																																							
				□100×100×6	91	216	○																																																																																																																																																																																																																																																																																																																																																																																																																																							
				□125×125×6	116	216	○																																																																																																																																																																																																																																																																																																																																																																																																																																							
				□75×75×4.5	13	216	○																																																																																																																																																																																																																																																																																																																																																																																																																																							
				□75×75×4.5	58	216	○																																																																																																																																																																																																																																																																																																																																																																																																																																							
				□100×100×6	52	216	○																																																																																																																																																																																																																																																																																																																																																																																																																																							
				□125×125×6	102	216	○																																																																																																																																																																																																																																																																																																																																																																																																																																							
				□175×175×6	114	216	○																																																																																																																																																																																																																																																																																																																																																																																																																																							
				□75×75×4.5	17	216	○																																																																																																																																																																																																																																																																																																																																																																																																																																							
				□75×75×4.5	83	216	○																																																																																																																																																																																																																																																																																																																																																																																																																																							
				□100×100×6	77	216	○																																																																																																																																																																																																																																																																																																																																																																																																																																							
				□150×150×6	108	216	○																																																																																																																																																																																																																																																																																																																																																																																																																																							
				□200×200×9	92	216	○																																																																																																																																																																																																																																																																																																																																																																																																																																							

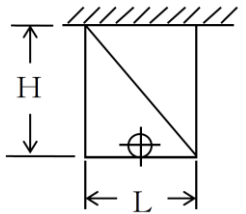
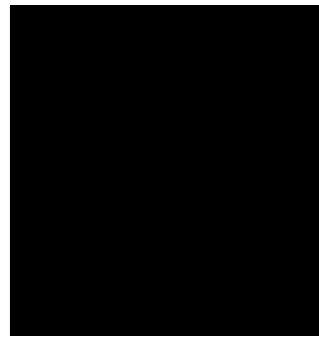
再処理施設	発電炉	備考																																																																																																																																																																																																																																																																																																																																																																																																																																												
添付書類IV-1-1	添付書類IV-1-1-11-1	添付書類V-2-1-12-1																																																																																																																																																																																																																																																																																																																																																																																																																																												
	<p>第3.1-9表(13/18) 支持架構の耐震計算結果</p> <table border="1"> <thead> <tr> <th colspan="2">支持架構寸法</th> <th colspan="2">荷重(kN)</th> <th rowspan="2">鋼材サイズ</th> <th colspan="2">組合せ応力(MPa)</th> </tr> <tr> <th>H(mm)</th> <th>L(mm)</th> <th>水平</th> <th>鉛直</th> <th>発生</th> <th>許容</th> </tr> </thead> <tbody> <tr><td></td><td></td><td></td><td></td><td></td><td>17</td><td></td></tr> <tr><td></td><td></td><td></td><td></td><td></td><td>33</td><td></td></tr> <tr><td></td><td></td><td></td><td></td><td></td><td>83</td><td></td></tr> <tr><td></td><td></td><td></td><td></td><td></td><td>164</td><td></td></tr> <tr><td></td><td></td><td></td><td></td><td></td><td>96</td><td></td></tr> <tr><td></td><td></td><td></td><td></td><td></td><td>127</td><td></td></tr> <tr><td></td><td></td><td></td><td></td><td></td><td>142</td><td></td></tr> <tr><td></td><td></td><td></td><td></td><td></td><td>125</td><td></td></tr> <tr><td></td><td></td><td></td><td></td><td></td><td>26</td><td></td></tr> <tr><td></td><td></td><td></td><td></td><td></td><td>50</td><td></td></tr> <tr><td></td><td></td><td></td><td></td><td></td><td>123</td><td></td></tr> <tr><td></td><td></td><td></td><td></td><td></td><td>143</td><td></td></tr> <tr><td></td><td></td><td></td><td></td><td></td><td>96</td><td></td></tr> <tr><td></td><td></td><td></td><td></td><td></td><td>124</td><td></td></tr> <tr><td></td><td></td><td></td><td></td><td></td><td>138</td><td></td></tr> <tr><td></td><td></td><td></td><td></td><td></td><td>123</td><td></td></tr> <tr><td></td><td></td><td></td><td></td><td></td><td>46</td><td></td></tr> <tr><td></td><td></td><td></td><td></td><td></td><td>90</td><td></td></tr> <tr><td></td><td></td><td></td><td></td><td></td><td>128</td><td></td></tr> <tr><td></td><td></td><td></td><td></td><td></td><td>51</td><td></td></tr> <tr><td></td><td></td><td></td><td></td><td></td><td>151</td><td></td></tr> <tr><td></td><td></td><td></td><td></td><td></td><td>109</td><td></td></tr> <tr><td></td><td></td><td></td><td></td><td></td><td>150</td><td></td></tr> <tr><td></td><td></td><td></td><td></td><td></td><td>150</td><td></td></tr> <tr><td></td><td></td><td></td><td></td><td></td><td>67</td><td></td></tr> <tr><td></td><td></td><td></td><td></td><td></td><td>129</td><td></td></tr> <tr><td></td><td></td><td></td><td></td><td></td><td>183</td><td></td></tr> <tr><td></td><td></td><td></td><td></td><td></td><td>70</td><td></td></tr> <tr><td></td><td></td><td></td><td></td><td></td><td>120</td><td></td></tr> <tr><td></td><td></td><td></td><td></td><td></td><td>146</td><td></td></tr> <tr><td></td><td></td><td></td><td></td><td></td><td>119</td><td></td></tr> <tr><td></td><td></td><td></td><td></td><td></td><td>105</td><td></td></tr> <tr><td></td><td></td><td></td><td></td><td></td><td>88</td><td></td></tr> <tr><td></td><td></td><td></td><td></td><td></td><td>169</td><td></td></tr> <tr><td></td><td></td><td></td><td></td><td></td><td>178</td><td></td></tr> <tr><td></td><td></td><td></td><td></td><td></td><td>89</td><td></td></tr> <tr><td></td><td></td><td></td><td></td><td></td><td>151</td><td></td></tr> <tr><td></td><td></td><td></td><td></td><td></td><td>89</td><td></td></tr> <tr><td></td><td></td><td></td><td></td><td></td><td>148</td><td></td></tr> <tr><td></td><td></td><td></td><td></td><td></td><td>130</td><td></td></tr> </tbody> </table>  <p>基本形状：タイプ4 許容値：235MPa</p>	支持架構寸法		荷重(kN)		鋼材サイズ	組合せ応力(MPa)		H(mm)	L(mm)	水平	鉛直	発生	許容						17							33							83							164							96							127							142							125							26							50							123							143							96							124							138							123							46							90							128							51							151							109							150							150							67							129							183							70							120							146							119							105							88							169							178							89							151							89							148							130		<p>表5-10-13 支持架構の耐震計算結果</p> <table border="1"> <thead> <tr> <th colspan="2">支持架構寸法</th> <th colspan="2">荷重(kN)</th> <th rowspan="2">鋼材サイズ</th> <th colspan="2">組合せ応力(MPa)</th> <th rowspan="2">評価</th> </tr> <tr> <th>H(mm)</th> <th>L(mm)</th> <th>水平</th> <th>鉛直</th> <th>発生</th> <th>許容</th> </tr> </thead> <tbody> <tr><td></td><td></td><td></td><td></td><td>□75×75×4.5</td><td>8</td><td>216</td><td>○</td></tr> <tr><td></td><td></td><td></td><td></td><td>□75×75×4.5</td><td>32</td><td>216</td><td>○</td></tr> <tr><td></td><td></td><td></td><td></td><td>□75×75×4.5</td><td>62</td><td>216</td><td>○</td></tr> <tr><td></td><td></td><td></td><td></td><td>□100×100×6</td><td>88</td><td>216</td><td>○</td></tr> <tr><td></td><td></td><td></td><td></td><td>□125×125×6</td><td>119</td><td>216</td><td>○</td></tr> <tr><td></td><td></td><td></td><td></td><td>□75×75×4.5</td><td>13</td><td>216</td><td>○</td></tr> <tr><td></td><td></td><td></td><td></td><td>□75×75×4.5</td><td>59</td><td>216</td><td>○</td></tr> <tr><td></td><td></td><td></td><td></td><td>□100×100×6</td><td>54</td><td>216</td><td>○</td></tr> <tr><td></td><td></td><td></td><td></td><td>□125×125×6</td><td>107</td><td>216</td><td>○</td></tr> <tr><td></td><td></td><td></td><td></td><td>□175×175×6</td><td>120</td><td>216</td><td>○</td></tr> <tr><td></td><td></td><td></td><td></td><td>□75×75×4.5</td><td>18</td><td>216</td><td>○</td></tr> <tr><td></td><td></td><td></td><td></td><td>□75×75×4.5</td><td>87</td><td>216</td><td>○</td></tr> <tr><td></td><td></td><td></td><td></td><td>□100×100×6</td><td>80</td><td>216</td><td>○</td></tr> <tr><td></td><td></td><td></td><td></td><td>□150×150×6</td><td>114</td><td>216</td><td>○</td></tr> <tr><td></td><td></td><td></td><td></td><td>□200×200×9</td><td>97</td><td>216</td><td>○</td></tr> </tbody> </table>  <p>基本形状：タイプ6</p>	支持架構寸法		荷重(kN)		鋼材サイズ	組合せ応力(MPa)		評価	H(mm)	L(mm)	水平	鉛直	発生	許容					□75×75×4.5	8	216	○					□75×75×4.5	32	216	○					□75×75×4.5	62	216	○					□100×100×6	88	216	○					□125×125×6	119	216	○					□75×75×4.5	13	216	○					□75×75×4.5	59	216	○					□100×100×6	54	216	○					□125×125×6	107	216	○					□175×175×6	120	216	○					□75×75×4.5	18	216	○					□75×75×4.5	87	216	○					□100×100×6	80	216	○					□150×150×6	114	216	○					□200×200×9	97	216	○	<p>・2項で示している支持構造物の耐震評価結果を型式ごとに記載しており、記載の差異により新たな論点が生じるものではない。</p>
支持架構寸法		荷重(kN)		鋼材サイズ	組合せ応力(MPa)																																																																																																																																																																																																																																																																																																																																																																																																																																									
H(mm)	L(mm)	水平	鉛直		発生	許容																																																																																																																																																																																																																																																																																																																																																																																																																																								
					17																																																																																																																																																																																																																																																																																																																																																																																																																																									
					33																																																																																																																																																																																																																																																																																																																																																																																																																																									
					83																																																																																																																																																																																																																																																																																																																																																																																																																																									
					164																																																																																																																																																																																																																																																																																																																																																																																																																																									
					96																																																																																																																																																																																																																																																																																																																																																																																																																																									
					127																																																																																																																																																																																																																																																																																																																																																																																																																																									
					142																																																																																																																																																																																																																																																																																																																																																																																																																																									
					125																																																																																																																																																																																																																																																																																																																																																																																																																																									
					26																																																																																																																																																																																																																																																																																																																																																																																																																																									
					50																																																																																																																																																																																																																																																																																																																																																																																																																																									
					123																																																																																																																																																																																																																																																																																																																																																																																																																																									
					143																																																																																																																																																																																																																																																																																																																																																																																																																																									
					96																																																																																																																																																																																																																																																																																																																																																																																																																																									
					124																																																																																																																																																																																																																																																																																																																																																																																																																																									
					138																																																																																																																																																																																																																																																																																																																																																																																																																																									
					123																																																																																																																																																																																																																																																																																																																																																																																																																																									
					46																																																																																																																																																																																																																																																																																																																																																																																																																																									
					90																																																																																																																																																																																																																																																																																																																																																																																																																																									
					128																																																																																																																																																																																																																																																																																																																																																																																																																																									
					51																																																																																																																																																																																																																																																																																																																																																																																																																																									
					151																																																																																																																																																																																																																																																																																																																																																																																																																																									
					109																																																																																																																																																																																																																																																																																																																																																																																																																																									
					150																																																																																																																																																																																																																																																																																																																																																																																																																																									
					150																																																																																																																																																																																																																																																																																																																																																																																																																																									
					67																																																																																																																																																																																																																																																																																																																																																																																																																																									
					129																																																																																																																																																																																																																																																																																																																																																																																																																																									
					183																																																																																																																																																																																																																																																																																																																																																																																																																																									
					70																																																																																																																																																																																																																																																																																																																																																																																																																																									
					120																																																																																																																																																																																																																																																																																																																																																																																																																																									
					146																																																																																																																																																																																																																																																																																																																																																																																																																																									
					119																																																																																																																																																																																																																																																																																																																																																																																																																																									
					105																																																																																																																																																																																																																																																																																																																																																																																																																																									
					88																																																																																																																																																																																																																																																																																																																																																																																																																																									
					169																																																																																																																																																																																																																																																																																																																																																																																																																																									
					178																																																																																																																																																																																																																																																																																																																																																																																																																																									
					89																																																																																																																																																																																																																																																																																																																																																																																																																																									
					151																																																																																																																																																																																																																																																																																																																																																																																																																																									
					89																																																																																																																																																																																																																																																																																																																																																																																																																																									
					148																																																																																																																																																																																																																																																																																																																																																																																																																																									
					130																																																																																																																																																																																																																																																																																																																																																																																																																																									
支持架構寸法		荷重(kN)		鋼材サイズ	組合せ応力(MPa)		評価																																																																																																																																																																																																																																																																																																																																																																																																																																							
H(mm)	L(mm)	水平	鉛直		発生	許容																																																																																																																																																																																																																																																																																																																																																																																																																																								
				□75×75×4.5	8	216	○																																																																																																																																																																																																																																																																																																																																																																																																																																							
				□75×75×4.5	32	216	○																																																																																																																																																																																																																																																																																																																																																																																																																																							
				□75×75×4.5	62	216	○																																																																																																																																																																																																																																																																																																																																																																																																																																							
				□100×100×6	88	216	○																																																																																																																																																																																																																																																																																																																																																																																																																																							
				□125×125×6	119	216	○																																																																																																																																																																																																																																																																																																																																																																																																																																							
				□75×75×4.5	13	216	○																																																																																																																																																																																																																																																																																																																																																																																																																																							
				□75×75×4.5	59	216	○																																																																																																																																																																																																																																																																																																																																																																																																																																							
				□100×100×6	54	216	○																																																																																																																																																																																																																																																																																																																																																																																																																																							
				□125×125×6	107	216	○																																																																																																																																																																																																																																																																																																																																																																																																																																							
				□175×175×6	120	216	○																																																																																																																																																																																																																																																																																																																																																																																																																																							
				□75×75×4.5	18	216	○																																																																																																																																																																																																																																																																																																																																																																																																																																							
				□75×75×4.5	87	216	○																																																																																																																																																																																																																																																																																																																																																																																																																																							
				□100×100×6	80	216	○																																																																																																																																																																																																																																																																																																																																																																																																																																							
				□150×150×6	114	216	○																																																																																																																																																																																																																																																																																																																																																																																																																																							
				□200×200×9	97	216	○																																																																																																																																																																																																																																																																																																																																																																																																																																							

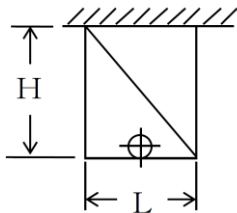
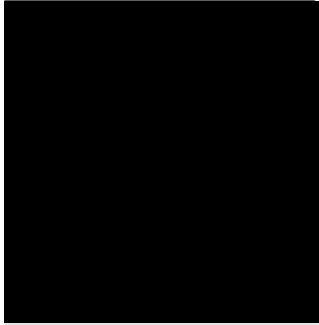
再処理施設	発電炉	備考																																																																																																																																																																																																																																																																																																																																																																																																	
添付書類IV-1-1	添付書類IV-1-1-11-1	添付書類V-2-1-12-1																																																																																																																																																																																																																																																																																																																																																																																																	
	<p>第3.1-9表(14/18) 支持架構の耐震計算結果</p> <table border="1"> <thead> <tr> <th colspan="2">支持架構寸法</th> <th colspan="2">荷重(kN)</th> <th rowspan="2">鋼材サイズ</th> <th rowspan="2">組合せ応力(MPa) 発生応力</th> </tr> <tr> <th>H(mm)</th> <th>L(mm)</th> <th>水平</th> <th>鉛直</th> </tr> </thead> <tbody> <tr><td></td><td></td><td></td><td></td><td></td><td>20</td></tr> <tr><td></td><td></td><td></td><td></td><td></td><td>38</td></tr> <tr><td></td><td></td><td></td><td></td><td></td><td>95</td></tr> <tr><td></td><td></td><td></td><td></td><td></td><td>189</td></tr> <tr><td></td><td></td><td></td><td></td><td></td><td>158</td></tr> <tr><td></td><td></td><td></td><td></td><td></td><td>143</td></tr> <tr><td></td><td></td><td></td><td></td><td></td><td>130</td></tr> <tr><td></td><td></td><td></td><td></td><td></td><td>118</td></tr> <tr><td></td><td></td><td></td><td></td><td></td><td>28</td></tr> <tr><td></td><td></td><td></td><td></td><td></td><td>55</td></tr> <tr><td></td><td></td><td></td><td></td><td></td><td>135</td></tr> <tr><td></td><td></td><td></td><td></td><td></td><td>157</td></tr> <tr><td></td><td></td><td></td><td></td><td></td><td>109</td></tr> <tr><td></td><td></td><td></td><td></td><td></td><td>153</td></tr> <tr><td></td><td></td><td></td><td></td><td></td><td>138</td></tr> <tr><td></td><td></td><td></td><td></td><td></td><td>147</td></tr> <tr><td></td><td></td><td></td><td></td><td></td><td>50</td></tr> <tr><td></td><td></td><td></td><td></td><td></td><td>97</td></tr> <tr><td></td><td></td><td></td><td></td><td></td><td>137</td></tr> <tr><td></td><td></td><td></td><td></td><td></td><td>53</td></tr> <tr><td></td><td></td><td></td><td></td><td></td><td>157</td></tr> <tr><td></td><td></td><td></td><td></td><td></td><td>113</td></tr> <tr><td></td><td></td><td></td><td></td><td></td><td>98</td></tr> <tr><td></td><td></td><td></td><td></td><td></td><td>157</td></tr> <tr><td></td><td></td><td></td><td></td><td></td><td>71</td></tr> <tr><td></td><td></td><td></td><td></td><td></td><td>137</td></tr> <tr><td></td><td></td><td></td><td></td><td></td><td>145</td></tr> <tr><td></td><td></td><td></td><td></td><td></td><td>72</td></tr> <tr><td></td><td></td><td></td><td></td><td></td><td>124</td></tr> <tr><td></td><td></td><td></td><td></td><td></td><td>151</td></tr> <tr><td></td><td></td><td></td><td></td><td></td><td>124</td></tr> <tr><td></td><td></td><td></td><td></td><td></td><td>109</td></tr> <tr><td></td><td></td><td></td><td></td><td></td><td>93</td></tr> <tr><td></td><td></td><td></td><td></td><td></td><td>178</td></tr> <tr><td></td><td></td><td></td><td></td><td></td><td>47</td></tr> <tr><td></td><td></td><td></td><td></td><td></td><td>91</td></tr> <tr><td></td><td></td><td></td><td></td><td></td><td>155</td></tr> <tr><td></td><td></td><td></td><td></td><td></td><td>92</td></tr> <tr><td></td><td></td><td></td><td></td><td></td><td>153</td></tr> <tr><td></td><td></td><td></td><td></td><td></td><td>134</td></tr> </tbody> </table>  <p>基本形状：タイプ4 許容値：235MPa</p>	支持架構寸法		荷重(kN)		鋼材サイズ	組合せ応力(MPa) 発生応力	H(mm)	L(mm)	水平	鉛直						20						38						95						189						158						143						130						118						28						55						135						157						109						153						138						147						50						97						137						53						157						113						98						157						71						137						145						72						124						151						124						109						93						178						47						91						155						92						153						134	<p>表5-10-14 支持架構の耐震計算結果</p> <table border="1"> <thead> <tr> <th colspan="2">支持架構寸法</th> <th colspan="2">荷重(kN)</th> <th rowspan="2">鋼材サイズ</th> <th colspan="2">組合せ応力(MPa)</th> <th rowspan="2">評価</th> </tr> <tr> <th>H(mm)</th> <th>L(mm)</th> <th>水平</th> <th>鉛直</th> <th>発生 応力</th> <th>許容 応力</th> </tr> </thead> <tbody> <tr><td></td><td></td><td></td><td></td><td>□75×75×4.5</td><td>8</td><td>216</td><td>○</td></tr> <tr><td></td><td></td><td></td><td></td><td>□75×75×4.5</td><td>30</td><td>216</td><td>○</td></tr> <tr><td></td><td></td><td></td><td></td><td>□75×75×4.5</td><td>60</td><td>216</td><td>○</td></tr> <tr><td></td><td></td><td></td><td></td><td>□100×100×6</td><td>84</td><td>216</td><td>○</td></tr> <tr><td></td><td></td><td></td><td></td><td>□125×125×6</td><td>114</td><td>216</td><td>○</td></tr> <tr><td></td><td></td><td></td><td></td><td>□75×75×4.5</td><td>13</td><td>216</td><td>○</td></tr> <tr><td></td><td></td><td></td><td></td><td>□75×75×4.5</td><td>56</td><td>216</td><td>○</td></tr> <tr><td></td><td></td><td></td><td></td><td>□100×100×6</td><td>52</td><td>216</td><td>○</td></tr> <tr><td></td><td></td><td></td><td></td><td>□125×125×6</td><td>102</td><td>216</td><td>○</td></tr> <tr><td></td><td></td><td></td><td></td><td>□175×175×6</td><td>114</td><td>216</td><td>○</td></tr> <tr><td></td><td></td><td></td><td></td><td>□75×75×4.5</td><td>17</td><td>216</td><td>○</td></tr> <tr><td></td><td></td><td></td><td></td><td>□75×75×4.5</td><td>83</td><td>216</td><td>○</td></tr> <tr><td></td><td></td><td></td><td></td><td>□100×100×6</td><td>77</td><td>216</td><td>○</td></tr> <tr><td></td><td></td><td></td><td></td><td>□150×150×6</td><td>108</td><td>216</td><td>○</td></tr> <tr><td></td><td></td><td></td><td></td><td>□200×200×9</td><td>92</td><td>216</td><td>○</td></tr> </tbody> </table>  <p>基本形状：タイプ6</p>	支持架構寸法		荷重(kN)		鋼材サイズ	組合せ応力(MPa)		評価	H(mm)	L(mm)	水平	鉛直	発生 応力	許容 応力					□75×75×4.5	8	216	○					□75×75×4.5	30	216	○					□75×75×4.5	60	216	○					□100×100×6	84	216	○					□125×125×6	114	216	○					□75×75×4.5	13	216	○					□75×75×4.5	56	216	○					□100×100×6	52	216	○					□125×125×6	102	216	○					□175×175×6	114	216	○					□75×75×4.5	17	216	○					□75×75×4.5	83	216	○					□100×100×6	77	216	○					□150×150×6	108	216	○					□200×200×9	92	216	○	<p>・2項で示している支持構造物の耐震評価結果を型式ごとに記載しており、記載の差異により新たな論点が生じるものではない。</p>
支持架構寸法		荷重(kN)		鋼材サイズ	組合せ応力(MPa) 発生応力																																																																																																																																																																																																																																																																																																																																																																																														
H(mm)	L(mm)	水平	鉛直																																																																																																																																																																																																																																																																																																																																																																																																
					20																																																																																																																																																																																																																																																																																																																																																																																														
					38																																																																																																																																																																																																																																																																																																																																																																																														
					95																																																																																																																																																																																																																																																																																																																																																																																														
					189																																																																																																																																																																																																																																																																																																																																																																																														
					158																																																																																																																																																																																																																																																																																																																																																																																														
					143																																																																																																																																																																																																																																																																																																																																																																																														
					130																																																																																																																																																																																																																																																																																																																																																																																														
					118																																																																																																																																																																																																																																																																																																																																																																																														
					28																																																																																																																																																																																																																																																																																																																																																																																														
					55																																																																																																																																																																																																																																																																																																																																																																																														
					135																																																																																																																																																																																																																																																																																																																																																																																														
					157																																																																																																																																																																																																																																																																																																																																																																																														
					109																																																																																																																																																																																																																																																																																																																																																																																														
					153																																																																																																																																																																																																																																																																																																																																																																																														
					138																																																																																																																																																																																																																																																																																																																																																																																														
					147																																																																																																																																																																																																																																																																																																																																																																																														
					50																																																																																																																																																																																																																																																																																																																																																																																														
					97																																																																																																																																																																																																																																																																																																																																																																																														
					137																																																																																																																																																																																																																																																																																																																																																																																														
					53																																																																																																																																																																																																																																																																																																																																																																																														
					157																																																																																																																																																																																																																																																																																																																																																																																														
					113																																																																																																																																																																																																																																																																																																																																																																																														
					98																																																																																																																																																																																																																																																																																																																																																																																														
					157																																																																																																																																																																																																																																																																																																																																																																																														
					71																																																																																																																																																																																																																																																																																																																																																																																														
					137																																																																																																																																																																																																																																																																																																																																																																																														
					145																																																																																																																																																																																																																																																																																																																																																																																														
					72																																																																																																																																																																																																																																																																																																																																																																																														
					124																																																																																																																																																																																																																																																																																																																																																																																														
					151																																																																																																																																																																																																																																																																																																																																																																																														
					124																																																																																																																																																																																																																																																																																																																																																																																														
					109																																																																																																																																																																																																																																																																																																																																																																																														
					93																																																																																																																																																																																																																																																																																																																																																																																														
					178																																																																																																																																																																																																																																																																																																																																																																																														
					47																																																																																																																																																																																																																																																																																																																																																																																														
					91																																																																																																																																																																																																																																																																																																																																																																																														
					155																																																																																																																																																																																																																																																																																																																																																																																														
					92																																																																																																																																																																																																																																																																																																																																																																																														
					153																																																																																																																																																																																																																																																																																																																																																																																														
					134																																																																																																																																																																																																																																																																																																																																																																																														
支持架構寸法		荷重(kN)		鋼材サイズ	組合せ応力(MPa)		評価																																																																																																																																																																																																																																																																																																																																																																																												
H(mm)	L(mm)	水平	鉛直		発生 応力	許容 応力																																																																																																																																																																																																																																																																																																																																																																																													
				□75×75×4.5	8	216	○																																																																																																																																																																																																																																																																																																																																																																																												
				□75×75×4.5	30	216	○																																																																																																																																																																																																																																																																																																																																																																																												
				□75×75×4.5	60	216	○																																																																																																																																																																																																																																																																																																																																																																																												
				□100×100×6	84	216	○																																																																																																																																																																																																																																																																																																																																																																																												
				□125×125×6	114	216	○																																																																																																																																																																																																																																																																																																																																																																																												
				□75×75×4.5	13	216	○																																																																																																																																																																																																																																																																																																																																																																																												
				□75×75×4.5	56	216	○																																																																																																																																																																																																																																																																																																																																																																																												
				□100×100×6	52	216	○																																																																																																																																																																																																																																																																																																																																																																																												
				□125×125×6	102	216	○																																																																																																																																																																																																																																																																																																																																																																																												
				□175×175×6	114	216	○																																																																																																																																																																																																																																																																																																																																																																																												
				□75×75×4.5	17	216	○																																																																																																																																																																																																																																																																																																																																																																																												
				□75×75×4.5	83	216	○																																																																																																																																																																																																																																																																																																																																																																																												
				□100×100×6	77	216	○																																																																																																																																																																																																																																																																																																																																																																																												
				□150×150×6	108	216	○																																																																																																																																																																																																																																																																																																																																																																																												
				□200×200×9	92	216	○																																																																																																																																																																																																																																																																																																																																																																																												

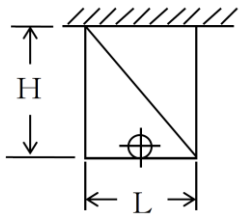
再処理施設	発電炉	備考																																																																																																																																																																																																																																																										
添付書類IV-1-1	添付書類IV-1-1-11-1	添付書類V-2-1-12-1																																																																																																																																																																																																																																																										
	<p>第3.1-9表(15/18) 支持架構の耐震計算結果</p> <table border="1"> <thead> <tr> <th colspan="2">支持架構寸法</th> <th colspan="2">荷重(kN)</th> <th rowspan="2">鋼材サイズ</th> <th rowspan="2">組合せ応力(MPa) 発生応力</th> </tr> <tr> <th>H(mm)</th> <th>L(mm)</th> <th>水平</th> <th>鉛直</th> </tr> </thead> <tbody> <tr><td></td><td></td><td></td><td></td><td></td><td>22</td></tr> <tr><td></td><td></td><td></td><td></td><td></td><td>42</td></tr> <tr><td></td><td></td><td></td><td></td><td></td><td>105</td></tr> <tr><td></td><td></td><td></td><td></td><td></td><td>159</td></tr> <tr><td></td><td></td><td></td><td></td><td></td><td>150</td></tr> <tr><td></td><td></td><td></td><td></td><td></td><td>111</td></tr> <tr><td></td><td></td><td></td><td></td><td></td><td>104</td></tr> <tr><td></td><td></td><td></td><td></td><td></td><td>142</td></tr> <tr><td></td><td></td><td></td><td></td><td></td><td>30</td></tr> <tr><td></td><td></td><td></td><td></td><td></td><td>59</td></tr> <tr><td></td><td></td><td></td><td></td><td></td><td>145</td></tr> <tr><td></td><td></td><td></td><td></td><td></td><td>169</td></tr> <tr><td></td><td></td><td></td><td></td><td></td><td>146</td></tr> <tr><td></td><td></td><td></td><td></td><td></td><td>146</td></tr> <tr><td></td><td></td><td></td><td></td><td></td><td>143</td></tr> <tr><td></td><td></td><td></td><td></td><td></td><td>132</td></tr> <tr><td></td><td></td><td></td><td></td><td></td><td>53</td></tr> <tr><td></td><td></td><td></td><td></td><td></td><td>102</td></tr> <tr><td></td><td></td><td></td><td></td><td></td><td>144</td></tr> <tr><td></td><td></td><td></td><td></td><td></td><td>55</td></tr> <tr><td></td><td></td><td></td><td></td><td></td><td>163</td></tr> <tr><td></td><td></td><td></td><td></td><td></td><td>116</td></tr> <tr><td></td><td></td><td></td><td></td><td></td><td>104</td></tr> <tr><td></td><td></td><td></td><td></td><td></td><td>166</td></tr> <tr><td></td><td></td><td></td><td></td><td></td><td>75</td></tr> <tr><td></td><td></td><td></td><td></td><td></td><td>144</td></tr> <tr><td></td><td></td><td></td><td></td><td></td><td>152</td></tr> <tr><td></td><td></td><td></td><td></td><td></td><td>75</td></tr> <tr><td></td><td></td><td></td><td></td><td></td><td>127</td></tr> <tr><td></td><td></td><td></td><td></td><td></td><td>155</td></tr> <tr><td></td><td></td><td></td><td></td><td></td><td>127</td></tr> <tr><td></td><td></td><td></td><td></td><td></td><td>112</td></tr> <tr><td></td><td></td><td></td><td></td><td></td><td>97</td></tr> <tr><td></td><td></td><td></td><td></td><td></td><td>186</td></tr> <tr><td></td><td></td><td></td><td></td><td></td><td>48</td></tr> <tr><td></td><td></td><td></td><td></td><td></td><td>94</td></tr> <tr><td></td><td></td><td></td><td></td><td></td><td>159</td></tr> <tr><td></td><td></td><td></td><td></td><td></td><td>94</td></tr> <tr><td></td><td></td><td></td><td></td><td></td><td>156</td></tr> <tr><td></td><td></td><td></td><td></td><td></td><td>137</td></tr> </tbody> </table>  <p>基本形状：タイプ4 許容値：235MPa</p>	支持架構寸法		荷重(kN)		鋼材サイズ	組合せ応力(MPa) 発生応力	H(mm)	L(mm)	水平	鉛直						22						42						105						159						150						111						104						142						30						59						145						169						146						146						143						132						53						102						144						55						163						116						104						166						75						144						152						75						127						155						127						112						97						186						48						94						159						94						156						137	<p>・2項で示している支持構造物の耐震評価結果を型式ごとに記載しており、記載の差異により新たな論点が生じるものではない。</p>
支持架構寸法		荷重(kN)		鋼材サイズ	組合せ応力(MPa) 発生応力																																																																																																																																																																																																																																																							
H(mm)	L(mm)	水平	鉛直																																																																																																																																																																																																																																																									
					22																																																																																																																																																																																																																																																							
					42																																																																																																																																																																																																																																																							
					105																																																																																																																																																																																																																																																							
					159																																																																																																																																																																																																																																																							
					150																																																																																																																																																																																																																																																							
					111																																																																																																																																																																																																																																																							
					104																																																																																																																																																																																																																																																							
					142																																																																																																																																																																																																																																																							
					30																																																																																																																																																																																																																																																							
					59																																																																																																																																																																																																																																																							
					145																																																																																																																																																																																																																																																							
					169																																																																																																																																																																																																																																																							
					146																																																																																																																																																																																																																																																							
					146																																																																																																																																																																																																																																																							
					143																																																																																																																																																																																																																																																							
					132																																																																																																																																																																																																																																																							
					53																																																																																																																																																																																																																																																							
					102																																																																																																																																																																																																																																																							
					144																																																																																																																																																																																																																																																							
					55																																																																																																																																																																																																																																																							
					163																																																																																																																																																																																																																																																							
					116																																																																																																																																																																																																																																																							
					104																																																																																																																																																																																																																																																							
					166																																																																																																																																																																																																																																																							
					75																																																																																																																																																																																																																																																							
					144																																																																																																																																																																																																																																																							
					152																																																																																																																																																																																																																																																							
					75																																																																																																																																																																																																																																																							
					127																																																																																																																																																																																																																																																							
					155																																																																																																																																																																																																																																																							
					127																																																																																																																																																																																																																																																							
					112																																																																																																																																																																																																																																																							
					97																																																																																																																																																																																																																																																							
					186																																																																																																																																																																																																																																																							
					48																																																																																																																																																																																																																																																							
					94																																																																																																																																																																																																																																																							
					159																																																																																																																																																																																																																																																							
					94																																																																																																																																																																																																																																																							
					156																																																																																																																																																																																																																																																							
					137																																																																																																																																																																																																																																																							

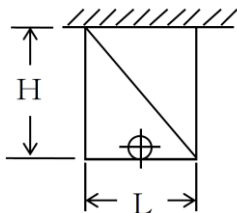
再処理施設	発電炉	備考																																																																																																																																																																																																																																																										
添付書類IV-1-1	添付書類IV-1-1-11-1	添付書類V-2-1-12-1																																																																																																																																																																																																																																																										
	<p>第3.1-9表(16/18) 支持架構の耐震計算結果</p> <table border="1"> <thead> <tr> <th colspan="2">支持架構寸法</th> <th colspan="2">荷重(kN)</th> <th rowspan="2">鋼材サイズ</th> <th rowspan="2">組合せ応力(MPa) 発生応力</th> </tr> <tr> <th>H(mm)</th> <th>L(mm)</th> <th>水平</th> <th>鉛直</th> </tr> </thead> <tbody> <tr><td></td><td></td><td></td><td></td><td></td><td>26</td></tr> <tr><td></td><td></td><td></td><td></td><td></td><td>51</td></tr> <tr><td></td><td></td><td></td><td></td><td></td><td>127</td></tr> <tr><td></td><td></td><td></td><td></td><td></td><td>97</td></tr> <tr><td></td><td></td><td></td><td></td><td></td><td>132</td></tr> <tr><td></td><td></td><td></td><td></td><td></td><td>145</td></tr> <tr><td></td><td></td><td></td><td></td><td></td><td>135</td></tr> <tr><td></td><td></td><td></td><td></td><td></td><td>131</td></tr> <tr><td></td><td></td><td></td><td></td><td></td><td>32</td></tr> <tr><td></td><td></td><td></td><td></td><td></td><td>62</td></tr> <tr><td></td><td></td><td></td><td></td><td></td><td>153</td></tr> <tr><td></td><td></td><td></td><td></td><td></td><td>180</td></tr> <tr><td></td><td></td><td></td><td></td><td></td><td>183</td></tr> <tr><td></td><td></td><td></td><td></td><td></td><td>142</td></tr> <tr><td></td><td></td><td></td><td></td><td></td><td>156</td></tr> <tr><td></td><td></td><td></td><td></td><td></td><td>137</td></tr> <tr><td></td><td></td><td></td><td></td><td></td><td>55</td></tr> <tr><td></td><td></td><td></td><td></td><td></td><td>107</td></tr> <tr><td></td><td></td><td></td><td></td><td></td><td>151</td></tr> <tr><td></td><td></td><td></td><td></td><td></td><td>57</td></tr> <tr><td></td><td></td><td></td><td></td><td></td><td>98</td></tr> <tr><td></td><td></td><td></td><td></td><td></td><td>120</td></tr> <tr><td></td><td></td><td></td><td></td><td></td><td>112</td></tr> <tr><td></td><td></td><td></td><td></td><td></td><td>172</td></tr> <tr><td></td><td></td><td></td><td></td><td></td><td>78</td></tr> <tr><td></td><td></td><td></td><td></td><td></td><td>150</td></tr> <tr><td></td><td></td><td></td><td></td><td></td><td>157</td></tr> <tr><td></td><td></td><td></td><td></td><td></td><td>77</td></tr> <tr><td></td><td></td><td></td><td></td><td></td><td>131</td></tr> <tr><td></td><td></td><td></td><td></td><td></td><td>159</td></tr> <tr><td></td><td></td><td></td><td></td><td></td><td>129</td></tr> <tr><td></td><td></td><td></td><td></td><td></td><td>114</td></tr> <tr><td></td><td></td><td></td><td></td><td></td><td>101</td></tr> <tr><td></td><td></td><td></td><td></td><td></td><td>193</td></tr> <tr><td></td><td></td><td></td><td></td><td></td><td>50</td></tr> <tr><td></td><td></td><td></td><td></td><td></td><td>97</td></tr> <tr><td></td><td></td><td></td><td></td><td></td><td>163</td></tr> <tr><td></td><td></td><td></td><td></td><td></td><td>96</td></tr> <tr><td></td><td></td><td></td><td></td><td></td><td>159</td></tr> <tr><td></td><td></td><td></td><td></td><td></td><td>139</td></tr> </tbody> </table>  <p>基本形状：タイプ4 許容値：235MPa</p>	支持架構寸法		荷重(kN)		鋼材サイズ	組合せ応力(MPa) 発生応力	H(mm)	L(mm)	水平	鉛直						26						51						127						97						132						145						135						131						32						62						153						180						183						142						156						137						55						107						151						57						98						120						112						172						78						150						157						77						131						159						129						114						101						193						50						97						163						96						159						139	<p>・2項で示している支持構造物の耐震評価結果を型式ごとに記載しており、記載の差異により新たな論点が生じるものではない。</p>
支持架構寸法		荷重(kN)		鋼材サイズ	組合せ応力(MPa) 発生応力																																																																																																																																																																																																																																																							
H(mm)	L(mm)	水平	鉛直																																																																																																																																																																																																																																																									
					26																																																																																																																																																																																																																																																							
					51																																																																																																																																																																																																																																																							
					127																																																																																																																																																																																																																																																							
					97																																																																																																																																																																																																																																																							
					132																																																																																																																																																																																																																																																							
					145																																																																																																																																																																																																																																																							
					135																																																																																																																																																																																																																																																							
					131																																																																																																																																																																																																																																																							
					32																																																																																																																																																																																																																																																							
					62																																																																																																																																																																																																																																																							
					153																																																																																																																																																																																																																																																							
					180																																																																																																																																																																																																																																																							
					183																																																																																																																																																																																																																																																							
					142																																																																																																																																																																																																																																																							
					156																																																																																																																																																																																																																																																							
					137																																																																																																																																																																																																																																																							
					55																																																																																																																																																																																																																																																							
					107																																																																																																																																																																																																																																																							
					151																																																																																																																																																																																																																																																							
					57																																																																																																																																																																																																																																																							
					98																																																																																																																																																																																																																																																							
					120																																																																																																																																																																																																																																																							
					112																																																																																																																																																																																																																																																							
					172																																																																																																																																																																																																																																																							
					78																																																																																																																																																																																																																																																							
					150																																																																																																																																																																																																																																																							
					157																																																																																																																																																																																																																																																							
					77																																																																																																																																																																																																																																																							
					131																																																																																																																																																																																																																																																							
					159																																																																																																																																																																																																																																																							
					129																																																																																																																																																																																																																																																							
					114																																																																																																																																																																																																																																																							
					101																																																																																																																																																																																																																																																							
					193																																																																																																																																																																																																																																																							
					50																																																																																																																																																																																																																																																							
					97																																																																																																																																																																																																																																																							
					163																																																																																																																																																																																																																																																							
					96																																																																																																																																																																																																																																																							
					159																																																																																																																																																																																																																																																							
					139																																																																																																																																																																																																																																																							

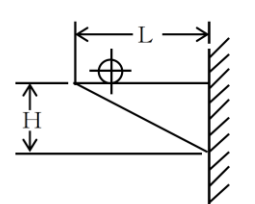
再処理施設	発電炉	備考																																																																																																																																																																																																																																																										
添付書類IV-1-1	添付書類IV-1-1-11-1	添付書類V-2-1-12-1																																																																																																																																																																																																																																																										
	<p style="text-align: center;">第 3.1-9 表(17/18) 支持架構の耐震計算結果</p> <table border="1" style="width: 100%; border-collapse: collapse;"> <thead> <tr> <th colspan="2">支持架構寸法</th> <th colspan="2">荷重(kN)</th> <th rowspan="2">鋼材サイズ</th> <th rowspan="2">組合せ応力(MPa) 発生応力</th> </tr> <tr> <th>H(mm)</th> <th>L(mm)</th> <th>水平</th> <th>鉛直</th> </tr> </thead> <tbody> <tr><td colspan="5" style="background-color: black;"></td><td>17</td></tr> <tr><td colspan="5" style="background-color: black;"></td><td>33</td></tr> <tr><td colspan="5" style="background-color: black;"></td><td>81</td></tr> <tr><td colspan="5" style="background-color: black;"></td><td>161</td></tr> <tr><td colspan="5" style="background-color: black;"></td><td>107</td></tr> <tr><td colspan="5" style="background-color: black;"></td><td>138</td></tr> <tr><td colspan="5" style="background-color: black;"></td><td>152</td></tr> <tr><td colspan="5" style="background-color: black;"></td><td>131</td></tr> <tr><td colspan="5" style="background-color: black;"></td><td>18</td></tr> <tr><td colspan="5" style="background-color: black;"></td><td>36</td></tr> <tr><td colspan="5" style="background-color: black;"></td><td>88</td></tr> <tr><td colspan="5" style="background-color: black;"></td><td>176</td></tr> <tr><td colspan="5" style="background-color: black;"></td><td>120</td></tr> <tr><td colspan="5" style="background-color: black;"></td><td>162</td></tr> <tr><td colspan="5" style="background-color: black;"></td><td>146</td></tr> <tr><td colspan="5" style="background-color: black;"></td><td>155</td></tr> <tr><td colspan="5" style="background-color: black;"></td><td>21</td></tr> <tr><td colspan="5" style="background-color: black;"></td><td>40</td></tr> <tr><td colspan="5" style="background-color: black;"></td><td>98</td></tr> <tr><td colspan="5" style="background-color: black;"></td><td>118</td></tr> <tr><td colspan="5" style="background-color: black;"></td><td>115</td></tr> <tr><td colspan="5" style="background-color: black;"></td><td>160</td></tr> <tr><td colspan="5" style="background-color: black;"></td><td>147</td></tr> <tr><td colspan="5" style="background-color: black;"></td><td>156</td></tr> <tr><td colspan="5" style="background-color: black;"></td><td>22</td></tr> <tr><td colspan="5" style="background-color: black;"></td><td>42</td></tr> <tr><td colspan="5" style="background-color: black;"></td><td>101</td></tr> <tr><td colspan="5" style="background-color: black;"></td><td>122</td></tr> <tr><td colspan="5" style="background-color: black;"></td><td>110</td></tr> <tr><td colspan="5" style="background-color: black;"></td><td>152</td></tr> <tr><td colspan="5" style="background-color: black;"></td><td>139</td></tr> <tr><td colspan="5" style="background-color: black;"></td><td>147</td></tr> <tr><td colspan="5" style="background-color: black;"></td><td>24</td></tr> <tr><td colspan="5" style="background-color: black;"></td><td>44</td></tr> <tr><td colspan="5" style="background-color: black;"></td><td>103</td></tr> <tr><td colspan="5" style="background-color: black;"></td><td>124</td></tr> <tr><td colspan="5" style="background-color: black;"></td><td>110</td></tr> <tr><td colspan="5" style="background-color: black;"></td><td>146</td></tr> <tr><td colspan="5" style="background-color: black;"></td><td>134</td></tr> <tr><td colspan="5" style="background-color: black;"></td><td>140</td></tr> </tbody> </table> <div style="text-align: center; margin-top: 20px;">  <div style="border: 1px solid black; padding: 5px; width: fit-content; margin: 0 auto;"> 基本形状：タイプ5 許容値：235MPa </div> </div>	支持架構寸法		荷重(kN)		鋼材サイズ	組合せ応力(MPa) 発生応力	H(mm)	L(mm)	水平	鉛直						17						33						81						161						107						138						152						131						18						36						88						176						120						162						146						155						21						40						98						118						115						160						147						156						22						42						101						122						110						152						139						147						24						44						103						124						110						146						134						140	<p>・ 2項で示している支持構造物の耐震評価結果を型式ごとに記載しており、記載の差異により新たな論点が生じるものではない。</p>
支持架構寸法		荷重(kN)		鋼材サイズ	組合せ応力(MPa) 発生応力																																																																																																																																																																																																																																																							
H(mm)	L(mm)	水平	鉛直																																																																																																																																																																																																																																																									
					17																																																																																																																																																																																																																																																							
					33																																																																																																																																																																																																																																																							
					81																																																																																																																																																																																																																																																							
					161																																																																																																																																																																																																																																																							
					107																																																																																																																																																																																																																																																							
					138																																																																																																																																																																																																																																																							
					152																																																																																																																																																																																																																																																							
					131																																																																																																																																																																																																																																																							
					18																																																																																																																																																																																																																																																							
					36																																																																																																																																																																																																																																																							
					88																																																																																																																																																																																																																																																							
					176																																																																																																																																																																																																																																																							
					120																																																																																																																																																																																																																																																							
					162																																																																																																																																																																																																																																																							
					146																																																																																																																																																																																																																																																							
					155																																																																																																																																																																																																																																																							
					21																																																																																																																																																																																																																																																							
					40																																																																																																																																																																																																																																																							
					98																																																																																																																																																																																																																																																							
					118																																																																																																																																																																																																																																																							
					115																																																																																																																																																																																																																																																							
					160																																																																																																																																																																																																																																																							
					147																																																																																																																																																																																																																																																							
					156																																																																																																																																																																																																																																																							
					22																																																																																																																																																																																																																																																							
					42																																																																																																																																																																																																																																																							
					101																																																																																																																																																																																																																																																							
					122																																																																																																																																																																																																																																																							
					110																																																																																																																																																																																																																																																							
					152																																																																																																																																																																																																																																																							
					139																																																																																																																																																																																																																																																							
					147																																																																																																																																																																																																																																																							
					24																																																																																																																																																																																																																																																							
					44																																																																																																																																																																																																																																																							
					103																																																																																																																																																																																																																																																							
					124																																																																																																																																																																																																																																																							
					110																																																																																																																																																																																																																																																							
					146																																																																																																																																																																																																																																																							
					134																																																																																																																																																																																																																																																							
					140																																																																																																																																																																																																																																																							

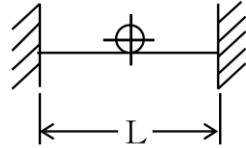
再処理施設	発電炉	備考																																																																																																																																																																																																																																																										
添付書類IV-1-1	添付書類IV-1-1-11-1	添付書類V-2-1-12-1																																																																																																																																																																																																																																																										
	<p style="text-align: center;">第 3.1-9 表(18/18) 支持架構の耐震計算結果</p> <table border="1" style="width: 100%; border-collapse: collapse;"> <thead> <tr> <th colspan="2">支持架構寸法</th> <th colspan="2">荷 重 (kN)</th> <th rowspan="2">鋼材サイズ</th> <th rowspan="2">組合せ応力 (MPa) 発生応力</th> </tr> <tr> <th>H (mm)</th> <th>L (mm)</th> <th>水 平</th> <th>鉛 直</th> </tr> </thead> <tbody> <tr><td colspan="5" style="background-color: black;"></td><td>12</td></tr> <tr><td colspan="5" style="background-color: black;"></td><td>24</td></tr> <tr><td colspan="5" style="background-color: black;"></td><td>58</td></tr> <tr><td colspan="5" style="background-color: black;"></td><td>116</td></tr> <tr><td colspan="5" style="background-color: black;"></td><td>154</td></tr> <tr><td colspan="5" style="background-color: black;"></td><td>96</td></tr> <tr><td colspan="5" style="background-color: black;"></td><td>160</td></tr> <tr><td colspan="5" style="background-color: black;"></td><td>159</td></tr> <tr><td colspan="5" style="background-color: black;"></td><td>19</td></tr> <tr><td colspan="5" style="background-color: black;"></td><td>38</td></tr> <tr><td colspan="5" style="background-color: black;"></td><td>94</td></tr> <tr><td colspan="5" style="background-color: black;"></td><td>187</td></tr> <tr><td colspan="5" style="background-color: black;"></td><td>67</td></tr> <tr><td colspan="5" style="background-color: black;"></td><td>133</td></tr> <tr><td colspan="5" style="background-color: black;"></td><td>132</td></tr> <tr><td colspan="5" style="background-color: black;"></td><td>135</td></tr> <tr><td colspan="5" style="background-color: black;"></td><td>38</td></tr> <tr><td colspan="5" style="background-color: black;"></td><td>74</td></tr> <tr><td colspan="5" style="background-color: black;"></td><td>183</td></tr> <tr><td colspan="5" style="background-color: black;"></td><td>155</td></tr> <tr><td colspan="5" style="background-color: black;"></td><td>115</td></tr> <tr><td colspan="5" style="background-color: black;"></td><td>132</td></tr> <tr><td colspan="5" style="background-color: black;"></td><td>136</td></tr> <tr><td colspan="5" style="background-color: black;"></td><td>108</td></tr> <tr><td colspan="5" style="background-color: black;"></td><td>58</td></tr> <tr><td colspan="5" style="background-color: black;"></td><td>111</td></tr> <tr><td colspan="5" style="background-color: black;"></td><td>156</td></tr> <tr><td colspan="5" style="background-color: black;"></td><td>56</td></tr> <tr><td colspan="5" style="background-color: black;"></td><td>94</td></tr> <tr><td colspan="5" style="background-color: black;"></td><td>114</td></tr> <tr><td colspan="5" style="background-color: black;"></td><td>92</td></tr> <tr><td colspan="5" style="background-color: black;"></td><td>147</td></tr> <tr><td colspan="5" style="background-color: black;"></td><td>78</td></tr> <tr><td colspan="5" style="background-color: black;"></td><td>149</td></tr> <tr><td colspan="5" style="background-color: black;"></td><td>155</td></tr> <tr><td colspan="5" style="background-color: black;"></td><td>73</td></tr> <tr><td colspan="5" style="background-color: black;"></td><td>122</td></tr> <tr><td colspan="5" style="background-color: black;"></td><td>146</td></tr> <tr><td colspan="5" style="background-color: black;"></td><td>117</td></tr> <tr><td colspan="5" style="background-color: black;"></td><td>101</td></tr> </tbody> </table> <div style="text-align: center; margin-top: 20px;">  <p style="margin: 5px 0;">基本形状：タイプ-6 許容値：235MPa</p> </div>	支持架構寸法		荷 重 (kN)		鋼材サイズ	組合せ応力 (MPa) 発生応力	H (mm)	L (mm)	水 平	鉛 直						12						24						58						116						154						96						160						159						19						38						94						187						67						133						132						135						38						74						183						155						115						132						136						108						58						111						156						56						94						114						92						147						78						149						155						73						122						146						117						101	<p>・ 2 項で示している支持構造物の耐震評価結果を型式ごとに記載しており、記載の差異により新たな論点が生じるものではない。</p>
支持架構寸法		荷 重 (kN)		鋼材サイズ	組合せ応力 (MPa) 発生応力																																																																																																																																																																																																																																																							
H (mm)	L (mm)	水 平	鉛 直																																																																																																																																																																																																																																																									
					12																																																																																																																																																																																																																																																							
					24																																																																																																																																																																																																																																																							
					58																																																																																																																																																																																																																																																							
					116																																																																																																																																																																																																																																																							
					154																																																																																																																																																																																																																																																							
					96																																																																																																																																																																																																																																																							
					160																																																																																																																																																																																																																																																							
					159																																																																																																																																																																																																																																																							
					19																																																																																																																																																																																																																																																							
					38																																																																																																																																																																																																																																																							
					94																																																																																																																																																																																																																																																							
					187																																																																																																																																																																																																																																																							
					67																																																																																																																																																																																																																																																							
					133																																																																																																																																																																																																																																																							
					132																																																																																																																																																																																																																																																							
					135																																																																																																																																																																																																																																																							
					38																																																																																																																																																																																																																																																							
					74																																																																																																																																																																																																																																																							
					183																																																																																																																																																																																																																																																							
					155																																																																																																																																																																																																																																																							
					115																																																																																																																																																																																																																																																							
					132																																																																																																																																																																																																																																																							
					136																																																																																																																																																																																																																																																							
					108																																																																																																																																																																																																																																																							
					58																																																																																																																																																																																																																																																							
					111																																																																																																																																																																																																																																																							
					156																																																																																																																																																																																																																																																							
					56																																																																																																																																																																																																																																																							
					94																																																																																																																																																																																																																																																							
					114																																																																																																																																																																																																																																																							
					92																																																																																																																																																																																																																																																							
					147																																																																																																																																																																																																																																																							
					78																																																																																																																																																																																																																																																							
					149																																																																																																																																																																																																																																																							
					155																																																																																																																																																																																																																																																							
					73																																																																																																																																																																																																																																																							
					122																																																																																																																																																																																																																																																							
					146																																																																																																																																																																																																																																																							
					117																																																																																																																																																																																																																																																							
					101																																																																																																																																																																																																																																																							

再処理施設	発電炉	備考																																																																																																																																																																															
添付書類IV-1-1	添付書類IV-1-1-11-1	添付書類V-2-1-12-1																																																																																																																																																																															
	<p>第3.1-10表(1/3) 埋込金物の耐震計算結果 (ベースプレート, 材料 [REDACTED]) (単位: MPa)</p> <table border="1"> <thead> <tr> <th>型式</th> <th>ベースプレートの 圧縮側の曲げ応力</th> <th>ベースプレートの 引張側の曲げ応力</th> <th>許容応力</th> <th>評 価</th> </tr> </thead> <tbody> <tr> <td>B</td> <td>48</td> <td>257</td> <td>271</td> <td>○</td> </tr> <tr> <td>C</td> <td>42</td> <td>105</td> <td>271</td> <td>○</td> </tr> <tr> <td>E</td> <td>21</td> <td>107</td> <td>271</td> <td>○</td> </tr> </tbody> </table> <p>第3.1-10表(2/3) 埋込金物の耐震計算結果 (スタッドジベル, 材料 [REDACTED]) (単位: MPa)</p> <table border="1"> <thead> <tr> <th rowspan="2">型式</th> <th colspan="2">引張応力</th> <th colspan="2">せん断応力</th> <th rowspan="2">評 価</th> </tr> <tr> <th>発生応力</th> <th>許容応力</th> <th>発生応力</th> <th>許容応力</th> </tr> </thead> <tbody> <tr> <td>B</td> <td>113</td> <td>235</td> <td>123</td> <td>135</td> <td>○</td> </tr> <tr> <td>C</td> <td>133</td> <td>235</td> <td>105</td> <td>135</td> <td>○</td> </tr> <tr> <td>E</td> <td>98</td> <td>235</td> <td>125</td> <td>135</td> <td>○</td> </tr> </tbody> </table> <p>第3.1-10表(3/3) 埋込金物の耐震計算結果 (コンクリート) (単位: N)</p> <table border="1"> <thead> <tr> <th rowspan="3">型式</th> <th colspan="2">コンクリート コーン状破壊における引張荷重</th> <th rowspan="3">評 価</th> </tr> <tr> <th>発生荷重</th> <th>許容荷重</th> </tr> </thead> <tbody> <tr> <td>B</td> <td>22632</td> <td>30600</td> <td>○</td> </tr> <tr> <td>C</td> <td>26682</td> <td>37400</td> <td>○</td> </tr> <tr> <td>E</td> <td>37135</td> <td>51100</td> <td>○</td> </tr> </tbody> </table>	型式	ベースプレートの 圧縮側の曲げ応力	ベースプレートの 引張側の曲げ応力	許容応力	評 価	B	48	257	271	○	C	42	105	271	○	E	21	107	271	○	型式	引張応力		せん断応力		評 価	発生応力	許容応力	発生応力	許容応力	B	113	235	123	135	○	C	133	235	105	135	○	E	98	235	125	135	○	型式	コンクリート コーン状破壊における引張荷重		評 価	発生荷重	許容荷重	B	22632	30600	○	C	26682	37400	○	E	37135	51100	○	<p>表5-11-1 埋込金物の耐震計算結果 (プレート)</p> <table border="1"> <thead> <tr> <th rowspan="2">タイプ</th> <th colspan="2">最大使用荷重(kN)</th> <th colspan="2">曲げ・せん断 共存時の応力(MPa)</th> <th rowspan="2">評 価</th> </tr> <tr> <th>引張荷重</th> <th>せん断荷重</th> <th>発生応力</th> <th>許容応力</th> </tr> </thead> <tbody> <tr> <td>I</td> <td>[REDACTED]</td> <td>[REDACTED]</td> <td>235</td> <td>235</td> <td>○</td> </tr> <tr> <td>VI</td> <td>[REDACTED]</td> <td>[REDACTED]</td> <td>235</td> <td>235</td> <td>○</td> </tr> <tr> <td>X</td> <td>[REDACTED]</td> <td>[REDACTED]</td> <td>245</td> <td>245</td> <td>○</td> </tr> </tbody> </table> <p>表5-11-2 埋込金物の耐震計算結果 (スタッド)</p> <table border="1"> <thead> <tr> <th rowspan="2">タイプ</th> <th colspan="2">最大使用荷重(kN)</th> <th colspan="2">引張応力(MPa)</th> <th rowspan="2">評 価</th> </tr> <tr> <th>引張荷重</th> <th>せん断荷重</th> <th>発生応力</th> <th>許容応力</th> </tr> </thead> <tbody> <tr> <td>I</td> <td>[REDACTED]</td> <td>[REDACTED]</td> <td>83</td> <td>235</td> <td>○</td> </tr> <tr> <td>VI</td> <td>[REDACTED]</td> <td>[REDACTED]</td> <td>49</td> <td>235</td> <td>○</td> </tr> <tr> <td>X</td> <td>[REDACTED]</td> <td>[REDACTED]</td> <td>26</td> <td>245</td> <td>○</td> </tr> </tbody> </table> <p>表5-11-3 埋込金物の耐震計算結果 (コンクリート)</p> <table border="1"> <thead> <tr> <th rowspan="3">タイプ</th> <th colspan="2">最大使用 荷重(kN)</th> <th colspan="4">引張荷重(kN)</th> <th colspan="2">せん断 荷重(kN)</th> <th rowspan="3">評 価</th> </tr> <tr> <th rowspan="2">引張 荷重</th> <th rowspan="2">せん断 荷重</th> <th colspan="2">シアコーン</th> <th colspan="2">支圧</th> <th rowspan="2">発生 荷重</th> <th rowspan="2">許容 荷重</th> </tr> <tr> <th>発生 荷重</th> <th>許容 荷重</th> <th>発生 荷重</th> <th>許容 荷重</th> </tr> </thead> <tbody> <tr> <td>I</td> <td>[REDACTED]</td> <td>[REDACTED]</td> <td>93.6</td> <td>157.4</td> <td>93.6</td> <td>437.9</td> <td>240.7</td> <td>299.4</td> <td>○</td> </tr> <tr> <td>VI</td> <td>[REDACTED]</td> <td>[REDACTED]</td> <td>146.4</td> <td>624.9</td> <td>146.4</td> <td>1002.5</td> <td>780.4</td> <td>802.8</td> <td>○</td> </tr> <tr> <td>X</td> <td>[REDACTED]</td> <td>[REDACTED]</td> <td>20.8</td> <td>81.4</td> <td>20.8</td> <td>295.8</td> <td>205.2</td> <td>212.3</td> <td>○</td> </tr> </tbody> </table>	タイプ	最大使用荷重(kN)		曲げ・せん断 共存時の応力(MPa)		評 価	引張荷重	せん断荷重	発生応力	許容応力	I	[REDACTED]	[REDACTED]	235	235	○	VI	[REDACTED]	[REDACTED]	235	235	○	X	[REDACTED]	[REDACTED]	245	245	○	タイプ	最大使用荷重(kN)		引張応力(MPa)		評 価	引張荷重	せん断荷重	発生応力	許容応力	I	[REDACTED]	[REDACTED]	83	235	○	VI	[REDACTED]	[REDACTED]	49	235	○	X	[REDACTED]	[REDACTED]	26	245	○	タイプ	最大使用 荷重(kN)		引張荷重(kN)				せん断 荷重(kN)		評 価	引張 荷重	せん断 荷重	シアコーン		支圧		発生 荷重	許容 荷重	発生 荷重	許容 荷重	発生 荷重	許容 荷重	I	[REDACTED]	[REDACTED]	93.6	157.4	93.6	437.9	240.7	299.4	○	VI	[REDACTED]	[REDACTED]	146.4	624.9	146.4	1002.5	780.4	802.8	○	X	[REDACTED]	[REDACTED]	20.8	81.4	20.8	295.8	205.2	212.3	○	<p>・ 2項で示している支持構造物の耐震評価結果を型式ごとに記載しており、記載の差異により新たな論点が生じるものではない。</p>
型式	ベースプレートの 圧縮側の曲げ応力	ベースプレートの 引張側の曲げ応力	許容応力	評 価																																																																																																																																																																													
B	48	257	271	○																																																																																																																																																																													
C	42	105	271	○																																																																																																																																																																													
E	21	107	271	○																																																																																																																																																																													
型式	引張応力		せん断応力		評 価																																																																																																																																																																												
	発生応力	許容応力	発生応力	許容応力																																																																																																																																																																													
B	113	235	123	135	○																																																																																																																																																																												
C	133	235	105	135	○																																																																																																																																																																												
E	98	235	125	135	○																																																																																																																																																																												
型式	コンクリート コーン状破壊における引張荷重		評 価																																																																																																																																																																														
	発生荷重	許容荷重																																																																																																																																																																															
	B	22632		30600	○																																																																																																																																																																												
C	26682	37400	○																																																																																																																																																																														
E	37135	51100	○																																																																																																																																																																														
タイプ	最大使用荷重(kN)		曲げ・せん断 共存時の応力(MPa)		評 価																																																																																																																																																																												
	引張荷重	せん断荷重	発生応力	許容応力																																																																																																																																																																													
I	[REDACTED]	[REDACTED]	235	235	○																																																																																																																																																																												
VI	[REDACTED]	[REDACTED]	235	235	○																																																																																																																																																																												
X	[REDACTED]	[REDACTED]	245	245	○																																																																																																																																																																												
タイプ	最大使用荷重(kN)		引張応力(MPa)		評 価																																																																																																																																																																												
	引張荷重	せん断荷重	発生応力	許容応力																																																																																																																																																																													
I	[REDACTED]	[REDACTED]	83	235	○																																																																																																																																																																												
VI	[REDACTED]	[REDACTED]	49	235	○																																																																																																																																																																												
X	[REDACTED]	[REDACTED]	26	245	○																																																																																																																																																																												
タイプ	最大使用 荷重(kN)		引張荷重(kN)				せん断 荷重(kN)		評 価																																																																																																																																																																								
	引張 荷重	せん断 荷重	シアコーン		支圧		発生 荷重	許容 荷重																																																																																																																																																																									
			発生 荷重	許容 荷重	発生 荷重	許容 荷重																																																																																																																																																																											
I	[REDACTED]	[REDACTED]	93.6	157.4	93.6	437.9	240.7	299.4	○																																																																																																																																																																								
VI	[REDACTED]	[REDACTED]	146.4	624.9	146.4	1002.5	780.4	802.8	○																																																																																																																																																																								
X	[REDACTED]	[REDACTED]	20.8	81.4	20.8	295.8	205.2	212.3	○																																																																																																																																																																								

再処理施設		発電炉	備考
添付書類IV-1-1	添付書類IV-1-1-11-1	添付書類V-2-1-12-1	
	<p>3.2 支持構造物の<u>基本形状の耐震計算結果</u></p> <p>3.2.1 支持構造物の耐震計算結果 支持構造物の<u>基本形状</u>を第3.2.1-1表に、耐震計算結果を第3.2.1-2表～第3.2.1-8表に示す。 なお、本項における耐震計算結果は、<u>支持構造物の基本形状を示したものである。本項に記載のない支持構造物については、基本形状を基に、設置状況に応じた架構寸法の変更、剛性を高めるための部材の追加又は基本形状を組み合わせた形状となり計算方法は同一であるため、耐震裕度としては同等である。</u></p> <p>3.2.2 個別の処置方法 支持構造物の評価において、支持点荷重が最大使用荷重を超えた場合には、標準支持間隔法であれば支持間隔の短縮化等による支持点荷重低減、多質点系はりモデル解析であれば使用鋼材又は構造の見直し等により強度向上を図るものとする。</p>	<p>5.2 <u>代表的な支持構造物の耐震計算例</u></p> <p>5.2.1 支持構造物の耐震計算例 代表的な支持構造物を表5-12に、耐震計算例を表5-13-1～表5-13-10に示す。 なお、本項における耐震計算結果は、<u>代表的な支持構造物の例を示したものであり、本項に記載のない支持構造物についても同様な評価を行う。</u></p> <p>5.2.2 個別の処置方法 支持構造物の評価において、支持点荷重が定格荷重又は最大使用荷重を超えた場合には、標準支持間隔法であれば支持間隔の短縮化等による支持点荷重低減、3次元はりモデル解析であれば使用鋼材又は構造の見直し等により強度向上を図るものとする。</p>	<p>・本項に記載のない支持構造物についての記載内容を充実化したものであり、記載の差異により新たな論点が生じるものではない。</p>

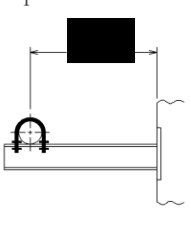
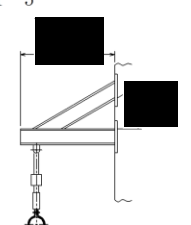
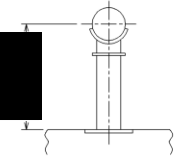
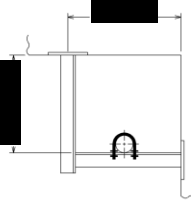
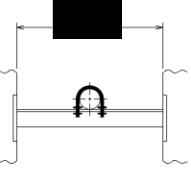
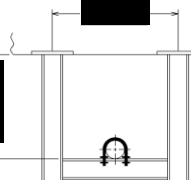
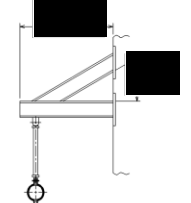
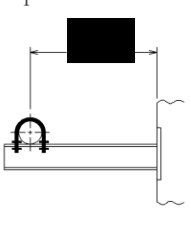
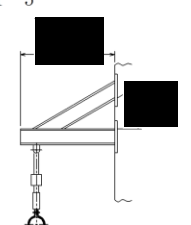
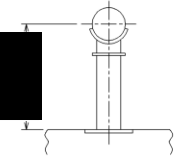
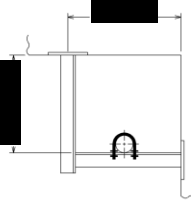
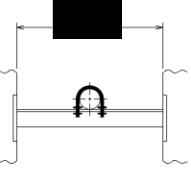
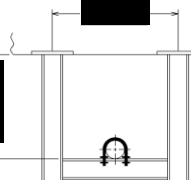
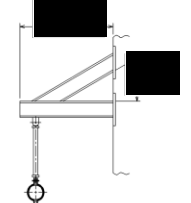
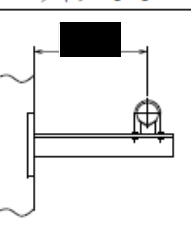
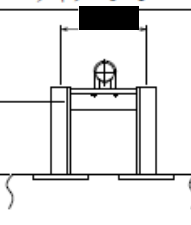
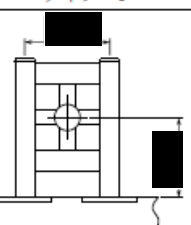
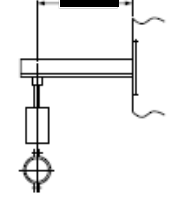
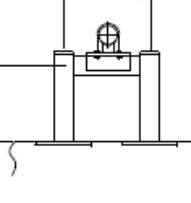
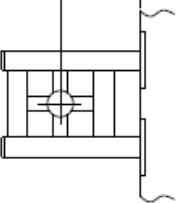
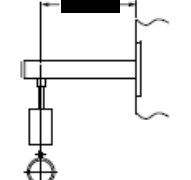
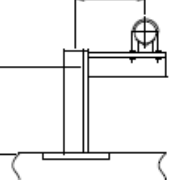
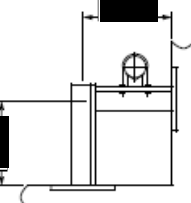
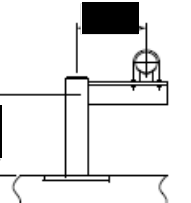
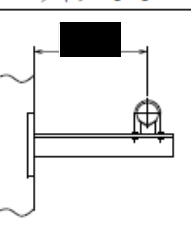
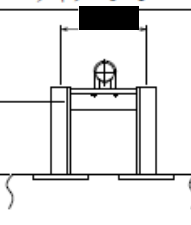
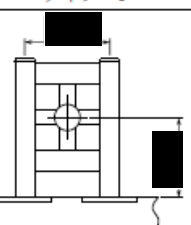
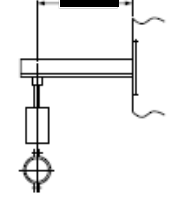
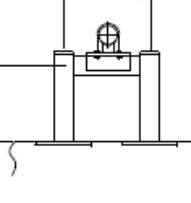
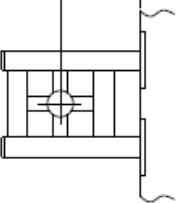
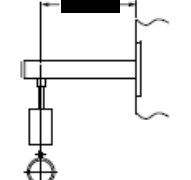
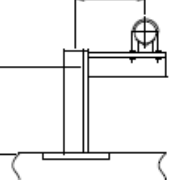
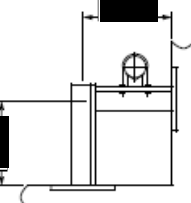
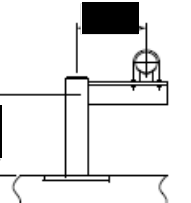
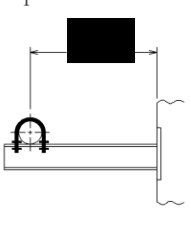
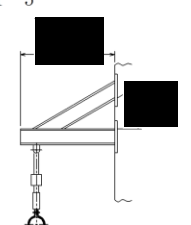
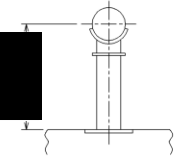
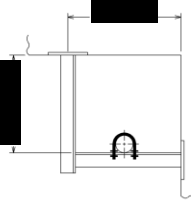
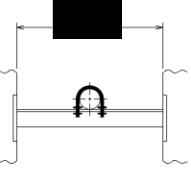
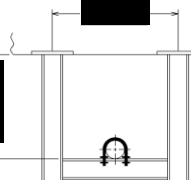
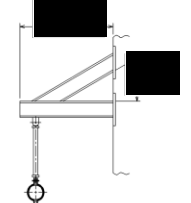
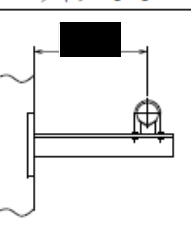
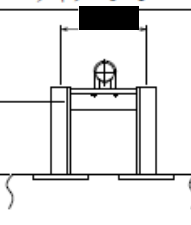
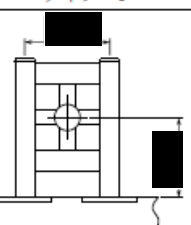
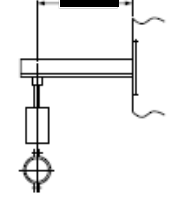
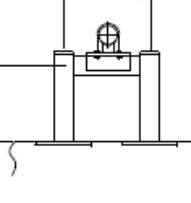
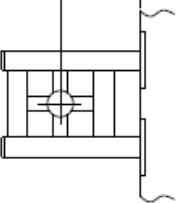
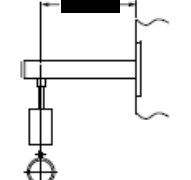
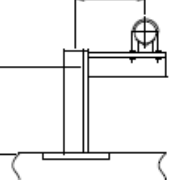
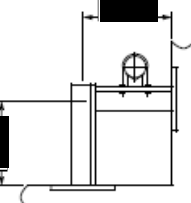
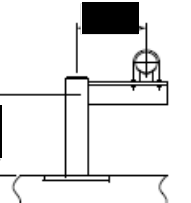
再処理施設	発電炉	備考																					
添付書類IV-1-1	添付書類IV-1-1-11-1	添付書類V-2-1-12-1																					
	<p>第3.2.1-1表 支持構造物の基本形状</p> <table border="1"> <tr> <td data-bbox="988 325 1344 583"> タイプ-1-1  </td> <td data-bbox="1344 325 1700 583"> タイプ-1-5  </td> </tr> <tr> <td data-bbox="988 583 1344 842"> タイプ-1-2  </td> <td data-bbox="1344 583 1700 842"> タイプ-2  </td> </tr> <tr> <td data-bbox="988 842 1344 1073"> タイプ-1-3  </td> <td data-bbox="1344 842 1700 1073"> タイプ-3  </td> </tr> <tr> <td data-bbox="988 1073 1344 1339"> タイプ-1-4  </td> <td data-bbox="1344 1073 1700 1339"></td> </tr> </table>	タイプ-1-1 	タイプ-1-5 	タイプ-1-2 	タイプ-2 	タイプ-1-3 	タイプ-3 	タイプ-1-4 		<p>表5-12 代表的な支持構造物</p> <table border="1"> <tr> <td data-bbox="1795 325 2021 583"> タイプ-1-1  </td> <td data-bbox="2021 325 2258 583"> タイプ-3-1  </td> <td data-bbox="2258 325 2493 583"> タイプ-5  </td> </tr> <tr> <td data-bbox="1795 583 2021 842"> タイプ-1-2  </td> <td data-bbox="2021 583 2258 842"> タイプ-3-2  </td> <td data-bbox="2258 583 2493 842"> タイプ-6  </td> </tr> <tr> <td data-bbox="1795 842 2021 1073"> タイプ-1-3  </td> <td data-bbox="2021 842 2258 1073"> タイプ-4-1  </td> <td data-bbox="2258 842 2493 1073"></td> </tr> <tr> <td data-bbox="1795 1073 2021 1339"> タイプ-2  </td> <td data-bbox="2021 1073 2258 1339"> タイプ-4-2  </td> <td data-bbox="2258 1073 2493 1339"></td> </tr> </table>	タイプ-1-1 	タイプ-3-1 	タイプ-5 	タイプ-1-2 	タイプ-3-2 	タイプ-6 	タイプ-1-3 	タイプ-4-1 		タイプ-2 	タイプ-4-2 		<p>再処理施設において用いている支持構造物の基本形状を記載しており、発電炉と形状が違う理由は設計メーカーが異なることによるものであるため、記載の差異により新たな論点が生じるものではない。</p>
タイプ-1-1 	タイプ-1-5 																						
タイプ-1-2 	タイプ-2 																						
タイプ-1-3 	タイプ-3 																						
タイプ-1-4 																							
タイプ-1-1 	タイプ-3-1 	タイプ-5 																					
タイプ-1-2 	タイプ-3-2 	タイプ-6 																					
タイプ-1-3 	タイプ-4-1 																						
タイプ-2 	タイプ-4-2 																						

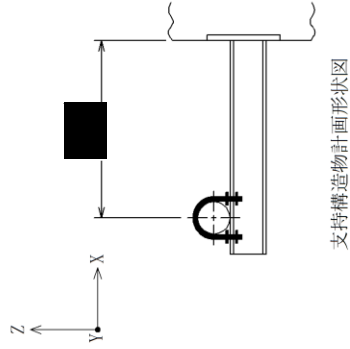
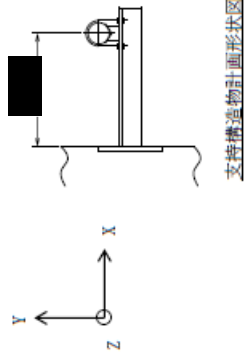
再処理施設	発電炉	備考																																																																			
添付書類IV-1-1	添付書類IV-1-1-11-1	添付書類V-2-1-12-1																																																																			
	<p>第3.2.1-2表(1/2) 支持構造物の強度及び耐震計算結果</p> <p>(1) 支持点荷重(N)</p> <table border="1"> <tr> <td>F_x</td> <td>F_y</td> <td>F_z</td> </tr> <tr> <td>4000</td> <td>-</td> <td>4000</td> </tr> </table> <p>(2) 支持架構</p> <p>① 最大発生応力及び許容応力</p> <table border="1"> <tr> <td rowspan="2">鋼材サイズ</td> <td colspan="2">組合せ応力(MPa)</td> </tr> <tr> <td>最大発生応力</td> <td>許容応力</td> </tr> <tr> <td></td> <td>59</td> <td>235</td> </tr> </table> <p>② 評価結果</p> <p>評価 以上より、選定した鋼材サイズの最大発生応力は、許容応力以下であり健全性を確認した。</p> <p>(3) 付属部品</p> <p>① 支持点荷重及び最大使用荷重</p> <table border="1"> <tr> <td rowspan="2">付属部品名称</td> <td rowspan="2">型式番号</td> <td colspan="2">支持点荷重(kN)</td> <td colspan="2">最大使用荷重(kN)</td> </tr> <tr> <td>引張荷重方向</td> <td>せん断荷重方向</td> <td>引張荷重方向</td> <td>せん断荷重方向</td> </tr> <tr> <td>Uボルト</td> <td>100A</td> <td>4</td> <td>4</td> <td>18</td> <td>18</td> </tr> </table> <p>② 評価結果</p> <p>評価 以上より、当該Uボルトに作用する支持点荷重は、最大使用荷重以下であり健全性を確認した。</p> 	F_x	F_y	F_z	4000	-	4000	鋼材サイズ	組合せ応力(MPa)		最大発生応力	許容応力		59	235	付属部品名称	型式番号	支持点荷重(kN)		最大使用荷重(kN)		引張荷重方向	せん断荷重方向	引張荷重方向	せん断荷重方向	Uボルト	100A	4	4	18	18	<p>表5-13-1 支持構造物の強度及び耐震計算結果(I/2)</p> <p>支持構造物評価(タイプ1-1)</p> <p>(1) 支持点荷重(N)</p> <table border="1"> <tr> <td>F_x</td> <td>F_y</td> <td>F_z</td> </tr> <tr> <td>5000</td> <td>5000</td> <td>-</td> </tr> </table> <p>(2) 支持架構</p> <p>① 最大発生応力及び許容応力</p> <table border="1"> <tr> <td rowspan="2">鋼材サイズ</td> <td colspan="2">最大発生応力 (MPa)</td> <td colspan="2">許容応力 (MPa)</td> </tr> <tr> <td>最大発生応力</td> <td>許容応力</td> <td>最大発生応力</td> <td>許容応力</td> </tr> <tr> <td></td> <td>107</td> <td>234</td> <td>107</td> <td>234</td> </tr> </table> <p>② 評価結果</p> <p>評価 以上より、選定した鋼材サイズの最大発生応力は、許容応力以下であり健全性を確認した。</p> <p>(3) 付属部品</p> <p>① 支持点荷重及び最大使用荷重</p> <table border="1"> <tr> <td rowspan="2">付属部品名称</td> <td rowspan="2">型式番号</td> <td colspan="2">支持点荷重(N)</td> <td colspan="2">最大使用荷重(N)</td> </tr> <tr> <td>引張荷重方向</td> <td>せん断荷重方向</td> <td>引張荷重方向</td> <td>せん断荷重方向</td> </tr> <tr> <td>Uボルト</td> <td>UN-100</td> <td>5000</td> <td>5000</td> <td>12000</td> <td>12000</td> </tr> </table> <p>② 評価結果</p> <p>評価 以上より、当該Uボルトに作用する支持点荷重は、最大使用荷重以下であり健全性を確認した。</p> 	F_x	F_y	F_z	5000	5000	-	鋼材サイズ	最大発生応力 (MPa)		許容応力 (MPa)		最大発生応力	許容応力	最大発生応力	許容応力		107	234	107	234	付属部品名称	型式番号	支持点荷重(N)		最大使用荷重(N)		引張荷重方向	せん断荷重方向	引張荷重方向	せん断荷重方向	Uボルト	UN-100	5000	5000	12000	12000	<p>・ 代表的な支持構造物の形状に差異があるが、結果の示し方に差異はないため、記載の差異により新たな論点が生じるものではない。</p>
F_x	F_y	F_z																																																																			
4000	-	4000																																																																			
鋼材サイズ	組合せ応力(MPa)																																																																				
	最大発生応力	許容応力																																																																			
	59	235																																																																			
付属部品名称	型式番号	支持点荷重(kN)		最大使用荷重(kN)																																																																	
		引張荷重方向	せん断荷重方向	引張荷重方向	せん断荷重方向																																																																
Uボルト	100A	4	4	18	18																																																																
F_x	F_y	F_z																																																																			
5000	5000	-																																																																			
鋼材サイズ	最大発生応力 (MPa)		許容応力 (MPa)																																																																		
	最大発生応力	許容応力	最大発生応力	許容応力																																																																	
	107	234	107	234																																																																	
付属部品名称	型式番号	支持点荷重(N)		最大使用荷重(N)																																																																	
		引張荷重方向	せん断荷重方向	引張荷重方向	せん断荷重方向																																																																
Uボルト	UN-100	5000	5000	12000	12000																																																																

再処理施設	発電炉	備考																															
添付書類IV-1-1	添付書類IV-1-1-11-1	添付書類V-2-1-12-1																															
	<p>第3.2.1-2表(2/2) 支持構造物の強度及び耐震計算結果</p> <p>① 発生荷重</p> <table border="1" data-bbox="1181 730 1320 1579"> <thead> <tr> <th colspan="2">軸方向荷重と曲げモーメントの組合せ</th> <th colspan="2">せん断方向荷重と回転モーメントの組合せ</th> </tr> <tr> <th>軸方向荷重 (kN)</th> <th>曲げモーメント (kN・m)</th> <th>せん断方向荷重 (kN)</th> <th>回転モーメント (kN・m)</th> </tr> </thead> <tbody> <tr> <td>4</td> <td>2.1</td> <td>5</td> <td>0.0</td> </tr> </tbody> </table> <p>② 最大使用荷重</p> <table border="1" data-bbox="1359 630 1498 1579"> <thead> <tr> <th rowspan="2">型式</th> <th colspan="3">最大使用荷重</th> </tr> <tr> <th>軸方向荷重 (kN)</th> <th>曲げモーメント (kN・m)</th> <th>せん断方向荷重 (kN)</th> </tr> </thead> <tbody> <tr> <td>B</td> <td>25</td> <td>2.5</td> <td>40</td> </tr> <tr> <td></td> <td></td> <td></td> <th>回転モーメント (kN・m)</th> </tr> <tr> <td></td> <td></td> <td></td> <td>4.0</td> </tr> </tbody> </table> <p>③ 評価結果</p> <p>以上より、当該埋込金物に作用する発生荷重は、選定した型式の最大使用荷重以下であり健全性を確認した。</p>	軸方向荷重と曲げモーメントの組合せ		せん断方向荷重と回転モーメントの組合せ		軸方向荷重 (kN)	曲げモーメント (kN・m)	せん断方向荷重 (kN)	回転モーメント (kN・m)	4	2.1	5	0.0	型式	最大使用荷重			軸方向荷重 (kN)	曲げモーメント (kN・m)	せん断方向荷重 (kN)	B	25	2.5	40				回転モーメント (kN・m)				4.0	<p>・ 代表的な支持構造物の形状に差異があるが、結果の示し方に差異はないため、記載の差異により新たな論点が生じるものではない。</p>
軸方向荷重と曲げモーメントの組合せ		せん断方向荷重と回転モーメントの組合せ																															
軸方向荷重 (kN)	曲げモーメント (kN・m)	せん断方向荷重 (kN)	回転モーメント (kN・m)																														
4	2.1	5	0.0																														
型式	最大使用荷重																																
	軸方向荷重 (kN)	曲げモーメント (kN・m)	せん断方向荷重 (kN)																														
B	25	2.5	40																														
			回転モーメント (kN・m)																														
			4.0																														
	<p>表5-13-1 支持構造物の強度及び耐震計算結果(2/2)</p> <p>① 発生荷重</p> <table border="1" data-bbox="1893 1171 1964 1558"> <thead> <tr> <th>引張り(N)</th> <th>せん断(N)</th> </tr> </thead> <tbody> <tr> <td>34500</td> <td>5000</td> </tr> </tbody> </table> <p>② 発生荷重及び最大使用荷重</p> <table border="1" data-bbox="2033 646 2136 1558"> <thead> <tr> <th rowspan="2">タイプ</th> <th colspan="2">発生荷重(N)</th> <th colspan="2">最大使用荷重(N)</th> </tr> <tr> <th>引張り</th> <th>せん断</th> <th>引張り</th> <th>せん断</th> </tr> </thead> <tbody> <tr> <td>I</td> <td>34500</td> <td>5000</td> <td>93600</td> <td>240700</td> </tr> </tbody> </table> <p>③ 評価結果</p> <p>以上より、当該埋込金物に作用する発生荷重は、選定したタイプの最大使用荷重以下であり健全性を確認した。</p>	引張り(N)	せん断(N)	34500	5000	タイプ	発生荷重(N)		最大使用荷重(N)		引張り	せん断	引張り	せん断	I	34500	5000	93600	240700														
引張り(N)	せん断(N)																																
34500	5000																																
タイプ	発生荷重(N)		最大使用荷重(N)																														
	引張り	せん断	引張り	せん断																													
I	34500	5000	93600	240700																													

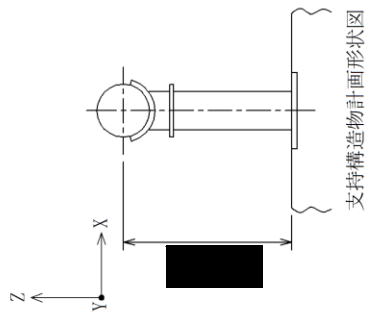
再処理施設	発電炉	備考																																					
添付書類IV-1-1	添付書類IV-1-1-11-1	添付書類V-2-1-12-1																																					
	<p>第3.2.1-3表(1/2) 支持構造物の強度及び耐震計算結果</p> <div style="display: flex; justify-content: space-around;"> <div style="text-align: center;"> <p>支持構造物評価(タイプ-1-2)</p> <p>(1) 支持点荷重</p> <table border="1"> <thead> <tr> <th>F_x (N)</th> <th>F_y (N)</th> <th>F_z (N)</th> <th>M_x (N・m)</th> <th>M_y (N・m)</th> <th>M_z (N・m)</th> </tr> </thead> <tbody> <tr> <td>1500</td> <td>1500</td> <td>1500</td> <td>1500</td> <td>1500</td> <td>1500</td> </tr> </tbody> </table> <p>(2) 付属部品</p> <p>① 最大使用荷重</p> <table border="1"> <thead> <tr> <th>付属部品名称</th> <th>型式</th> <th>最大使用荷重</th> </tr> </thead> <tbody> <tr> <td>ラグ</td> <td>S-4</td> <td>F_x, F_y, F_z (N) 2400 M_x, M_y, M_z (N・m) 2400</td> </tr> </tbody> </table> <p>② 評価結果</p> <p>評価 以上より、当該ラグに作用する支持点荷重は、最大使用荷重以下であり健全性を確認した。</p> </div> <div style="text-align: center;">  <p>支持構造物計画形状図</p> </div> </div>	F _x (N)	F _y (N)	F _z (N)	M _x (N・m)	M _y (N・m)	M _z (N・m)	1500	1500	1500	1500	1500	1500	付属部品名称	型式	最大使用荷重	ラグ	S-4	F _x , F _y , F _z (N) 2400 M _x , M _y , M _z (N・m) 2400	<p>表5-13-2 支持構造物の強度及び耐震計算結果(1/2)</p> <p>支持構造物評価(タイプ-1-2)</p> <p>(1) 支持点荷重(N)</p> <table border="1"> <thead> <tr> <th>F_x</th> <th>F_y</th> <th>F_z</th> </tr> </thead> <tbody> <tr> <td>-</td> <td>5000</td> <td>-</td> </tr> </tbody> </table> <p>(2) 支持装置</p> <table border="1"> <thead> <tr> <th>支持装置名称</th> <th>型式番号</th> <th>定格荷重 (kN)</th> </tr> </thead> <tbody> <tr> <td>オイルスナックバ</td> <td>06</td> <td>6</td> </tr> </tbody> </table> <p>評価 以上より、当該オイルスナックバに作用する支持点荷重は、定格荷重以下であり健全性を確認した。</p> <p>(3) 支持架構</p> <p>① 最大発生応力及び許容応力</p> <table border="1"> <thead> <tr> <th>鋼材サイズ</th> <th>最大発生応力 (MPa)</th> <th>許容応力 (MPa)</th> </tr> </thead> <tbody> <tr> <td>■</td> <td>104</td> <td>234</td> </tr> </tbody> </table> <p>② 評価結果</p> <p>評価 以上より、選定した鋼材サイズの最大発生応力は、許容応力以下であり健全性を確認した。</p>	F _x	F _y	F _z	-	5000	-	支持装置名称	型式番号	定格荷重 (kN)	オイルスナックバ	06	6	鋼材サイズ	最大発生応力 (MPa)	許容応力 (MPa)	■	104	234	<p>代表的な支持構造物の形状に差異があるが、結果の示し方に差異はないため、記載の差異により新たな論点が生じるものではない。</p>
F _x (N)	F _y (N)	F _z (N)	M _x (N・m)	M _y (N・m)	M _z (N・m)																																		
1500	1500	1500	1500	1500	1500																																		
付属部品名称	型式	最大使用荷重																																					
ラグ	S-4	F _x , F _y , F _z (N) 2400 M _x , M _y , M _z (N・m) 2400																																					
F _x	F _y	F _z																																					
-	5000	-																																					
支持装置名称	型式番号	定格荷重 (kN)																																					
オイルスナックバ	06	6																																					
鋼材サイズ	最大発生応力 (MPa)	許容応力 (MPa)																																					
■	104	234																																					

再処理施設	発電炉	備考																							
添付書類IV-1-1	添付書類IV-1-1-11-1	添付書類V-2-1-12-1																							
	<p>第3.2.1-3表(2/2) 支持構造物の強度及び耐震計算結果</p> <p>④ 埋込金物</p> <p>① 発生荷重</p> <table border="1" data-bbox="1181 724 1320 1564"> <thead> <tr> <th colspan="2">軸方向荷重と曲げモーメントの組合せ</th> <th colspan="2">せん断方向荷重と回転モーメントの組合せ</th> </tr> <tr> <th>軸方向荷重 (kN)</th> <th>曲げモーメント (kN・m)</th> <th>せん断方向荷重 (kN)</th> <th>回転モーメント (kN・m)</th> </tr> </thead> <tbody> <tr> <td>2</td> <td>4.8</td> <td>3</td> <td>1.5</td> </tr> </tbody> </table> <p>② 最大使用荷重</p> <table border="1" data-bbox="1359 625 1498 1564"> <thead> <tr> <th rowspan="2">型式</th> <th colspan="3">最大使用荷重</th> </tr> <tr> <th>軸方向荷重 (kN)</th> <th>曲げモーメント (kN・m)</th> <th>せん断方向荷重 (kN)</th> </tr> </thead> <tbody> <tr> <td>C</td> <td>50</td> <td>6.0</td> <td>35</td> </tr> </tbody> </table> <p>③ 評価結果</p> <p>評価 以上より、当該埋込金物に作用する発生荷重は、選定した型式の最大使用荷重以下であり健全性を確認した。</p>	軸方向荷重と曲げモーメントの組合せ		せん断方向荷重と回転モーメントの組合せ		軸方向荷重 (kN)	曲げモーメント (kN・m)	せん断方向荷重 (kN)	回転モーメント (kN・m)	2	4.8	3	1.5	型式	最大使用荷重			軸方向荷重 (kN)	曲げモーメント (kN・m)	せん断方向荷重 (kN)	C	50	6.0	35	<p>・ 代表的な支持構造物の形状に差異があるが、結果の示し方に差異はないため、記載の差異により新たな論点が生じるものではない。</p>
軸方向荷重と曲げモーメントの組合せ		せん断方向荷重と回転モーメントの組合せ																							
軸方向荷重 (kN)	曲げモーメント (kN・m)	せん断方向荷重 (kN)	回転モーメント (kN・m)																						
2	4.8	3	1.5																						
型式	最大使用荷重																								
	軸方向荷重 (kN)	曲げモーメント (kN・m)	せん断方向荷重 (kN)																						
C	50	6.0	35																						

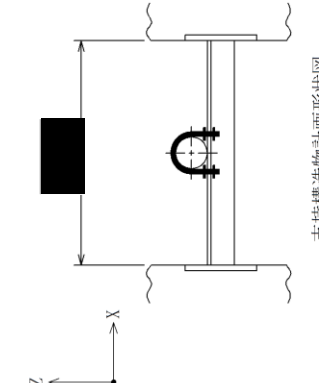
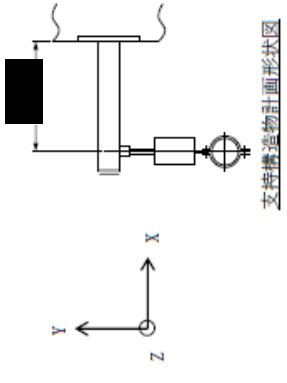
再処理施設	発電炉	備考																																									
<p>添付書類IV-1-1</p>	<p>添付書類IV-1-1-11-1</p> <p>第3.2.1-4表(1/2) 支持構造物の強度及び耐震計算結果</p> <p>(1) 支持構造物評価(タイプ1-3)</p> <table border="1"> <tr> <td>F_x</td> <td>F_y</td> <td>F_z</td> </tr> <tr> <td>4000</td> <td>-</td> <td>4000</td> </tr> </table> <p>(2) 支持架構</p> <p>① 最大発生応力及び許容応力</p> <table border="1"> <tr> <td rowspan="2">鋼材サイズ</td> <td>最大発生応力</td> <td>許容応力</td> </tr> <tr> <td>146</td> <td>235</td> </tr> </table> <p>② 評価結果</p> <p>評価 以上より、選定した鋼材サイズの最大発生応力は、許容応力以下であり健全性を確認した。</p> <p>(3) 付属部品</p> <p>① 支持点荷重及び最大使用荷重</p> <table border="1"> <tr> <td rowspan="2">付属部品名称</td> <td rowspan="2">型式番号</td> <td colspan="2">支持点荷重(kN)</td> <td rowspan="2">最大使用荷重(kN)</td> </tr> <tr> <td>引張荷重方向</td> <td>せん断荷重方向</td> </tr> <tr> <td>Uボルト</td> <td>100A</td> <td>4</td> <td>4</td> <td>18</td> </tr> </table> <p>② 評価結果</p> <p>評価 以上より、当該Uボルトに作用する支持点荷重は、最大使用荷重以下であり健全性を確認した。</p>  <p>支持構造物計画形状図</p>	F_x	F_y	F_z	4000	-	4000	鋼材サイズ	最大発生応力	許容応力	146	235	付属部品名称	型式番号	支持点荷重(kN)		最大使用荷重(kN)	引張荷重方向	せん断荷重方向	Uボルト	100A	4	4	18	<p>添付書類V-2-1-12-1</p> <p>表5-13-3 支持構造物の強度及び耐震計算結果(1/2)</p> <p>支持構造物評価(タイプ1-3)</p> <p>(1) 支持点荷重(N)</p> <table border="1"> <tr> <td>F_x</td> <td>F_y</td> <td>F_z</td> </tr> <tr> <td>-</td> <td>10000</td> <td>-</td> </tr> </table> <p>(2) 支持装置</p> <table border="1"> <tr> <td>支持装置名称</td> <td>型式番号</td> <td>定格荷重(kN)</td> </tr> <tr> <td>メカニカルスナック</td> <td>1</td> <td>10</td> </tr> </table> <p>評価 以上より、当該メカニカルスナックに作用する支持点荷重は、定格荷重以下であり健全性を確認した。</p> <p>(3) 支持架構</p> <p>① 最大発生応力及び許容応力</p> <table border="1"> <tr> <td>鋼材サイズ</td> <td>最大発生応力(MPa)</td> <td>許容応力(MPa)</td> </tr> <tr> <td></td> <td>84</td> <td>216</td> </tr> </table> <p>② 評価結果</p> <p>評価 以上より、選定した鋼材サイズの最大発生応力は、許容応力以下であり健全性を確認した。</p>  <p>支持構造物計画形状図</p> <p>・ 代表的な支持構造物の形状に差異があるが、結果の示し方に差異はないため、記載の差異により新たな論点が生じるものではない。</p>	F_x	F_y	F_z	-	10000	-	支持装置名称	型式番号	定格荷重(kN)	メカニカルスナック	1	10	鋼材サイズ	最大発生応力(MPa)	許容応力(MPa)		84	216
F_x	F_y	F_z																																									
4000	-	4000																																									
鋼材サイズ	最大発生応力	許容応力																																									
	146	235																																									
付属部品名称	型式番号	支持点荷重(kN)		最大使用荷重(kN)																																							
		引張荷重方向	せん断荷重方向																																								
Uボルト	100A	4	4	18																																							
F_x	F_y	F_z																																									
-	10000	-																																									
支持装置名称	型式番号	定格荷重(kN)																																									
メカニカルスナック	1	10																																									
鋼材サイズ	最大発生応力(MPa)	許容応力(MPa)																																									
	84	216																																									

再処理施設	発電炉	備考																																											
添付書類IV-1-1	添付書類IV-1-1-11-1	添付書類V-2-1-12-1																																											
	<p>第3.2.1-4表(2/2) 支持構造物の強度及び耐震計算結果</p> <p>(4) 埋込金物</p> <p>① 発生荷重</p> <table border="1" data-bbox="1181 714 1320 1533"> <thead> <tr> <th colspan="2">軸方向荷重と曲げモーメントの組合せ</th> <th colspan="2">せん断方向荷重と回転モーメントの組合せ</th> </tr> <tr> <th>軸方向荷重 (kN)</th> <th>曲げモーメント (kN・m)</th> <th>せん断方向荷重 (kN)</th> <th>回転モーメント (kN・m)</th> </tr> </thead> <tbody> <tr> <td>2</td> <td>0.6</td> <td>3</td> <td>0.0</td> </tr> </tbody> </table> <p>② 最大使用荷重</p> <table border="1" data-bbox="1350 619 1498 1533"> <thead> <tr> <th rowspan="2">型式</th> <th colspan="3">最大使用荷重</th> </tr> <tr> <th>軸方向荷重 (kN)</th> <th>曲げモーメント (kN・m)</th> <th>せん断方向荷重 (kN)</th> <th>回転モーメント (kN・m)</th> </tr> </thead> <tbody> <tr> <td>B</td> <td>25</td> <td>2.5</td> <td>40</td> <td>4.0</td> </tr> </tbody> </table> <p>③ 評価結果</p> <p>評価 以上より、当該埋込金物に作用する発生荷重は、選定した型式の最大使用荷重以下であり健全性を確認した。</p>	軸方向荷重と曲げモーメントの組合せ		せん断方向荷重と回転モーメントの組合せ		軸方向荷重 (kN)	曲げモーメント (kN・m)	せん断方向荷重 (kN)	回転モーメント (kN・m)	2	0.6	3	0.0	型式	最大使用荷重			軸方向荷重 (kN)	曲げモーメント (kN・m)	せん断方向荷重 (kN)	回転モーメント (kN・m)	B	25	2.5	40	4.0	<p>表5-13-3 支持構造物の強度及び耐震計算結果(2/2)</p> <p>(4) 埋込金物</p> <p>① 発生荷重</p> <table border="1" data-bbox="1884 1134 1958 1512"> <thead> <tr> <th>引張り(N)</th> <th>せん断(N)</th> </tr> </thead> <tbody> <tr> <td>59000</td> <td>10000</td> </tr> </tbody> </table> <p>② 発生荷重及び最大使用荷重</p> <table border="1" data-bbox="2018 630 2136 1512"> <thead> <tr> <th rowspan="2">タイプ</th> <th colspan="2">発生荷重(N)</th> <th colspan="2">最大使用荷重(N)</th> </tr> <tr> <th>引張り</th> <th>せん断</th> <th>引張り</th> <th>せん断</th> </tr> </thead> <tbody> <tr> <td>I</td> <td>59000</td> <td>10000</td> <td>93600</td> <td>240700</td> </tr> </tbody> </table> <p>③ 評価結果</p> <p>評価 以上より、当該埋込金物に作用する発生荷重は、選定したタイプの最大使用荷重以下であり健全性を確認した。</p> <p>・ 代表的な支持構造物の形状に差異があるが、結果の示し方に差異はないため、記載の差異により新たな論点が生じるものではない。</p>	引張り(N)	せん断(N)	59000	10000	タイプ	発生荷重(N)		最大使用荷重(N)		引張り	せん断	引張り	せん断	I	59000	10000	93600	240700
軸方向荷重と曲げモーメントの組合せ		せん断方向荷重と回転モーメントの組合せ																																											
軸方向荷重 (kN)	曲げモーメント (kN・m)	せん断方向荷重 (kN)	回転モーメント (kN・m)																																										
2	0.6	3	0.0																																										
型式	最大使用荷重																																												
	軸方向荷重 (kN)	曲げモーメント (kN・m)	せん断方向荷重 (kN)	回転モーメント (kN・m)																																									
B	25	2.5	40	4.0																																									
引張り(N)	せん断(N)																																												
59000	10000																																												
タイプ	発生荷重(N)		最大使用荷重(N)																																										
	引張り	せん断	引張り	せん断																																									
I	59000	10000	93600	240700																																									

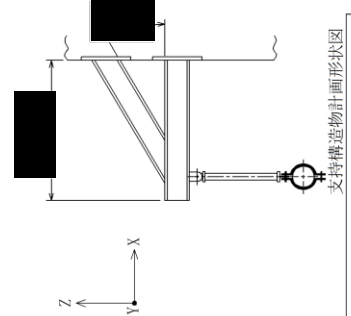
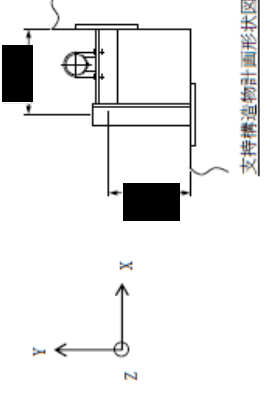
再処理施設	発電炉	備考																																															
<p>添付書類IV-1-1</p>	<p>添付書類IV-1-1-11-1</p> <p>第3.2.1-5表(1/2) 支持構造物の強度及び耐震計算結果</p>  <p>支持構造物計画形状図</p> <p>支持構造物評価(タイプ1-4)</p> <table border="1" data-bbox="1113 882 1202 1291"> <tr> <td>F_x</td> <td>F_y</td> <td>F_z</td> </tr> <tr> <td>-</td> <td>-</td> <td>4000</td> </tr> </table> <p>(1) 支持点荷重(N)</p> <table border="1" data-bbox="1231 756 1335 1291"> <tr> <td>支持装置名称</td> <td>型式番号</td> <td>定格荷重(kN)</td> </tr> <tr> <td>ロッドストレイント</td> <td>06</td> <td>6.0</td> </tr> </table> <p>(2) 支持装置</p> <p>評価 以上より、当該ロッドストレイントに作用する支持点荷重は、定格荷重以下であり健全性を確認した。</p> <p>(3) 支持架構</p> <p>① 最大発生応力及び許容応力</p> <table border="1" data-bbox="1469 808 1573 1291"> <tr> <td rowspan="2">鋼材サイズ</td> <td>組合せ応力(MPa)</td> <td rowspan="2">許容応力</td> </tr> <tr> <td>最大発生応力</td> <td>235</td> </tr> <tr> <td></td> <td>36</td> <td></td> </tr> </table> <p>② 評価結果</p> <p>以上より、選定した鋼材サイズの最大発生応力は、許容応力以下であり健全性を確認した。</p>	F _x	F _y	F _z	-	-	4000	支持装置名称	型式番号	定格荷重(kN)	ロッドストレイント	06	6.0	鋼材サイズ	組合せ応力(MPa)	許容応力	最大発生応力	235		36		<p>添付書類V-2-1-12-1</p> <p>表5-13-4 支持構造物の強度及び耐震計算結果(1/2)</p>  <p>支持構造物計画形状図</p> <p>支持構造物評価(タイプ2)</p> <table border="1" data-bbox="1855 913 1944 1291"> <tr> <td>F_x</td> <td>F_y</td> <td>F_z</td> </tr> <tr> <td>10000</td> <td>10000</td> <td>-</td> </tr> </table> <p>(1) 支持点荷重(N)</p> <p>(2) 支持架構</p> <p>① 最大発生応力及び許容応力</p> <table border="1" data-bbox="2003 819 2122 1291"> <tr> <td>鋼材サイズ</td> <td>最大発生応力(MPa)</td> <td>許容応力(MPa)</td> </tr> <tr> <td></td> <td>148</td> <td>234</td> </tr> </table> <p>② 評価結果</p> <p>以上より、選定した鋼材サイズの最大発生応力は、許容応力以下であり健全性を確認した。</p> <p>(3) 付属部品</p> <p>① 支持点荷重及び最大使用荷重</p> <table border="1" data-bbox="2270 388 2374 1239"> <tr> <td rowspan="2">付属部品名称</td> <td rowspan="2">型式番号</td> <td colspan="2">支持点荷重(N)</td> </tr> <tr> <td>引張荷重方向</td> <td>せん断荷重方向</td> </tr> <tr> <td>Uボルト</td> <td>UN-100</td> <td>10000</td> <td>12000</td> </tr> <tr> <td></td> <td></td> <td>10000</td> <td>12000</td> </tr> </table> <p>② 評価結果</p> <p>以上より、当該Uボルトに作用する支持点荷重は、最大使用荷重以下であり健全性を確認した。</p>	F _x	F _y	F _z	10000	10000	-	鋼材サイズ	最大発生応力(MPa)	許容応力(MPa)		148	234	付属部品名称	型式番号	支持点荷重(N)		引張荷重方向	せん断荷重方向	Uボルト	UN-100	10000	12000			10000	12000	<p>備考</p> <ul style="list-style-type: none"> 代表的な支持構造物の形状に差異があるが、結果の示し方に差異はないため、記載の差異により新たな論点が生じるものではない。
F _x	F _y	F _z																																															
-	-	4000																																															
支持装置名称	型式番号	定格荷重(kN)																																															
ロッドストレイント	06	6.0																																															
鋼材サイズ	組合せ応力(MPa)	許容応力																																															
	最大発生応力		235																																														
	36																																																
F _x	F _y	F _z																																															
10000	10000	-																																															
鋼材サイズ	最大発生応力(MPa)	許容応力(MPa)																																															
	148	234																																															
付属部品名称	型式番号	支持点荷重(N)																																															
		引張荷重方向	せん断荷重方向																																														
Uボルト	UN-100	10000	12000																																														
		10000	12000																																														

再処理施設		発電炉		備考																																																
添付書類IV-1-1	添付書類IV-1-1-11-1	添付書類V-2-1-12-1																																																		
	<p>第3.2.1-5表(2/2) 支持構造物の強度及び耐震計算結果</p> <p>(4) 埋込金物</p> <p>① 発生荷重</p> <table border="1"> <thead> <tr> <th colspan="2">軸方向荷重と曲げモーメントの組合せ</th> <th colspan="2">せん断方向荷重と回転モーメントの組合せ</th> </tr> <tr> <th>軸方向荷重 (kN)</th> <th>曲げモーメント (kN・m)</th> <th>せん断方向荷重 (kN)</th> <th>回転モーメント (kN・m)</th> </tr> </thead> <tbody> <tr> <td>7</td> <td>0.1</td> <td>4</td> <td>0.0</td> </tr> </tbody> </table> <p>② 最大使用荷重</p> <table border="1"> <thead> <tr> <th rowspan="2">型式</th> <th colspan="3">最大使用荷重</th> </tr> <tr> <th>軸方向荷重 (kN)</th> <th>曲げモーメント (kN・m)</th> <th>せん断方向荷重 (kN)</th> </tr> </thead> <tbody> <tr> <td>B</td> <td>25</td> <td>2.5</td> <td>40</td> </tr> <tr> <td></td> <td></td> <td></td> <th>回転モーメント (kN・m)</th> </tr> <tr> <td></td> <td></td> <td></td> <td>4.0</td> </tr> </tbody> </table> <p>③ 評価結果</p> <p>評価 以上より、当該埋込金物に作用する発生荷重は、選定した型式の最大使用荷重以下であり健全性を確認した。</p>	軸方向荷重と曲げモーメントの組合せ		せん断方向荷重と回転モーメントの組合せ		軸方向荷重 (kN)	曲げモーメント (kN・m)	せん断方向荷重 (kN)	回転モーメント (kN・m)	7	0.1	4	0.0	型式	最大使用荷重			軸方向荷重 (kN)	曲げモーメント (kN・m)	せん断方向荷重 (kN)	B	25	2.5	40				回転モーメント (kN・m)				4.0	<p>表5-13-4 支持構造物の強度及び耐震計算結果(2/2)</p> <p>(4) 埋込金物</p> <p>① 発生荷重</p> <table border="1"> <thead> <tr> <th>引張り(N)</th> <th>せん断(N)</th> </tr> </thead> <tbody> <tr> <td>22804</td> <td>6100</td> </tr> </tbody> </table> <p>② 発生荷重及び最大使用荷重</p> <table border="1"> <thead> <tr> <th rowspan="2">タイプ</th> <th colspan="2">発生荷重(N)</th> <th colspan="2">最大使用荷重(N)</th> </tr> <tr> <th>引張り</th> <th>せん断</th> <th>引張り</th> <th>せん断</th> </tr> </thead> <tbody> <tr> <td>I</td> <td>22804</td> <td>6100</td> <td>93600</td> <td>240700</td> </tr> </tbody> </table> <p>③ 評価結果</p> <p>評価 以上より、当該埋込金物に作用する発生荷重は、選定したタイプの最大使用荷重以下であり健全性を確認した。</p>	引張り(N)	せん断(N)	22804	6100	タイプ	発生荷重(N)		最大使用荷重(N)		引張り	せん断	引張り	せん断	I	22804	6100	93600	240700	<p>・ 代表的な支持構造物の形状に差異があるが、結果の示し方に差異はないため、記載の差異により新たな論点が生じるものではない。</p>
軸方向荷重と曲げモーメントの組合せ		せん断方向荷重と回転モーメントの組合せ																																																		
軸方向荷重 (kN)	曲げモーメント (kN・m)	せん断方向荷重 (kN)	回転モーメント (kN・m)																																																	
7	0.1	4	0.0																																																	
型式	最大使用荷重																																																			
	軸方向荷重 (kN)	曲げモーメント (kN・m)	せん断方向荷重 (kN)																																																	
B	25	2.5	40																																																	
			回転モーメント (kN・m)																																																	
			4.0																																																	
引張り(N)	せん断(N)																																																			
22804	6100																																																			
タイプ	発生荷重(N)		最大使用荷重(N)																																																	
	引張り	せん断	引張り	せん断																																																
I	22804	6100	93600	240700																																																

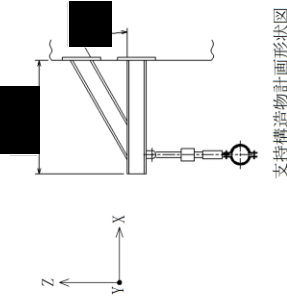
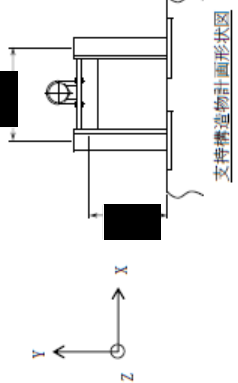
再処理施設	発電炉	備考																																																	
添付書類IV-1-1	添付書類IV-1-1-11-1	添付書類V-2-1-12-1																																																	
	<p>第3.2.1-6表(1/2) 支持構造物の強度及び耐震計算結果</p>  <p>支持構造物計画形状図</p> <p>支持構造物評価(タイプ-1-5)</p> <table border="1" data-bbox="1113 892 1187 1312"> <tr> <td>F_x</td> <td>F_y</td> <td>F_z</td> </tr> <tr> <td>-</td> <td>-</td> <td>4000</td> </tr> </table> <p>(1) 支持点荷重(N)</p> <table border="1" data-bbox="1231 766 1335 1312"> <tr> <th>支持装置名称</th> <th>型式番号</th> <th>定格荷重(kN)</th> </tr> <tr> <td>メカニカルスナバ</td> <td>06</td> <td>6.0</td> </tr> </table> <p>(2) 支持装置</p> <p>評価 以上より、当該メカニカルスナバに作用する支持点荷重は、定格荷重以下であり健全性を確認した。</p> <p>(3) 支持架構</p> <p>① 最大発生応力及び許容応力</p> <table border="1" data-bbox="1469 808 1573 1312"> <tr> <th rowspan="2">鋼材サイズ</th> <th colspan="2">組合せ応力(MPa)</th> </tr> <tr> <th>最大発生応力</th> <th>許容応力</th> </tr> <tr> <td>■</td> <td>36</td> <td>235</td> </tr> </table> <p>② 評価結果</p> <p>以上より、選定した鋼材サイズの最大発生応力は、許容応力以下であり健全性を確認した。</p>	F _x	F _y	F _z	-	-	4000	支持装置名称	型式番号	定格荷重(kN)	メカニカルスナバ	06	6.0	鋼材サイズ	組合せ応力(MPa)		最大発生応力	許容応力	■	36	235	<p>表5-13-5 支持構造物の強度及び耐震計算結果(1/2)</p>  <p>支持構造物計画形状図</p> <p>支持構造物評価(タイプ-3-1)</p> <table border="1" data-bbox="1855 913 1929 1228"> <tr> <td>F_x</td> <td>F_y</td> <td>F_z</td> </tr> <tr> <td>10000</td> <td>10000</td> <td>-</td> </tr> </table> <p>(1) 支持点荷重(N)</p> <p>(2) 支持架構</p> <p>① 最大発生応力及び許容応力</p> <table border="1" data-bbox="2003 829 2107 1228"> <tr> <th>鋼材サイズ</th> <th>最大発生応力(MPa)</th> <th>許容応力(MPa)</th> </tr> <tr> <td>■</td> <td>141</td> <td>234</td> </tr> </table> <p>② 評価結果</p> <p>以上より、選定した鋼材サイズの最大発生応力は、許容応力以下であり健全性を確認した。</p> <p>(3) 付属部品</p> <p>① 支持点荷重及び最大使用荷重</p> <table border="1" data-bbox="2255 409 2359 1228"> <tr> <th rowspan="2">付属部品名称</th> <th rowspan="2">型式番号</th> <th colspan="2">支持点荷重(N)</th> <th colspan="2">最大使用荷重(N)</th> </tr> <tr> <th>せん断荷重方向</th> <th>引張荷重方向</th> <th>せん断荷重方向</th> <th>引張荷重方向</th> </tr> <tr> <td>Uボルト</td> <td>UN-100</td> <td>10000</td> <td>10000</td> <td>12000</td> <td>12000</td> </tr> </table> <p>② 評価結果</p> <p>以上より、当該Uボルトに作用する支持点荷重は、最大使用荷重以下であり健全性を確認した。</p>	F _x	F _y	F _z	10000	10000	-	鋼材サイズ	最大発生応力(MPa)	許容応力(MPa)	■	141	234	付属部品名称	型式番号	支持点荷重(N)		最大使用荷重(N)		せん断荷重方向	引張荷重方向	せん断荷重方向	引張荷重方向	Uボルト	UN-100	10000	10000	12000	12000	<p>・ 代表的な支持構造物の形状に差異があるが、結果の示し方に差異はないため、記載の差異により新たな論点が生じるものではない。</p>
F _x	F _y	F _z																																																	
-	-	4000																																																	
支持装置名称	型式番号	定格荷重(kN)																																																	
メカニカルスナバ	06	6.0																																																	
鋼材サイズ	組合せ応力(MPa)																																																		
	最大発生応力	許容応力																																																	
■	36	235																																																	
F _x	F _y	F _z																																																	
10000	10000	-																																																	
鋼材サイズ	最大発生応力(MPa)	許容応力(MPa)																																																	
■	141	234																																																	
付属部品名称	型式番号	支持点荷重(N)		最大使用荷重(N)																																															
		せん断荷重方向	引張荷重方向	せん断荷重方向	引張荷重方向																																														
Uボルト	UN-100	10000	10000	12000	12000																																														

再処理施設	発電炉	備考																																																						
添付書類IV-1-1	添付書類IV-1-1-11-1	添付書類V-2-1-12-1																																																						
	<p>第3.2.1-6表(2/2) 支持構造物の強度及び耐震計算結果</p> <p>(4) 埋込金物</p> <p>① 発生荷重</p> <table border="1" data-bbox="1172 756 1320 1680"> <thead> <tr> <th colspan="2">軸方向荷重と曲げモーメントの組合せ</th> <th colspan="2">せん断方向荷重と回転モーメントの組合せ</th> </tr> <tr> <th>軸方向荷重 (kN)</th> <th>曲げモーメント (kN・m)</th> <th>せん断方向荷重 (kN)</th> <th>回転モーメント (kN・m)</th> </tr> </thead> <tbody> <tr> <td>7</td> <td>0.1</td> <td>4</td> <td>0.0</td> </tr> </tbody> </table> <p>② 最大使用荷重</p> <table border="1" data-bbox="1350 651 1513 1680"> <thead> <tr> <th rowspan="2">型式</th> <th colspan="3">最大使用荷重</th> </tr> <tr> <th>軸方向荷重 (kN)</th> <th>曲げモーメント (kN・m)</th> <th>せん断方向荷重 (kN)</th> </tr> </thead> <tbody> <tr> <td>B</td> <td>25</td> <td>2.5</td> <td>40</td> </tr> <tr> <td></td> <td></td> <td></td> <th>回転モーメント (kN・m)</th> </tr> <tr> <td></td> <td></td> <td></td> <td>4.0</td> </tr> </tbody> </table> <p>③ 評価結果</p> <table border="1" data-bbox="1543 367 1587 1680"> <tr> <td>評価</td> <td>以上より、当該埋込金物に作用する発生荷重は、選定した型式の最大使用荷重以下であり健全性を確認した。</td> </tr> </table>	軸方向荷重と曲げモーメントの組合せ		せん断方向荷重と回転モーメントの組合せ		軸方向荷重 (kN)	曲げモーメント (kN・m)	せん断方向荷重 (kN)	回転モーメント (kN・m)	7	0.1	4	0.0	型式	最大使用荷重			軸方向荷重 (kN)	曲げモーメント (kN・m)	せん断方向荷重 (kN)	B	25	2.5	40				回転モーメント (kN・m)				4.0	評価	以上より、当該埋込金物に作用する発生荷重は、選定した型式の最大使用荷重以下であり健全性を確認した。	<p>表5-13-5 支持構造物の強度及び耐震計算結果(2/2)</p> <p>(4) 埋込金物</p> <p>① 発生荷重</p> <table border="1" data-bbox="1899 1207 1973 1627"> <thead> <tr> <th>引張り(N)</th> <th>せん断(N)</th> </tr> </thead> <tbody> <tr> <td>47848</td> <td>6212</td> </tr> </tbody> </table> <p>② 発生荷重及び最大使用荷重</p> <table border="1" data-bbox="2047 651 2151 1627"> <thead> <tr> <th rowspan="2">タイプ</th> <th colspan="2">発生荷重(N)</th> <th colspan="2">最大使用荷重(N)</th> </tr> <tr> <th>引張り</th> <th>せん断</th> <th>引張り</th> <th>せん断</th> </tr> </thead> <tbody> <tr> <td>I</td> <td>47848</td> <td>6212</td> <td>93600</td> <td>240700</td> </tr> </tbody> </table> <p>③ 評価結果</p> <table border="1" data-bbox="2226 304 2270 1627"> <tr> <td>評価</td> <td>以上より、当該埋込金物に作用する発生荷重は、選定したタイプの最大使用荷重以下であり健全性を確認した。</td> </tr> </table>	引張り(N)	せん断(N)	47848	6212	タイプ	発生荷重(N)		最大使用荷重(N)		引張り	せん断	引張り	せん断	I	47848	6212	93600	240700	評価	以上より、当該埋込金物に作用する発生荷重は、選定したタイプの最大使用荷重以下であり健全性を確認した。	<p>・ 代表的な支持構造物の形状に差異があるが、結果の示し方に差異はないため、記載の差異により新たな論点が生じるものではない。</p>
軸方向荷重と曲げモーメントの組合せ		せん断方向荷重と回転モーメントの組合せ																																																						
軸方向荷重 (kN)	曲げモーメント (kN・m)	せん断方向荷重 (kN)	回転モーメント (kN・m)																																																					
7	0.1	4	0.0																																																					
型式	最大使用荷重																																																							
	軸方向荷重 (kN)	曲げモーメント (kN・m)	せん断方向荷重 (kN)																																																					
B	25	2.5	40																																																					
			回転モーメント (kN・m)																																																					
			4.0																																																					
評価	以上より、当該埋込金物に作用する発生荷重は、選定した型式の最大使用荷重以下であり健全性を確認した。																																																							
引張り(N)	せん断(N)																																																							
47848	6212																																																							
タイプ	発生荷重(N)		最大使用荷重(N)																																																					
	引張り	せん断	引張り	せん断																																																				
I	47848	6212	93600	240700																																																				
評価	以上より、当該埋込金物に作用する発生荷重は、選定したタイプの最大使用荷重以下であり健全性を確認した。																																																							

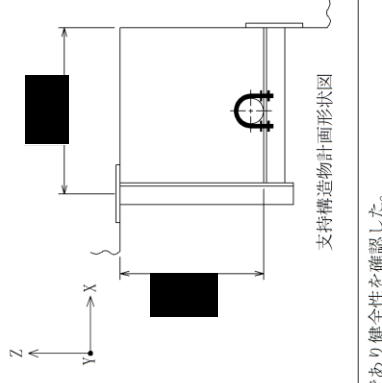
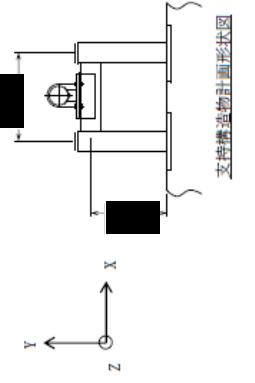
再処理施設	添付書類IV-1-1-11-1	発電炉	備考																																																			
添付書類IV-1-1	<p>第3.2.1-7表(1/2) 支持構造物の強度及び耐震計算結果</p> <p>支持構造物評価(タイプ-2)</p> <p>(1) 支持点荷重(N)</p> <table border="1"> <tr> <td>F_x</td> <td>F_y</td> <td>F_z</td> </tr> <tr> <td>4000</td> <td>-</td> <td>4000</td> </tr> </table> <p>(2) 支持架構</p> <p>① 最大発生応力及び許容応力</p> <table border="1"> <tr> <td rowspan="2">鋼材サイズ</td> <td colspan="2">組合せ応力(MPa)</td> </tr> <tr> <td>最大発生応力</td> <td>許容応力</td> </tr> <tr> <td></td> <td>108</td> <td>235</td> </tr> </table> <p>② 評価結果</p> <p>評価 以上より、選定した鋼材サイズの最大発生応力は、許容応力以下であり健全性を確認した。</p> <p>(3) 付属部品</p> <p>① 支持点荷重及び最大使用荷重</p> <table border="1"> <tr> <td rowspan="2">付属部品名称</td> <td rowspan="2">型式番号</td> <td colspan="2">支持点荷重(kN)</td> <td rowspan="2">最大使用荷重(kN)</td> </tr> <tr> <td>引張荷重方向</td> <td>せん断荷重方向</td> </tr> <tr> <td>Uボルト</td> <td>100A</td> <td>4</td> <td>4</td> <td>18</td> </tr> </table> <p>② 評価結果</p> <p>評価 以上より、当該Uボルトに作用する支持点荷重は、最大使用荷重以下であり健全性を確認した。</p> 	F_x	F_y	F_z	4000	-	4000	鋼材サイズ	組合せ応力(MPa)		最大発生応力	許容応力		108	235	付属部品名称	型式番号	支持点荷重(kN)		最大使用荷重(kN)	引張荷重方向	せん断荷重方向	Uボルト	100A	4	4	18	<p>添付書類V-2-1-12-1</p> <p>表5-13-6 支持構造物の強度及び耐震計算結果(1/2)</p> <p>支持構造物評価(タイプ-3-2)</p> <p>(1) 支持点荷重(N)</p> <table border="1"> <tr> <td>F_x</td> <td>F_y</td> <td>F_z</td> </tr> <tr> <td>30000</td> <td>30000</td> <td>-</td> </tr> </table> <p>(2) 支持架構</p> <p>① 最大発生応力及び許容応力</p> <table border="1"> <tr> <td rowspan="2">鋼材サイズ</td> <td rowspan="2">最大発生応力(MPa)</td> <td rowspan="2">許容応力(MPa)</td> </tr> <tr> <td></td> </tr> <tr> <td></td> <td>123</td> <td>216</td> </tr> </table> <p>② 評価結果</p> <p>評価 以上より、選定した鋼材サイズの最大発生応力は、許容応力以下であり健全性を確認した。</p>  <p>(3) 付属部品</p> <p>① 支持点荷重及び最大使用荷重</p> <table border="1"> <tr> <td rowspan="2">付属部品名称</td> <td rowspan="2">型式番号</td> <td colspan="2">支持点荷重(N)</td> <td rowspan="2">最大使用荷重(N)</td> </tr> <tr> <td>引張荷重方向</td> <td>せん断荷重方向</td> </tr> <tr> <td>Uボルト</td> <td>UN-200</td> <td>30000</td> <td>30000</td> <td>32000</td> </tr> </table> <p>② 評価結果</p> <p>評価 以上より、当該Uボルトに作用する支持点荷重は、最大使用荷重以下であり健全性を確認した。</p>	F_x	F_y	F_z	30000	30000	-	鋼材サイズ	最大発生応力(MPa)	許容応力(MPa)			123	216	付属部品名称	型式番号	支持点荷重(N)		最大使用荷重(N)	引張荷重方向	せん断荷重方向	Uボルト	UN-200	30000	30000	32000	<p>備考</p> <ul style="list-style-type: none"> 代表的な支持構造物の形状に差異があるが、結果の示し方に差異はないため、記載の差異により新たな論点が生じるものではない。
F_x	F_y	F_z																																																				
4000	-	4000																																																				
鋼材サイズ	組合せ応力(MPa)																																																					
	最大発生応力	許容応力																																																				
	108	235																																																				
付属部品名称	型式番号	支持点荷重(kN)		最大使用荷重(kN)																																																		
		引張荷重方向	せん断荷重方向																																																			
Uボルト	100A	4	4	18																																																		
F_x	F_y	F_z																																																				
30000	30000	-																																																				
鋼材サイズ	最大発生応力(MPa)	許容応力(MPa)																																																				
	123	216																																																				
付属部品名称	型式番号	支持点荷重(N)		最大使用荷重(N)																																																		
		引張荷重方向	せん断荷重方向																																																			
Uボルト	UN-200	30000	30000	32000																																																		

再処理施設	発電炉	備考																															
添付書類IV-1-1	添付書類IV-1-1-11-1	添付書類V-2-1-12-1																															
	<p>第3.2.1-7表(2/2) 支持構造物の強度及び耐震計算結果</p> <p>(4) 埋込金物</p> <p>① 発生荷重</p> <table border="1" data-bbox="1181 751 1329 1661"> <thead> <tr> <th colspan="2">軸方向荷重と曲げモーメントの組合せ</th> <th colspan="2">せん断方向荷重と回転モーメントの組合せ</th> </tr> <tr> <th>軸方向荷重 (kN)</th> <th>曲げモーメント (kN・m)</th> <th>せん断方向荷重 (kN)</th> <th>回転モーメント (kN・m)</th> </tr> </thead> <tbody> <tr> <td>5</td> <td>0.7</td> <td>3</td> <td>0.0</td> </tr> </tbody> </table> <p>② 最大使用荷重</p> <table border="1" data-bbox="1368 646 1522 1661"> <thead> <tr> <th rowspan="2">型式</th> <th colspan="3">最大使用荷重</th> </tr> <tr> <th>軸方向荷重 (kN)</th> <th>曲げモーメント (kN・m)</th> <th>せん断方向荷重 (kN)</th> </tr> </thead> <tbody> <tr> <td>B</td> <td>25</td> <td>2.5</td> <td>40</td> </tr> <tr> <td></td> <td></td> <td></td> <th>回転モーメント (kN・m)</th> </tr> <tr> <td></td> <td></td> <td></td> <td>4.0</td> </tr> </tbody> </table> <p>③ 評価結果</p> <p>評価 以上より、当該埋込金物に作用する発生荷重は、選定した型式の最大使用荷重以下であり健全性を確認した。</p>	軸方向荷重と曲げモーメントの組合せ		せん断方向荷重と回転モーメントの組合せ		軸方向荷重 (kN)	曲げモーメント (kN・m)	せん断方向荷重 (kN)	回転モーメント (kN・m)	5	0.7	3	0.0	型式	最大使用荷重			軸方向荷重 (kN)	曲げモーメント (kN・m)	せん断方向荷重 (kN)	B	25	2.5	40				回転モーメント (kN・m)				4.0	<p>・ 代表的な支持構造物の形状に差異があるが、結果の示し方に差異はないため、記載の差異により新たな論点が生じるものではない。</p>
軸方向荷重と曲げモーメントの組合せ		せん断方向荷重と回転モーメントの組合せ																															
軸方向荷重 (kN)	曲げモーメント (kN・m)	せん断方向荷重 (kN)	回転モーメント (kN・m)																														
5	0.7	3	0.0																														
型式	最大使用荷重																																
	軸方向荷重 (kN)	曲げモーメント (kN・m)	せん断方向荷重 (kN)																														
B	25	2.5	40																														
			回転モーメント (kN・m)																														
			4.0																														
	<p>(4) 埋込金物</p> <p>① 発生荷重</p> <table border="1" data-bbox="1908 1220 1982 1633"> <thead> <tr> <th>引張り(N)</th> <th>せん断(N)</th> </tr> </thead> <tbody> <tr> <td>99608</td> <td>20496</td> </tr> </tbody> </table> <p>② 発生荷重及び最大使用荷重</p> <table border="1" data-bbox="2056 663 2163 1633"> <thead> <tr> <th rowspan="2">タイプ</th> <th colspan="2">発生荷重(N)</th> <th colspan="2">最大使用荷重(N)</th> </tr> <tr> <th>引張り</th> <th>せん断</th> <th>引張り</th> <th>せん断</th> </tr> </thead> <tbody> <tr> <td>VI</td> <td>99608</td> <td>20496</td> <td>146400</td> <td>780400</td> </tr> </tbody> </table> <p>③ 評価結果</p> <p>評価 以上より、当該埋込金物に作用する発生荷重は、選定したタイプの最大使用荷重以下であり健全性を確認した。</p>	引張り(N)	せん断(N)	99608	20496	タイプ	発生荷重(N)		最大使用荷重(N)		引張り	せん断	引張り	せん断	VI	99608	20496	146400	780400														
引張り(N)	せん断(N)																																
99608	20496																																
タイプ	発生荷重(N)		最大使用荷重(N)																														
	引張り	せん断	引張り	せん断																													
VI	99608	20496	146400	780400																													

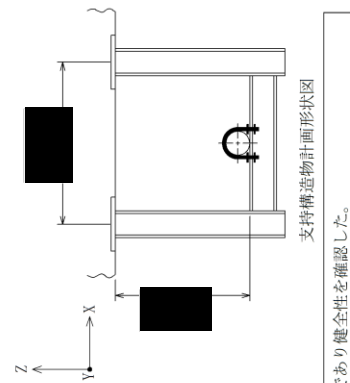
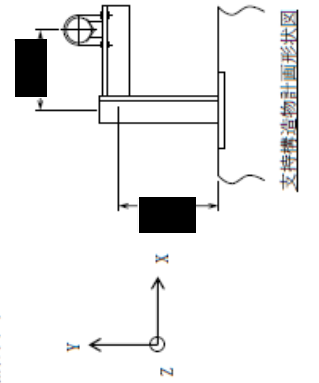
再処理施設	発電炉	備考																																															
<p>添付書類IV-1-1</p>	<p>添付書類IV-1-1-11-1</p> <p>第3.2.1-8表(1/2) 支持構造物の強度及び耐震計算結果</p> <div style="display: flex; justify-content: space-around;"> <div style="width: 45%;"> <p>支持構造物評価(タイプ-3)</p> <table border="1" style="width: 100%;"> <tr> <td>F_x</td> <td>F_y</td> <td>F_z</td> </tr> <tr> <td>4000</td> <td>-</td> <td>4000</td> </tr> </table> <p>① 支持点荷重</p> <table border="1" style="width: 100%;"> <tr> <th colspan="2">組合せ応力(MPa)</th> </tr> <tr> <td>最大発生応力</td> <td>許容応力</td> </tr> <tr> <td>49</td> <td>235</td> </tr> </table> <p>② 評価結果</p> <p>以上より、選定した鋼材サイズの最大発生応力は、許容応力以下であり健全性を確認した。</p> </div> <div style="width: 45%;">  <p>支持構造物計画形状図</p> <p>③ 付属部品</p> <table border="1" style="width: 100%;"> <tr> <th rowspan="2">付属部品名称</th> <th colspan="2">支持点荷重(kN)</th> <th rowspan="2">最大使用荷重(kN)</th> </tr> <tr> <th>引張荷重方向</th> <th>せん断荷重方向</th> </tr> <tr> <td>Uボルト</td> <td>4</td> <td>4</td> <td>18</td> </tr> </table> <p>④ 評価結果</p> <p>以上より、当該Uボルトに作用する支持点荷重は、最大使用荷重以下であり健全性を確認した。</p> </div> </div>	F _x	F _y	F _z	4000	-	4000	組合せ応力(MPa)		最大発生応力	許容応力	49	235	付属部品名称	支持点荷重(kN)		最大使用荷重(kN)	引張荷重方向	せん断荷重方向	Uボルト	4	4	18	<p>添付書類V-2-1-12-1</p> <p>表5-13-7 支持構造物の強度及び耐震計算結果(1/2)</p> <div style="display: flex; justify-content: space-around;"> <div style="width: 45%;"> <p>支持構造物評価(タイプ-4-1)</p> <table border="1" style="width: 100%;"> <tr> <td>F_x</td> <td>F_y</td> <td>F_z</td> </tr> <tr> <td>1000</td> <td>1000</td> <td>-</td> </tr> </table> <p>① 支持点荷重</p> <table border="1" style="width: 100%;"> <tr> <th colspan="2">最大発生応力及び許容応力</th> </tr> <tr> <td>鋼材サイズ</td> <td>最大発生応力(MPa)</td> <td>許容応力(MPa)</td> </tr> <tr> <td></td> <td>71</td> <td>234</td> </tr> </table> <p>② 評価結果</p> <p>以上より、選定した鋼材サイズの最大発生応力は、許容応力以下であり健全性を確認した。</p> </div> <div style="width: 45%;">  <p>支持構造物計画形状図</p> <p>③ 付属部品</p> <table border="1" style="width: 100%;"> <tr> <th colspan="2">支持点荷重及び最大使用荷重</th> </tr> <tr> <td>付属部品名称</td> <td>型式番号</td> <td>支持点荷重(N)</td> <td>最大使用荷重(N)</td> </tr> <tr> <td>Uボルト</td> <td>UN-100</td> <td>1000</td> <td>12000</td> </tr> </table> <p>④ 評価結果</p> <p>以上より、当該Uボルトに作用する支持点荷重は、最大使用荷重以下であり健全性を確認した。</p> </div> </div>	F _x	F _y	F _z	1000	1000	-	最大発生応力及び許容応力		鋼材サイズ	最大発生応力(MPa)	許容応力(MPa)		71	234	支持点荷重及び最大使用荷重		付属部品名称	型式番号	支持点荷重(N)	最大使用荷重(N)	Uボルト	UN-100	1000	12000	<p>備考</p> <ul style="list-style-type: none"> 代表的な支持構造物の形状に差異があるが、結果の示し方に差異はないため、記載の差異により新たな論点が生じるものではない。
F _x	F _y	F _z																																															
4000	-	4000																																															
組合せ応力(MPa)																																																	
最大発生応力	許容応力																																																
49	235																																																
付属部品名称	支持点荷重(kN)		最大使用荷重(kN)																																														
	引張荷重方向	せん断荷重方向																																															
Uボルト	4	4	18																																														
F _x	F _y	F _z																																															
1000	1000	-																																															
最大発生応力及び許容応力																																																	
鋼材サイズ	最大発生応力(MPa)	許容応力(MPa)																																															
	71	234																																															
支持点荷重及び最大使用荷重																																																	
付属部品名称	型式番号	支持点荷重(N)	最大使用荷重(N)																																														
Uボルト	UN-100	1000	12000																																														

再処理施設	発電炉	備考																																																	
添付書類IV-1-1	添付書類IV-1-1-11-1	添付書類V-2-1-12-1																																																	
	<p>第3.2.1-8表(2/2) 支持構造物の強度及び耐震計算結果</p> <p>(4) 埋込金物</p> <p>① 発生荷重</p> <table border="1" data-bbox="1187 735 1335 1596"> <thead> <tr> <th colspan="2">軸方向荷重と曲げモーメントの組合せ</th> <th colspan="2">せん断方向荷重と回転モーメントの組合せ</th> </tr> <tr> <th>軸方向荷重 (kN)</th> <th>曲げモーメント (kN・m)</th> <th>せん断方向荷重 (kN)</th> <th>回転モーメント (kN・m)</th> </tr> </thead> <tbody> <tr> <td>3</td> <td>1.7</td> <td>4</td> <td>0.0</td> </tr> </tbody> </table> <p>② 最大使用荷重</p> <table border="1" data-bbox="1365 630 1513 1596"> <thead> <tr> <th rowspan="2">型式</th> <th colspan="3">最大使用荷重</th> </tr> <tr> <th>軸方向荷重 (kN)</th> <th>曲げモーメント (kN・m)</th> <th>せん断方向荷重 (kN)</th> </tr> </thead> <tbody> <tr> <td>B</td> <td>25</td> <td>2.5</td> <td>40</td> </tr> <tr> <td></td> <td></td> <td></td> <th>回転モーメント (kN・m)</th> </tr> <tr> <td></td> <td></td> <td></td> <td>4.0</td> </tr> </tbody> </table> <p>③ 評価結果</p> <p>評価 以上より、当該埋込金物に作用する発生荷重は、選定した型式の最大使用荷重以下であり健全性を確認した。</p>	軸方向荷重と曲げモーメントの組合せ		せん断方向荷重と回転モーメントの組合せ		軸方向荷重 (kN)	曲げモーメント (kN・m)	せん断方向荷重 (kN)	回転モーメント (kN・m)	3	1.7	4	0.0	型式	最大使用荷重			軸方向荷重 (kN)	曲げモーメント (kN・m)	せん断方向荷重 (kN)	B	25	2.5	40				回転モーメント (kN・m)				4.0	<p>表5-13-7 支持構造物の強度及び耐震計算結果(2/2)</p> <p>(4) 埋込金物</p> <p>① 発生荷重</p> <table border="1" data-bbox="1899 1176 1988 1575"> <thead> <tr> <th>引張り(N)</th> <th>せん断(N)</th> </tr> </thead> <tbody> <tr> <td>21060</td> <td>1000</td> </tr> </tbody> </table> <p>② 発生荷重及び最大使用荷重</p> <table border="1" data-bbox="2047 630 2166 1575"> <thead> <tr> <th rowspan="2">タイプ</th> <th colspan="2">発生荷重(N)</th> <th colspan="2">最大使用荷重(N)</th> </tr> <tr> <th>引張り</th> <th>せん断</th> <th>引張り</th> <th>せん断</th> </tr> </thead> <tbody> <tr> <td>I</td> <td>21060</td> <td>1000</td> <td>93600</td> <td>240700</td> </tr> </tbody> </table> <p>③ 評価結果</p> <p>評価 以上より、当該埋込金物に作用する発生荷重は、選定したタイプの最大使用荷重以下であり健全性を確認した。</p> <p>・ 代表的な支持構造物の形状に差異があるが、結果の示し方に差異はないため、記載の差異により新たな論点が生じるものではない。</p>	引張り(N)	せん断(N)	21060	1000	タイプ	発生荷重(N)		最大使用荷重(N)		引張り	せん断	引張り	せん断	I	21060	1000	93600	240700
軸方向荷重と曲げモーメントの組合せ		せん断方向荷重と回転モーメントの組合せ																																																	
軸方向荷重 (kN)	曲げモーメント (kN・m)	せん断方向荷重 (kN)	回転モーメント (kN・m)																																																
3	1.7	4	0.0																																																
型式	最大使用荷重																																																		
	軸方向荷重 (kN)	曲げモーメント (kN・m)	せん断方向荷重 (kN)																																																
B	25	2.5	40																																																
			回転モーメント (kN・m)																																																
			4.0																																																
引張り(N)	せん断(N)																																																		
21060	1000																																																		
タイプ	発生荷重(N)		最大使用荷重(N)																																																
	引張り	せん断	引張り	せん断																																															
I	21060	1000	93600	240700																																															

再処理施設	発電炉	備考																																
添付書類IV-1-1	添付書類IV-1-1-11-1	添付書類V-2-1-12-1																																
		<p>表5-13-8 支持構造物の強度及び耐震計算結果(1/2)</p> <p>支持構造物評価 (タイプ4-2)</p> <p>(1) 支持点荷重(N)</p> <table border="1"> <tr> <td>F_x</td> <td>F_y</td> <td>F_z</td> </tr> <tr> <td>5000</td> <td>5000</td> <td>-</td> </tr> </table> <p>(2) 支持架構</p> <p>① 最大発生応力及び許容応力</p> <table border="1"> <tr> <td>鋼材サイズ</td> <td>最大発生応力 (MPa)</td> <td>許容応力 (MPa)</td> </tr> <tr> <td>■</td> <td>109</td> <td>216</td> </tr> </table> <p>② 評価結果</p> <table border="1"> <tr> <td>評価</td> <td>以上より、選定した鋼材サイズの最大発生応力は、許容応力以下であり健全性を確認した。</td> </tr> </table> <p>(3) 付属部品</p> <p>① 支持点荷重及び最大使用荷重</p> <table border="1"> <tr> <td rowspan="2">付属部品名称</td> <td rowspan="2">型式番号</td> <td colspan="2">支持点荷重(N)</td> <td colspan="2">最大使用荷重(N)</td> </tr> <tr> <td>引張荷重方向</td> <td>せん断荷重方向</td> <td>引張荷重方向</td> <td>せん断荷重方向</td> </tr> <tr> <td>Uボルト</td> <td>UN-100</td> <td>5000</td> <td>5000</td> <td>12000</td> <td>12000</td> </tr> </table> <p>② 評価結果</p> <table border="1"> <tr> <td>評価</td> <td>以上より、当該Uボルトに作用する支持点荷重は、最大使用荷重以下であり健全性を確認した。</td> </tr> </table> <p>・再処理施設において用いている代表的な支持構造物として示していないためであり、記載の差異により新たな論点が生じるものではない。</p>	F _x	F _y	F _z	5000	5000	-	鋼材サイズ	最大発生応力 (MPa)	許容応力 (MPa)	■	109	216	評価	以上より、選定した鋼材サイズの最大発生応力は、許容応力以下であり健全性を確認した。	付属部品名称	型式番号	支持点荷重(N)		最大使用荷重(N)		引張荷重方向	せん断荷重方向	引張荷重方向	せん断荷重方向	Uボルト	UN-100	5000	5000	12000	12000	評価	以上より、当該Uボルトに作用する支持点荷重は、最大使用荷重以下であり健全性を確認した。
F _x	F _y	F _z																																
5000	5000	-																																
鋼材サイズ	最大発生応力 (MPa)	許容応力 (MPa)																																
■	109	216																																
評価	以上より、選定した鋼材サイズの最大発生応力は、許容応力以下であり健全性を確認した。																																	
付属部品名称	型式番号	支持点荷重(N)		最大使用荷重(N)																														
		引張荷重方向	せん断荷重方向	引張荷重方向	せん断荷重方向																													
Uボルト	UN-100	5000	5000	12000	12000																													
評価	以上より、当該Uボルトに作用する支持点荷重は、最大使用荷重以下であり健全性を確認した。																																	

再処理施設		発電炉		備考																				
添付書類IV-1-1	添付書類IV-1-1-11-1	添付書類V-2-1-12-1																						
		<p>表 5-13-8 支持構造物の強度及び耐震計算結果(2/2)</p> <p>(4) 埋込金物</p> <p>① 発生荷重</p> <table border="1"> <tr> <td>引張り(N)</td> <td>せん断(N)</td> </tr> <tr> <td>81700</td> <td>5000</td> </tr> </table> <p>② 発生荷重及び最大使用荷重</p> <table border="1"> <tr> <td rowspan="2">タイプ</td> <td colspan="2">発生荷重(N)</td> <td colspan="2">最大使用荷重(N)</td> </tr> <tr> <td>引張り</td> <td>せん断</td> <td>引張り</td> <td>せん断</td> </tr> <tr> <td>I</td> <td>81700</td> <td>5000</td> <td>90600</td> <td>240700</td> </tr> </table> <p>③ 評価結果</p> <table border="1"> <tr> <td>評価</td> <td>以上より、当該埋込金物に作用する発生荷重は、選定したタイプの最大使用荷重以下であり健全性を確認した。</td> </tr> </table>		引張り(N)	せん断(N)	81700	5000	タイプ	発生荷重(N)		最大使用荷重(N)		引張り	せん断	引張り	せん断	I	81700	5000	90600	240700	評価	以上より、当該埋込金物に作用する発生荷重は、選定したタイプの最大使用荷重以下であり健全性を確認した。	<p>・再処理施設において用いている代表的な支持構造物として示していないためであり、記載の差異により新たな論点が生じるものではない。</p>
引張り(N)	せん断(N)																							
81700	5000																							
タイプ	発生荷重(N)		最大使用荷重(N)																					
	引張り	せん断	引張り	せん断																				
I	81700	5000	90600	240700																				
評価	以上より、当該埋込金物に作用する発生荷重は、選定したタイプの最大使用荷重以下であり健全性を確認した。																							

再処理施設	発電炉	備考																								
添付書類IV-1-1	添付書類IV-1-1-11-1	添付書類V-2-1-12-1																								
		<p>表 5-13-9 支持構造物の強度及び耐震計算結果(L/2)</p> <p>支持構造物評価 (タイプ-5)</p> <p>(1) 支持点荷重(N)</p> <table border="1" data-bbox="1863 940 1932 1272"> <tr> <td>F_x</td> <td>F_y</td> <td>F_z</td> </tr> <tr> <td>5000</td> <td>5000</td> <td>-</td> </tr> </table> <p>(2) 支持架構</p> <p>① 最大発生応力及び許容応力</p> <table border="1" data-bbox="2012 846 2113 1272"> <tr> <td>鋼材サイズ</td> <td>最大発生応力 (MPa)</td> <td>許容応力 (MPa)</td> </tr> <tr> <td>■</td> <td>58</td> <td>216</td> </tr> </table> <p>② 評価結果</p> <p>評価 以上より、選定した鋼材サイズの最大発生応力は、許容応力以下であり健全性を確認した。</p> <p>(3) 付属部品</p> <p>① 支持点荷重及び最大使用荷重</p> <table border="1" data-bbox="2282 415 2377 1272"> <tr> <td rowspan="2">付属部品名称</td> <td rowspan="2">型式番号</td> <td colspan="2">支持点荷重(N)</td> <td rowspan="2">最大使用荷重(N)</td> </tr> <tr> <td>せん断荷重方向</td> <td>せん断荷重方向</td> </tr> <tr> <td>ラグ</td> <td>LU-100</td> <td>5000</td> <td>9570</td> <td>9570</td> </tr> </table> <p>② 評価結果</p> <p>評価 以上より、当該ラグに作用する支持点荷重は、最大使用荷重以下であり健全性を確認した。</p>	F _x	F _y	F _z	5000	5000	-	鋼材サイズ	最大発生応力 (MPa)	許容応力 (MPa)	■	58	216	付属部品名称	型式番号	支持点荷重(N)		最大使用荷重(N)	せん断荷重方向	せん断荷重方向	ラグ	LU-100	5000	9570	9570
F _x	F _y	F _z																								
5000	5000	-																								
鋼材サイズ	最大発生応力 (MPa)	許容応力 (MPa)																								
■	58	216																								
付属部品名称	型式番号	支持点荷重(N)		最大使用荷重(N)																						
		せん断荷重方向	せん断荷重方向																							
ラグ	LU-100	5000	9570	9570																						
<p>再処理施設において用いている代表的な支持構造物として示していないためであり、記載の差異により新たな論点が生じるものではない。</p>																										

再処理施設		発電炉	備考																				
添付書類IV-1-1	添付書類IV-1-1-11-1	添付書類V-2-1-12-1																					
		<p>表5-13-9 支持構造物の強度及び耐震計算結果(2/2)</p> <p>(4) 埋込金物</p> <p>① 発生荷重</p> <table border="1"> <tr> <td>引張り(N)</td> <td>せん断(N)</td> </tr> <tr> <td>24884</td> <td>2540</td> </tr> </table> <p>② 発生荷重及び最大使用荷重</p> <table border="1"> <thead> <tr> <th rowspan="2">タイプ</th> <th colspan="2">発生荷重(N)</th> <th colspan="2">最大使用荷重(N)</th> </tr> <tr> <th>引張り</th> <th>せん断</th> <th>引張り</th> <th>せん断</th> </tr> </thead> <tbody> <tr> <td>I</td> <td>24884</td> <td>2540</td> <td>93600</td> <td>240700</td> </tr> </tbody> </table> <p>③ 評価結果</p> <table border="1"> <tr> <td>評価</td> <td>以上より、当該埋込金物に作用する発生荷重は、選定したタイプの最大使用荷重以下であり健全性を確認した。</td> </tr> </table>	引張り(N)	せん断(N)	24884	2540	タイプ	発生荷重(N)		最大使用荷重(N)		引張り	せん断	引張り	せん断	I	24884	2540	93600	240700	評価	以上より、当該埋込金物に作用する発生荷重は、選定したタイプの最大使用荷重以下であり健全性を確認した。	<ul style="list-style-type: none"> 再処理施設において用いている代表的な支持構造物として示していないためであり、記載の差異により新たな論点が生じるものではない。
引張り(N)	せん断(N)																						
24884	2540																						
タイプ	発生荷重(N)		最大使用荷重(N)																				
	引張り	せん断	引張り	せん断																			
I	24884	2540	93600	240700																			
評価	以上より、当該埋込金物に作用する発生荷重は、選定したタイプの最大使用荷重以下であり健全性を確認した。																						

再処理施設	発電炉	備考																							
添付書類IV-1-1	添付書類IV-1-1-11-1	添付書類V-2-1-12-1																							
		<p>表5-13-10 支持構造物の強度及び耐震計算結果(1/2)</p> <p>支持構造物評価 (タイプ-6)</p> <p>(1) 支持点荷重(N)</p> <table border="1" data-bbox="1863 919 1932 1245"> <tr> <td>F_x</td> <td>F_y</td> <td>F_z</td> </tr> <tr> <td>5000</td> <td>5000</td> <td>-</td> </tr> </table> <p>(2) 支持架構</p> <p>① 最大発生応力及び許容応力</p> <table border="1" data-bbox="2012 840 2110 1245"> <tr> <td>鋼材サイズ</td> <td>最大発生応力 (MPa)</td> <td>許容応力 (MPa)</td> </tr> <tr> <td>■</td> <td>56</td> <td>216</td> </tr> </table> <p>② 評価結果</p> <p>以上より、選定した鋼材サイズの最大発生応力は、許容応力以下であり健全性を確認した。</p> <p>(3) 付属部品</p> <p>① 支持点荷重及び最大使用荷重</p> <table border="1" data-bbox="2279 401 2371 1245"> <tr> <td rowspan="2">付属部品名称</td> <td colspan="2">支持点荷重(N)</td> <td>最大使用荷重(N)</td> </tr> <tr> <td>圧縮荷重方向</td> <td>せん断荷重方向</td> <td>せん断荷重方向</td> </tr> <tr> <td>ラグ</td> <td>5000</td> <td>5000</td> <td>9570</td> </tr> </table> <p>② 評価結果</p> <p>以上より、当該ラグに作用する支持点荷重は、最大使用荷重以下であり健全性を確認した。</p> <p>・再処理施設において用いている代表的な支持構造物として示していないためであり、記載の差異により新たな論点が生じるものではない。</p>	F _x	F _y	F _z	5000	5000	-	鋼材サイズ	最大発生応力 (MPa)	許容応力 (MPa)	■	56	216	付属部品名称	支持点荷重(N)		最大使用荷重(N)	圧縮荷重方向	せん断荷重方向	せん断荷重方向	ラグ	5000	5000	9570
F _x	F _y	F _z																							
5000	5000	-																							
鋼材サイズ	最大発生応力 (MPa)	許容応力 (MPa)																							
■	56	216																							
付属部品名称	支持点荷重(N)		最大使用荷重(N)																						
	圧縮荷重方向	せん断荷重方向	せん断荷重方向																						
ラグ	5000	5000	9570																						

再処理施設		発電炉	備考																		
添付書類IV-1-1	添付書類IV-1-1-11-1	添付書類V-2-1-12-1																			
		<p>表5-13-10 支持構造物の強度及び耐震計算結果(2/2)</p> <p>(4) 埋込金物</p> <p>① 発生荷重</p> <table border="1"> <tr> <td>引張り(N)</td> <td>せん断(N)</td> </tr> <tr> <td>24848</td> <td>2536</td> </tr> </table> <p>② 発生荷重及び最大使用荷重</p> <table border="1"> <thead> <tr> <th rowspan="2">タイプ</th> <th colspan="2">発生荷重(N)</th> <th colspan="2">最大使用荷重(N)</th> </tr> <tr> <th>引張り</th> <th>せん断</th> <th>引張り</th> <th>せん断</th> </tr> </thead> <tbody> <tr> <td>I</td> <td>24848</td> <td>2536</td> <td>93600</td> <td>240700</td> </tr> </tbody> </table> <p>③ 評価結果</p> <p>以上より、当該埋込金物に作用する発生荷重は、選定したタイプの最大使用荷重以下であり健全性を確認した。</p>	引張り(N)	せん断(N)	24848	2536	タイプ	発生荷重(N)		最大使用荷重(N)		引張り	せん断	引張り	せん断	I	24848	2536	93600	240700	<p>・再処理施設において用いている代表的な支持構造物として示していないためであり、記載の差異により新たな論点が生じるものではない。</p>
引張り(N)	せん断(N)																				
24848	2536																				
タイプ	発生荷重(N)		最大使用荷重(N)																		
	引張り	せん断	引張り	せん断																	
I	24848	2536	93600	240700																	

再処理施設		発電炉	備考
添付書類IV-1-1	添付書類IV-1-1-11-1	添付書類V-2-1-12-1	
	<p>4. その他の考慮事項</p> <p>(1) 機器と配管の相対変位に対する考慮 機器と配管との相対変位に対しては、配管側のフレキシビリティでできる限り変位を吸収することとし、機器側管台部又は支持構造体に過大な反力を生じさせないよう配管側のサポート設計において考慮する。</p> <p>(2) 建物・構築物との共振の防止 支持に当たっては据付場所に応じ、建物・構築物の共振領域からできるだけ外れた固有振動数を持つよう考慮する。また、共振領域近くで設計する場合は地震応答に対して十分な強度余裕を持つようにする。</p> <p>(3) 隣接する設備 配管が他の配管又は諸設備と接近して設置される場合は、地震、自重、熱膨張及び機械的荷重による変位があっても干渉しないようにする。保温材を施工する配管については、保温材の厚みを含めても干渉しないようにする。</p> <p>(4) 材料の選定 材料選定に当たっては、使用条件下における強度に配慮し、十分な使用実績があり、材料特性が把握された安全上信頼性が高いものを使用する。 また、「IV-1-1-9 構造計画、材料選択上の留意点」の材料の選択方針に基づき、ダクティリティを持つよう配慮する。</p>	<p>5. その他特に考慮すべき事項(V-2-1-11)</p> <p>(1) 機器と配管の相対変位に対する考慮 機器と配管との相対変位に対しては、配管側のフレキシビリティでできる限り変位を吸収することとし、機器側管台部又は支持構造体に過大な反力を生じさせないよう配管側のサポート設計において考慮する。</p> <p><u>(2) 動的機器の支持に対する考慮</u> <u>ポンプ、ファン等の動的機器に対しては地震力の他に機器の振動を考慮して支持構造物の強度設計を行う。</u> <u>また、振動による軸芯のずれを起こさないよう、据付台の基礎へのグラウト固定、取付ボルトの回り止め等の処置を行う。</u></p> <p>(3) 建屋・構築物との共振の防止 支持に当たっては据付場所に応じ、建屋・構築物の共振領域からできるだけ外れた固有振動数を持つよう考慮する。また、共振領域近くで設計する場合は地震応答に対して十分な強度余裕を持つようにする。</p> <p><u>(4) 波及的影響の防止</u> <u>耐震重要度における下位クラスの機器の破損によって上位クラスの機器に波及的影響を及ぼすことがないように配置等を考慮して設計するが、波及的影響が考えられる場合には、下位クラス機器の支持構造物は上位クラスに適用される地震動に対して設計する。</u></p> <p>(5) 隣接する設備 配管が他の配管又は諸設備と接近して設置される場合は、地震、自重、熱膨張及び機械的荷重による変位があっても干渉しないようにする。保温材を施工する配管については、保温材の厚みを含めても干渉しないようにする。</p> <p>(6) 材料の選定 材料選定に当たっては、使用条件下における強度に配慮し、十分な使用実績があり、材料特性が把握された安全上信頼性が高いものを使用する。 また、添付書類「V-2-1-10 ダクティリティに関する設計方針」の材料の選択方針に基づき、ダクティリティを持つよう配慮する。</p>	<ul style="list-style-type: none"> 具体的な考慮内容については、補足説明資料「耐震機電 23 機器と配管の相対変位に対する設計上の扱いについて」に示す。 発電炉では、機器・配管共通の方針として示しており、それに対して再処理施設では、機器、配管系それぞれ分けた方針としているが、記載内容は同等であるため、記載の差異により新たな論点が生じるものではない。なお、本記載は機器に対する方針であり、「IV-1-1-10 機器の耐震支持方針」に記載している。

再処理施設	発電炉	備考																																																											
添付書類IV-1-1	添付書類IV-1-1-11-1	添付書類V-2-1-12-1																																																											
	<p>【IV-1-1-11-1別紙1 安全機能を有する施設の直管部標準支持間隔】</p> <p>1. 概要 本資料は、耐震Sクラスの配管について、「IV-1-1 耐震設計の基本方針」及び「IV-1-1-11-1 配管の耐震支持方針」に基づき標準支持間隔法により算出した直管部標準支持間隔の解析結果を施設ごとにまとめたものである。</p> <p>2. 準拠規格 「IV-1-1 耐震設計の基本方針」に示す規格のうち、本評価に対する準拠規格について第2-1表に示す。</p> <p style="text-align: center;">第2-1表 準拠規格</p> <table border="1" data-bbox="937 747 1748 905"> <thead> <tr> <th>準拠規格名</th> </tr> </thead> <tbody> <tr> <td>原子力発電所耐震設計技術指針 JEAG4601-1987</td> </tr> <tr> <td>原子力発電所耐震設計技術指針 重要度分類・許容応力編 JEAG4601・補-1984</td> </tr> <tr> <td>発電用原子力設備規格 設計・建設規格(2005年版(2007年追補版を含む)) <第I編 軽水炉規格> JSME S NC1-2005/2007*</td> </tr> </tbody> </table> <p>注記 * : JSME S NC1以外に使用している鉄鋼材料の規格については、「V-2 強度計算方法」における添付-1「容器等の材料及び構造に関する設計の基本方針」に定められた値を準用することとする。</p> <p>3. 計算精度と数値の丸め方 解析に用いる計算精度は耐震性の結果に影響を及ぼさない桁数を確保する。 また、解析結果において数値を示す際の丸め方を第3-1表に示す。</p> <p style="text-align: center;">第3-1表 表示する数値の丸め方</p> <table border="1" data-bbox="946 1241 1739 1833"> <thead> <tr> <th>数値の種類</th> <th>単位</th> <th>処理桁</th> <th>処理方法</th> <th>表示桁</th> </tr> </thead> <tbody> <tr> <td>固有周期</td> <td>s</td> <td>小数点以下第4位</td> <td>四捨五入</td> <td>小数点以下第3位</td> </tr> <tr> <td>圧力</td> <td>MPa</td> <td>小数点以下第3位</td> <td>四捨五入</td> <td>小数点以下第2位</td> </tr> <tr> <td>温度</td> <td>℃</td> <td>小数点以下第1位</td> <td>四捨五入</td> <td>整数位</td> </tr> <tr> <td>外径</td> <td>mm</td> <td>小数点以下第2位</td> <td>四捨五入</td> <td>小数点以下第1位</td> </tr> <tr> <td>厚さ</td> <td>mm</td> <td>小数点以下第3位</td> <td>四捨五入</td> <td>小数点以下第1位</td> </tr> <tr> <td>比重</td> <td>-</td> <td>小数点以下第3位</td> <td>四捨五入</td> <td>小数点以下第2位</td> </tr> <tr> <td>単位長さ当たり重量</td> <td>N/m</td> <td>小数点以下第3位</td> <td>切上げ</td> <td>小数点以下第2位</td> </tr> <tr> <td>支持間隔</td> <td>mm</td> <td>十の位</td> <td>切捨て</td> <td>整数位</td> </tr> <tr> <td>算出応力</td> <td>MPa</td> <td>小数点以下第1位</td> <td>切上げ</td> <td>整数位</td> </tr> <tr> <td>許容応力*</td> <td>MPa</td> <td>小数点以下第1位</td> <td>切捨て</td> <td>整数位</td> </tr> </tbody> </table> <p>注記 * : JSME S NC1 付録材料図表に記載された温度の中間における許容応力は比例法により補間した値の小数点以下第1位を切り捨て、整数位までの値とする。</p>	準拠規格名	原子力発電所耐震設計技術指針 JEAG4601-1987	原子力発電所耐震設計技術指針 重要度分類・許容応力編 JEAG4601・補-1984	発電用原子力設備規格 設計・建設規格(2005年版(2007年追補版を含む)) <第I編 軽水炉規格> JSME S NC1-2005/2007*	数値の種類	単位	処理桁	処理方法	表示桁	固有周期	s	小数点以下第4位	四捨五入	小数点以下第3位	圧力	MPa	小数点以下第3位	四捨五入	小数点以下第2位	温度	℃	小数点以下第1位	四捨五入	整数位	外径	mm	小数点以下第2位	四捨五入	小数点以下第1位	厚さ	mm	小数点以下第3位	四捨五入	小数点以下第1位	比重	-	小数点以下第3位	四捨五入	小数点以下第2位	単位長さ当たり重量	N/m	小数点以下第3位	切上げ	小数点以下第2位	支持間隔	mm	十の位	切捨て	整数位	算出応力	MPa	小数点以下第1位	切上げ	整数位	許容応力*	MPa	小数点以下第1位	切捨て	整数位	<p>・発電炉は標準支持間隔法に用いる設計条件を本基本方針内に示しているが、再処理施設は本資料の別紙にて纏めて示す方針としているため、記載の差異により新たな論点が生じるものではない。</p> <p>・再処理施設において標準支持間隔法に適用している規格及び数値の丸めについて、記載の明確化を行ったため、記載の差異により新たな論点が生じるものではない。</p>
準拠規格名																																																													
原子力発電所耐震設計技術指針 JEAG4601-1987																																																													
原子力発電所耐震設計技術指針 重要度分類・許容応力編 JEAG4601・補-1984																																																													
発電用原子力設備規格 設計・建設規格(2005年版(2007年追補版を含む)) <第I編 軽水炉規格> JSME S NC1-2005/2007*																																																													
数値の種類	単位	処理桁	処理方法	表示桁																																																									
固有周期	s	小数点以下第4位	四捨五入	小数点以下第3位																																																									
圧力	MPa	小数点以下第3位	四捨五入	小数点以下第2位																																																									
温度	℃	小数点以下第1位	四捨五入	整数位																																																									
外径	mm	小数点以下第2位	四捨五入	小数点以下第1位																																																									
厚さ	mm	小数点以下第3位	四捨五入	小数点以下第1位																																																									
比重	-	小数点以下第3位	四捨五入	小数点以下第2位																																																									
単位長さ当たり重量	N/m	小数点以下第3位	切上げ	小数点以下第2位																																																									
支持間隔	mm	十の位	切捨て	整数位																																																									
算出応力	MPa	小数点以下第1位	切上げ	整数位																																																									
許容応力*	MPa	小数点以下第1位	切捨て	整数位																																																									

再処理施設		発電炉	備考
添付書類IV-1-1	添付書類IV-1-1-11-1	添付書類V-2-1-12-1	
	<p>別紙資料【IV-1-1-11-1別紙1-1 安全冷却水B冷却塔の直管部標準支持間隔】</p> <p><u>1. 解析条件</u></p> <p><u>1.1 配管設計条件</u> 標準支持間隔の算定に必要な配管設計条件を第1.1-1表に示す。</p> <p><u>1.2 階層の区分</u> 解析に当たっては、設計用床応答曲線をいくつかの階層に区分し、支持間隔を求めるものとし、第1.2-1表に示す階層の区分とする。 配管系の固有振動数については配管系の設計に用いる建屋床応答スペクトルのピークの固有振動数領域より短周期側に避けることを原則とするため、第1.2-1表に示すピーク振動数以上となるように設計する。なお、配管系の固有振動数は支持構造物を含めた固有振動数であり、支持構造物の固有振動数は第1.2-1表に示す値以上とする。</p> <p><u>2. 解析結果</u> 第1.1-1表の各種配管の設計条件をもとに計算した直管部標準支持間隔、固有周期及び応力の解析結果を第2-1表に示す。 なお、一次応力は内圧応力、自重応力及び地震応力の和とし、地震応力が弾性設計用地震動S_d又は静的震度に対するものをS_d、基準地震動S_sに対するものをS_sと表している。</p>		<p>・発電炉は標準支持間隔法に用いる設計条件を本基本方針内に示しているが、再処理施設は本資料の別紙にて纏めて示す方針としているため、記載の差異により新たな論点が生じるものではない。</p>

再処理施設	発電炉	備考																																																																																																									
添付書類IV-1-1	添付書類IV-1-1-11-1	添付書類V-2-1-12-1																																																																																																									
	<p style="text-align: center;">第 2.3-1 表 配管設計条件 (炭素鋼)</p> <p style="text-align: right;">最高使用温度 ██████ 内部流体比重 ██████</p> <p>【安全冷却水B冷却塔】</p> <table border="1" style="width: 100%; border-collapse: collapse; margin-bottom: 10px;"> <thead> <tr> <th rowspan="3">番号</th> <th colspan="2">配管仕様</th> <th rowspan="3">最高使用 圧力 (MPa)</th> <th colspan="4">単位長さ当たり重量 (N/m)</th> </tr> <tr> <th rowspan="2">口径 (A)</th> <th rowspan="2">板厚 SCH</th> <th colspan="2">保温材無し</th> <th colspan="2">保温材有り</th> </tr> <tr> <th>気体</th> <th>液体</th> <th>気体</th> <th>液体</th> </tr> </thead> <tbody> <tr> <td>1</td> <td>100</td> <td>40</td> <td>██████</td> <td>-</td> <td>██████</td> <td>-</td> <td>-</td> </tr> <tr> <td>2</td> <td>150</td> <td>40</td> <td>██████</td> <td>-</td> <td>██████</td> <td>-</td> <td>-</td> </tr> <tr> <td>3</td> <td>200</td> <td>40</td> <td>██████</td> <td>-</td> <td>██████</td> <td>-</td> <td>-</td> </tr> <tr> <td colspan="8">以下余白</td> </tr> </tbody> </table> <p style="text-align: center;">第1.2-1表 設計用床応答曲線区分</p> <table border="1" style="width: 100%; border-collapse: collapse;"> <thead> <tr> <th>床応答曲線区分</th> <th>標高 (m)</th> <th>ピーク振動数 (Hz)</th> <th>支持構造物の固有振動数 (Hz)</th> </tr> </thead> <tbody> <tr> <td>1</td> <td>EL. ██████ ~ ██████</td> <td rowspan="2" style="text-align: center;">-</td> <td rowspan="2" style="text-align: center;">██████</td> </tr> <tr> <td>2</td> <td>EL. ██████ ~ ██████</td> </tr> </tbody> </table>	番号	配管仕様		最高使用 圧力 (MPa)	単位長さ当たり重量 (N/m)				口径 (A)	板厚 SCH	保温材無し		保温材有り		気体	液体	気体	液体	1	100	40	██████	-	██████	-	-	2	150	40	██████	-	██████	-	-	3	200	40	██████	-	██████	-	-	以下余白								床応答曲線区分	標高 (m)	ピーク振動数 (Hz)	支持構造物の固有振動数 (Hz)	1	EL. ██████ ~ ██████	-	██████	2	EL. ██████ ~ ██████	<p>【記載箇所：3.3.1.3(6) 配管系の振動数に記載している内容】</p> <table border="1" style="width: 100%; border-collapse: collapse; margin-bottom: 10px;"> <caption style="text-align: center;">表3-5 配管仕様 (緊急時対策所用代替電源設備)</caption> <thead> <tr> <th rowspan="2">番号</th> <th rowspan="2">配管仕様 口径(mm) / 板厚(mm)</th> <th colspan="2">単位長さ当たりの重量 (kg/m)</th> <th rowspan="2">内圧 (MPa)</th> </tr> <tr> <th>保温材無</th> <th>保温材有</th> </tr> </thead> <tbody> <tr> <td>1</td> <td>60.5 / 3.9</td> <td colspan="2">██████████████</td> <td rowspan="5">██████████</td> </tr> <tr> <td>2</td> <td>60.5 / 3.9</td> <td colspan="2">██████████████</td> </tr> <tr> <td>3</td> <td>48.6 / 3.7</td> <td colspan="2">██████████████</td> </tr> <tr> <td>4</td> <td>48.6 / 3.7</td> <td colspan="2">██████████████</td> </tr> <tr> <td>5</td> <td>27.2 / 2.9</td> <td colspan="2">██████████████</td> </tr> </tbody> </table> <p>【記載箇所：3.3.1.3(6) 配管系の振動数に記載している内容】</p> <table border="1" style="width: 100%; border-collapse: collapse;"> <caption style="text-align: center;">表3-4 床応答曲線区分 (緊急時対策所用代替電源設備)</caption> <thead> <tr> <th>建屋</th> <th>床応答曲線高さ E.L. (m)</th> <th>制限振動数 (Hz)</th> <th>支持構造物の固有振動数 (Hz)</th> </tr> </thead> <tbody> <tr> <td>緊急時対策所建屋</td> <td colspan="3">████████████████████</td> </tr> <tr> <td>緊急時対策所用発電機</td> <td colspan="3">████████████████████</td> </tr> <tr> <td>燃料油貯蔵タンク基礎</td> <td colspan="3">████████████████████</td> </tr> </tbody> </table> <p style="text-align: right; margin-top: 10px;">(18/258) 頁から</p>	番号	配管仕様 口径(mm) / 板厚(mm)	単位長さ当たりの重量 (kg/m)		内圧 (MPa)	保温材無	保温材有	1	60.5 / 3.9	██████████████		██████████	2	60.5 / 3.9	██████████████		3	48.6 / 3.7	██████████████		4	48.6 / 3.7	██████████████		5	27.2 / 2.9	██████████████		建屋	床応答曲線高さ E.L. (m)	制限振動数 (Hz)	支持構造物の固有振動数 (Hz)	緊急時対策所建屋	████████████████████			緊急時対策所用発電機	████████████████████			燃料油貯蔵タンク基礎	████████████████████			
番号	配管仕様		最高使用 圧力 (MPa)	単位長さ当たり重量 (N/m)																																																																																																							
	口径 (A)			板厚 SCH		保温材無し		保温材有り																																																																																																			
		気体			液体	気体	液体																																																																																																				
1	100	40	██████	-	██████	-	-																																																																																																				
2	150	40	██████	-	██████	-	-																																																																																																				
3	200	40	██████	-	██████	-	-																																																																																																				
以下余白																																																																																																											
床応答曲線区分	標高 (m)	ピーク振動数 (Hz)	支持構造物の固有振動数 (Hz)																																																																																																								
1	EL. ██████ ~ ██████	-	██████																																																																																																								
2	EL. ██████ ~ ██████																																																																																																										
番号	配管仕様 口径(mm) / 板厚(mm)	単位長さ当たりの重量 (kg/m)		内圧 (MPa)																																																																																																							
		保温材無	保温材有																																																																																																								
1	60.5 / 3.9	██████████████		██████████																																																																																																							
2	60.5 / 3.9	██████████████																																																																																																									
3	48.6 / 3.7	██████████████																																																																																																									
4	48.6 / 3.7	██████████████																																																																																																									
5	27.2 / 2.9	██████████████																																																																																																									
建屋	床応答曲線高さ E.L. (m)	制限振動数 (Hz)	支持構造物の固有振動数 (Hz)																																																																																																								
緊急時対策所建屋	████████████████████																																																																																																										
緊急時対策所用発電機	████████████████████																																																																																																										
燃料油貯蔵タンク基礎	████████████████████																																																																																																										

再処理施設	発電炉	備考																																																																																																																																																																										
添付書類IV-1-1	添付書類IV-1-1-11-1	添付書類V-2-1-12-1																																																																																																																																																																										
	<p>第2-1表 Sクラス配管部標準支持間隔(取組、保溫材無し)</p> <p>【安全余裕率1.5倍】</p> <table border="1"> <thead> <tr> <th rowspan="2">標準 配管 口径(φ) 及び壁厚</th> <th colspan="3">気体</th> <th colspan="3">液体</th> <th colspan="3">気体</th> <th colspan="3">液体</th> </tr> <tr> <th>支持 間隔 (mm)</th> <th>固有 周期 (s)</th> <th>一次応力 (MPa)</th> <th>支持 間隔 (mm)</th> <th>固有 周期 (s)</th> <th>一次応力 (MPa)</th> <th>支持 間隔 (mm)</th> <th>固有 周期 (s)</th> <th>一次応力 (MPa)</th> <th>支持 間隔 (mm)</th> <th>固有 周期 (s)</th> <th>一次応力 (MPa)</th> </tr> </thead> <tbody> <tr> <td>100 SCH40</td> <td>-</td> <td>-</td> <td>-</td> <td>-</td> <td>-</td> <td>-</td> <td>-</td> <td>-</td> <td>-</td> <td>-</td> <td>-</td> <td>-</td> </tr> <tr> <td>150 SCH40</td> <td>-</td> <td>-</td> <td>-</td> <td>-</td> <td>-</td> <td>-</td> <td>-</td> <td>-</td> <td>-</td> <td>-</td> <td>-</td> <td>-</td> </tr> <tr> <td>200 SCH40</td> <td>-</td> <td>-</td> <td>-</td> <td>-</td> <td>-</td> <td>-</td> <td>-</td> <td>-</td> <td>-</td> <td>-</td> <td>-</td> <td>-</td> </tr> <tr> <td>以下余白</td> <td></td> <td></td> <td></td> <td></td> <td></td> <td></td> <td></td> <td></td> <td></td> <td></td> <td></td> <td></td> </tr> </tbody> </table>	標準 配管 口径(φ) 及び壁厚	気体			液体			気体			液体			支持 間隔 (mm)	固有 周期 (s)	一次応力 (MPa)	支持 間隔 (mm)	固有 周期 (s)	一次応力 (MPa)	支持 間隔 (mm)	固有 周期 (s)	一次応力 (MPa)	支持 間隔 (mm)	固有 周期 (s)	一次応力 (MPa)	100 SCH40	-	-	-	-	-	-	-	-	-	-	-	-	150 SCH40	-	-	-	-	-	-	-	-	-	-	-	-	200 SCH40	-	-	-	-	-	-	-	-	-	-	-	-	以下余白													<p>【記載箇所：3.3.8 標準支持間隔に記載している内容】</p> <p>表3-7 直管部標準支持間隔(減衰定数0.5%)</p> <table border="1"> <thead> <tr> <th rowspan="2">建屋</th> <th rowspan="2">E.L. (m)</th> <th rowspan="2">材料</th> <th rowspan="2">外径 (mm)</th> <th rowspan="2">保 温 材 の 有 無</th> <th rowspan="2">単 位 長 さ 当 た り の 質 量 (kg/m)</th> <th colspan="4">解析結果</th> <th rowspan="2">番 号</th> </tr> <tr> <th>支持 間隔 (m)</th> <th>固有 振動 数 (Hz)</th> <th>一次 応力 (MPa)</th> <th>許容 応力 (MPa)</th> </tr> </thead> <tbody> <tr> <td>緊急時対策所 用発電機燃料 油貯蔵タンク 基礎</td> <td>23.3</td> <td rowspan="3">STPT370</td> <td>60.5</td> <td>無</td> <td>7.27</td> <td>4.0</td> <td>10.0</td> <td>148</td> <td>331</td> <td>1</td> </tr> <tr> <td rowspan="2">緊急時対策所 建屋</td> <td rowspan="2">23.3</td> <td>60.5</td> <td>無</td> <td>7.27</td> <td>4.0</td> <td>10.0</td> <td>148</td> <td>331</td> <td>1</td> </tr> <tr> <td>60.5</td> <td>無</td> <td>7.27</td> <td>3.9</td> <td>10.3</td> <td>101</td> <td>331</td> <td>2</td> </tr> <tr> <td rowspan="2">緊急時対策所 建屋</td> <td rowspan="2">30.3</td> <td rowspan="2">STPT370</td> <td>48.6</td> <td>無</td> <td>5.21</td> <td>3.6</td> <td>10.1</td> <td>147</td> <td>331</td> <td>4</td> </tr> <tr> <td>48.6</td> <td>無</td> <td>5.21</td> <td>3.5</td> <td>10.4</td> <td>103</td> <td>331</td> <td>3</td> </tr> <tr> <td rowspan="2">緊急時対策所 建屋</td> <td rowspan="2">23.3</td> <td rowspan="2">STPT370</td> <td>48.6</td> <td>無</td> <td>5.21</td> <td>3.6</td> <td>10.1</td> <td>147</td> <td>331</td> <td>4</td> </tr> <tr> <td>48.6</td> <td>無</td> <td>5.21</td> <td>3.5</td> <td>10.4</td> <td>104</td> <td>331</td> <td>4</td> </tr> <tr> <td>緊急時対策所 建屋</td> <td>30.3</td> <td>STPT370</td> <td>27.2</td> <td>無</td> <td>2.04</td> <td>2.7</td> <td>10.1</td> <td>147</td> <td>331</td> <td>5</td> </tr> </tbody> </table> <p>(40/258) 頁から</p>	建屋	E.L. (m)	材料	外径 (mm)	保 温 材 の 有 無	単 位 長 さ 当 た り の 質 量 (kg/m)	解析結果				番 号	支持 間隔 (m)	固有 振動 数 (Hz)	一次 応力 (MPa)	許容 応力 (MPa)	緊急時対策所 用発電機燃料 油貯蔵タンク 基礎	23.3	STPT370	60.5	無	7.27	4.0	10.0	148	331	1	緊急時対策所 建屋	23.3	60.5	無	7.27	4.0	10.0	148	331	1	60.5	無	7.27	3.9	10.3	101	331	2	緊急時対策所 建屋	30.3	STPT370	48.6	無	5.21	3.6	10.1	147	331	4	48.6	無	5.21	3.5	10.4	103	331	3	緊急時対策所 建屋	23.3	STPT370	48.6	無	5.21	3.6	10.1	147	331	4	48.6	無	5.21	3.5	10.4	104	331	4	緊急時対策所 建屋	30.3	STPT370	27.2	無	2.04	2.7	10.1	147	331	5
標準 配管 口径(φ) 及び壁厚	気体			液体			気体			液体																																																																																																																																																																		
	支持 間隔 (mm)	固有 周期 (s)	一次応力 (MPa)	支持 間隔 (mm)	固有 周期 (s)	一次応力 (MPa)	支持 間隔 (mm)	固有 周期 (s)	一次応力 (MPa)	支持 間隔 (mm)	固有 周期 (s)	一次応力 (MPa)																																																																																																																																																																
100 SCH40	-	-	-	-	-	-	-	-	-	-	-	-																																																																																																																																																																
150 SCH40	-	-	-	-	-	-	-	-	-	-	-	-																																																																																																																																																																
200 SCH40	-	-	-	-	-	-	-	-	-	-	-	-																																																																																																																																																																
以下余白																																																																																																																																																																												
建屋	E.L. (m)	材料	外径 (mm)	保 温 材 の 有 無	単 位 長 さ 当 た り の 質 量 (kg/m)	解析結果				番 号																																																																																																																																																																		
						支持 間隔 (m)	固有 振動 数 (Hz)	一次 応力 (MPa)	許容 応力 (MPa)																																																																																																																																																																			
緊急時対策所 用発電機燃料 油貯蔵タンク 基礎	23.3	STPT370	60.5	無	7.27	4.0	10.0	148	331	1																																																																																																																																																																		
緊急時対策所 建屋	23.3		60.5	無	7.27	4.0	10.0	148	331	1																																																																																																																																																																		
			60.5	無	7.27	3.9	10.3	101	331	2																																																																																																																																																																		
緊急時対策所 建屋	30.3	STPT370	48.6	無	5.21	3.6	10.1	147	331	4																																																																																																																																																																		
			48.6	無	5.21	3.5	10.4	103	331	3																																																																																																																																																																		
緊急時対策所 建屋	23.3	STPT370	48.6	無	5.21	3.6	10.1	147	331	4																																																																																																																																																																		
			48.6	無	5.21	3.5	10.4	104	331	4																																																																																																																																																																		
緊急時対策所 建屋	30.3	STPT370	27.2	無	2.04	2.7	10.1	147	331	5																																																																																																																																																																		

別紙 4－12

ダクトの耐震支持方針

※本資料は設備の申請に合わせて次回以降に追加する

【凡例】

下線：

- ・プラントの違いによらない記載内容の差異
- ・章立ての違いによる記載位置の違いによる差異

二重下線：

- ・プラント固有の事項による記載内容の差異
- ・後次回の申請範囲に伴う差異

別紙4－13

電気計測制御装置等の耐震支持方針

【凡例】

下線：

- ・プラントの違いによらない記載内容の差異
- ・章立ての違いによる記載位置の違いによる差異

二重下線：

- ・プラント固有の事項による記載内容の差異
- ・後次回の申請範囲に伴う差異

再処理施設		発電炉	備考
添付書類IV-1-1	添付書類IV-1-1-12	添付書類V-2-1-11	
	IV-1-1-12 <u>電気計測制御装置等の耐震支持方針</u> 目次 1. 基本原則 2. 支持構造物の設計 2.1 設計手順 2.2 支持構造物及び埋込金物の設計 3. <u>電気計測制御装置等の耐震設計方針</u> 3.1 概要 3.2 耐震設計の範囲 3.3 耐震設計の手順 3.3.1 盤の耐震設計手順 3.3.2 装置の耐震設計手順 3.3.3 器具の耐震設計手順 3.3.4 電路類の耐震設計手順 3.3.5 既存資料の利用による耐震設計	V-2-1-11 <u>機器・配管の耐震支持設計方針</u> 目次 3. <u>電気計測制御装置</u> 3.1 基本原則 3.2 支持構造物の設計 3.2.1 設計手順 3.2.2 支持構造物及び埋込金物の設計 V-2-1-11 <u>機器・配管の耐震支持設計方針 別紙1</u> 目次 1. 概要 2. 耐震設計の範囲 3. 耐震設計の手順 3.1 盤の耐震設計手順 3.2 装置の耐震設計手順 3.3 器具の耐震設計手順 3.4 電路類の耐震設計手順 3.5 既存資料の利用による耐震設計	・再処理施設においては、機器、配管系、電気計測制御装置等について各々支持構造物の設計方針が異なることから個別の設計方針を作成している。よって、本資料との比較においては、発電炉の電気計測制御装置の耐震支持設計方針部分との比較を行う。

再処理施設		発電炉	備考
添付書類IV-1-1	添付書類IV-1-1-12	添付書類V-2-1-11	
<p>9. 機器・配管系の支持方針について 機器・配管系本体については「5. 機能維持の基本方針」に基づいて耐震設計を行う。それらの支持構造物については、容器及びポンプ類等の機器、配管系、電気計測制御装置等の設計方針を「IV-1-1-10 機器の耐震支持方針」、「IV-1-1-11-1 配管の耐震支持方針」、「IV-1-1-12 電気計測制御装置等の耐震支持方針」及び後次回にて申請する「IV-1-1-11-2 ダクトの耐震支持方針」に示す。</p>	<p>1. 基本原則 電気計測制御装置等の耐震支持方針は下記によるものとする。 (1) 電気計測制御装置等は取付ボルト等により支持構造物に固定される。支持構造物は、剛な床、壁面等から支持することとする。 (2) 支持構造物を含め十分剛構造とすることで建物・構築物との共振を防止する。 (3) 剛性を十分に確保できない場合は、振動特性に応じた地震応答解析により、応力評価に必要な荷重等を算定し、その荷重等に耐える設計とする。 (4) 地震時に要求される電氣的機能を喪失しない構造とする。 電気計測制御装置等の電氣的機能維持の設計方針を3.以降に示す。</p> <p>2. 支持構造物の設計 2.1 設計手順 電気計測制御装置等の配置及び構造計画に際しては、設置場所の環境条件、現地施工性等の関連を十分考慮して総合的な調整を行い、電気計測制御装置等の特性、運転操作及び保守点検の際に支障とならないこと等についての配慮を十分加味した耐震設計を行うよう考慮する。</p> <p>設計手順を第2.1-1図に示す。 支持構造物の設計は、建物・構築物基本計画、電気計測制御装置等の基本設計条件等から配置設計を行い、耐震解析及び機能維持の検討により強度及び支持機能を確認し、詳細設計を行う。</p>	<p>3. 電気計測制御装置 3.1 基本原則 電気計測制御装置の耐震支持方針は下記によるものとする。 (1) 電気計測制御装置は取付ボルト等により支持構造物に固定される。支持構造物は、剛な床、壁面等から支持することとする。 (2) 支持構造物を含め十分剛構造とすることで建屋との共振を防止する。 (3) 剛性を十分に確保できない場合は、振動特性に応じた地震応答解析により、応力評価に必要な荷重等を算定し、その荷重等に耐える設計とする。 (4) 地震時に要求される電氣的機能を喪失しない構造とする。 電気計測制御装置の電氣的機能維持の設計方針を別紙1に示す。</p> <p>3.2 支持構造物の設計 3.2.1 設計手順 電気計測制御装置の配置、構造計画に際しては、設置場所の環境条件、現地施工性等の関連を十分考慮して総合的な調整を行い、電気計測制御装置類の特性、運転操作及び保守点検の際に支障とならないこと等についての配慮を十分加味した耐震設計を行うよう考慮する。</p> <p>設計手順を図3-1に示す。 支持構造物の設計は、建屋基本計画及び電気計測制御装置の基本設計条件等から配置設計を行い、耐震解析、機能維持の検討により強度及び支持機能を確認し、詳細設計を行う。</p>	<p>・再処理施設における電気計測制御装置は、盤、装置、器具及び回路類であり電気計測制御装置等としているため、記載の差異により新たな論点が生じるものではない。</p>

再処理施設	発電炉	備考
添付書類IV-1-1	添付書類IV-1-1-12	添付書類V-2-1-11
	<p>*1 変圧器、蓄電池 測温抵抗体は除く。</p> <p>*2 環境条件、現地施工性及び運転操作・保守点検時の配慮含む。</p> <p>第2.1-1 図 支持構造物の耐震設計フローチャート</p>	<p>*1 変圧器、蓄電池 測温抵抗体は除く。</p> <p>*2 環境条件、現地施工性及び運転操作・保守点検時の配慮含む。</p> <p>図3-1 電気計測制御装置の支持構造物設計フロー</p>

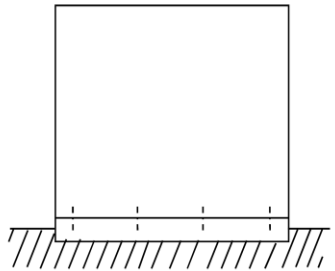
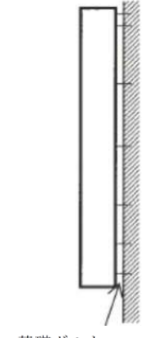
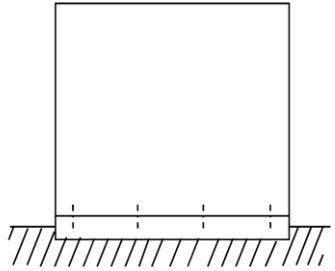
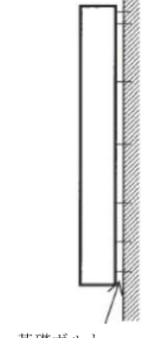
再処理施設		発電炉	備考
添付書類IV-1-1	添付書類IV-1-1-12	添付書類V-2-1-11	
	<p>2.2 支持構造物及び埋込金物の設計</p> <p>(1) 盤の設計</p> <p>a. 設計方針 盤に実装される器具は取付ボルトにより盤に固定する。</p> <p>盤には<u>垂直自立形</u>と<u>壁掛形</u>があり、鋼材及び鋼板を組み合わせたフレーム及び筐体で構成される箱型構造とする。 <u>垂直自立形</u>の盤は基礎ボルトにより、あるいは床面に埋め込まれた埋込金物に溶接することにより自重及び地震荷重に対し、有効な支持機能を有するよう設計する。 <u>壁掛形</u>の盤は基礎ボルトにより、あるいは埋込金物に溶接することにより自重及び地震荷重に対し、有効な支持機能を有するよう設計する。</p> <p>b. 荷重条件 荷重の種類及び組合せについては「IV-1-1-8 機能維持の基本方針」に従う。</p> <div style="display: flex; justify-content: space-around; align-items: center;"> <div style="text-align: center;">  <p>(垂直自立形)</p> </div> <div style="text-align: center;">  <p>基礎ボルト (壁掛形)</p> </div> </div>	<p>3.2.2 支持構造物及び埋込金物の設計</p> <p>(1) 盤の設計</p> <p>a. 設計方針 盤に実装される器具は取付ボルトにより盤に固定する。</p> <p>盤には<u>自立型</u>と<u>壁掛型</u>があり、鋼材及び鋼板を組み合わせたフレーム及び筐体で構成される箱型構造とする。 <u>自立型</u>の盤は基礎ボルトにより、あるいは床面に埋め込まれた埋込金物に溶接することにより自重及び地震荷重に対し、有効な支持機能を有するよう設計する。 <u>壁掛型</u>の盤は基礎ボルトにより、あるいは埋込金物に溶接することにより自重及び地震荷重に対し、有効な支持機能を有するよう設計する。</p> <p>b. 荷重条件 荷重の種類及び組合せについては、添付書類「V-2-1-9 機能維持の基本方針」に従う。</p> <div style="display: flex; justify-content: space-around; align-items: center;"> <div style="text-align: center;">  <p>(自立盤)</p> </div> <div style="text-align: center;">  <p>基礎ボルト (壁掛盤)</p> </div> </div>	<p>・再処理施設における盤の形状による呼称であり、記載の差異により新たな論点が生じるものではない。</p>

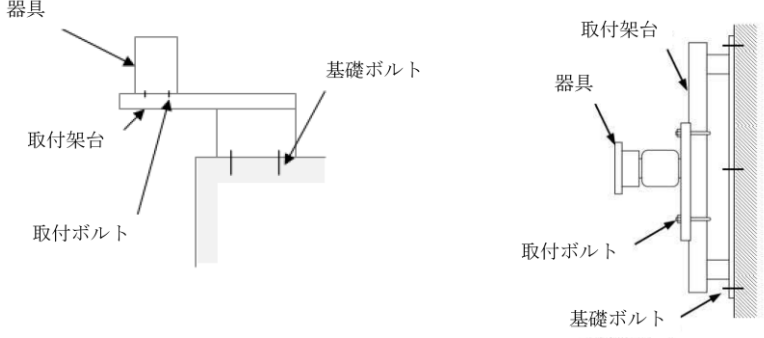
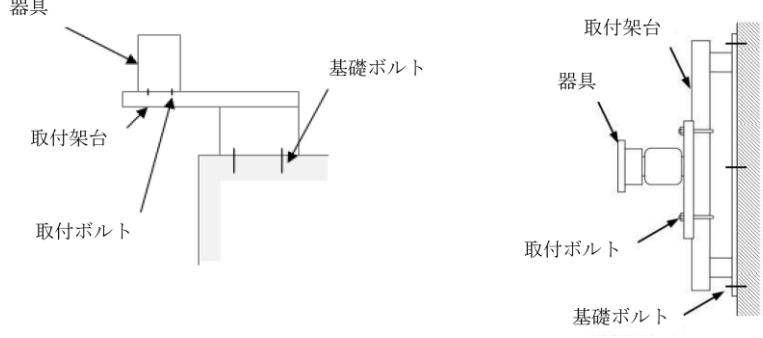
再処理施設		発電炉	備考
添付書類IV-1-1	添付書類IV-1-1-12	添付書類V-2-1-11	
	<p>(2) 架台の設計</p> <p>a. 設計方針 架台に実装される器具は取付ボルトにより架台に固定する。 架台は鋼材を組み合わせた溶接構造又はボルト締結構造とし、自重及び地震荷重に対し、機能低下を起こすような変形を起こさないよう設計する。 架台は基礎ボルトにより、あるいは埋込金物に溶接することにより自重及び地震荷重に対し、有効な支持機能を有するよう設計する。</p> <p>b. 荷重条件 荷重の種類及び組合せについては「IV-1-1-8 機能維持の基本方針」に従う。</p> 	<p>(2) 架台の設計</p> <p>a. 設計方針 架台に実装される器具は取付ボルトにより架台に固定する。 架台は鋼材を組み合わせた溶接構造又はボルト締結構造とし、自重及び地震荷重に対し、機能低下を起こすような変形をおこさないよう設計する。 架台は基礎ボルトにより、あるいは埋込金物に溶接することにより自重及び地震荷重に対し、有効な支持機能を有するよう設計する。</p> <p>b. 荷重条件 荷重の種類及び組合せについては、添付書類「V-2-1-9 機能維持の基本方針」に従う。</p> 	

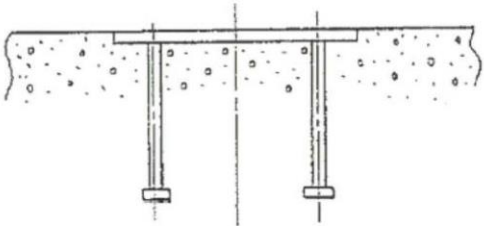
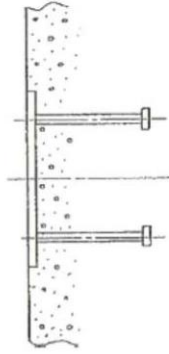
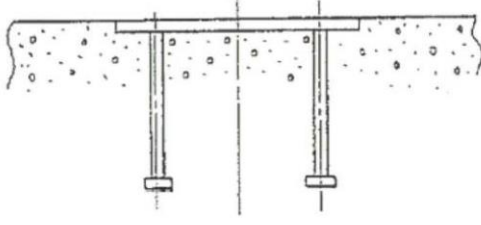
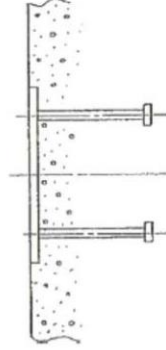
再処理施設		発電炉	備考
添付書類IV-1-1	添付書類IV-1-1-12	添付書類V-2-1-11	
	<p>(3) 埋込金物の設計</p> <p>a. 設計方針 埋込金物は、支持構造物から加わる荷重を基礎に伝え、支持構造物と一体となって支持機能を満たすように設計する。埋込金物の選定は、支持荷重及び配置を考慮して行う。</p> <p>b. 荷重条件 荷重の種類及び組合せについては「IV-1-1-8 機能維持の基本方針」に従う。</p> <p>c. 種類及び選定 埋込金物には下記の種類があり、それぞれの使用用途に合わせて選定する。</p> <p>(a) 埋込金物形式 機器の配置計画時に基礎との取合い形状が確定できない場合に使用する。</p> <div style="display: flex; justify-content: space-around; align-items: center;">   </div> <p style="text-align: center;">(自立式) (壁掛式)</p>	<p>(3) 埋込金物の設計</p> <p>a. 設計方針 埋込金物は、支持構造物から加わる荷重を基礎に伝え、支持構造物と一体となって支持機能を満たすように設計する。埋込金物の選定は、支持荷重及び配置を考慮して行う。</p> <p>b. 荷重条件 荷重の種類及び組合せについては、添付書類「V-2-1-9 機能維持の基本方針」に従う。</p> <p>c. 種類及び選定 埋込金物には下記の種類があり、それぞれの使用用途にあわせて選定する。</p> <p>(a) 埋込金物形式 機器の配置計画時に基礎との取合い形状が確定できない場合に使用する。</p> <div style="display: flex; justify-content: space-around; align-items: center;">   </div> <p style="text-align: center;">(自立式) (壁掛式)</p>	

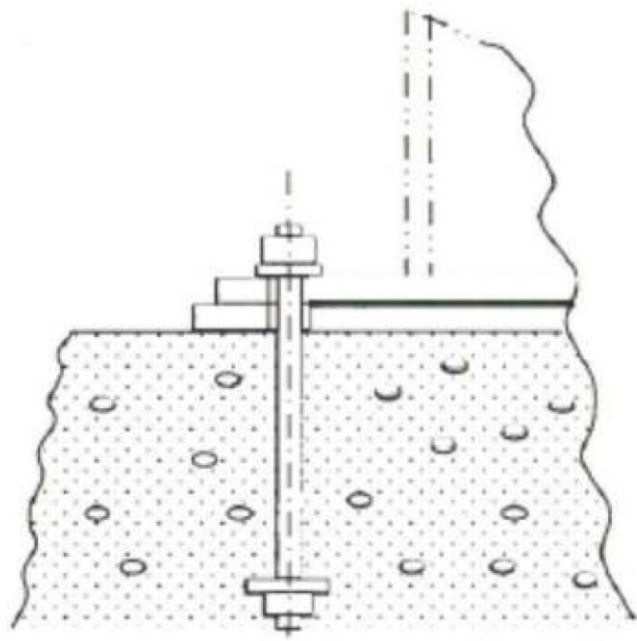
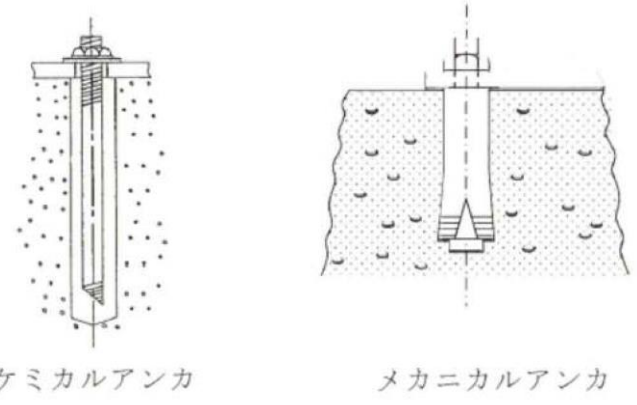
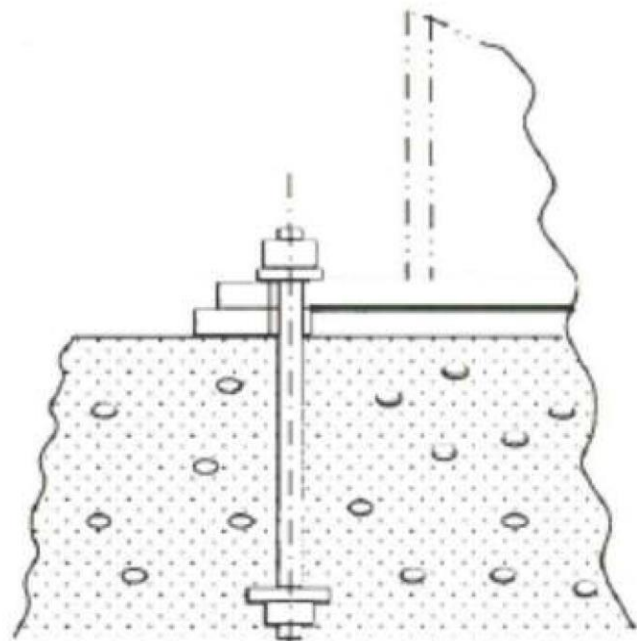
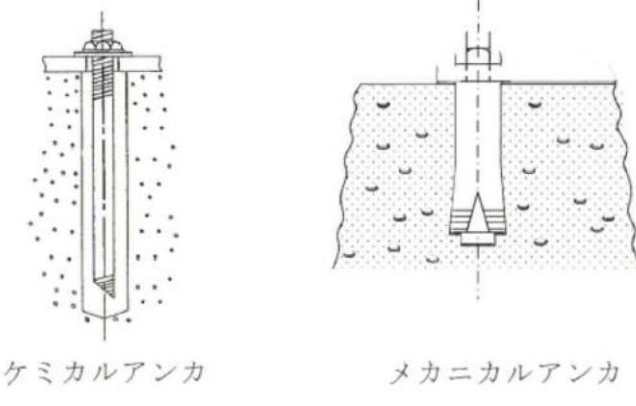
再処理施設	発電炉	備考
添付書類IV-1-1	添付書類V-2-1-11	備考
	<p>(b) 基礎ボルト形式 機器の配置計画時に基礎との取合い形状が確定できる場合に使用する。</p>  <p>(c) 後打アンカ 打設後のコンクリートに穿孔機で孔をあけて設置するもので、ケミカルアンカ又はメカニカルアンカを適用する。ただし、ケミカルアンカは、要求される支持機能が維持できる温度条件で使用する。また、メカニカルアンカは振動が大きい箇所に使用しない。</p> <p>後打アンカの設計は、<u>JEAG4601・補-1984</u>又は「各種合成構造設計指針・同解説」((社)日本建築学会, 2010改定)に基づき設計する。また、アンカメーカーが定める施工要領に従い設置する。</p>  <p>ケミカルアンカ メカニカルアンカ</p>	<p>(b) 基礎ボルト形式 機器の配置計画時に基礎との取合い形状が確定できる場合に使用する。</p>  <p>(c) 後打アンカ 打設後のコンクリートに穿孔機で孔をあけて設置するもので、ケミカルアンカ又はメカニカルアンカを使用する。ただし、ケミカルアンカは、要求される支持機能が維持できる温度条件で使用する。また、メカニカルアンカは振動が大きい箇所に使用しない。</p> <p>後打アンカの設計は、「各種合成構造設計指針・同解説」(日本建築学会, 2010年改定)に基づき設計する。また、アンカメーカーが定める施工要領に従い設置する。</p>  <p>ケミカルアンカ メカニカルアンカ</p> <p>・申請書間の整合を図るため、添付書類「IV-1-1-8 機能維持の基本方針」に合わせた記載としており、記載の差異により新たな論点が生じるものではない。</p>

再処理施設		発電炉	備考
添付書類IV-1-1	添付書類IV-1-1-12	添付書類V-2-1-11	
<p>5.1.5 許容限界</p> <p>b. 機器・配管系</p> <p>(a) Sクラスの機器・配管系</p> <p>イ. 基準地震動S_sによる地震力との組合せに対する許容限界</p> <p>塑性域に達するひずみが生じる場合であっても、その量が小さなレベルに留まって破断延性限界に十分な余裕を有し、その施設の機能に影響を及ぼすことがない限度に応力、荷重を制限する値を許容限界とする。</p> <p>ロ. 弾性設計用地震動S_dによる地震力又は静的地震力との組合せに対する許容限界</p> <p>発生する応力に対して、応答が全体的におおむね弾性状態に留まるように、降伏応力又はこれと同等の安全性を有する応力を許容限界とする。</p> <p>(b) Bクラス及びCクラスの機器・配管系</p> <p>上記b.(a)ロ.による応力を許容限界とする。</p>	<p>(4) 基礎の設計</p> <p>a. 設計方針</p> <p>電気計測制御装置等の基礎は、支持構造物から加わる自重及び地震荷重に対し、有効な支持機能を有するよう設計する。基礎の選定は、電気計測制御装置等の支持方法、支持荷重及び配置を考慮して行う。</p> <p>b. 荷重条件</p> <p>基礎の設計は、電気計測制御装置等から伝わる荷重に対し、荷重成分の組合せを考慮して行う。荷重の種類及び組合せについては、「IV-1-1-8 機能維持の基本方針」に従う。</p> <p>3. 電気計測制御装置等の耐震設計方針</p> <p>3.1 概要</p> <p>本方針は、電気計測制御装置等の耐震設計の基本方針を示すものである。</p> <p>3.2 耐震設計の範囲</p> <p><u>電気計測制御装置等の区分及び適用範囲を第3.2-1表に示すとおりとし、安全機能を有する施設のうち耐震重要度Sクラスの電気計測制御装置等に該当する電気計測制御装置等を対象とする。</u></p> <p>なお、耐震重要度Sクラスの電気計測制御装置等が下位クラスの電気計測制御装置等による波及的影響によって、安全機能を損なわないように設計する。</p> <p><u>重大事故等対処施設の設計方針については、重大事故等対処施設の申請に合わせて次回以降に詳細を説明する。</u></p>	<p>(4) 基礎の設計</p> <p>a. 設計方針</p> <p>電気計測制御装置の基礎は、支持構造物から加わる自重、地震荷重に対し、有効な支持機能を有するよう設計する。基礎の選定は、電気計測制御装置の支持方法、支持荷重及び配置を考慮して行う。</p> <p>b. 荷重条件</p> <p>基礎の設計は、電気計測制御装置から伝わる荷重に対し、荷重成分の組合せを考慮して行う。荷重の種類及び組合せについては、添付書類「V-2-1-9 機能維持の基本方針」に従う。</p> <p>別紙1 電気計測制御装置等の耐震設計方針</p> <p>1. 概要</p> <p>本方針は、電気計測制御装置等（以下「電気計装品」という。）の耐震設計の基本方針を示すものである。</p> <p>2. 耐震設計の範囲</p> <p>電気計装品の区分及び適用範囲を表2-1に示すとおりとし、設計基準対象施設のうち耐震Sクラスの電気計装品及び重大事故等対処施設のうち常設耐震重要重大事故防止設備または常設重大事故緩和設備に該当する電気計装品を対象とする。</p> <p>なお、耐震Sクラスの電気計装品及び重大事故等対処施設のうち常設耐震重要重大事故防止設備及び常設重大事故緩和設備の電気計装品が、下位クラスの電気計装品による波及的影響によって、それぞれの安全機能及び重大事故等に対処するために必要な機能を損なわないように設計する。</p>	<p>・重大事故等対処施設の内容については、後次回で比較結果を示す。</p> <p>・重大事故等対処施設の内容については、後次回で比較結果を示す。</p>

再処理施設	発電炉	備考																																									
添付書類IV-1-1	添付書類IV-1-1-12	添付書類V-2-1-11																																									
	<p>第3.2-1表 電気計測制御装置等の区分及び適用範囲</p> <table border="1"> <thead> <tr> <th>区分</th> <th>定義</th> <th>適用範囲</th> <th>対象</th> </tr> </thead> <tbody> <tr> <td>1. 盤</td> <td>電気計測制御装置等の一部で、銅材、銅板等によって作られた構造物で器具、ケーブル等を含み、電気系、計装系の信号の処理、制御及び操作系の保護、閉閉並びに電力の変換等の機能をもつているものをいう。</td> <td>盤本体の他にチャンネルベース、盤とチャンネルベース取付ボルト及び基礎ボルトまで含む。</td> <td>中央制御盤類、閉鎖配電盤、パワースタ、コントロールセンター、計装ラック、現場操作盤、静止形インバータ、蓄電池用充電器等</td> </tr> <tr> <td>2. 装置</td> <td>電力の変換、あるいはエネルギーの変換を目的とした電気計測制御装置等の一部をいう。</td> <td>ディーゼル発電機は発電機本体及び基礎ボルトを含む。 蓄電池は接続導体、架台及び基礎ボルトまで含む。</td> <td>変圧器、ディーゼル発電機、電動機、電動発電機、蓄電池等</td> </tr> <tr> <td>3. 器具</td> <td>電気計測制御装置等において取扱われる信号又は電力に対し、検出、変換、演算、制御等の操作を行い、電気系、計装系の機能を作り出す要素をいう。これらは盤類に取付けられ、あるいは所定の取付場所に設置される。</td> <td>発信器、検出器等のように計装配管に取り付けられたり、現場に支持金物で据え付けられるものはその取付金物まで含む。</td> <td>各種検出器、発信器、保護継電器、各種継電器、演算器、スイッチ、遮断器、指示計、計器用変成器、変流器等</td> </tr> <tr> <td>4. 回路類</td> <td>電線、ケーブル、導体等の形で電流が通じている回路が、銅板その他の材料で構成された支持及び保護の役目をする構造物に取納されている場合、その構造物及び電気回路を含めて回路類という。</td> <td>ケーブルトレイ、バスダクト、電線管等の支持構造物及び埋込金物を含む。 計装配管は止め弁以降の計装配管、支持構造物及び埋込金物を含む。</td> <td>ケーブルトレイ、バスダクト、電線管、ケーブルベネトレーション、計装配管等</td> </tr> </tbody> </table>	区分	定義	適用範囲	対象	1. 盤	電気計測制御装置等の一部で、銅材、銅板等によって作られた構造物で器具、ケーブル等を含み、電気系、計装系の信号の処理、制御及び操作系の保護、閉閉並びに電力の変換等の機能をもつているものをいう。	盤本体の他にチャンネルベース、盤とチャンネルベース取付ボルト及び基礎ボルトまで含む。	中央制御盤類、閉鎖配電盤、パワースタ、コントロールセンター、計装ラック、現場操作盤、静止形インバータ、蓄電池用充電器等	2. 装置	電力の変換、あるいはエネルギーの変換を目的とした電気計測制御装置等の一部をいう。	ディーゼル発電機は発電機本体及び基礎ボルトを含む。 蓄電池は接続導体、架台及び基礎ボルトまで含む。	変圧器、ディーゼル発電機、電動機、電動発電機、蓄電池等	3. 器具	電気計測制御装置等において取扱われる信号又は電力に対し、検出、変換、演算、制御等の操作を行い、電気系、計装系の機能を作り出す要素をいう。これらは盤類に取付けられ、あるいは所定の取付場所に設置される。	発信器、検出器等のように計装配管に取り付けられたり、現場に支持金物で据え付けられるものはその取付金物まで含む。	各種検出器、発信器、保護継電器、各種継電器、演算器、スイッチ、遮断器、指示計、計器用変成器、変流器等	4. 回路類	電線、ケーブル、導体等の形で電流が通じている回路が、銅板その他の材料で構成された支持及び保護の役目をする構造物に取納されている場合、その構造物及び電気回路を含めて回路類という。	ケーブルトレイ、バスダクト、電線管等の支持構造物及び埋込金物を含む。 計装配管は止め弁以降の計装配管、支持構造物及び埋込金物を含む。	ケーブルトレイ、バスダクト、電線管、ケーブルベネトレーション、計装配管等	<p>表2-1 電気計装品の区分及び適用範囲</p> <table border="1"> <thead> <tr> <th>区分</th> <th>定義</th> <th>適用範囲</th> <th>対象</th> </tr> </thead> <tbody> <tr> <td>1. 盤</td> <td>電気計装品の一部で、銅材、銅板等によって作られた構造物で器具、ケーブル等を含み、電気系、計装系の信号の処理、制御及び操作系の保護、閉閉並びに電力の変換等の機能をもつているものをいう。</td> <td>盤本体の他にチャンネルベース、盤とチャンネルベース取付ボルト及び基礎ボルトまで含む。</td> <td>中央制御盤類、閉鎖配電盤、パワースタ、コントロールセンター、計装ラック、現場操作盤、静止形インバータ、蓄電池用充電器等</td> </tr> <tr> <td>2. 装置</td> <td>電力の変換、あるいはエネルギーの変換を目的とした電気計装品の一部をいう。</td> <td>ディーゼル発電機は発電機本体及び基礎ボルトを含む。 蓄電池は接続導体、架台及び基礎ボルトまで含む。</td> <td>変圧器、ディーゼル発電機、補機用電動機、電動発電機、蓄電池等</td> </tr> <tr> <td>3. 器具</td> <td>電気計装品において取扱われる信号又は電力に対し、検出、変換、演算、制御等の操作を行い、電気系、計装系の機能を作り出す要素をいう。これらは盤類に取付けられ、あるいは所定の取付場所に設置される。</td> <td>発信器、検出器等のように計装配管に取り付けられたり、現場に支持金物で据え付けられるものはその取付金物まで含む。</td> <td>各種検出器、発信器、保護継電器、制御継電器、演算器、スイッチ、遮断器、指示計、計器用変成器、変流器等</td> </tr> <tr> <td>4. 回路類</td> <td>電線、ケーブル、導体等の形で電流が通じている回路が、銅板その他の材料で構成された支持及び保護の役目をする構造物に取納されている場合、その構造物及び電気回路を含めて回路類という。</td> <td>ケーブルトレイ、バスダクト、電線管等の支持構造物及び埋込金物を含む。 計装配管は、止め弁以降の計装配管、支持構造物及び埋込金物を含む。</td> <td>ケーブルトレイ、バスダクト、電線管、ケーブルベネトレーション、計装配管等</td> </tr> </tbody> </table>	区分	定義	適用範囲	対象	1. 盤	電気計装品の一部で、銅材、銅板等によって作られた構造物で器具、ケーブル等を含み、電気系、計装系の信号の処理、制御及び操作系の保護、閉閉並びに電力の変換等の機能をもつているものをいう。	盤本体の他にチャンネルベース、盤とチャンネルベース取付ボルト及び基礎ボルトまで含む。	中央制御盤類、閉鎖配電盤、パワースタ、コントロールセンター、計装ラック、現場操作盤、静止形インバータ、蓄電池用充電器等	2. 装置	電力の変換、あるいはエネルギーの変換を目的とした電気計装品の一部をいう。	ディーゼル発電機は発電機本体及び基礎ボルトを含む。 蓄電池は接続導体、架台及び基礎ボルトまで含む。	変圧器、ディーゼル発電機、補機用電動機、電動発電機、蓄電池等	3. 器具	電気計装品において取扱われる信号又は電力に対し、検出、変換、演算、制御等の操作を行い、電気系、計装系の機能を作り出す要素をいう。これらは盤類に取付けられ、あるいは所定の取付場所に設置される。	発信器、検出器等のように計装配管に取り付けられたり、現場に支持金物で据え付けられるものはその取付金物まで含む。	各種検出器、発信器、保護継電器、制御継電器、演算器、スイッチ、遮断器、指示計、計器用変成器、変流器等	4. 回路類	電線、ケーブル、導体等の形で電流が通じている回路が、銅板その他の材料で構成された支持及び保護の役目をする構造物に取納されている場合、その構造物及び電気回路を含めて回路類という。	ケーブルトレイ、バスダクト、電線管等の支持構造物及び埋込金物を含む。 計装配管は、止め弁以降の計装配管、支持構造物及び埋込金物を含む。	ケーブルトレイ、バスダクト、電線管、ケーブルベネトレーション、計装配管等	<p>・再処理施設においては、機器を主要機器と補機とに区別していないことから、記載の差異により新たな論点が生じるものではない。</p>
区分	定義	適用範囲	対象																																								
1. 盤	電気計測制御装置等の一部で、銅材、銅板等によって作られた構造物で器具、ケーブル等を含み、電気系、計装系の信号の処理、制御及び操作系の保護、閉閉並びに電力の変換等の機能をもつているものをいう。	盤本体の他にチャンネルベース、盤とチャンネルベース取付ボルト及び基礎ボルトまで含む。	中央制御盤類、閉鎖配電盤、パワースタ、コントロールセンター、計装ラック、現場操作盤、静止形インバータ、蓄電池用充電器等																																								
2. 装置	電力の変換、あるいはエネルギーの変換を目的とした電気計測制御装置等の一部をいう。	ディーゼル発電機は発電機本体及び基礎ボルトを含む。 蓄電池は接続導体、架台及び基礎ボルトまで含む。	変圧器、ディーゼル発電機、電動機、電動発電機、蓄電池等																																								
3. 器具	電気計測制御装置等において取扱われる信号又は電力に対し、検出、変換、演算、制御等の操作を行い、電気系、計装系の機能を作り出す要素をいう。これらは盤類に取付けられ、あるいは所定の取付場所に設置される。	発信器、検出器等のように計装配管に取り付けられたり、現場に支持金物で据え付けられるものはその取付金物まで含む。	各種検出器、発信器、保護継電器、各種継電器、演算器、スイッチ、遮断器、指示計、計器用変成器、変流器等																																								
4. 回路類	電線、ケーブル、導体等の形で電流が通じている回路が、銅板その他の材料で構成された支持及び保護の役目をする構造物に取納されている場合、その構造物及び電気回路を含めて回路類という。	ケーブルトレイ、バスダクト、電線管等の支持構造物及び埋込金物を含む。 計装配管は止め弁以降の計装配管、支持構造物及び埋込金物を含む。	ケーブルトレイ、バスダクト、電線管、ケーブルベネトレーション、計装配管等																																								
区分	定義	適用範囲	対象																																								
1. 盤	電気計装品の一部で、銅材、銅板等によって作られた構造物で器具、ケーブル等を含み、電気系、計装系の信号の処理、制御及び操作系の保護、閉閉並びに電力の変換等の機能をもつているものをいう。	盤本体の他にチャンネルベース、盤とチャンネルベース取付ボルト及び基礎ボルトまで含む。	中央制御盤類、閉鎖配電盤、パワースタ、コントロールセンター、計装ラック、現場操作盤、静止形インバータ、蓄電池用充電器等																																								
2. 装置	電力の変換、あるいはエネルギーの変換を目的とした電気計装品の一部をいう。	ディーゼル発電機は発電機本体及び基礎ボルトを含む。 蓄電池は接続導体、架台及び基礎ボルトまで含む。	変圧器、ディーゼル発電機、補機用電動機、電動発電機、蓄電池等																																								
3. 器具	電気計装品において取扱われる信号又は電力に対し、検出、変換、演算、制御等の操作を行い、電気系、計装系の機能を作り出す要素をいう。これらは盤類に取付けられ、あるいは所定の取付場所に設置される。	発信器、検出器等のように計装配管に取り付けられたり、現場に支持金物で据え付けられるものはその取付金物まで含む。	各種検出器、発信器、保護継電器、制御継電器、演算器、スイッチ、遮断器、指示計、計器用変成器、変流器等																																								
4. 回路類	電線、ケーブル、導体等の形で電流が通じている回路が、銅板その他の材料で構成された支持及び保護の役目をする構造物に取納されている場合、その構造物及び電気回路を含めて回路類という。	ケーブルトレイ、バスダクト、電線管等の支持構造物及び埋込金物を含む。 計装配管は、止め弁以降の計装配管、支持構造物及び埋込金物を含む。	ケーブルトレイ、バスダクト、電線管、ケーブルベネトレーション、計装配管等																																								

再処理施設		発電炉	備考
添付書類IV-1-1	添付書類IV-1-1-12	添付書類V-2-1-11	
<p>5.2 機能維持 (2) 機器・配管系 a. 安全機能を有する施設 (b) 電氣的機能維持 電氣的機能が要求される設備は、地震時及び地震後において、その設備に要求される安全機能を維持するため、安全機能を有する施設の耐震重要度に応じた地震動に対して、要求される電氣的機能が維持できることを実証試験又は解析により確認することで、電氣的機能を維持する設計とする。</p>	<p>3.3 耐震設計の手順 具体的な手順は、構造上及び機能上の性質により異なるので、<u>電気計測制御装置等を盤、装置、器具及び電路類の4種類に大別し、以下各々についてその手順を示す。</u></p> <p>3.3.1 盤の耐震設計手順 盤は、多種多様の器具を収納する集合体であるので、構造的及び機能的に設計地震力に対して健全でなければならない。 解析モデル化が可能で解析が容易である場合は「振動特性解析による方法」を採用し、解析モデル化が不可能な場合又は解析モデル化が可能であっても実験によって耐震性を検定するのが容易な場合は、「振動特性試験による方法」を採用する。</p> <p>振動特性解析又は振動特性試験によって剛構造かどうかを判定し、剛構造であれば静的解析により構造及び機能的健全性を確認する。剛構造でない場合は、応答解析又は応答試験を実施する。</p> <p>応答試験による場合は、取り付けられる器具を実装して行うことが容易な場合には、実装集合体応答試験により構造的及び機能的健全性を確認する。 また、器具を実装して行うことが困難な場合には物理的及び構造的に実物を模擬したものを取り付けられた模擬集合体応答試験を行い構造的健全性を確認するとともに、模擬器具取付点の応答を測定し、器具の単体で検定された検定スペクトルと比較することにより機能的健全性を確認する。 応答解析による場合は、解析により構造的健全性を確認するとともに器具の取付点の応答と器具単体で得られた検定スペクトルとを比較することにより、機能的健全性を確認する。 第3.3.1-1図に盤の耐震設計フローチャートを示す。</p>	<p>3. 耐震設計の手順 具体的な手順は、構造上及び機能上の性質により異なるので、電気計測装置を盤、装置、器具及び電路類の4種類に大別し、以下各々についてその手順を示す。</p> <p>3.1 盤の耐震設計手順 (図3-1 参照) 盤は、多種多様の器具を収納する集合体であるので、構造的、機能的に設計地震力に対して健全でなければならない。 解析モデル化が可能で解析が容易である場合は「振動特性解析による方法」を採用し、解析モデル化が不可能な場合若しくは解析モデル化が可能であっても実験によって耐震性を検定するのが容易な場合は、「振動特性試験による方法」を採用する。</p> <p>振動特性解析又は振動特性試験によって剛構造かどうかを判定し、剛構造であれば静的解析により構造的及び機能的健全性を確認する。剛構造でない場合は、応答解析又は応答試験を実施する。</p> <p>応答試験による場合は、取り付けられる器具を実装して行うことが容易な場合には、実装集合体応答試験により構造的及び機能的健全性を確認する。 また、器具を実装して行うことが困難な場合には物理的、構造的に実物を模擬したものを取り付けられた模擬集合体応答試験を行い構造的健全性を確認するとともに、模擬器具取付点の応答を測定し、器具の単体で検定された検定スペクトルと比較することにより機能的健全性を確認する。</p> <p>応答解析による場合は、解析により構造的健全性を確認するとともに器具の取付点の応答と器具単体で得られた検定スペクトルとを比較することにより、機能的健全性を確認する。</p>	

再処理施設	発電炉	備考
添付書類IV-1-1	添付書類V-2-1-11	添付書類IV-1-1-12
	<p>①②: 第 3.3.3-1 図 器具の耐震設計フローチャート参照</p> <p>第 3.3.1-1 図 盤の耐震設計フローチャート</p>	<p>① ②: 図 3-3 器具の耐震設計フローチャート参照</p> <p>図 3-1 盤の耐震設計フローチャート</p>

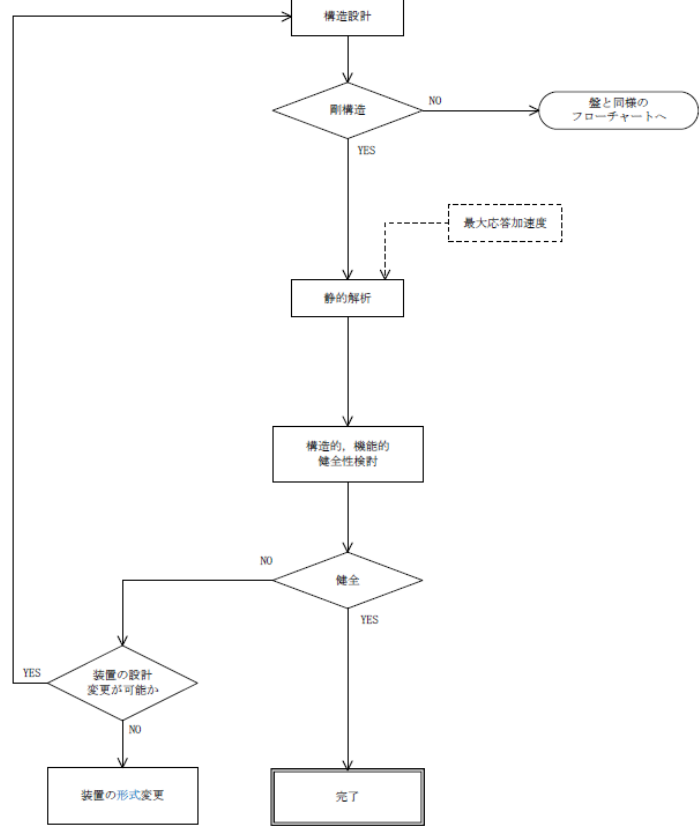
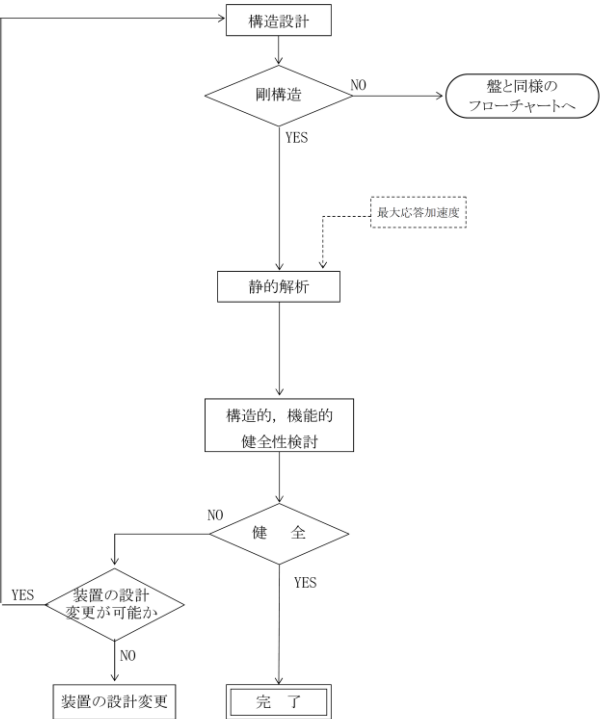
再処理施設	発電炉	備考
添付書類IV-1-1	添付書類V-2-1-11	
	<p>3.3.2 装置の耐震設計手順 装置は、一般的に剛構造であり、その機能は、構造的健全性が保たれている限り失われることはない。したがって、耐震性の検討は、静的解析を行って構造的健全性を確かめる。 ただし、剛構造でない場合は、盤と同様に応答解析又は応答試験によって構造的健全性を確認する。 第3.3.2-1図に装置の耐震設計フローチャートを示す。</p>  <p>第3.3.2-1図 装置の耐震設計フローチャート</p>	<p>3.2 装置の耐震設計手順 (図3-2 参照) 装置は、一般に剛な構造であり、その機能は、構造的健全性が保たれている限り失われることはない。したがって、耐震性の検討は、静的解析を行って構造的健全性を確かめる。 ただし、剛構造でない場合は、盤と同様に応答解析又は応答試験によって構造的健全性を確認する。</p>  <p>図3-2 装置の耐震設計フローチャート</p>

再処理施設	発電炉	備考
添付書類IV-1-1	添付書類V-2-1-11	
	<p>3.3.3 器具の耐震設計手順 器具の耐震性の検討は、構造及び機能の両面について行う。</p> <p>器具は、構造的及び機能的健全性を保持し得る限界入力又は許容入力値を求める一般検定試験(又は限界性能試験)を行い、検定スペクトルを求め、これと取付け位置の応答とを比較することにより耐震性を判定する。</p> <p>一般検定試験を行えない場合は、器具取付け位置の動的入力によって応答試験を行うことにより耐震性を判定する。</p> <p>器具の中で、計器用変成器等のように剛体と見なせるものであって構造的に健全であれば、その機能が維持されるものについては装置と同様に静的解析を行って構造的健全性を確認する。</p> <p>第3.3.3-1図に器具の耐震設計フローチャートを示す。</p> <p>第 3.3.3-1 図 器具の耐震設計フローチャート</p>	<p>3.3 器具の耐震設計手順 (図3-3 参照) 器具の耐震性の検討は、構造、機能の両面について行う。</p> <p>器具は、構造的及び機能的健全性を保持し得る限界入力、又は許容入力値を求める一般検定試験(又は限界性能試験)を行い、検定スペクトルを求め、これと取付け位置の応答とを比較することにより耐震性を判定する。</p> <p>一般検定試験を行えない場合は、器具取付け位置の動的入力によって応答試験を行うことにより耐震性を判定する。</p> <p>器具の中で、計器用変成器等のように剛体と見なせるものであって構造的に健全であれば、その機能が維持されるものについては装置と同様に静的解析を行って構造的健全性を確認する。</p> <p>図 3-3 器具の耐震設計フローチャート</p>

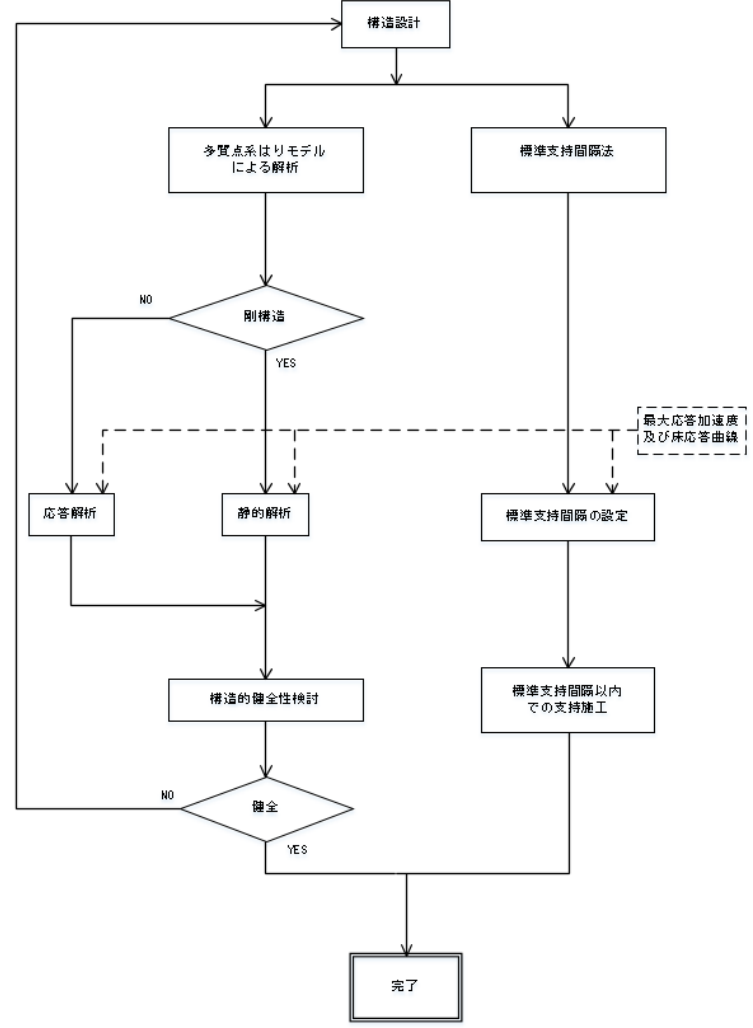
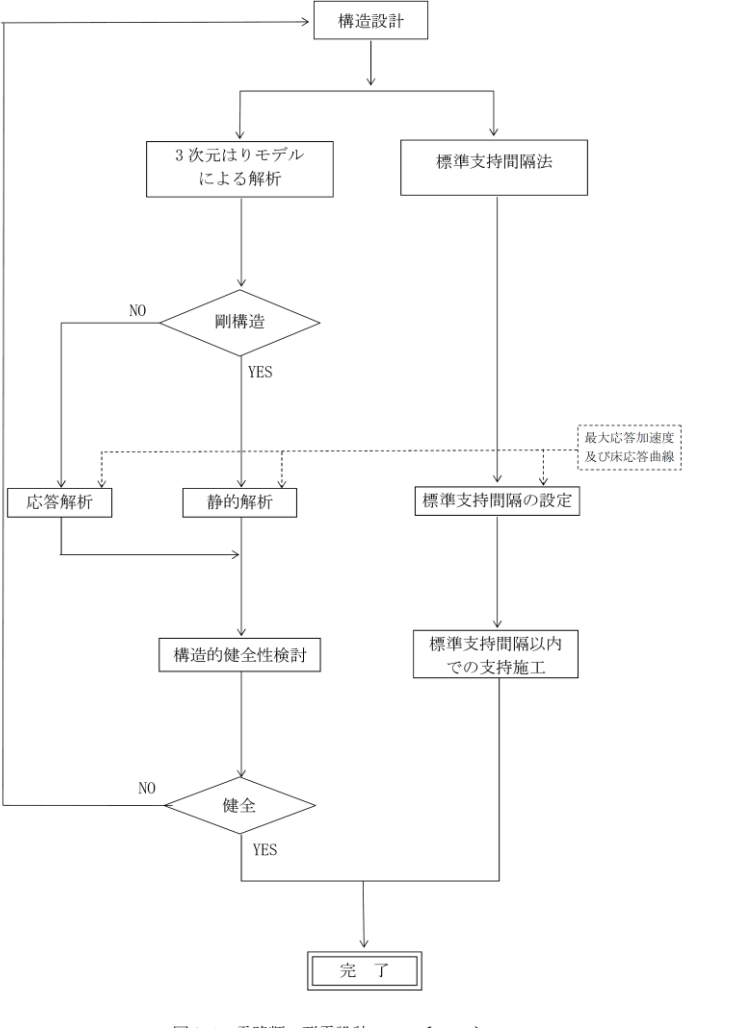
再処理施設	発電炉	備考
添付書類IV-1-1	添付書類IV-1-1-12	添付書類V-2-1-11
	<p>3.3.4 電路類の耐震設計手順</p> <p>電路類は、構造的に健全ならば機能が維持されるので構造的検討のみを行う。この際には多質点系はりモデルによる解析又は標準支持間隔法を用いる。多質点系はりモデルによる解析の場合は、固有振動数に応じて応答解析による方法又は静的解析による方法を用いて構造的健全性を確認する方針とする。</p> <p>また、標準支持間隔法を用いる場合は、<u>静的又は動的地震力による応力</u>が許容応力以下となる標準支持間隔を設定し、標準支持間隔以内で支持することにより耐震性を確保する。</p> <p>第3.3.4-1図に電路類の耐震設計フローチャートを示す。</p> <p>また各建屋間、建屋と建屋外地盤とにまたがって設置されるものについては、それらの地震時の相対変位を吸収できる構造とする。</p> <p>熱膨張等を考慮しなければならないものについては、その荷重に対して構造的健全性を確認する方針とする。</p>  <p>第3.3.4-1図 電路類の耐震設計フローチャート</p>	<p>3.4 電路類の耐震設計手順 (図3-4 参照)</p> <p>電路類は、構造的に健全ならば機能が維持されるので構造的検討のみを行う。この際には3次元はりモデルによる解析又は標準支持間隔法を用いる。3次元はりモデルによる解析の場合は、固有振動数に応じて応答解析による方法、又は静的解析による方法を用いて構造的健全性を確認する方針とする。</p> <p>また、標準支持間隔法を用いる場合は、<u>振動数基準による標準支持間隔法</u>を基本として標準支持間隔を設定し、標準支持間隔以内で支持することにより耐震性を確保する。</p> <p>また、各建物間、建物と建物外地盤とにまたがって設置されるものについては、それらの地震時の相対変位を吸収できる構造とする。</p> <p>熱膨張等を考慮しなければならないものについては、その荷重に対して構造的健全性を確認する方針とする。</p>  <p>図3-4 電路類の耐震設計フローチャート</p>
<ul style="list-style-type: none"> 再処理施設における標準支持間隔法による支持間隔の設定は、配管と同様に応力基準により算出していることから、記載の差異により新たな論点が生じるものではない。 本内容については、補足説明資料「【耐震機電16】配管系の評価手法(定ピッチスパン法)について」に示す。 		

再処理施設		発電炉	備考
添付書類IV-1-1	添付書類IV-1-1-12	添付書類V-2-1-11	
	<p>3.3.5 既存資料の利用による耐震設計</p> <p>電気計測制御装置等の耐震設計は、既に振動実験又は解析が行われており、かつ、その電気計測制御装置等が本再処理施設に使用されるものと同等又は類似と判断される場合には、その実験データ又は解析値を利用して耐震設計を行う。</p>	<p>3.5 既存資料の利用による耐震設計</p> <p>電気計装品の耐震設計は、既に振動実験若しくは解析が行われており、かつ、その電気計装品が本原子力発電所に使用されるものと同等又は類似と判断される場合には、その実験データ若しくは解析値を利用して耐震設計を行う。</p>	

別紙 4－14

地震時の臨界安全性検討方針

※本資料は設備の申請に合わせて次回以降に追加する

【凡例】

下線：

- ・プラントの違いによらない記載内容の差異
- ・章立ての違いによる記載位置の違いによる差異

二重下線：

- ・プラント固有の事項による記載内容の差異
- ・後次回の申請範囲に伴う差異

別紙4－15

波及的影響を及ぼすおそれのある 下位クラス施設の耐震評価方針

【凡例】

下線：

- ・プラントの違いによらない記載内容の差異
- ・章立ての違いによる記載位置の違いによる差異

二重下線：

- ・プラント固有の事項による記載内容の差異
- ・後次回の申請範囲に伴う差異

【IV-2-2-1 波及的影響を及ぼすおそれのある下位クラス施設の耐震評価方針】(1/13)

再処理施設		発電炉	備考
添付書類IV-1-1-4	添付書類IV-2-2-1	添付書類V-2-11-1	
	IV-2-2-1 波及的影響を及ぼすおそれのある下位クラス施設の耐震評価方針 目次 1. 概要 2. 基本方針 3. 耐震評価方針 3.1 耐震評価部位 3.2 地震応答解析 3.3 設計用地震動又は地震力 3.4 荷重の種類及び荷重の組合せ 3.5 許容限界 3.6 まとめ	V-2-11-1 波及的影響を及ぼすおそれのある下位クラス施設の耐震評価方針 目次 1. 概要 2. 基本方針 3. 耐震評価方針 3.1 耐震評価部位 3.2 地震応答解析 3.3 設計用地震動又は地震力 3.4 荷重の種類及び荷重の組合せ 3.5 許容限界 3.6 まとめ	

【IV-2-2-1 波及的影響を及ぼすおそれのある下位クラス施設の耐震評価方針】(2/13)

再処理施設	発電炉	備考												
添付書類IV-1-1-4	添付書類IV-2-2-1	添付書類V-2-11-1												
<p>5. 波及的影響の設計対象とする下位クラス施設の耐震設計方針</p> <p>「4. 波及的影響の設計対象とする下位クラス施設」において選定した施設の耐震設計方針を以下に示す。</p> <p>5.1 耐震評価部位</p> <p>波及的影響の設計対象とする下位クラス施設の評価対象部位は、それぞれの損傷モードに応じて選定する。</p> <p>すなわち、評価対象下位クラス施設の不等沈下、相対変位、接続部における相互影響、損傷、転倒及び落下を防止するよう、主要構造部材、支持部及び固定部等を対象とする。</p> <p>また、地盤の不等沈下又は下位クラス施設の転倒を想定して設計する施設については、上位クラス施設の機能に影響がないよう評価部位を選定する。</p> <p>各施設の耐震評価部位は、「IV-2-2-1 波及的影響を及ぼすおそれのある下位クラス施設の耐震評価方針」の「3.1 耐震評価部位」に示す。</p> <p>5.2 地震応答解析</p> <p>波及的影響の設計対象とする下位クラス施設の耐震設計において実施する地震応答解析については、「IV-1-1 耐震設計の基本方針」の「10. 耐震計算の基本方針」に従い、既設工認で実績があり、かつ最新の知見に照らしても妥当な手法及び条件を基本として行う。また、周辺地盤の液状化のおそれのある施設は、その周辺地盤の液状化による影響を考慮する。</p> <p>各施設の設計に適用する地震応答解析は、「IV-2-2-1 波及的影響を及ぼすおそれのある下位クラス施設の耐震評価方針」の「3.2 地震応答解析」に示す。</p> <p>5.3 設計用地震動又は地震力</p> <p>波及的影響の設計対象とする下位クラス施設においては、上位クラス施設の設計に用いる地震動又は地震力を適用する。</p> <p>各施設の設計に適用する地震動又は地震力は、「IV-2-2-1 波及的影響を及ぼすおそれのある下位クラス施設の耐震評価方針」の「3.3 設計用地震動又は地震力」に示す。</p> <p>5.4 荷重の種類及び荷重の組合せ</p> <p>波及的影響の防止を目的とした設計において用いる荷重の種類及び荷重の組合せについては、波及的影響を受けるおそれのある上位クラス施設と同じ運転状態において下位クラス施設に発生する荷重を組み合わせる。</p> <p>また、地盤の不等沈下又は転倒を想定し、上位クラス施設の機能に影響がないよう設計する場合は、転倒等に伴い発生する荷重を組み合わせる。</p> <p>なお、上位クラス施設に再処理施設内にある施設(安全機能を有する施設以外の施設及び資機材等含む)を設置する場合は、その施設の荷重も考慮する。</p> <p>荷重の設定においては、実運用・実事象上定まる範囲を考慮して設定する。</p>	<p>1. 概要</p> <p>本資料は、安全機能を有する施設を設計する際に、「IV-1-1-4 波及的影響に係る基本方針」の「4. 波及的影響の設計対象とする下位クラス施設」にて選定した波及的影響の設計対象とする下位クラス施設の耐震評価方針を説明するものである。</p> <p>2. 基本方針</p> <p>波及的影響の設計対象とする下位クラス施設は、「IV-1-1-4 波及的影響に係る基本方針」の「5. 波及的影響の設計対象とする下位クラス施設の耐震設計方針」に基づき、以下「3. 耐震評価方針」に示すとおり、耐震評価部位、地震応答解析、設計用地震動又は地震力、荷重の種類及び荷重の組合せ並びに許容限界を定めて耐震評価を実施する。</p> <p>この耐震評価を実施するものとして、「IV-1-1-4 波及的影響に係る基本方針」の「4. 波及的影響の設計対象とする下位クラス施設」にて選定した波及的影響の設計対象とする下位クラス施設を第2-1表に示す。</p> <table border="1" data-bbox="991 1234 1685 1436"> <caption>第2-1表 波及的影響の設計対象とする下位クラス施設</caption> <thead> <tr> <th>分類</th> <th>波及的影響の設計対象とする下位クラス施設</th> </tr> </thead> <tbody> <tr> <td>建物・構築物</td> <td>飛来物防護ネット(再処理設備本体用 安全冷却水系冷却塔B)</td> </tr> </tbody> </table>	分類	波及的影響の設計対象とする下位クラス施設	建物・構築物	飛来物防護ネット(再処理設備本体用 安全冷却水系冷却塔B)	<p>1. 概要</p> <p>本資料は、設計基準対象施設及び重大事故等対処施設を設計する際に、添付書類「V-2-1-5 波及的影響に係る基本方針」の「4. 波及的影響の設計対象とする下位クラス施設」にて選定した波及的影響の設計対象とする下位クラス施設の耐震評価方針を説明するものである。</p> <p>2. 基本方針</p> <p>波及的影響の設計対象とする下位クラス施設は、添付書類「V-2-1-5 波及的影響に係る基本方針」の「5. 波及的影響の設計対象とする下位クラス施設の耐震設計方針」に基づき、以下「3. 耐震評価方針」に示すとおり、耐震評価部位、地震応答解析、設計用地震動又は地震力、荷重の種類及び荷重の組合せ並びに許容限界を定めて耐震評価を実施する。</p> <p>この耐震評価を実施するものとして、添付書類「V-2-1-5 波及的影響に係る基本方針」の「4. 波及的影響の設計対象とする下位クラス施設」にて選定した波及的影響の設計対象とする下位クラス施設を、<u>建物・構築物及び機器・配管系に分けて表2-1に示す。</u></p> <table border="1" data-bbox="1783 1234 2309 1717"> <caption>表2-1 波及的影響の設計対象とする下位クラス施設</caption> <thead> <tr> <th colspan="2">下位クラス施設</th> </tr> </thead> <tbody> <tr> <td>建物・構築物</td> <td>タービン建屋 サービス建屋 使用済燃料乾式貯蔵建屋上屋</td> </tr> <tr> <td>機器・配管系</td> <td>燃料取替機 原子炉建屋クレーン 使用済燃料乾式貯蔵建屋天井クレーン チャンネル着脱機 原子炉遮蔽 原子炉ウエル遮蔽ブロック 制御棒貯蔵ラック 制御棒貯蔵ハンガ ウォータレグシールライン(残留熱除去系、高圧炉心スプレイ系及び低圧炉心スプレイ系) 格納容器機器ドレンサンブ 海水ポンプエリア電巻防護対策施設 中央制御室天井照明 耐火障壁 原子炉建屋外側ブローアウトパネル防護対策施設</td> </tr> <tr> <td>土木構造物</td> <td>土留鋼管矢板</td> </tr> </tbody> </table> <p>・ 重大事故等対処施設については後次回で比較結果を示す。</p> <p>・ 後次回申請以降の機器・配管系の申請時に分類を示す。</p>	下位クラス施設		建物・構築物	タービン建屋 サービス建屋 使用済燃料乾式貯蔵建屋上屋	機器・配管系	燃料取替機 原子炉建屋クレーン 使用済燃料乾式貯蔵建屋天井クレーン チャンネル着脱機 原子炉遮蔽 原子炉ウエル遮蔽ブロック 制御棒貯蔵ラック 制御棒貯蔵ハンガ ウォータレグシールライン(残留熱除去系、高圧炉心スプレイ系及び低圧炉心スプレイ系) 格納容器機器ドレンサンブ 海水ポンプエリア電巻防護対策施設 中央制御室天井照明 耐火障壁 原子炉建屋外側ブローアウトパネル防護対策施設	土木構造物	土留鋼管矢板
分類	波及的影響の設計対象とする下位クラス施設													
建物・構築物	飛来物防護ネット(再処理設備本体用 安全冷却水系冷却塔B)													
下位クラス施設														
建物・構築物	タービン建屋 サービス建屋 使用済燃料乾式貯蔵建屋上屋													
機器・配管系	燃料取替機 原子炉建屋クレーン 使用済燃料乾式貯蔵建屋天井クレーン チャンネル着脱機 原子炉遮蔽 原子炉ウエル遮蔽ブロック 制御棒貯蔵ラック 制御棒貯蔵ハンガ ウォータレグシールライン(残留熱除去系、高圧炉心スプレイ系及び低圧炉心スプレイ系) 格納容器機器ドレンサンブ 海水ポンプエリア電巻防護対策施設 中央制御室天井照明 耐火障壁 原子炉建屋外側ブローアウトパネル防護対策施設													
土木構造物	土留鋼管矢板													

【IV-2-2-1 波及的影響を及ぼすおそれのある下位クラス施設の耐震評価方針】(3/13)

再処理施設	再処理施設	発電炉	備考
添付書類IV-1-1-4	添付書類IV-2-2-1	添付書類V-2-11-1	
<p>各施設の設計に適用する荷重の種類及び組み合わせは、「IV-2-2-1 波及的影響を及ぼすおそれのある下位クラス施設の耐震評価方針」の「3.4 荷重の種類及び荷重の組合せ」に示す。</p>	<p>3. 耐震評価方針</p> <p>3.1 耐震評価部位</p> <p>耐震評価部位については、対象設備の構造及び波及的影響の観点から考慮し、JEAG4601を含む工事計画での実績を参照した上で、耐震評価上厳しい箇所を選定する。</p> <p>3.1.1 不等沈下又は相対変位の観点</p> <p>(1) 地盤の不等沈下による影響</p> <p><u>地盤の不等沈下による影響については、「IV-1-1-4 波及的影響に係る基本方針」の「4.1 不等沈下又は相対変位の観点」に示すように、地盤の不等沈下による波及的影響の設計対象として選定する下位クラス施設はなく、安全冷却水B冷却塔並びに安全冷却水B冷却塔まわりの配管及び弁に対して波及的影響を及ぼす下位クラス施設はない。</u></p> <p>(2) 建屋間の相対変位による影響</p> <p>a. <u>安全冷却水B冷却塔、安全冷却水B冷却塔まわりの配管及び弁並びに飛来物防護ネット(再処理設備本体用 安全冷却水系冷却塔B)</u></p> <p><u>下位クラス施設である飛来物防護ネット(再処理設備本体用 安全冷却水系冷却塔B)は、上位クラス施設である安全冷却水B冷却塔並びに安全冷却水B冷却塔まわりの配管及び弁に隣接していることから、上位クラス施設の設計に適用する地震動又は地震力に伴う相対変位により衝突して、安全冷却水B冷却塔並びに安全冷却水B冷却塔まわりの配管及び弁に対して波及的影響を及ぼすおそれが否定できない。このため下位クラス施設である飛来物防護ネット(再処理設備本体用 安全冷却水系冷却塔B)と上位クラス施設である安全冷却水B冷却塔並びに安全冷却水B冷却塔まわりの配管及び弁の相対変位に対する評価を実施する。</u></p> <p><u>各施設の評価に必要な詳細構造計画は各計算書に示す。</u></p>	<p>3. 耐震評価方針</p> <p>3.1 耐震評価部位</p> <p>耐震評価部位については、対象設備の構造及び波及的影響の観点から考慮し、JEAG 4601を含む工事計画での実績を参照した上で、耐震評価上厳しい箇所を選定する。</p> <p>3.1.1 不等沈下又は相対変位の観点</p> <p>(1) 地盤の不等沈下による影響</p> <p>a. <u>土留鋼管矢板</u></p> <p><u>土留鋼管矢板は、地盤の不等沈下により貯留堰の機能に影響を及ぼす可能性が否定できないことから、上位クラス施設の設計に適用する地震動又は地震力に対して、土留鋼管矢板の構造部材の健全性及び基礎地盤の支持性能の確認を行う。</u></p> <p>(2) 建屋間の相対変位による影響</p> <p>a. <u>タービン建屋及びサービス建屋</u></p> <p><u>タービン建屋及びサービス建屋は、相対変位により原子炉建屋に衝突する可能性が否定できないことから、上位クラス施設の設計に適用する地震動又は地震力に対して、タービン建屋及びサービス建屋の相対変位による衝突の有無の確認を行い、衝突する場合には衝突時に原子炉建屋に影響がないことを確認する。</u></p>	<ul style="list-style-type: none"> 第1回申請では本内容に該当する施設が無いため、記載の差異により新たな論点が生じるものではない。後次回申請の施設に対する内容については後次回で比較結果を示す。 本内容については、補足説明資料「【耐震機電03】下位クラス施設の波及的影響の検討について(建物・構築物、機器・配管系)」にて示す。なお、安全冷却水B冷却塔飛来物防護ネットについては鷹架層に支持しているため不等沈下による設計対象としては選定されない。表層地盤の変状による影響については別途補足説明資料「【耐震建物23】竜巻防護対策設備の耐震性評価に関する補足説明」にて示す。 施設の違いによる記載はあるが、記載内容については発電炉と同様であるため、記載の差異により新たな論点が生じるものではない。後次回申請の施設に対する内容は後次回で比較結果を示す。 本内容については、補足説明資料「耐震機電03 下位クラス施設の波及的影響の検討について(建物・構築物、機器・配管系)」に示す。

【IV-2-2-1 波及的影響を及ぼすおそれのある下位クラス施設の耐震評価方針】(4/13)

再処理施設		発電炉	備考
添付書類IV-1-1-4	添付書類IV-2-2-1	添付書類V-2-11-1	
	<p>3.1.2 接続部の観点</p> <p><u>接続部の観点による影響については、「IV-1-1-4 波及的影響に係る基本方針」の「4.2 接続部の観点」に示すように、安全冷却水 B 冷却塔並びに安全冷却水 B 冷却塔まわりの配管及び弁に下位クラスの施設は接続していないことから、安全冷却水 B 冷却塔並びに安全冷却水 B 冷却塔まわりの配管及び弁に対して波及的影響を及ぼす下位クラス施設はない。</u></p>	<p>3.1.2 接続部の観点</p> <p>a. <u>ウォータレグシールライン（残留熱除去系、高圧炉心スプレイ系及び低圧炉心スプレイ系）</u></p> <p><u>残留熱除去系配管、高圧炉心スプレイ系配管及び低圧炉心スプレイ系配管に系統上接続されている下位クラス施設のウォータレグシールライン（残留熱除去系、高圧炉心スプレイ系及び低圧炉心スプレイ系）は、下位クラス施設のウォータレグシールラインの損傷により、上位クラス施設の残留熱除去系配管のバウンダリ機能の喪失の可能性が否定できない。このため、上位クラス施設の残留熱除去系配管と系統上接続されている下位クラス施設のウォータレグシールラインについて、上位クラス施設の設計に適用する地震動又は地震力に対して、主要構造部材及び支持部の評価を実施する。</u></p>	<ul style="list-style-type: none"> 第1回申請では本内容に該当する施設が無いため、記載の差異により新たな論点が生じるものではない。後次回申請の施設に対する内容については後次回で比較結果を示す。 本内容については、補足説明資料「【耐震機電 03】下位クラス施設の波及的影響の検討について（建物・構築物、機器・配管系）」にて示す。

【IV－2－2－1 波及的影響を及ぼすおそれのある下位クラス施設の耐震評価方針】(5/13)

再処理施設	発電炉	備考
添付書類IV－1－1－4	添付書類V－2－11－1	備考
<p>添付書類IV－2－2－1</p> <p>3.1.3 建屋内における下位クラス施設の損傷、転倒及び落下の観点</p> <p><u>建屋内における下位クラス施設の損傷、転倒及び落下の観点による影響については、「IV－1－1－4 波及的影響に係る基本方針」の「4.3 建屋内施設の損傷、転倒及び落下の観点」に示すように、安全冷却水B冷却塔並びに安全冷却水B冷却塔まわりの配管及び弁は屋外に設置される施設であることから、安全冷却水B冷却塔並びに安全冷却水B冷却塔まわりの配管及び弁に対して波及的影響を及ぼす下位クラス施設はない。</u></p>	<p>添付書類IV－2－2－1</p> <p>3.1.3 屋内施設の損傷・転倒及び落下等の観点</p> <p>a. <u>燃料取替機</u> 燃料取替機は、上位クラス施設である使用済燃料プール、使用済燃料貯蔵ラック等の上部に設置していることから、上位クラス施設の設計に適用する地震動又は地震力に伴う転倒又は落下により、使用済燃料プール、使用済燃料貯蔵ラック等に衝突し波及的影響を及ぼすおそれが否定できない。このため上位クラス施設の設計に適用する地震動又は地震力に対して、主要構造部材、支持部及び吊具の評価を実施する。</p> <p>b. <u>原子炉建屋クレーン</u> 原子炉建屋クレーンは、上位クラス施設である使用済燃料プール、使用済燃料貯蔵ラック等の上部に設置していることから、上位クラス施設の設計に適用する地震動又は地震力に伴う転倒又は落下により、使用済燃料プール、使用済燃料貯蔵ラック等に衝突し波及的影響を及ぼすおそれが否定できない。このため上位クラス施設の設計に適用する地震動又は地震力に対して、主要構造部材、支持部及び吊具の評価を実施する。</p> <p>c. <u>使用済燃料乾式貯蔵建屋天井クレーン</u> 使用済燃料乾式貯蔵建屋天井クレーンは、上位クラス施設である使用済燃料乾式貯蔵容器の上部に設置していることから、上位クラス施設の設計に適用する地震動又は地震力に伴う転倒又は落下により、使用済燃料乾式貯蔵容器に衝突し波及的影響を及ぼすおそれが否定できない。このため上位クラス施設の設計に適用する地震動又は地震力に対して、主要構造部材及び支持部の評価を実施する。</p> <p>d. <u>チャンネル着脱機</u> チャンネル着脱機は、上位クラス施設である使用済燃料プール及び使用済燃料貯蔵ラックの上部又は隣接して設置していることから、上位クラス施設の設計に適用する地震動又は地震力に伴う転倒又は落下により、使用済燃料プール及び使用済燃料貯蔵ラックに衝突し波及的影響を及ぼすおそれが否定できない。このため上位クラス施設の設計に適用する地震動又は地震力に対して、主要構造部材、支持部及び吊具の評価を実施する。</p> <p>e. <u>原子炉遮蔽</u> 原子炉遮蔽は、上位クラス施設である原子炉圧力容器に隣接していることから、上位クラス施設の設計に適用する地震動又は地震力に伴う転倒により、原子炉圧力容器に衝突し波及的影響を及ぼすおそれが否定できない。このため上位クラス施設の設計に適用する地震動又は地震力に対して、主要構造部材、固定部の評価を実施する。</p> <p>f. <u>原子炉ウェル遮蔽ブロック</u> 原子炉ウェル遮蔽ブロックは、上位クラス施設である原子炉格納容器の上部に設置していることから、上位クラス施設の設計に適用する地震動又は地震力に伴う落下により、原子炉格納容器に衝突し波及的影響を及ぼすおそれが否定できない。このため上位クラス施設の設計に適用する地震動又は地震力に対して、主要構造部材の評価を実施する。</p>	<p>添付書類V－2－11－1</p> <p>3.1.3 屋内施設の損傷・転倒及び落下等の観点</p> <p>a. <u>燃料取替機</u> 燃料取替機は、上位クラス施設である使用済燃料プール、使用済燃料貯蔵ラック等の上部に設置していることから、上位クラス施設の設計に適用する地震動又は地震力に伴う転倒又は落下により、使用済燃料プール、使用済燃料貯蔵ラック等に衝突し波及的影響を及ぼすおそれが否定できない。このため上位クラス施設の設計に適用する地震動又は地震力に対して、主要構造部材、支持部及び吊具の評価を実施する。</p> <p>b. <u>原子炉建屋クレーン</u> 原子炉建屋クレーンは、上位クラス施設である使用済燃料プール、使用済燃料貯蔵ラック等の上部に設置していることから、上位クラス施設の設計に適用する地震動又は地震力に伴う転倒又は落下により、使用済燃料プール、使用済燃料貯蔵ラック等に衝突し波及的影響を及ぼすおそれが否定できない。このため上位クラス施設の設計に適用する地震動又は地震力に対して、主要構造部材、支持部及び吊具の評価を実施する。</p> <p>c. <u>使用済燃料乾式貯蔵建屋天井クレーン</u> 使用済燃料乾式貯蔵建屋天井クレーンは、上位クラス施設である使用済燃料乾式貯蔵容器の上部に設置していることから、上位クラス施設の設計に適用する地震動又は地震力に伴う転倒又は落下により、使用済燃料乾式貯蔵容器に衝突し波及的影響を及ぼすおそれが否定できない。このため上位クラス施設の設計に適用する地震動又は地震力に対して、主要構造部材及び支持部の評価を実施する。</p> <p>d. <u>チャンネル着脱機</u> チャンネル着脱機は、上位クラス施設である使用済燃料プール及び使用済燃料貯蔵ラックの上部又は隣接して設置していることから、上位クラス施設の設計に適用する地震動又は地震力に伴う転倒又は落下により、使用済燃料プール及び使用済燃料貯蔵ラックに衝突し波及的影響を及ぼすおそれが否定できない。このため上位クラス施設の設計に適用する地震動又は地震力に対して、主要構造部材、支持部及び吊具の評価を実施する。</p> <p>e. <u>原子炉遮蔽</u> 原子炉遮蔽は、上位クラス施設である原子炉圧力容器に隣接していることから、上位クラス施設の設計に適用する地震動又は地震力に伴う転倒により、原子炉圧力容器に衝突し波及的影響を及ぼすおそれが否定できない。このため上位クラス施設の設計に適用する地震動又は地震力に対して、主要構造部材、固定部の評価を実施する。</p> <p>f. <u>原子炉ウェル遮蔽ブロック</u> 原子炉ウェル遮蔽ブロックは、上位クラス施設である原子炉格納容器の上部に設置していることから、上位クラス施設の設計に適用する地震動又は地震力に伴う落下により、原子炉格納容器に衝突し波及的影響を及ぼすおそれが否定できない。このため上位クラス施設の設計に適用する地震動又は地震力に対して、主要構造部材の評価を実施する。</p> <p>備考</p> <ul style="list-style-type: none"> 第1回申請では本内容に該当する施設が無いので、記載の差異により新たな論点が生じるものではない。後次回申請の施設に対する内容については後次回で比較結果を示す。 本内容については、補足説明資料「【耐震機電03】下位クラス施設の波及的影響の検討について（建物・構築物、機器・配管系）」にて示す。

【IV-2-2-1 波及的影響を及ぼすおそれのある下位クラス施設の耐震評価方針】(6/13)

再処理施設	発電炉	備考
添付書類IV-1-1-4	添付書類IV-2-2-1	添付書類V-2-11-1
		<p>g. <u>制御棒貯蔵ラック</u> <u>制御棒貯蔵ラックは、上位クラス施設である使用済燃料プール及び使用済燃料貯蔵ラックの上部又は隣接して設置していることから、上位クラス施設の設計に適用する地震動又は地震力に伴う転倒又は落下により、使用済燃料プール及び使用済燃料貯蔵ラックに衝突し波及的影響を及ぼすおそれが否定できない。このため上位クラス施設の設計に適用する地震動又は地震力に対して、主要構造部材及び固定部の評価を実施する。</u></p> <p>h. <u>制御棒貯蔵ハンガ</u> <u>制御棒貯蔵ハンガは、上位クラス施設である使用済燃料プール及び使用済燃料貯蔵ラックの上部又は隣接して設置していることから、上位クラス施設の設計に適用する地震動又は地震力に伴う転倒又は落下により、使用済燃料プール及び使用済燃料貯蔵ラックに衝突し波及的影響を及ぼすおそれが否定できない。このため上位クラス施設の設計に適用する地震動又は地震力に対して、主要構造部材及び固定部の評価を実施する。</u></p> <p>i. <u>格納容器機器ドレンサンプ</u> <u>格納容器機器ドレンサンプは、上位クラス施設である格納容器床ドレンサンプ及び導入管の近傍に設置していることから、上位クラス施設の設計に適用する地震動又は地震力に伴う転倒により、格納容器床ドレンサンプ及び導入管に波及的影響を及ぼすおそれが否定できない。このため上位クラス施設の設計に適用する地震動又は地震力に対して、主要構造部材の評価を実施する。</u></p> <p>g. <u>中央制御室天井照明</u> <u>中央制御室天井照明は、上位クラス施設である緊急時炉心冷却系操作盤、原子炉補機操作盤等の上部に設置していることから、上位クラス施設の設計に適用する地震動又は地震力に伴う落下により、緊急時炉心冷却系操作盤、原子炉補機操作盤等に衝突し波及的影響を及ぼすおそれが否定できない。このため上位クラス施設の設計に適用する地震動又は地震力に対して、主要構造部材及び固定部の評価を実施する。</u></p> <p>h. <u>使用済燃料乾式貯蔵建屋上屋</u> <u>使用済燃料乾式貯蔵建屋上屋は、上位クラス施設である使用済燃料乾式貯蔵容器の上部に設置していることから、上位クラス施設の設計に適用する地震動又は地震力に伴う落下により、使用済燃料乾式貯蔵容器に衝突し波及的影響を及ぼすおそれが否定できない。このため上位クラス施設の設計に適用する地震動又は地震力に対して、主要構造部材の評価を実施する。</u></p> <p>i. <u>耐火障壁</u> <u>耐火障壁は、上位クラス施設であるパワーセンタ、125V系蓄電池、可燃性ガス濃度制御系再結合器等の近傍に設置していることから、上位クラス施設の設計に適用する地震動又は地震力に伴う転倒により、パワーセンタ、125V系蓄電池、可燃性ガス濃度制御系等に衝突し波及的影響を及ぼすおそれが否定できない。このため上位クラス施設の設計に適用する地震動又は地震力に対して、主要構造部材及び固定部の評価を実施する。</u></p>

・第1回申請では本内容に該当する施設が無いので、記載の差異により新たな論点が生じるものではない。後次回申請の施設に対する内容については後次回で比較結果を示す。

・本内容については、補足説明資料「【耐震機電03】下位クラス施設の波及的影響の検討について(建物・構築物、機器・配管系)」にて示す。

【IV-2-2-1 波及的影響を及ぼすおそれのある下位クラス施設の耐震評価方針】(7/13)

再処理施設	発電炉	備考
添付書類IV-1-1-4	添付書類IV-2-2-1	添付書類V-2-11-1
	<p>3.1.4 建屋外における下位クラス施設の損傷、転倒及び落下の観点</p> <p>(1) <u>飛来物防護ネット(再処理設備本体用 安全冷却水系冷却塔 B)</u> 下位クラス施設である<u>飛来物防護ネット(再処理設備本体用 安全冷却水系冷却塔 B)</u>は、上位クラス施設である<u>安全冷却水 B 冷却塔並びに安全冷却水 B 冷却塔まわりの配管及び弁を覆うように設置していることから、上位クラス施設の設計に適用する地震動又は地震力に伴う転倒又は落下により、安全冷却水 B 冷却塔並びに安全冷却水 B 冷却塔まわりの配管及び弁に衝突し、波及的影響を及ぼすおそれが否定できない。このため主要構造部材及び支持部の評価を実施する。</u></p> <p>各施設の評価に必要な詳細構造計画は各計算書に示す。</p> <p>3.2 地震応答解析 地震応答解析については、「IV-1-1-4 波及的影響に係る基本方針」の「5.2 地震応答解析」に基づき、下位クラス施設に適用する方法として、「IV-1-1-5 地震応答解析の基本方針」に記載の建物・構築物、機器・配管系それぞれの地震応答解析の方針に従い実施する。</p>	<p>3.1.4 屋外施設の損傷・転倒及び落下等の観点</p> <p>a. <u>海水ポンプエリア防護対策施設</u> 下位クラス施設である<u>海水ポンプエリア防護対策施設</u>は、上位クラス施設である<u>残留熱除去系海水系ポンプ、残留熱除去系海水系ストレーナ等の上部に設置していることから、上位クラス施設の設計に適用する地震動又は地震力に伴う落下により、残留熱除去系海水系ポンプ、残留熱除去系海水系ストレーナ等に衝突し、波及的影響を及ぼすおそれが否定できない。このため主要構造部材及び支持部の評価を実施する。</u></p> <p>b. <u>原子炉建屋外側ブローアウトパネル防護対策施設</u> <u>原子炉建屋外側ブローアウトパネル防護対策施設は、上位クラス施設である原子炉建屋外側ブローアウトパネル及びブローアウトパネル閉止装置に近接して設置していることから、上位クラス施設の設計に適用する地震動又は地震力に伴う損傷により、原子炉建屋外側ブローアウトパネル及びブローアウトパネル閉止装置に衝突し、波及的影響を及ぼすおそれが否定できない。このため主要構造部材及び支持部の評価を実施する。</u></p> <p>各施設の評価に必要な詳細構造計画は各計算書に示す。</p> <p>3.2 地震応答解析 地震応答解析については、添付書類「V-2-1-5 波及的影響に係る基本方針」の「5.2 地震応答解析」に基づき、下位クラス施設に適用する方法として、添付書類「V-2-1-6 地震応答解析の基本方針」に記載の建物・構築物、機器・配管系又は<u>屋外重要土木構築物</u>それぞれの地震応答解析の方針に従い実施する。</p>
<p>・施設の違いによる記載はあるが、記載内容については発電炉と同様であるため、記載の差異により新たな論点が生じるものではない。後次回申請の施設に対する内容は後次回で比較結果を示す。</p> <p>・本内容については、補足説明資料「【耐震機電 03】下位クラス施設の波及的影響の検討について(建物・構築物、機器・配管系)」に示す。</p> <p>・補足説明資料「地震 00-01 本文、添付、添付書類、補足説明項目への展開(地震)(再処理施設) 別紙1 基本設計方針の許可整合性、発電炉との比較」と同様に、建物・構築物は、建物、構築物、土木構築物の総称としており、土木構築物についても、建物・構築物の章内にて記載。本内容については、補足説明資</p>		

【IV-2-2-1 波及的影響を及ぼすおそれのある下位クラス施設の耐震評価方針】(8/13)

再処理施設		発電炉	備考
添付書類IV-1-1-4	添付書類IV-2-2-1	添付書類V-2-11-1	
	<p>3.3 設計用地震動又は地震力 設計用地震動又は地震力については、「IV-1-1-4 波及的影響に係る基本方針」の「5.3 設計用地震動又は地震力」に基づき、上位クラス施設の設計に適用する地震動又は地震力として、基準地震動 S_s を適用する。</p>	<p>3.3 設計用地震動又は地震力 設計用地震動又は地震力については、添付書類「V-2-1-5 波及的影響に係る基本方針」の「5.3 設計用地震動又は地震力」に基づき、上位クラス施設の設計に適用する地震動又は地震力として、基準地震動 S_s を適用する。</p>	<p>料「【耐震建物20】洞道の設工認申請上の取り扱いについて」にて示す。なお、「IV-1-1-4 波及的影響に係る基本方針」の「4. 波及的影響の設計対象とする下位クラス施設」において選定される土木構造物はない。</p>

【IV-2-2-1 波及的影響を及ぼすおそれのある下位クラス施設の耐震評価方針】(9/13)

再処理施設	発電炉	備考
添付書類IV-1-1-4	添付書類IV-2-2-1	添付書類V-2-11-1
	<p>3.4 荷重の種類及び荷重の組合せ</p> <p>荷重の種類及び組合せについては、「IV-1-1-4 波及的影響に係る基本方針」の「5.4 荷重の種類及び荷重の組合せ」に基づき、<u>波及的影響の防止を目的とした設計において用いる荷重の種類及び荷重の組合せとして、波及的影響を受けるおそれのある上位クラス施設と同じ運転状態において下位クラス施設に発生する荷重を組み合わせる。</u></p> <p>また、屋外に設置されている施設については、「IV-1-1-8 機能維持の基本方針」の積雪荷重及び風荷重の組合せの考え方に基づき設定する。</p> <p>3.5 許容限界</p> <p>波及的影響の設計対象とする下位クラス施設の評価に用いる許容限界については、「IV-1-1-4 波及的影響に係る基本方針」の「5.5 許容限界」に基づき、波及的影響を受けるおそれのある上位クラス施設と同じ運転状態において、下位クラス施設が波及的影響を及ぼすおそれがないよう、また、上位クラス施設の機能に影響がないよう、以下、建物・構築物、機器・配管系に分けて設定する。</p>	<p>3.4 荷重の種類及び荷重の組合せ</p> <p>荷重の種類及び組合せについては、添付書類「V-2-1-5 波及的影響に係る基本方針」の「5.4 荷重の種類及び荷重の組合せ」に基づき、<u>波及的影響を受けるおそれのある上位クラス施設の運転状態において下位クラス施設に発生する荷重は、上位クラス施設がSクラス施設の場合は運転状態I~IVとして、SA施設の場合は運転状態Vとして発生する荷重を設定し、添付書類「V-2-1-9 機能維持の基本方針」の設計基準対象施設又は常設重大事故等対処施設の荷重の組合せをそれぞれ適用する。</u></p> <p>また、屋外に設置されている施設については、添付書類「V-2-1-9 機能維持の基本方針」の風荷重及び積雪荷重の組合せの考え方にに基づき設定する。</p> <p>3.5 許容限界</p> <p>波及的影響の設計対象とする下位クラス施設の評価に用いる許容限界については、添付書類「V-2-1-5 波及的影響に係る基本方針」の「5.5 許容限界」に基づき、波及的影響を受けるおそれのある上位クラス施設と同じ運転状態において、下位クラス施設が波及的影響を及ぼすおそれがないよう、また、上位クラス施設の機能に影響がないよう、以下、建物・構築物、機器・配管系及び土木構造物に分けて設定する。</p>

- 申請書間の整合を図るため、「IV-1-1-4 波及的影響に係る基本方針」に合わせた記載としており、記載の差異により新たな論点が生じるものではない。
- 重大事故等対処施設については後次回で比較結果を示す。

- 補足説明資料「地震00-01本文、添付、添付書類、補足説明項目への展開(地震)(再処理施設)別紙1基本設計方針の許可整合性、発電炉との比較」と同様に、建物・構築物は、建物、構築物、土木構造物の総称としており、土木構造物についても、建物・構築物の章内にて記載。本内容については、補足説明資料「【耐震建物20】洞道の設工認申請上の取り扱いについて」にて示す。なお、「IV-1-1-4 波及的影響に係る基本方

【IV-2-2-1 波及的影響を及ぼすおそれのある下位クラス施設の耐震評価方針】(10/13)

再処理施設		発電炉	備考
添付書類IV-1-1-4	添付書類IV-2-2-1	添付書類V-2-11-1	
	<p>3.5.1 建物・構築物 建物・構築物については、「IV-1-1-4 波及的影響に係る基本方針」の「5.5 許容限界」に基づき、距離及び終局耐力を許容限界とする。 終局耐力においては、鉄筋コンクリート造耐震壁を主要構造とする建物・構築物についてはJEAG4601に基づく終局点に対応するせん断ひずみ、それ以外の建物・構築物については崩壊機構が形成されないこと又は「鋼構造設計規準-許容応力度設計法-」((社)日本建築学会, 2005)等に基づく終局耐力を設定することを基本とする。</p> <p>3.5.2 機器・配管系 機器・配管系については、「IV-1-1-4 波及的影響に係る基本方針」の「5.5 許容限界」に基づき、破断延性限界に十分な余裕を有していることに相当する許容限界として、「IV-1-1-8 機能維持の基本方針」に示す<u>基準地震動S_sとの荷重の組合せに適用する許容限界</u>を設定する。</p>	<p>3.5.1 建物・構築物 建物・構築物については、添付書類「V-2-1-5 波及的影響に係る基本方針」の「5.5 許容限界」に基づき、距離及び終局耐力を許容限界とする。 終局耐力においては、鉄筋コンクリート造耐震壁を主要構造とする建物・構築物についてはJEAG4601に基づく終局点に対応するせん断ひずみ、それ以外の建物・構築物については崩壊機構が形成されないこと又は「鋼構造設計規準-許容応力度設計法-」((社)日本建築学会, 2005)等に基づく終局耐力を設定することを基本とする。</p> <p>3.5.2 機器・配管系 機器・配管系については、添付書類「V-2-1-5 波及的影響に係る基本方針」の「5.5 許容限界」に基づき、破断延性限界に十分な余裕を有していることに相当する許容限界として、添付書類「V-2-1-9 機能維持の基本方針」に示す<u>許容応力状態IV_{ΔS}</u>を設定する。</p>	<p>針」の「4. 波及的影響の設計対象とする下位クラス施設」において選定される土木構造物はない。</p> <p>・施設共通となる基本的な許容限界の考え方を記載しており、施設固有の特殊な部材は別途施設毎に示す。なお、安全冷却水B冷却塔竜巻防護ネットの座屈拘束ブレース等については第3.6-1表に示す。</p> <p>・申請書間の整合を図るため、「IV-1-1-4 波及的影響に係る基本方針」に合わせた記載としており、記載の差異により新たな論点が生じるものではない。</p>

【IV-2-2-1 波及的影響を及ぼすおそれのある下位クラス施設の耐震評価方針】(11/13)

再処理施設		発電炉	備考
添付書類IV-1-1-4	添付書類IV-2-2-1	添付書類V-2-11-1	
		<p>3.5.3 土木構造物</p> <p><u>土木構造物については、添付書類「V-2-1-5 波及的影響に係る基本方針」の「5.5 許容限界」に基づき、構造部材は短期許容応力度、基礎地盤は極限支持力度に対して適切な安全余裕を考慮して設定する。</u></p>	<p>・ 補足説明資料「地震00-01 本文、添付、添付書類、補足説明項目への展開（地震）（再処理施設）別紙1 基本設計方針の許可整合性、発電炉との比較」と同様に、建物・構築物は、建物、構築物、土木構造物の総称としており、土木構造物についても、建物・構築物の章内にて記載。本内容については、補足説明資料「【耐震建物20】洞道の設工認申請上の取り扱いについて」にて示す。なお、「IV-1-1-4 波及的影響に係る基本方針」の「4. 波及的影響の設計対象とする下位クラス施設」において選定される土木構造物はない。</p>

【IV-2-2-1 波及的影響を及ぼすおそれのある下位クラス施設の耐震評価方針】(12/13)

再処理施設		発電炉	備考
添付書類IV-1-1-4	添付書類IV-2-2-1	添付書類V-2-11-1	
	<p>3.6 まとめ 以上を踏まえ、波及的影響の設計対象とする下位クラス施設の耐震評価方針を第3.6-1表に示す。</p> <p>各施設の詳細な評価は、「IV-2-2-2 波及的影響を及ぼすおそれのある下位クラス施設の耐震性についての計算書」以降の各計算書に示す。</p>	<p>3.6 まとめ 以上を踏まえ、波及的影響の設計対象とする下位クラス施設の耐震評価方針を表3-1に示す。<u>評価条件の欄については、波及的影響を受けるおそれのある上位クラス施設と同じ運転状態を想定することから、上位クラス施設がSクラス施設の場合は「DB」、重要SA施設の場合は「SA」と評価条件に明記する。</u></p> <p>各施設の詳細な評価は、添付書類「V-2-11-2」以降の各計算書に示す。</p>	<p>・重大事故等対処施設については後次回で比較結果を示す。</p>

【IV-2-2-1 波及的影響を及ぼすおそれのある下位クラス施設の耐震評価方針】(13/13)

再処理施設		添付書類IV-2-2-1		添付書類IV-1-1-4		添付書類V-2-11-1		添付書類V-2-11-1		備考																																																																																																																																																																																
添付書類IV-1-1-4		添付書類IV-2-2-1		添付書類IV-1-1-4		添付書類V-2-11-1		添付書類V-2-11-1		備考																																																																																																																																																																																
<p>第3.6-1表 波及的影響の設計対象とする下位クラス施設の耐震評価方針</p> <table border="1"> <tr> <td>分類</td> <td>建物・構築物</td> <td>設計対象 下位クラス施設</td> <td>設計の観点*</td> <td>耐震評価部位</td> <td>設計用地震動</td> <td>荷重の種類及び 荷重の組合せ</td> <td>許容限界設定の考え方</td> </tr> <tr> <td></td> <td></td> <td>飛来物防護ネット (再処理設備本体用 安全冷却水 系冷却塔B)</td> <td>設置地盤及び地震応答 性状の相違等に起因す る相対変位又は不等沈 下による影響(相対変 位) 建屋外における下位ク ラス施設の影響、転倒 及び落下</td> <td>主要構造部 支持部</td> <td>S_s</td> <td>D+L_s+S_s+WL</td> <td>許容限界設定の考え方 飛来物防護ネット(再処理設備本体用 安全冷却水 系冷却塔B)と安全冷却水B冷却塔の離隔距離。 「鋼構造設計規程」(社)日本建築学会,2005)等に基 づく鉄筋強度。 産部拘束ブレースについては、「BC」評定-ST0126-06 にて保証されている許容限界とする。</td> </tr> </table>		分類	建物・構築物	設計対象 下位クラス施設	設計の観点*	耐震評価部位	設計用地震動	荷重の種類及び 荷重の組合せ	許容限界設定の考え方			飛来物防護ネット (再処理設備本体用 安全冷却水 系冷却塔B)	設置地盤及び地震応答 性状の相違等に起因す る相対変位又は不等沈 下による影響(相対変 位) 建屋外における下位ク ラス施設の影響、転倒 及び落下	主要構造部 支持部	S _s	D+L _s +S _s +WL	許容限界設定の考え方 飛来物防護ネット(再処理設備本体用 安全冷却水 系冷却塔B)と安全冷却水B冷却塔の離隔距離。 「鋼構造設計規程」(社)日本建築学会,2005)等に基 づく鉄筋強度。 産部拘束ブレースについては、「BC」評定-ST0126-06 にて保証されている許容限界とする。	<p>記号の説明</p> <p>D : 固定荷重 L : 積載荷重 L_s : 積雪荷重(短期事象との組合せ用) S_s : 基準地震動S_sによる地震力 WL : 風荷重(「IV-1-1-8 機能維持の基本方針」に基づき設定)</p>		<p>注記* : 「IV-1-1-4 波及的影響に係る基本方針」の「3. 波及的影響を考慮した施設の設計方針」にて設定した4つの設計の観点を記載</p>		<p>表3-1 波及的影響の設計対象とする下位クラス施設の耐震評価方針</p> <table border="1"> <thead> <tr> <th>設計対象 下位クラス施設</th> <th>評価の観点*</th> <th>耐震評価 部位</th> <th>設計用 地震動</th> <th>荷重の種類 荷重の組合せ</th> <th>評価 条件</th> <th>許容限界設定の考え方</th> </tr> </thead> <tbody> <tr> <td>建物・構築物</td> <td></td> <td></td> <td></td> <td></td> <td></td> <td></td> </tr> <tr> <td>タービン建屋</td> <td>① (相対変位)</td> <td>主要構造部材</td> <td>S_s</td> <td>G+P+S_{max}+K_s</td> <td>DB</td> <td>「J E A C 4601-1987」に基づく終局点に 対応するせん断ひずみを適用する。タービン建 屋と原子炉建屋との離隔距離を適用する。</td> </tr> <tr> <td>サービス建屋</td> <td>① (相対変位)</td> <td>主要構造部材</td> <td>S_s</td> <td>G+P+S_{max}+K_s</td> <td>DB</td> <td>「技術基準解説書」に基づく層間変形角を適 用する。 サービス建屋原子炉建屋との離隔距離を適 用する。</td> </tr> <tr> <td>使用済燃料乾式貯蔵建屋 上屋</td> <td>③</td> <td>主要構造部材</td> <td>S_s</td> <td>G+E+P+S+CL+ K_s</td> <td>DB</td> <td>「J E A C 4601-1987」に基づく終局点に 対応するせん断ひずみを適用する。「S 規準」 及び「技術基準解説書」に基づく弾性強度 を適用する。</td> </tr> <tr> <td>機器・配管系</td> <td></td> <td></td> <td></td> <td></td> <td></td> <td></td> </tr> <tr> <td>燃料取扱機</td> <td>③</td> <td>主要構造部材 支持部 吊具</td> <td>S_s</td> <td>D+P₁+M₁+S_s , D+P_{max}+M_{max}+S_s</td> <td>DB SA</td> <td>添付書類「V-2-1-9 機能維持の基本方針」に 示すその他の支持構造物の許容応力(許容応 力状態IV)を適用する。 吊具については、クレーン構造規格及び日本 クレーン協会規格に定められた安全率を上 回るように設定された許容荷重を適用する。</td> </tr> <tr> <td>原子炉建屋クレーン</td> <td>③</td> <td>主要構造部材 支持部 吊具</td> <td>S_s</td> <td>D+P₁+M₁+S_s , D+P_{max}+M_{max}+S_s</td> <td>DB SA</td> <td>添付書類「V-2-1-9 機能維持の基本方針」に 示すその他の支持構造物の許容応力(許容応 力状態IV)を適用する。 吊具については、クレーン構造規格及び日本 クレーン協会規格に定められた安全率を上 回るように設定された許容荷重を適用する。</td> </tr> </tbody> </table> <p>注記* : 添付書類「V-2-1-5 波及的影響に係る基本方針」にて設定した4つの設計の観点を記載</p> <table border="1"> <thead> <tr> <th>設計対象 下位クラス施設</th> <th>評価の観点*</th> <th>耐震評価 部位</th> <th>設計用 地震動</th> <th>荷重の種類 荷重の組合せ</th> <th>評価 条件</th> <th>許容限界設定の考え方</th> </tr> </thead> <tbody> <tr> <td>使用済燃料乾式貯蔵建屋</td> <td>③</td> <td>主要構造部材 支持部</td> <td>S_s</td> <td>D+P₁+M₁+S_s</td> <td>DB</td> <td>添付書類「V-2-1-9 機能維持の基本方針」に 示すその他の支持構造物の許容応力(許容応 力状態IV)を適用する。</td> </tr> <tr> <td>チャンネル着脱機</td> <td>③</td> <td>主要構造部材 支持部 吊具</td> <td>S_s</td> <td>D+P₁+M₁+S_s , D+P_{max}+M_{max}+S_s</td> <td>DB SA</td> <td>添付書類「V-2-1-9 機能維持の基本方針」に 示すその他の支持構造物の許容応力(許容応 力状態IV)を適用する。 吊具については、クレーン構造規格及び日本 クレーン協会規格に定められた安全率を上 回るように設定された許容荷重を適用する。</td> </tr> <tr> <td>原子炉遮蔽</td> <td>③</td> <td>主要構造部材 支持部</td> <td>S_s</td> <td>D+S_s</td> <td>DB SA</td> <td>「鋼構造設計規程」に基づく短期許容応力度 を適用する。</td> </tr> <tr> <td>原子炉ウェル遮蔽ブロッ ク</td> <td>③</td> <td>主要構造部材</td> <td>S_s</td> <td>G+P+S</td> <td>DB SA</td> <td>「鋼構造設計規程」に基づく短期許容応力度 を適用する。</td> </tr> <tr> <td>前炉種貯蔵ラック</td> <td>③</td> <td>主要構造部材 支持部</td> <td>S_s</td> <td>D+P₁+M₁+S_s , D+P_{max}+M_{max}+S_s</td> <td>DB SA</td> <td>添付書類「V-2-1-9 機能維持の基本方針」に 示すその他の支持構造物の許容応力(許容応 力状態IV)を適用する。</td> </tr> <tr> <td>前炉種貯蔵ハンガ</td> <td>③</td> <td>主要構造部材 支持部</td> <td>S_s</td> <td>D+P₁+M₁+S_s , D+P_{max}+M_{max}+S_s</td> <td>DB SA</td> <td>添付書類「V-2-1-9 機能維持の基本方針」に 示すその他の支持構造物の許容応力(許容応 力状態IV)を適用する。</td> </tr> <tr> <td>ウオータグシールドライ ン(蒸気熱除去系、高圧伊 心スプレイス及び低圧伊 心スプレイス)</td> <td>③</td> <td>主要構造部材 支持部</td> <td>S_s</td> <td>D+P₁+M₁+S_s , D+P_{max}+M_{max}+S_s</td> <td>DB SA</td> <td>添付書類「V-2-1-9 機能維持の基本方針」に 示すその他の支持構造物の許容応力(許容応 力状態IV)を適用する。</td> </tr> <tr> <td>格納容器機器ドレンサン プ</td> <td>③</td> <td>主要構造部材</td> <td>S_s</td> <td>D+P₁+M₁+S_s , D+P_{max}+M_{max}+S_s</td> <td>DB SA</td> <td>添付書類「V-2-1-9 機能維持の基本方針」に 示すクラス容器を適用する。</td> </tr> </tbody> </table> <p>注記* : 添付書類「V-2-1-5 波及的影響に係る基本方針」にて設定した4つの設計の観点を記載</p> <table border="1"> <thead> <tr> <th>設計対象 下位クラス施設</th> <th>評価の観点*</th> <th>耐震評価 部位</th> <th>設計用 地震動</th> <th>荷重の種類 荷重の組合せ</th> <th>評価 条件</th> <th>許容限界設定の考え方</th> </tr> </thead> <tbody> <tr> <td>海水ポンプエリア防護対 策施設</td> <td>④</td> <td>主要構造部材 支持部</td> <td>S_s</td> <td>D+S_s+P₁+P₂</td> <td>DB SA</td> <td>添付書類「V-2-1-9 機能維持の基本方針」に 示すその他の支持構造物の許容応力(許容応 力状態IV)を適用する。「コンクリート標準 示方書」及び「道路橋示方書」に基づく短期 許容応力度を適用する。</td> </tr> <tr> <td>中央制御室天井照明</td> <td>③</td> <td>主要構造部材 支持部</td> <td>S_s</td> <td>D+P₁+M₁+S_s , D+P_{max}+M_{max}+S_s</td> <td>DB SA</td> <td>添付書類「V-2-1-9 機能維持の基本方針」に 示すその他の支持構造物の許容応力(許容応 力状態IV)を適用する。</td> </tr> <tr> <td>耐火障壁</td> <td>⑤</td> <td>主要構造部材 支持部 吊具</td> <td>S_s</td> <td>D+S_s</td> <td>DB SA</td> <td>「鉄筋コンクリート構造計算規程・同解 説」に基づく許容応力度を適用する。 「各種合成構造設計指針・同解説」に基づ くアンカージ力を適用する。</td> </tr> <tr> <td>原子炉建屋外側ブローア ウトパネル防護対策施設</td> <td>④</td> <td>主要構造部材 支持部 吊具</td> <td>S_s</td> <td>D+S_s+P₁+P₂</td> <td>DB SA</td> <td>添付書類「V-2-1-9 機能維持の基本方針」に 示すその他の支持構造物の許容応力(許容応 力状態IV)を適用する。「コンクリート標準 示方書」及び「道路橋示方書」に基づく短期 許容応力度を適用する。</td> </tr> <tr> <td>土木構築物 土留鋼管矢板</td> <td>① (不等沈下)</td> <td>主要構造部材 基礎地盤</td> <td>S_s</td> <td>D+S_s+P₁+P₂</td> <td>DB</td> <td>「道路橋示方書」に基づく短期許容応力度及 び制限支持力度を適用する。</td> </tr> </tbody> </table> <p>注記* : 添付書類「V-2-1-5 波及的影響に係る基本方針」にて設定した4つの設計の観点を記載</p>		設計対象 下位クラス施設	評価の観点*	耐震評価 部位	設計用 地震動	荷重の種類 荷重の組合せ	評価 条件	許容限界設定の考え方	建物・構築物							タービン建屋	① (相対変位)	主要構造部材	S _s	G+P+S _{max} +K _s	DB	「J E A C 4601-1987」に基づく終局点に 対応するせん断ひずみを適用する。タービン建 屋と原子炉建屋との離隔距離を適用する。	サービス建屋	① (相対変位)	主要構造部材	S _s	G+P+S _{max} +K _s	DB	「技術基準解説書」に基づく層間変形角を適 用する。 サービス建屋原子炉建屋との離隔距離を適 用する。	使用済燃料乾式貯蔵建屋 上屋	③	主要構造部材	S _s	G+E+P+S+CL+ K _s	DB	「J E A C 4601-1987」に基づく終局点に 対応するせん断ひずみを適用する。「S 規準」 及び「技術基準解説書」に基づく弾性強度 を適用する。	機器・配管系							燃料取扱機	③	主要構造部材 支持部 吊具	S _s	D+P ₁ +M ₁ +S _s , D+P _{max} +M _{max} +S _s	DB SA	添付書類「V-2-1-9 機能維持の基本方針」に 示すその他の支持構造物の許容応力(許容応 力状態IV)を適用する。 吊具については、クレーン構造規格及び日本 クレーン協会規格に定められた安全率を上 回るように設定された許容荷重を適用する。	原子炉建屋クレーン	③	主要構造部材 支持部 吊具	S _s	D+P ₁ +M ₁ +S _s , D+P _{max} +M _{max} +S _s	DB SA	添付書類「V-2-1-9 機能維持の基本方針」に 示すその他の支持構造物の許容応力(許容応 力状態IV)を適用する。 吊具については、クレーン構造規格及び日本 クレーン協会規格に定められた安全率を上 回るように設定された許容荷重を適用する。	設計対象 下位クラス施設	評価の観点*	耐震評価 部位	設計用 地震動	荷重の種類 荷重の組合せ	評価 条件	許容限界設定の考え方	使用済燃料乾式貯蔵建屋	③	主要構造部材 支持部	S _s	D+P ₁ +M ₁ +S _s	DB	添付書類「V-2-1-9 機能維持の基本方針」に 示すその他の支持構造物の許容応力(許容応 力状態IV)を適用する。	チャンネル着脱機	③	主要構造部材 支持部 吊具	S _s	D+P ₁ +M ₁ +S _s , D+P _{max} +M _{max} +S _s	DB SA	添付書類「V-2-1-9 機能維持の基本方針」に 示すその他の支持構造物の許容応力(許容応 力状態IV)を適用する。 吊具については、クレーン構造規格及び日本 クレーン協会規格に定められた安全率を上 回るように設定された許容荷重を適用する。	原子炉遮蔽	③	主要構造部材 支持部	S _s	D+S _s	DB SA	「鋼構造設計規程」に基づく短期許容応力度 を適用する。	原子炉ウェル遮蔽ブロッ ク	③	主要構造部材	S _s	G+P+S	DB SA	「鋼構造設計規程」に基づく短期許容応力度 を適用する。	前炉種貯蔵ラック	③	主要構造部材 支持部	S _s	D+P ₁ +M ₁ +S _s , D+P _{max} +M _{max} +S _s	DB SA	添付書類「V-2-1-9 機能維持の基本方針」に 示すその他の支持構造物の許容応力(許容応 力状態IV)を適用する。	前炉種貯蔵ハンガ	③	主要構造部材 支持部	S _s	D+P ₁ +M ₁ +S _s , D+P _{max} +M _{max} +S _s	DB SA	添付書類「V-2-1-9 機能維持の基本方針」に 示すその他の支持構造物の許容応力(許容応 力状態IV)を適用する。	ウオータグシールドライ ン(蒸気熱除去系、高圧伊 心スプレイス及び低圧伊 心スプレイス)	③	主要構造部材 支持部	S _s	D+P ₁ +M ₁ +S _s , D+P _{max} +M _{max} +S _s	DB SA	添付書類「V-2-1-9 機能維持の基本方針」に 示すその他の支持構造物の許容応力(許容応 力状態IV)を適用する。	格納容器機器ドレンサン プ	③	主要構造部材	S _s	D+P ₁ +M ₁ +S _s , D+P _{max} +M _{max} +S _s	DB SA	添付書類「V-2-1-9 機能維持の基本方針」に 示すクラス容器を適用する。	設計対象 下位クラス施設	評価の観点*	耐震評価 部位	設計用 地震動	荷重の種類 荷重の組合せ	評価 条件	許容限界設定の考え方	海水ポンプエリア防護対 策施設	④	主要構造部材 支持部	S _s	D+S _s +P ₁ +P ₂	DB SA	添付書類「V-2-1-9 機能維持の基本方針」に 示すその他の支持構造物の許容応力(許容応 力状態IV)を適用する。「コンクリート標準 示方書」及び「道路橋示方書」に基づく短期 許容応力度を適用する。	中央制御室天井照明	③	主要構造部材 支持部	S _s	D+P ₁ +M ₁ +S _s , D+P _{max} +M _{max} +S _s	DB SA	添付書類「V-2-1-9 機能維持の基本方針」に 示すその他の支持構造物の許容応力(許容応 力状態IV)を適用する。	耐火障壁	⑤	主要構造部材 支持部 吊具	S _s	D+S _s	DB SA	「鉄筋コンクリート構造計算規程・同解 説」に基づく許容応力度を適用する。 「各種合成構造設計指針・同解説」に基づ くアンカージ力を適用する。	原子炉建屋外側ブローア ウトパネル防護対策施設	④	主要構造部材 支持部 吊具	S _s	D+S _s +P ₁ +P ₂	DB SA	添付書類「V-2-1-9 機能維持の基本方針」に 示すその他の支持構造物の許容応力(許容応 力状態IV)を適用する。「コンクリート標準 示方書」及び「道路橋示方書」に基づく短期 許容応力度を適用する。	土木構築物 土留鋼管矢板	① (不等沈下)	主要構造部材 基礎地盤	S _s	D+S _s +P ₁ +P ₂	DB	「道路橋示方書」に基づく短期許容応力度及 び制限支持力度を適用する。	<p>第1回申請である安全冷却水B冷却塔に対する記載としており、その他の施設及び重大事故等対処施設については後次回で比較結果を示す。</p>	
分類	建物・構築物	設計対象 下位クラス施設	設計の観点*	耐震評価部位	設計用地震動	荷重の種類及び 荷重の組合せ	許容限界設定の考え方																																																																																																																																																																																			
		飛来物防護ネット (再処理設備本体用 安全冷却水 系冷却塔B)	設置地盤及び地震応答 性状の相違等に起因す る相対変位又は不等沈 下による影響(相対変 位) 建屋外における下位ク ラス施設の影響、転倒 及び落下	主要構造部 支持部	S _s	D+L _s +S _s +WL	許容限界設定の考え方 飛来物防護ネット(再処理設備本体用 安全冷却水 系冷却塔B)と安全冷却水B冷却塔の離隔距離。 「鋼構造設計規程」(社)日本建築学会,2005)等に基 づく鉄筋強度。 産部拘束ブレースについては、「BC」評定-ST0126-06 にて保証されている許容限界とする。																																																																																																																																																																																			
設計対象 下位クラス施設	評価の観点*	耐震評価 部位	設計用 地震動	荷重の種類 荷重の組合せ	評価 条件	許容限界設定の考え方																																																																																																																																																																																				
建物・構築物																																																																																																																																																																																										
タービン建屋	① (相対変位)	主要構造部材	S _s	G+P+S _{max} +K _s	DB	「J E A C 4601-1987」に基づく終局点に 対応するせん断ひずみを適用する。タービン建 屋と原子炉建屋との離隔距離を適用する。																																																																																																																																																																																				
サービス建屋	① (相対変位)	主要構造部材	S _s	G+P+S _{max} +K _s	DB	「技術基準解説書」に基づく層間変形角を適 用する。 サービス建屋原子炉建屋との離隔距離を適 用する。																																																																																																																																																																																				
使用済燃料乾式貯蔵建屋 上屋	③	主要構造部材	S _s	G+E+P+S+CL+ K _s	DB	「J E A C 4601-1987」に基づく終局点に 対応するせん断ひずみを適用する。「S 規準」 及び「技術基準解説書」に基づく弾性強度 を適用する。																																																																																																																																																																																				
機器・配管系																																																																																																																																																																																										
燃料取扱機	③	主要構造部材 支持部 吊具	S _s	D+P ₁ +M ₁ +S _s , D+P _{max} +M _{max} +S _s	DB SA	添付書類「V-2-1-9 機能維持の基本方針」に 示すその他の支持構造物の許容応力(許容応 力状態IV)を適用する。 吊具については、クレーン構造規格及び日本 クレーン協会規格に定められた安全率を上 回るように設定された許容荷重を適用する。																																																																																																																																																																																				
原子炉建屋クレーン	③	主要構造部材 支持部 吊具	S _s	D+P ₁ +M ₁ +S _s , D+P _{max} +M _{max} +S _s	DB SA	添付書類「V-2-1-9 機能維持の基本方針」に 示すその他の支持構造物の許容応力(許容応 力状態IV)を適用する。 吊具については、クレーン構造規格及び日本 クレーン協会規格に定められた安全率を上 回るように設定された許容荷重を適用する。																																																																																																																																																																																				
設計対象 下位クラス施設	評価の観点*	耐震評価 部位	設計用 地震動	荷重の種類 荷重の組合せ	評価 条件	許容限界設定の考え方																																																																																																																																																																																				
使用済燃料乾式貯蔵建屋	③	主要構造部材 支持部	S _s	D+P ₁ +M ₁ +S _s	DB	添付書類「V-2-1-9 機能維持の基本方針」に 示すその他の支持構造物の許容応力(許容応 力状態IV)を適用する。																																																																																																																																																																																				
チャンネル着脱機	③	主要構造部材 支持部 吊具	S _s	D+P ₁ +M ₁ +S _s , D+P _{max} +M _{max} +S _s	DB SA	添付書類「V-2-1-9 機能維持の基本方針」に 示すその他の支持構造物の許容応力(許容応 力状態IV)を適用する。 吊具については、クレーン構造規格及び日本 クレーン協会規格に定められた安全率を上 回るように設定された許容荷重を適用する。																																																																																																																																																																																				
原子炉遮蔽	③	主要構造部材 支持部	S _s	D+S _s	DB SA	「鋼構造設計規程」に基づく短期許容応力度 を適用する。																																																																																																																																																																																				
原子炉ウェル遮蔽ブロッ ク	③	主要構造部材	S _s	G+P+S	DB SA	「鋼構造設計規程」に基づく短期許容応力度 を適用する。																																																																																																																																																																																				
前炉種貯蔵ラック	③	主要構造部材 支持部	S _s	D+P ₁ +M ₁ +S _s , D+P _{max} +M _{max} +S _s	DB SA	添付書類「V-2-1-9 機能維持の基本方針」に 示すその他の支持構造物の許容応力(許容応 力状態IV)を適用する。																																																																																																																																																																																				
前炉種貯蔵ハンガ	③	主要構造部材 支持部	S _s	D+P ₁ +M ₁ +S _s , D+P _{max} +M _{max} +S _s	DB SA	添付書類「V-2-1-9 機能維持の基本方針」に 示すその他の支持構造物の許容応力(許容応 力状態IV)を適用する。																																																																																																																																																																																				
ウオータグシールドライ ン(蒸気熱除去系、高圧伊 心スプレイス及び低圧伊 心スプレイス)	③	主要構造部材 支持部	S _s	D+P ₁ +M ₁ +S _s , D+P _{max} +M _{max} +S _s	DB SA	添付書類「V-2-1-9 機能維持の基本方針」に 示すその他の支持構造物の許容応力(許容応 力状態IV)を適用する。																																																																																																																																																																																				
格納容器機器ドレンサン プ	③	主要構造部材	S _s	D+P ₁ +M ₁ +S _s , D+P _{max} +M _{max} +S _s	DB SA	添付書類「V-2-1-9 機能維持の基本方針」に 示すクラス容器を適用する。																																																																																																																																																																																				
設計対象 下位クラス施設	評価の観点*	耐震評価 部位	設計用 地震動	荷重の種類 荷重の組合せ	評価 条件	許容限界設定の考え方																																																																																																																																																																																				
海水ポンプエリア防護対 策施設	④	主要構造部材 支持部	S _s	D+S _s +P ₁ +P ₂	DB SA	添付書類「V-2-1-9 機能維持の基本方針」に 示すその他の支持構造物の許容応力(許容応 力状態IV)を適用する。「コンクリート標準 示方書」及び「道路橋示方書」に基づく短期 許容応力度を適用する。																																																																																																																																																																																				
中央制御室天井照明	③	主要構造部材 支持部	S _s	D+P ₁ +M ₁ +S _s , D+P _{max} +M _{max} +S _s	DB SA	添付書類「V-2-1-9 機能維持の基本方針」に 示すその他の支持構造物の許容応力(許容応 力状態IV)を適用する。																																																																																																																																																																																				
耐火障壁	⑤	主要構造部材 支持部 吊具	S _s	D+S _s	DB SA	「鉄筋コンクリート構造計算規程・同解 説」に基づく許容応力度を適用する。 「各種合成構造設計指針・同解説」に基づ くアンカージ力を適用する。																																																																																																																																																																																				
原子炉建屋外側ブローア ウトパネル防護対策施設	④	主要構造部材 支持部 吊具	S _s	D+S _s +P ₁ +P ₂	DB SA	添付書類「V-2-1-9 機能維持の基本方針」に 示すその他の支持構造物の許容応力(許容応 力状態IV)を適用する。「コンクリート標準 示方書」及び「道路橋示方書」に基づく短期 許容応力度を適用する。																																																																																																																																																																																				
土木構築物 土留鋼管矢板	① (不等沈下)	主要構造部材 基礎地盤	S _s	D+S _s +P ₁ +P ₂	DB	「道路橋示方書」に基づく短期許容応力度及 び制限支持力度を適用する。																																																																																																																																																																																				

別紙4－16

機器の耐震性に関する 計算書作成の基本方針

【凡例】

下線：

- ・プラントの違いによらない記載内容の差異
- ・章立ての違いによる記載位置の違いによる差異

二重下線：

- ・プラント固有の事項による記載内容の差異
- ・後次回の申請範囲に伴う差異

【IV-1-2-1 機器の耐震性に関する計算書作成の基本方針】(1/28)

再処理施設		発電炉	備考
添付書類IV-1-1	添付書類IV-1-2-1	添付書類V-2-1-13-1	
	IV-1-2-1 機器の耐震性に関する計算書作成の基本方針 目次 1. 概要 2. <u>耐震評価の方針</u> 2.1 <u>評価条件の記載方針</u> 3. <u>耐震計算方法</u> 3.1 <u>計算式設定の考え方</u> 3.2 <u>基本方針に示す計算式の分類</u> 3.3 <u>疲労評価の計算式</u>	V-2-1-13-1 スカート支持たて置円筒形容器の耐震性についての計算書作成の基本方針 目次 1. 概要 2. <u>一般事項</u> 2.1 <u>評価方針</u> 2.2 <u>適用基準</u> 2.3 <u>記号の説明</u> 2.4 <u>計算精度と数値の丸め方</u> 3. <u>評価部位</u> 4. <u>固有周期</u> 4.1 <u>固有周期の計算方法</u> 5. <u>構造強度評価</u> 5.1 <u>構造強度評価方法</u> 5.2 <u>設計用地震力</u> 5.3 <u>計算方法</u> 5.4 <u>応力の評価</u> 6. <u>耐震計算書のフォーマット</u>	<ul style="list-style-type: none"> • 発電炉における計算式の示し方として、定型式は形状毎に基本方針として示し、FEMは個別の計算書内に計算式を示している。これに対し当社は、設備の類型化を行うこととしており、機器全体に共通的に適用する評価条件を示した上で、定型式・FEMに関わらず複数機器に共通して用いる計算式を基本方針上に示す構成となる。これらの内容は基本方針の構成違いであることから、記載の展開は必要なく、記載の差異により新たな論点が生じるものではない。 • 類型化に対する考え方については、補足説明資料「【耐震機電07】機器、配管系の類型化に対する分類の考え方について」に示す。

【IV-1-2-1 機器の耐震性に関する計算書作成の基本方針】(2/28)

	再処理施設	発電炉	備考
添付書類IV-1-1	添付書類IV-1-2-1	添付書類V-2-1-1 3-1	
<p>10. 耐震計算の基本方針</p> <p>前述の耐震設計方針に基づいて設計した施設について、耐震計算を行うに当たり、既設工認で実績があり、かつ、最新の知見に照らしても妥当な手法及び条件を用いることを基本とする。</p> <p>評価対象設備である配管系、機器(容器及びポンプ類)及び電気計装品(盤、装置及び器具)のうち、複数設備に共通して適用する計算方法については「IV-1-1-11-1 配管の耐震支持方針」、「IV-1-2 耐震計算書作成の基本方針」及び後次回にて申請する「IV-1-1-11-2 ダクトの耐震支持方針」に示す。</p> <p>10.2 機器・配管系</p> <p>機器・配管系の評価は、「4. 設計用地震力」で示す設計用地震力による適切な応力解析に基づいた地震応力と、組み合わせるべき他の荷重による応力との組合せ応力が「5. 機能維持の基本方針」で示す許容限界内にあることを確認すること(解析による設計)により行う。</p> <p>評価手法は、以下に示す解析法によりJEAG4601に基づき実施することを基本とし、その他の手法を適用する場合は適用性を確認の上適用することとする。なお、時刻歴応答解析法及びスペクトルモーダル解析法を用いる場合は、材料物性のばらつき等を適切に考慮する。</p> <ul style="list-style-type: none"> ・スペクトルモーダル解析法 ・時刻歴応答解析法 ・定式化された計算式を用いた解析法 ・FEM等を用いた応力解析法 <p>機器・配管系については、解析方法及び解析モデルを機器、配管系ごとに設定するとともに、安全機能に応じた評価を行う。</p> <p>これら機器、配管系ごとに適用する解析方法及び解析モデルを「IV-1-1-5 地震応答解析の基本方針」に示す。</p> <p>具体的な評価手法は、「IV-1-1-10 機器の耐震支持方針」、「IV-1-1-11-1 配管の耐震支持方針」、「IV-1-2 耐震計算書作成の基本方針」、「IV-2 再処理施設の耐震性に関する計算書」及び後次回にて申請する「IV-1-1-11-2 ダクトの耐震支持方針」に示す。</p>	<p>1. 概要</p> <p><u>本基本方針は、「IV-1-1 耐震設計の基本方針」に基づき設計した機器が、設計用地震力に対して十分な耐震性を有していることを確認するための耐震計算の方法について説明するものである。</u></p> <p><u>機器の耐震評価は、「IV-1-1-5 地震応答解析の基本方針」に示す解析方法及び解析モデルである、質点系モデルによる定式化された計算式を用いた解析法又は有限要素モデルによる FEM 等を用いた応力解析法を適用して行う。</u></p> <p><u>ここでは、耐震評価の方針及び計算方法について示す。</u></p> <p>2. 耐震評価の方針</p> <p><u>機器の耐震評価は、「IV-1-1 耐震設計の基本方針」の準拠規格に基づき、「IV-1-1-5 地震応答解析の基本方針」の減衰定数を用いた上で、「IV-1-1-8 機能維持の基本方針」にて設定した荷重の組合せを用いて算出した設計用地震力による応力が許容限界内に収まることを確認する。確認結果を示すに当たっては、耐震評価に用いた評価条件の記載方針について示す。</u></p> <p><u>これら、耐震計算のフローについて第 2-1 図に示す。</u></p>		<ul style="list-style-type: none"> ・再処理施設では、計算式を基本方針として示しており、これに伴う申請書上の構成の説明であることから、記載の展開は必要なく、記載の差異により新たな論点が生じるものではない。 ・解析方法及び解析モデルに応じた機器の評価方法を示す添付書類を明記したものであり、記載の差異により新たな論点が生じるものではない。

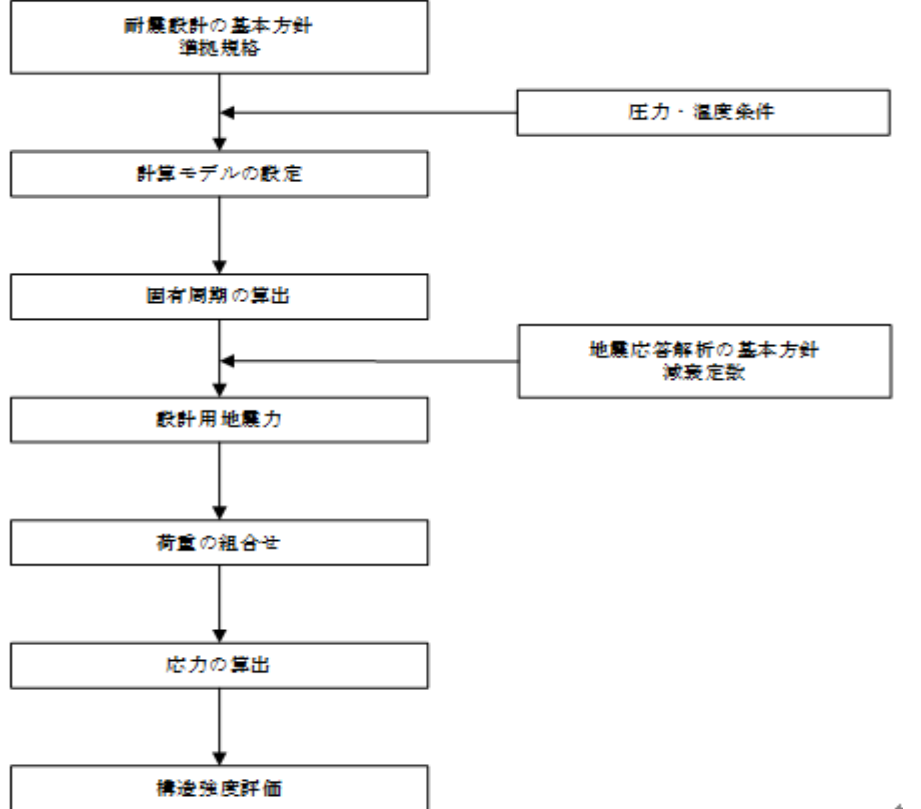
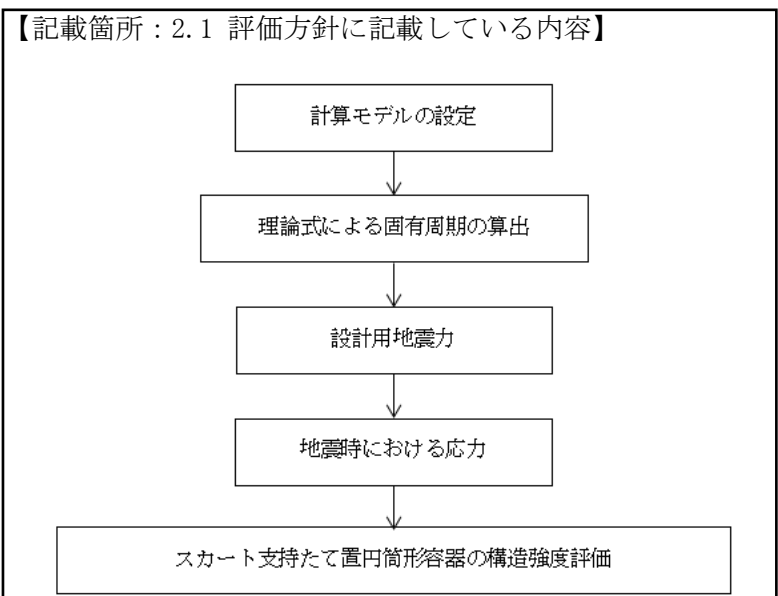
再処理施設	発電炉	備考
添付書類IV-1-1	添付書類IV-1-2-1	添付書類V-2-1-1 3-1
	 <p style="text-align: center;">第 2-1 図 機器の耐震評価のフロー</p>	<p>【記載箇所：2.1 評価方針に記載している内容】</p>  <p>図 2-1 <u>スカート支持たて置円筒形容器</u>の耐震評価フロー</p> <p style="text-align: right;">(14/28) 頁から</p> <p>・発電炉では各機器に応じた評価フローを基本方針又は個別の耐震計算書上に記載しており、当社では全機器に対し共通的な耐震評価フローとなる記載として全体方針を示しているため、記載の差異により新たな論点が生じるものではない。</p>

再処理施設	発電炉	備考
添付書類IV-1-1	添付書類IV-1-2-1	添付書類V-2-1-13-1
	<p>2.1 <u>評価条件の記載方針</u></p> <p>2.1.1 <u>準拠規格</u> <u>準拠規格は、「IV-1-1 耐震設計の基本方針」に示した規格のうち、評価に用いる規格及び年度を記載する。</u></p> <p>2.1.2 <u>圧力・温度条件</u> <u>圧力条件及び温度条件は、設備の本文仕様表に示す最高使用圧力及び最高使用温度を記載する。</u></p> <p>2.1.3 <u>寸法</u> <u>寸法は、原則として公称値を記載する。</u> <u>なお、腐食を考慮する場合においては、「V-3 強度計算書」に示す腐食代を考慮した評価を行う。</u></p>	<p>・発電炉では、各機器の評価条件に対する具体的な適用方法までは記載されていないが、当社では評価条件に対する具体的な適用方法を共通的に基本方針上に示した上で個別の計算書へ展開することから、記載の差異により新たな論点が生じるものではない。</p> <div data-bbox="1804 955 2534 1073" style="border: 1px solid black; padding: 5px;"> <p>【記載箇所：4.1 固有周期の計算方法に記載している内容】 e. 耐震計算に用いる寸法は、公称値を使用する。</p> </div> <div data-bbox="2300 1073 2534 1131" style="border: 1px solid black; padding: 5px; text-align: right;"> <p>(21/28) 頁から</p> </div>

再処理施設	発電炉	備考																																																																																																																																																																														
添付書類IV-1-1	添付書類IV-1-2-1	添付書類V-2-1-13-1																																																																																																																																																																														
	<p>2.1.4 計算精度と数値の丸め方 <u>耐震評価に用いる計算精度は耐震性の結果に影響を及ぼさない桁数を確保する。</u> <u>また、耐震計算書において数値を示す際の数値の丸め方は、原則として第2.1.4-1表に基づき、健全性の確認に影響を与える場合は切上げ、切捨てによる処理をしたうえで表示する。</u></p> <p style="text-align: center;">第2.1.4-1表 表示する数値の丸め方</p> <table border="1" data-bbox="1023 598 1668 1260"> <thead> <tr> <th>数値の種類</th> <th>単位</th> <th>処理桁</th> <th>処理方法</th> <th>表示桁</th> </tr> </thead> <tbody> <tr><td>固有周期</td><td>s</td><td>小数点以下第4位</td><td>四捨五入</td><td>小数点以下第3位</td></tr> <tr><td>震度</td><td>-</td><td>小数点以下第3位</td><td>切上げ</td><td>小数点以下第2位</td></tr> <tr><td>圧力</td><td>MPa</td><td>小数点以下第3位</td><td>四捨五入</td><td>小数点以下第2位</td></tr> <tr><td>温度</td><td>℃</td><td>小数点以下第1位</td><td>四捨五入</td><td>整数</td></tr> <tr><td>比重</td><td>-</td><td>小数点以下第3位</td><td>四捨五入</td><td>小数点以下第2位</td></tr> <tr><td>質量</td><td>kg</td><td>小数点以下第1位</td><td>切上げ</td><td>整数</td></tr> <tr><td>長さ</td><td>mm</td><td>小数点以下第2位</td><td>四捨五入</td><td>小数点以下第1位</td></tr> <tr><td>厚さ</td><td>mm</td><td>小数点以下第2位</td><td>四捨五入</td><td>小数点以下第1位</td></tr> <tr><td>面積</td><td>mm²</td><td>有効数字5桁目</td><td>四捨五入</td><td>有効数字4桁^{*1}</td></tr> <tr><td>力</td><td>N</td><td>有効数字5桁目</td><td>四捨五入</td><td>有効数字4桁^{*1}</td></tr> <tr><td>縦弾性係数</td><td>MPa</td><td>有効数字4桁目</td><td>四捨五入</td><td>有効数字3桁</td></tr> <tr><td>せん断弾性係数</td><td>MPa</td><td>有効数字4桁目</td><td>四捨五入</td><td>有効数字3桁</td></tr> <tr><td>断面係数</td><td>mm³</td><td>有効数字5桁目</td><td>四捨五入</td><td>有効数字4桁^{*1}</td></tr> <tr><td>断面二次モーメント</td><td>mm⁴</td><td>有効数字5桁目</td><td>四捨五入</td><td>有効数字4桁^{*1}</td></tr> <tr><td>ねじりモーメント係数</td><td>mm⁴</td><td>有効数字5桁目</td><td>四捨五入</td><td>有効数字4桁^{*1}</td></tr> <tr><td>ポアソン比</td><td>-</td><td>-</td><td>-</td><td>小数点以下第2位</td></tr> <tr><td>角度</td><td>rad</td><td>小数点以下第4位</td><td>四捨五入</td><td>小数点以下第3位</td></tr> <tr><td>局部ばね定数</td><td>-</td><td>小数点以下第1位</td><td>四捨五入</td><td>整数</td></tr> <tr><td>算出応力</td><td>MPa</td><td>小数点以下第1位</td><td>切上げ</td><td>整数</td></tr> <tr><td>許容応力^{*2}</td><td>MPa</td><td>小数点以下第1位</td><td>切捨て</td><td>整数</td></tr> </tbody> </table> <p>注記 *1: 絶対値が1000以上のときは、べき数表示とする。 *2: JSME S NC1 付録材料図表に記載された温度の中間における引張強さ及び降伏点は、比例法により補間した値の小数点以下第1位を切り捨て、整数位までの値とする。</p>	数値の種類	単位	処理桁	処理方法	表示桁	固有周期	s	小数点以下第4位	四捨五入	小数点以下第3位	震度	-	小数点以下第3位	切上げ	小数点以下第2位	圧力	MPa	小数点以下第3位	四捨五入	小数点以下第2位	温度	℃	小数点以下第1位	四捨五入	整数	比重	-	小数点以下第3位	四捨五入	小数点以下第2位	質量	kg	小数点以下第1位	切上げ	整数	長さ	mm	小数点以下第2位	四捨五入	小数点以下第1位	厚さ	mm	小数点以下第2位	四捨五入	小数点以下第1位	面積	mm ²	有効数字5桁目	四捨五入	有効数字4桁 ^{*1}	力	N	有効数字5桁目	四捨五入	有効数字4桁 ^{*1}	縦弾性係数	MPa	有効数字4桁目	四捨五入	有効数字3桁	せん断弾性係数	MPa	有効数字4桁目	四捨五入	有効数字3桁	断面係数	mm ³	有効数字5桁目	四捨五入	有効数字4桁 ^{*1}	断面二次モーメント	mm ⁴	有効数字5桁目	四捨五入	有効数字4桁 ^{*1}	ねじりモーメント係数	mm ⁴	有効数字5桁目	四捨五入	有効数字4桁 ^{*1}	ポアソン比	-	-	-	小数点以下第2位	角度	rad	小数点以下第4位	四捨五入	小数点以下第3位	局部ばね定数	-	小数点以下第1位	四捨五入	整数	算出応力	MPa	小数点以下第1位	切上げ	整数	許容応力 ^{*2}	MPa	小数点以下第1位	切捨て	整数	<p>【記載箇所: 2.4 計算精度と数値の丸め方に記載している内容】 2.4 計算精度と数値の丸め方 <u>精度は6桁以上を確保する。</u> <u>表示する数値の丸め方は表2-1に示すとおりである。</u></p> <p style="text-align: center;">表2-1 表示する数値の丸め方</p> <table border="1" data-bbox="1810 577 2522 1218"> <thead> <tr> <th>数値の種類</th> <th>単位</th> <th>処理桁</th> <th>処理方法</th> <th>表示桁</th> </tr> </thead> <tbody> <tr><td>固有周期</td><td>s</td><td>小数点以下第4位</td><td>四捨五入</td><td>小数点以下第3位</td></tr> <tr><td>震度</td><td>-</td><td>小数点以下第3位</td><td>切上げ</td><td>小数点以下第2位</td></tr> <tr><td>最高使用圧力</td><td>MPa</td><td>-</td><td>-</td><td>小数点以下第2位</td></tr> <tr><td>温度</td><td>℃</td><td>-</td><td>-</td><td>整数位</td></tr> <tr><td>比重</td><td>-</td><td>小数点以下第3位</td><td>四捨五入</td><td>小数点以下第2位</td></tr> <tr><td>質量</td><td>kg</td><td>-</td><td>-</td><td>整数位</td></tr> <tr><td rowspan="3">長さ</td><td>下記以外の長さ</td><td>mm</td><td>-</td><td>整数位^{*1}</td></tr> <tr><td>胴板の厚さ</td><td>mm</td><td>-</td><td>小数点以下第1位</td></tr> <tr><td>スカート厚さ</td><td>mm</td><td>-</td><td>小数点以下第1位</td></tr> <tr><td>面積</td><td>mm²</td><td>有効数字5桁目</td><td>四捨五入</td><td>有効数字4桁^{*2}</td></tr> <tr><td>モーメント</td><td>N・mm</td><td>有効数字5桁目</td><td>四捨五入</td><td>有効数字4桁^{*2}</td></tr> <tr><td>算出応力</td><td>MPa</td><td>小数点以下第1位</td><td>切上げ</td><td>整数位</td></tr> <tr><td>許容応力^{*3}</td><td>MPa</td><td>小数点以下第1位</td><td>切捨て</td><td>整数位</td></tr> </tbody> </table> <p>注記 *1: 設計上定める値が小数点以下の場合、小数点以下表示とする。 *2: 絶対値が1000以上のときは、べき数表示とする。 *3: 設計・建設規格 付録材料図表に記載された温度の中間における引張強さ及び降伏点は、比例法により補間した値の小数点以下第1位を切り捨て、整数位までの値とする。</p> <p style="text-align: right;">(20/28) 頁から</p>	数値の種類	単位	処理桁	処理方法	表示桁	固有周期	s	小数点以下第4位	四捨五入	小数点以下第3位	震度	-	小数点以下第3位	切上げ	小数点以下第2位	最高使用圧力	MPa	-	-	小数点以下第2位	温度	℃	-	-	整数位	比重	-	小数点以下第3位	四捨五入	小数点以下第2位	質量	kg	-	-	整数位	長さ	下記以外の長さ	mm	-	整数位 ^{*1}	胴板の厚さ	mm	-	小数点以下第1位	スカート厚さ	mm	-	小数点以下第1位	面積	mm ²	有効数字5桁目	四捨五入	有効数字4桁 ^{*2}	モーメント	N・mm	有効数字5桁目	四捨五入	有効数字4桁 ^{*2}	算出応力	MPa	小数点以下第1位	切上げ	整数位	許容応力 ^{*3}	MPa	小数点以下第1位	切捨て	整数位	<p>• 発電炉では、各機器に応じた数値の丸め方を基本方針又は個別の耐震計算書へ示しおり、当社では数値の丸め方を共通的に基本方針上に示した上で個別の計算書へ展開することから、記載の差異により新たな論点が生じるものではない。</p>
数値の種類	単位	処理桁	処理方法	表示桁																																																																																																																																																																												
固有周期	s	小数点以下第4位	四捨五入	小数点以下第3位																																																																																																																																																																												
震度	-	小数点以下第3位	切上げ	小数点以下第2位																																																																																																																																																																												
圧力	MPa	小数点以下第3位	四捨五入	小数点以下第2位																																																																																																																																																																												
温度	℃	小数点以下第1位	四捨五入	整数																																																																																																																																																																												
比重	-	小数点以下第3位	四捨五入	小数点以下第2位																																																																																																																																																																												
質量	kg	小数点以下第1位	切上げ	整数																																																																																																																																																																												
長さ	mm	小数点以下第2位	四捨五入	小数点以下第1位																																																																																																																																																																												
厚さ	mm	小数点以下第2位	四捨五入	小数点以下第1位																																																																																																																																																																												
面積	mm ²	有効数字5桁目	四捨五入	有効数字4桁 ^{*1}																																																																																																																																																																												
力	N	有効数字5桁目	四捨五入	有効数字4桁 ^{*1}																																																																																																																																																																												
縦弾性係数	MPa	有効数字4桁目	四捨五入	有効数字3桁																																																																																																																																																																												
せん断弾性係数	MPa	有効数字4桁目	四捨五入	有効数字3桁																																																																																																																																																																												
断面係数	mm ³	有効数字5桁目	四捨五入	有効数字4桁 ^{*1}																																																																																																																																																																												
断面二次モーメント	mm ⁴	有効数字5桁目	四捨五入	有効数字4桁 ^{*1}																																																																																																																																																																												
ねじりモーメント係数	mm ⁴	有効数字5桁目	四捨五入	有効数字4桁 ^{*1}																																																																																																																																																																												
ポアソン比	-	-	-	小数点以下第2位																																																																																																																																																																												
角度	rad	小数点以下第4位	四捨五入	小数点以下第3位																																																																																																																																																																												
局部ばね定数	-	小数点以下第1位	四捨五入	整数																																																																																																																																																																												
算出応力	MPa	小数点以下第1位	切上げ	整数																																																																																																																																																																												
許容応力 ^{*2}	MPa	小数点以下第1位	切捨て	整数																																																																																																																																																																												
数値の種類	単位	処理桁	処理方法	表示桁																																																																																																																																																																												
固有周期	s	小数点以下第4位	四捨五入	小数点以下第3位																																																																																																																																																																												
震度	-	小数点以下第3位	切上げ	小数点以下第2位																																																																																																																																																																												
最高使用圧力	MPa	-	-	小数点以下第2位																																																																																																																																																																												
温度	℃	-	-	整数位																																																																																																																																																																												
比重	-	小数点以下第3位	四捨五入	小数点以下第2位																																																																																																																																																																												
質量	kg	-	-	整数位																																																																																																																																																																												
長さ	下記以外の長さ	mm	-	整数位 ^{*1}																																																																																																																																																																												
	胴板の厚さ	mm	-	小数点以下第1位																																																																																																																																																																												
	スカート厚さ	mm	-	小数点以下第1位																																																																																																																																																																												
面積	mm ²	有効数字5桁目	四捨五入	有効数字4桁 ^{*2}																																																																																																																																																																												
モーメント	N・mm	有効数字5桁目	四捨五入	有効数字4桁 ^{*2}																																																																																																																																																																												
算出応力	MPa	小数点以下第1位	切上げ	整数位																																																																																																																																																																												
許容応力 ^{*3}	MPa	小数点以下第1位	切捨て	整数位																																																																																																																																																																												

	再処理施設	発電炉	備考
添付書類IV－1－1	添付書類IV－1－2－1	添付書類V－2－1－1 3－1	
	<p>3. <u>耐震計算方法</u> <u>機器の耐震評価に用いる計算式については、定式化された計算式を用いた解析法、有限要素モデルによる FEM 等を用いた応力解析法の評価手法ごとに設定しており、ここではそれぞれの評価手法において適用する計算式を示す。</u></p> <p>3.1 <u>計算式設定の考え方</u> <u>機器の耐震計算における計算式は、JEAG に示されている計算式を基本とし、JEAG に示されていない構造は、JEAG 及び材料力学の計算式を組み合わせ設定する。</u> <u>JEAG に示されている計算式は容器等となっており、そのうち再処理施設の機器は 5 種類が該当する。</u> <u>また、JEAG に示されていない再処理施設特有の構造である機器については、バウンダリの構成の有無に応じて計算式の設定を行っている。バウンダリを有する設備の計算式は JEAG 及び材料力学の計算式を組み合わせ設定し、バウンダリを有していない設備の計算式は材料力学に基づいて設定する。</u> <u>以上のことから、計算式の分類としては 7 分類となる。</u></p> <p>3.2 <u>基本方針に示す計算式の分類</u> <u>a. JEAG に示されている計算式に該当する構造</u> (1) <u>たて置円筒形容器</u> <u>たて置円筒形の容器であり、円筒胴又はスカートにより支持している設備。</u> (2) <u>ラグ支持たて置円筒形容器</u> <u>たて置円筒形の容器であり、胴中央部を支持脚又はラグにより支持している設備。</u> (3) <u>脚支持たて置円筒形容器</u> <u>たて置円筒形の容器であり、本体を脚により支持している設備。</u> (4) <u>横置円筒形容器</u> <u>横置円筒形の容器であり、円筒胴が固定面に対し並行に配置され、支持脚又はラグにより支持している設備。</u> (5) <u>支持部一体型設備</u> <u>本体及び支持部の剛性が高く、一体となる設備。</u> <u>b. 再処理施設特有の構造</u> (6) <u>バウンダリを有する設備</u> <u>バウンダリである容器を有する設備であり、支持脚又はラグにより支持している設備。</u> (7) <u>バウンダリを有していない設備</u> <u>クレーン類等、支持構造部で構成されるバウンダリを有さない設備。</u></p>		<p>・再処理施設では、計算式を基本方針として示しており、これに伴う申請書上の構成の説明であるため、記載の展開は必要なく、記載の差異により新たな論点が生じるものではない。</p> <p>・各基本方針から体系的に整理した内容について、「【耐震機電07】機器、配管系の類型化に対する分類の考え方について」に示す。</p>

【IV－1－2－1 機器の耐震性に関する計算書作成の基本方針】(7/28)

再処理施設	発電炉	備考																																																											
添付書類IV－1－1	添付書類IV－1－2－1	添付書類V－2－1－1 3－1																																																											
	<p>再処理施設の機器の計算式については、これら 7 分類の計算式を基本として、それぞれの構造に応じた計算式の設定を行う。</p> <p>定式化された計算式を用いた解析法の計算式一覧を第 3.2-1 表、FEM 等を用いた応力解析法の計算式一覧を第 3.2-2 表に示す。</p> <p>第 3.2-1 表 定式化された計算式を用いた解析法の計算式一覧*1</p> <table border="1" data-bbox="952 579 1762 1535"> <thead> <tr> <th>計算式の分類</th> <th>別紙番号</th> <th>基本方針名称</th> </tr> </thead> <tbody> <tr> <td rowspan="8">(1)たて置円筒形容器</td> <td>1-1</td> <td>スカート支持たて置円筒形容器の耐震性に関する計算書作成の基本方針</td> </tr> <tr> <td>1-2</td> <td>平底たて置円筒形容器の耐震性に関する計算書作成の基本方針</td> </tr> <tr> <td>1-3</td> <td>溶媒フィルタの耐震性に関する計算書作成の基本方針</td> </tr> <tr> <td>1-4</td> <td>中間支持たて置円筒形容器（フランジ固定）の耐震性に関する計算書作成の基本方針</td> </tr> <tr> <td>1-5</td> <td>スカート支持たて置円筒形容器（耐震設計上の重要度分類Bクラス）の耐震性に関する計算書作成の基本方針</td> </tr> <tr> <td>1-6</td> <td>平底たて置円筒形容器（耐震設計上の重要度分類Bクラス）の耐震性に関する計算書作成の基本方針</td> </tr> <tr> <td>1-7</td> <td>溶媒フィルタ（耐震設計上の重要度分類Bクラス）の耐震性に関する計算書作成の基本方針</td> </tr> <tr> <td>1-8</td> <td>上部スカート支持たて置円筒形容器（耐震設計上の重要度分類Bクラス）の耐震性に関する計算書作成の基本方針</td> </tr> <tr> <td rowspan="4">(2)ラグ支持たて置円筒形容器</td> <td>1-9</td> <td>中間支持たて置円筒形容器（4ラグ支持）の耐震性に関する計算書作成の基本方針</td> </tr> <tr> <td>1-10</td> <td>中間支持たて置円筒形容器（2ラグ支持）の耐震性に関する計算書作成の基本方針</td> </tr> <tr> <td>1-11</td> <td>中間支持たて置円筒形容器（4ラグ支持、耐震設計上の重要度分類Bクラス）の耐震性に関する計算書作成の基本方針</td> </tr> <tr> <td>1-12</td> <td>中間支持たて置円筒形容器（2ラグ支持、耐震設計上の重要度分類Bクラス）の耐震性に関する計算書作成の基本方針</td> </tr> <tr> <td rowspan="2">(3)脚支持たて置円筒形容器</td> <td>1-13</td> <td>四脚たて置円筒形容器の耐震性に関する計算書作成の基本方針</td> </tr> <tr> <td>1-14</td> <td>四脚たて置円筒形容器（耐震設計上の重要度分類Bクラス）の耐震性に関する計算書作成の基本方針</td> </tr> <tr> <td rowspan="12">(4)横置円筒形容器</td> <td>1-15</td> <td>横置一胴円筒形容器の耐震性に関する計算書作成の基本方針</td> </tr> <tr> <td>1-16</td> <td>横置一胴円筒形容器（3脚以上支持）の耐震性に関する計算書作成の基本方針</td> </tr> <tr> <td>1-17</td> <td>デミスタ（2脚支持）の耐震性に関する計算書作成の基本方針</td> </tr> <tr> <td>1-18</td> <td>デミスタ（1脚支持）の耐震性に関する計算書作成の基本方針</td> </tr> <tr> <td>1-19</td> <td>中間支持たて置円筒形容器（1ラグ支持）の耐震性に関する計算書作成の基本方針</td> </tr> <tr> <td>1-20</td> <td>中間支持たて置円筒形容器（長手方向2ラグ支持）の耐震性に関する計算書作成の基本方針</td> </tr> <tr> <td>1-21</td> <td>横置一胴円筒形容器（耐震設計上の重要度分類Bクラス）の耐震性に関する計算書作成の基本方針</td> </tr> <tr> <td>1-22</td> <td>デミスタ（2脚支持、耐震設計上の重要度分類Bクラス）の耐震性に関する計算書作成の基本方針</td> </tr> <tr> <td>1-23</td> <td>デミスタ（1脚支持、耐震設計上の重要度分類Bクラス）の耐震性に関する計算書作成の基本方針</td> </tr> <tr> <td>1-24</td> <td>中間支持たて置円筒形容器（1ラグ支持、耐震設計上の重要度分類Bクラス）の耐震性に関する計算書作成の基本方針</td> </tr> <tr> <td>1-25</td> <td>中間支持たて置円筒形容器（長手方向2ラグ支持、耐震設計上の重要度分類Bクラス）の耐震性に関する計算書作成の基本方針</td> </tr> <tr> <td>1-26</td> <td>中間支持横置円筒形容器（1ラグ支持、耐震設計上の重要度分類Bクラス）の耐震性に関する計算書作成の基本方針</td> </tr> </tbody> </table>	計算式の分類	別紙番号	基本方針名称	(1)たて置円筒形容器	1-1	スカート支持たて置円筒形容器の耐震性に関する計算書作成の基本方針	1-2	平底たて置円筒形容器の耐震性に関する計算書作成の基本方針	1-3	溶媒フィルタの耐震性に関する計算書作成の基本方針	1-4	中間支持たて置円筒形容器（フランジ固定）の耐震性に関する計算書作成の基本方針	1-5	スカート支持たて置円筒形容器（耐震設計上の重要度分類Bクラス）の耐震性に関する計算書作成の基本方針	1-6	平底たて置円筒形容器（耐震設計上の重要度分類Bクラス）の耐震性に関する計算書作成の基本方針	1-7	溶媒フィルタ（耐震設計上の重要度分類Bクラス）の耐震性に関する計算書作成の基本方針	1-8	上部スカート支持たて置円筒形容器（耐震設計上の重要度分類Bクラス）の耐震性に関する計算書作成の基本方針	(2)ラグ支持たて置円筒形容器	1-9	中間支持たて置円筒形容器（4ラグ支持）の耐震性に関する計算書作成の基本方針	1-10	中間支持たて置円筒形容器（2ラグ支持）の耐震性に関する計算書作成の基本方針	1-11	中間支持たて置円筒形容器（4ラグ支持、耐震設計上の重要度分類Bクラス）の耐震性に関する計算書作成の基本方針	1-12	中間支持たて置円筒形容器（2ラグ支持、耐震設計上の重要度分類Bクラス）の耐震性に関する計算書作成の基本方針	(3)脚支持たて置円筒形容器	1-13	四脚たて置円筒形容器の耐震性に関する計算書作成の基本方針	1-14	四脚たて置円筒形容器（耐震設計上の重要度分類Bクラス）の耐震性に関する計算書作成の基本方針	(4)横置円筒形容器	1-15	横置一胴円筒形容器の耐震性に関する計算書作成の基本方針	1-16	横置一胴円筒形容器（3脚以上支持）の耐震性に関する計算書作成の基本方針	1-17	デミスタ（2脚支持）の耐震性に関する計算書作成の基本方針	1-18	デミスタ（1脚支持）の耐震性に関する計算書作成の基本方針	1-19	中間支持たて置円筒形容器（1ラグ支持）の耐震性に関する計算書作成の基本方針	1-20	中間支持たて置円筒形容器（長手方向2ラグ支持）の耐震性に関する計算書作成の基本方針	1-21	横置一胴円筒形容器（耐震設計上の重要度分類Bクラス）の耐震性に関する計算書作成の基本方針	1-22	デミスタ（2脚支持、耐震設計上の重要度分類Bクラス）の耐震性に関する計算書作成の基本方針	1-23	デミスタ（1脚支持、耐震設計上の重要度分類Bクラス）の耐震性に関する計算書作成の基本方針	1-24	中間支持たて置円筒形容器（1ラグ支持、耐震設計上の重要度分類Bクラス）の耐震性に関する計算書作成の基本方針	1-25	中間支持たて置円筒形容器（長手方向2ラグ支持、耐震設計上の重要度分類Bクラス）の耐震性に関する計算書作成の基本方針	1-26	中間支持横置円筒形容器（1ラグ支持、耐震設計上の重要度分類Bクラス）の耐震性に関する計算書作成の基本方針	<p>再処理施設では、計算式を基本方針として示しており、これに伴う申請書上の構成の説明であることから、記載の展開は必要なく、記載の差異により新たな論点が生じるものではない。</p>
計算式の分類	別紙番号	基本方針名称																																																											
(1)たて置円筒形容器	1-1	スカート支持たて置円筒形容器の耐震性に関する計算書作成の基本方針																																																											
	1-2	平底たて置円筒形容器の耐震性に関する計算書作成の基本方針																																																											
	1-3	溶媒フィルタの耐震性に関する計算書作成の基本方針																																																											
	1-4	中間支持たて置円筒形容器（フランジ固定）の耐震性に関する計算書作成の基本方針																																																											
	1-5	スカート支持たて置円筒形容器（耐震設計上の重要度分類Bクラス）の耐震性に関する計算書作成の基本方針																																																											
	1-6	平底たて置円筒形容器（耐震設計上の重要度分類Bクラス）の耐震性に関する計算書作成の基本方針																																																											
	1-7	溶媒フィルタ（耐震設計上の重要度分類Bクラス）の耐震性に関する計算書作成の基本方針																																																											
	1-8	上部スカート支持たて置円筒形容器（耐震設計上の重要度分類Bクラス）の耐震性に関する計算書作成の基本方針																																																											
(2)ラグ支持たて置円筒形容器	1-9	中間支持たて置円筒形容器（4ラグ支持）の耐震性に関する計算書作成の基本方針																																																											
	1-10	中間支持たて置円筒形容器（2ラグ支持）の耐震性に関する計算書作成の基本方針																																																											
	1-11	中間支持たて置円筒形容器（4ラグ支持、耐震設計上の重要度分類Bクラス）の耐震性に関する計算書作成の基本方針																																																											
	1-12	中間支持たて置円筒形容器（2ラグ支持、耐震設計上の重要度分類Bクラス）の耐震性に関する計算書作成の基本方針																																																											
(3)脚支持たて置円筒形容器	1-13	四脚たて置円筒形容器の耐震性に関する計算書作成の基本方針																																																											
	1-14	四脚たて置円筒形容器（耐震設計上の重要度分類Bクラス）の耐震性に関する計算書作成の基本方針																																																											
(4)横置円筒形容器	1-15	横置一胴円筒形容器の耐震性に関する計算書作成の基本方針																																																											
	1-16	横置一胴円筒形容器（3脚以上支持）の耐震性に関する計算書作成の基本方針																																																											
	1-17	デミスタ（2脚支持）の耐震性に関する計算書作成の基本方針																																																											
	1-18	デミスタ（1脚支持）の耐震性に関する計算書作成の基本方針																																																											
	1-19	中間支持たて置円筒形容器（1ラグ支持）の耐震性に関する計算書作成の基本方針																																																											
	1-20	中間支持たて置円筒形容器（長手方向2ラグ支持）の耐震性に関する計算書作成の基本方針																																																											
	1-21	横置一胴円筒形容器（耐震設計上の重要度分類Bクラス）の耐震性に関する計算書作成の基本方針																																																											
	1-22	デミスタ（2脚支持、耐震設計上の重要度分類Bクラス）の耐震性に関する計算書作成の基本方針																																																											
	1-23	デミスタ（1脚支持、耐震設計上の重要度分類Bクラス）の耐震性に関する計算書作成の基本方針																																																											
	1-24	中間支持たて置円筒形容器（1ラグ支持、耐震設計上の重要度分類Bクラス）の耐震性に関する計算書作成の基本方針																																																											
	1-25	中間支持たて置円筒形容器（長手方向2ラグ支持、耐震設計上の重要度分類Bクラス）の耐震性に関する計算書作成の基本方針																																																											
	1-26	中間支持横置円筒形容器（1ラグ支持、耐震設計上の重要度分類Bクラス）の耐震性に関する計算書作成の基本方針																																																											

【IV-1-2-1 機器の耐震性に関する計算書作成の基本方針】(8/28)

再処理施設	発電炉	備考																																												
添付書類IV-1-1	添付書類IV-1-2-1	添付書類V-2-1-1 3-1																																												
	<table border="1" data-bbox="905 321 1751 1073"> <thead> <tr> <th>計算式の分類</th> <th>別紙番号</th> <th>基本方針名称</th> </tr> </thead> <tbody> <tr> <td rowspan="10">(5) 支持部一体型設備</td> <td>1-27</td> <td>横軸ポンプの耐震性に関する計算書作成の基本方針</td> </tr> <tr> <td>1-28</td> <td>ディーゼル機関・発電機の耐震性に関する計算書作成の基本方針</td> </tr> <tr> <td>1-29</td> <td>矩形電気計装設備の耐震性に関する計算書作成の基本方針</td> </tr> <tr> <td>1-30</td> <td>たて軸ポンプの耐震性に関する計算書作成の基本方針</td> </tr> <tr> <td>1-31</td> <td>フィルタユニットの耐震性に関する計算書作成の基本方針</td> </tr> <tr> <td>1-32</td> <td>フィルタユニット(遮蔽体一体形)の耐震性に関する計算書作成の基本方針</td> </tr> <tr> <td>1-33</td> <td>横軸ポンプ(耐震設計上の重要度分類Bクラス)の耐震性に関する計算書作成の基本方針</td> </tr> <tr> <td>1-34</td> <td>たて軸ポンプ(耐震設計上の重要度分類Bクラス)の耐震性に関する計算書作成の基本方針</td> </tr> <tr> <td>1-35</td> <td>フィルタユニット(耐震設計上の重要度分類Bクラス)の耐震性に関する計算書作成の基本方針</td> </tr> <tr> <td>1-36</td> <td>フィルタユニット(遮蔽体一体形、耐震設計上の重要度分類Bクラス)の耐震性に関する計算書作成の基本方針</td> </tr> <tr> <td rowspan="3">(6) バウンダリを有する設備</td> <td>1-37</td> <td>中間支持たて置角形容器(2ラグ支持)の耐震性に関する計算書作成の基本方針</td> </tr> <tr> <td>1-38</td> <td>プレート式熱交換器の耐震性に関する計算書作成の基本方針</td> </tr> <tr> <td>1-39</td> <td>中間支持たて置角形容器(2ラグ支持、耐震設計上の重要度分類Bクラス)の耐震性に関する計算書作成の基本方針</td> </tr> <tr> <td rowspan="6">(7) バウンダリを有しない設備</td> <td>1-40</td> <td>昇降装置の耐震性に関する計算書作成の基本方針</td> </tr> <tr> <td>1-41</td> <td>燃料仮置きラックの耐震性に関する計算書作成の基本方針</td> </tr> <tr> <td>1-42</td> <td>躯体付構造設備の耐震性に関する計算書作成の基本方針</td> </tr> <tr> <td>1-43</td> <td>固定式クレーンの耐震性に関する計算書作成の基本方針</td> </tr> <tr> <td>1-44</td> <td>躯体付構造設備(架構支持)の耐震性に関する計算書作成の基本方針</td> </tr> <tr> <td>1-45</td> <td>天井クレーン(耐震設計上の重要度分類Bクラス)の耐震性に関する計算書作成の基本方針</td> </tr> </tbody> </table> <p data-bbox="926 1140 1786 1234">注記 *1:定型化された計算式を用いた解析法による計算式については、各設備の申請に合わせて説明する予定であり次回以降に詳細を説明する。</p>	計算式の分類	別紙番号	基本方針名称	(5) 支持部一体型設備	1-27	横軸ポンプの耐震性に関する計算書作成の基本方針	1-28	ディーゼル機関・発電機の耐震性に関する計算書作成の基本方針	1-29	矩形電気計装設備の耐震性に関する計算書作成の基本方針	1-30	たて軸ポンプの耐震性に関する計算書作成の基本方針	1-31	フィルタユニットの耐震性に関する計算書作成の基本方針	1-32	フィルタユニット(遮蔽体一体形)の耐震性に関する計算書作成の基本方針	1-33	横軸ポンプ(耐震設計上の重要度分類Bクラス)の耐震性に関する計算書作成の基本方針	1-34	たて軸ポンプ(耐震設計上の重要度分類Bクラス)の耐震性に関する計算書作成の基本方針	1-35	フィルタユニット(耐震設計上の重要度分類Bクラス)の耐震性に関する計算書作成の基本方針	1-36	フィルタユニット(遮蔽体一体形、耐震設計上の重要度分類Bクラス)の耐震性に関する計算書作成の基本方針	(6) バウンダリを有する設備	1-37	中間支持たて置角形容器(2ラグ支持)の耐震性に関する計算書作成の基本方針	1-38	プレート式熱交換器の耐震性に関する計算書作成の基本方針	1-39	中間支持たて置角形容器(2ラグ支持、耐震設計上の重要度分類Bクラス)の耐震性に関する計算書作成の基本方針	(7) バウンダリを有しない設備	1-40	昇降装置の耐震性に関する計算書作成の基本方針	1-41	燃料仮置きラックの耐震性に関する計算書作成の基本方針	1-42	躯体付構造設備の耐震性に関する計算書作成の基本方針	1-43	固定式クレーンの耐震性に関する計算書作成の基本方針	1-44	躯体付構造設備(架構支持)の耐震性に関する計算書作成の基本方針	1-45	天井クレーン(耐震設計上の重要度分類Bクラス)の耐震性に関する計算書作成の基本方針	<p data-bbox="2567 258 2775 646">再処理施設では、計算式を基本方針として示しており、これに伴う申請書上の構成の説明であることから、記載の展開は必要なく、記載の差異により新たな論点が生じるものではない。</p>
計算式の分類	別紙番号	基本方針名称																																												
(5) 支持部一体型設備	1-27	横軸ポンプの耐震性に関する計算書作成の基本方針																																												
	1-28	ディーゼル機関・発電機の耐震性に関する計算書作成の基本方針																																												
	1-29	矩形電気計装設備の耐震性に関する計算書作成の基本方針																																												
	1-30	たて軸ポンプの耐震性に関する計算書作成の基本方針																																												
	1-31	フィルタユニットの耐震性に関する計算書作成の基本方針																																												
	1-32	フィルタユニット(遮蔽体一体形)の耐震性に関する計算書作成の基本方針																																												
	1-33	横軸ポンプ(耐震設計上の重要度分類Bクラス)の耐震性に関する計算書作成の基本方針																																												
	1-34	たて軸ポンプ(耐震設計上の重要度分類Bクラス)の耐震性に関する計算書作成の基本方針																																												
	1-35	フィルタユニット(耐震設計上の重要度分類Bクラス)の耐震性に関する計算書作成の基本方針																																												
	1-36	フィルタユニット(遮蔽体一体形、耐震設計上の重要度分類Bクラス)の耐震性に関する計算書作成の基本方針																																												
(6) バウンダリを有する設備	1-37	中間支持たて置角形容器(2ラグ支持)の耐震性に関する計算書作成の基本方針																																												
	1-38	プレート式熱交換器の耐震性に関する計算書作成の基本方針																																												
	1-39	中間支持たて置角形容器(2ラグ支持、耐震設計上の重要度分類Bクラス)の耐震性に関する計算書作成の基本方針																																												
(7) バウンダリを有しない設備	1-40	昇降装置の耐震性に関する計算書作成の基本方針																																												
	1-41	燃料仮置きラックの耐震性に関する計算書作成の基本方針																																												
	1-42	躯体付構造設備の耐震性に関する計算書作成の基本方針																																												
	1-43	固定式クレーンの耐震性に関する計算書作成の基本方針																																												
	1-44	躯体付構造設備(架構支持)の耐震性に関する計算書作成の基本方針																																												
	1-45	天井クレーン(耐震設計上の重要度分類Bクラス)の耐震性に関する計算書作成の基本方針																																												

【IV－1－2－1 機器の耐震性に関する計算書作成の基本方針】(9/28)

再処理施設	発電炉	備考																																																																		
添付書類IV－1－1	添付書類IV－1－2－1	添付書類V－2－1－1 3－1																																																																		
	<p style="text-align: center;">第3.2-2表 FEM等を用いた応力解析法の計算式一覧*2</p> <table border="1" style="width: 100%; border-collapse: collapse;"> <thead> <tr> <th style="width: 20%;">計算式の分類</th> <th style="width: 10%;">別紙番号</th> <th style="width: 70%;">基本方針名称</th> </tr> </thead> <tbody> <tr><td rowspan="31" style="vertical-align: middle;">(6) バウンダリを有する設備</td><td>2-1</td><td>環状形槽（平底たて置）の耐震性に関する計算書作成の基本方針</td></tr> <tr><td>2-2</td><td>ミキサ・セトラの耐震性に関する計算書作成の基本方針</td></tr> <tr><td>2-3</td><td>バッファチューブ（2ラグ支持）の耐震性に関する計算書作成の基本方針</td></tr> <tr><td>2-4</td><td>グローブボックス等の耐震性に関する計算書作成の基本方針</td></tr> <tr><td>2-5</td><td>平板容器の耐震性に関する計算書作成の基本方針</td></tr> <tr><td>2-6</td><td>環状形バルスカラムの耐震性に関する計算書作成の基本方針</td></tr> <tr><td>2-7</td><td>デミスタの耐震性に関する計算書作成の基本方針</td></tr> <tr><td>2-8</td><td>ラグ支持たて置容器の耐震性に関する計算書作成の基本方針</td></tr> <tr><td>2-9</td><td>シュートの耐震性に関する計算書作成の基本方針</td></tr> <tr><td>2-10</td><td>流路形成板の耐震性に関する計算書作成の基本方針</td></tr> <tr><td>2-11</td><td>円筒形バルスカラムの耐震性に関する計算書作成の基本方針</td></tr> <tr><td>2-12</td><td>バッファチューブ（小口径タイプ）の耐震性に関する計算書作成の基本方針</td></tr> <tr><td>2-13</td><td>充てん塔の耐震性に関する計算書作成の基本方針</td></tr> <tr><td>2-14</td><td>中間支持たて置円筒形容器（4ラグ支持、コイル付）の耐震性に関する計算書作成の基本方針</td></tr> <tr><td>2-15</td><td>スカート支持たて置円筒形容器（コイル付）の耐震性に関する計算書作成の基本方針</td></tr> <tr><td>2-16</td><td>ハル洗浄槽の耐震性に関する計算書作成の基本方針</td></tr> <tr><td>2-17</td><td>ウラン洗浄塔の耐震性に関する計算書作成の基本方針</td></tr> <tr><td>2-18</td><td>よう素追出し塔の耐震性に関する計算書作成の基本方針</td></tr> <tr><td>2-19</td><td>清澄機の耐震性に関する計算書作成の基本方針</td></tr> <tr><td>2-20</td><td>ガラス溶融炉の耐震性に関する計算書作成の基本方針</td></tr> <tr><td>2-21</td><td>セル内クーラの耐震性に関する計算書作成の基本方針</td></tr> <tr><td>2-22</td><td>溶解槽の耐震性に関する計算書作成の基本方針</td></tr> <tr><td>2-23</td><td>高レベル廃液濃縮缶の耐震性に関する計算書作成の基本方針</td></tr> <tr><td>2-24</td><td>補助油水分離槽の耐震性に関する計算書作成の基本方針</td></tr> <tr><td>2-25</td><td>プール水冷却系熱交換器の耐震性に関する計算書作成の基本方針</td></tr> <tr><td>2-26</td><td>ブルトニウム濃縮缶の耐震性に関する計算書作成の基本方針</td></tr> <tr><td>2-27</td><td>環状形槽（平底たて置、耐震設計上の重要度分類Bクラス）の耐震性に関する計算書作成の基本方針</td></tr> <tr><td>2-28</td><td>ミキサ・セトラ（耐震設計上の重要度分類Bクラス）の耐震性に関する計算書作成の基本方針</td></tr> <tr><td>2-29</td><td>バッファチューブ（2ラグ支持、耐震設計上の重要度分類Bクラス）の耐震性に関する計算書作成の基本方針</td></tr> <tr><td>2-30</td><td>円筒形バルスカラム（耐震設計上の重要度分類Bクラス）の耐震性に関する計算書作成の基本方針</td></tr> <tr><td>2-31</td><td>バッファチューブ（小口径タイプ、耐震設計上の重要度分類Bクラス）の耐震性に関する計算書作成の基本方針</td></tr> </tbody> </table>	計算式の分類	別紙番号	基本方針名称	(6) バウンダリを有する設備	2-1	環状形槽（平底たて置）の耐震性に関する計算書作成の基本方針	2-2	ミキサ・セトラの耐震性に関する計算書作成の基本方針	2-3	バッファチューブ（2ラグ支持）の耐震性に関する計算書作成の基本方針	2-4	グローブボックス等の耐震性に関する計算書作成の基本方針	2-5	平板容器の耐震性に関する計算書作成の基本方針	2-6	環状形バルスカラムの耐震性に関する計算書作成の基本方針	2-7	デミスタの耐震性に関する計算書作成の基本方針	2-8	ラグ支持たて置容器の耐震性に関する計算書作成の基本方針	2-9	シュートの耐震性に関する計算書作成の基本方針	2-10	流路形成板の耐震性に関する計算書作成の基本方針	2-11	円筒形バルスカラムの耐震性に関する計算書作成の基本方針	2-12	バッファチューブ（小口径タイプ）の耐震性に関する計算書作成の基本方針	2-13	充てん塔の耐震性に関する計算書作成の基本方針	2-14	中間支持たて置円筒形容器（4ラグ支持、コイル付）の耐震性に関する計算書作成の基本方針	2-15	スカート支持たて置円筒形容器（コイル付）の耐震性に関する計算書作成の基本方針	2-16	ハル洗浄槽の耐震性に関する計算書作成の基本方針	2-17	ウラン洗浄塔の耐震性に関する計算書作成の基本方針	2-18	よう素追出し塔の耐震性に関する計算書作成の基本方針	2-19	清澄機の耐震性に関する計算書作成の基本方針	2-20	ガラス溶融炉の耐震性に関する計算書作成の基本方針	2-21	セル内クーラの耐震性に関する計算書作成の基本方針	2-22	溶解槽の耐震性に関する計算書作成の基本方針	2-23	高レベル廃液濃縮缶の耐震性に関する計算書作成の基本方針	2-24	補助油水分離槽の耐震性に関する計算書作成の基本方針	2-25	プール水冷却系熱交換器の耐震性に関する計算書作成の基本方針	2-26	ブルトニウム濃縮缶の耐震性に関する計算書作成の基本方針	2-27	環状形槽（平底たて置、耐震設計上の重要度分類Bクラス）の耐震性に関する計算書作成の基本方針	2-28	ミキサ・セトラ（耐震設計上の重要度分類Bクラス）の耐震性に関する計算書作成の基本方針	2-29	バッファチューブ（2ラグ支持、耐震設計上の重要度分類Bクラス）の耐震性に関する計算書作成の基本方針	2-30	円筒形バルスカラム（耐震設計上の重要度分類Bクラス）の耐震性に関する計算書作成の基本方針	2-31	バッファチューブ（小口径タイプ、耐震設計上の重要度分類Bクラス）の耐震性に関する計算書作成の基本方針	<ul style="list-style-type: none"> ・再処理施設では、計算式を基本方針として示しており、これに伴う申請書上の構成の説明であることから、記載の展開は必要なく、記載の差異により新たな論点が生じるものではない。 ・FEM等を用いた応力解析法を適用する設備は、複雑な構造に対して解析コードを用いた評価を行うことから、いずれもb. 再処理施設特有の構造として、バウンダリを有する設備又はバウンダリを有していない設備に分類される。
計算式の分類	別紙番号	基本方針名称																																																																		
(6) バウンダリを有する設備	2-1	環状形槽（平底たて置）の耐震性に関する計算書作成の基本方針																																																																		
	2-2	ミキサ・セトラの耐震性に関する計算書作成の基本方針																																																																		
	2-3	バッファチューブ（2ラグ支持）の耐震性に関する計算書作成の基本方針																																																																		
	2-4	グローブボックス等の耐震性に関する計算書作成の基本方針																																																																		
	2-5	平板容器の耐震性に関する計算書作成の基本方針																																																																		
	2-6	環状形バルスカラムの耐震性に関する計算書作成の基本方針																																																																		
	2-7	デミスタの耐震性に関する計算書作成の基本方針																																																																		
	2-8	ラグ支持たて置容器の耐震性に関する計算書作成の基本方針																																																																		
	2-9	シュートの耐震性に関する計算書作成の基本方針																																																																		
	2-10	流路形成板の耐震性に関する計算書作成の基本方針																																																																		
	2-11	円筒形バルスカラムの耐震性に関する計算書作成の基本方針																																																																		
	2-12	バッファチューブ（小口径タイプ）の耐震性に関する計算書作成の基本方針																																																																		
	2-13	充てん塔の耐震性に関する計算書作成の基本方針																																																																		
	2-14	中間支持たて置円筒形容器（4ラグ支持、コイル付）の耐震性に関する計算書作成の基本方針																																																																		
	2-15	スカート支持たて置円筒形容器（コイル付）の耐震性に関する計算書作成の基本方針																																																																		
	2-16	ハル洗浄槽の耐震性に関する計算書作成の基本方針																																																																		
	2-17	ウラン洗浄塔の耐震性に関する計算書作成の基本方針																																																																		
	2-18	よう素追出し塔の耐震性に関する計算書作成の基本方針																																																																		
	2-19	清澄機の耐震性に関する計算書作成の基本方針																																																																		
	2-20	ガラス溶融炉の耐震性に関する計算書作成の基本方針																																																																		
	2-21	セル内クーラの耐震性に関する計算書作成の基本方針																																																																		
	2-22	溶解槽の耐震性に関する計算書作成の基本方針																																																																		
	2-23	高レベル廃液濃縮缶の耐震性に関する計算書作成の基本方針																																																																		
	2-24	補助油水分離槽の耐震性に関する計算書作成の基本方針																																																																		
	2-25	プール水冷却系熱交換器の耐震性に関する計算書作成の基本方針																																																																		
	2-26	ブルトニウム濃縮缶の耐震性に関する計算書作成の基本方針																																																																		
	2-27	環状形槽（平底たて置、耐震設計上の重要度分類Bクラス）の耐震性に関する計算書作成の基本方針																																																																		
	2-28	ミキサ・セトラ（耐震設計上の重要度分類Bクラス）の耐震性に関する計算書作成の基本方針																																																																		
	2-29	バッファチューブ（2ラグ支持、耐震設計上の重要度分類Bクラス）の耐震性に関する計算書作成の基本方針																																																																		
	2-30	円筒形バルスカラム（耐震設計上の重要度分類Bクラス）の耐震性に関する計算書作成の基本方針																																																																		
	2-31	バッファチューブ（小口径タイプ、耐震設計上の重要度分類Bクラス）の耐震性に関する計算書作成の基本方針																																																																		

【IV－1－2－1 機器の耐震性に関する計算書作成の基本方針】(10/28)

再処理施設		発電炉		備考																																						
添付書類IV－1－1	添付書類IV－1－2－1	添付書類V－2－1－13－1																																								
	<table border="1"> <thead> <tr> <th>計算式の分類</th> <th>別紙番号</th> <th>基本方針名称</th> </tr> </thead> <tbody> <tr> <td rowspan="17">(7) バウンダリを有しない設備</td> <td>2－32</td> <td>冷却塔の耐震性に関する計算書作成の基本方針</td> </tr> <tr> <td>2－33</td> <td>通風管の耐震性に関する計算書作成の基本方針</td> </tr> <tr> <td>2－34</td> <td>取納管の耐震性に関する計算書作成の基本方針</td> </tr> <tr> <td>2－35</td> <td>迷路板の耐震性に関する計算書作成の基本方針</td> </tr> <tr> <td>2－36</td> <td>クレーン・台車類の耐震性に関する計算書作成の基本方針</td> </tr> <tr> <td>2－37</td> <td>遮蔽容器付クレーンの耐震性に関する計算書作成の基本方針</td> </tr> <tr> <td>2－38</td> <td>整流板の耐震性に関する計算書作成の基本方針</td> </tr> <tr> <td>2－39</td> <td>架構支持貯蔵設備の耐震性に関する計算書作成の基本方針</td> </tr> <tr> <td>2－40</td> <td>固化セル移送台車の耐震性に関する計算書作成の基本方針</td> </tr> <tr> <td>2－41</td> <td>バスケット搬送機の耐震性に関する計算書作成の基本方針</td> </tr> <tr> <td>2－42</td> <td>トレンチ移送台車の耐震性に関する計算書作成の基本方針</td> </tr> <tr> <td>2－43</td> <td>貯蔵ホールの耐震性に関する計算書作成の基本方針</td> </tr> <tr> <td>2－44</td> <td>燃料貯蔵ラックの耐震性に関する計算書作成の基本方針</td> </tr> <tr> <td>2－45</td> <td>バスケット仮置き架台の耐震性に関する計算書作成の基本方針</td> </tr> <tr> <td>2－46</td> <td>燃料移送水中台車の耐震性に関する計算書作成の基本方針</td> </tr> <tr> <td>2－47</td> <td>第1チャンネルボックス切断装置の耐震性に関する計算書作成の基本方針</td> </tr> <tr> <td>2－48</td> <td>第1バーナブルボイズン切断装置の耐震性に関する計算書作成の基本方針</td> </tr> </tbody> </table> <p>注記 *2: FEM等を用いた応力解析法を用いる機器のうち、冷却塔以外の計算式については、各設備の申請に合わせて説明する予定であり次回以降に詳細を説明する。</p>	計算式の分類	別紙番号	基本方針名称	(7) バウンダリを有しない設備	2－32	冷却塔の耐震性に関する計算書作成の基本方針	2－33	通風管の耐震性に関する計算書作成の基本方針	2－34	取納管の耐震性に関する計算書作成の基本方針	2－35	迷路板の耐震性に関する計算書作成の基本方針	2－36	クレーン・台車類の耐震性に関する計算書作成の基本方針	2－37	遮蔽容器付クレーンの耐震性に関する計算書作成の基本方針	2－38	整流板の耐震性に関する計算書作成の基本方針	2－39	架構支持貯蔵設備の耐震性に関する計算書作成の基本方針	2－40	固化セル移送台車の耐震性に関する計算書作成の基本方針	2－41	バスケット搬送機の耐震性に関する計算書作成の基本方針	2－42	トレンチ移送台車の耐震性に関する計算書作成の基本方針	2－43	貯蔵ホールの耐震性に関する計算書作成の基本方針	2－44	燃料貯蔵ラックの耐震性に関する計算書作成の基本方針	2－45	バスケット仮置き架台の耐震性に関する計算書作成の基本方針	2－46	燃料移送水中台車の耐震性に関する計算書作成の基本方針	2－47	第1チャンネルボックス切断装置の耐震性に関する計算書作成の基本方針	2－48	第1バーナブルボイズン切断装置の耐震性に関する計算書作成の基本方針			<p>・再処理施設では、計算式を基本方針として示しており、これに伴う申請書上の構成の説明であることから、記載の展開は必要なく、記載の差異により新たな論点が生じるものではない。</p>
計算式の分類	別紙番号	基本方針名称																																								
(7) バウンダリを有しない設備	2－32	冷却塔の耐震性に関する計算書作成の基本方針																																								
	2－33	通風管の耐震性に関する計算書作成の基本方針																																								
	2－34	取納管の耐震性に関する計算書作成の基本方針																																								
	2－35	迷路板の耐震性に関する計算書作成の基本方針																																								
	2－36	クレーン・台車類の耐震性に関する計算書作成の基本方針																																								
	2－37	遮蔽容器付クレーンの耐震性に関する計算書作成の基本方針																																								
	2－38	整流板の耐震性に関する計算書作成の基本方針																																								
	2－39	架構支持貯蔵設備の耐震性に関する計算書作成の基本方針																																								
	2－40	固化セル移送台車の耐震性に関する計算書作成の基本方針																																								
	2－41	バスケット搬送機の耐震性に関する計算書作成の基本方針																																								
	2－42	トレンチ移送台車の耐震性に関する計算書作成の基本方針																																								
	2－43	貯蔵ホールの耐震性に関する計算書作成の基本方針																																								
	2－44	燃料貯蔵ラックの耐震性に関する計算書作成の基本方針																																								
	2－45	バスケット仮置き架台の耐震性に関する計算書作成の基本方針																																								
	2－46	燃料移送水中台車の耐震性に関する計算書作成の基本方針																																								
	2－47	第1チャンネルボックス切断装置の耐震性に関する計算書作成の基本方針																																								
	2－48	第1バーナブルボイズン切断装置の耐震性に関する計算書作成の基本方針																																								

再処理施設	発電炉	備考				
添付書類IV-1-1	添付書類IV-1-2-1	添付書類V-2-1-13-1				
	<p>3.3 疲労評価の計算式 <u>構造強度評価において、地震動のみによる一次+二次応力の変動値が「IV-1-1-8 機能維持の基本方針」に示す許容限界 $2S_y$ を超える場合に適用する疲労評価の計算式を第3.3-1表に示す。</u></p> <p style="text-align: center;"><u>第3.3-1表 疲労評価の計算式一覧</u></p> <table border="1" data-bbox="943 493 1742 581"> <thead> <tr> <th>別紙番号</th> <th>耐震計算書作成の基本方針名称</th> </tr> </thead> <tbody> <tr> <td>3-1</td> <td>疲労評価（簡易弾塑性解析）に関する計算書作成の基本方針</td> </tr> </tbody> </table>	別紙番号	耐震計算書作成の基本方針名称	3-1	疲労評価（簡易弾塑性解析）に関する計算書作成の基本方針	<p>・発電炉では、疲労評価の計算式を管の基本方針又は評価対象機器の耐震計算書上に示しており、当社では、共通的となる計算式として疲労評価の計算式を本方針上に示すことから、記載の差異により新たな論点が生じるものではない。</p>
別紙番号	耐震計算書作成の基本方針名称					
3-1	疲労評価（簡易弾塑性解析）に関する計算書作成の基本方針					

再処理施設		発電炉	備考
添付書類IV-1-1	添付書類IV-1-2-1	添付書類V-2-1-13-1	
	<p>【IV-1-2-1 別紙2-32 冷却塔の耐震性に関する計算書作成の基本方針】</p> <p style="text-align: center;">目次</p> <p>1. 概要</p> <p>2. 準拠規格</p> <p>3. 構造強度評価</p> <p>3.1 構造の説明</p> <p>3.2 評価方針</p> <p>3.2.1 計算条件</p> <p>3.2.2 解析モデルの設定方法</p> <p>3.2.3 荷重の組合せ及び許容応力</p> <p>3.2.4 計算方法</p> <p>3.3 評価</p> <p>4. 動的機能維持評価</p> <p>4.1 構造の説明</p> <p>4.2 評価方針</p> <p>4.2.1 計算条件</p> <p>4.2.2 解析モデルの設定方法</p> <p>4.2.3 荷重の組合せ及び許容値</p> <p>4.2.4 計算方法</p> <p>4.3 評価</p>	<p>V-2-1-13-1 スカート支持たて置円筒形容器の耐震性についての計算書作成の基本方針</p> <p style="text-align: center;">目次</p> <p>1. 概要</p> <p>2. 一般事項</p> <p>2.1 評価方針</p> <p>2.2 適用基準</p> <p>2.3 記号の説明</p> <p>2.4 計算精度と数値の丸め方</p> <p>3. 評価部位</p> <p>4. 固有周期</p> <p>4.1 固有周期の計算方法</p> <p>5. 構造強度評価</p> <p>5.1 構造強度評価方法</p> <p>5.2 設計用地震力</p> <p>5.3 計算方法</p> <p>5.4 応力の評価</p> <p>6. 耐震計算書のフォーマット</p>	<ul style="list-style-type: none"> 本基本方針に対する発電炉との比較としては、比較対象が無いことから、類似する基本方針との比較を行う。確認内容としては、記載内容の比較ではなく、構成に対する確認を行うことが目的であるため、本比較による記載の差異により新たな論点が生じるものではない。 本基本方針内容を含む基本的な計算書の記載内容に対する比較については、補足説明資料「【耐震機電19】機電設備の耐震計算書の作成について」に示す。

【IV－1－2－1 機器の耐震性に関する計算書作成の基本方針】(13/28)

再処理施設	発電炉	備考							
添付書類IV－1－1	添付書類IV－1－2－1	添付書類V－2－1－1 3－1							
	<p>1. 概要 本基本方針は、<u>冷却塔の耐震性について、「IV－1－1 耐震設計の基本方針」に基づき、十分な構造強度及び動的機能を有していることを確認するための計算方法を示すものである。なお、計算方法にかかわらず設備全体に適用する評価条件については、「IV－1－2－1 機器の耐震性に関する計算書作成の基本方針」の2. 耐震評価の方針に示す。</u></p> <p>2. 準拠規格 「IV－1－1 耐震設計の基本方針」に示す規格のうち、本評価に対する準拠規格について第2-1表に示す。</p> <p style="text-align: center;">第2-1表 準拠規格</p> <table border="1" data-bbox="943 940 1715 1222"> <thead> <tr> <th>準拠規格名</th> </tr> </thead> <tbody> <tr> <td>原子力発電所耐震設計技術指針 JEAG4601-1987</td> </tr> <tr> <td>原子力発電所耐震設計技術指針 重要度分類・許容応力編 JEAG4601・補-1984</td> </tr> <tr> <td>原子力発電所耐震設計技術指針 JEAG4601-1991 追補版</td> </tr> <tr> <td>建築基準法・同施行令</td> </tr> <tr> <td>発電用原子力設備規格 設計・建設規格(2005年版(2007年追補版を含む)) <第I編 軽水炉規格> JSME S NC1-2005/2007*</td> </tr> </tbody> </table> <p>注記 * : JSME S NC1以外に使用している鉄鋼材料の規格については、「V－2 強度計算方法」における添付－1「容器等の材料及び構造に関する設計の基本方針」に定められた値を準用することとする。</p> <p>3. 構造強度評価 3.1 構造の説明 <u>冷却塔は、伝熱管、遮熱板、ファン駆動部及びルーバとこれら全体を支持する支持架構によって構成される。</u> <u>冷却塔の耐震評価は、伝熱管、伝熱管を束ねる管束、上載機器を支持する支持架構、遮熱板、ファン及びルーバを固定するボルト部に対して実施する。</u></p>	準拠規格名	原子力発電所耐震設計技術指針 JEAG4601-1987	原子力発電所耐震設計技術指針 重要度分類・許容応力編 JEAG4601・補-1984	原子力発電所耐震設計技術指針 JEAG4601-1991 追補版	建築基準法・同施行令	発電用原子力設備規格 設計・建設規格(2005年版(2007年追補版を含む)) <第I編 軽水炉規格> JSME S NC1-2005/2007*	<p>1. 概要 本基本方針は、添付書類「V-2-1-1 耐震設計の基本方針の概要」に基づき、<u>耐震性に関する説明書が求められているスカート支持たて置円筒形容器（耐震設計上の重要度分類Sクラス又はS。機能維持の計算を行うもの）が、十分な耐震性を有していることを確認するための耐震計算の方法について記載したものである。</u> (15/28) 頁へ</p> <p>解析の方針及び減衰定数については、添付書類「V-2-1-6 地震応答解析の基本方針」に従うものとする。</p> <p>ただし、本基本方針が適用できないスカート支持たて置円筒形容器にあつては、個別耐震計算書にその耐震計算方法を含めて記載する。</p> <p>【記載箇所：2.2 適用基準に記載している内容】 2.2 適用基準 適用基準を以下に示す。</p> <p>(1) 原子力発電所耐震設計技術指針 JEAG4601－1987（日本電気協会） (2) 原子力発電所耐震設計技術指針 重要度分類・許容応力編 JEAG4601・補－1984（日本電気協会） (3) 原子力発電所耐震設計技術指針 JEAG4601－1991 追補版（日本電気協会） (4) 発電用原子力設備規格 設計・建設規格（2005年版（2007年追補版含む。）） JSME S NC1－2005/2007（日本機械学会）</p> <p>(17/28) 頁から</p> <p>【記載箇所：3. 評価部位に記載している内容】 3. 評価部位 <u>スカート支持たて置円筒形容器の耐震評価は「5.1 構造強度評価方法」に示す条件に基づき、耐震評価上厳しくなる胴、スカート及び基礎ボルトについて評価を実施する。</u></p> <p>(20/28) 頁から</p>	<p>・設備の違いによる記載の差異はあるが、記載項目は合致しており、新たな論点が生じるものではない。</p> <p>・設備の違いによる記載の差異はあるが、記載項目は合致しており、新たな論点が生じるものではない。</p> <p>・設備の違いによる記載の差異はあるが、記載項目は合致しており、新たな論点が生じるものではない。</p>
準拠規格名									
原子力発電所耐震設計技術指針 JEAG4601-1987									
原子力発電所耐震設計技術指針 重要度分類・許容応力編 JEAG4601・補-1984									
原子力発電所耐震設計技術指針 JEAG4601-1991 追補版									
建築基準法・同施行令									
発電用原子力設備規格 設計・建設規格(2005年版(2007年追補版を含む)) <第I編 軽水炉規格> JSME S NC1-2005/2007*									

【IV-1-2-1 機器の耐震性に関する計算書作成の基本方針】(14/28)

再処理施設	発電炉	備考
添付書類IV-1-1	添付書類IV-1-2-1	添付書類V-2-1-13-1
	<p>3.2 評価方針</p> <p><u>冷却塔の耐震評価では、解析により固有周期を求め、解析モデルを用いた地震応答解析を行ったのち応力評価を行う。</u></p>	<p>2. 一般事項</p> <p>2.1 評価方針</p> <p>(16/28) 頁へ</p> <p><u>スカート支持たて置円筒形容器の応力評価は、添付書類「V-2-1-9 機能維持の基本方針」のうち「3.1 構造強度上の制限」にて設定した荷重及び荷重の組合せ並びに許容限界に基づき、「3. 評価部位」にて設定する箇所において、「4. 固有周期」で算出した固有周期に基づく設計用地震力による応力等が許容限界内に収まることを、「5. 構造強度評価」にて示す方法にて確認することで実施する。確認結果を「6. 耐震計算書のフォーマット」にて示す。</u></p> <p><u>スカート支持たて置円筒形容器の耐震評価フローを図 2-1 に示す。</u></p> <div data-bbox="1804 693 2537 1281" data-label="Diagram"> <pre> graph TD A[計算モデルの設定] --> B[理論式による固有周期の算出] B --> C[設計用地震力] C --> D[地震時における応力] D --> E[スカート支持たて置円筒形容器の構造強度評価] </pre> <p>図 2-1 スカート支持たて置円筒形容器の耐震評価フロー</p> <p>(3/28) 頁へ</p> </div>

・設備の違いによる記載の差異はあるが、記載項目は合致しており、新たな論点が生じるものではない。

【IV-1-2-1 機器の耐震性に関する計算書作成の基本方針】(15/28)

再処理施設	発電炉	備考
添付書類IV-1-1	添付書類IV-1-2-1	添付書類V-2-1-13-1
	<p>3.2.1 計算条件 <u>計算条件は、「IV-1-1-8 機能維持の基本方針」にて設定した耐震設計上の重要度分類</u>に応じた入力地震動に対し、「IV-1-1-6 設計用床応答曲線の作成方針」に基づき算定した設備据付位置の設計用地震力を用いる。</p> <p>また、減衰定数については、「IV-1-1-5 地震応答解析の基本方針」に基づき、設備の種類、構造等に応じて適用する。</p> <p>3.2.2 解析モデルの設定方法 <u>冷却塔は、ファン駆動部、管束、ルーバ及び遮熱板とこれら全体を支持する支持架構によって構成している複合構造物であることから、はり要素又は板要素を用いた3次元モデルとする。</u> <u>支持架構は、柱材、はり材及びブレースにより構成し、各部材を溶接又はボルトにより接合し、柱脚部は基礎ボルトにより基礎コンクリートに固定している。</u> <u>ファン駆動部は、ファンとこれを駆動する原動機及び減速機により構成し、原動機及び減速機は、取付ボルトで支持架構のコモンベッドに固定している。</u> <u>管束は、伝熱管(フィンチューブ)、ヘッダとこれらを支持するチューブサポート及び管束フレームより構成し、管束フレームは、取付ボルトで支持架構の床はりに固定している。</u> <u>ルーバは、ルーバフレームに支持され、ルーバフレームは、取付ボルトで管束フレーム上部あるいは支持架構上に固定している。</u> <u>遮熱板は、鋼板により構成し、鋼板は取付ボルト又は溶接により支持架構に固定している。</u> <u>支持架構により支持するファン駆動部、管束、ルーバ及び遮熱板は、いずれも高い剛性を有することから、構造をモデル化するのではなく支持架構への質量としてモデル化する。ただし、伝熱管本体を評価する場合は、はり要素を用いた3次元モデルとする。</u></p>	<p>【記載箇所：5.1 構造強度評価方法に記載している内容】 <u>(1)地震力は容器に対して水平方向及び鉛直方向から作用するものとする。</u> 【記載箇所：5.2 設計用地震力に記載している内容】 <u>「弾性設計用地震動S_d又は静的震度」及び「基準地震動S_s」による地震力は、添付書類「V-2-1-7 設計用床応答曲線の作成方針」に基づき設定する。</u> 【記載箇所：5.3.1 応力の計算方法に記載している内容】 <u>応力計算における水平方向と鉛直方向の組合せについて、静的地震力を用いる場合は絶対値を用いる。動的地震力を用いる場合は、絶対値和又はSRS法を用いる。</u></p> <p>(21/28) 頁から</p> <p>【記載箇所：1. 概要に記載している内容】 <u>解析の方針及び減衰定数については、添付書類「V-2-1-6 地震応答解析の基本方針」に従うものとする。</u></p> <p>(13/28) 頁から</p> <p>【記載箇所：4.1 固有周期の計算方法に記載している内容】 <u>(1) 計算モデル</u> <u>モデル化に当たっては次の条件で行う。</u> <u>a. 容器及び内容物の質量は重心に集中するものとする。</u> <u>b. 容器はスカートで支持され、スカートは下端のベースプレート</u> <u>を円周上等ピッチの多数の基礎ボルトで基礎に固定されており、固定端とする。</u> <u>c. 胴とスカートをはりと考え、変形モードは曲げ及びせん断変形を考慮する。</u> <u>d. スカートを部材において、マンホール等の開口部があつて補強をしていない場合は、欠損の影響を考慮する。</u> <u>e. 耐震計算に用いる寸法は、公称値を使用する。</u> <u>本容器は、前記の条件より図4-1に示す下端固定の1質点系振動モデルあるいは下端固定上端支持の1質点系振動モデルとして考える。</u></p> <p>(21/28) 頁から</p> <p>・地震力及び地震力の組合せ方法については、「IV-1-1-8 機能維持の基本方針」の内容を呼び込むことを3.2.1計算条件に記載しており、記載の差異により新たな論点が生じるものではない。 ・設備の違いによる記載の差異はあるが、記載項目は合致しており、新たな論点が生じるものではない。 ・設備の違いによる記載の差異はあるが、記載項目は合致しており、新たな論点が生じるものではない。</p>

再処理施設	発電炉	備考
添付書類IV-1-1	添付書類IV-1-2-1	添付書類V-2-1-1 3-1
	<p>3.2.3 荷重の組合せ及び許容応力</p> <p>3.2.3.1 荷重の組合せ</p> <p>荷重の組合せは、「IV-1-1-8 機能維持の基本方針(b.配管系, e.支持構造物)」に基づき設定する。</p> <p>冷却塔は屋外に配置される設備であることから、下記に示す積雪荷重及び風荷重を考慮する。</p> <p>考慮する荷重については、「IV-1-1-8 機能維持の基本方針」第3.1-3表に基づき設定する。</p> <p>(1) 積雪荷重</p> <p>屋上のルーバ及び歩廊上に積雪荷重を考慮する。</p> <p>(2) 風荷重</p> <p>風圧力による荷重は、建築基準法施行令第87条及び平成12年建設省告示第1454号に従い、地表面粗度区分Ⅱ、地方の区分に応じて定められた風速34m/s及び建屋形状を考慮して算出した風力係数Cを用いて算出する。</p> $W_w = q \cdot C \cdot A$ <p>ここで、</p> $q = 0.6 \cdot E' \cdot V_0^2$ $E' = E_r^2 \cdot G_f$ $E_r = 1.7 \cdot (H/ZG)^\alpha \quad (H > Z_b \text{ より})$ <p><u>W_w : 短期風荷重 (N)</u> <u>q : 速度圧 (N/m²)</u> <u>C : 風力係数</u> <u>A : 風向に垂直な面に投影した面積 (m²)</u> <u>E' : 速度圧の高さ方向の分布を示す係数 (平12建告第1454号による)</u> <u>E_r : 平均風速の高さ方向の分布係数</u> <u>G_f : ガスト影響係数 (G_f=1.0)</u> <u>V₀ : その地方における基準風速 (平12建告第1454号により, 34 [m/s])</u> <u>H : 建築物の高さと軒の高さとの平均 (m)</u> <u>Z_b : 地表面粗度区分に応じたパラメータ (Z_b=5[m])</u> <u>ZG : 地表面粗度区分に応じたパラメータ (ZG=350[m])</u> <u>α : 地表面粗度区分に応じたパラメータ (α=0.15)</u></p> <p>3.2.3.2 許容応力</p> <p>許容応力は、「IV-1-1-8 機能維持の基本方針(b.配管系, e.支持構造物)」に基づく。</p>	<p>(14/28) 頁から</p> <p>【記載箇所：2.1 評価方針に記載している内容】 スカート支持たて置円筒形容器の応力評価は、添付書類「V-2-1-9 機能維持の基本方針」のうち「3.1 構造強度上の制限」にて設定した荷重及び荷重の組合せ並びに許容限界に基づき、「3. 評価部位」にて設定する箇所において、「4. 固有周期」で算出した固有周期に基づく設計用地震力による応力等が許容限界内に収まることを、「5. 構造強度評価」にて示す方法にて確認することで実施する。</p> <p>(14/28) 頁から</p> <p>【記載箇所：2.1 評価方針に記載している内容】 スカート支持たて置円筒形容器の応力評価は、添付書類「V-2-1-9 機能維持の基本方針」のうち「3.1 構造強度上の制限」にて設定した荷重及び荷重の組合せ並びに許容限界に基づき、「3. 評価部位」にて設定する箇所において、「4. 固有周期」で算出した固有周期に基づく設計用地震力による応力等が許容限界内に収まることを、「5. 構造強度評価」にて示す方法にて確認することで実施する。</p>
		<p>・設備の違いによる記載の差異はあるが、記載項目は合致しており、新たな論点が生じるものではない。</p> <p>・本設備に対して考慮する荷重については、補足説明資料「【耐震機電13】既設工認からの変更点について」に示す。</p> <p>・設備の違いによる記載の差異はあるが、記載項目は合致しており、新たな論点が生じるものではない。</p>

再処理施設		発電炉	備考
添付書類IV-1-1	添付書類IV-1-2-1	添付書類V-2-1-13-1	
		<p>2.2 適用基準 適用基準を以下に示す。</p> <ul style="list-style-type: none"> (1) 原子力発電所耐震設計技術指針 J E A G 4 6 0 1 - 1987 (日本電気協会) (2) 原子力発電所耐震設計技術指針 重要度分類・許容応力編 J E A G 4 6 0 1 ・補-1984 (日本電気協会) (3) 原子力発電所耐震設計技術指針 J E A G 4 6 0 1 - 1991 追補版 (日本電気協会) (4) 発電用原子力設備規格 設計・建設規格 (2005年版 (2007年追補版含む。)) J S M E S N C 1 - 2005/2007 (日本機械学会) 	
		(13/28) 頁へ	

【IV-1-2-1 機器の耐震性に関する計算書作成の基本方針】(18/28)

再処理施設	発電炉	備考																																																																																																																																																																												
添付書類IV-1-1	添付書類IV-1-2-1	添付書類V-2-1-13-1																																																																																																																																																																												
	<p>3.2.4 計算方法 耐震計算は、本項に示す方法に基づく。</p> <p>3.2.4.1 記号の説明</p> <table border="1" data-bbox="905 388 1765 1480"> <thead> <tr> <th>記号</th> <th>表示内容</th> <th>単位</th> </tr> </thead> <tbody> <tr><td>A</td><td>支持架構部材の断面積</td><td>mm²</td></tr> <tr><td>A_S</td><td>支持架構部材のせん断面積</td><td>mm²</td></tr> <tr><td>A_b</td><td>原動機、管束等の取付ボルトの軸断面積</td><td>mm²</td></tr> <tr><td>A_{ab}</td><td>基礎ボルトの軸断面積</td><td>mm²</td></tr> <tr><td>C_H</td><td>水平方向設計震度</td><td>—</td></tr> <tr><td>C_P</td><td>ファン駆動部の振動による震度</td><td>—</td></tr> <tr><td>C_V</td><td>鉛直方向設計震度</td><td>—</td></tr> <tr><td>D_o</td><td>伝熱管の外径</td><td>mm</td></tr> <tr><td>F</td><td>「JSME S NC1」SSB-3121.1(1)に定める値</td><td>MPa</td></tr> <tr><td>F*</td><td>「JSME S NC1」SSB-3121.1(1)に定める値 ただし、「S_y」及びを「1.2S_y」と読み替える</td><td>MPa</td></tr> <tr><td>F_b</td><td>支持架構に作用する軸力</td><td>N</td></tr> <tr><td>F_{bs}</td><td>基礎ボルトに作用するせん断力</td><td>N</td></tr> <tr><td>F_{bt}</td><td>基礎ボルトに作用する引張力</td><td>N</td></tr> <tr><td>1.5f_t, 1.5f_t*</td><td>支持架構の許容引張応力</td><td>MPa</td></tr> <tr><td>1.5f_s, 1.5f_s*</td><td>支持架構の許容せん断応力</td><td>MPa</td></tr> <tr><td>1.5f_c, 1.5f_c*</td><td>支持架構の許容圧縮応力</td><td>MPa</td></tr> <tr><td>1.5f_b, 1.5f_b*</td><td>支持架構の許容曲げ応力</td><td>MPa</td></tr> <tr><td>1.5f_{so}, 1.5f_{so}*</td><td>せん断力のみを受けるボルトの許容せん断応力</td><td>MPa</td></tr> <tr><td>1.5f_{ts}, 1.5f_{ts}*</td><td>引張力とせん断力を同時に受けるボルトの許容引張応力</td><td>MPa</td></tr> <tr><td>f_{to}</td><td>引張力のみを受けるボルトの許容引張応力</td><td>MPa</td></tr> <tr><td>h</td><td>取付ボルトから重心までの高さ</td><td>mm</td></tr> <tr><td>i₁</td><td>応力係数で「JSME S NC1」PPC-3810に規定する値又は、1.33のいずれか大きい方の値</td><td>—</td></tr> </tbody> </table>	記号	表示内容	単位	A	支持架構部材の断面積	mm ²	A _S	支持架構部材のせん断面積	mm ²	A _b	原動機、管束等の取付ボルトの軸断面積	mm ²	A _{ab}	基礎ボルトの軸断面積	mm ²	C _H	水平方向設計震度	—	C _P	ファン駆動部の振動による震度	—	C _V	鉛直方向設計震度	—	D _o	伝熱管の外径	mm	F	「JSME S NC1」SSB-3121.1(1)に定める値	MPa	F*	「JSME S NC1」SSB-3121.1(1)に定める値 ただし、「S _y 」及びを「1.2S _y 」と読み替える	MPa	F _b	支持架構に作用する軸力	N	F _{bs}	基礎ボルトに作用するせん断力	N	F _{bt}	基礎ボルトに作用する引張力	N	1.5f _t , 1.5f _t *	支持架構の許容引張応力	MPa	1.5f _s , 1.5f _s *	支持架構の許容せん断応力	MPa	1.5f _c , 1.5f _c *	支持架構の許容圧縮応力	MPa	1.5f _b , 1.5f _b *	支持架構の許容曲げ応力	MPa	1.5f _{so} , 1.5f _{so} *	せん断力のみを受けるボルトの許容せん断応力	MPa	1.5f _{ts} , 1.5f _{ts} *	引張力とせん断力を同時に受けるボルトの許容引張応力	MPa	f _{to}	引張力のみを受けるボルトの許容引張応力	MPa	h	取付ボルトから重心までの高さ	mm	i ₁	応力係数で「JSME S NC1」PPC-3810に規定する値又は、1.33のいずれか大きい方の値	—	<p>2.3 記号の説明</p> <table border="1" data-bbox="1810 388 2531 1459"> <thead> <tr> <th>記号</th> <th>記号の説明</th> <th>単位</th> </tr> </thead> <tbody> <tr><td>A</td><td>胴の軸断面積</td><td>mm²</td></tr> <tr><td>A_b</td><td>基礎ボルトの軸断面積</td><td>mm²</td></tr> <tr><td>A_o</td><td>胴の有効せん断断面積</td><td>mm²</td></tr> <tr><td>A_s</td><td>スカートの軸断面積</td><td>mm²</td></tr> <tr><td>A_{so}</td><td>スカートの有効せん断断面積</td><td>mm²</td></tr> <tr><td>C_o</td><td>基礎ボルト計算における係数</td><td>—</td></tr> <tr><td>C_H</td><td>水平方向設計震度</td><td>—</td></tr> <tr><td>C_t</td><td>基礎ボルト計算における係数</td><td>—</td></tr> <tr><td>C_V</td><td>鉛直方向設計震度</td><td>—</td></tr> <tr><td>D_{bi}</td><td>ベースプレートの内径</td><td>mm</td></tr> <tr><td>D_{bo}</td><td>ベースプレートの外径</td><td>mm</td></tr> <tr><td>D_e</td><td>基礎ボルトのピッチ円直径</td><td>mm</td></tr> <tr><td>D_i</td><td>胴の内径</td><td>mm</td></tr> <tr><td>D_j</td><td>スカートに設けられた各開口部の穴径 (j=1, 2, 3…j_i)</td><td>mm</td></tr> <tr><td>D_s</td><td>スカートの内径</td><td>mm</td></tr> <tr><td>E</td><td>胴の縦弾性係数</td><td>MPa</td></tr> <tr><td>E_s</td><td>スカートの縦弾性係数</td><td>MPa</td></tr> <tr><td>e</td><td>基礎ボルト計算における係数</td><td>—</td></tr> <tr><td>F</td><td>設計・建設規格 SSB-3121.1又はSSB-3131に定める値</td><td>MPa</td></tr> <tr><td>F*</td><td>設計・建設規格 SSB-3121.3又はSSB-3133に定める値</td><td>MPa</td></tr> <tr><td>F_o</td><td>基礎に作用する圧縮力</td><td>N</td></tr> <tr><td>F_t</td><td>基礎ボルトに作用する引張力</td><td>N</td></tr> <tr><td>f_b</td><td>曲げモーメントに対する許容座屈応力</td><td>MPa</td></tr> <tr><td>f_c</td><td>軸圧縮荷重に対する許容座屈応力</td><td>MPa</td></tr> <tr><td>f_{sb}</td><td>せん断力のみを受ける基礎ボルトの許容せん断応力 (f_sを1.5倍した値又は f_{so}を1.5倍した値)</td><td>MPa</td></tr> <tr><td>f_t</td><td>スカートの許容引張応力 (f_tを1.5倍した値又は f_{to}を1.5倍した値)</td><td>MPa</td></tr> <tr><td>f_{to}</td><td>引張力のみを受ける基礎ボルトの許容引張応力 (f_tを1.5倍した値又は f_{to}を1.5倍した値)</td><td>MPa</td></tr> <tr><td>f_{ts}</td><td>引張力とせん断力を同時に受ける基礎ボルトの許容引張応力</td><td>MPa</td></tr> <tr><td>G</td><td>胴のせん断弾性係数</td><td>MPa</td></tr> <tr><td>G_s</td><td>スカートのせん断弾性係数</td><td>MPa</td></tr> <tr><td>g</td><td>重力加速度 (= 9.80665)</td><td>m/s²</td></tr> <tr><td>H</td><td>水頭</td><td>mm</td></tr> <tr><td>I</td><td>胴の断面二次モーメント</td><td>mm⁴</td></tr> </tbody> </table> <p>(記号の説明については、評価対象によって異なることから個別の内容に対する比較はせず、これ以降の頁の発電炉側の記載を省略する。)</p>	記号	記号の説明	単位	A	胴の軸断面積	mm ²	A _b	基礎ボルトの軸断面積	mm ²	A _o	胴の有効せん断断面積	mm ²	A _s	スカートの軸断面積	mm ²	A _{so}	スカートの有効せん断断面積	mm ²	C _o	基礎ボルト計算における係数	—	C _H	水平方向設計震度	—	C _t	基礎ボルト計算における係数	—	C _V	鉛直方向設計震度	—	D _{bi}	ベースプレートの内径	mm	D _{bo}	ベースプレートの外径	mm	D _e	基礎ボルトのピッチ円直径	mm	D _i	胴の内径	mm	D _j	スカートに設けられた各開口部の穴径 (j=1, 2, 3…j _i)	mm	D _s	スカートの内径	mm	E	胴の縦弾性係数	MPa	E _s	スカートの縦弾性係数	MPa	e	基礎ボルト計算における係数	—	F	設計・建設規格 SSB-3121.1又はSSB-3131に定める値	MPa	F*	設計・建設規格 SSB-3121.3又はSSB-3133に定める値	MPa	F _o	基礎に作用する圧縮力	N	F _t	基礎ボルトに作用する引張力	N	f _b	曲げモーメントに対する許容座屈応力	MPa	f _c	軸圧縮荷重に対する許容座屈応力	MPa	f _{sb}	せん断力のみを受ける基礎ボルトの許容せん断応力 (f _s を1.5倍した値又は f _{so} を1.5倍した値)	MPa	f _t	スカートの許容引張応力 (f _t を1.5倍した値又は f _{to} を1.5倍した値)	MPa	f _{to}	引張力のみを受ける基礎ボルトの許容引張応力 (f _t を1.5倍した値又は f _{to} を1.5倍した値)	MPa	f _{ts}	引張力とせん断力を同時に受ける基礎ボルトの許容引張応力	MPa	G	胴のせん断弾性係数	MPa	G _s	スカートのせん断弾性係数	MPa	g	重力加速度 (= 9.80665)	m/s ²	H	水頭	mm	I	胴の断面二次モーメント	mm ⁴	<p>・設備の違いによる記載の差異はあるが、記載項目は合致しており、新たな論点が生じるものではない。</p>
記号	表示内容	単位																																																																																																																																																																												
A	支持架構部材の断面積	mm ²																																																																																																																																																																												
A _S	支持架構部材のせん断面積	mm ²																																																																																																																																																																												
A _b	原動機、管束等の取付ボルトの軸断面積	mm ²																																																																																																																																																																												
A _{ab}	基礎ボルトの軸断面積	mm ²																																																																																																																																																																												
C _H	水平方向設計震度	—																																																																																																																																																																												
C _P	ファン駆動部の振動による震度	—																																																																																																																																																																												
C _V	鉛直方向設計震度	—																																																																																																																																																																												
D _o	伝熱管の外径	mm																																																																																																																																																																												
F	「JSME S NC1」SSB-3121.1(1)に定める値	MPa																																																																																																																																																																												
F*	「JSME S NC1」SSB-3121.1(1)に定める値 ただし、「S _y 」及びを「1.2S _y 」と読み替える	MPa																																																																																																																																																																												
F _b	支持架構に作用する軸力	N																																																																																																																																																																												
F _{bs}	基礎ボルトに作用するせん断力	N																																																																																																																																																																												
F _{bt}	基礎ボルトに作用する引張力	N																																																																																																																																																																												
1.5f _t , 1.5f _t *	支持架構の許容引張応力	MPa																																																																																																																																																																												
1.5f _s , 1.5f _s *	支持架構の許容せん断応力	MPa																																																																																																																																																																												
1.5f _c , 1.5f _c *	支持架構の許容圧縮応力	MPa																																																																																																																																																																												
1.5f _b , 1.5f _b *	支持架構の許容曲げ応力	MPa																																																																																																																																																																												
1.5f _{so} , 1.5f _{so} *	せん断力のみを受けるボルトの許容せん断応力	MPa																																																																																																																																																																												
1.5f _{ts} , 1.5f _{ts} *	引張力とせん断力を同時に受けるボルトの許容引張応力	MPa																																																																																																																																																																												
f _{to}	引張力のみを受けるボルトの許容引張応力	MPa																																																																																																																																																																												
h	取付ボルトから重心までの高さ	mm																																																																																																																																																																												
i ₁	応力係数で「JSME S NC1」PPC-3810に規定する値又は、1.33のいずれか大きい方の値	—																																																																																																																																																																												
記号	記号の説明	単位																																																																																																																																																																												
A	胴の軸断面積	mm ²																																																																																																																																																																												
A _b	基礎ボルトの軸断面積	mm ²																																																																																																																																																																												
A _o	胴の有効せん断断面積	mm ²																																																																																																																																																																												
A _s	スカートの軸断面積	mm ²																																																																																																																																																																												
A _{so}	スカートの有効せん断断面積	mm ²																																																																																																																																																																												
C _o	基礎ボルト計算における係数	—																																																																																																																																																																												
C _H	水平方向設計震度	—																																																																																																																																																																												
C _t	基礎ボルト計算における係数	—																																																																																																																																																																												
C _V	鉛直方向設計震度	—																																																																																																																																																																												
D _{bi}	ベースプレートの内径	mm																																																																																																																																																																												
D _{bo}	ベースプレートの外径	mm																																																																																																																																																																												
D _e	基礎ボルトのピッチ円直径	mm																																																																																																																																																																												
D _i	胴の内径	mm																																																																																																																																																																												
D _j	スカートに設けられた各開口部の穴径 (j=1, 2, 3…j _i)	mm																																																																																																																																																																												
D _s	スカートの内径	mm																																																																																																																																																																												
E	胴の縦弾性係数	MPa																																																																																																																																																																												
E _s	スカートの縦弾性係数	MPa																																																																																																																																																																												
e	基礎ボルト計算における係数	—																																																																																																																																																																												
F	設計・建設規格 SSB-3121.1又はSSB-3131に定める値	MPa																																																																																																																																																																												
F*	設計・建設規格 SSB-3121.3又はSSB-3133に定める値	MPa																																																																																																																																																																												
F _o	基礎に作用する圧縮力	N																																																																																																																																																																												
F _t	基礎ボルトに作用する引張力	N																																																																																																																																																																												
f _b	曲げモーメントに対する許容座屈応力	MPa																																																																																																																																																																												
f _c	軸圧縮荷重に対する許容座屈応力	MPa																																																																																																																																																																												
f _{sb}	せん断力のみを受ける基礎ボルトの許容せん断応力 (f _s を1.5倍した値又は f _{so} を1.5倍した値)	MPa																																																																																																																																																																												
f _t	スカートの許容引張応力 (f _t を1.5倍した値又は f _{to} を1.5倍した値)	MPa																																																																																																																																																																												
f _{to}	引張力のみを受ける基礎ボルトの許容引張応力 (f _t を1.5倍した値又は f _{to} を1.5倍した値)	MPa																																																																																																																																																																												
f _{ts}	引張力とせん断力を同時に受ける基礎ボルトの許容引張応力	MPa																																																																																																																																																																												
G	胴のせん断弾性係数	MPa																																																																																																																																																																												
G _s	スカートのせん断弾性係数	MPa																																																																																																																																																																												
g	重力加速度 (= 9.80665)	m/s ²																																																																																																																																																																												
H	水頭	mm																																																																																																																																																																												
I	胴の断面二次モーメント	mm ⁴																																																																																																																																																																												

【IV-1-2-1 機器の耐震性に関する計算書作成の基本方針】(19/28)

再処理施設		発電炉		備考
添付書類IV-1-1	添付書類IV-1-2-1		添付書類V-2-1-13-1	
記号	表 示 内 容	単 位		
i_2	応力係数で「JSME S NC1」PPC-3810に規定する値又は、1.0のいずれか大きい方の値	—		・設備の違いによる記載の差異はあるが、記載項目は合致しており、新たな論点が生じるものではない。
L	取付ボルト間の距離	mm		
M_a	自重により伝熱管に作用するモーメント	N・mm		
M_b	地震により伝熱管に作用するモーメント	N・mm		
M	支持架構に作用するモーメント	N・mm		
M_c	地震動による相対変位により伝熱管に生じるモーメントの全振幅	N・mm		
M_p	ファン駆動部の回転により作用するモーメント	N・mm		
M_b^*	地震動の慣性力により伝熱管に生じるモーメントの全振幅	N・mm		
N	原動機の回転数	rpm		
n	せん断力を受ける取付ボルトの評価本数	—		
n_a	柱脚部1個当たりの基礎ボルト本数	—		
n_t	引張力の作用する取付ボルトの評価本数	—		
P	伝熱管の最高使用圧力	MPa		
P_m	原動機の出力量	kW		
Q_b	支持架構に作用するせん断力	N		
S_a	伝熱管の許容応力	MPa		
S_n	伝熱管の一次+二次応力の変動値	MPa		
t	伝熱管の板厚	mm		
m	原動機、管束等の質量	kg		
g	重力加速度 (=9.80665)	m/s ²		
W_w	原動機、管束等に作用する風荷重	N		
Z_f	伝熱管の断面係数	mm ³		
Z	支持架構の断面係数	mm ³		
σ_b	支持架構に生じる曲げ応力	MPa		
σ_c	支持架構に生じる圧縮応力	MPa		
σ_f	伝熱管の一次応力	MPa		
σ_o	取付ボルトに生じる引張応力	MPa		
σ_t	支持架構に生じる引張応力	MPa		
σ_{ao}	基礎ボルトに生じる引張応力	MPa		
τ	支持架構に生じるせん断応力	MPa		
τ_b	取付ボルトに生じるせん断応力	MPa		
τ_{ao}	基礎ボルトに生じるせん断応力	MPa		

再処理施設		発電炉		備考																																																																				
添付書類IV-1-1	添付書類IV-1-2-1	添付書類V-2-1-13-1																																																																						
		<p>2.4 計算精度と数値の丸め方 精度は6桁以上を確保する。 表示する数値の丸め方は表2-1に示すとおりである。</p> <p>表2-1 表示する数値の丸め方</p> <table border="1"> <thead> <tr> <th>数値の種類</th> <th>単位</th> <th>処理桁</th> <th>処理方法</th> <th>表示桁</th> </tr> </thead> <tbody> <tr> <td>固有周期</td> <td>s</td> <td>小数点以下第4位</td> <td>四捨五入</td> <td>小数点以下第3位</td> </tr> <tr> <td>震度</td> <td>—</td> <td>小数点以下第3位</td> <td>切上げ</td> <td>小数点以下第2位</td> </tr> <tr> <td>最高使用圧力</td> <td>MPa</td> <td>—</td> <td>—</td> <td>小数点以下第2位</td> </tr> <tr> <td>温度</td> <td>℃</td> <td>—</td> <td>—</td> <td>整数位</td> </tr> <tr> <td>比重</td> <td>—</td> <td>小数点以下第3位</td> <td>四捨五入</td> <td>小数点以下第2位</td> </tr> <tr> <td>質量</td> <td>kg</td> <td>—</td> <td>—</td> <td>整数位</td> </tr> <tr> <td rowspan="3">長さ</td> <td>下記以外の長さ</td> <td>mm</td> <td>—</td> <td>整数位^{*1}</td> </tr> <tr> <td>胴板の厚さ</td> <td>mm</td> <td>—</td> <td>小数点以下第1位</td> </tr> <tr> <td>スカート厚さ</td> <td>mm</td> <td>—</td> <td>小数点以下第1位</td> </tr> <tr> <td>面積</td> <td>mm²</td> <td>有効数字5桁目</td> <td>四捨五入</td> <td>有効数字4桁^{*2}</td> </tr> <tr> <td>モーメント</td> <td>N・mm</td> <td>有効数字5桁目</td> <td>四捨五入</td> <td>有効数字4桁^{*2}</td> </tr> <tr> <td>算出応力</td> <td>MPa</td> <td>小数点以下第1位</td> <td>切上げ</td> <td>整数位</td> </tr> <tr> <td>許容応力^{*3}</td> <td>MPa</td> <td>小数点以下第1位</td> <td>切捨て</td> <td>整数位</td> </tr> </tbody> </table> <p>注記 *1:設計上定める値が小数点以下の場合は、小数点以下表示とする。 *2:絶対値が1000以上のときは、べき数表示とする。 *3:設計・建設規格 付録材料図表に記載された温度の間における引張強さ及び降伏点は、比例法により補間した値の小数点以下第1位を切り捨て、整数位までの値とする。</p> <p style="text-align: right;">(5/28) 頁へ</p>		数値の種類	単位	処理桁	処理方法	表示桁	固有周期	s	小数点以下第4位	四捨五入	小数点以下第3位	震度	—	小数点以下第3位	切上げ	小数点以下第2位	最高使用圧力	MPa	—	—	小数点以下第2位	温度	℃	—	—	整数位	比重	—	小数点以下第3位	四捨五入	小数点以下第2位	質量	kg	—	—	整数位	長さ	下記以外の長さ	mm	—	整数位 ^{*1}	胴板の厚さ	mm	—	小数点以下第1位	スカート厚さ	mm	—	小数点以下第1位	面積	mm ²	有効数字5桁目	四捨五入	有効数字4桁 ^{*2}	モーメント	N・mm	有効数字5桁目	四捨五入	有効数字4桁 ^{*2}	算出応力	MPa	小数点以下第1位	切上げ	整数位	許容応力 ^{*3}	MPa	小数点以下第1位	切捨て	整数位	
数値の種類	単位	処理桁	処理方法	表示桁																																																																				
固有周期	s	小数点以下第4位	四捨五入	小数点以下第3位																																																																				
震度	—	小数点以下第3位	切上げ	小数点以下第2位																																																																				
最高使用圧力	MPa	—	—	小数点以下第2位																																																																				
温度	℃	—	—	整数位																																																																				
比重	—	小数点以下第3位	四捨五入	小数点以下第2位																																																																				
質量	kg	—	—	整数位																																																																				
長さ	下記以外の長さ	mm	—	整数位 ^{*1}																																																																				
	胴板の厚さ	mm	—	小数点以下第1位																																																																				
	スカート厚さ	mm	—	小数点以下第1位																																																																				
面積	mm ²	有効数字5桁目	四捨五入	有効数字4桁 ^{*2}																																																																				
モーメント	N・mm	有効数字5桁目	四捨五入	有効数字4桁 ^{*2}																																																																				
算出応力	MPa	小数点以下第1位	切上げ	整数位																																																																				
許容応力 ^{*3}	MPa	小数点以下第1位	切捨て	整数位																																																																				
		<p>3. 評価部位 スカート支持たて置円筒形容器の耐震評価は「5.1 構造強度評価方法」に示す条件に基づき、耐震評価上厳しくなる胴、スカート及び基礎ボルトについて評価を実施する。</p> <p style="text-align: right;">(13/28) 頁へ</p>																																																																						

【IV-1-2-1 機器の耐震性に関する計算書作成の基本方針】(21/28)

再処理施設	発電炉	備考
添付書類IV-1-1	添付書類IV-1-2-1	添付書類V-2-1-1 3-1
		<p>4. 固有周期 4.1 固有周期の計算方法 <u>スカート支持たて置円筒形容器の固有周期の計算方法を以下に示す。</u> (4/28), (15/28) 頁へ</p> <p>(1) 計算モデル モデル化に当たっては次の条件で行う。 a. 容器及び内容物の質量は重心に集中するものとする。 b. 容器はスカートで支持され、スカートは下端のベースプレート_レを円周上等ピッチの多数の基礎ボルトで基礎に固定されており、固定端とする。 c. 胴とスカートをはりと考え、変形モードは曲げ及びせん断変形を考慮する。 d. スカート部材において、マンホール等の開口部があって補強をしていない場合は、欠損の影響を考慮する。 e. 耐震計算に用いる寸法は、公称値を使用する。 本容器は、前記の条件より図4-1に示す下端固定の1質点系振動モデルあるいは下端固定上端支持の1質点系振動モデルとして考える。</p> <p>(固有周期の計算モデル及び計算方法については、各設備によって異なることから個別の内容に対する比較はせず、発電炉側の記載を省略する。)</p> <p>5. 構造強度評価 5.1 構造強度評価方法 <u>4.1項 a.～e.のほか、次の条件で計算する。</u> (15/28) 頁へ</p> <p>(1) 地震力は容器に対して水平方向及び鉛直方向から作用するものとする。概要図を図5-1に示す。 (概要図については、各設備によって異なることから個別の内容に対する比較はせず、発電炉側の記載を省略する。)</p> <p>5.2 設計用地震力 「弾性設計用地震動S_d又は静的震度」及び「基準地震動S_s」による地震力は、添付書類「V-2-1-7 設計用床応答曲線の作成方針」に基づき設定する。 (15/28) 頁へ</p> <p>5.3 計算方法 5.3.1 応力の計算方法 <u>応力計算における水平方向と鉛直方向の組合せについて、静的地震力を用いる場合は絶対値和を用いる。動的地震力を用いる場合は、絶対値和又はSRSS法を用いる。</u> (15/28) 頁へ</p>

・設備の違いによる記載の差異はあるが、記載項目は合致しており、新たな論点が生じるものではない。

・設備の違いによる記載の差異はあるが、記載項目は合致しており、新たな論点が生じるものではない。
 ・地震力の組合せ方法については、

再処理施設	発電炉	備考
添付書類IV-1-1	添付書類IV-1-2-1	添付書類V-2-1-13-1
	<p><u>3.2.4.2 伝熱管の応力</u> <u>伝熱管の一次応力σ_f及び一次+二次応力S_nは、次式により算出する。</u> <u>(1)一次応力</u> 一次応力は、次式で表される。 $\sigma_f = \frac{PD_o}{4t} + \frac{0.75i_1(M_a+M_b)}{Z_f} \dots\dots\dots (3.2.4.2-1)$ <u>(2)一次+二次応力</u> 一次+二次応力は、次式で表される。 $S_n = \frac{0.75i_1M_b^*+i_2M_c}{Z_f} \dots\dots\dots (3.2.4.2-2)$</p> <p><u>3.2.4.3 取付ボルトの応力</u> <u>原動機、減速機、ファンリングサポート、遮熱板、管束及びルーバ取付ボルトに生じる引張応力σ_o及びせん断応力τ_bは、次式により算出する。</u> <u>また、原動機及び減速機取付ボルトの応力計算に際しては、地震力に併せて振動による震度及び回転によるモーメントを考慮する。なお、風荷重については、設備形状により必要に応じて考慮する。</u></p> <p><u>(1)引張応力</u> <u>引張応力は、次式で表される。</u> <u>a. 角形配置の場合</u> 取付ボルトに対する引張力は、取付ボルトを支点とする転倒を考え、これを片側のボルトで受けるものとする。 なお、自重より鉛直方向設計震度が大きい場合は、浮上り力である上方向に作用する力が引張力として作用する。 $\sigma_o = \frac{g(m(C_H+C_P)h - \frac{mL}{2}(1-C_V-C_P)) + M_P+W_w h}{n_t A_b L} \dots\dots\dots (3.2.4.3-1)$ ここで、 $M_P = \left(\frac{60}{2\pi N} \right) \times 10^6 P_m \dots\dots\dots (3.2.4.3-2)$ <u>b. 円形配置の場合</u> 取付ボルトに対する引張力は、支点から正比例した力が作用するものとし、最も厳しい条件として支点から最も離れたボルトについて計算する。 なお、自重より鉛直方向設計震度が大きい場合は、浮上り力である上方向に作用する力が引張力として作用する。 $\sigma_o = \frac{mC_H g h}{3/8 A_b n_t L} - \frac{mL(1-C_V)g}{2A_b n_t} \dots\dots\dots (3.2.4.3-3)$</p>	<p><u>5.3.1.1 胴の計算方法</u> <u>5.3.1.2 スカートの計算方法</u> <u>5.3.1.3 基礎ボルトの計算方法</u></p> <p>(計算方法については、各評価部位によって異なることから個別の内容に対する比較はせず、発電炉側の記載を省略する。)</p> <p>「IV-1-1-8 機能維持の基本方針」の内容を呼び込むことを3.2.1計算条件に記載しており、記載の差異により新たな論点が生じるものではない。</p> <p>・設備の違いによる記載の差異はあるが、記載項目は合致しており、新たな論点が生じるものではない。</p>

再処理施設	発電炉	備考
添付書類IV-1-1	添付書類IV-1-2-1	添付書類V-2-1-13-1
	<p>(2)せん断応力 <u>せん断応力は、次式で表される。</u> <u>なお、取付ボルトに作用するせん断荷重は、取付ボルトの全本数で受けるものとして計算する。</u></p> $\tau_b = \frac{mg(C_H+C_P)+W_w}{A_b n_t} \dots\dots\dots (3.2.4.3-4)$ <p>3.2.4.4 支持架構の応力 <u>支持架構の引張応力σ_t、圧縮応力σ_c、せん断応力τ及び曲げ応力σ_bは、次式により算出する。</u></p> <p>(1) 引張応力 <u>引張応力は、次式で表される。</u></p> $\sigma_t = \frac{F_b}{A} \quad (\text{ただし, } F_b \geq 0) \quad \dots\dots\dots (3.2.4.4-1)$ <p>(2) 圧縮応力 <u>圧縮応力は、次式で表される。</u></p> $\sigma_c = -\frac{F_b}{A} \quad (\text{ただし, } F_b < 0) \quad \dots\dots\dots (3.2.4.4-2)$ <p>(3) せん断応力 <u>せん断応力は、次式で表される。</u></p> $\tau = \frac{Q_b}{A_s} \quad \dots\dots\dots (3.2.4.4-3)$ <p>(4) 曲げ応力 <u>曲げ応力は、次式で表される。</u></p> $\sigma_b = \frac{M}{Z} \quad \dots\dots\dots (3.2.4.4-4)$ <p>(5) 組合せ応力 <u>1) 圧縮力と曲げモーメント</u> <u>圧縮力と曲げモーメントを同時に受ける部材の応力は、次式を満足すること。</u> <u>なお、基準地震動S_sによる評価ではf_cをf_c^*、f_bをf_b^*に読み替える。</u></p> $\frac{\sigma_c}{1.5f_c} + \frac{\sigma_b}{1.5f_b} \leq 1 \quad \dots\dots\dots (3.2.4.4-5)$ <p><u>2) 引張力と曲げモーメント</u> <u>引張力と曲げモーメントを同時に受ける部材の応力は、次式を満足すること。</u> <u>なお、基準地震動S_sによる評価ではf_tをf_t^*に読み替える。</u></p> $\frac{\sigma_t + \sigma_b}{1.5f_t} \leq 1 \quad \dots\dots\dots (3.2.4.4-6)$	<p>・設備の違いによる記載の差異はあるが、記載項目は合致しており、新たな論点が生じるものではない。</p>

【IV-1-2-1 機器の耐震性に関する計算書作成の基本方針】(24/28)

再処理施設	発電炉	備考												
添付書類IV-1-1	添付書類IV-1-2-1	添付書類V-2-1-13-1												
	<p>3.2.4.5 基礎ボルトの応力 <u>基礎ボルトの引張応力σ_{a0}及びせん断応力τ_{a0}は、次式により算出する。</u> (1)引張応力 <u>引張応力は、次式で表される。</u> なお、基礎ボルトに作用する引抜き力は、当該柱脚部の基礎ボルト全本数で受けるものとして計算する。 $\sigma_{a0} = \frac{F_{bt}}{A_{ab}n_a} \dots\dots\dots (3.2.4.5-1)$ (2)せん断応力 <u>せん断応力は、次式で表される。</u> なお、基礎ボルトに作用するせん断力は、当該柱脚部の基礎ボルト全本数で受けるものとして計算する。 $\tau_{a0} = \frac{F_{bs}}{A_{ab}n_a} \dots\dots\dots (3.2.4.5-2)$</p> <p>3.3 評価 <u>3.2.4項で算出した応力が3.2.3.2項の許容応力以下であること。</u> ここで、3.2.4.3項で算出した取付ボルトの引張応力σ_0は、下記2式より算出した許容引張応力$1.5f_{ts}$以下であること。なお、基準地震動S_sによる評価ではf_{ts}をf_{ts}^*に読み替える。 $1.5f_{ts} = 1.4f_{t0} - 1.6\tau_b \dots\dots\dots (3.3-1)$ $1.5f_{ts} \leq f_{t0} \dots\dots\dots (3.3-2)$ また、3.2.4.5項で算出した基礎ボルトの引張応力σ_{a0}は、下記2式より算出した許容引張応力$1.5f_{ts}$以下であること。なお、基準地震動S_sによる評価ではf_{ts}をf_{ts}^*に読み替える。 $1.5f_{ts} = 1.4f_{t0} - 1.6\tau_{a0} \dots\dots\dots (3.3-3)$ $1.5f_{ts} \leq f_{t0} \dots\dots\dots (3.3-4)$</p>	<p>5.4 応力の評価 5.4.1 胴の応力評価 5.3.1.1項で求めた組合せ応力が胴の最高使用温度における許容応力S_a以下であること。ただし、S_aは下表による。</p> <table border="1" data-bbox="1855 892 2374 1228"> <thead> <tr> <th rowspan="2">応力の種類</th> <th colspan="2">許容応力S_a</th> </tr> <tr> <th>弾性設計用地震動S_e又は静的震度による荷重との組合せの場合</th> <th>管理地震動S_mによる荷重との組合せの場合</th> </tr> </thead> <tbody> <tr> <td>一次一般応力</td> <td>設計降伏点S_yと設計引張強さS_uの0.6倍のいずれか小さい方の値。ただし、オーステナイト系ステンレス鋼及び高ニッケル合金にあっては許容引張応力Sの1.2倍の方が大きい場合は、この大きい方の値とする。</td> <td>設計引張強さS_uの0.6倍</td> </tr> <tr> <td>一次応力と二次応力の和</td> <td colspan="2">地震動のみによる一次応力と二次応力の和の変動値が設計降伏点S_yの2倍以下であれば、疲労解析は不要とする。</td> </tr> </tbody> </table> <p>一次応力の評価は算出応力が一次一般応力と同じ値であるので省略する。</p> <p>5.4.2 スカートの応力評価 5.4.3 基礎ボルトの応力評価</p> <p>(応力の評価については、評価部位によって異なることから個別の内容に対する比較はせず、発電炉側の記載を省略する。)</p> <p>6. 耐震計算書のフォーマット <u>スカート支持たて置円筒形容器の耐震計算書のフォーマットは、以下の通りである。</u></p>	応力の種類	許容応力 S_a		弾性設計用地震動 S_e 又は静的震度による荷重との組合せの場合	管理地震動 S_m による荷重との組合せの場合	一次一般応力	設計降伏点 S_y と設計引張強さ S_u の0.6倍のいずれか小さい方の値。ただし、オーステナイト系ステンレス鋼及び高ニッケル合金にあっては許容引張応力 S の1.2倍の方が大きい場合は、この大きい方の値とする。	設計引張強さ S_u の0.6倍	一次応力と二次応力の和	地震動のみによる一次応力と二次応力の和の変動値が設計降伏点 S_y の2倍以下であれば、疲労解析は不要とする。		<p>・設備の違いによる記載の差異はあるが、記載項目は合致しており、新たな論点が生じるものではない。</p> <p>・設備の違いによる記載の差異はあるが、記載項目は合致しており、新たな論点が生じるものではない。</p> <p>・FEM評価における耐震計算書のフォーマットについては、設備によって項目が増減するため、当社では計算書構成を含めたサンプルを補足説明資料「【耐震機電19】機電設備の耐震計算書の作成について」に示す。</p>
応力の種類	許容応力 S_a													
	弾性設計用地震動 S_e 又は静的震度による荷重との組合せの場合	管理地震動 S_m による荷重との組合せの場合												
一次一般応力	設計降伏点 S_y と設計引張強さ S_u の0.6倍のいずれか小さい方の値。ただし、オーステナイト系ステンレス鋼及び高ニッケル合金にあっては許容引張応力 S の1.2倍の方が大きい場合は、この大きい方の値とする。	設計引張強さ S_u の0.6倍												
一次応力と二次応力の和	地震動のみによる一次応力と二次応力の和の変動値が設計降伏点 S_y の2倍以下であれば、疲労解析は不要とする。													

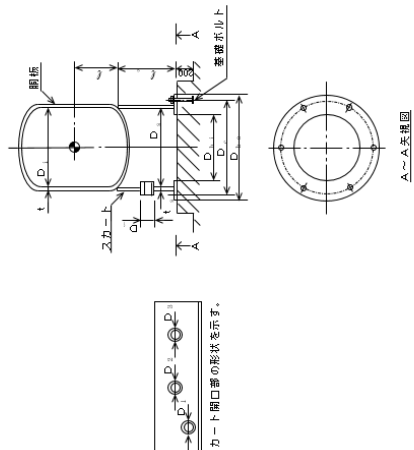
再処理施設	再処理施設	発電炉	備考																																																																																																
添付書類IV-1-1	添付書類IV-1-2-1	添付書類V-2-1-13-1																																																																																																	
		<p>【フォーマット】 設計書等対象施設としての評価結果 【○○○○】 機器の耐震性に関する計算結果 1. 設計書等対象施設 1.1 設計条件</p> <table border="1" data-bbox="1869 315 1973 1407"> <thead> <tr> <th rowspan="2">機 器 名 称</th> <th rowspan="2">耐震設計上の 標準系分類</th> <th rowspan="2">耐震設計上の 標準系分類 (n)</th> <th colspan="2">開口幅及び床間高さ (m)</th> <th colspan="2">固有周期 (s)</th> <th colspan="2">弾性設計用地震動 S_e 又は静的地震動 S_s</th> <th colspan="2">基準地 震動 S_g</th> <th rowspan="2">耐震係数 (MPa)</th> <th rowspan="2">開口幅 (mm)</th> <th rowspan="2">開口幅 (mm)</th> </tr> <tr> <th>水平方向</th> <th>鉛直方向</th> <th>水平方向</th> <th>鉛直方向</th> <th>水平方向</th> <th>鉛直方向</th> <th>水平方向</th> <th>鉛直方向</th> </tr> </thead> <tbody> <tr> <td></td> <td></td> <td>EL</td> <td></td> <td></td> <td></td> <td></td> <td>C₁</td> <td>C₁</td> <td>C₁</td> <td>C₁</td> <td></td> <td></td> <td></td> </tr> </tbody> </table> <p>1.2 機器項目</p> <table border="1" data-bbox="2018 756 2092 1407"> <thead> <tr> <th>m₀ (kg)</th> <th>D₁ (mm)</th> <th>t₁ (mm)</th> <th>D₂ (mm)</th> <th>t₂ (mm)</th> <th>E₁ (MPa)</th> <th>E₂ (MPa)</th> <th>G₁ (MPa)</th> <th>G₂ (MPa)</th> </tr> </thead> <tbody> <tr> <td></td> <td></td> <td></td> <td></td> <td></td> <td></td> <td></td> <td></td> <td></td> </tr> </tbody> </table> <table border="1" data-bbox="2092 819 2166 1407"> <thead> <tr> <th>f₁ (mm)</th> <th>D₁ (mm)</th> <th>D₂ (mm)</th> <th>φ</th> <th>n</th> <th>D₁ (mm)</th> <th>D₂ (mm)</th> </tr> </thead> <tbody> <tr> <td></td> <td></td> <td></td> <td></td> <td></td> <td></td> <td></td> </tr> </tbody> </table> <table border="1" data-bbox="2166 882 2270 1407"> <thead> <tr> <th>D₁ (mm)</th> <th>Y (mm)</th> <th>弾性設計用地震動 S_e 又は静的地震動 S_s (N-mm)</th> <th>基準地 震動 S_g (N-mm)</th> </tr> </thead> <tbody> <tr> <td></td> <td></td> <td></td> <td></td> </tr> </tbody> </table> <table border="1" data-bbox="2270 798 2344 1407"> <thead> <tr> <th>S₁ (鋼板) (MPa)</th> <th>S₂ (鋼板) (MPa)</th> <th>S₃ (スカート) (MPa)</th> <th>S₄ (スカート) (MPa)</th> <th>F (スカート) (MPa)</th> <th>F (スカート) (MPa)</th> </tr> </thead> <tbody> <tr> <td></td> <td></td> <td></td> <td></td> <td></td> <td></td> </tr> </tbody> </table> <table border="1" data-bbox="2344 1050 2433 1407"> <thead> <tr> <th>S₁ (鋼板ボルト) (MPa)</th> <th>S₂ (鋼板ボルト) (MPa)</th> <th>F (鋼板ボルト) (MPa)</th> <th>F (鋼板ボルト) (MPa)</th> </tr> </thead> <tbody> <tr> <td></td> <td></td> <td></td> <td></td> </tr> </tbody> </table> <p>注記 * : 基準係レベルを示す。</p>  <p>(耐震計算書のフォーマットについては、設備固有の内容となることから全ての内容に対する比較はせず、本ページ以外の発電炉側の記載を省略する。)</p>	機 器 名 称	耐震設計上の 標準系分類	耐震設計上の 標準系分類 (n)	開口幅及び床間高さ (m)		固有周期 (s)		弾性設計用地震動 S _e 又は静的地震動 S _s		基準地 震動 S _g		耐震係数 (MPa)	開口幅 (mm)	開口幅 (mm)	水平方向	鉛直方向	水平方向	鉛直方向	水平方向	鉛直方向	水平方向	鉛直方向			EL					C ₁	C ₁	C ₁	C ₁				m ₀ (kg)	D ₁ (mm)	t ₁ (mm)	D ₂ (mm)	t ₂ (mm)	E ₁ (MPa)	E ₂ (MPa)	G ₁ (MPa)	G ₂ (MPa)										f ₁ (mm)	D ₁ (mm)	D ₂ (mm)	φ	n	D ₁ (mm)	D ₂ (mm)								D ₁ (mm)	Y (mm)	弾性設計用地震動 S _e 又は静的地震動 S _s (N-mm)	基準地 震動 S _g (N-mm)					S ₁ (鋼板) (MPa)	S ₂ (鋼板) (MPa)	S ₃ (スカート) (MPa)	S ₄ (スカート) (MPa)	F (スカート) (MPa)	F (スカート) (MPa)							S ₁ (鋼板ボルト) (MPa)	S ₂ (鋼板ボルト) (MPa)	F (鋼板ボルト) (MPa)	F (鋼板ボルト) (MPa)					<p>• 設備の違いによる記載の差異はあるが、記載項目は合致しており、新たな論点が生じるものではない。</p>
機 器 名 称	耐震設計上の 標準系分類	耐震設計上の 標準系分類 (n)				開口幅及び床間高さ (m)		固有周期 (s)		弾性設計用地震動 S _e 又は静的地震動 S _s		基準地 震動 S _g					耐震係数 (MPa)	開口幅 (mm)	開口幅 (mm)																																																																																
			水平方向	鉛直方向	水平方向	鉛直方向	水平方向	鉛直方向	水平方向	鉛直方向																																																																																									
		EL					C ₁	C ₁	C ₁	C ₁																																																																																									
m ₀ (kg)	D ₁ (mm)	t ₁ (mm)	D ₂ (mm)	t ₂ (mm)	E ₁ (MPa)	E ₂ (MPa)	G ₁ (MPa)	G ₂ (MPa)																																																																																											
f ₁ (mm)	D ₁ (mm)	D ₂ (mm)	φ	n	D ₁ (mm)	D ₂ (mm)																																																																																													
D ₁ (mm)	Y (mm)	弾性設計用地震動 S _e 又は静的地震動 S _s (N-mm)	基準地 震動 S _g (N-mm)																																																																																																
S ₁ (鋼板) (MPa)	S ₂ (鋼板) (MPa)	S ₃ (スカート) (MPa)	S ₄ (スカート) (MPa)	F (スカート) (MPa)	F (スカート) (MPa)																																																																																														
S ₁ (鋼板ボルト) (MPa)	S ₂ (鋼板ボルト) (MPa)	F (鋼板ボルト) (MPa)	F (鋼板ボルト) (MPa)																																																																																																

	再処理施設	発電炉	備考
添付書類IV-1-1	添付書類IV-1-2-1	添付書類V-2-1-13-1	
	<p><u>4. 動的機能維持評価</u></p> <p><u>4.1 構造の説明</u> 冷却塔のファン駆動部は、ファンとこれを駆動する原動機及び減速機により構成している。原動機は誘導電動機であり、形式は横形ころがり軸受機に分類される。原動機及び減速機は、軸継手により連結されている。 冷却塔の耐震評価は、ファン及び原動機に対して実施する。</p> <p><u>4.2 評価方針</u> 冷却塔の機能維持評価は、本項に示す荷重及び荷重の組合せ並びに許容応力に基づき、「4.1 構造の説明」にて設定する評価部位において、解析モデルを用いて算出した固有周期に基づく設計用地震力による応力又は応答加速度が許容値内に収まることを確認する。 なお、評価部位のうちファンについては、「IV-1-1-8 機能維持の基本方針」第4.1-1表に示す加速度の適用範囲から外れるため、詳細検討としてファン軸応力、軸受荷重及びチップクリアランス(ファンとファンリングとの隙間)の評価を行う。</p> <p><u>4.2.1 計算条件</u> 計算条件は、「IV-1-1-8 機能維持の基本方針」にて設定した耐震設計上の重要度分類に応じた入力地震動に対し、「IV-1-1-6 設計用床応答曲線の作成方針」に基づき算定した設備据付位置の設計用地震力を用いる。 また、減衰定数については、「IV-1-1-5 地震応答解析の基本方針」に基づき、設備の種類、構造等に応じて適用する。</p> <p><u>4.2.2 解析モデルの設定方法</u> 冷却塔のファン軸は解析による評価を行うため、はり要素を用いて有限要素モデル化する。 ファン軸は軸受を介して減速機に連結し、水平2方向の軸受けばね要素及び減衰要素により減速機へ結合する。</p> <p><u>4.2.3 荷重の組合せ及び許容値</u> 機能維持評価は、ファン運転状態の評価を行うものとし、地震力に併せてファン回転によるねじりモーメント及びスラスト荷重を考慮する。評価に用いる荷重は、下記の荷重がファン軸に作用するものとする。</p> <ul style="list-style-type: none"> ・ファン及びファン軸の自重 ・ファンの回転による荷重(ねじりモーメント及びスラスト荷重) ・水平方向及び鉛直方向地震荷重 機能維持評価において各部位の評価に用いる許容値を以下に示す。 <p><u>(1) ファン軸応力</u> 許容応力は、「IV-1-1-8 機能維持の基本方針(e. 支持構造物)」に基づく。</p> <p><u>(2) 軸受</u> 軸受の基本静定格荷重を許容荷重とする。</p> <p><u>(3) チップクリアランスの評価</u> 据付(通常)時のチップクリアランスを許容値とする。</p>		<ul style="list-style-type: none"> ・設備の違いによる記載の差異はあるが、記載項目は合致しており、新たな論点が生じるものではない。 ・本設備の機能維持評価の妥当性については、補足説明資料「【耐震機電14】動的機能維持評価手法の適用について」に示す。

再処理施設	発電炉	備考																																																						
添付書類IV-1-1	添付書類IV-1-2-1	添付書類V-2-1-13-1																																																						
	<p>(4) 原動機 <u>「IV-1-1-8 機能維持の基本方針」第4.1-1表に示す動的機能確認済加速度を許容値とする。</u></p> <p>4.2.4 計算方法 <u>耐震計算は、本項に示す方法に基づく。</u></p> <p>4.2.4.1 記号の説明</p> <table border="1" data-bbox="905 525 1765 1291"> <thead> <tr> <th>記号</th> <th>表 示 内 容</th> <th>単 位</th> </tr> </thead> <tbody> <tr> <td>d</td> <td>ファン軸径</td> <td>mm</td> </tr> <tr> <td>F_{Ba}</td> <td>軸方向の最大荷重</td> <td>N</td> </tr> <tr> <td>F_{Br}</td> <td>軸受部ラジアル方向の最大荷重</td> <td>N</td> </tr> <tr> <td>f_{si}</td> <td>荷重係数(衝撃荷重として1.5とする)</td> <td>—</td> </tr> <tr> <td>M_{bf}</td> <td>地震力によりファン軸に作用する曲げモーメント</td> <td>N・mm</td> </tr> <tr> <td>M_{tf}</td> <td>ファン回転によるねじりモーメント</td> <td>N・mm</td> </tr> <tr> <td>P_o</td> <td>軸受の静等価荷重</td> <td>N</td> </tr> <tr> <td>P₁</td> <td>ファン及びカップリング等の自重</td> <td>N</td> </tr> <tr> <td>P₂</td> <td>ファン軸の鉛直地震力により作用する軸力</td> <td>N</td> </tr> <tr> <td>P₃</td> <td>ファン回転によるスラスト荷重</td> <td>N</td> </tr> <tr> <td>Q_t</td> <td>地震力によるファン軸に作用するせん断力</td> <td>N</td> </tr> <tr> <td>Y_o</td> <td>静スラスト係数</td> <td>—</td> </tr> <tr> <td>σ_{bf}</td> <td>地震力によるファン軸外縁の曲げ応力</td> <td>MPa</td> </tr> <tr> <td>σ_{mf}</td> <td>軸力による圧縮応力</td> <td>MPa</td> </tr> <tr> <td>τ_{st}</td> <td>地震力によるファン軸のせん断応力</td> <td>MPa</td> </tr> <tr> <td>τ_{tf}</td> <td>ファン軸の回転による軸外縁のせん断応力</td> <td>MPa</td> </tr> <tr> <td>τ_{max}</td> <td>ファン軸の組合せ応力</td> <td>MPa</td> </tr> </tbody> </table>	記号	表 示 内 容	単 位	d	ファン軸径	mm	F _{Ba}	軸方向の最大荷重	N	F _{Br}	軸受部ラジアル方向の最大荷重	N	f _{si}	荷重係数(衝撃荷重として1.5とする)	—	M _{bf}	地震力によりファン軸に作用する曲げモーメント	N・mm	M _{tf}	ファン回転によるねじりモーメント	N・mm	P _o	軸受の静等価荷重	N	P ₁	ファン及びカップリング等の自重	N	P ₂	ファン軸の鉛直地震力により作用する軸力	N	P ₃	ファン回転によるスラスト荷重	N	Q _t	地震力によるファン軸に作用するせん断力	N	Y _o	静スラスト係数	—	σ _{bf}	地震力によるファン軸外縁の曲げ応力	MPa	σ _{mf}	軸力による圧縮応力	MPa	τ _{st}	地震力によるファン軸のせん断応力	MPa	τ _{tf}	ファン軸の回転による軸外縁のせん断応力	MPa	τ _{max}	ファン軸の組合せ応力	MPa	<p>・設備の違いによる記載の差異はあるが、記載項目は合致しており、新たな論点が生じるものではない。</p>
記号	表 示 内 容	単 位																																																						
d	ファン軸径	mm																																																						
F _{Ba}	軸方向の最大荷重	N																																																						
F _{Br}	軸受部ラジアル方向の最大荷重	N																																																						
f _{si}	荷重係数(衝撃荷重として1.5とする)	—																																																						
M _{bf}	地震力によりファン軸に作用する曲げモーメント	N・mm																																																						
M _{tf}	ファン回転によるねじりモーメント	N・mm																																																						
P _o	軸受の静等価荷重	N																																																						
P ₁	ファン及びカップリング等の自重	N																																																						
P ₂	ファン軸の鉛直地震力により作用する軸力	N																																																						
P ₃	ファン回転によるスラスト荷重	N																																																						
Q _t	地震力によるファン軸に作用するせん断力	N																																																						
Y _o	静スラスト係数	—																																																						
σ _{bf}	地震力によるファン軸外縁の曲げ応力	MPa																																																						
σ _{mf}	軸力による圧縮応力	MPa																																																						
τ _{st}	地震力によるファン軸のせん断応力	MPa																																																						
τ _{tf}	ファン軸の回転による軸外縁のせん断応力	MPa																																																						
τ _{max}	ファン軸の組合せ応力	MPa																																																						

再処理施設	発電炉	備考
添付書類IV-1-1	添付書類IV-1-2-1	添付書類V-2-1-13-1
	<p>4.2.4.2 <u>ファン軸応力の計算方法</u> <u>軸受部に作用する反力及び軸に作用する最大曲げモーメントより生じる応力は、次式により算出する。</u></p> <p>(1) <u>地震力による軸外縁曲げ応力</u> <u>軸外縁曲げ応力は、次式で表される。</u> $\sigma_{bf} = \frac{32M_{bf}}{\pi d^3} \dots\dots\dots (4.2.4.2-1)$</p> <p>(2) <u>軸力による圧縮応力</u> <u>圧縮応力は、次式で表される。</u> $\sigma_{mf} = \frac{4(P_1+P_2+P_3)}{\pi d^2} \dots\dots\dots (4.2.4.2-2)$</p> <p>(3) <u>ファン軸の回転による軸外縁のせん断応力</u> <u>軸外縁のせん断応力は、次式で表される。</u> $\tau_{tf} = \frac{16M_{bf}}{\pi d^3} \dots\dots\dots (4.2.4.2-3)$</p> <p>(4) <u>地震力によるせん断応力</u> <u>せん断応力は、次式で表される。</u> $\tau_{st} = \frac{4Q_t}{\pi d^2} \dots\dots\dots (4.2.4.2-4)$</p> <p>(5) <u>組合せ応力</u> <u>組合せ応力は、次式で表される。</u> $\tau_{max} = \frac{1}{2} \sqrt{(\sigma_{bf} + \sigma_{mf})^2 + 4(\tau_{tf} + \tau_{st})^2} \dots\dots\dots (4.2.4.2-5)$</p> <p>4.2.4.3 <u>軸受荷重の計算方法</u> <u>ファン軸の地震応力解析によって得られる軸受部の各種荷重から静等価荷重を次式により算出する。</u> <u>なお、静等価荷重は下記に示す2式のいずれか大きい値を用いる。</u> $P_o = f_{si} (0.5F_{Br} + Y_o F_{Ba}) \dots\dots\dots (4.2.4.3-1)$ $P_o = f_{si} F_{Br} \dots\dots\dots (4.2.4.3-2)$</p> <p>4.2.4.4 <u>地震時チップクリアランスの計算方法</u> <u>地震時におけるファンブレード先端とファンリングの接触の有無を確認するための両者間の相対変位は、各々の最大応答変位の絶対和として求める。ここで、ファンリングについては、十分に剛な構造であることより、その応答変位は0とする。</u></p> <p>4.2.4.5 <u>原動機の計算方法</u> <u>原動機の応答加速度が動的機能確認済加速度内に収まることを確認する。なお、動的機能確認済加速度を超える場合には、詳細検討により機能維持を満足することを確認する。</u></p> <p>4.3 <u>評価</u> <u>4.2.4項で算出した値が4.2.3項に示す許容値以下であること。</u></p>	<p>・設備の違いによる記載の差異はあるが、記載項目は合致しており、新たな論点が生じるものではない。</p>

別紙 4 - 17

配管系の耐震性に関する計算書作成 の基本方針

※本資料は設備の申請に合わせて次回以降に追加する

【凡例】

下線：

- ・プラントの違いによらない記載内容の差異
- ・章立ての違いによる記載位置の違いによる差異

二重下線：

- ・プラント固有の事項による記載内容の差異
- ・後次回の申請範囲に伴う差異

別紙4-18

安全冷却水B冷却塔の 地震応答計算書

本添付書類は、別で定める方針に沿った評価・計算を示す書類であり、結果を示すものであることから、発電炉との比較は行わない。
また、図書番号や数値は最終精査中。

目 次

	ページ
1. 概要	1
2. 基本方針	2
2.1 位置	2
2.2 構造概要	3
2.3 解析方針	5
2.4 準拠規格・基準等	7
3. 解析方法	8
3.1 地震応答解析に用いる地震動	8
3.2 地震応答解析モデル	9
3.2.1 水平方向モデル	10
3.2.2 鉛直方向モデル	56
3.3 建物・構築物の入力地震動	64
3.3.1 水平方向	64
3.3.2 鉛直方向	80
3.4 解析方法	90
3.4.1 動的解析	90
3.5 解析条件	91
3.5.1 地盤のロッキングばねの復元力特性	91
3.6 材料物性のばらつき	92
4. 解析結果	96
4.1 動的解析	96
4.1.1 固有値解析結果	96
4.1.2 基本ケースの地震応答解析結果	96
4.1.3 材料物性のばらつきを考慮したケースの地震応答解析結果	157

1. 概要

本資料は、「IV-1-1 耐震設計の基本方針」, 「IV-1-1-2 地盤の支持性能に係る基本方針」及び「IV-1-1-5 地震応答解析の基本方針」に基づく安全冷却水B冷却塔基礎の地震応答解析について説明するものである。

地震応答解析により算出した各種応答値は、「IV-1-1-8 機能維持の基本方針」に示す建物・構築物及び機器・配管系の設計用地震力として用いる。

2. 基本方針

2.1 位置

安全冷却水B冷却塔基礎の設置位置を第2.1-1図に示す。

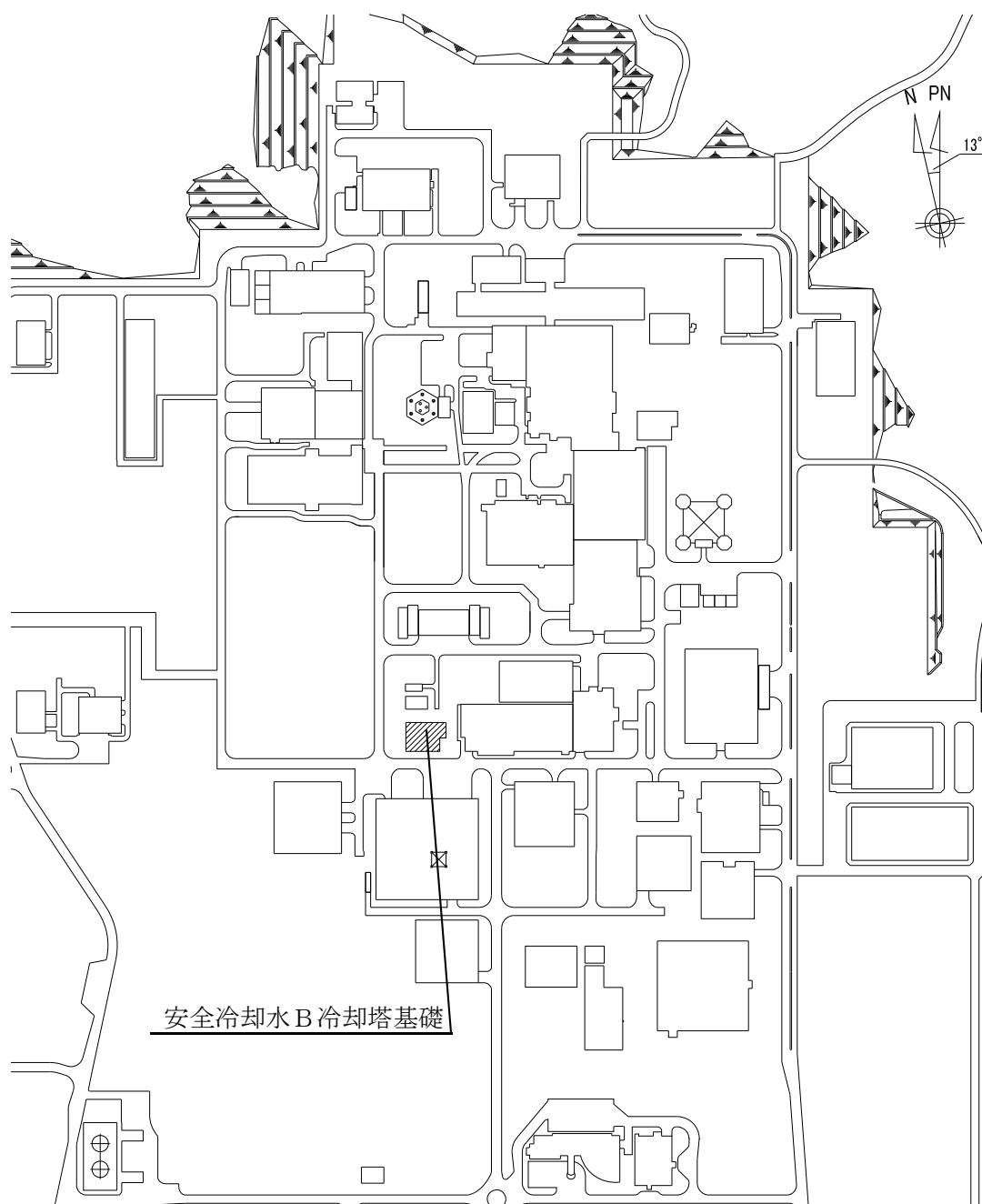

第2.1-1図 安全冷却水B冷却塔基礎の設置位置

2.2 構造概要

安全冷却水B冷却塔は、各施設の安全冷却水系の冷却水を除熱するため設けられる。安全冷却水B冷却塔基礎は、安全冷却水B冷却塔を支持するための基礎である。

安全冷却水B冷却塔基礎の主体構造は鉄筋コンクリート造である。平面規模は主要部分で [redacted] m(NS)×[redacted] m(EW)である。 [redacted] また、基礎スラブはマンメイドロック（以下、「MMR」という。）を介して岩盤に設置されている。

安全冷却水B冷却塔基礎の概略平面図を第2.2-1図に、概略断面図を第2.2-2図に示す。

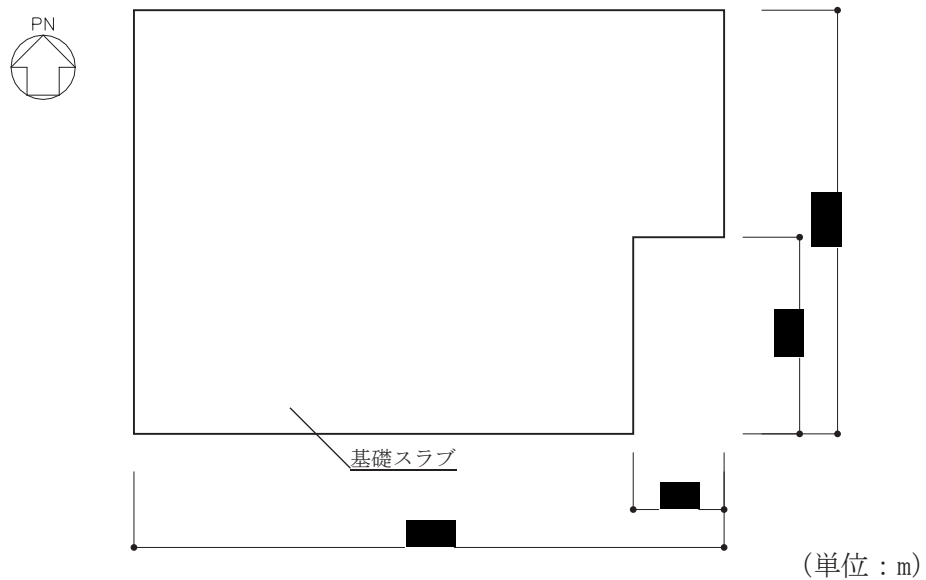

注記：構築物寸法は、基礎外面押えとする。

第2.2-1図 概略平面図 (T.M.S.L. [redacted] m)

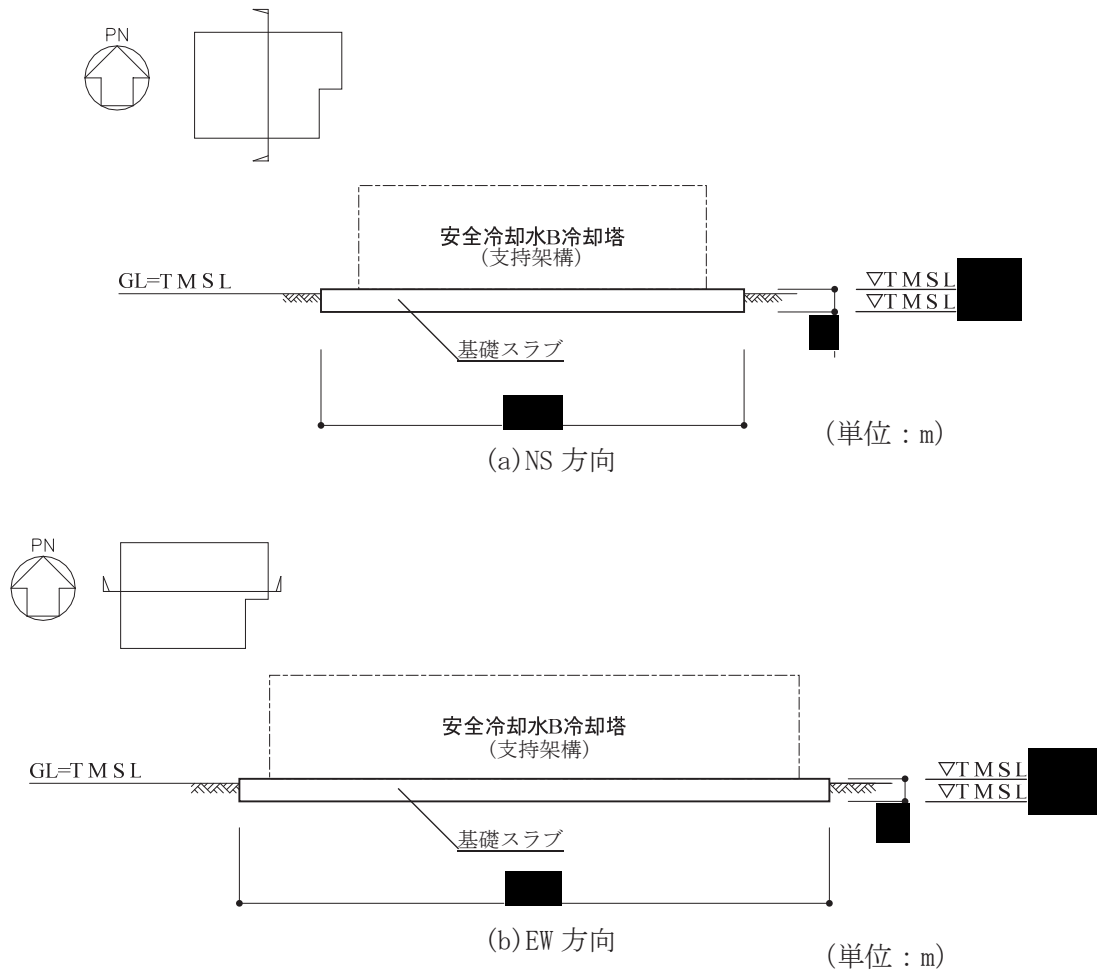

第 2.2-2 図 概略断面図

2.3 解析方針

「IV-1-1-8 機能維持の基本方針」に示す建物・構築物及び機器・配管系の設計用地震力を設定するにあたり、「IV-1-1 耐震設計の基本方針」に基づき、安全冷却水B冷却塔基礎における動的地震力を算定する。

動的地震力は地震応答解析により算定することとし、解析モデル、入力地震動及び解析方法については「IV-1-1-5 地震応答解析の基本方針」に基づき設定する。動的地震力算定のため実施する地震応答解析については、「3. 解析方法」に示す解析モデル、入力地震動及び解析方法により実施し、その結果を「4. 解析結果」に示す。

第2.3-1図に設計用地震力算定フローを示す。

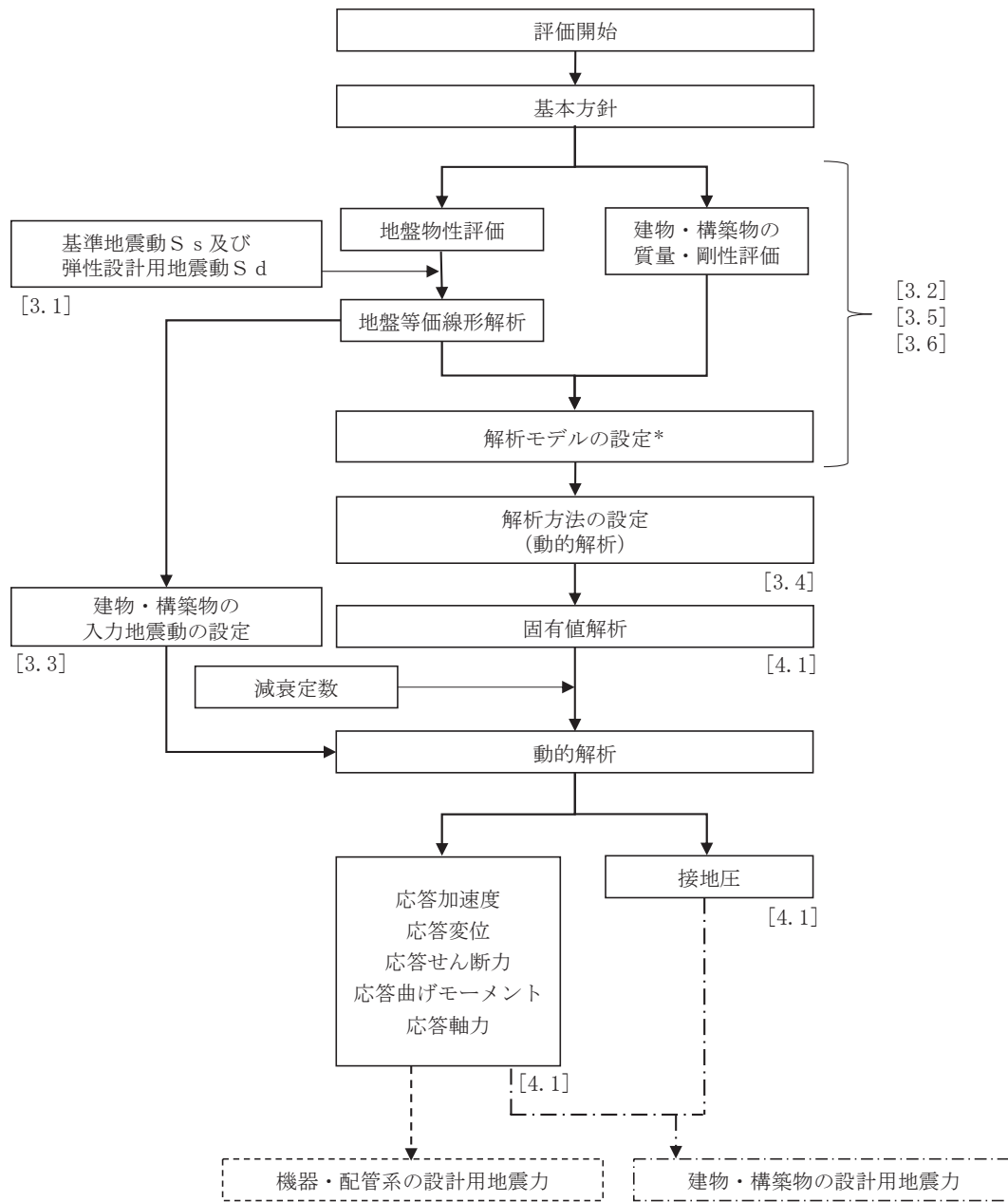

注記 * : 材料物性のばらつきを考慮する。

注記 : []内は本資料における章番号を示す。

第 2.3-1 図 設計用地震力算定フロー

2.4 準拠規格・基準等

地震応答解析において準拠する規格・基準等を以下に示す。

- ・ 建築基準法・同施行令
- ・ 鉄筋コンクリート構造計算規準・同解説—許容応力度設計法—
（(社)日本建築学会, 1999)
- ・ 原子力発電所耐震設計技術指針 JEAG 4601-1987 ((社)日本電気協会) (以下,
「JEAG 4601-1987」という。)
- ・ 原子力発電所耐震設計技術指針 重要度分類・許容応力編 JEAG 4601・補
-1984 ((社)日本電気協会)
- ・ 原子力発電所耐震設計技術指針 JEAG 4601-1991 追補版 ((社)日本電気協会)
(以下, 「JEAG 4601-1991 追補版」という。)

3. 解析方法

3.1 地震応答解析に用いる地震動

地震応答解析に用いる地震動は、「IV-1-1-1 基準地震動 S_s 及び弾性設計用地震動 S_d の概要」に基づく解放基盤表面レベルで定義された基準地震動 S_s 及び弾性設計用地震動 S_d とする。

なお、基準地震動 $S_s-B1\sim B5$ 及び弾性設計用地震動 $S_d-B1\sim B5$ については、建物・構築物への入力地震動を評価する際に、プラントノース(真北に対し、時計回りに 13° の方向)に変換を行う。

3.2 地震応答解析モデル

地震応答解析モデルは、「IV-1-1-5 地震応答解析の基本方針」に基づき、水平方向及び鉛直方向それぞれについて設定する。地震応答解析モデルの設定に用いた使用材料の物性値を第3.2-1表に示す。

第3.2-1表 使用材料の物性値

使用材料	ヤング係数 E (N/mm ²)	せん断 弾性係数 G (N/mm ²)	減衰定数 h (%)	備考
鉄筋コンクリート コンクリート： Fc=23.5(N/mm ²) (Fc=240(kgf/cm ²)) 鉄筋：SD345	2.25×10 ⁴	9.38×10 ³	5	基礎
支持架構 鉄骨架構：■■■■ ■■■■ ■■■■ 基礎ボルト：■■■■				冷却塔 (支持架構)

3.2.1 水平方向モデル

水平方向の地震応答解析モデルは、構築物と地盤の相互作用を考慮した構築物—地盤連成モデルとし、基礎の曲げ、せん断剛性及び鉄骨造の支持架構の等価せん断剛性を考慮した質点系モデルを用いる。地震応答解析は弾性時刻歴応答解析により行う。また、第3.2.1-1図に示すとおり、「原子力発電所耐震設計技術規程 JEAC4601-2008((社)日本電気協会)」の基礎浮上りの評価法を参考に、応答のレベルに応じて異なる地震応答解析モデルを用いる。水平方向の地震応答解析モデルを第3.2.1-2図、解析モデルの諸元を第3.2.1-1表及び第3.2.1-2表に示す。

鉄筋コンクリート造の基礎については、基礎躯体の地震方向のせん断剛性及び曲げ剛性を考慮する。鉄骨造の支持架構については、柱、梁及びブレースの各部材の剛性並びに質量を考慮した3次元フレームモデルの固有値解析結果から求めた等価せん断剛性を考慮する。

地盤は、地盤調査に基づき水平成層地盤とし、第3.2.1-2図に示すモデルに用いる基礎底面地盤ばねについては、「JEG 4601-1991 追補版」により、成層補正を行ったのち、振動アドミタンス理論に基づき求めたスウェイ及びロッキングの地盤ばねを、近似法により定数化して用いる。このうち、基礎底面のロッキング地盤ばねには、基礎浮上りによる幾何学的非線形性を考慮する。基礎底面地盤ばねの評価には解析コード「VA Ver. 2.0」を用いる。なお、地盤定数については、ひずみ依存特性を考慮して求めた等価物性値を用いる。

安全冷却水B冷却塔基礎の地盤条件の設定にあたっては、敷地全体の地下構造との関係や構築物近傍位置での地質・速度構造を踏まえ、構築物近傍の地盤調査結果を重視して安全冷却水B冷却塔基礎の直下又は近傍のボーリング調査結果に基づき設定した地盤の物性値を用いる。「IV-1-1-2 地盤の支持性能に係る基本方針」に基づく地盤の初期物性値を第3.2.1-3表に、ひずみ依存特性を第3.2.1-3図～第3.2.1-5図に示す。基準地震動 S_s 及び弾性設計用地震動 S_d に対して、ひずみ依存特性を考慮した地盤の等価線形解析による有効せん断ひずみ分布を第3.2.1-6図及び第3.2.1-7図に、地盤の等価線形解析で得られる等価物性値に基づき設定した地盤定数を第3.2.1-4表～第3.2.1-23表に示す。また、地盤ばねの定数化の概要を第3.2.1-8図に、地盤ばね定数及び減衰係数を第3.2.1-24表～第3.2.1-43表に示す。なお、安全冷却水B冷却塔基礎の直下にあるMMRについては、支持地盤相当の岩盤に支持されているとみなし、MMR直下の支持地盤の物性値を設定する。

解析コードの検証及び妥当性確認等の概要については、「IV-3 計算機プログラム(解析コード)の概要」に示す。

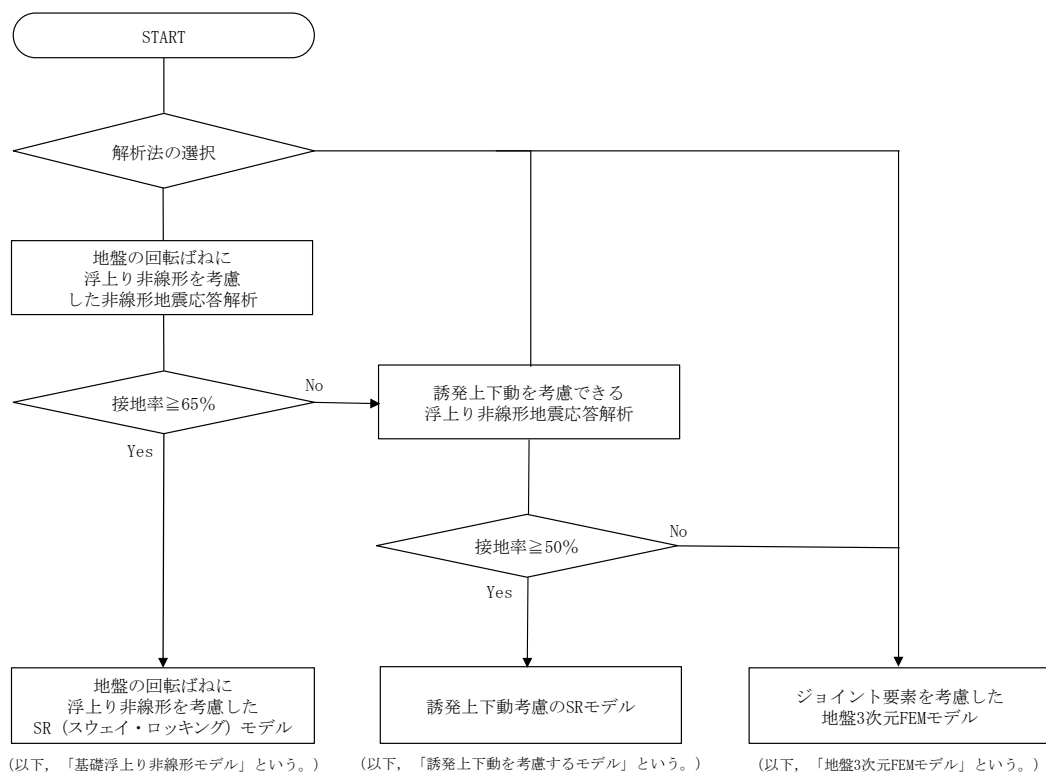

第 3.2.1-1 図 解析モデル選定フロー

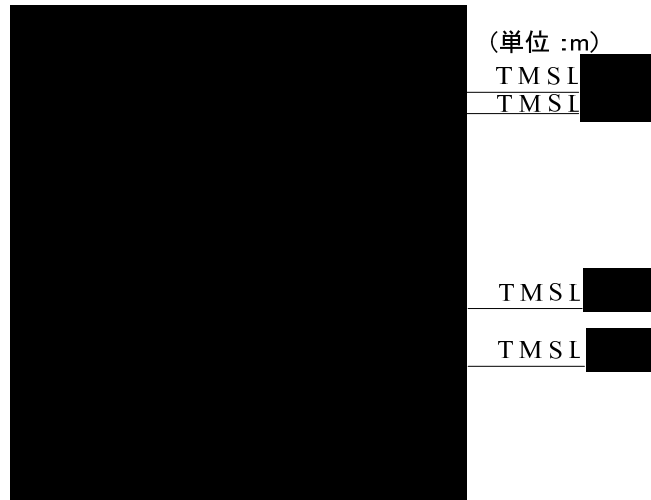

- 注記 1 : ○数字は質点番号を示す。
 2 : □数字は要素番号を示す。
 3 : K_S は底面スウェイばねを示す。
 4 : K_R は底面ロッキングばねを示す。

第 3.2.1-2 図 地震応答解析モデル (水平方向)

第 3. 2. 1-1 表 地震応答解析モデル諸元 (NS 方向)

質点番号	質点位置 T. M. S. L. (m)	重量 W (kN)	回転慣性 重量 I_g ($\times 10^6 \text{kN} \cdot \text{m}^2$)	要素 番号	要素位置 T. M. S. L. (m)	断面二次 モーメント I ($\times 10^4 \text{m}^4$)	せん断 断面積 A_s (m^2)
				—	—	—	—
	構築物総重量		—	—	—	—	—

第 3. 2. 1-2 表 地震応答解析モデル諸元 (EW 方向)

質点番号	質点位置 T. M. S. L. (m)	重量 W (kN)	回転慣性 重量 I_g ($\times 10^6 \text{kN} \cdot \text{m}^2$)	要素 番号	要素位置 T. M. S. L. (m)	断面二次 モーメント I ($\times 10^4 \text{m}^4$)	せん断 断面積 A_s (m^2)
				—	—	—	—
	構築物総重量		—	—	—	—	—

第 3. 2. 1-3 表 地盤の初期物性値

標高 T. M. S. L. (m)	岩種	単位体積重量 γ_t (kN/m ³)	S波速度 V_s (m/s)	P波速度 V_p (m/s)	剛性低下率 $G/G_0-\gamma$	減衰定数 $h-\gamma$
▽基礎スラブ底面						
53.80						
▽MMR下端レベル	MMR	*1	*1	*1	*1	
39.00						
37.08	細粒砂岩	18.3	680	1910		*2
36.63	粗粒砂岩					*3
9.02	細粒砂岩					*2
-25.57		18.1	940	2040		
▽解放基盤表面	泥岩 (下部層)	16.9	790	1880		*4
-70.00	泥岩 (下部層)	16.9	790	1880		—

注記 *1: 支持地盤相当の岩盤に支持されているとみなし, MMR 直下の支持地盤の物性値を設定する。

*2: 第 3. 2. 1-3 図示す細粒砂岩のひずみ依存特性を設定する。

*3: 第 3. 2. 1-4 図に示す粗粒砂岩のひずみ依存特性を設定する。

*4: 第 3. 2. 1-5 図に示す泥岩 (下部層) のひずみ依存特性を設定する。

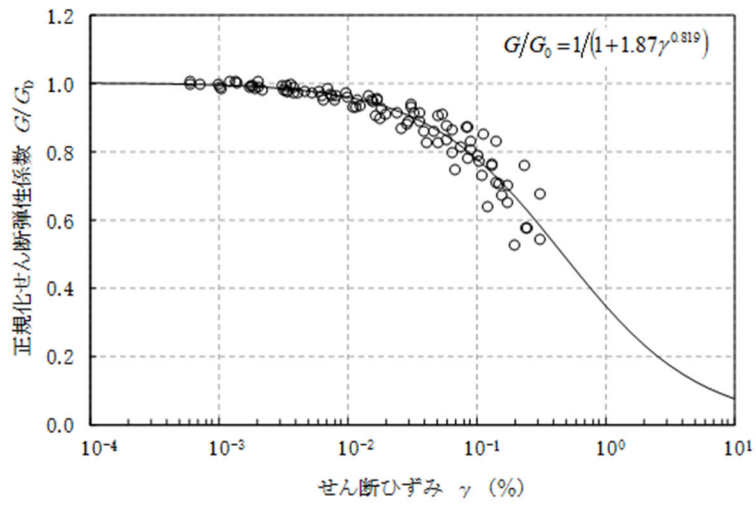

(a) 剛性低下率

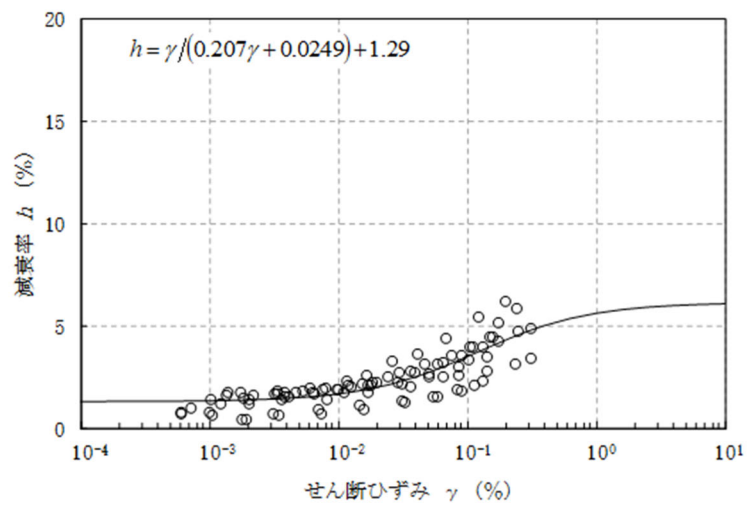

(b) 減衰定数

第 3.2.1-3 図 ひずみ依存特性 (細粒砂岩)

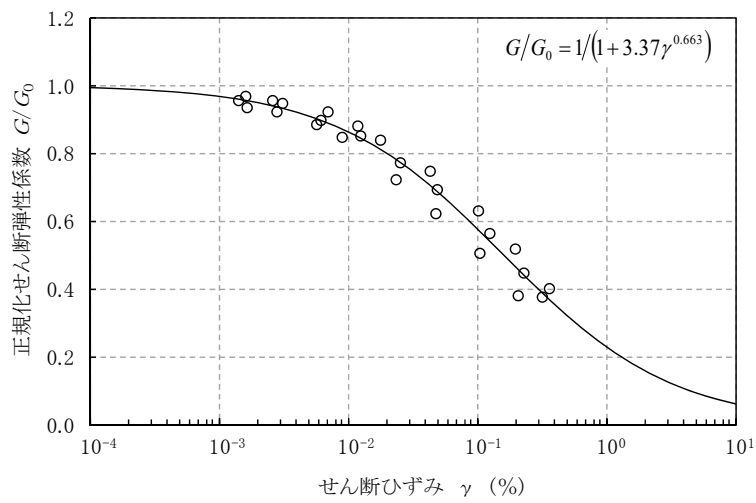

(a) 剛性低下率

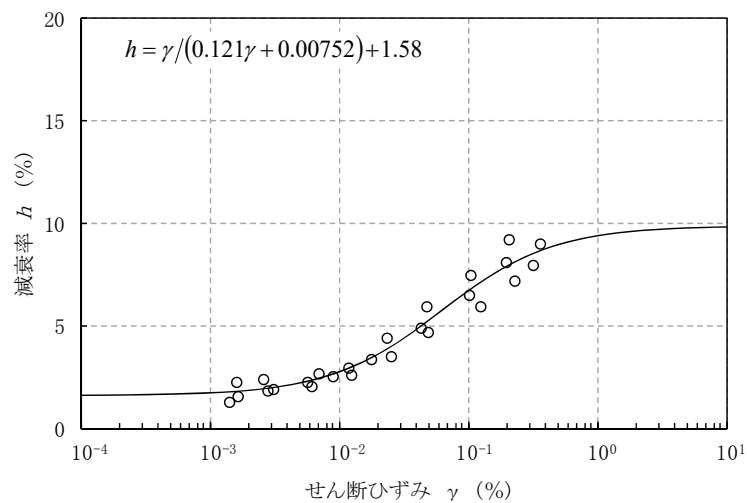

(b) 減衰定数

第 3.2.1-4 図 ひずみ依存特性 (粗粒砂岩)

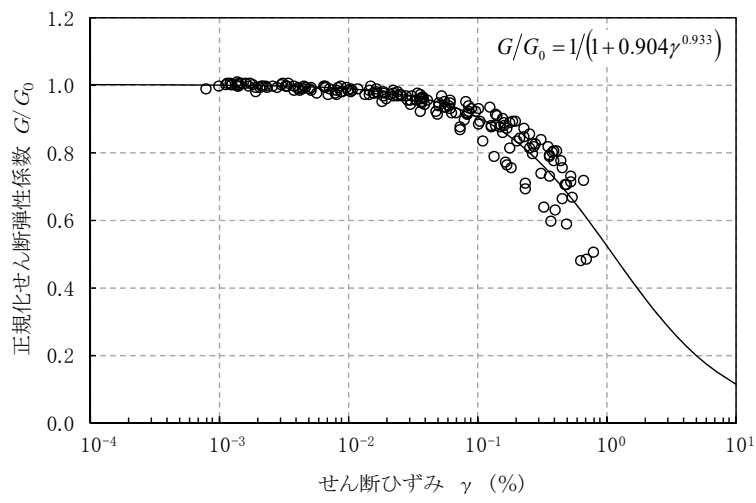

(a) 剛性低下率

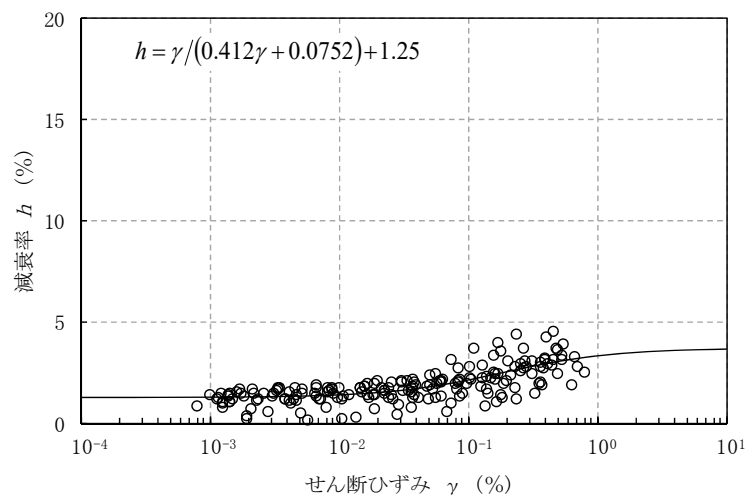

(b) 減衰定数

第 3.2.1-5 図 ひずみ依存特性 (泥岩 (下部層))

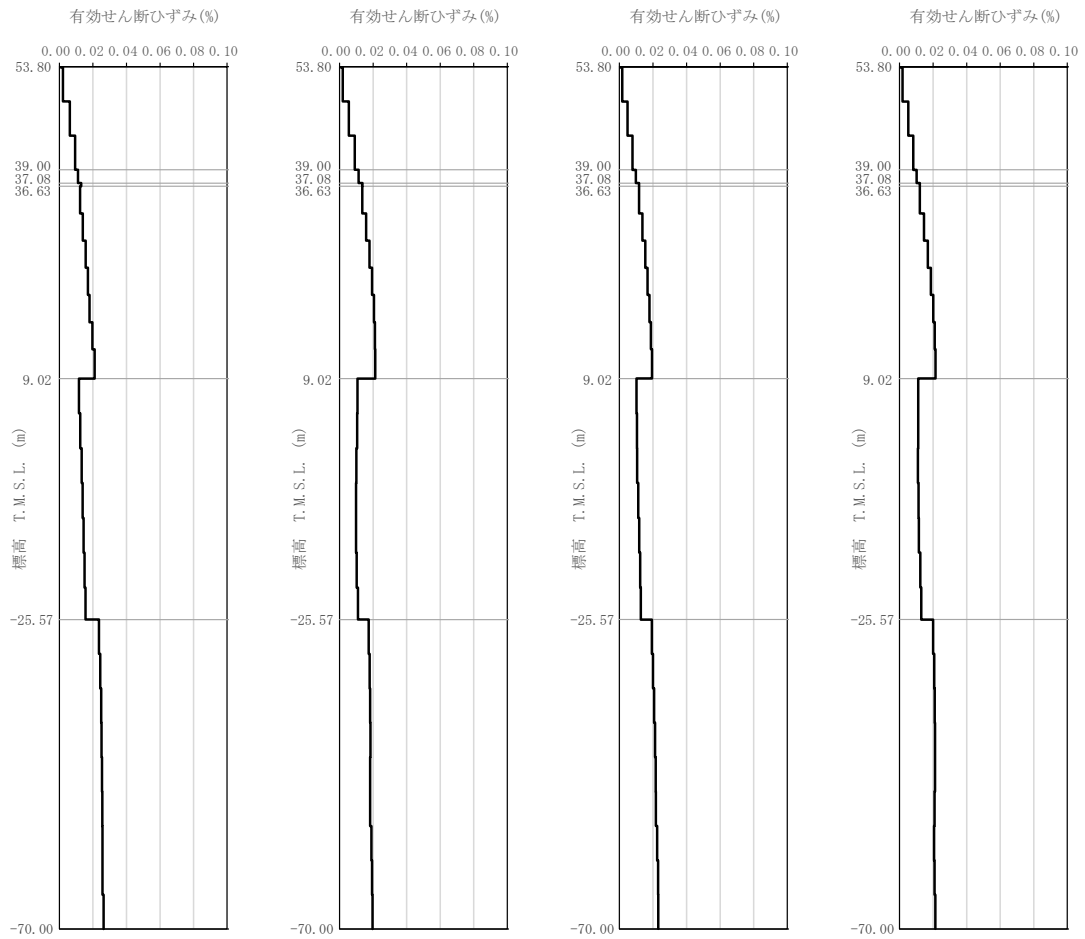

(a) S s - A

(b) S s - B 1

(c) S s - B 2

(d) S s - B 3

第 3.2.1-6 図 有効せん断ひずみ分布 (S s) (1/3)

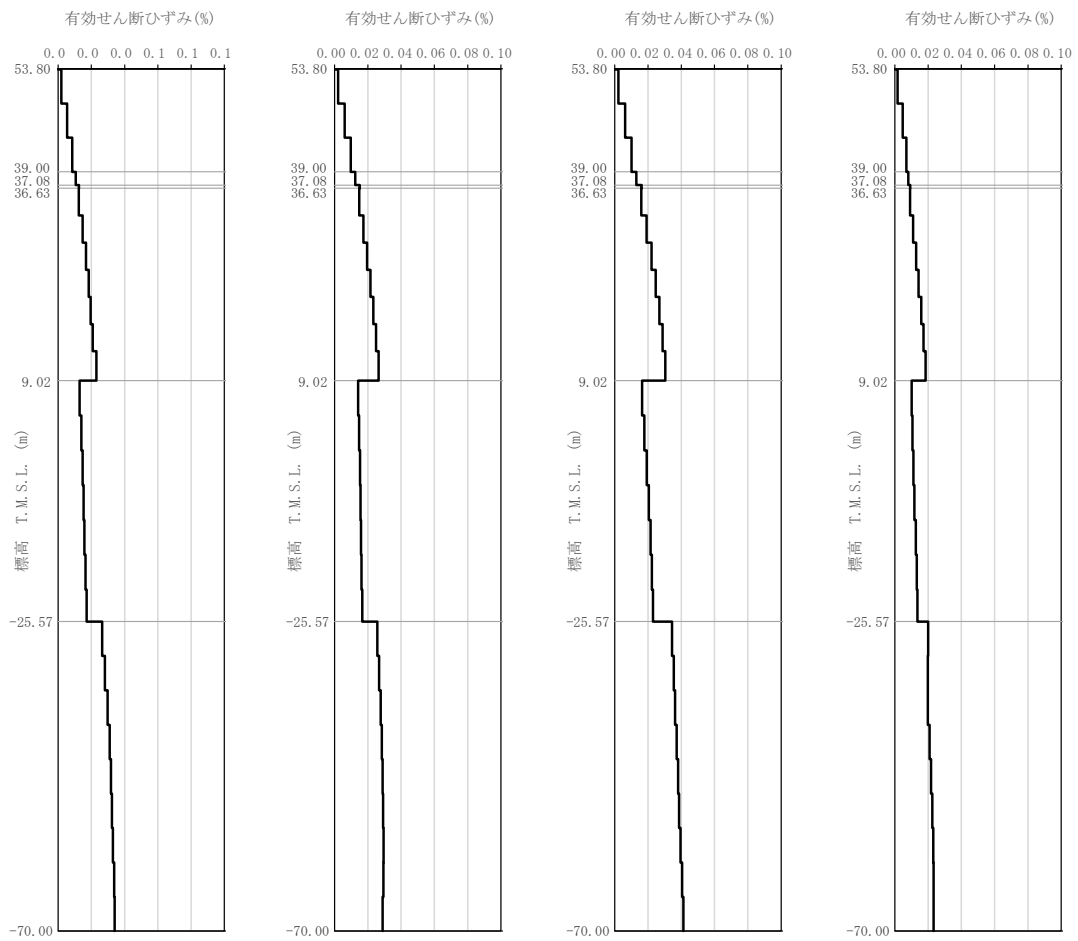

(e) S_s-B4

(f) S_s-B5

(g) S_s-C1

(h) S_s-C2

第 3.2.1-6 図 有効せん断ひずみ分布 (S_s) (2/3)

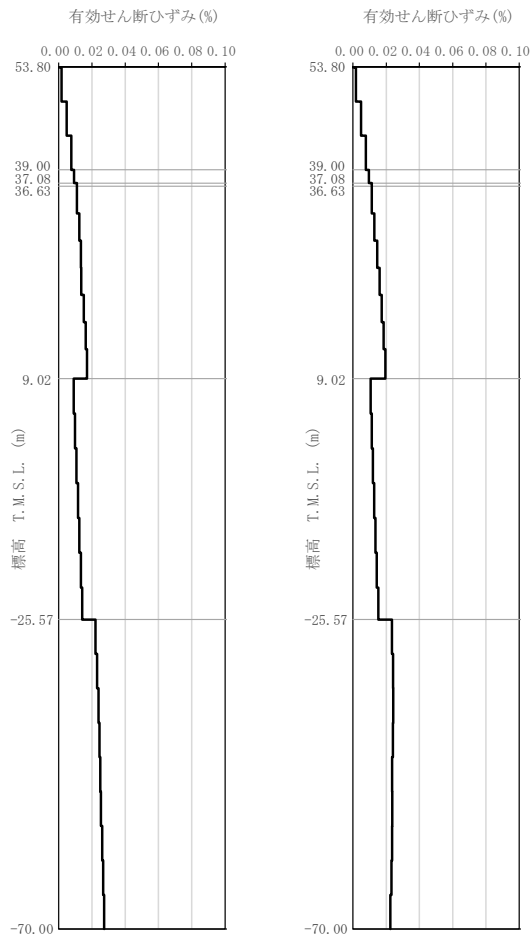

第 3.2.1-6 図 有効せん断ひずみ分布 (S_s) (3/3)

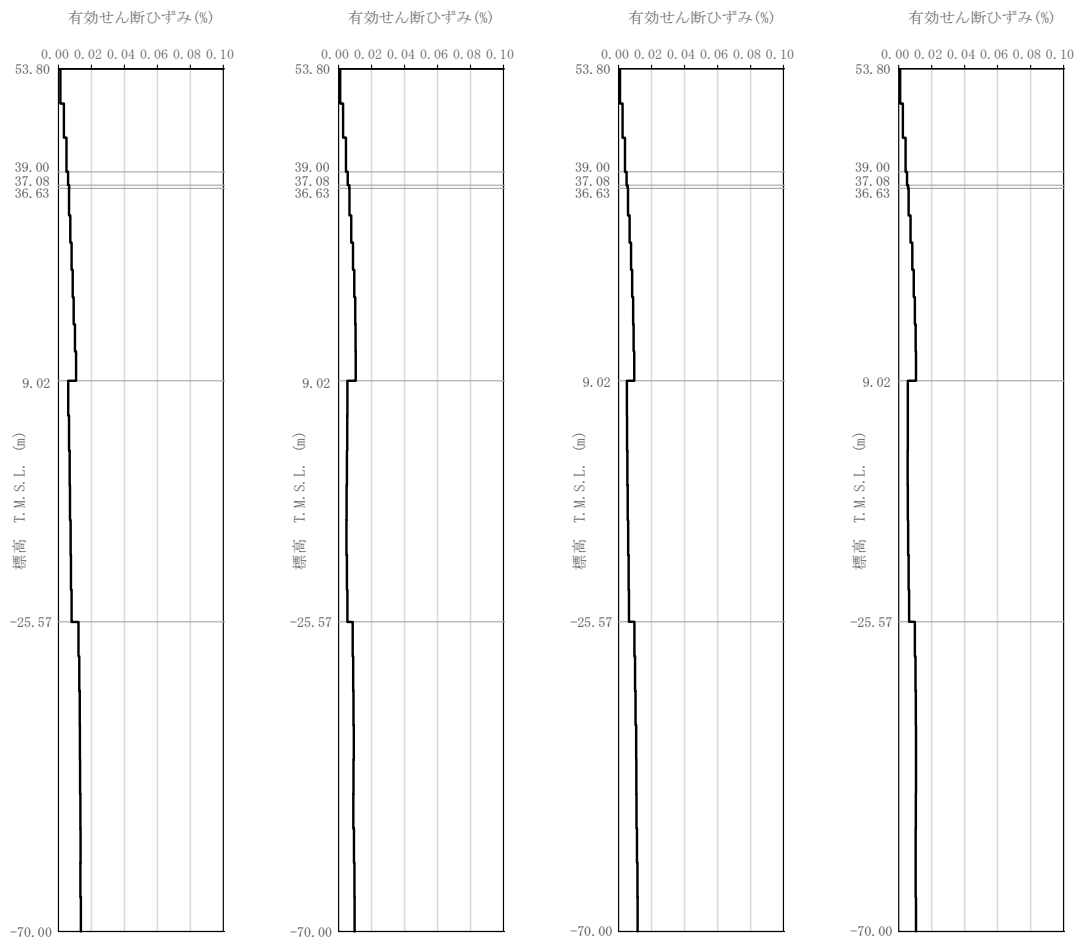

(a) S d - A

(b) S d - B 1

(c) S d - B 2

(d) S d - B 3

第 3.2.1-7 図 有効せん断ひずみ分布 (S d) (1/3)

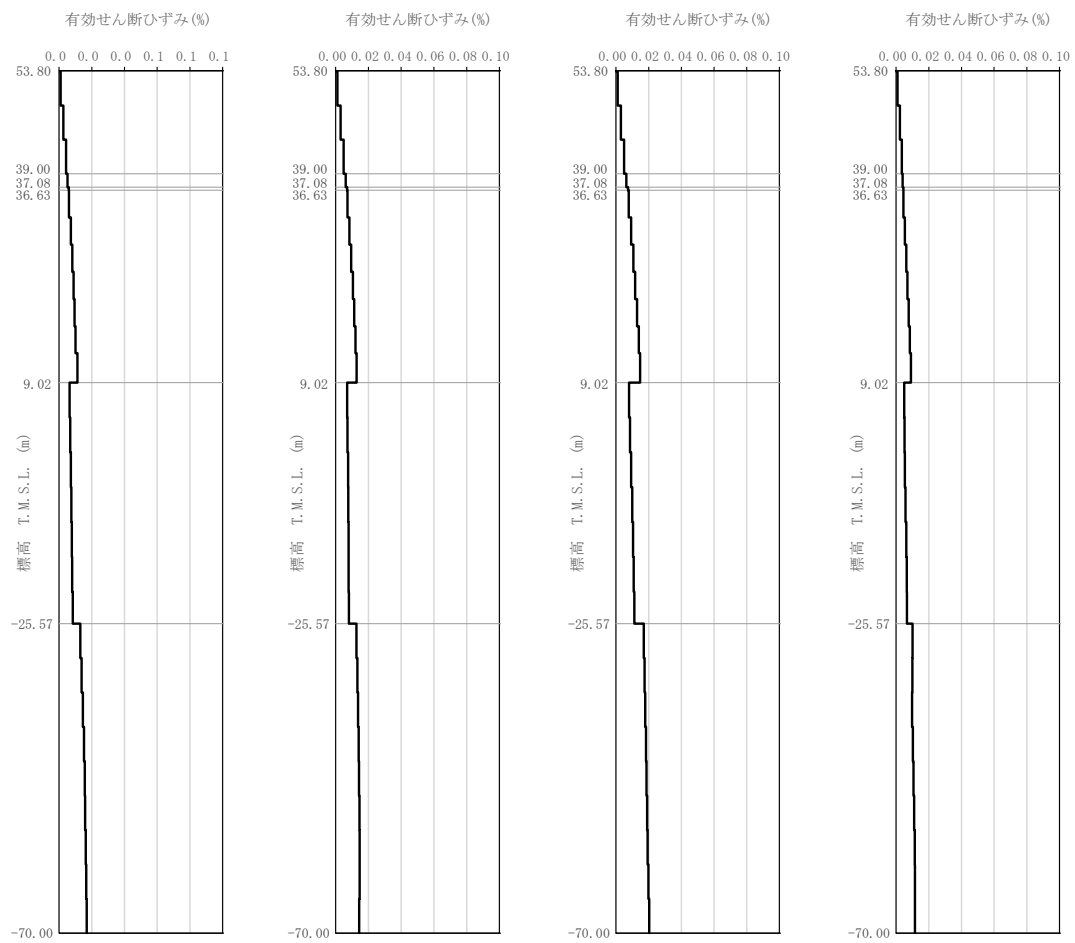

(e) S d - B 4

(f) S d - B 5

(g) S d - C 1

(h) S d - C 2

第 3.2.1-7 図 有効せん断ひずみ分布 (S d) (2/3)

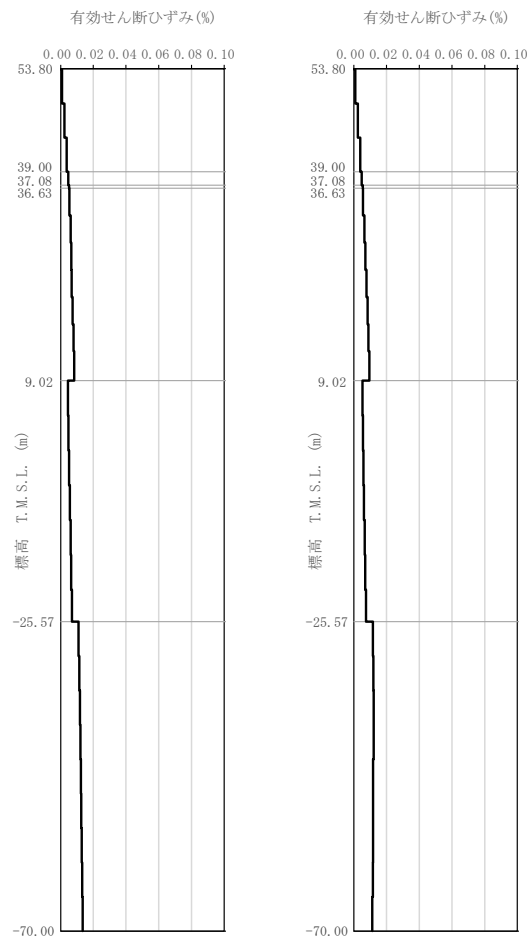

第 3.2.1-7 図 有効せん断ひずみ分布 (S d) (3/3)

第 3.2.1-4 表 地盤定数 (S s - A)

標高 T. M. S. L. (m)	地層区分	層厚 (m)	単位 体積重量 γ_t (kN/m^3)	せん断 弾性係数 G ($\times 10^5 \text{kN}/\text{m}^2$)	等価 S波速度 (m/s)	等価 P波速度 (m/s)	等価 減衰定数 h	ポアソン比
53.80	MMR	14.80	18.3	8.41	671	1880	0.02	0.43
39.00	細粒砂岩	1.92	18.3	8.24	664	1860	0.02	0.43
37.08	粗粒砂岩	0.45	18.3	7.32	626	1750	0.03	0.43
36.63	細粒砂岩	27.61	18.3	8.11	659	1850	0.02	0.43
9.02		34.59	18.1	15.5	915	1980	0.02	0.37
-25.57	泥岩 (下部層)	44.43	16.9	10.4	778	1850	0.02	0.39
-70.00	解放基盤表面	—	16.9	10.7	790	1880	0.01	0.39

第 3.2.1-5 表 地盤定数 (S s - B 1)

標高 T. M. S. L. (m)	地層区分	層厚 (m)	単位 体積重量 γ_t (kN/m^3)	せん断 弾性係数 G ($\times 10^5 \text{kN}/\text{m}^2$)	等価 S波速度 (m/s)	等価 P波速度 (m/s)	等価 減衰定数 h	ポアソン比
53.80	MMR	14.80	18.3	8.43	671	1880	0.02	0.43
39.00	細粒砂岩	1.92	18.3	8.25	664	1860	0.02	0.43
37.08	粗粒砂岩	0.45	18.3	7.31	625	1750	0.03	0.43
36.63	細粒砂岩	27.61	18.3	8.06	656	1840	0.02	0.43
9.02		34.59	18.1	15.7	920	2000	0.02	0.37
-25.57	泥岩 (下部層)	44.43	16.9	10.5	781	1860	0.02	0.39
-70.00	解放基盤表面	—	16.9	10.7	790	1880	0.01	0.39

第 3.2.1-6 表 地盤定数 (S s - B 2)

標高 T. M. S. L. (m)	地層区分	層厚 (m)	単位 体積重量 γ_t (kN/m^3)	せん断 弾性係数 G ($\times 10^5 \text{kN}/\text{m}^2$)	等価 S波速度 (m/s)	等価 P波速度 (m/s)	等価 減衰定数 h	ポアソン比
53.80	MMR	14.80	18.3	8.45	672	1880	0.02	0.43
39.00	細粒砂岩	1.92	18.3	8.29	666	1870	0.02	0.43
37.08	粗粒砂岩	0.45	18.3	7.41	629	1760	0.03	0.43
36.63	細粒砂岩	27.61	18.3	8.12	659	1850	0.02	0.43
9.02		34.59	18.1	15.6	918	1990	0.02	0.37
-25.57	泥岩 (下部層)	44.43	16.9	10.5	780	1860	0.02	0.39
-70.00	解放基盤表面	—	16.9	10.7	790	1880	0.01	0.39

第 3.2.1-7 表 地盤定数 (S s - B 3)

標高 T. M. S. L. (m)	地層区分	層厚 (m)	単位 体積重量 γ_t (kN/m^3)	せん断 弾性係数 G ($\times 10^5 \text{kN}/\text{m}^2$)	等価 S波速度 (m/s)	等価 P波速度 (m/s)	等価 減衰定数 h	ポアソン比
53.80	MMR	14.80	18.3	8.44	672	1880	0.02	0.43
39.00	細粒砂岩	1.92	18.3	8.27	665	1860	0.02	0.43
37.08	粗粒砂岩	0.45	18.3	7.37	628	1760	0.03	0.43
36.63	細粒砂岩	27.61	18.3	8.08	657	1840	0.02	0.43
9.02		34.59	18.1	15.6	918	1990	0.02	0.37
-25.57	泥岩 (下部層)	44.43	16.9	10.5	780	1860	0.02	0.39
-70.00	解放基盤表面	—	16.9	10.7	790	1880	0.01	0.39

第 3.2.1-8 表 地盤定数 (S s - B 4)

標高 T. M. S. L. (m)	地層区分	層厚 (m)	単位 体積重量 γ_t (kN/m ³)	せん断 弾性係数 G ($\times 10^5$ kN/m ²)	等価 S波速度 (m/s)	等価 P波速度 (m/s)	等価 減衰定数 h	ポアソン比
53.80	MMR	14.80	18.3	8.43	671	1880	0.02	0.43
39.00	細粒砂岩	1.92	18.3	8.27	665	1860	0.02	0.43
37.08	粗粒砂岩	0.45	18.3	7.37	628	1760	0.03	0.43
36.63	細粒砂岩	27.61	18.3	8.10	658	1840	0.02	0.43
9.02		34.59	18.1	15.4	912	1980	0.02	0.37
-25.57	泥岩 (下部層)	44.43	16.9	10.4	776	1850	0.02	0.39
-70.00	解放基盤表面	—	16.9	10.7	790	1880	0.01	0.39

第 3.2.1-9 表 地盤定数 (S s - B 5)

標高 T. M. S. L. (m)	地層区分	層厚 (m)	単位 体積重量 γ_t (kN/m ³)	せん断 弾性係数 G ($\times 10^5$ kN/m ²)	等価 S波速度 (m/s)	等価 P波速度 (m/s)	等価 減衰定数 h	ポアソン比
53.80	MMR	14.80	18.3	8.42	671	1880	0.02	0.43
39.00	細粒砂岩	1.92	18.3	8.22	663	1860	0.02	0.43
37.08	粗粒砂岩	0.45	18.3	7.15	618	1730	0.03	0.43
36.63	細粒砂岩	27.61	18.3	8.01	654	1830	0.02	0.43
9.02		34.59	18.1	15.4	912	1980	0.02	0.37
-25.57	泥岩 (下部層)	44.43	16.9	10.4	777	1850	0.02	0.39
-70.00	解放基盤表面	—	16.9	10.7	790	1880	0.01	0.39

第 3.2.1-10 表 地盤定数 (S s - C 1)

標高 T. M. S. L. (m)	地層区分	層厚 (m)	単位 体積重量 γ_t (kN/m ³)	せん断 弾性係数 G ($\times 10^5$ kN/m ²)	等価 S波速度 (m/s)	等価 P波速度 (m/s)	等価 減衰定数 h	ポアソン比
53.80	MMR	14.80	18.3	8.41	671	1880	0.02	0.43
39.00	細粒砂岩	1.92	18.3	8.20	662	1850	0.02	0.43
37.08	粗粒砂岩	0.45	18.3	7.10	616	1730	0.03	0.43
36.63	細粒砂岩	27.61	18.3	7.94	652	1830	0.02	0.43
9.02		34.59	18.1	15.2	906	1960	0.02	0.37
-25.57	泥岩 (下部層)	44.43	16.9	10.3	773	1840	0.02	0.39
-70.00	解放基盤表面	—	16.9	10.7	790	1880	0.01	0.39

第 3.2.1-11 表 地盤定数 (S s - C 2)

標高 T. M. S. L. (m)	地層区分	層厚 (m)	単位 体積重量 γ_t (kN/m ³)	せん断 弾性係数 G ($\times 10^5$ kN/m ²)	等価 S波速度 (m/s)	等価 P波速度 (m/s)	等価 減衰定数 h	ポアソン比
53.80	MMR	14.80	18.3	8.46	673	1890	0.02	0.43
39.00	細粒砂岩	1.92	18.3	8.34	668	1870	0.02	0.43
37.08	粗粒砂岩	0.45	18.3	7.56	636	1780	0.03	0.43
36.63	細粒砂岩	27.61	18.3	8.18	661	1850	0.02	0.43
9.02		34.59	18.1	15.6	917	1990	0.02	0.37
-25.57	泥岩 (下部層)	44.43	16.9	10.5	780	1860	0.02	0.39
-70.00	解放基盤表面	—	16.9	10.7	790	1880	0.01	0.39

第 3.2.1-12 表 地盤定数 (S s - C 3)

標高 T. M. S. L. (m)	地層区分	層厚 (m)	単位 体積重量 γ_t (kN/m^3)	せん断 弾性係数 G ($\times 10^5 \text{kN}/\text{m}^2$)	等価 S波速度 (m/s)	等価 P波速度 (m/s)	等価 減衰定数 h	ポアソン比
53.80	MMR	14.80	18.3	8.45	672	1880	0.02	0.43
39.00	細粒砂岩	1.92	18.3	8.30	666	1870	0.02	0.43
37.08	粗粒砂岩	0.45	18.3	7.43	630	1770	0.03	0.43
36.63	細粒砂岩	27.61	18.3	8.17	661	1850	0.02	0.43
9.02		34.59	18.1	15.6	918	1990	0.02	0.37
-25.57	泥岩 (下部層)	44.43	16.9	10.4	779	1860	0.02	0.39
-70.00	解放基盤表面	—	16.9	10.7	790	1880	0.01	0.39

第 3.2.1-13 表 地盤定数 (S s - C 4)

標高 T. M. S. L. (m)	地層区分	層厚 (m)	単位 体積重量 γ_t (kN/m^3)	せん断 弾性係数 G ($\times 10^5 \text{kN}/\text{m}^2$)	等価 S波速度 (m/s)	等価 P波速度 (m/s)	等価 減衰定数 h	ポアソン比
53.80	MMR	14.80	18.3	8.44	672	1880	0.02	0.43
39.00	細粒砂岩	1.92	18.3	8.29	666	1870	0.02	0.43
37.08	粗粒砂岩	0.45	18.3	7.41	629	1760	0.03	0.43
36.63	細粒砂岩	27.61	18.3	8.13	659	1850	0.02	0.43
9.02		34.59	18.1	15.5	916	1990	0.02	0.37
-25.57	泥岩 (下部層)	44.43	16.9	10.4	779	1860	0.02	0.39
-70.00	解放基盤表面	—	16.9	10.7	790	1880	0.01	0.39

第 3.2.1-14 表 地盤定数 (S d - A)

標高 T. M. S. L. (m)	地層区分	層厚 (m)	単位 体積重量 γ_t (kN/m^3)	せん断 弾性係数 G ($\times 10^5 \text{kN}/\text{m}^2$)	等価 S波速度 (m/s)	等価 P波速度 (m/s)	等価 減衰定数 h	ポアソン比
53.80	MMR	14.80	18.3	8.50	674	1890	0.01	0.43
39.00	細粒砂岩	1.92	18.3	8.41	671	1880	0.02	0.43
37.08	粗粒砂岩	0.45	18.3	7.74	643	1800	0.02	0.43
36.63	細粒砂岩	27.61	18.3	8.33	667	1870	0.02	0.43
9.02		34.59	18.1	15.8	925	2010	0.02	0.37
-25.57	泥岩 (下部層)	44.43	16.9	10.6	783	1860	0.01	0.39
-70.00	解放基盤表面	—	16.9	10.7	790	1880	0.01	0.39

第 3.2.1-15 表 地盤定数 (S d - B 1)

標高 T. M. S. L. (m)	地層区分	層厚 (m)	単位 体積重量 γ_t (kN/m^3)	せん断 弾性係数 G ($\times 10^5 \text{kN}/\text{m}^2$)	等価 S波速度 (m/s)	等価 P波速度 (m/s)	等価 減衰定数 h	ポアソン比
53.80	MMR	14.80	18.3	8.52	675	1890	0.01	0.43
39.00	細粒砂岩	1.92	18.3	8.42	671	1880	0.02	0.43
37.08	粗粒砂岩	0.45	18.3	7.76	644	1800	0.02	0.43
36.63	細粒砂岩	27.61	18.3	8.31	667	1870	0.02	0.43
9.02		34.59	18.1	15.9	928	2010	0.02	0.37
-25.57	泥岩 (下部層)	44.43	16.9	10.6	785	1870	0.01	0.39
-70.00	解放基盤表面	—	16.9	10.7	790	1880	0.01	0.39

第 3.2.1-16 表 地盤定数 (S d - B 2)

標高 T. M. S. L. (m)	地層区分	層厚 (m)	単位 体積重量 γ_t (kN/m^3)	せん断 弾性係数 G ($\times 10^5 \text{kN}/\text{m}^2$)	等価 S波速度 (m/s)	等価 P波速度 (m/s)	等価 減衰定数 h	ポアソン比
53.80	MMR	14.80	18.3	8.53	675	1890	0.01	0.43
39.00	細粒砂岩	1.92	18.3	8.44	672	1880	0.02	0.43
37.08	粗粒砂岩	0.45	18.3	7.83	647	1810	0.02	0.43
36.63	細粒砂岩	27.61	18.3	8.35	668	1870	0.02	0.43
9.02		34.59	18.1	15.9	928	2010	0.02	0.37
-25.57	泥岩 (下部層)	44.43	16.9	10.6	785	1870	0.01	0.39
-70.00	解放基盤表面	—	16.9	10.7	790	1880	0.01	0.39

第 3.2.1-17 表 地盤定数 (S d - B 3)

標高 T. M. S. L. (m)	地層区分	層厚 (m)	単位 体積重量 γ_t (kN/m^3)	せん断 弾性係数 G ($\times 10^5 \text{kN}/\text{m}^2$)	等価 S波速度 (m/s)	等価 P波速度 (m/s)	等価 減衰定数 h	ポアソン比
53.80	MMR	14.80	18.3	8.53	675	1890	0.01	0.43
39.00	細粒砂岩	1.92	18.3	8.43	671	1880	0.02	0.43
37.08	粗粒砂岩	0.45	18.3	7.80	646	1810	0.02	0.43
36.63	細粒砂岩	27.61	18.3	8.32	667	1870	0.02	0.43
9.02		34.59	18.1	15.9	927	2010	0.02	0.37
-25.57	泥岩 (下部層)	44.43	16.9	10.6	785	1870	0.01	0.39
-70.00	解放基盤表面	—	16.9	10.7	790	1880	0.01	0.39

第 3.2.1-18 表 地盤定数 (S d - B 4)

標高 T. M. S. L. (m)	地層区分	層厚 (m)	単位 体積重量 γ_t (kN/m^3)	せん断 弾性係数 G ($\times 10^5 \text{kN}/\text{m}^2$)	等価 S波速度 (m/s)	等価 P波速度 (m/s)	等価 減衰定数 h	ポアソン比
53.80	MMR	14.80	18.3	8.53	675	1890	0.01	0.43
39.00	細粒砂岩	1.92	18.3	8.43	671	1880	0.02	0.43
37.08	粗粒砂岩	0.45	18.3	7.80	646	1810	0.02	0.43
36.63	細粒砂岩	27.61	18.3	8.33	667	1870	0.02	0.43
9.02		34.59	18.1	15.8	925	2010	0.02	0.37
-25.57	泥岩 (下部層)	44.43	16.9	10.5	782	1860	0.02	0.39
-70.00	解放基盤表面	—	16.9	10.7	790	1880	0.01	0.39

第 3.2.1-19 表 地盤定数 (S d - B 5)

標高 T. M. S. L. (m)	地層区分	層厚 (m)	単位 体積重量 γ_t (kN/m^3)	せん断 弾性係数 G ($\times 10^5 \text{kN}/\text{m}^2$)	等価 S波速度 (m/s)	等価 P波速度 (m/s)	等価 減衰定数 h	ポアソン比
53.80	MMR	14.80	18.3	8.52	675	1890	0.01	0.43
39.00	細粒砂岩	1.92	18.3	8.41	671	1880	0.02	0.43
37.08	粗粒砂岩	0.45	18.3	7.73	643	1800	0.02	0.43
36.63	細粒砂岩	27.61	18.3	8.28	665	1860	0.02	0.43
9.02		34.59	18.1	15.8	924	2000	0.02	0.37
-25.57	泥岩 (下部層)	44.43	16.9	10.5	783	1860	0.01	0.39
-70.00	解放基盤表面	—	16.9	10.7	790	1880	0.01	0.39

第 3.2.1-20 表 地盤定数 (S d - C 1)

標高 T. M. S. L. (m)	地層区分	層厚 (m)	単位 体積重量 γ_t (kN/m^3)	せん断 弾性係数 G ($\times 10^5 \text{kN}/\text{m}^2$)	等価 S波速度 (m/s)	等価 P波速度 (m/s)	等価 減衰定数 h	ポアソン比
53.80	MMR	14.80	18.3	8.51	675	1890	0.01	0.43
39.00	細粒砂岩	1.92	18.3	8.40	670	1880	0.02	0.43
37.08	粗粒砂岩	0.45	18.3	7.70	642	1800	0.02	0.43
36.63	細粒砂岩	27.61	18.3	8.24	664	1860	0.02	0.43
9.02		34.59	18.1	15.7	921	2000	0.02	0.37
-25.57	泥岩 (下部層)	44.43	16.9	10.5	781	1860	0.02	0.39
-70.00	解放基盤表面	—	16.9	10.7	790	1880	0.01	0.39

第 3.2.1-21 表 地盤定数 (S d - C 2)

標高 T. M. S. L. (m)	地層区分	層厚 (m)	単位 体積重量 γ_t (kN/m^3)	せん断 弾性係数 G ($\times 10^5 \text{kN}/\text{m}^2$)	等価 S波速度 (m/s)	等価 P波速度 (m/s)	等価 減衰定数 h	ポアソン比
53.80	MMR	14.80	18.3	8.54	676	1890	0.01	0.43
39.00	細粒砂岩	1.92	18.3	8.47	673	1890	0.02	0.43
37.08	粗粒砂岩	0.45	18.3	7.93	651	1820	0.02	0.43
36.63	細粒砂岩	27.61	18.3	8.38	669	1870	0.02	0.43
9.02		34.59	18.1	15.9	927	2010	0.02	0.37
-25.57	泥岩 (下部層)	44.43	16.9	10.6	785	1870	0.01	0.39
-70.00	解放基盤表面	—	16.9	10.7	790	1880	0.01	0.39

第 3.2.1-22 表 地盤定数 (S d - C 3)

標高 T. M. S. L. (m)	地層区分	層厚 (m)	単位 体積重量 γ_t (kN/m^3)	せん断 弾性係数 G ($\times 10^5 \text{kN}/\text{m}^2$)	等価 S波速度 (m/s)	等価 P波速度 (m/s)	等価 減衰定数 h	ポアソン比
53.80	MMR	14.80	18.3	8.53	675	1890	0.01	0.43
39.00	細粒砂岩	1.92	18.3	8.44	672	1880	0.02	0.43
37.08	粗粒砂岩	0.45	18.3	7.84	647	1810	0.02	0.43
36.63	細粒砂岩	27.61	18.3	8.38	669	1870	0.02	0.43
9.02		34.59	18.1	15.9	928	2010	0.02	0.37
-25.57	泥岩 (下部層)	44.43	16.9	10.6	784	1870	0.01	0.39
-70.00	解放基盤表面	—	16.9	10.7	790	1880	0.01	0.39

第 3.2.1-23 表 地盤定数 (S d - C 4)

標高 T. M. S. L. (m)	地層区分	層厚 (m)	単位 体積重量 γ_t (kN/m^3)	せん断 弾性係数 G ($\times 10^5 \text{kN}/\text{m}^2$)	等価 S波速度 (m/s)	等価 P波速度 (m/s)	等価 減衰定数 h	ポアソン比
53.80	MMR	14.80	18.3	8.53	675	1890	0.01	0.43
39.00	細粒砂岩	1.92	18.3	8.44	672	1880	0.02	0.43
37.08	粗粒砂岩	0.45	18.3	7.83	647	1810	0.02	0.43
36.63	細粒砂岩	27.61	18.3	8.36	669	1870	0.02	0.43
9.02		34.59	18.1	15.9	927	2010	0.02	0.37
-25.57	泥岩 (下部層)	44.43	16.9	10.6	784	1870	0.01	0.39
-70.00	解放基盤表面	—	16.9	10.7	790	1880	0.01	0.39

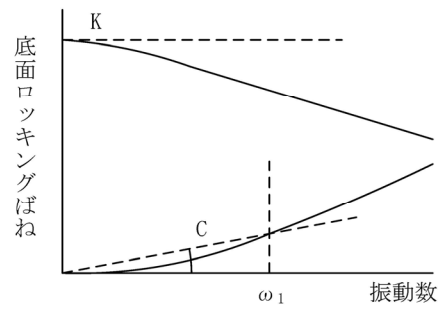
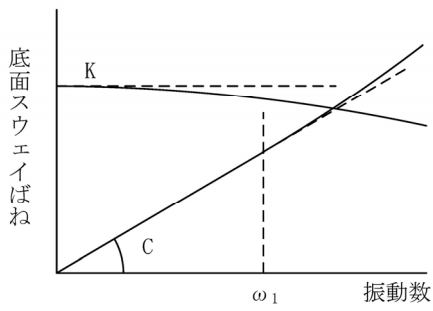

ばね定数：0Hz のばね定数 K で定数化

減衰係数：振動系全体のうち地盤の影響が卓越する最初の固有振動数 ω_1 に対応する虚部の値と原点を結ぶ直線の傾き C で定数化

第 3.2.1-8 図 地盤ばねの定数化の概要

第 3.2.1-24 表 地盤ばね定数と減衰係数 (S s - A)

(a)NS 方向

		質点 番号	ばね定数	減衰係数
底面スウェイばね	K_S			
底面ロッキングばね	K_R			

注記 1: スウェイばね: ばね定数 (kN/m), 減衰係数 (kN·s/m)

2: ロッキングばね: ばね定数 (kN·m/rad), 減衰係数 (kN·m·s/rad)

(b)EW 方向

		質点 番号	ばね定数	減衰係数
底面スウェイばね	K_S			
底面ロッキングばね	K_R			

注記 1: スウェイばね: ばね定数 (kN/m), 減衰係数 (kN·s/m)

2: ロッキングばね: ばね定数 (kN·m/rad), 減衰係数 (kN·m·s/rad)

第 3.2.1-25 表 地盤ばね定数と減衰係数 (S s - B 1)

(a)NS 方向

		質点 番号	ばね定数	減衰係数
底面スウェイばね	K_S			
底面ロッキングばね	K_R			

注記 1: スウェイばね: ばね定数 (kN/m), 減衰係数 (kN·s/m)

2: ロッキングばね: ばね定数 (kN·m/rad), 減衰係数 (kN·m·s/rad)

(b)EW 方向

		質点 番号	ばね定数	減衰係数
底面スウェイばね	K_S			
底面ロッキングばね	K_R			

注記 1: スウェイばね: ばね定数 (kN/m), 減衰係数 (kN·s/m)

2: ロッキングばね: ばね定数 (kN·m/rad), 減衰係数 (kN·m·s/rad)

第 3.2.1-26 表 地盤ばね定数と減衰係数 (S s - B 2)

(a)NS 方向

		質点 番号	ばね定数	減衰係数
底面スウェイばね	K_S			
底面ロッキングばね	K_R			

注記 1: スウェイばね: ばね定数 (kN/m), 減衰係数 (kN·s/m)

2: ロッキングばね: ばね定数 (kN·m/rad), 減衰係数 (kN·m·s/rad)

(b)EW 方向

		質点 番号	ばね定数	減衰係数
底面スウェイばね	K_S			
底面ロッキングばね	K_R			

注記 1: スウェイばね: ばね定数 (kN/m), 減衰係数 (kN·s/m)

2: ロッキングばね: ばね定数 (kN·m/rad), 減衰係数 (kN·m·s/rad)

第 3.2.1-27 表 地盤ばね定数と減衰係数 (S s - B 3)

(a)NS 方向

		質点 番号	ばね定数	減衰係数
底面スウェイばね	K_S			
底面ロッキングばね	K_R			

注記 1: スウェイばね: ばね定数 (kN/m), 減衰係数 (kN·s/m)

2: ロッキングばね: ばね定数 (kN·m/rad), 減衰係数 (kN·m·s/rad)

(b)EW 方向

		質点 番号	ばね定数	減衰係数
底面スウェイばね	K_S			
底面ロッキングばね	K_R			

注記 1: スウェイばね: ばね定数 (kN/m), 減衰係数 (kN·s/m)

2: ロッキングばね: ばね定数 (kN·m/rad), 減衰係数 (kN·m·s/rad)

第 3.2.1-28 表 地盤ばね定数と減衰係数 (S s - B 4)

(a)NS 方向

		質点 番号	ばね定数	減衰係数
底面スウェイばね	K_S			
底面ロックンクばね	K_R			

注記 1: スウェイばね: ばね定数 (kN/m), 減衰係数 (kN·s/m)

2: ロックンクばね: ばね定数 (kN·m/rad), 減衰係数 (kN·m·s/rad)

(b)EW 方向

		質点 番号	ばね定数	減衰係数
底面スウェイばね	K_S			
底面ロックンクばね	K_R			

注記 1: スウェイばね: ばね定数 (kN/m), 減衰係数 (kN·s/m)

2: ロックンクばね: ばね定数 (kN·m/rad), 減衰係数 (kN·m·s/rad)

第 3.2.1-29 表 地盤ばね定数と減衰係数 (S s - B 5)

(a)NS 方向

		質点 番号	ばね定数	減衰係数
底面スウェイばね	K_S			
底面ロッキングばね	K_R			

注記 1: スウェイばね: ばね定数 (kN/m), 減衰係数 (kN·s/m)

2: ロッキングばね: ばね定数 (kN·m/rad), 減衰係数 (kN·m·s/rad)

(b)EW 方向

		質点 番号	ばね定数	減衰係数
底面スウェイばね	K_S			
底面ロッキングばね	K_R			

注記 1: スウェイばね: ばね定数 (kN/m), 減衰係数 (kN·s/m)

2: ロッキングばね: ばね定数 (kN·m/rad), 減衰係数 (kN·m·s/rad)

第 3.2.1-30 表 地盤ばね定数と減衰係数 (S s - C 1)

(a)NS 方向

		質点 番号	ばね定数	減衰係数
底面スウェイばね	K_S			
底面ロッキングばね	K_R			

注記 1: スウェイばね: ばね定数 (kN/m), 減衰係数 (kN·s/m)

2: ロッキングばね: ばね定数 (kN·m/rad), 減衰係数 (kN·m·s/rad)

(b)EW 方向

		質点 番号	ばね定数	減衰係数
底面スウェイばね	K_S			
底面ロッキングばね	K_R			

注記 1: スウェイばね: ばね定数 (kN/m), 減衰係数 (kN·s/m)

2: ロッキングばね: ばね定数 (kN·m/rad), 減衰係数 (kN·m·s/rad)

第 3.2.1-31 表 地盤ばね定数と減衰係数 (S s - C 2)

(a)NS 方向

		質点 番号	ばね定数	減衰係数
底面スウェイばね	K_S			
底面ロックンクばね	K_R			

注記 1: スウェイばね: ばね定数 (kN/m), 減衰係数 (kN·s/m)

2: ロックンクばね: ばね定数 (kN·m/rad), 減衰係数 (kN·m·s/rad)

(b)EW 方向

		質点 番号	ばね定数	減衰係数
底面スウェイばね	K_S			
底面ロックンクばね	K_R			

注記 1: スウェイばね: ばね定数 (kN/m), 減衰係数 (kN·s/m)

2: ロックンクばね: ばね定数 (kN·m/rad), 減衰係数 (kN·m·s/rad)

第 3.2.1-32 表 地盤ばね定数と減衰係数 (S s - C 3)

(a)NS 方向

		質点 番号	ばね定数	減衰係数
底面スウェイばね	K_S			
底面ロッキングばね	K_R			

注記 1: スウェイばね: ばね定数 (kN/m), 減衰係数 (kN·s/m)

2: ロッキングばね: ばね定数 (kN·m/rad), 減衰係数 (kN·m·s/rad)

(b)EW 方向

		質点 番号	ばね定数	減衰係数
底面スウェイばね	K_S			
底面ロッキングばね	K_R			

注記 1: スウェイばね: ばね定数 (kN/m), 減衰係数 (kN·s/m)

2: ロッキングばね: ばね定数 (kN·m/rad), 減衰係数 (kN·m·s/rad)

第 3.2.1-33 表 地盤ばね定数と減衰係数 (S s - C 4)

(a)NS 方向

		質点 番号	ばね定数	減衰係数
底面スウェイばね	K_S			
底面ロックンクばね	K_R			

注記 1: スウェイばね: ばね定数 (kN/m), 減衰係数 (kN·s/m)

2: ロックンクばね: ばね定数 (kN·m/rad), 減衰係数 (kN·m·s/rad)

(b)EW 方向

		質点 番号	ばね定数	減衰係数
底面スウェイばね	K_S			
底面ロックンクばね	K_R			

注記 1: スウェイばね: ばね定数 (kN/m), 減衰係数 (kN·s/m)

2: ロックンクばね: ばね定数 (kN·m/rad), 減衰係数 (kN·m·s/rad)

第 3.2.1-34 表 地盤ばね定数と減衰係数 (S d - A)

(a)NS 方向

		質点 番号	ばね定数	減衰係数
底面スウェイばね	K_S			
底面ロックンクばね	K_R			

注記 1: スウェイばね: ばね定数 (kN/m), 減衰係数 (kN·s/m)

2: ロックンクばね: ばね定数 (kN·m/rad), 減衰係数 (kN·m·s/rad)

(b)EW 方向

		質点 番号	ばね定数	減衰係数
底面スウェイばね	K_S			
底面ロックンクばね	K_R			

注記 1: スウェイばね: ばね定数 (kN/m), 減衰係数 (kN·s/m)

2: ロックンクばね: ばね定数 (kN·m/rad), 減衰係数 (kN·m·s/rad)

第 3.2.1-35 表 地盤ばね定数と減衰係数 (S d - B 1)

(a)NS 方向

		質点 番号	ばね定数	減衰係数
底面スウェイばね	K_S			
底面ロッキングばね	K_R			

注記 1: スウェイばね: ばね定数 (kN/m), 減衰係数 (kN·s/m)

2: ロッキングばね: ばね定数 (kN·m/rad), 減衰係数 (kN·m·s/rad)

(b)EW 方向

		質点 番号	ばね定数	減衰係数
底面スウェイばね	K_S			
底面ロッキングばね	K_R			

注記 1: スウェイばね: ばね定数 (kN/m), 減衰係数 (kN·s/m)

2: ロッキングばね: ばね定数 (kN·m/rad), 減衰係数 (kN·m·s/rad)

第 3.2.1-36 表 地盤ばね定数と減衰係数 (S d - B 2)

(a)NS 方向

		質点 番号	ばね定数	減衰係数
底面スウェイばね	K_S			
底面ロックンクばね	K_R			

注記 1: スウェイばね: ばね定数 (kN/m), 減衰係数 (kN・s/m)

2: ロックンクばね: ばね定数 (kN・m/rad), 減衰係数 (kN・m・s/rad)

(b)EW 方向

		質点 番号	ばね定数	減衰係数
底面スウェイばね	K_S			
底面ロックンクばね	K_R			

注記 1: スウェイばね: ばね定数 (kN/m), 減衰係数 (kN・s/m)

2: ロックンクばね: ばね定数 (kN・m/rad), 減衰係数 (kN・m・s/rad)

第 3.2.1-37 表 地盤ばね定数と減衰係数 (S d - B 3)

(a)NS 方向

		質点 番号	ばね定数	減衰係数
底面スウェイばね	K_S			
底面ロッキングばね	K_R			

注記 1: スウェイばね: ばね定数 (kN/m), 減衰係数 (kN·s/m)

2: ロッキングばね: ばね定数 (kN·m/rad), 減衰係数 (kN·m·s/rad)

(b)EW 方向

		質点 番号	ばね定数	減衰係数
底面スウェイばね	K_S			
底面ロッキングばね	K_R			

注記 1: スウェイばね: ばね定数 (kN/m), 減衰係数 (kN·s/m)

2: ロッキングばね: ばね定数 (kN·m/rad), 減衰係数 (kN·m·s/rad)

第 3.2.1-38 表 地盤ばね定数と減衰係数 (S d - B 4)

(a)NS 方向

		質点 番号	ばね定数	減衰係数
底面スウェイばね	K_S			
底面ロッキングばね	K_R			

注記 1: スウェイばね: ばね定数 (kN/m), 減衰係数 (kN·s/m)

2: ロッキングばね: ばね定数 (kN·m/rad), 減衰係数 (kN·m·s/rad)

(b)EW 方向

		質点 番号	ばね定数	減衰係数
底面スウェイばね	K_S			
底面ロッキングばね	K_R			

注記 1: スウェイばね: ばね定数 (kN/m), 減衰係数 (kN·s/m)

2: ロッキングばね: ばね定数 (kN·m/rad), 減衰係数 (kN·m·s/rad)

第 3.2.1-39 表 地盤ばね定数と減衰係数 (S d - B 5)

(a)NS 方向

		質点 番号	ばね定数	減衰係数
底面スウェイばね	K_S			
底面ロッキングばね	K_R			

注記 1: スウェイばね: ばね定数 (kN/m), 減衰係数 (kN・s/m)

2: ロッキングばね: ばね定数 (kN・m/rad), 減衰係数 (kN・m・s/rad)

(b)EW 方向

		質点 番号	ばね定数	減衰係数
底面スウェイばね	K_S			
底面ロッキングばね	K_R			

注記 1: スウェイばね: ばね定数 (kN/m), 減衰係数 (kN・s/m)

2: ロッキングばね: ばね定数 (kN・m/rad), 減衰係数 (kN・m・s/rad)

第 3.2.1-40 表 地盤ばね定数と減衰係数 (S d - C 1)

(a)NS 方向

		質点 番号	ばね定数	減衰係数
底面スウェイばね	K_S			
底面ロックンクばね	K_R			

注記 1: スウェイばね: ばね定数 (kN/m), 減衰係数 (kN・s/m)

2: ロックンクばね: ばね定数 (kN・m/rad), 減衰係数 (kN・m・s/rad)

(b)EW 方向

		質点 番号	ばね定数	減衰係数
底面スウェイばね	K_S			
底面ロックンクばね	K_R			

注記 1: スウェイばね: ばね定数 (kN/m), 減衰係数 (kN・s/m)

2: ロックンクばね: ばね定数 (kN・m/rad), 減衰係数 (kN・m・s/rad)

第 3.2.1-41 表 地盤ばね定数と減衰係数 (S d - C 2)

(a)NS 方向

		質点 番号	ばね定数	減衰係数
底面スウェイばね	K_S			
底面ロックンクばね	K_R			

注記 1: スウェイばね: ばね定数 (kN/m), 減衰係数 (kN·s/m)

2: ロックンクばね: ばね定数 (kN·m/rad), 減衰係数 (kN·m·s/rad)

(b)EW 方向

		質点 番号	ばね定数	減衰係数
底面スウェイばね	K_S			
底面ロックンクばね	K_R			

注記 1: スウェイばね: ばね定数 (kN/m), 減衰係数 (kN·s/m)

2: ロックンクばね: ばね定数 (kN·m/rad), 減衰係数 (kN·m·s/rad)

第 3.2.1-42 表 地盤ばね定数と減衰係数 (S d - C 3)

(a)NS 方向

		質点 番号	ばね定数	減衰係数
底面スウェイばね	K_S			
底面ロッキングばね	K_R			

注記 1: スウェイばね: ばね定数 (kN/m), 減衰係数 (kN·s/m)

2: ロッキングばね: ばね定数 (kN·m/rad), 減衰係数 (kN·m·s/rad)

(b)EW 方向

		質点 番号	ばね定数	減衰係数
底面スウェイばね	K_S			
底面ロッキングばね	K_R			

注記 1: スウェイばね: ばね定数 (kN/m), 減衰係数 (kN·s/m)

2: ロッキングばね: ばね定数 (kN·m/rad), 減衰係数 (kN·m·s/rad)

第 3.2.1-43 表 地盤ばね定数と減衰係数 (S d - C 4)

(a)NS 方向

		質点 番号	ばね定数	減衰係数
底面スウェイばね	K_S			
底面ロッキングばね	K_R			

注記 1: スウェイばね: ばね定数 (kN/m), 減衰係数 (kN·s/m)

2: ロッキングばね: ばね定数 (kN·m/rad), 減衰係数 (kN·m·s/rad)

(b)EW 方向

		質点 番号	ばね定数	減衰係数
底面スウェイばね	K_S			
底面ロッキングばね	K_R			

注記 1: スウェイばね: ばね定数 (kN/m), 減衰係数 (kN·s/m)

2: ロッキングばね: ばね定数 (kN·m/rad), 減衰係数 (kN·m·s/rad)

3.2.2 鉛直方向モデル

鉛直方向の地震応答解析モデルは、構築物と地盤の相互作用を考慮した構築物－地盤連成モデルとし、基礎スラブの軸剛性及び鉄骨造の支持架構の等価軸剛性を評価した質点系モデルを用いる。地震応答解析は弾性時刻歴応答解析により行う。鉛直方向の地震応答解析モデルを第3.2.2-1図、解析モデルの諸元を第3.2.2-1表に示す。

構築物の各部材の剛性として、鉄筋コンクリート造の基礎については、基礎躯体の軸断面積に基づき評価する。鉄骨造の支持架構については、柱、梁及びブレースの各部材の剛性並びに質量を考慮した3次元フレームモデルの固有値解析結果から求めた等価軸断面積を考慮する。

地盤は、地盤調査に基づき水平成層地盤とし、基礎底面地盤ばねについては、「JEAG 4601-1991 追補版」により、成層補正を行ったのち、振動アドミタンス理論に基づき求めた鉛直地盤ばねを近似法により定数化して用いる。基礎底面地盤ばねの評価には解析コード「VA Ver. 2.0」を用いる。なお、地盤定数については、ひずみ依存特性を考慮して求めた等価物性値を用いる。

「IV-1-1-2 地盤の支持性能に係る基本方針」に基づく地盤の初期物性値を第3.2.1-3表に、ひずみ依存特性を第3.2.1-3図に示す。地盤の等価線形解析で得られる等価物性値に基づき設定した地盤定数を第3.2.1-4表～第3.2.1-23表に示す。また、地盤ばねの定数化の概要を第3.2.2-2図に、地盤ばね定数及び減衰係数を第3.2.2-2表～第3.2.2-19表に示す。

なお、解析コードの検証及び妥当性確認等の概要については、「IV-3 計算機プログラム（解析コード）の概要」に示す。



- 注記 1 : ○数字は質点番号を示す。
 2 : □数字は要素番号を示す。
 3 : K_v は底面鉛直ばねを示す。

第 3.2.2-1 図 地震応答解析モデル (鉛直方向)

第 3.2.2-1 表 地震応答解析モデル諸元 (鉛直方向)

質点番号	質点位置 T. M. S. L. (m)	重量 W (kN)	要素番号	要素位置 T. M. S. L. (m)	軸断面積 A (m ²)
			—	—	—
構築物総重量			—	—	—

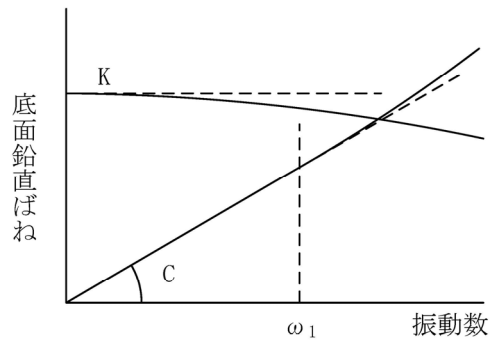

ばね定数：0Hz のばね定数 K で定数化

減衰係数：振動系全体のうち地盤の影響が卓越する最初の固有振動数 ω_1 に対応する虚部の値と原点を結ぶ直線の傾き C で定数化

第 3.2.2-2 図 鉛直地盤ばねの定数化の概要

第 3. 2. 2-2 表 地盤ばね定数と減衰係数 (S_s-A, 鉛直方向)

		質点 番号	ばね定数 (kN/m)	減衰係数 (kN・s/m)
底面鉛直ばね	K _v			

第 3. 2. 2-3 表 地盤ばね定数と減衰係数 (S_s-B 1, 鉛直方向)

		質点 番号	ばね定数 (kN/m)	減衰係数 (kN・s/m)
底面鉛直ばね	K _v			

第 3. 2. 2-4 表 地盤ばね定数と減衰係数 (S_s-B 2, 鉛直方向)

		質点 番号	ばね定数 (kN/m)	減衰係数 (kN・s/m)
底面鉛直ばね	K _v			

第 3. 2. 2-5 表 地盤ばね定数と減衰係数 (S_s-B 3, 鉛直方向)

		質点 番号	ばね定数 (kN/m)	減衰係数 (kN・s/m)
底面鉛直ばね	K _v			

第 3. 2. 2-6 表 地盤ばね定数と減衰係数 (S_s-B 4, 鉛直方向)

		質点 番号	ばね定数 (kN/m)	減衰係数 (kN・s/m)
底面鉛直ばね	K _v			

第 3. 2. 2-7 表 地盤ばね定数と減衰係数 (S_s-B 5, 鉛直方向)

		質点 番号	ばね定数 (kN/m)	減衰係数 (kN・s/m)
底面鉛直ばね	K _v			

第 3.2.2-8 表 地盤ばね定数と減衰係数 (S s - C 1, 鉛直方向)

		質点 番号	ばね定数 (kN/m)	減衰係数 (kN・s/m)
底面鉛直ばね	K_v			

第 3.2.2-9 表 地盤ばね定数と減衰係数 (S s - C 2, 鉛直方向)

		質点 番号	ばね定数 (kN/m)	減衰係数 (kN・s/m)
底面鉛直ばね	K_v			

第 3.2.2-10 表 地盤ばね定数と減衰係数 (S s - C 3, 鉛直方向)

		質点 番号	ばね定数 (kN/m)	減衰係数 (kN・s/m)
底面鉛直ばね	K_v			

第 3.2.2-11 表 地盤ばね定数と減衰係数 (S d - A, 鉛直方向)

		質点 番号	ばね定数 (kN/m)	減衰係数 (kN・s/m)
底面鉛直ばね	K_v			

第 3.2.2-12 表 地盤ばね定数と減衰係数 (S d - B 1, 鉛直方向)

		質点 番号	ばね定数 (kN/m)	減衰係数 (kN・s/m)
底面鉛直ばね	K_v			

第 3.2.2-13 表 地盤ばね定数と減衰係数 (S d - B 2, 鉛直方向)

		質点 番号	ばね定数 (kN/m)	減衰係数 (kN・s/m)
底面鉛直ばね	K_v			

第 3.2.2-14 表 地盤ばね定数と減衰係数 (S d - B 3, 鉛直方向)

		質点 番号	ばね定数 (kN/m)	減衰係数 (kN・s/m)
底面鉛直ばね	K_v			

第 3.2.2-15 表 地盤ばね定数と減衰係数 (S d - B 4, 鉛直方向)

		質点 番号	ばね定数 (kN/m)	減衰係数 (kN・s/m)
底面鉛直ばね	K_v			

第 3.2.2-16 表 地盤ばね定数と減衰係数 (S d - B 5, 鉛直方向)

		質点 番号	ばね定数 (kN/m)	減衰係数 (kN・s/m)
底面鉛直ばね	K_v			

第 3.2.2-17 表 地盤ばね定数と減衰係数 (S d - C 1, 鉛直方向)

		質点 番号	ばね定数 (kN/m)	減衰係数 (kN・s/m)
底面鉛直ばね	K_v			

第 3.2.2-18 表 地盤ばね定数と減衰係数 (S d - C 2, 鉛直方向)

		質点 番号	ばね定数 (kN/m)	減衰係数 (kN・s/m)
底面鉛直ばね	K_v			

第 3.2.2-19 表 地盤ばね定数と減衰係数 (S d - C 3, 鉛直方向)

		質点 番号	ばね定数 (kN/m)	減衰係数 (kN・s/m)
底面鉛直ばね	K_v			

3.3 建物・構築物の入力地震動

3.3.1 水平方向

水平方向モデルへの入力地震動は、1次元波動論に基づき、解放基盤表面レベルで定義される基準地震動 S_s 及び弾性設計用地震動 S_d に対する構築物基礎底面レベルでの地盤の応答として評価する。第3.3.1-1図に地震応答解析モデルに入力する地震動の概念図を示す。入力地震動の算定には、解析コード「REFLECT Ver. 2.0」を用いる。

ひずみ依存特性を考慮して求めた等価物性値を用いて、1次元波動論により算定した基礎底面位置 (T.M.S.L. 53.80m) における地盤応答の加速度応答スペクトルを第3.3.1-2図～第3.3.1-5図に示す。また、地盤応答の各深さの最大加速度分布を第3.3.1-6図及び第3.3.1-7図に示す。

なお、解析コードの検証及び妥当性確認等の概要については、「IV-3 計算機プログラム（解析コード）の概要」に示す。

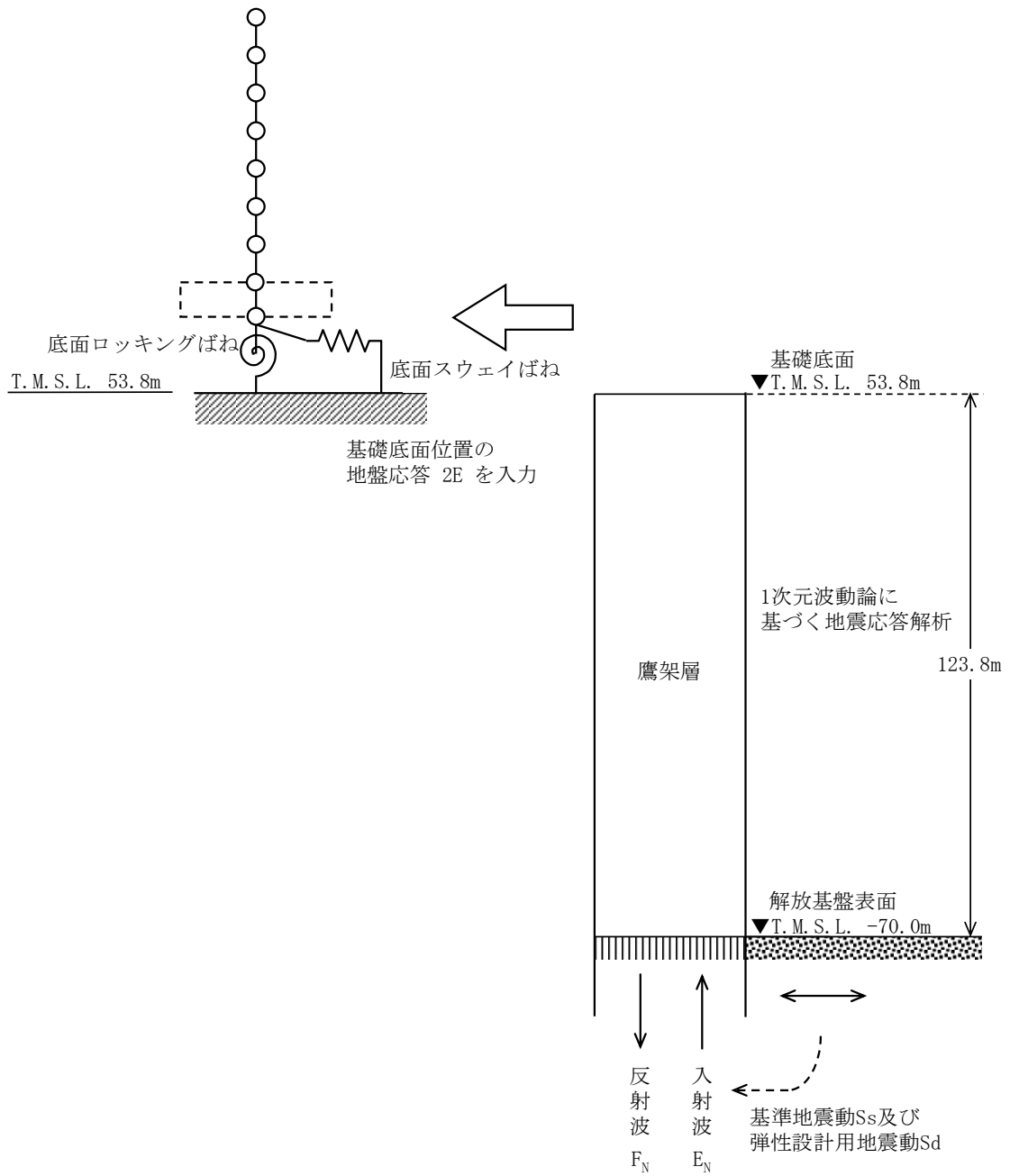

第 3.3.1-1 図 地震応答解析モデルに入力する地震動の概念図（水平方向）

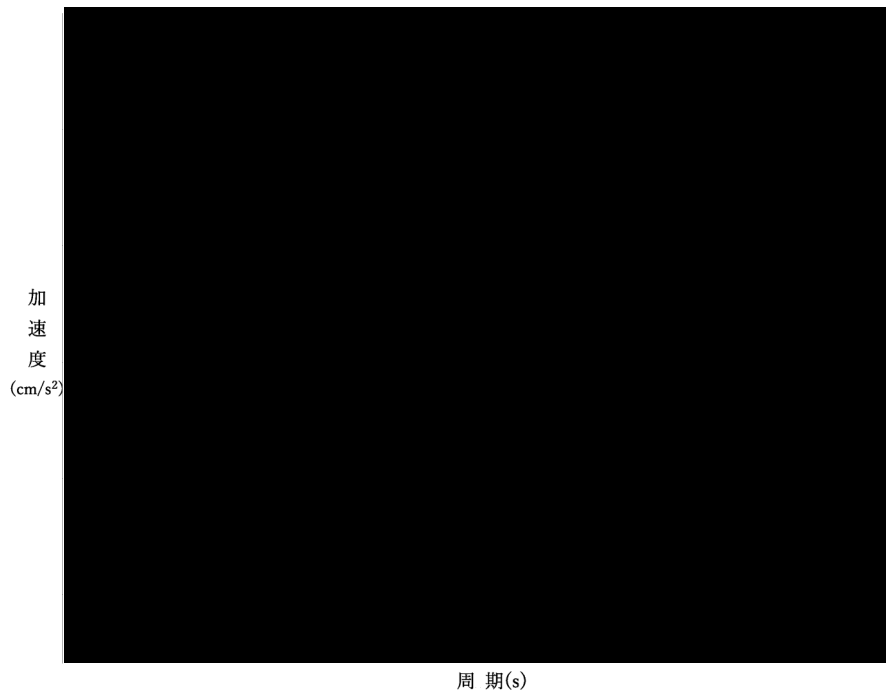

凡例

- : S_s - A (H)
- : S_s - B 1 (NS)
- : S_s - B 2 (NS)
- : S_s - B 3 (NS)
- : S_s - B 4 (NS)
- : S_s - B 5 (NS)
- : S_s - C 1 (NSEW)
- : S_s - C 2 (NS)
- - - : S_s - C 2 (EW)
- : S_s - C 3 (NS)
- - - : S_s - C 3 (EW)
- : S_s - C 4 (NS)
- - - : S_s - C 4 (EW)

第 3. 3. 1-2 図 入力地震動の加速度応答スペクトル
(S_s, NS 方向, T. M. S. L. 53. 80m)

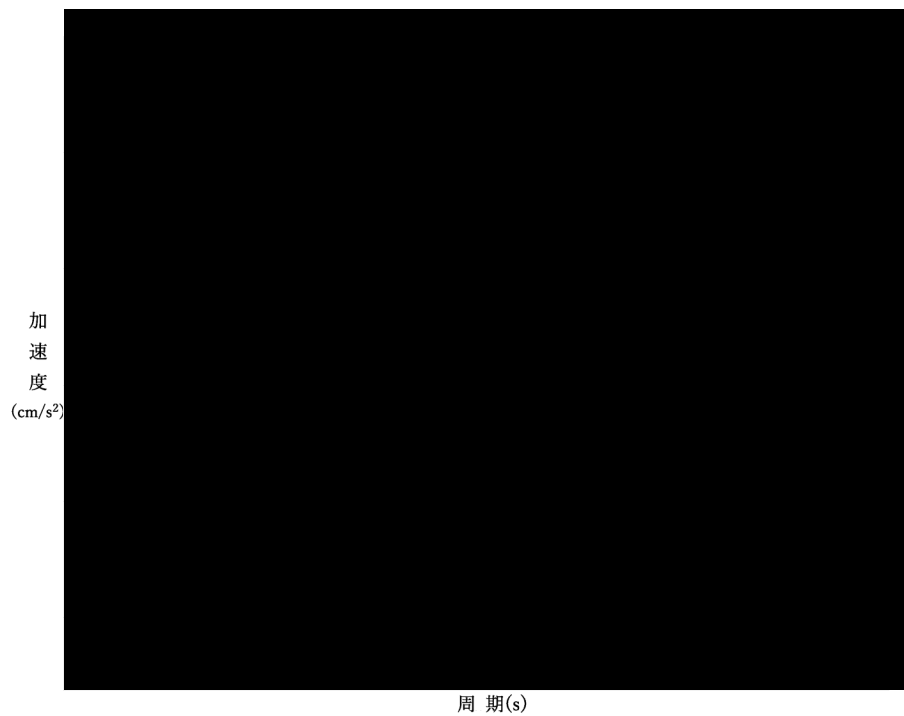

凡例

- : $S_s - A$ (H)
- : $S_s - B 1$ (EW)
- : $S_s - B 2$ (EW)
- : $S_s - B 3$ (EW)
- : $S_s - B 4$ (EW)
- : $S_s - B 5$ (EW)
- : $S_s - C 1$ (NSEW)
- : $S_s - C 2$ (NS)
- - - : $S_s - C 2$ (EW)
- : $S_s - C 3$ (NS)
- - - : $S_s - C 3$ (EW)
- : $S_s - C 4$ (NS)
- - - : $S_s - C 4$ (EW)

第 3. 3. 1-3 図 入力地震動の加速度応答スペクトル
(S_s , EW 方向, T. M. S. L. 53. 80m)

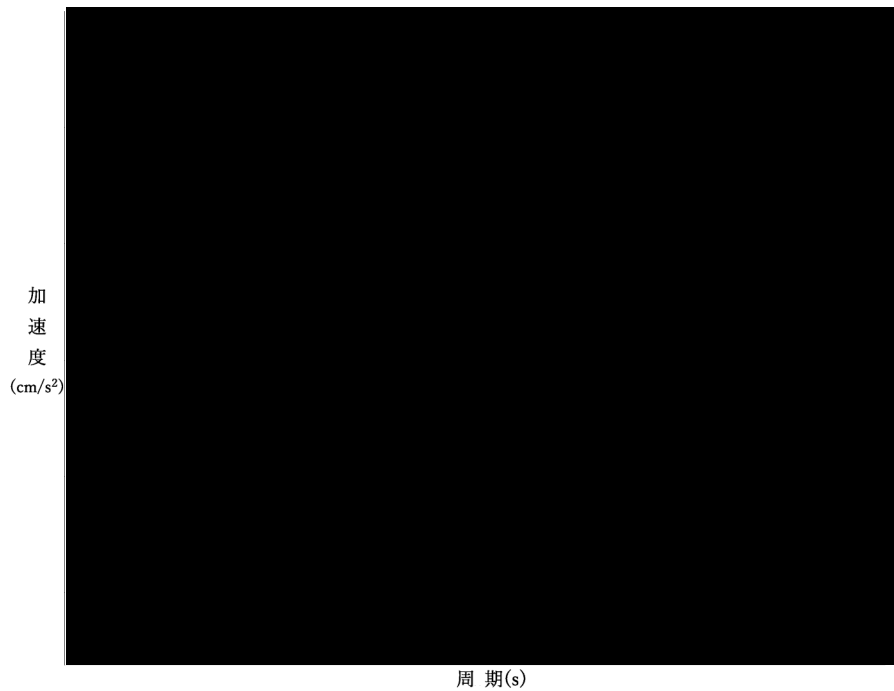

凡例

- : S d - A (H)
- : S d - B 1 (NS)
- : S d - B 2 (NS)
- : S d - B 3 (NS)
- : S d - B 4 (NS)
- : S d - B 5 (NS)
- : S d - C 1 (NSEW)
- : S d - C 2 (NS)
- - - : S d - C 2 (EW)
- : S d - C 3 (NS)
- - - : S d - C 3 (EW)
- : S d - C 4 (NS)
- - - : S d - C 4 (EW)

第 3. 3. 1-4 図 入力地震動の加速度応答スペクトル
(S d, NS 方向, T. M. S. L. 53. 80m)

加
速
度
(cm/s^2)



周 期(s)

凡例

- : S d - A (H)
- : S d - B 1 (E W)
- : S d - B 2 (E W)
- : S d - B 3 (E W)
- : S d - B 4 (E W)
- : S d - B 4 (E W)
- : S d - C 1 (N S E W)
- : S d - C 2 (N S)
- - - : S d - C 2 (E W)
- : S d - C 3 (N S)
- - - : S d - C 3 (E W)
- : S d - C 4 (N S)
- - - : S d - C 4 (E W)

第 3. 3. 1-5 図 入力地震動の加速度応答スペクトル
(S d, EW 方向, T. M. S. L. 53. 80m)

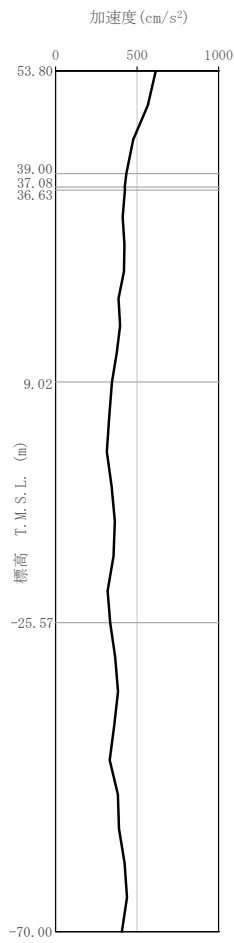

(a) S s - A
(H)

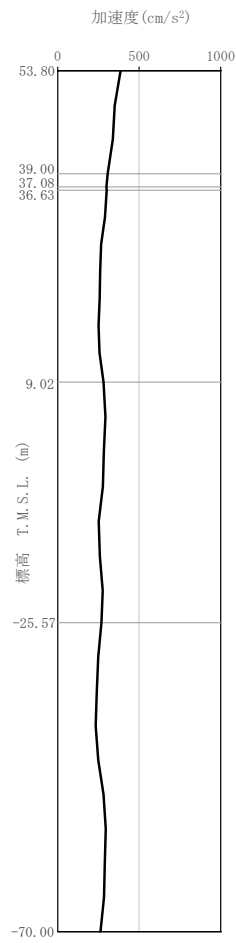

(b) S s - B 1
(NS)

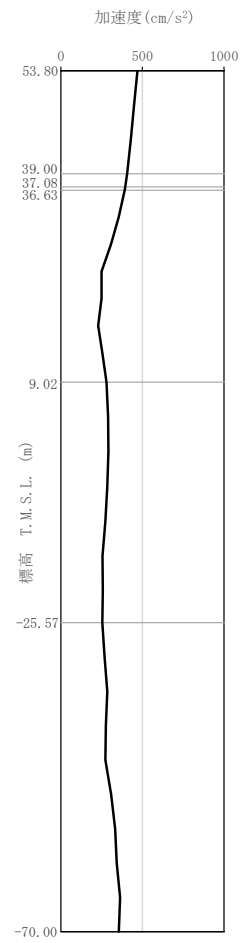

(c) S s - B 1
(EW)

第 3.3.1-6 図 最大加速度分布 (S s) (1/5)

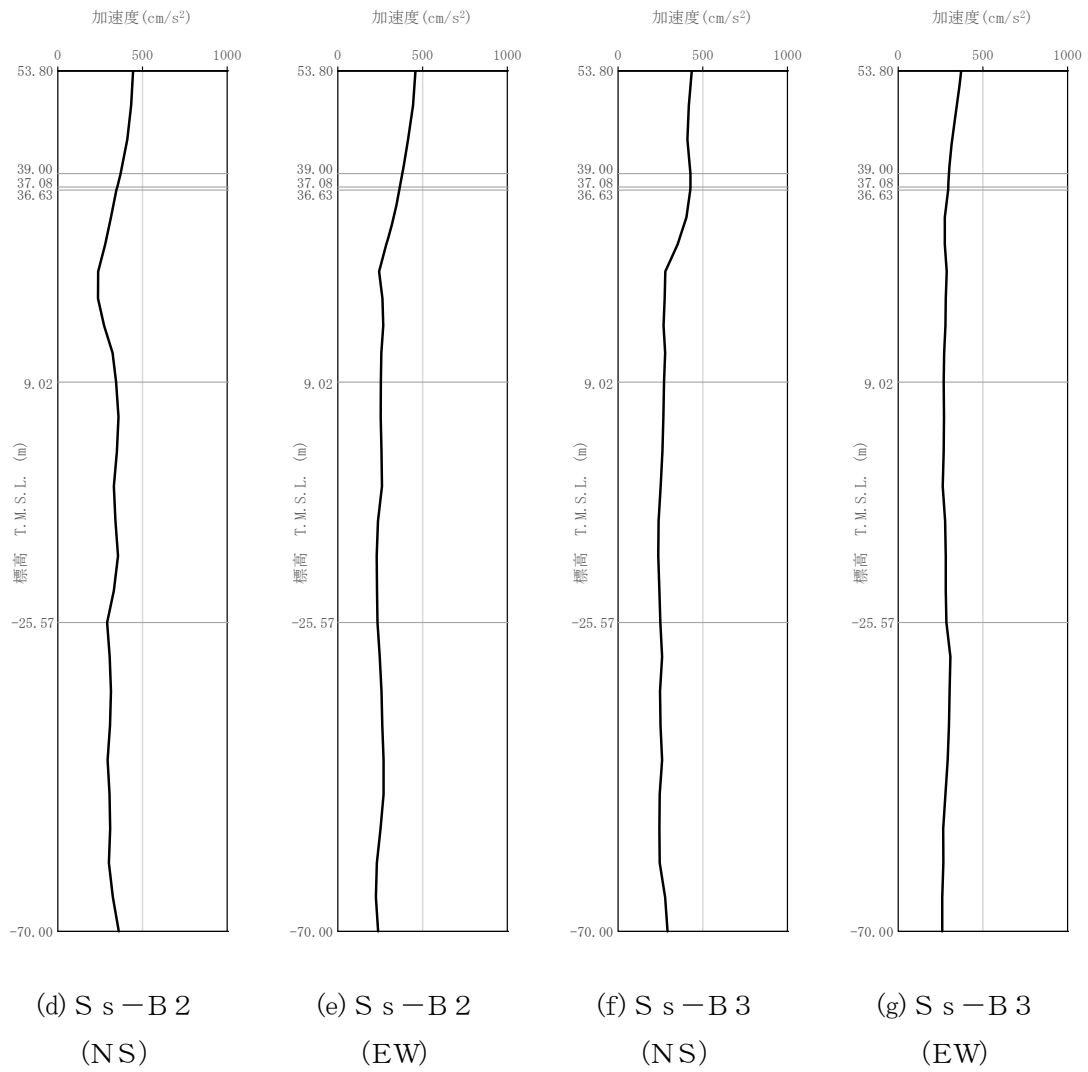

第 3.3.1-6 図 最大加速度分布 (S_s) (2/5)

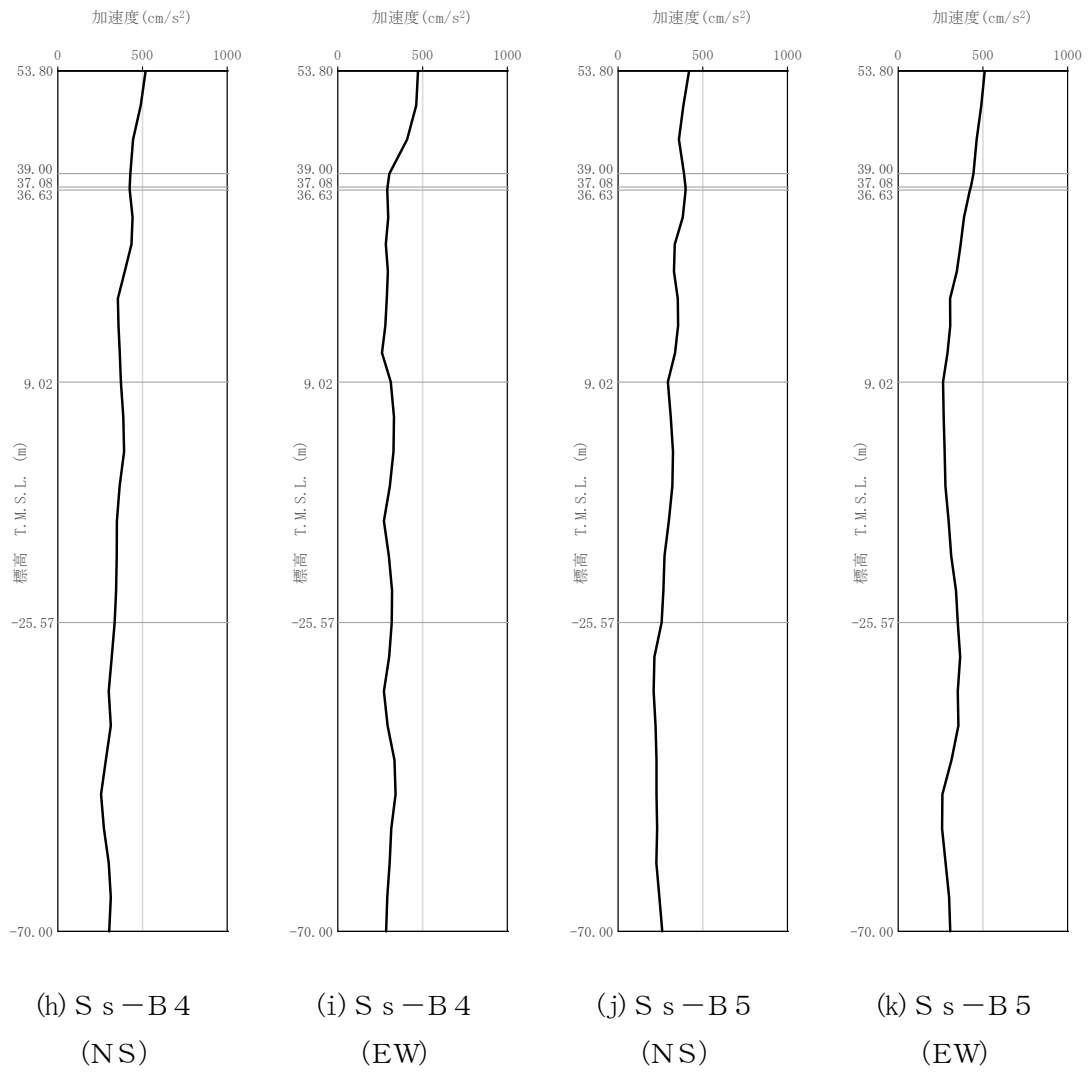

第 3.3.1-6 図 最大加速度分布 (S_s) (3/5)

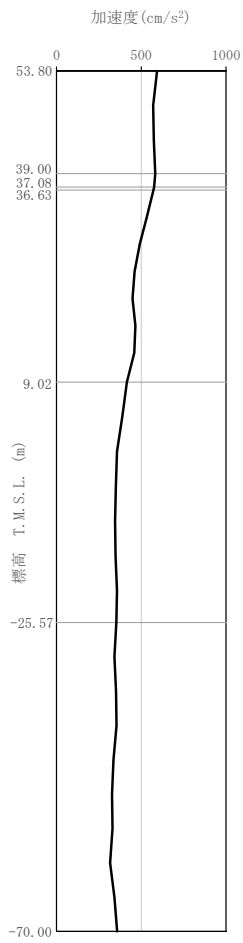

(l) S s - C 1
(NSEW)

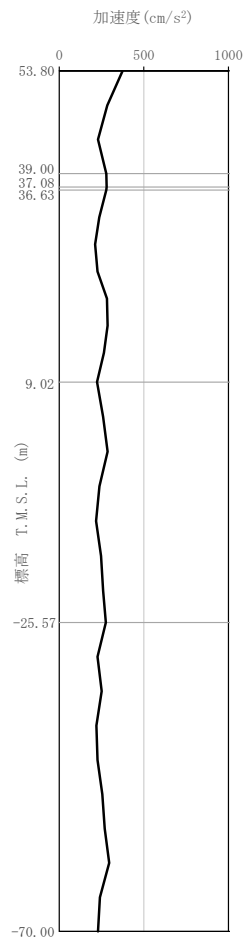

(m) S s - C 2
(NS)

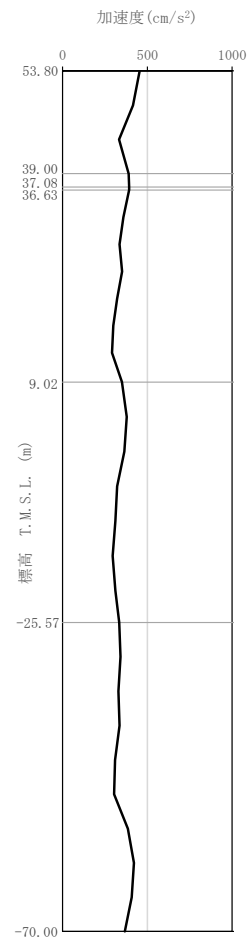

(n) S s - C 2
(EW)

第 3.3.1-6 図 最大加速度分布 (S s) (4/5)

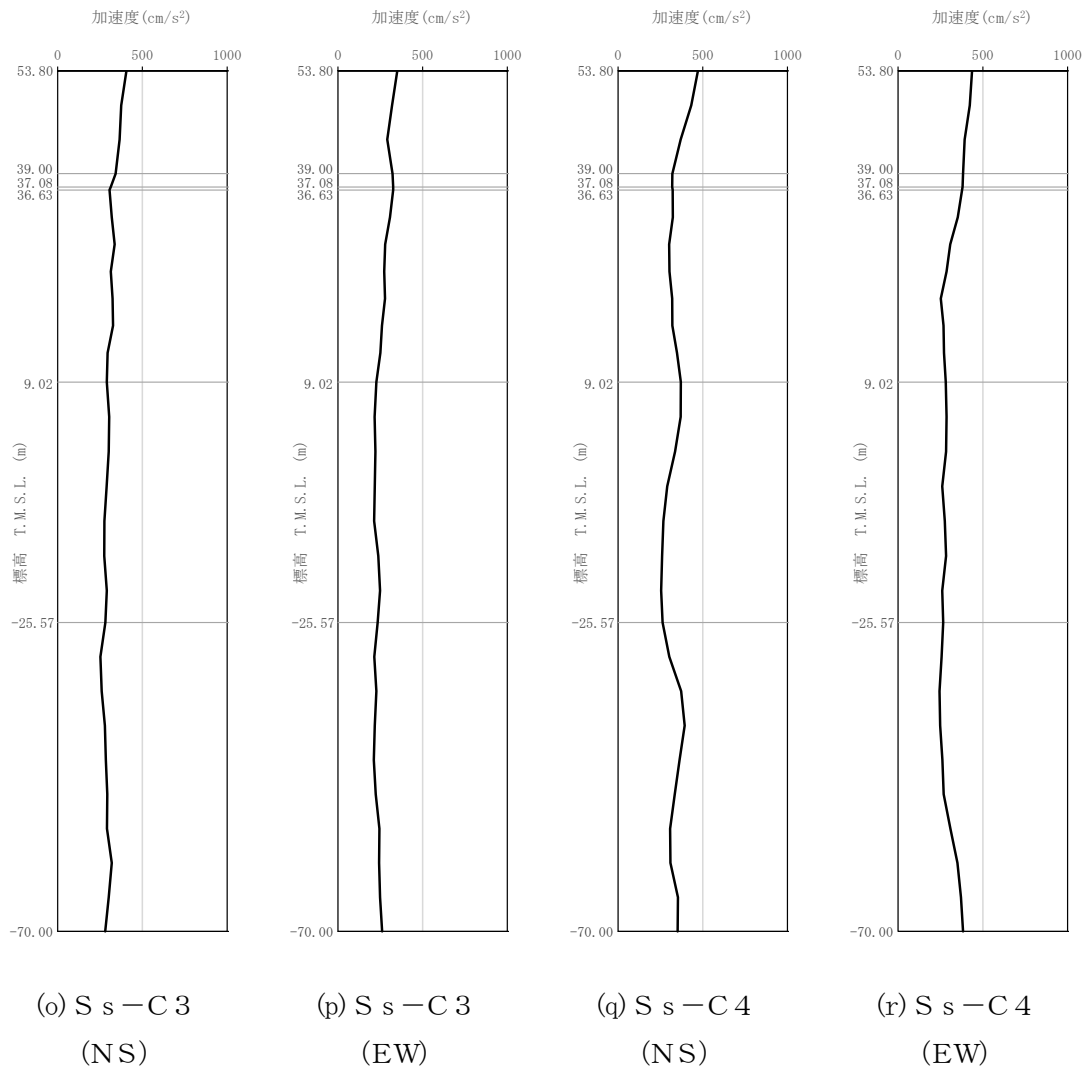

第 3.3.1-6 図 最大加速度分布 (S_s) (5/5)

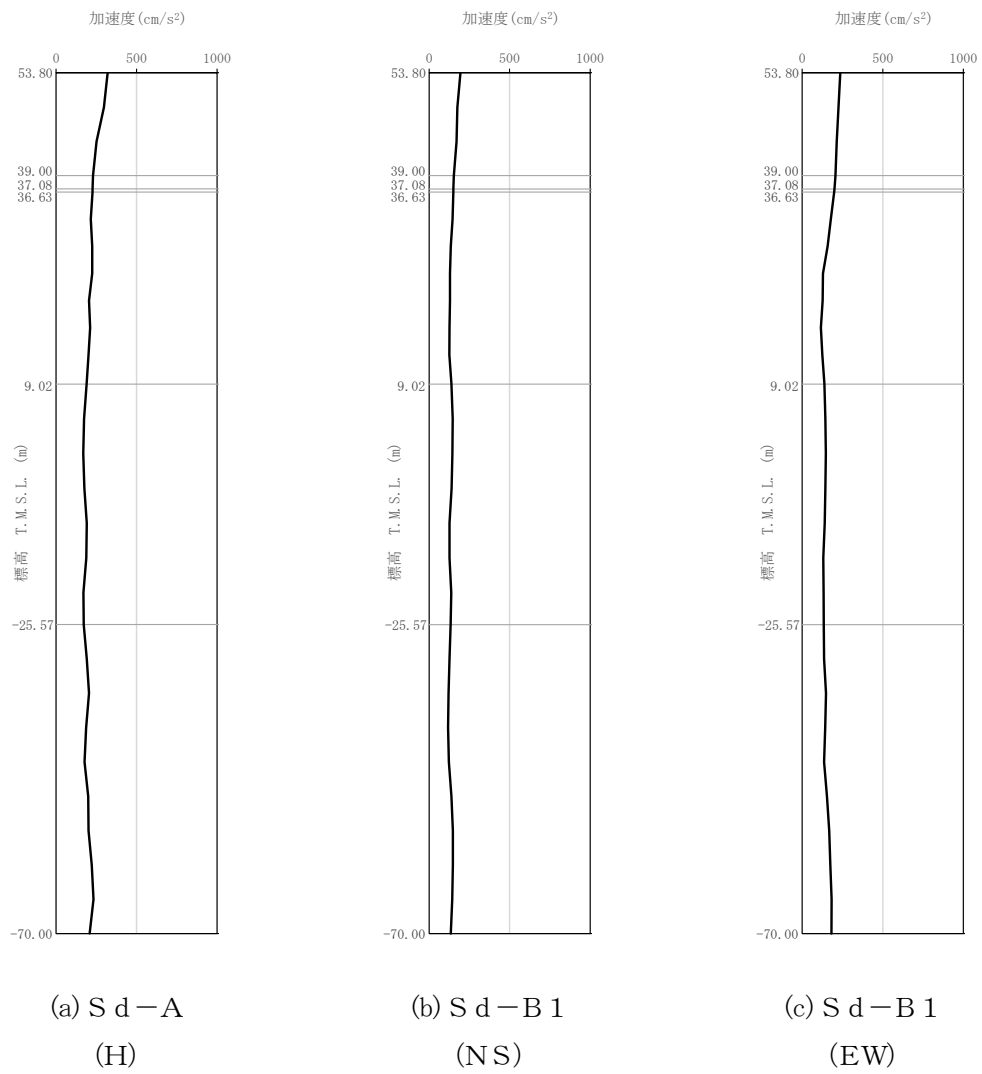

第 3.3.1-7 図 最大加速度分布 (S d) (1/5)

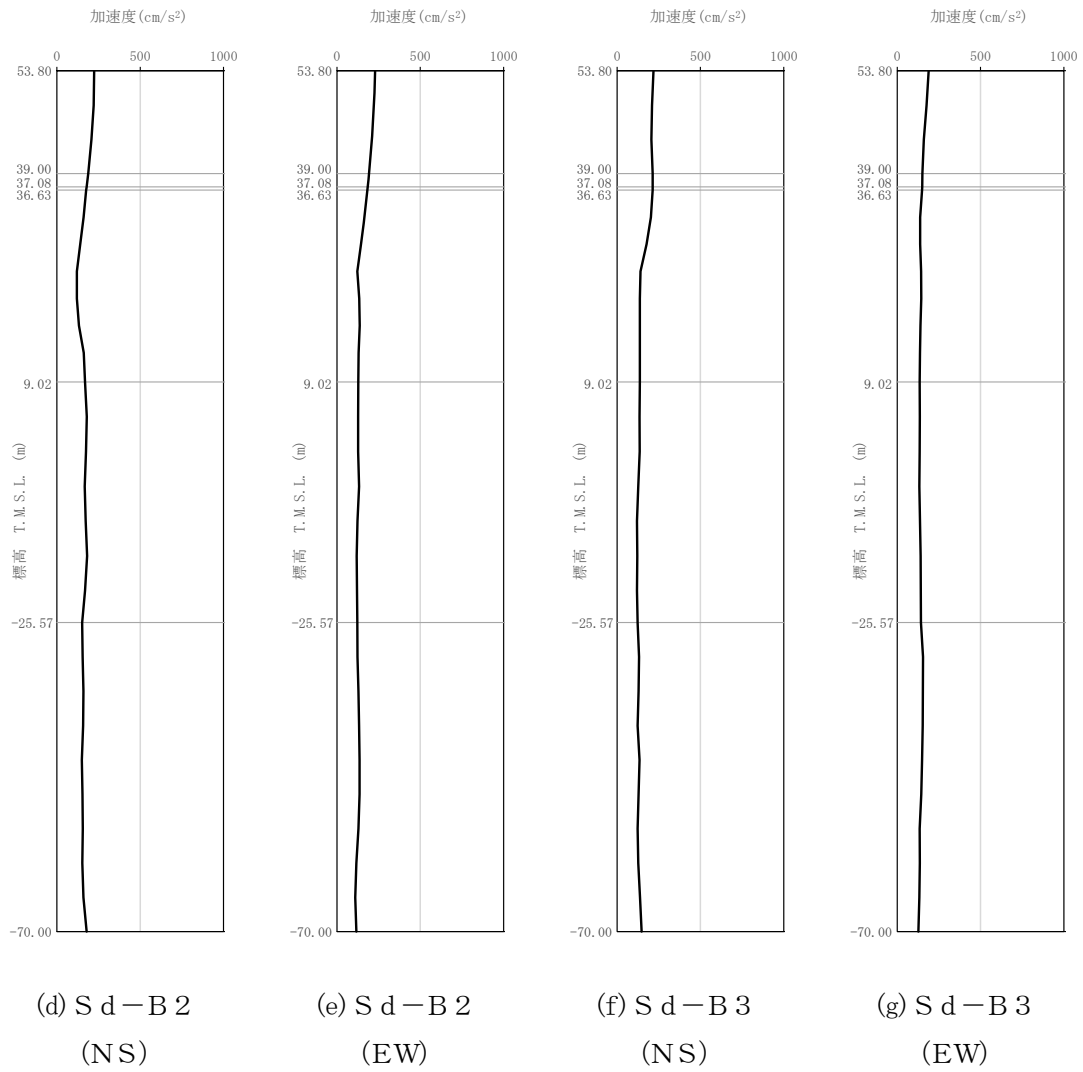

第 3.3.1-7 図 最大加速度分布 (S d) (2/5)

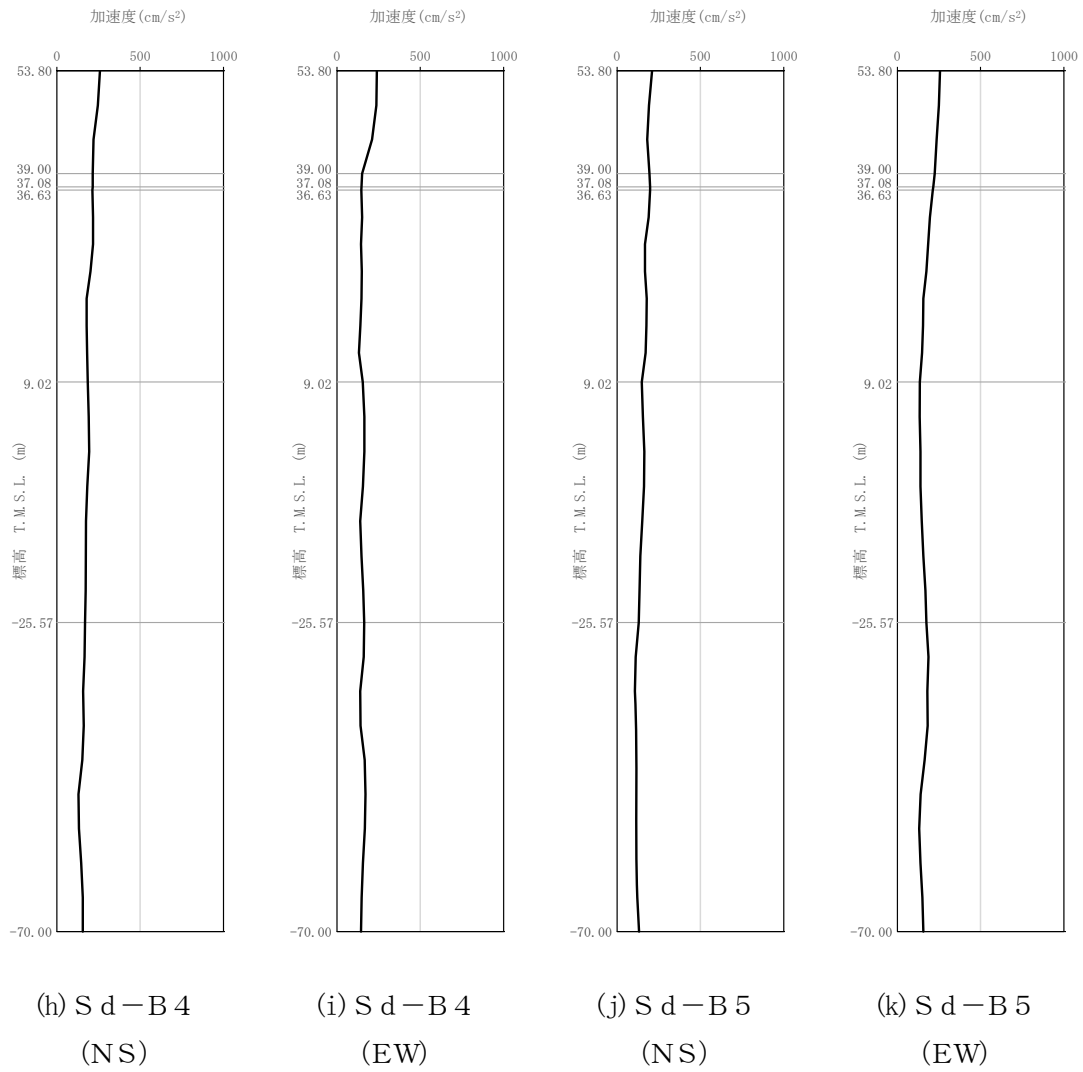

第 3.3.1-7 図 最大加速度分布 (Sd) (3/5)

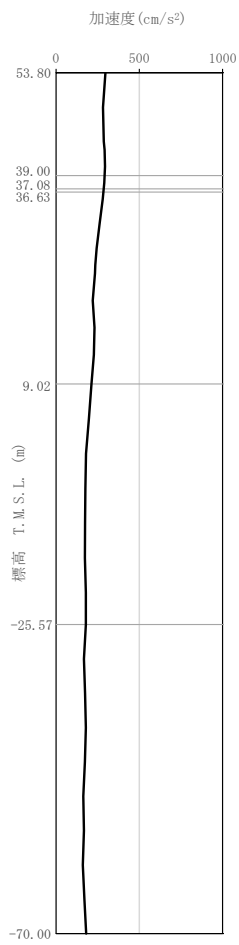

(l) S d - C 1
(NSEW)

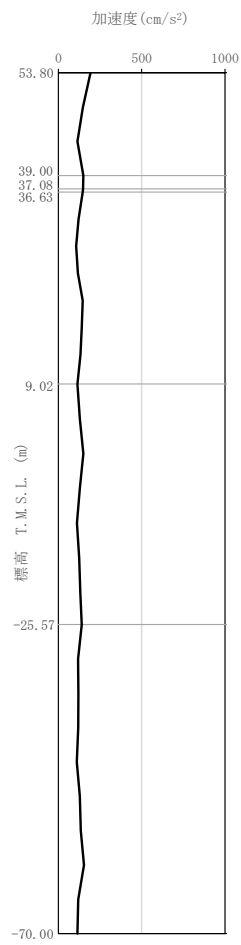

(m) S d - C 2
(NS)

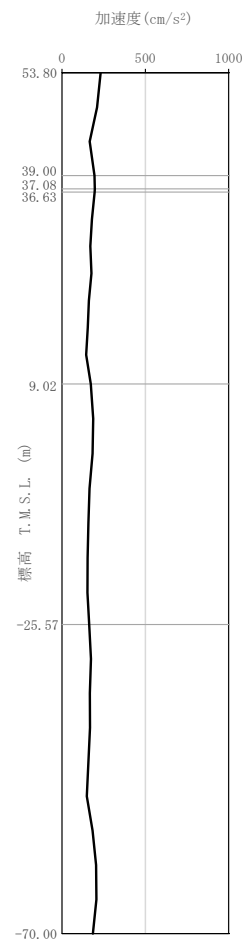

(n) S d - C 2
(EW)

第 3.3.1-7 図 最大加速度分布 (S d) (4/5)

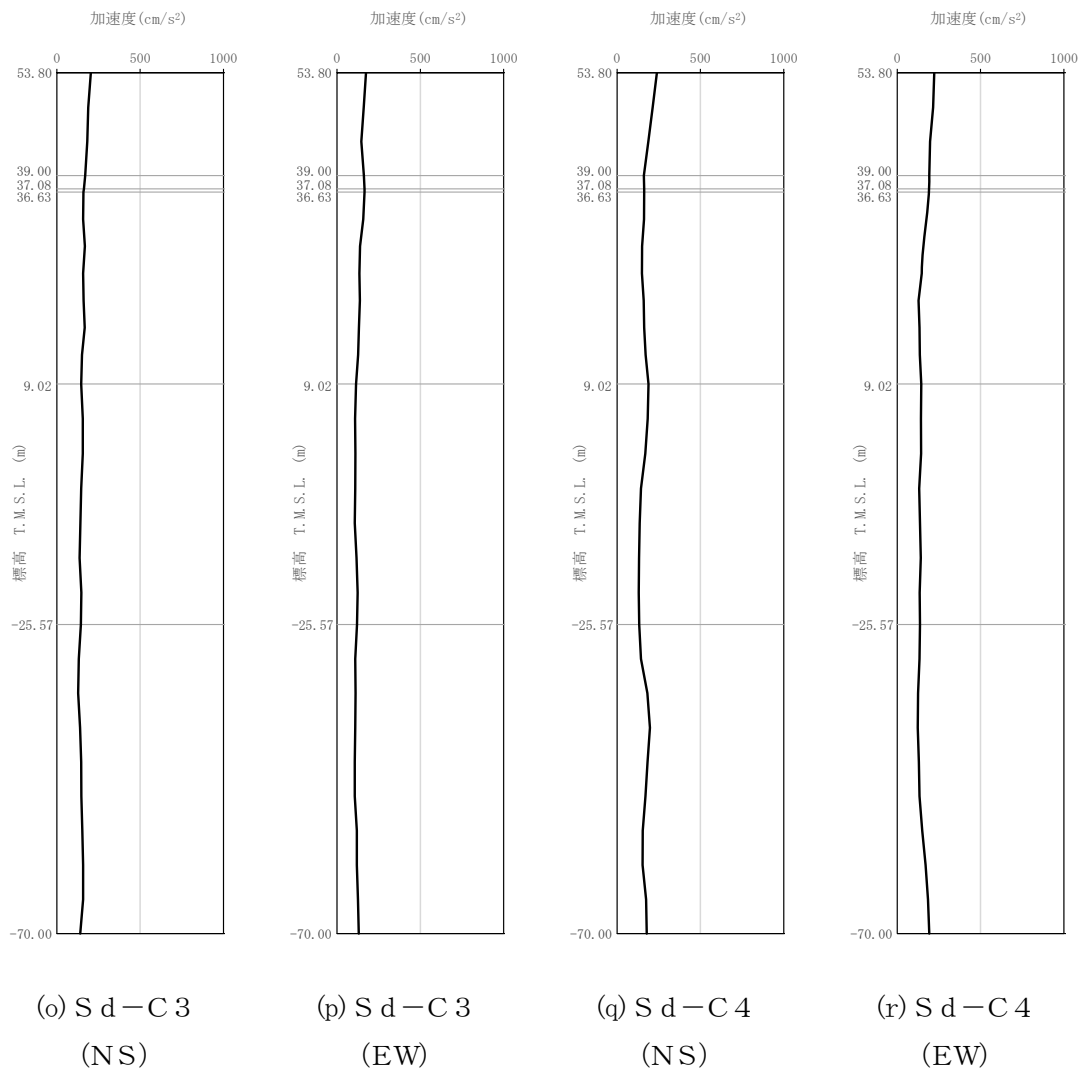

第 3.3.1-7 図 最大加速度分布 (Sd) (5/5)

3.3.2 鉛直方向

鉛直方向モデルへの入力地震動は、1次元波動論に基づき、解放基盤表面レベルで定義される基準地震動 S_s 及び弾性設計用地震動 S_d に対する構築物基礎底面レベルでの地盤の応答として評価する。第3.3.2-1図に地震応答解析モデルに入力する地震動の概念図を示す。入力地震動の算定には、解析コード「REFLECT Ver. 2.0」を用いる。

ひずみ依存特性を考慮して求めた等価物性値を用いて、1次元波動論により算定した基礎底面位置（T.M.S.L. 53.80m）における地盤応答の加速度応答スペクトルを第3.3.2-2図及び第3.3.2-3図に示す。また、地盤応答の各深さの最大加速度分布を第3.3.2-4図及び第3.3.2-5図に示す。

なお、解析コードの検証及び妥当性確認等の概要については、「IV-3 計算機プログラム（解析コード）の概要」に示す。

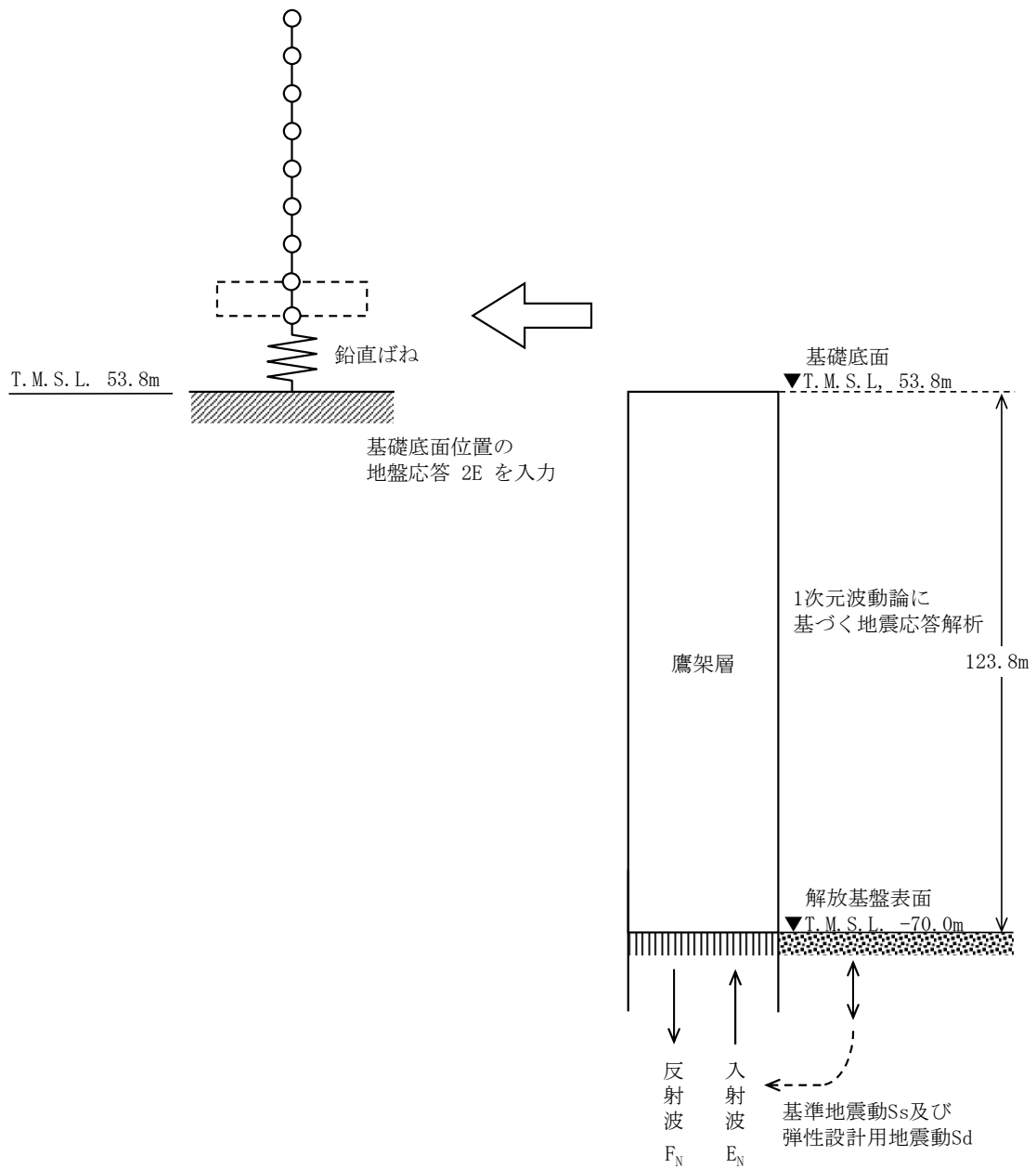

第 3.3.2-1 図 地震応答解析モデルに入力する地震動の概念図（鉛直方向）

加
速
度
(cm/s^2)

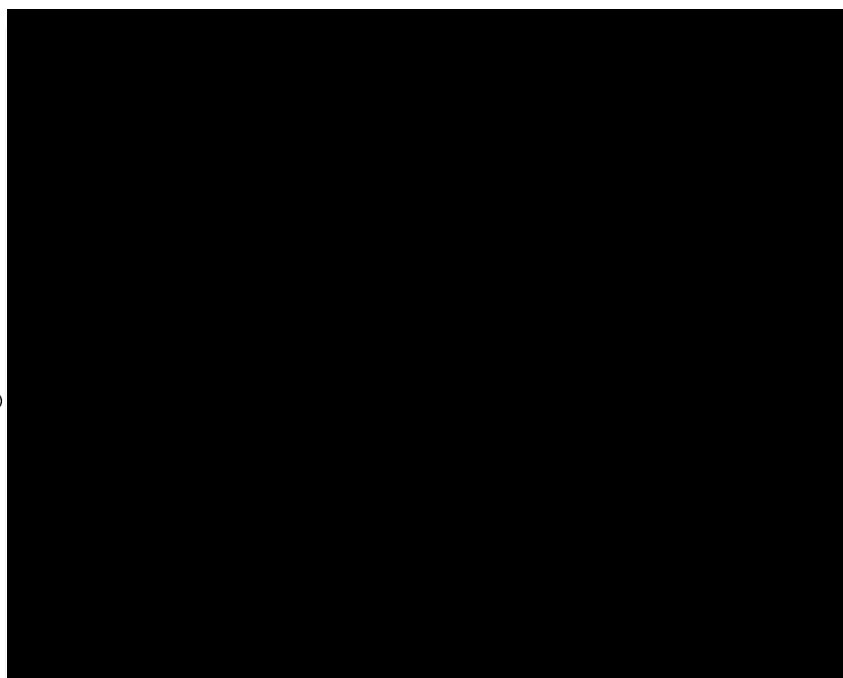

周 期(s)

凡例

- : $S_s - A$ (V)
- : $S_s - B 1$ (UD)
- : $S_s - B 2$ (UD)
- : $S_s - B 3$ (UD)
- : $S_s - B 4$ (UD)
- : $S_s - B 5$ (UD)
- : $S_s - C 1$ (UD)
- : $S_s - C 2$ (UD)
- : $S_s - C 3$ (UD)

第 3.3.2-2 図 入力地震動の加速度応答スペクトル
(S_s , 鉛直方向, T.M.S.L. 53.80m)

加
速
度
(cm/s²)



周 期(s)

凡例

- : S d - A (V)
- : S d - B 1 (UD)
- : S d - B 2 (UD)
- : S d - B 3 (UD)
- : S d - B 4 (UD)
- : S d - B 5 (UD)
- : S d - C 1 (UD)
- : S d - C 2 (UD)
- : S d - C 3 (UD)

第 3.3.2-3 図 入力地震動の加速度応答スペクトル
(S d, 鉛直方向, T. M. S. L. 53.80m)

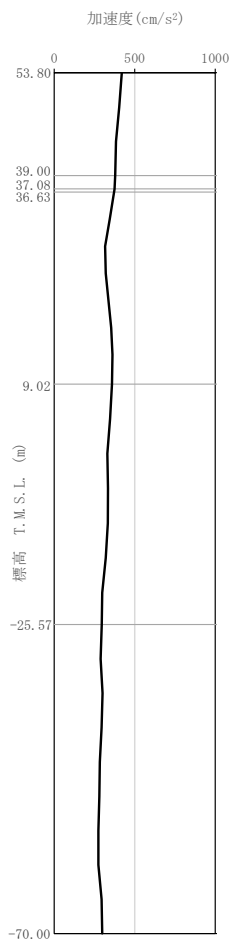

(a) S s - A (V)

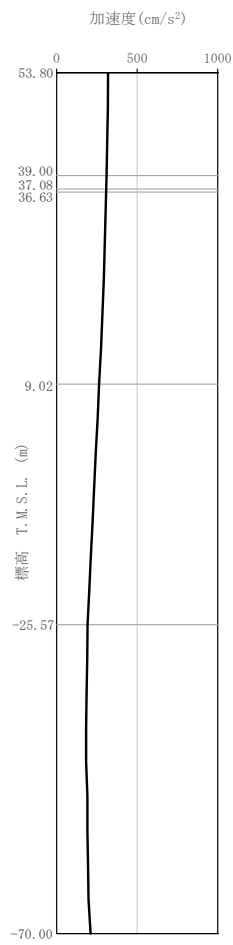

(b) S s - B 1 (UD)

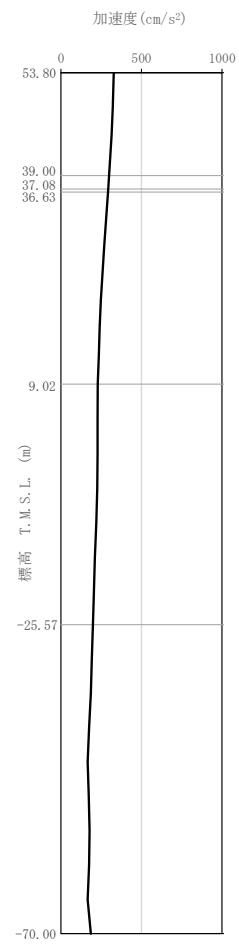

(c) S s - B 2 (UD)

第 3.3.2-4 図 最大加速度分布 (S s) (1/3)

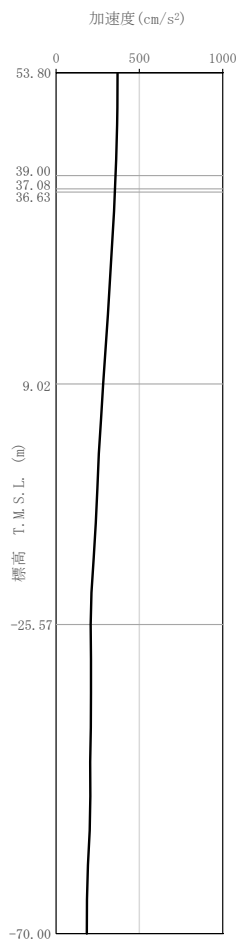

(d) S_s-B3 (UD)

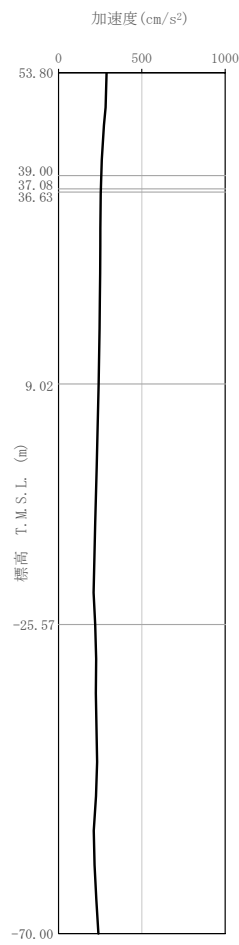

(e) S_s-B4 (UD)

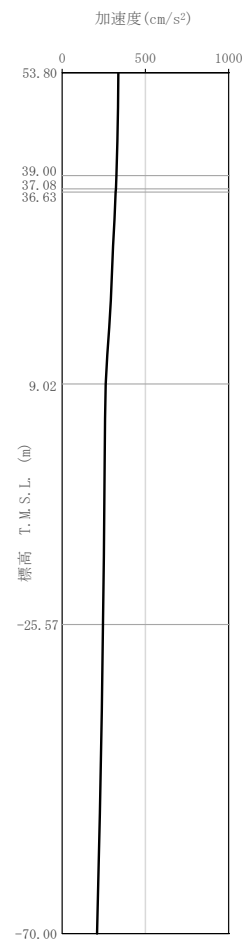

(f) S_s-B5 (UD)

第 3.3.2-4 図 最大加速度分布 (S_s) (2/3)

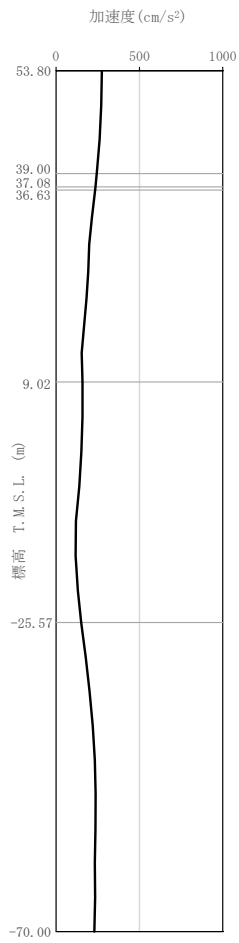

(g) S_s-C1 (UD)

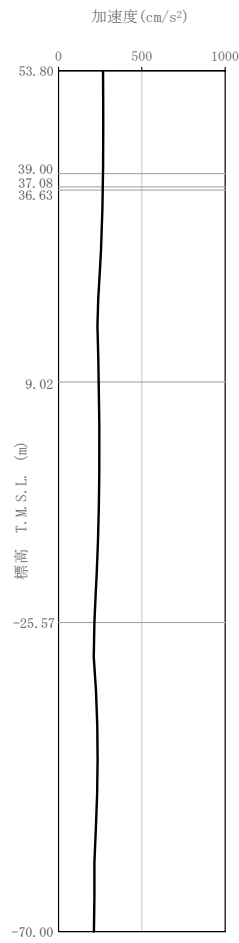

(h) S_s-C2 (UD)

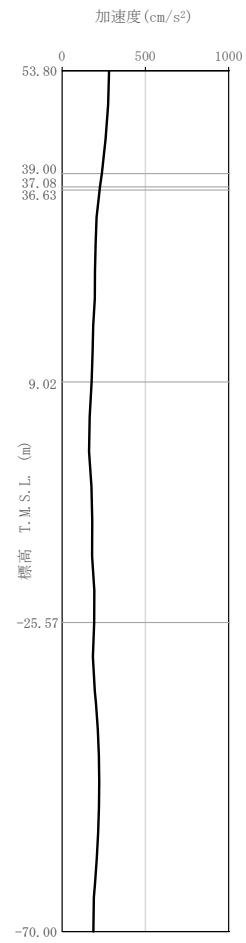

(i) S_s-C3 (UD)

第 3.3.2-4 図 最大加速度分布 (S_s) (3/3)

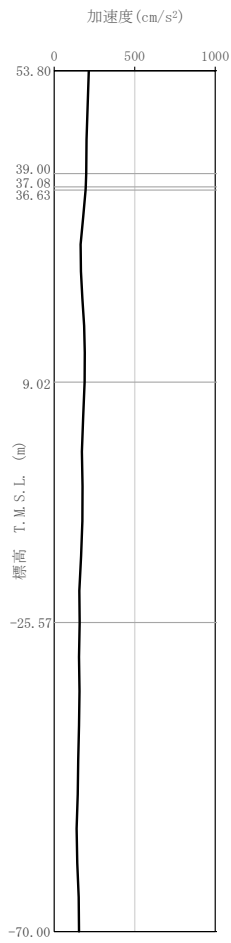

(a) S d - A (V)

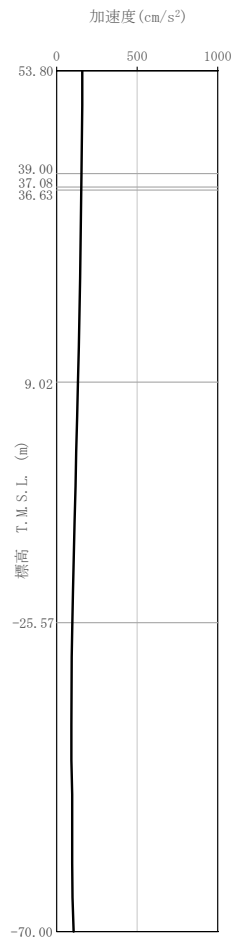

(b) S d - B 1 (UD)

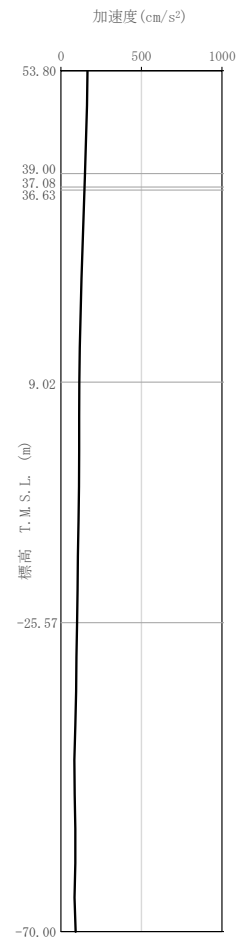

(c) S d - B 2 (UD)

第 3.3.2-5 图 最大加速度分布 (S d) (1/3)

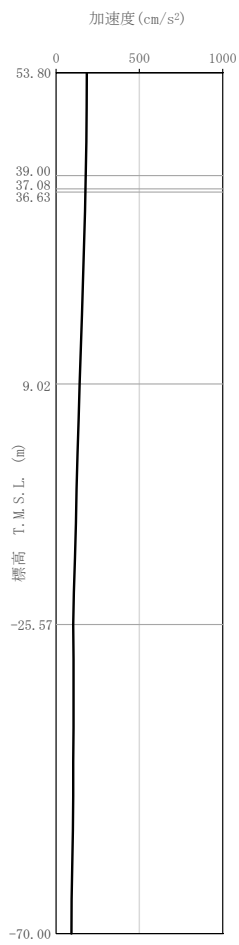

(d) S d-B 3 (UD)

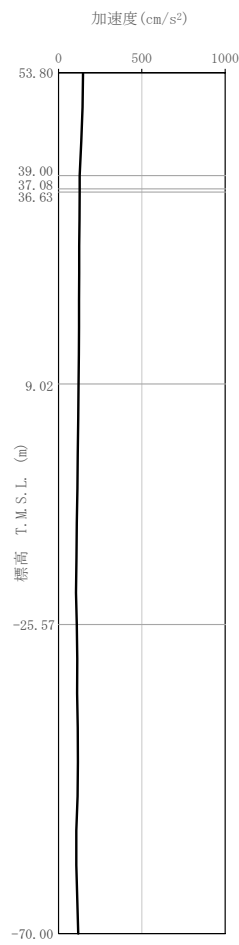

(e) S d-B 4 (UD)

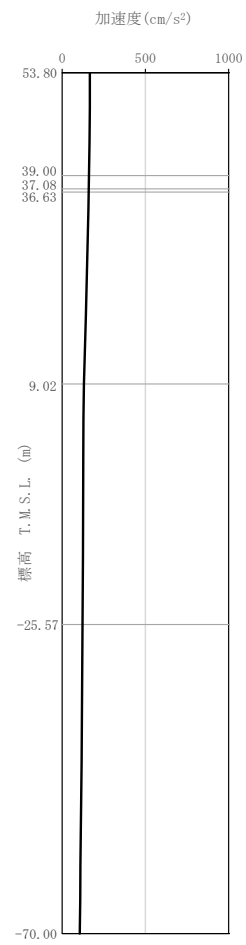

(f) S d-B 5 (UD)

第 3.3.2-5 図 最大加速度分布 (S d) (2/3)

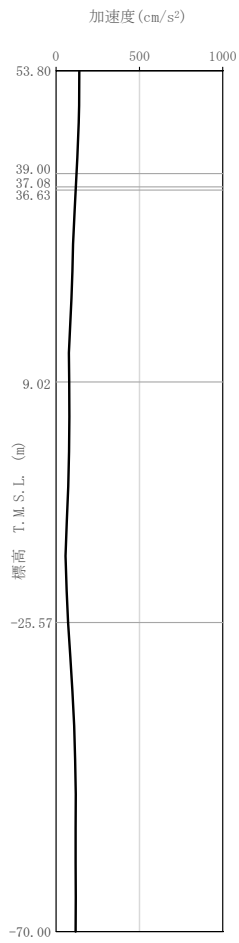

(g) S d - C 1 (UD)

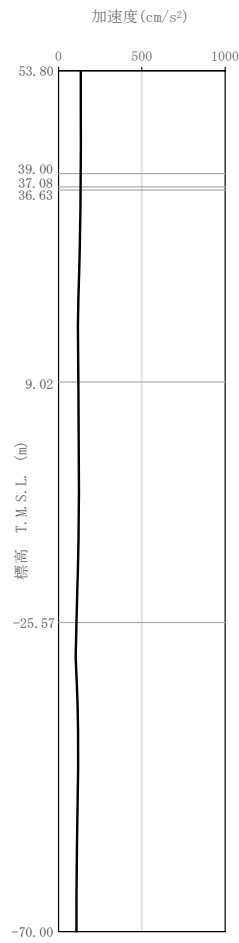

(h) S d - C 2 (UD)

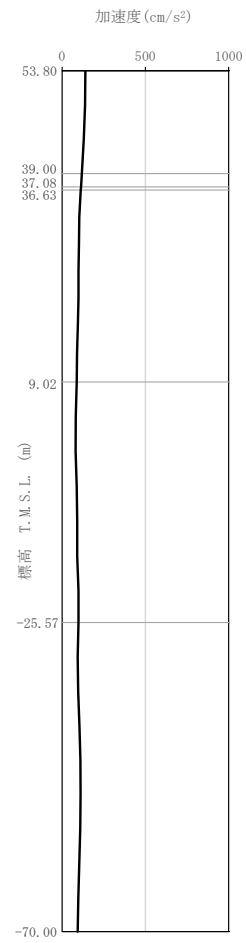

(i) S d - C 3 (UD)

第 3.3.2-5 图 最大加速度分布 (S d) (3/3)

3.4 解析方法

安全冷却水B冷却塔基礎の地震応答解析は、解析コード「TDAPⅢ Ver. 3.07」を用いる。

なお、解析コードの検証及び妥当性確認等の概要については、「Ⅳ－3 計算機プログラム（解析コード）の概要」に示す。

3.4.1 動的解析

建物・構築物の動的解析は、「Ⅳ－1－1－5 地震応答解析の基本方針」に記載の解析方法に基づき、時刻歴応答解析により実施する。

なお、最大接地圧は、「原子力発電所耐震設計技術規程 JEAC4601－2008（（社）日本電気協会）」を参考に、水平応答と鉛直応答から組合せ係数法（組合せ係数は1.0と0.4）を用いて算出する。

3.5 解析条件

3.5.1 地盤のロックンバねの復元力特性

地盤のロックンバねに関する曲げモーメントー回転角の関係は、「JEAG 4601-1991 追補版」に基づき、浮上りによる幾何学的非線形性を考慮する。ロックンバねの曲げモーメントー回転角の関係を第3.5.1-1図に示す。

浮上り時の地盤のロックンバねの剛性は、第3.5.1-1図の曲線で表され、減衰係数は、ロックンバねの接線剛性に比例するものとして考慮する。

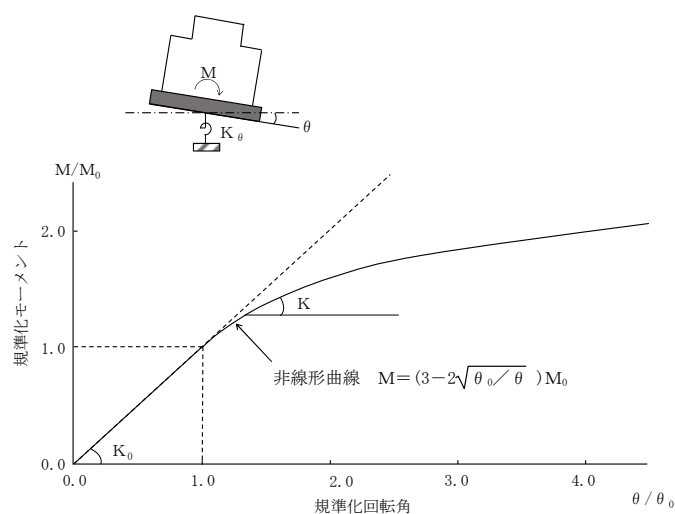

- M : 転倒モーメント
- M_0 : 浮上り限界転倒モーメント
- θ : 回転角
- θ_0 : 浮上り限界回転角
- K_0 : 底面ロックンバねのばね定数 (浮上り前)
- K : 底面ロックンバねのばね定数 (浮上り後)

第3.5.1-1図 ロックンバねの曲げモーメントー回転角の関係

3.6 材料物性のばらつき

解析においては、「3.2 地震応答解析モデル」に示す物性値及び定数を基本ケースとし、材料物性のばらつきを考慮する。材料物性のばらつきを考慮した地震応答解析は、構築物応答への影響の大きい地震動に対して実施することとし、基本ケースの地震応答解析において応答値（加速度，変位，せん断力，曲げモーメント及び軸力）が、各層において最大となっている地震動に対して実施する。

材料物性のばらつきのうち、地盤物性のばらつきについては、支持地盤及び埋戻し土ともに敷地内のボーリング調査結果等に基づき、第 3.2.1-3 表に示す地盤の物性値を基本とし、標準偏差 $\pm 1\sigma$ の変動幅を考慮する。第 3.6-1 表及び第 3.6-2 表に設定した地盤の初期物性値を示す [REDACTED]

[REDACTED]

[REDACTED]

材料物性のばらつきを考慮する解析ケースを、第 3.6-3 表に示す。

第 3.6-1 表 地盤の物性値

(地盤物性のばらつきを考慮したケース (+1σ))

標高 T. M. S. L. (m)	岩種	単位体積重量 γ_t (kN/m ³)	S波速度 V_s (m/s)	P波速度 V_p (m/s)	剛性低下率 $G/G_0-\gamma$	減衰定数 $h-\gamma$
▽基礎スラブ底面 53.80						
▽MMR下端レベル 39.00	MMR	*1	*1	*1	*1	
37.08	細粒砂岩	18.3	760	2060	*2	
36.63	粗粒砂岩				*3	
9.02	細粒砂岩	18.1	1010	2100	*2	
-25.57	泥岩 (下部層)	16.9	850	1940	*4	
▽解放基盤表面 -70.00	泥岩 (下部層)	16.9	850	1940	—	

注記 *1: 支持地盤相当の岩盤に支持されているとみなし, MMR 直下の支持地盤の物性値を設定する。

*2: 第 3.2.1-3 図示す細粒砂岩のひずみ依存特性を設定する。

*3: 第 3.2.1-4 図に示す粗粒砂岩のひずみ依存特性を設定する。

*4: 第 3.2.1-5 図に示す泥岩 (下部層) のひずみ依存特性を設定する。

第 3.6-2 表 地盤の物性値

(地盤物性のばらつきを考慮したケース (-1σ))

標高 T. M. S. L. (m)	岩種	単位体積重量 γ_t (kN/m ³)	S波速度 V_s (m/s)	P波速度 V_p (m/s)	剛性低下率 $G/G_0-\gamma$	減衰定数 $h-\gamma$
▽基礎スラブ底面 53.80						
▽MMR下端レベル 39.00	MMR	*1	*1	*1	*1	
37.08	細粒砂岩	18.3	600	1760	*2	
36.63	粗粒砂岩				*3	
9.02	細粒砂岩	18.1	870	1980	*2	
-25.57	泥岩 (下部層)	16.9	730	1820	*4	
▽解放基盤表面 -70.00	泥岩 (下部層)	16.9	730	1820	-	

注記 *1: 支持地盤相当の岩盤に支持されているとみなし, MMR 直下の支持地盤の物性値を設定する。

*2: 第 3.2.1-3 図示す細粒砂岩のひずみ依存特性を設定する。

*3: 第 3.2.1-4 図に示す粗粒砂岩のひずみ依存特性を設定する。

*4: 第 3.2.1-5 図に示す泥岩 (下部層) のひずみ依存特性を設定する。

第 3.6-3 表 材料物性のばらつきを考慮する解析ケース

ケース No.	地盤の物性値	解析ケース	基準地震動 S s	弾性設計用地震動 S d
0	第3.2.1-3表	基本ケース	全波	全波
1	第3.6-1表	地盤物性の ばらつきを考慮した ケース (+1 σ)	S s - A S s - B 3 S s - B 4 S s - C 1 S s - C 3 S s - C 4	S d - A S d - C 1 S d - C 3 S d - C 4
2	第3.6-2表	地盤物性の ばらつきを考慮した ケース (-1 σ)	S s - A S s - B 3 S s - B 4 S s - C 1 S s - C 3 S s - C 4	S d - A S d - C 1 S d - C 3 S d - C 4

4. 解析結果

4.1 動的解析

地震応答解析に採用した解析モデルの一覧を第 4.1-1 表～第 4.1-6 表に示す。

4.1.1 固有値解析結果

基本ケースの基礎浮上り非線形モデルによる固有値解析結果（固有周期，固有振動数及び刺激係数）を第 4.1.1-1 表～第 4.1.1-20 表に示す。刺激関数図を $S_s - A$ ， $S_d - A$ の結果を代表として，第 4.1.1-1 図～第 4.1.1-6 図に示す。

なお，刺激係数は，各次の固有ベクトル $\{u\}$ に対し，最大振幅が 1.0 となるように規準化した値を示す。

4.1.2 基本ケースの地震応答解析結果

(1) 基準地震動 S_s

基準地震動 S_s による最大応答値を第 4.1.2-1 図～第 4.1.2-11 図及び第 4.1.2-1 表～第 4.1.2-11 表に示す。

浮上り検討を第 4.1.2-12 表，最大接地圧を第 4.1.2-13 表に示す。

(2) 弾性設計用地震動 S_d

弾性設計用地震動 S_d による最大応答値を第 4.1.2-12 図～第 4.1.2-22 図及び第 4.1.2-14 表～第 4.1.2-24 表に示す。

浮上り検討を第 4.1.2-25 表，最大接地圧を第 4.1.2-26 表に示す。

第 4.1-1 表 地震応答解析に採用した解析モデル
(基準地震動 S_s , ケース No. 0)

(a) NS 方向

Ss-A (H)	Ss-B1 (NS)	Ss-B2 (NS)	Ss-B3 (NS)	Ss-B4 (NS)	Ss-B5 (NS)
-------------	---------------	---------------	---------------	---------------	---------------

Ss-C1 (NSEW)	Ss-C2 (NS)	Ss-C2 (EW)	Ss-C3 (NS)	Ss-C3 (EW)	Ss-C4 (NS)	Ss-C4 (EW)
-----------------	---------------	---------------	---------------	---------------	---------------	---------------

(b) EW 方向

Ss-A (H)	Ss-B1 (EW)	Ss-B2 (EW)	Ss-B3 (EW)	Ss-B4 (EW)	Ss-B5 (EW)
-------------	---------------	---------------	---------------	---------------	---------------

Ss-C1 (NSEW)	Ss-C2 (NS)	Ss-C2 (EW)	Ss-C3 (NS)	Ss-C3 (EW)	Ss-C4 (NS)	Ss-C4 (EW)
-----------------	---------------	---------------	---------------	---------------	---------------	---------------

凡例

- ① : 基礎浮上り非線形モデル
- ② : 誘発上下動を考慮するモデル
- ③ : 地盤 3 次元 FEM モデル

(c) 鉛直方向

Ss-A (V)	Ss-B1 (UD)	Ss-B2 (UD)	Ss-B3 (UD)	Ss-B4 (UD)	Ss-B5 (UD)
-------------	---------------	---------------	---------------	---------------	---------------

Ss-C1 (UD)	Ss-C2 (UD)	Ss-C3 (UD)
---------------	---------------	---------------

凡例

- ① : 鉛直ばねモデル
- ② : 地盤 3 次元 FEM モデル

第 4.1-2 表 地震応答解析に採用した解析モデル
(基準地震動 S_s, ケース No. 1)

(a) NS 方向

Ss-A (H)	Ss-B3 (NS)	Ss-B4 (NS)
-------------	---------------	---------------

Ss-C1 (NSEW)	Ss-C3 (NS)	Ss-C3 (EW)	Ss-C4 (NS)	Ss-C4 (EW)
-----------------	---------------	---------------	---------------	---------------

(b) EW 方向

Ss-A (H)	Ss-B3 (EW)	Ss-B4 (EW)
-------------	---------------	---------------

Ss-C1 (NSEW)	Ss-C3 (NS)	Ss-C3 (EW)	Ss-C4 (NS)	Ss-C4 (EW)
-----------------	---------------	---------------	---------------	---------------

凡例

- ① : 基礎浮上り非線形モデル
- ② : 誘発上下動を考慮するモデル
- ③ : 地盤 3 次元 FEM モデル

(c) 鉛直方向

Ss-A (V)	Ss-B3 (UD)	Ss-B4 (UD)	Ss-C1 (UD)	Ss-C3 (UD)
-------------	---------------	---------------	---------------	---------------

凡例

- ① : 鉛直ばねモデル
- ② : 地盤 3 次元 FEM モデル

第 4.1-3 表 地震応答解析に採用した解析モデル
(基準地震動 S_s , ケース No. 2)

(a) NS 方向

Ss-A (H)	Ss-B3 (NS)	Ss-B4 (NS)
-------------	---------------	---------------

Ss-C1 (NSEW)	Ss-C3 (NS)	Ss-C3 (EW)	Ss-C4 (NS)	Ss-C4 (EW)
-----------------	---------------	---------------	---------------	---------------

(b) EW 方向

Ss-A (H)	Ss-B3 (EW)	Ss-B4 (EW)
-------------	---------------	---------------

Ss-C1 (NSEW)	Ss-C3 (NS)	Ss-C3 (EW)	Ss-C4 (NS)	Ss-C4 (EW)
-----------------	---------------	---------------	---------------	---------------

凡例

- ① : 基礎浮上り非線形モデル
- ② : 誘発上下動を考慮するモデル
- ③ : 地盤 3 次元 FEM モデル

(c) 鉛直方向

Ss-A (V)	Ss-B3 (UD)	Ss-B4 (UD)	Ss-C1 (UD)	Ss-C3 (UD)
-------------	---------------	---------------	---------------	---------------

凡例

- ① : 鉛直ばねモデル
- ② : 地盤 3 次元 FEM モデル

第 4.1-4 表 地震応答解析に採用した解析モデル
 (弾性設計用地震動 S d, ケース No. 0)

(a) NS 方向

Sd-A (H)	Sd-B1 (NS)	Sd-B2 (NS)	Sd-B3 (NS)	Sd-B4 (NS)	Sd-B5 (NS)
-------------	---------------	---------------	---------------	---------------	---------------

Sd-C1 (NSEW)	Sd-C2 (NS)	Sd-C2 (EW)	Sd-C3 (NS)	Sd-C3 (EW)	Sd-C4 (NS)	Sd-C4 (EW)
-----------------	---------------	---------------	---------------	---------------	---------------	---------------

(b) EW 方向

Sd-A (H)	Sd-B1 (EW)	Sd-B2 (EW)	Sd-B3 (EW)	Sd-B4 (EW)	Sd-B5 (EW)
-------------	---------------	---------------	---------------	---------------	---------------

Sd-C1 (NSEW)	Sd-C2 (NS)	Sd-C2 (EW)	Sd-C3 (NS)	Sd-C3 (EW)	Sd-C4 (NS)	Sd-C4 (EW)
-----------------	---------------	---------------	---------------	---------------	---------------	---------------

凡例

- ① : 基礎浮上り非線形モデル
- ② : 誘発上下動を考慮するモデル
- ③ : 地盤 3 次元 FEM モデル

(c) 鉛直方向

Sd-A (V)	Sd-B1 (UD)	Sd-B2 (UD)	Sd-B3 (UD)	Sd-B4 (UD)	Sd-B5 (UD)
-------------	---------------	---------------	---------------	---------------	---------------

Sd-C1 (UD)	Sd-C2 (UD)	Sd-C3 (UD)
---------------	---------------	---------------

凡例

- ① : 鉛直ばねモデル
- ② : 地盤 3 次元 FEM モデル

第 4.1-5 表 地震応答解析に採用した解析モデル
 (弾性設計用地震動 S d, ケース No. 1)

(a) NS 方向

Sd-A (H)	Sd-C1 (NSEW)	Sd-C3 (NS)	Sd-C3 (EW)	Sd-C4 (NS)	Sd-C4 (EW)
-------------	-----------------	---------------	---------------	---------------	---------------

(b) EW 方向

Sd-A (H)	Sd-C1 (NSEW)	Sd-C3 (NS)	Sd-C3 (EW)	Sd-C4 (NS)	Sd-C4 (EW)
-------------	-----------------	---------------	---------------	---------------	---------------

凡例

- ①：基礎浮上り非線形モデル
- ②：誘発上下動を考慮するモデル
- ③：地盤 3 次元 FEM モデル

(c) 鉛直方向

Sd-A (V)	Sd-C1 (UD)	Sd-C3 (UD)
-------------	---------------	---------------

凡例

- ①：鉛直ばねモデル
- ②：地盤 3 次元 FEM モデル

第 4.1-6 表 地震応答解析に採用した解析モデル
 (弾性設計用地震動 S d, ケース No. 2)

(a) NS 方向

Sd-A (H)	Sd-C1 (NSEW)	Sd-C3 (NS)	Sd-C3 (EW)	Sd-C4 (NS)	Sd-C4 (EW)
-------------	-----------------	---------------	---------------	---------------	---------------

(b) EW 方向

Sd-A (H)	Sd-C1 (NSEW)	Sd-C3 (NS)	Sd-C3 (EW)	Sd-C4 (NS)	Sd-C4 (EW)
-------------	-----------------	---------------	---------------	---------------	---------------

凡例

- ① : 基礎浮上り非線形モデル
- ② : 誘発上下動を考慮するモデル
- ③ : 地盤 3 次元 FEM モデル

(c) 鉛直方向

Sd-A (V)	Sd-C1 (UD)	Sd-C3 (UD)
-------------	---------------	---------------

凡例

- ① : 鉛直ばねモデル
- ② : 地盤 3 次元 FEM モデル

第 4.1.1-1 表 固有値解析結果 (S s - A)

(a)NS 方向

次数	固有周期 (s)	固有振動数 (Hz)	刺激係数	卓越モード

(b)EW 方向

次数	固有周期 (s)	固有振動数 (Hz)	刺激係数	卓越モード

(c)鉛直方向

次数	固有周期 (s)	固有振動数 (Hz)	刺激係数	卓越モード

第 4.1.1-2 表 固有値解析結果 (S s - B 1)

(a)NS 方向

次数	固有周期 (s)	固有振動数 (Hz)	刺激係数	卓越モード

(b)EW 方向

次数	固有周期 (s)	固有振動数 (Hz)	刺激係数	卓越モード

(c)鉛直方向

次数	固有周期 (s)	固有振動数 (Hz)	刺激係数	卓越モード

第 4.1.1-3 表 固有値解析結果 (S s - B 2)

(a)NS 方向

次数	固有周期 (s)	固有振動数 (Hz)	刺激係数	卓越モード

(b)EW 方向

次数	固有周期 (s)	固有振動数 (Hz)	刺激係数	卓越モード

(c)鉛直方向

次数	固有周期 (s)	固有振動数 (Hz)	刺激係数	卓越モード

第 4.1.1-4 表 固有値解析結果 (S s - B 3)

(a)NS 方向

次数	固有周期 (s)	固有振動数 (Hz)	刺激係数	卓越モード

(b)EW 方向

次数	固有周期 (s)	固有振動数 (Hz)	刺激係数	卓越モード

(c)鉛直方向

次数	固有周期 (s)	固有振動数 (Hz)	刺激係数	卓越モード

第 4.1.1-5 表 固有値解析結果 (S s - B 4)

(a)NS 方向

次数	固有周期 (s)	固有振動数 (Hz)	刺激係数	卓越モード

(b)EW 方向

次数	固有周期 (s)	固有振動数 (Hz)	刺激係数	卓越モード

(c)鉛直方向

次数	固有周期 (s)	固有振動数 (Hz)	刺激係数	卓越モード

第 4.1.1-6 表 固有値解析結果 (S s - B 5)

(a)NS 方向

次数	固有周期 (s)	固有振動数 (Hz)	刺激係数	卓越モード

(b)EW 方向

次数	固有周期 (s)	固有振動数 (Hz)	刺激係数	卓越モード

(c)鉛直方向

次数	固有周期 (s)	固有振動数 (Hz)	刺激係数	卓越モード

第 4.1.1-7 表 固有値解析結果 (S s - C 1)

(a)NS 方向

次数	固有周期 (s)	固有振動数 (Hz)	刺激係数	卓越モード

(b)EW 方向

次数	固有周期 (s)	固有振動数 (Hz)	刺激係数	卓越モード

(c)鉛直方向

次数	固有周期 (s)	固有振動数 (Hz)	刺激係数	卓越モード

第 4.1.1-8 表 固有値解析結果 (S s - C 2)

(a)NS 方向

次数	固有周期 (s)	固有振動数 (Hz)	刺激係数	卓越モード

(b)EW 方向

次数	固有周期 (s)	固有振動数 (Hz)	刺激係数	卓越モード

(c)鉛直方向

次数	固有周期 (s)	固有振動数 (Hz)	刺激係数	卓越モード

第 4.1.1-9 表 固有値解析結果 (S s - C 3)

(a)NS 方向

次数	固有周期 (s)	固有振動数 (Hz)	刺激係数	卓越モード

(b)EW 方向

次数	固有周期 (s)	固有振動数 (Hz)	刺激係数	卓越モード

(c)鉛直方向

次数	固有周期 (s)	固有振動数 (Hz)	刺激係数	卓越モード

第 4.1.1-10 表 固有値解析結果 (S s - C 4)

(a)NS 方向

次数	固有周期 (s)	固有振動数 (Hz)	刺激係数	卓越モード

(b)EW 方向

次数	固有周期 (s)	固有振動数 (Hz)	刺激係数	卓越モード

1 次モード

固有周期 $T_1 =$ [] (s)
固有振動数 $f_1 =$ [] (Hz)
刺激係数 $\beta_1 =$ []

2 次モード

固有周期 $T_2 =$ [] (s)
固有振動数 $f_2 =$ [] (Hz)
刺激係数 $\beta_2 =$ []

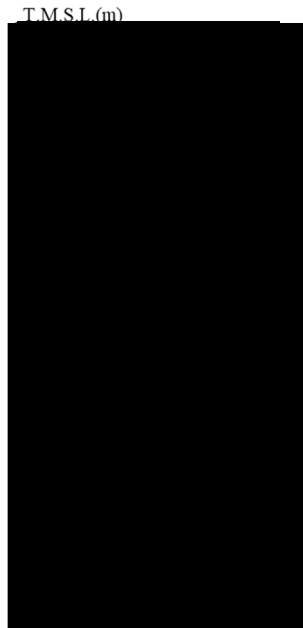

第 4.1.1-1 図 刺激関数図 (S s - A, NS 方向)

1 次モード

固有周期 $T_1 =$ [] (s)
固有振動数 $f_1 =$ [] (Hz)
刺激係数 $\beta_1 =$ []

2 次モード

固有周期 $T_2 =$ [] (s)
固有振動数 $f_2 =$ [] (Hz)
刺激係数 $\beta_2 =$ []

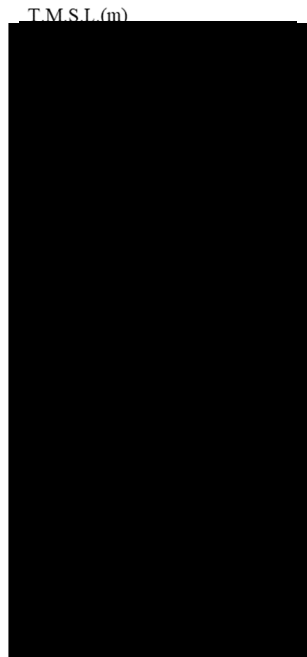

第 4.1.1-2 図 刺激関数図 (S s - A, EW 方向)

1 次モード

固有周期 $T_1 = \blacksquare$ (s)
固有振動数 $f_1 = \blacksquare$ (Hz)
刺激係数 $\beta_1 = \blacksquare$

2 次モード

固有周期 $T_2 = \blacksquare$ (s)
固有振動数 $f_2 = \blacksquare$ (Hz)
刺激係数 $\beta_2 = \blacksquare$



第 4.1.1-3 図 刺激関数図 (S s - A, 鉛直方向)

第 4. 1. 1-11 表 固有値解析結果 (S d - A)

(a)NS 方向

次数	固有周期 (s)	固有振動数 (Hz)	刺激係数	卓越モード

(b)EW 方向

次数	固有周期 (s)	固有振動数 (Hz)	刺激係数	卓越モード

(c)鉛直方向

次数	固有周期 (s)	固有振動数 (Hz)	刺激係数	卓越モード

第 4.1.1-12 表 固有値解析結果 (S d - B 1)

(a)NS 方向

次数	固有周期 (s)	固有振動数 (Hz)	刺激係数	卓越モード

(b)EW 方向

次数	固有周期 (s)	固有振動数 (Hz)	刺激係数	卓越モード

(c)鉛直方向

次数	固有周期 (s)	固有振動数 (Hz)	刺激係数	卓越モード

第 4.1.1-13 表 固有値解析結果 (S d - B 2)

(a)NS 方向

次数	固有周期 (s)	固有振動数 (Hz)	刺激係数	卓越モード

(b)EW 方向

次数	固有周期 (s)	固有振動数 (Hz)	刺激係数	卓越モード

(c)鉛直方向

次数	固有周期 (s)	固有振動数 (Hz)	刺激係数	卓越モード

第 4.1.1-14 表 固有値解析結果 (S d - B 3)

(a)NS 方向

次数	固有周期 (s)	固有振動数 (Hz)	刺激係数	卓越モード

(b)EW 方向

次数	固有周期 (s)	固有振動数 (Hz)	刺激係数	卓越モード

(c)鉛直方向

次数	固有周期 (s)	固有振動数 (Hz)	刺激係数	卓越モード

第 4.1.1-15 表 固有値解析結果 (S d - B 4)

(a)NS 方向

次数	固有周期 (s)	固有振動数 (Hz)	刺激係数	卓越モード

(b)EW 方向

次数	固有周期 (s)	固有振動数 (Hz)	刺激係数	卓越モード

(c)鉛直方向

次数	固有周期 (s)	固有振動数 (Hz)	刺激係数	卓越モード

第 4.1.1-16 表 固有値解析結果 (S d - B 5)

(a)NS 方向

次数	固有周期 (s)	固有振動数 (Hz)	刺激係数	卓越モード

(b)EW 方向

次数	固有周期 (s)	固有振動数 (Hz)	刺激係数	卓越モード

(c)鉛直方向

次数	固有周期 (s)	固有振動数 (Hz)	刺激係数	卓越モード

第 4.1.1-17 表 固有値解析結果 (S d - C 1)

(a)NS 方向

次数	固有周期 (s)	固有振動数 (Hz)	刺激係数	卓越モード

(b)EW 方向

次数	固有周期 (s)	固有振動数 (Hz)	刺激係数	卓越モード

(c)鉛直方向

次数	固有周期 (s)	固有振動数 (Hz)	刺激係数	卓越モード

第 4.1.1-18 表 固有値解析結果 (S d - C 2)

(a)NS 方向

次数	固有周期 (s)	固有振動数 (Hz)	刺激係数	卓越モード

(b)EW 方向

次数	固有周期 (s)	固有振動数 (Hz)	刺激係数	卓越モード

(c)鉛直方向

次数	固有周期 (s)	固有振動数 (Hz)	刺激係数	卓越モード

第 4.1.1-19 表 固有値解析結果 (S d - C 3)

(a)NS 方向

次数	固有周期 (s)	固有振動数 (Hz)	刺激係数	卓越モード

(b)EW 方向

次数	固有周期 (s)	固有振動数 (Hz)	刺激係数	卓越モード

(c)鉛直方向

次数	固有周期 (s)	固有振動数 (Hz)	刺激係数	卓越モード

第 4.1.1-20 表 固有値解析結果 (S d - C 4)

(a)NS 方向

次数	固有周期 (s)	固有振動数 (Hz)	刺激係数	卓越モード
[Redacted]				

(b)EW 方向

次数	固有周期 (s)	固有振動数 (Hz)	刺激係数	卓越モード
[Redacted]				

1 次モード

固有周期 $T_1 = \blacksquare$ (s)
固有振動数 $f_1 = \blacksquare$ (Hz)
刺激係数 $\beta_1 = \blacksquare$

2 次モード

固有周期 $T_2 = \blacksquare$ (s)
固有振動数 $f_2 = \blacksquare$ (Hz)
刺激係数 $\beta_2 = \blacksquare$

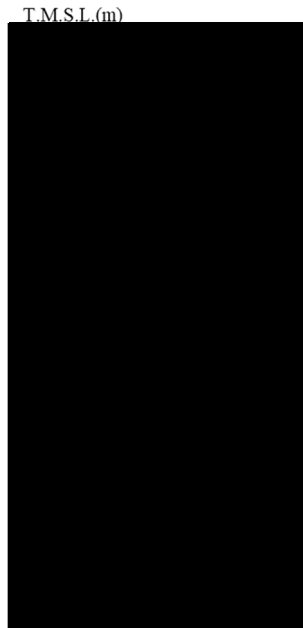

第 4.1.1-4 図 刺激関数図 (S d - A, NS 方向)

1 次モード

固有周期 $T_1 =$ [] (s)
固有振動数 $f_1 =$ [] (Hz)
刺激係数 $\beta_1 =$ []

2 次モード

固有周期 $T_2 =$ [] (s)
固有振動数 $f_2 =$ [] (Hz)
刺激係数 $\beta_2 =$ []

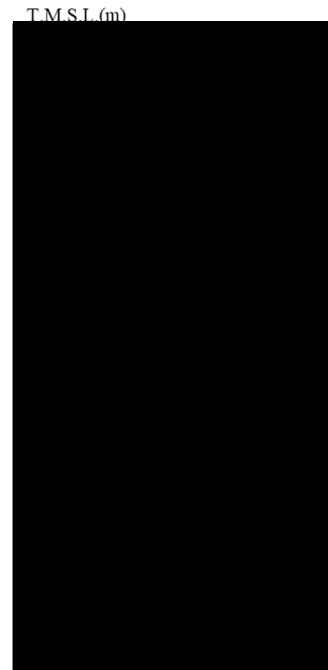
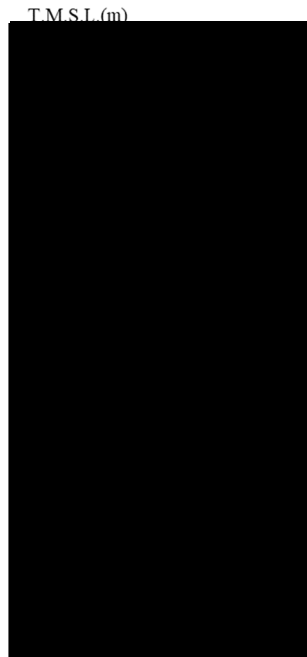

第 4.1.1-5 図 刺激関数図 (S d - A, EW 方向)

1 次モード

固有周期 $T_1 =$ [redacted] (s)
固有振動数 $f_1 =$ [redacted] (Hz)
刺激係数 $\beta_1 =$ [redacted]

2 次モード

固有周期 $T_2 =$ [redacted] (s)
固有振動数 $f_2 =$ [redacted] (Hz)
刺激係数 $\beta_2 =$ [redacted]

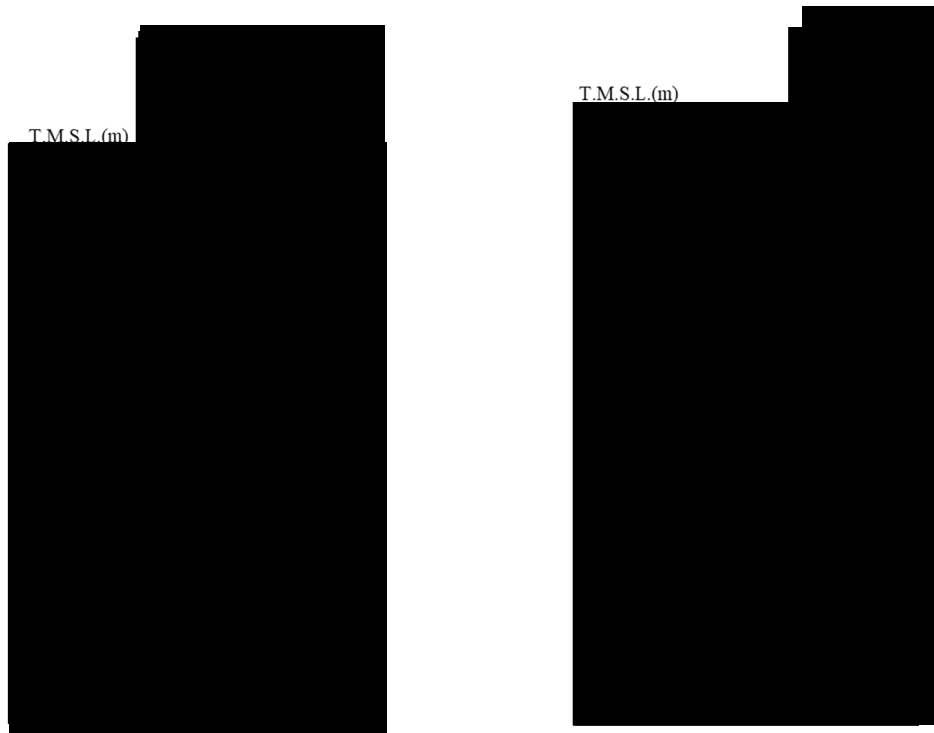

第 4.1.1-6 図 刺激関数図 (S d - A, 鉛直方向)



第 4.1.2-1 図 最大応答加速度（基準地震動 S_s ，ケース No. 0，NS 方向）

第 4.1.2-1 表 最大応答加速度一覧表（基準地震動 S_s ，ケース No. 0，NS 方向）

T. M. S. L. (m)	質点番号	最大応答加速度 (cm/s ²)												最大値
		Ss-A (H)	Ss-B1 (NS)	Ss-B2 (NS)	Ss-B3 (NS)	Ss-B4 (NS)	Ss-B5 (NS)	Ss-C1 (NSEW)	Ss-C2 (NS)	Ss-C2 (EW)	Ss-C3 (NS)	Ss-C3 (EW)	Ss-C4 (NS)	



第 4.1.2-2 図 最大応答変位 (基準地震動 S_s , ケース No.0, NS 方向)

第 4.1.2-2 表 最大応答変位一覧表 (基準地震動 S_s , ケース No.0, NS 方向)

T. M. S. L. (m)	質点番号	最大応答変位 (mm)												最大値
		Ss-A (H)	Ss-B1 (NS)	Ss-B2 (NS)	Ss-B3 (NS)	Ss-B4 (NS)	Ss-B5 (NS)	Ss-C1 (NSEW)	Ss-C2 (NS)	Ss-C2 (EW)	Ss-C3 (NS)	Ss-C3 (EW)	Ss-C4 (NS)	



第 4.1.2-3 図 最大応答せん断力（基準地震動 S_s ，ケース No. 0，NS 方向）

第 4.1.2-3 表 最大応答せん断力一覧表（基準地震動 S_s ，ケース No. 0，NS 方向）

T. M. S. L. (m)	要素 番号	最大応答せん断力 ($\times 10^6 kN$)												最大値
		Ss-A (H)	Ss-B1 (NS)	Ss-B2 (NS)	Ss-B3 (NS)	Ss-B4 (NS)	Ss-B5 (NS)	Ss-C1 (NSEW)	Ss-C2 (NS)	Ss-C2 (EW)	Ss-C3 (NS)	Ss-C3 (EW)	Ss-C4 (NS)	



第 4. 1. 2-4 図 最大応答曲げモーメント（基準地震動 S_s ，ケース No. 0，NS 方向）

第 4. 1. 2-4 表 最大応答曲げモーメント一覧表（基準地震動 S_s ，ケース No. 0，NS 方向）

T. M. S. L. (m)	要素 番号	最大応答曲げモーメント ($\times 10^6 \text{kN}\cdot\text{m}$)											最大値
		Ss-A (H)	Ss-B1 (NS)	Ss-B2 (NS)	Ss-B3 (NS)	Ss-B4 (NS)	Ss-B5 (NS)	Ss-C1 (NSEW)	Ss-C2 (NS)	Ss-C2 (EW)	Ss-C3 (NS)	Ss-C3 (EW)	



第 4. 1. 2-5 図 最大応答加速度（基準地震動 S_s ，ケース No. 0，EW 方向）

第 4. 1. 2-5 表 最大応答加速度一覧表（基準地震動 S_s ，ケース No. 0，EW 方向）

T. M. S. L. (m)	質点番号	最大応答加速度 (cm/s ²)												最大値
		Ss-A (H)	Ss-B1 (EW)	Ss-B2 (EW)	Ss-B3 (EW)	Ss-B4 (EW)	Ss-B5 (EW)	Ss-C1 (NSEW)	Ss-C2 (NS)	Ss-C2 (EW)	Ss-C3 (NS)	Ss-C3 (EW)	Ss-C4 (NS)	

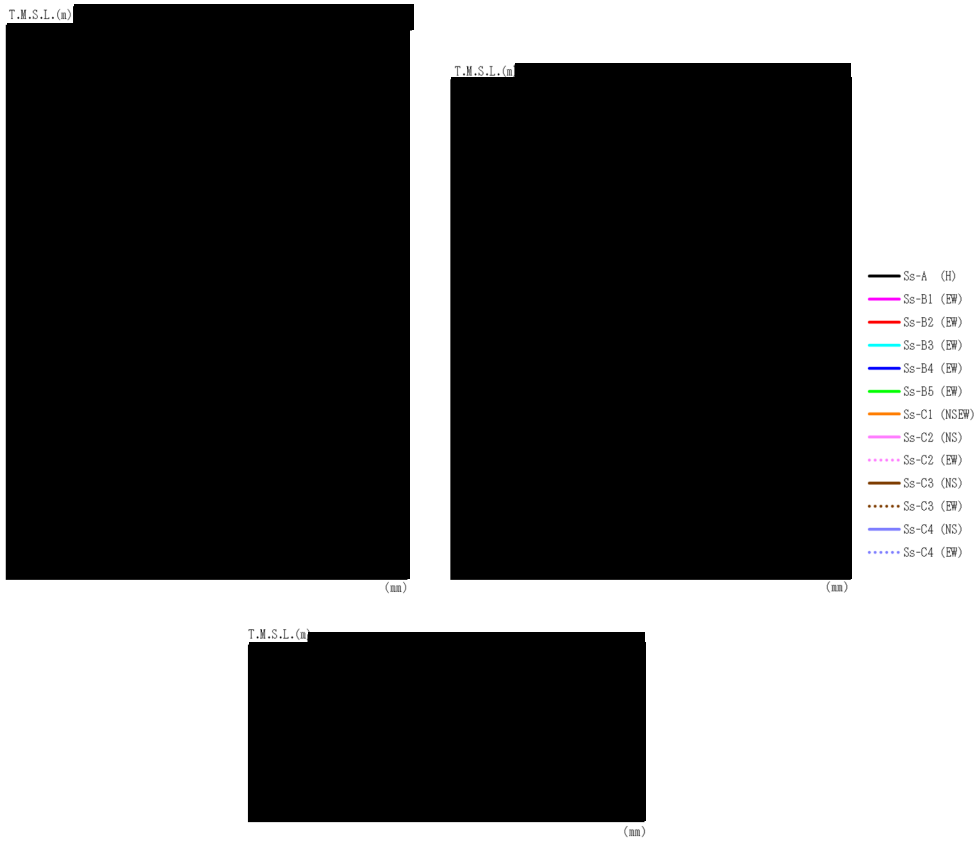

第 4.1.2-6 図 最大応答変位 (基準地震動 S_s , ケース No.0, EW 方向)

第 4.1.2-6 表 最大応答変位一覧表 (基準地震動 S_s , ケース No.0, EW 方向)

T. M. S. L. (m)	質点番号	最大応答変位 (mm)												最大値
		Ss-A (H)	Ss-B1 (EW)	Ss-B2 (EW)	Ss-B3 (EW)	Ss-B4 (EW)	Ss-B5 (EW)	Ss-C1 (NSEW)	Ss-C2 (NS)	Ss-C2 (EW)	Ss-C3 (NS)	Ss-C3 (EW)	Ss-C4 (NS)	

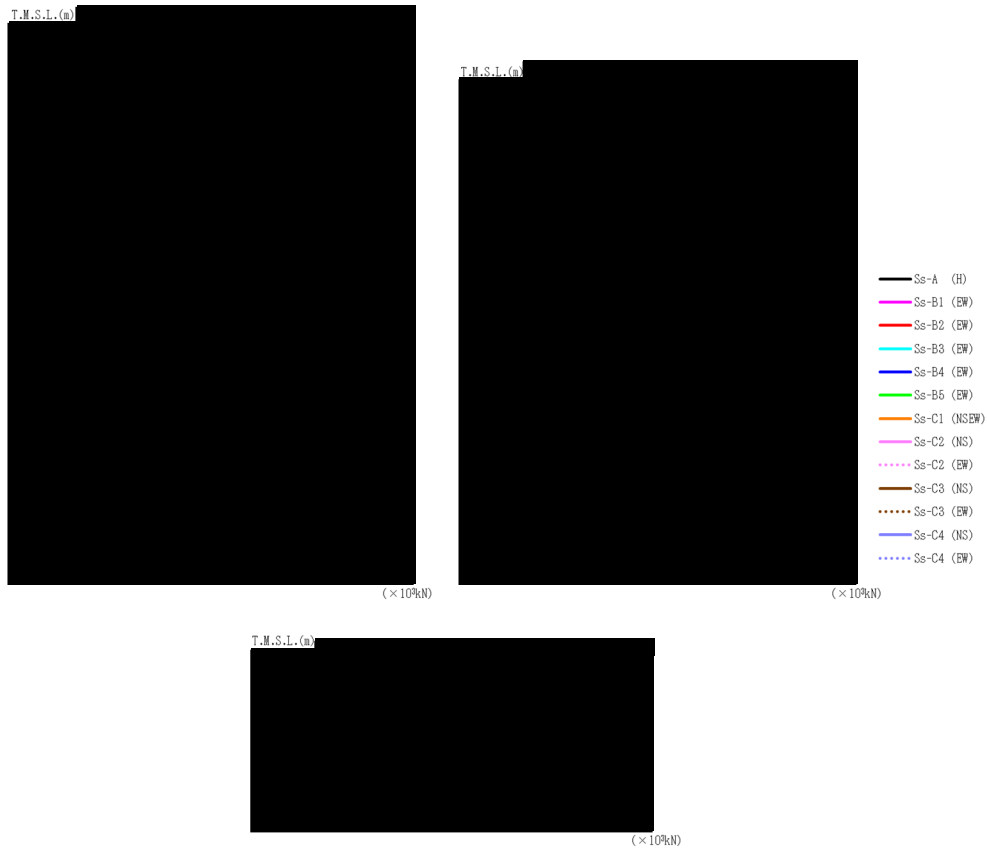

第 4.1.2-7 図 最大応答せん断力（基準地震動 S_s ，ケース No. 0，EW 方向）

第 4.1.2-7 表 最大応答せん断力一覧表（基準地震動 S_s ，ケース No. 0，EW 方向）

T. M. S. L. (m)	要素 番号	最大応答せん断力 ($\times 10^6 kN$)												最大値
		Ss-A (H)	Ss-B1 (EW)	Ss-B2 (EW)	Ss-B3 (EW)	Ss-B4 (EW)	Ss-B5 (EW)	Ss-C1 (NSEW)	Ss-C2 (NS)	Ss-C2 (EW)	Ss-C3 (NS)	Ss-C3 (EW)	Ss-C4 (NS)	
[Redacted data]														

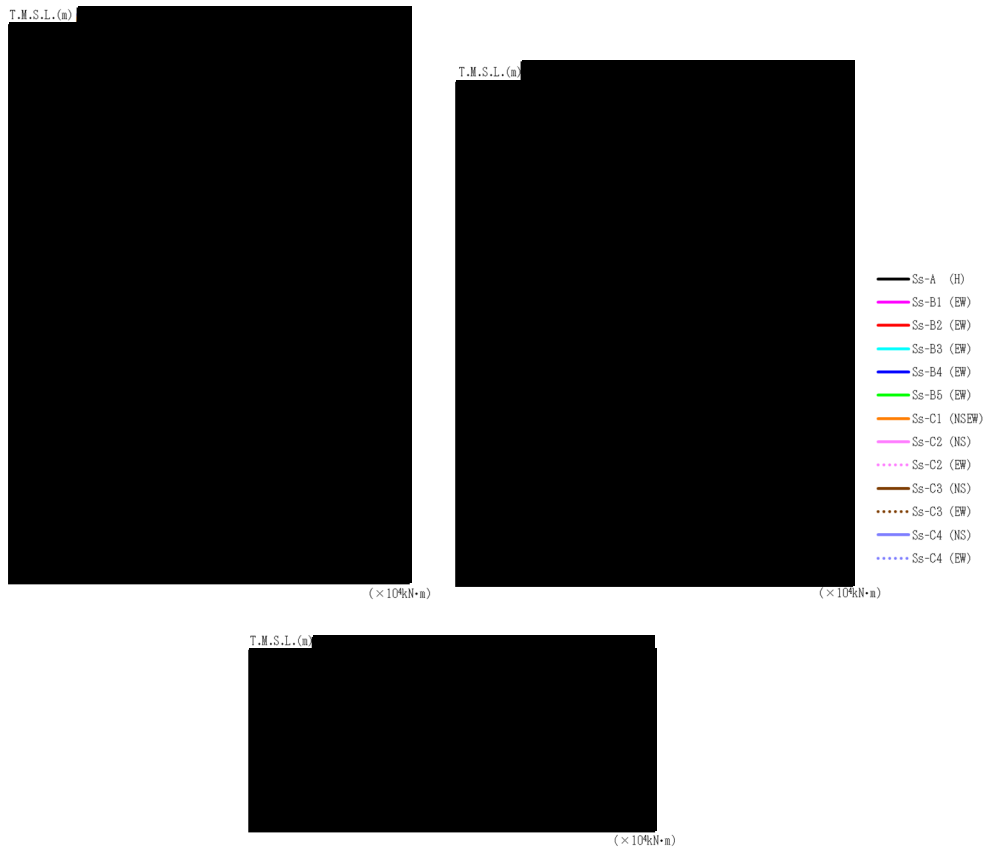

第 4. 1. 2-8 図 最大応答曲げモーメント（基準地震動 S_s ，ケース No. 0，EW 方向）

第 4. 1. 2-8 表 最大応答曲げモーメント一覧表（基準地震動 S_s ，ケース No. 0，EW 方向）

T. M. S. L. (m)	要素 番号	最大応答曲げモーメント ($\times 10^4 \text{kN}\cdot\text{m}$)												最大値	
		Ss-A (H)	Ss-B1 (EW)	Ss-B2 (EW)	Ss-B3 (EW)	Ss-B4 (EW)	Ss-B5 (EW)	Ss-C1 (NSEW)	Ss-C2 (NS)	Ss-C2 (EW)	Ss-C3 (NS)	Ss-C3 (EW)	Ss-C4 (NS)		Ss-C4 (EW)

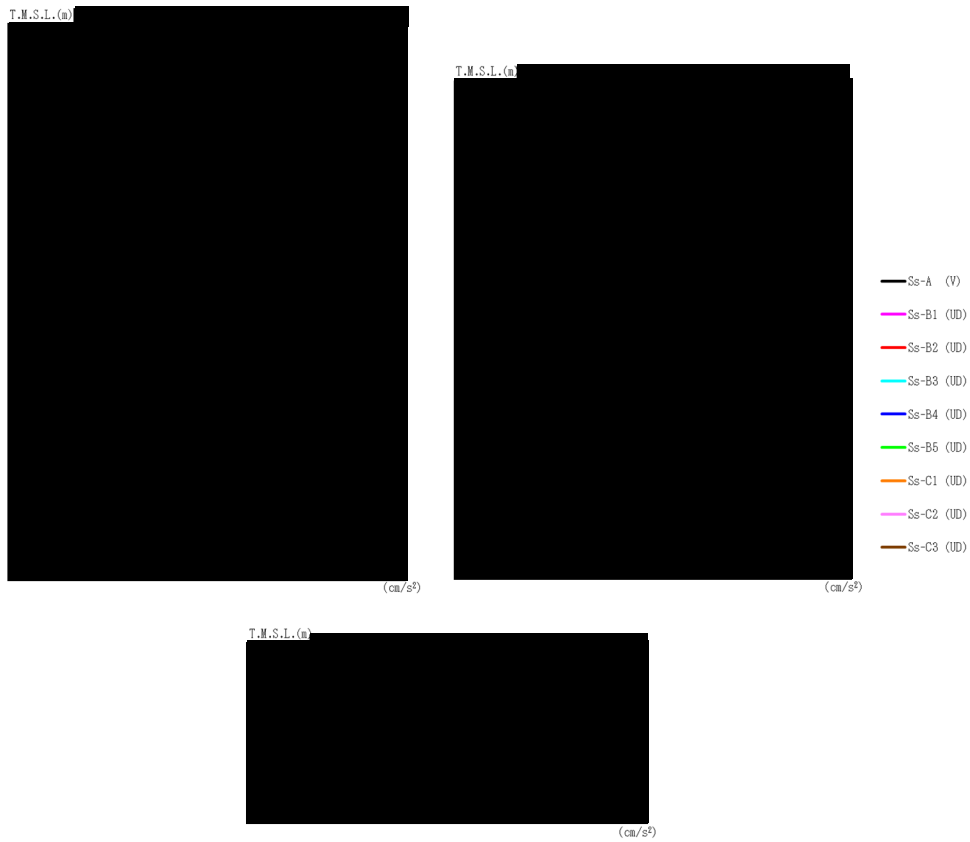

第 4.1.2-9 図 最大応答加速度（基準地震動 S_s ，ケース No. 0，鉛直方向）

第 4.1.2-9 表 最大応答加速度一覧表（基準地震動 S_s ，ケース No. 0，鉛直方向）

T. M. S. L. (m)	質点 番号	最大応答加速度 (cm/s^2)								
		Ss-A (V)	Ss-B1 (UD)	Ss-B2 (UD)	Ss-B3 (UD)	Ss-B4 (UD)	Ss-B5 (UD)	Ss-C1 (UD)	Ss-C2 (UD)	Ss-C3 (UD)

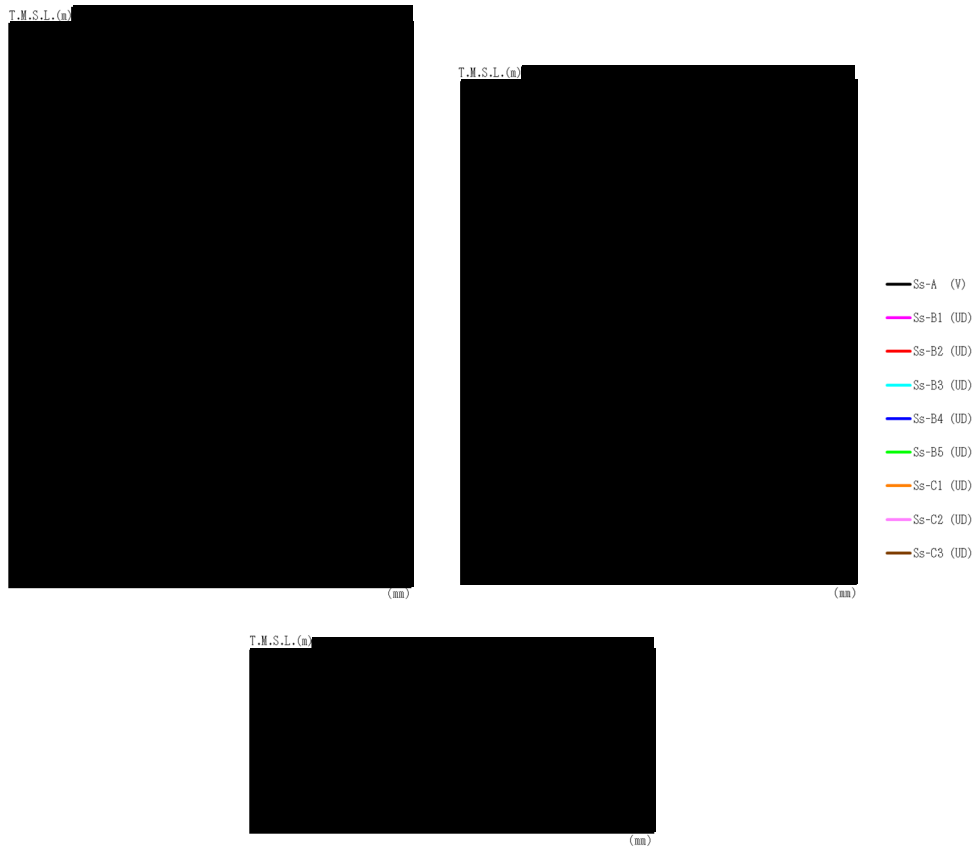

第 4. 1. 2-10 図 最大応答変位（基準地震動 S_s ，ケース No. 0，鉛直方向）

第 4. 1. 2-10 表 最大応答変位一覧表（基準地震動 S_s ，ケース No. 0，鉛直方向）

T. M. S. L. (m)	質点 番号	最大応答変位(mm)									最大値
		Ss-A (V)	Ss-B1 (UD)	Ss-B2 (UD)	Ss-B3 (UD)	Ss-B4 (UD)	Ss-B5 (UD)	Ss-C1 (UD)	Ss-C2 (UD)	Ss-C3 (UD)	

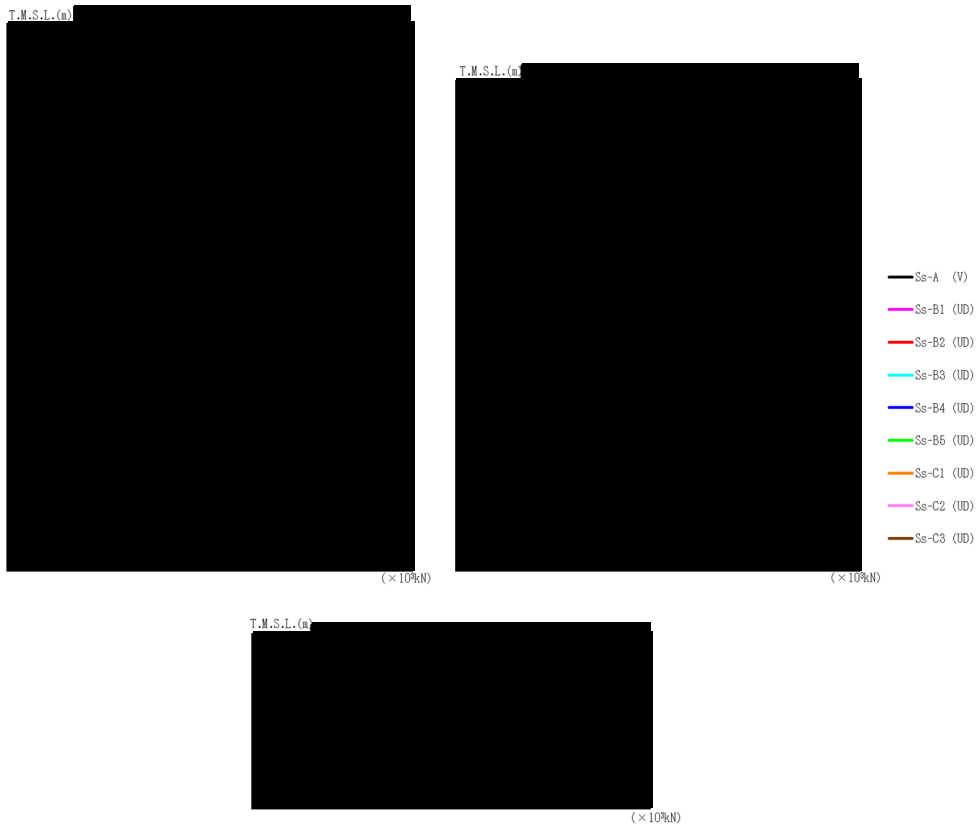

第 4. 1. 2-11 図 最大応答軸力（基準地震動 S_s ，ケース No. 0，鉛直方向）

第 4. 1. 2-11 表 最大応答軸力一覧表（基準地震動 S_s ，ケース No. 0，鉛直方向）

T. M. S. L. (m)	要素 番号	最大応答軸力 ($\times 10^3 \text{kN}$)									最大値
		Ss-A (V)	Ss-B1 (UD)	Ss-B2 (UD)	Ss-B3 (UD)	Ss-B4 (UD)	Ss-B5 (UD)	Ss-C1 (UD)	Ss-C2 (UD)	Ss-C3 (UD)	

第 4. 1. 2-12 表 浮上り検討 (基準地震動 S_s , ケース No. 0)

(a)NS 方向

地震動	浮上り限界転倒 モーメント ($\times 10^6 \text{kN}\cdot\text{m}$)	最小接地率算出時の 転倒モーメント ($\times 10^6 \text{kN}\cdot\text{m}$)	接地率 (%)
Ss-A (H)			
Ss-B1 (NS)			
Ss-B2 (NS)			
Ss-B3 (NS)			
Ss-B4 (NS)			
Ss-B5 (NS)			
Ss-C1 (NSEW)			
Ss-C2 (NS)			
Ss-C2 (EW)			
Ss-C3 (NS)			
Ss-C3 (EW)			
Ss-C4 (NS)			
Ss-C4 (EW)			

(b)EW 方向

地震動	浮上り限界転倒 モーメント ($\times 10^6 \text{kN}\cdot\text{m}$)	最小接地率算出時の 転倒モーメント ($\times 10^6 \text{kN}\cdot\text{m}$)	接地率 (%)
Ss-A (H)			
Ss-B1 (EW)			
Ss-B2 (EW)			
Ss-B3 (EW)			
Ss-B4 (EW)			
Ss-B5 (EW)			
Ss-C1 (NSEW)			
Ss-C2 (NS)			
Ss-C2 (EW)			
Ss-C3 (NS)			
Ss-C3 (EW)			
Ss-C4 (NS)			
Ss-C4 (EW)			

第 4.1.2-13 表 最大接地圧（基準地震動 S_s ，ケース No.0）（1/2）

地震動	方向		最大接地圧(kN/m ²)
S _s -A	NS	鉛直上向き	
		鉛直下向き	
	EW	鉛直上向き	
		鉛直下向き	
S _s -B1	NS	鉛直上向き	
		鉛直下向き	
	EW	鉛直上向き	
		鉛直下向き	
S _s -B2	NS	鉛直上向き	
		鉛直下向き	
	EW	鉛直上向き	
		鉛直下向き	
S _s -B3	NS	鉛直上向き	
		鉛直下向き	
	EW	鉛直上向き	
		鉛直下向き	
S _s -B4	NS	鉛直上向き	
		鉛直下向き	
	EW	鉛直上向き	
		鉛直下向き	
S _s -B5	NS	鉛直上向き	
		鉛直下向き	
	EW	鉛直上向き	
		鉛直下向き	

第 4.1.2-13 表 最大接地圧（基準地震動 S_s ，ケース No. 0）（2/2）

地震動	方向		最大接地圧 (kN/m ²)
S _s -C1	NS	鉛直上向き	
		鉛直下向き	
	EW	鉛直上向き	
		鉛直下向き	
S _s -C2 (NS)	NS	鉛直上向き	
		鉛直下向き	
	EW	鉛直上向き	
		鉛直下向き	
S _s -C2 (EW)	NS	鉛直上向き	
		鉛直下向き	
	EW	鉛直上向き	
		鉛直下向き	
S _s -C3 (NS)	NS	鉛直上向き	
		鉛直下向き	
	EW	鉛直上向き	
		鉛直下向き	
S _s -C3 (EW)	NS	鉛直上向き	
		鉛直下向き	
	EW	鉛直上向き	
		鉛直下向き	
S _s -C4 (NS)	NS	—	
	EW	—	
S _s -C4 (EW)	NS	—	
	EW	—	



第 4.1.2-12 図 最大応答加速度（弾性設計用地震動 S d，ケース No.0，NS 方向）

第 4.1.2-14 表 最大応答加速度一覧表（弾性設計用地震動 S d，ケース No.0，NS 方向）

T. M. S. L. (m)	質点番号	最大応答加速度 (cm/s ²)												最大値
		Sd-A (H)	Sd-B1 (NS)	Sd-B2 (NS)	Sd-B3 (NS)	Sd-B4 (NS)	Sd-B5 (NS)	Sd-C1 (NSEW)	Sd-C2 (NS)	Sd-C2 (EW)	Sd-C3 (NS)	Sd-C3 (EW)	Sd-C4 (NS)	
[Redacted Data]														



第 4. 1. 2-13 図 最大応答変位（弾性設計用地震動 S d，ケース No. 0，NS 方向）

第 4. 1. 2-15 表 最大応答変位一覧表（弾性設計用地震動 S d，ケース No. 0，NS 方向）

T. M. S. L. (m)	質点番号	最大応答変位 (mm)												最大値
		Sd-A (H)	Sd-B1 (NS)	Sd-B2 (NS)	Sd-B3 (NS)	Sd-B4 (NS)	Sd-B5 (NS)	Sd-C1 (NSEW)	Sd-C2 (NS)	Sd-C2 (EW)	Sd-C3 (NS)	Sd-C3 (EW)	Sd-C4 (NS)	
[Redacted Data]														

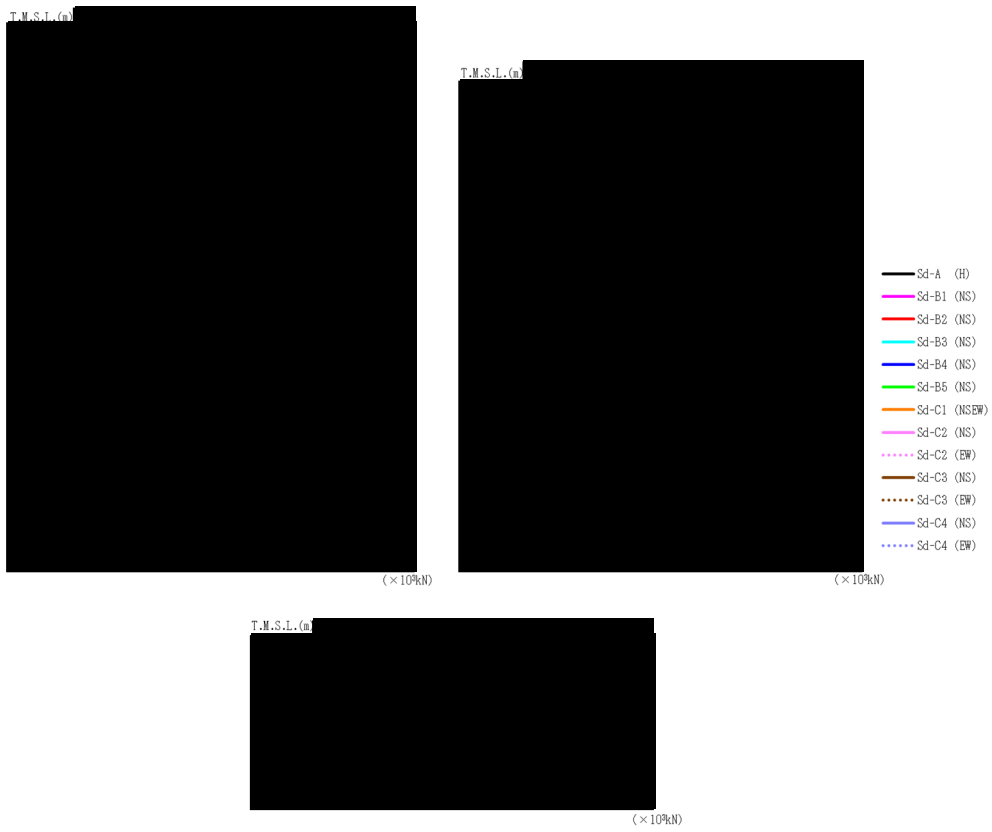

第 4. 1. 2-14 図 最大応答せん断力（弾性設計用地震動 S d， ケース No. 0， NS 方向）

第 4. 1. 2-16 表 最大応答せん断力一覧表（弾性設計用地震動 S d， ケース No. 0， NS 方向）

T. M. S. L. (m)	要素 番号	最大応答せん断力 (×10 ⁶ kN)												最大値
		Sd-A (H)	Sd-B1 (NS)	Sd-B2 (NS)	Sd-B3 (NS)	Sd-B4 (NS)	Sd-B5 (NS)	Sd-C1 (NSEW)	Sd-C2 (NS)	Sd-C2 (EW)	Sd-C3 (NS)	Sd-C3 (EW)	Sd-C4 (NS)	
[Redacted Data]														

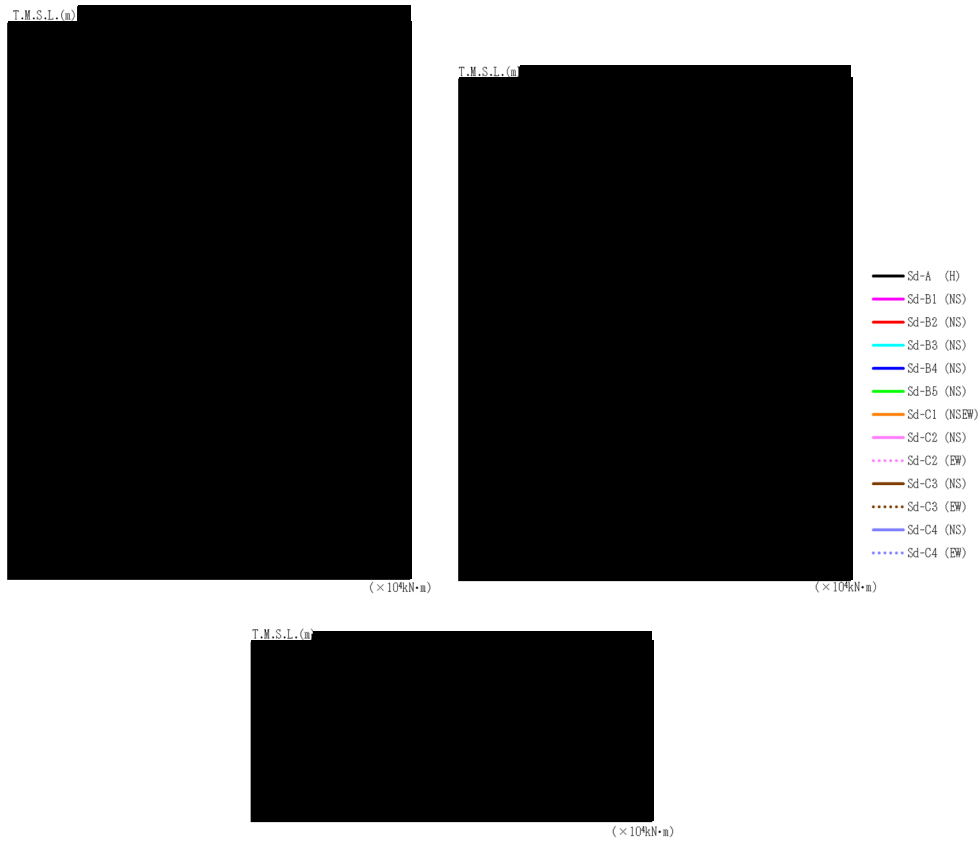

第 4.1.2-15 図 最大応答曲げモーメント
(弾性設計用地震動 S d , ケース No. 0, NS 方向)

第 4.1.2-17 表 最大応答曲げモーメント一覧表 (弾性設計用地震動 S d , ケース No. 0, NS 方向)

T. M. S. L. (m)	要素 番号	最大応答曲げモーメント(×10 ⁴ kN·m)												最大値
		Sd-A (H)	Sd-B1 (NS)	Sd-B2 (NS)	Sd-B3 (NS)	Sd-B4 (NS)	Sd-B5 (NS)	Sd-C1 (NSEW)	Sd-C2 (NS)	Sd-C2 (EW)	Sd-C3 (NS)	Sd-C3 (EW)	Sd-C4 (NS)	
[Redacted data]														



第 4.1.2-16 図 最大応答加速度（弾性設計用地震動 S d，ケース No.0，EW 方向）

第 4.1.2-18 表 最大応答加速度一覧表（弾性設計用地震動 S d，ケース No.0，EW 方向）

T. M. S. L. (m)	質点番号	最大応答加速度 (cm/s ²)												最大値
		Sd-A (H)	Sd-B1 (EW)	Sd-B2 (EW)	Sd-B3 (EW)	Sd-B4 (EW)	Sd-B5 (EW)	Sd-C1 (NSEW)	Sd-C2 (NS)	Sd-C2 (EW)	Sd-C3 (NS)	Sd-C3 (EW)	Sd-C4 (NS)	

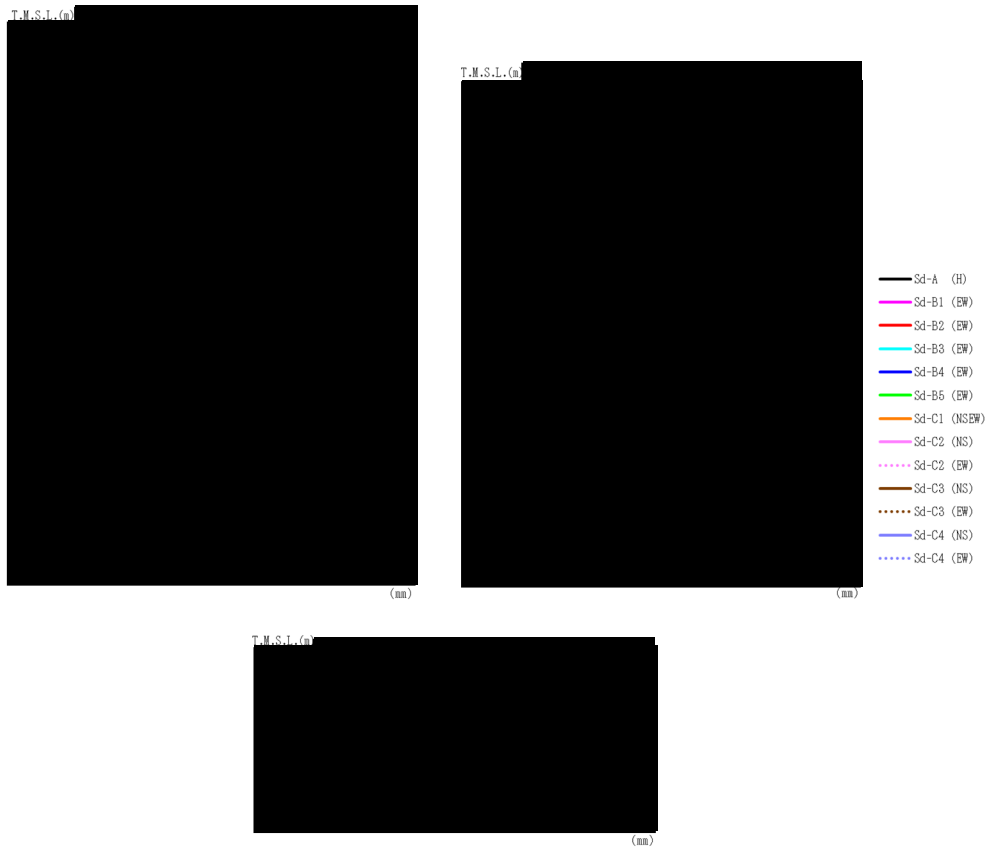

第 4. 1. 2-17 図 最大応答変位（弾性設計用地震動 S d，ケース No. 0，EW 方向）

第 4. 1. 2-19 表 最大応答変位一覧表（弾性設計用地震動 S d，ケース No. 0，EW 方向）

T. M. S. L. (m)	質点番号	最大応答変位 (mm)												最大値	
		Sd-A (H)	Sd-B1 (EW)	Sd-B2 (EW)	Sd-B3 (EW)	Sd-B4 (EW)	Sd-B5 (EW)	Sd-C1 (NSEW)	Sd-C2 (NS)	Sd-C2 (EW)	Sd-C3 (NS)	Sd-C3 (EW)	Sd-C4 (NS)		Sd-C4 (EW)



第 4. 1. 2-18 図 最大応答せん断力（弾性設計用地震動 S d，ケース No. 0，EW 方向）

第 4. 1. 2-20 表 最大応答せん断力一覧表（弾性設計用地震動 S d，ケース No. 0，EW 方向）

T. M. S. L. (m)	要素 番号	最大応答せん断力(×10%kN)												最大値
		Sd-A (H)	Sd-B1 (EW)	Sd-B2 (EW)	Sd-B3 (EW)	Sd-B4 (EW)	Sd-B5 (EW)	Sd-C1 (NSEW)	Sd-C2 (NS)	Sd-C2 (EW)	Sd-C3 (NS)	Sd-C3 (EW)	Sd-C4 (NS)	
[Redacted Data]														



第 4. 1. 2-19 図 最大応答曲げモーメント
(弾性設計用地震動 S d , ケース No. 0, EW 方向)

第 4. 1. 2-21 表 最大応答曲げモーメント一覧表 (弾性設計用地震動 S d , ケース No. 0, EW 方向)

T. M. S. L. (m)	要素 番号	最大応答曲げモーメント(×10%kN·m)												最大値
		Sd-A (H)	Sd-B1 (EW)	Sd-B2 (EW)	Sd-B3 (EW)	Sd-B4 (EW)	Sd-B5 (EW)	Sd-C1 (NSEW)	Sd-C2 (NS)	Sd-C2 (EW)	Sd-C3 (NS)	Sd-C3 (EW)	Sd-C4 (NS)	

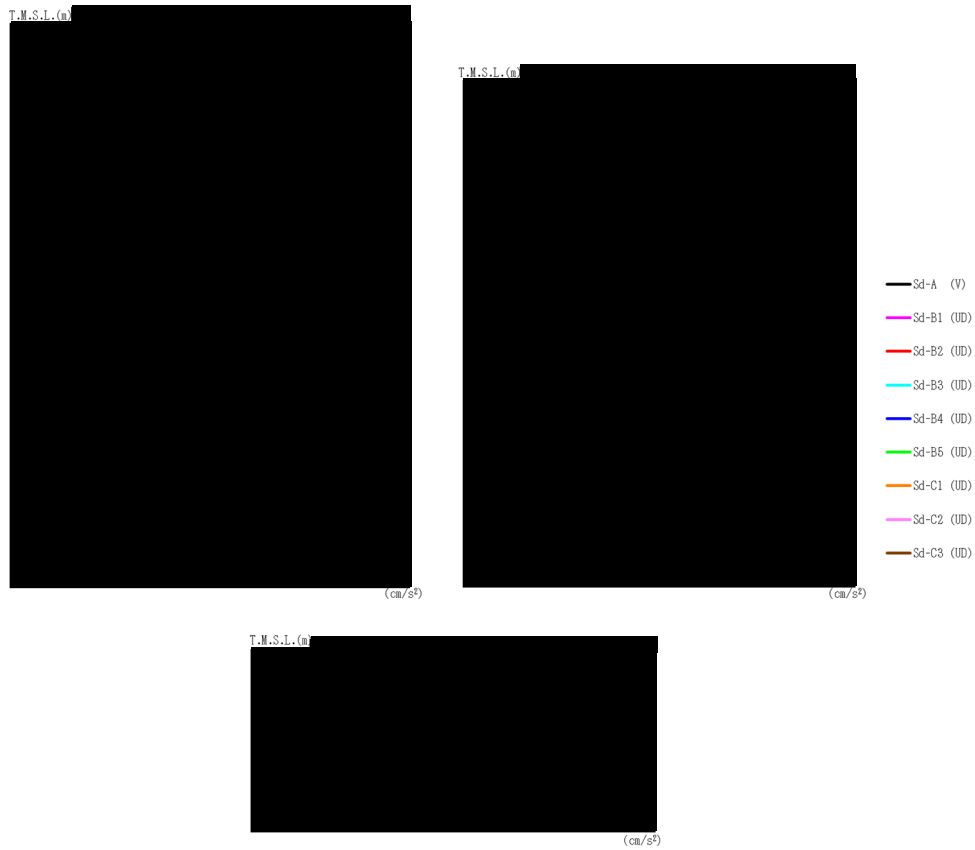

第 4. 1. 2-20 図 最大応答加速度（弾性設計用地震動 S d，ケース No. 0，鉛直方向）

第 4. 1. 2-22 表 最大応答加速度一覧表（弾性設計用地震動 S d，ケース No. 0，鉛直方向）

T. M. S. L. (m)	質点番号	最大応答加速度 (cm/s ²)								
		Sd-A (V)	Sd-B1 (UD)	Sd-B2 (UD)	Sd-B3 (UD)	Sd-B4 (UD)	Sd-B5 (UD)	Sd-C1 (UD)	Sd-C2 (UD)	Sd-C3 (UD)

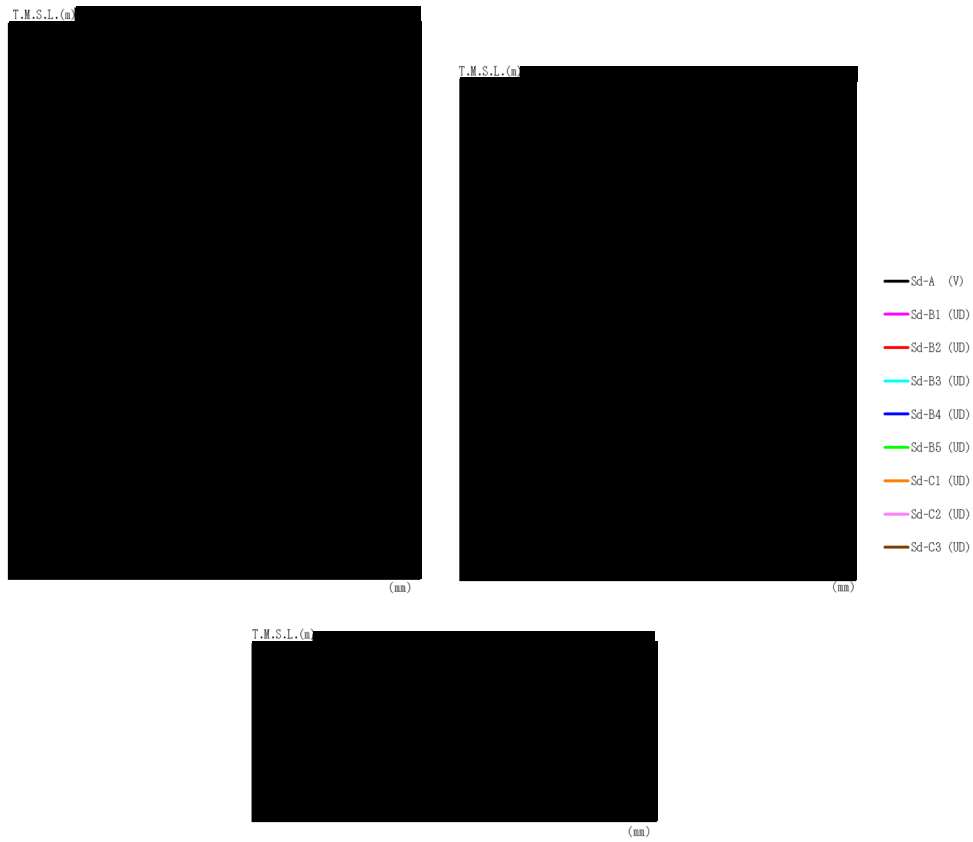

第 4.1.2-21 図 最大応答変位（弾性設計用地震動 S d，ケース No.0，鉛直方向）

第 4.1.2-23 表 最大応答変位一覧表（弾性設計用地震動 S d，ケース No.0，鉛直方向）

T. M. S. L. (m)	質点 番号	最大応答変位 (mm)								
		Sd-A (V)	Sd-B1 (UD)	Sd-B2 (UD)	Sd-B3 (UD)	Sd-B4 (UD)	Sd-B5 (UD)	Sd-C1 (UD)	Sd-C2 (UD)	Sd-C3 (UD)

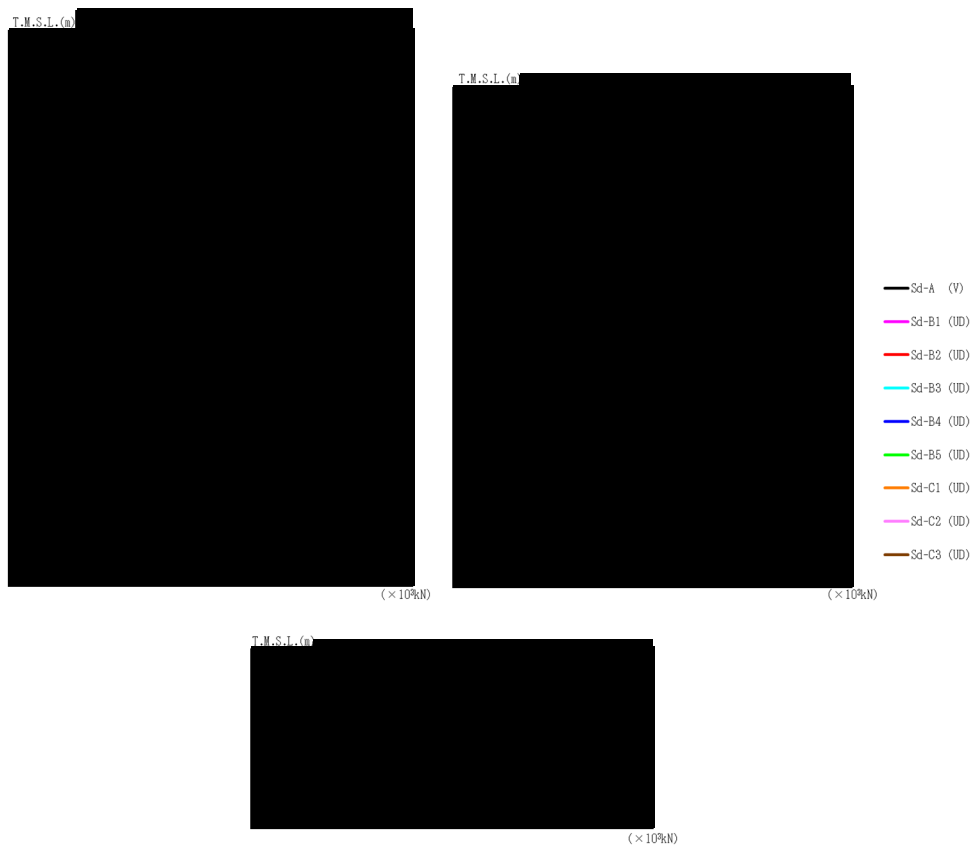

第 4.1.2-22 図 最大応答軸力（弾性設計用地震動 S d，ケース No. 0，鉛直方向）

第 4.1.2-24 表 最大応答軸力一覧表（弾性設計用地震動 S d，ケース No. 0，鉛直方向）

T. M. S. L. (m)	要素 番号	最大応答軸力 ($\times 10^3$ kN)									
		Sd-A (V)	Sd-B1 (UD)	Sd-B2 (UD)	Sd-B3 (UD)	Sd-B4 (UD)	Sd-B5 (UD)	Sd-C1 (UD)	Sd-C2 (UD)	Sd-C3 (UD)	最大値
[redacted]	[redacted]	[redacted]	[redacted]	[redacted]	[redacted]	[redacted]	[redacted]	[redacted]	[redacted]	[redacted]	[redacted]

第 4.1.2-25 表 浮上り検討 (弾性設計用地震動 S d, ケース No. 0)

(a)NS 方向

地震動	浮上り限界転倒 モーメント ($\times 10^6 \text{kN}\cdot\text{m}$)	最小接地率算出時の 転倒モーメント ($\times 10^6 \text{kN}\cdot\text{m}$)	接地率 (%)
Sd-A (H)			
Sd-B1 (NS)			
Sd-B2 (NS)			
Sd-B3 (NS)			
Sd-B4 (NS)			
Sd-B5 (NS)			
Sd-C1 (NSEW)			
Sd-C2 (NS)			
Sd-C2 (EW)			
Sd-C3 (NS)			
Sd-C3 (EW)			
Sd-C4 (NS)			
Sd-C4 (EW)			

(b)EW 方向

地震動	浮上り限界転倒 モーメント ($\times 10^6 \text{kN}\cdot\text{m}$)	最小接地率算出時の 転倒モーメント ($\times 10^6 \text{kN}\cdot\text{m}$)	接地率 (%)
Sd-A (H)			
Sd-B1 (EW)			
Sd-B2 (EW)			
Sd-B3 (EW)			
Sd-B4 (EW)			
Sd-B5 (EW)			
Sd-C1 (NSEW)			
Sd-C2 (NS)			
Sd-C2 (EW)			
Sd-C3 (NS)			
Sd-C3 (EW)			
Sd-C4 (NS)			
Sd-C4 (EW)			

第 4. 1. 2-26 表 最大接地圧（弾性設計用地震動 S d , ケース No. 0）（1/2）

地震動	方向		最大接地圧 (kN/m ²)
Sd-A	NS	鉛直上向き	
		鉛直下向き	
	EW	鉛直上向き	
		鉛直下向き	
Sd-B1	NS	鉛直上向き	
		鉛直下向き	
	EW	鉛直上向き	
		鉛直下向き	
Sd-B2	NS	鉛直上向き	
		鉛直下向き	
	EW	鉛直上向き	
		鉛直下向き	
Sd-B3	NS	鉛直上向き	
		鉛直下向き	
	EW	鉛直上向き	
		鉛直下向き	
Sd-B4	NS	鉛直上向き	
		鉛直下向き	
	EW	鉛直上向き	
		鉛直下向き	
Sd-B5	NS	鉛直上向き	
		鉛直下向き	
	EW	鉛直上向き	
		鉛直下向き	

第 4. 1. 2-26 表 最大接地圧（弾性設計用地震動 Sd, ケース No. 0）（2/2）

地震動	方向		最大接地圧 (kN/m ²)
Sd-C1	NS	鉛直上向き	
		鉛直下向き	
	EW	鉛直上向き	
		鉛直下向き	
Sd-C2 (NS)	NS	鉛直上向き	
		鉛直下向き	
	EW	鉛直上向き	
		鉛直下向き	
Sd-C2 (EW)	NS	鉛直上向き	
		鉛直下向き	
	EW	鉛直上向き	
		鉛直下向き	
Sd-C3 (NS)	NS	鉛直上向き	
		鉛直下向き	
	EW	鉛直上向き	
		鉛直下向き	
Sd-C3 (EW)	NS	鉛直上向き	
		鉛直下向き	
	EW	鉛直上向き	
		鉛直下向き	
Sd-C4 (NS)	NS	—	
	EW	—	
Sd-C4 (EW)	NS	—	
	EW	—	

4.1.3 材料物性のばらつきを考慮したケースの地震応答解析結果

(1) 基準地震動 S_s

基準地震動 S_s による最大応答値を第 4.1.3-1 図～第 4.1.3-11 図及び第 4.1.3-1 表～第 4.1.3-11 表に示す。

浮上り検討を第 4.1.3-12 表及び第 4.1.3-13 表，最大接地圧を第 4.1.3-14 表及び第 4.1.3-15 表に示す。

(2) 弾性設計用地震動 S_d

弾性設計用地震動 S_d による最大応答値を第 4.1.3-12 図～第 4.1.3-22 図及び第 4.1.3-16 表～第 4.1.3-26 表に示す。

浮上り検討を第 4.1.3-27 表及び第 4.1.3-28 表，最大接地圧を第 4.1.3-29 表及び第 4.1.3-30 表に示す。

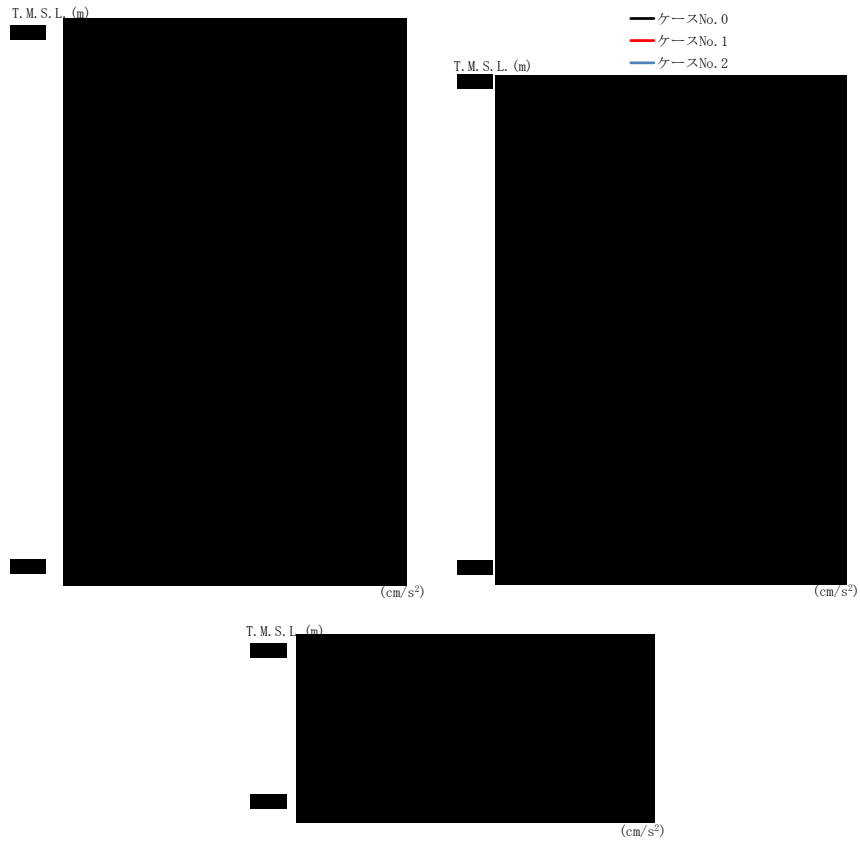

(a) S s - A (H)

第 4. 1. 3-1 図 最大応答加速度 (NS 方向) (1/8)

第 4. 1. 3-1 表 最大応答加速度一覧表 (NS 方向) (1/8)

(a) S s - A (H)

T. M. S. L. (m)	質 点 番 号	最大応答加速度 (cm/s ²)		
		ケース No. 0	ケース No. 1	ケース No. 2
[Redacted Data]				

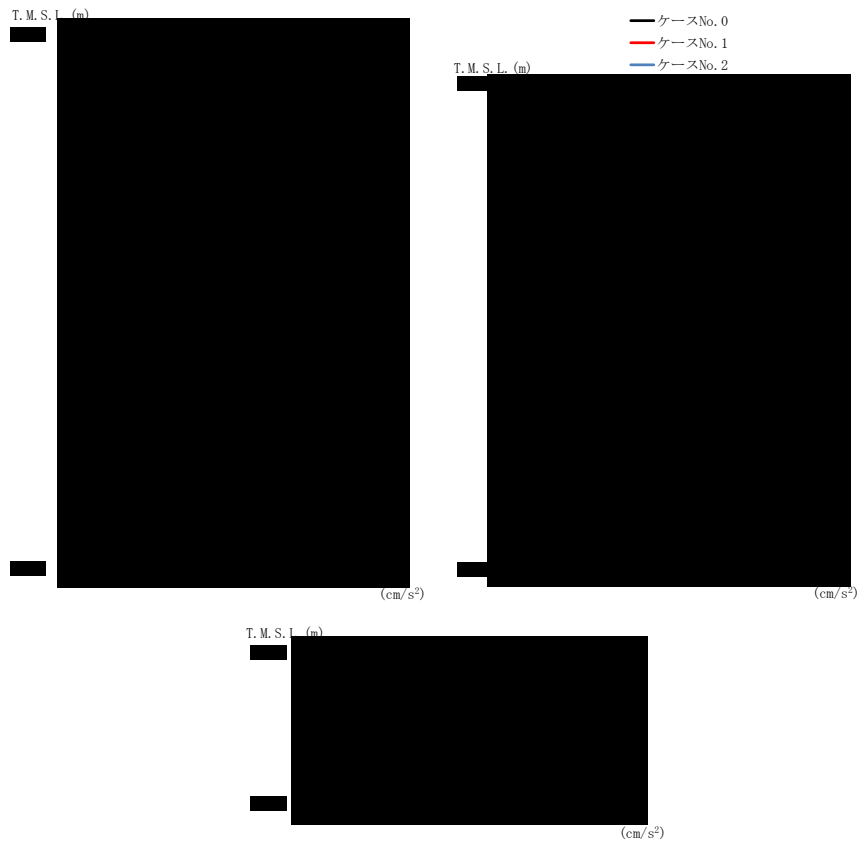

(b) S s - B 3 (NS)

第 4. 1. 3-1 図 最大応答加速度 (NS 方向) (2/8)

第 4. 1. 3-1 表 最大応答加速度一覧表 (NS 方向) (2/8)

(b) S s - B 3 (NS)

T. M. S. L. (m)	質 点 番 号	最大応答加速度 (cm/s ²)		
		ケース No. 0	ケース No. 1	ケース No. 2
[Redacted Data]				

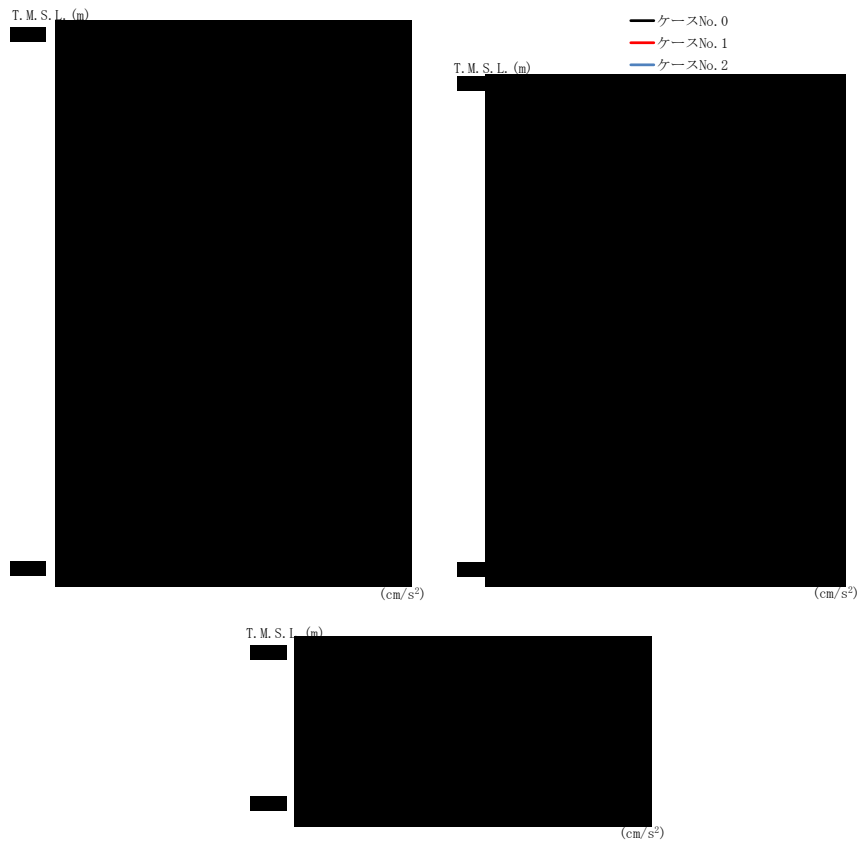

(c) S s - B 4 (NS)

第 4.1.3-1 図 最大応答加速度 (NS 方向) (3/8)

第 4.1.3-1 表 最大応答加速度一覧表 (NS 方向) (3/8)

(c) S s - B 4 (NS)

T.M.S.L. (m)	質点番号	最大応答加速度 (cm/s²)		
		ケース No. 0	ケース No. 1	ケース No. 2
0.0	0	0.0	0.0	0.0
0.5	0	0.0	0.0	0.0
1.0	0	0.0	0.0	0.0
1.5	0	0.0	0.0	0.0
2.0	0	0.0	0.0	0.0
2.5	0	0.0	0.0	0.0
3.0	0	0.0	0.0	0.0
3.5	0	0.0	0.0	0.0
4.0	0	0.0	0.0	0.0
4.5	0	0.0	0.0	0.0
5.0	0	0.0	0.0	0.0
5.5	0	0.0	0.0	0.0
6.0	0	0.0	0.0	0.0
6.5	0	0.0	0.0	0.0
7.0	0	0.0	0.0	0.0
7.5	0	0.0	0.0	0.0
8.0	0	0.0	0.0	0.0
8.5	0	0.0	0.0	0.0
9.0	0	0.0	0.0	0.0
9.5	0	0.0	0.0	0.0
10.0	0	0.0	0.0	0.0



(d) S s - C 1 (N S E W)

第 4. 1. 3-1 図 最大応答加速度 (NS 方向) (4/8)

第 4. 1. 3-1 表 最大応答加速度一覧表 (NS 方向) (4/8)

(d) S s - C 1 (N S E W)

T. M. S. L. (m)	質 点 番 号	最大応答加速度 (cm/s ²)		
		ケー ス No. 0	ケー ス No. 1	ケー ス No. 2
[Redacted Data]				



(e) S s - C 3 (NS)

第 4. 1. 3-1 図 最大応答加速度 (NS 方向) (5/8)

第 4. 1. 3-1 表 最大応答加速度一覧表 (NS 方向) (5/8)

(e) S s - C 3 (NS)

T. M. S. L. (m)	質 点 番 号	最大応答加速度 (cm/s ²)		
		ケー ス No. 0	ケー ス No. 1	ケー ス No. 2
[Redacted Data]				



(f) S s - C 3 (EW)

第 4. 1. 3-1 図 最大応答加速度 (NS 方向) (6/8)

第 4. 1. 3-1 表 最大応答加速度一覧表 (NS 方向) (6/8)

(f) S s - C 3 (EW)

T. M. S. L. (m)	質 点 番 号	最大応答加速度 (cm/s ²)		
		ケー ス No. 0	ケー ス No. 1	ケー ス No. 2
[Redacted Data]				



(g) S s - C 4 (NS)

第 4. 1. 3-1 図 最大応答加速度 (NS 方向) (7/8)

第 4. 1. 3-1 表 最大応答加速度一覧表 (NS 方向) (7/8)

(g) S s - C 4 (NS)

T. M. S. L. (m)	質 点 番 号	最大応答加速度 (cm/s ²)		
		ケース No. 0	ケース No. 1	ケース No. 2
[Redacted Data]				

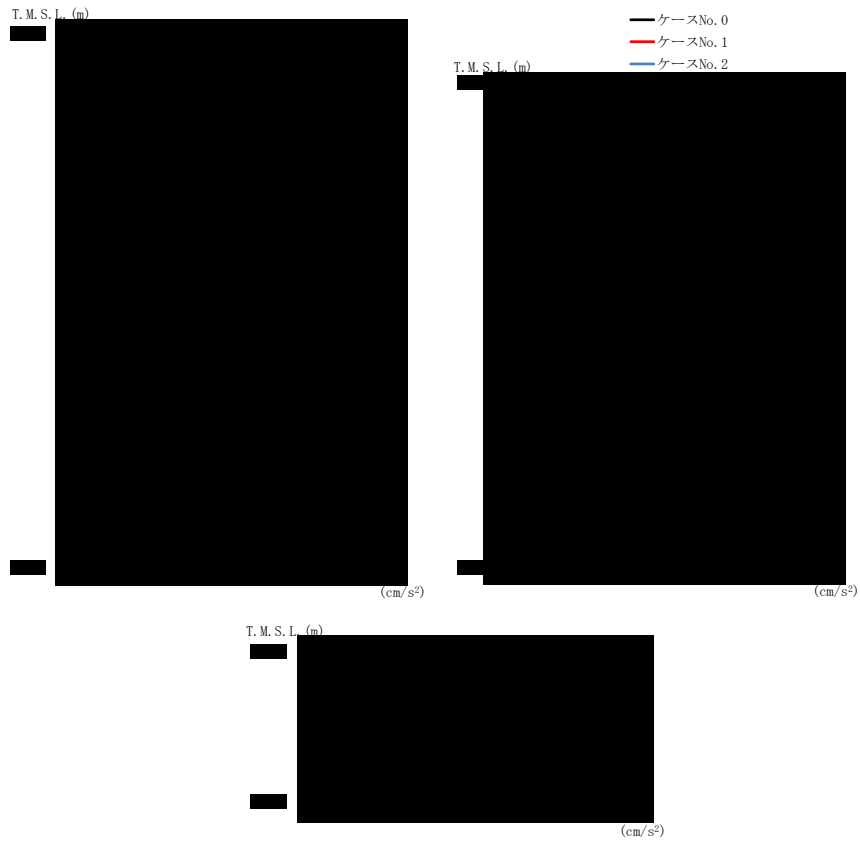

(h) S s - C 4 (EW)

第 4. 1. 3-1 図 最大応答加速度 (NS 方向) (8/8)

第 4. 1. 3-1 表 最大応答加速度一覧表 (NS 方向) (8/8)

(h) S s - C 4 (EW)

T. M. S. L. (m)	質点 番号	最大応答加速度 (cm/s ²)		
		ケース No. 0	ケース No. 1	ケース No. 2
[Redacted Data]				

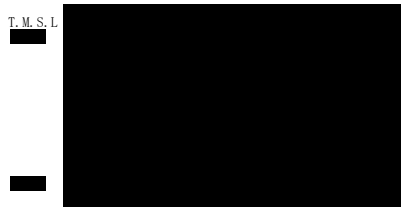

(a) S s - A (H)

第 4.1.3-2 図 最大応答変位 (NS 方向) (1/8)

第 4.1.3-2 表 最大応答変位一覧表 (NS 方向) (1/8)

(a) S s - A (H)

T. M. S. L. (m)	質 点 番 号	最大応答変位 (mm)		
		ケース No. 0	ケース No. 1	ケース No. 2
[Redacted data]				

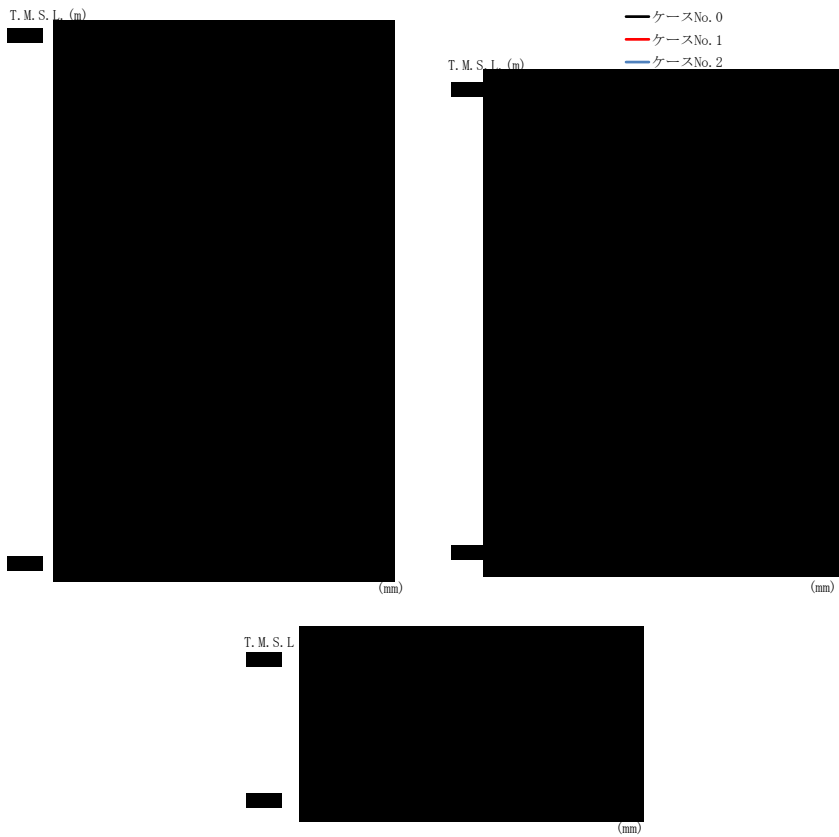

(b) S s - B 3 (NS)

第 4.1.3-2 図 最大応答変位 (NS 方向) (2/8)

第 4.1.3-2 表 最大応答変位一覧表 (NS 方向) (2/8)

(b) S s - B 3 (NS)

T. M. S. L. (m)	質 点 番 号	最大応答変位 (mm)		
		ケース No. 0	ケース No. 1	ケース No. 2
[Redacted]	[Redacted]	[Redacted]	[Redacted]	[Redacted]

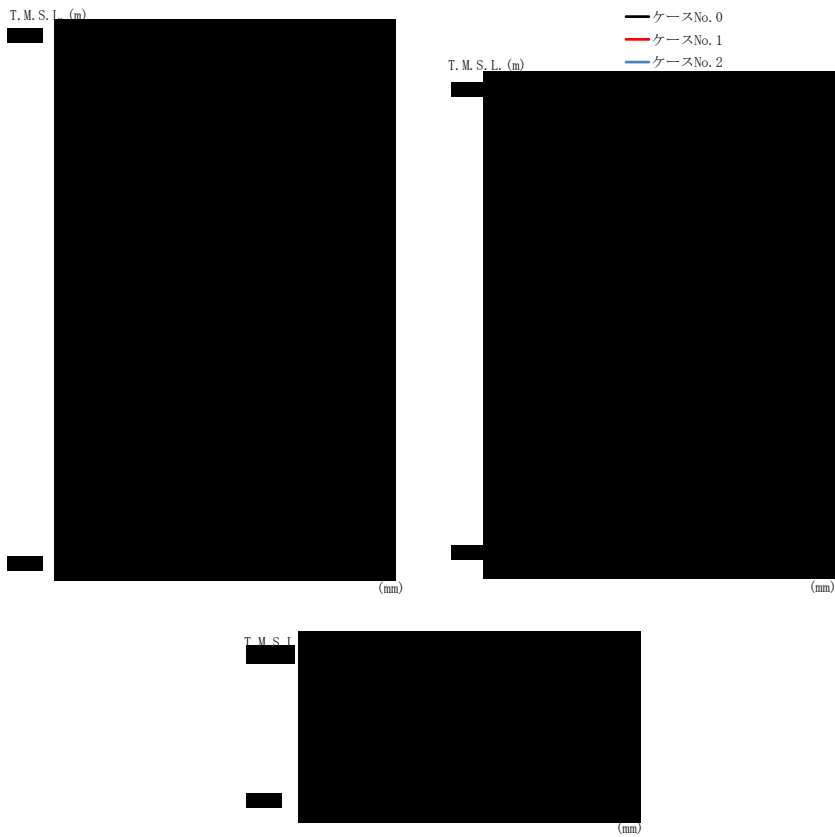

(c) S s - B 4 (N S)

第 4. 1. 3-2 図 最大応答変位 (NS 方向) (3/8)

第 4. 1. 3-2 表 最大応答変位一覧表 (NS 方向) (3/8)

(c) S s - B 4 (N S)

T. M. S. L. (m)	質 点 番 号	最大応答変位 (mm)		
		ケース No. 0	ケース No. 1	ケース No. 2

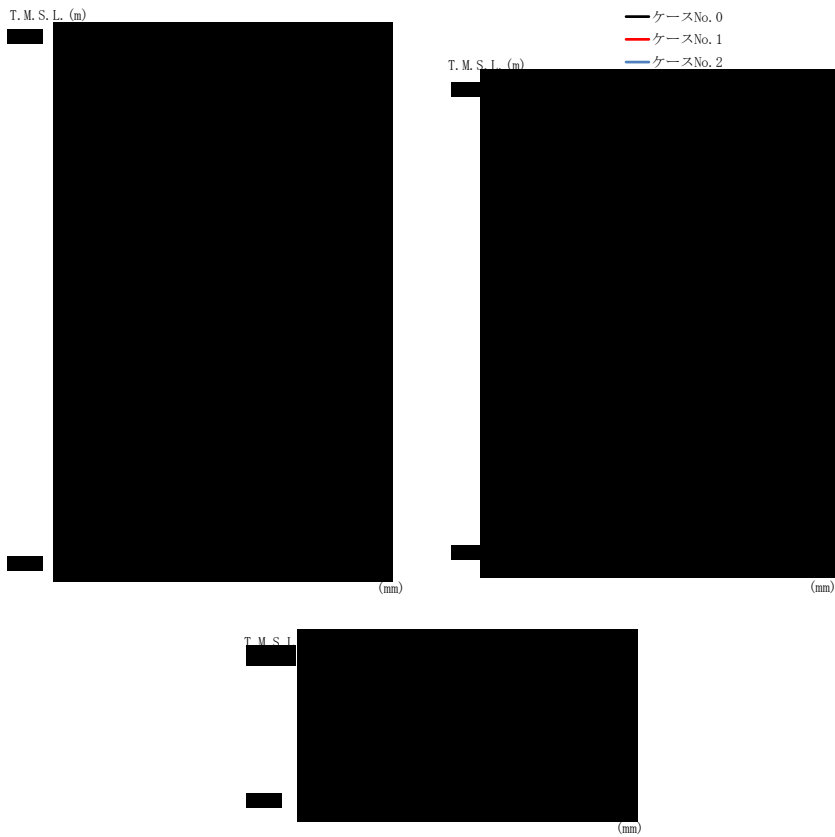

(d) S s - C 1 (NSEW)

第 4.1.3-2 図 最大応答変位 (NS 方向) (4/8)

第 4.1.3-2 表 最大応答変位一覧表 (NS 方向) (4/8)

(d) S s - C 1 (NSEW)

T. M. S. L. (m)	質 点 番 号	最大応答変位 (mm)		
		ケース No. 0	ケース No. 1	ケース No. 2



(e) S s - C 3 (NS)

第 4. 1. 3-2 図 最大応答変位 (NS 方向) (5/8)

第 4. 1. 3-2 表 最大応答変位一覧表 (NS 方向) (5/8)

(e) S s - C 3 (NS)

T. M. S. L. (m)	質 点 番 号	最大応答変位 (mm)		
		ケース No. 0	ケース No. 1	ケース No. 2

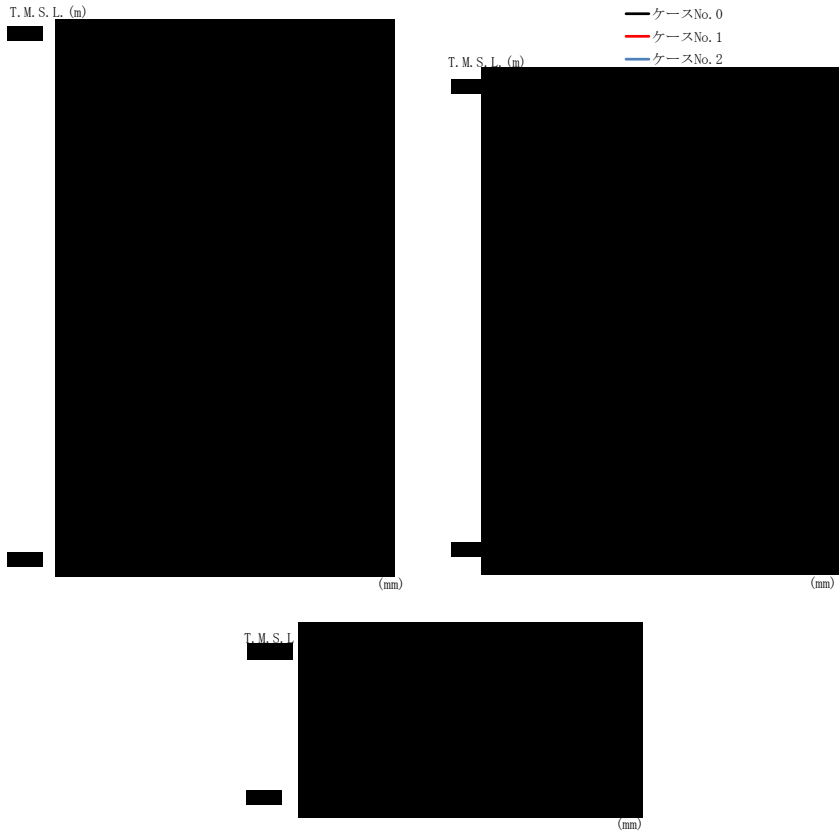

(f) S s - C 3 (EW)

第 4.1.3-2 図 最大応答変位 (NS 方向) (6/8)

第 4.1.3-2 表 最大応答変位一覧表 (NS 方向) (6/8)

(f) S s - C 3 (EW)

T. M. S. L. (m)	質 点 番 号	最大応答変位 (mm)		
		ケース No. 0	ケース No. 1	ケース No. 2
[Redacted Data]				

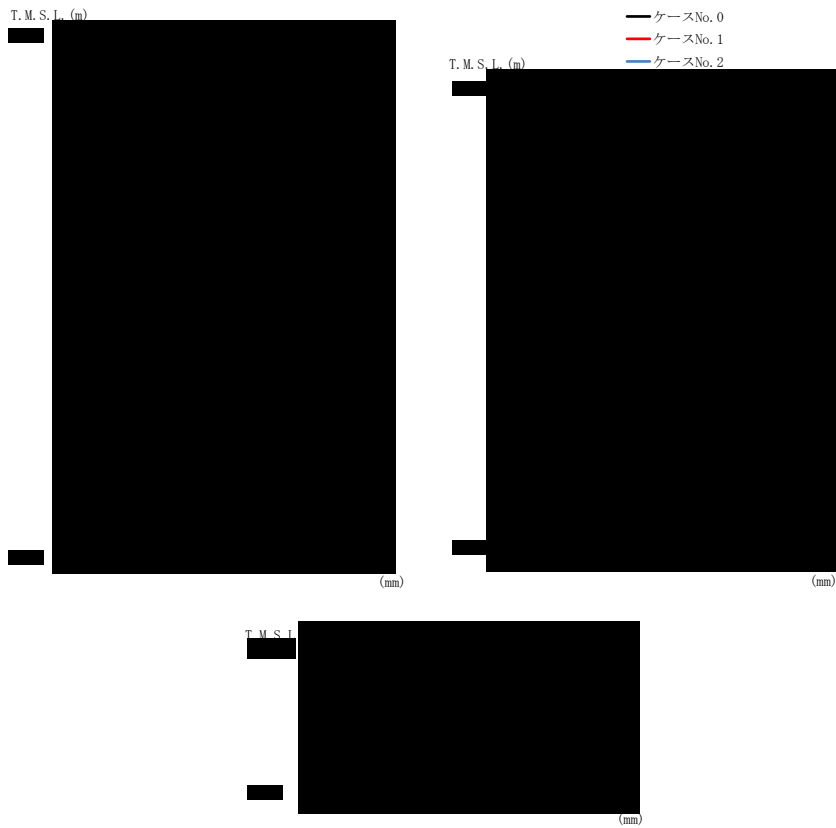

(g) S s - C 4 (NS)

第 4.1.3-2 図 最大応答変位 (NS 方向) (7/8)

第 4.1.3-2 表 最大応答変位一覧表 (NS 方向) (7/8)

(g) S s - C 4 (NS)

T. M. S. L. (m)	質 点 番 号	最大応答変位 (mm)		
		ケース No. 0	ケース No. 1	ケース No. 2
[Redacted Data]				

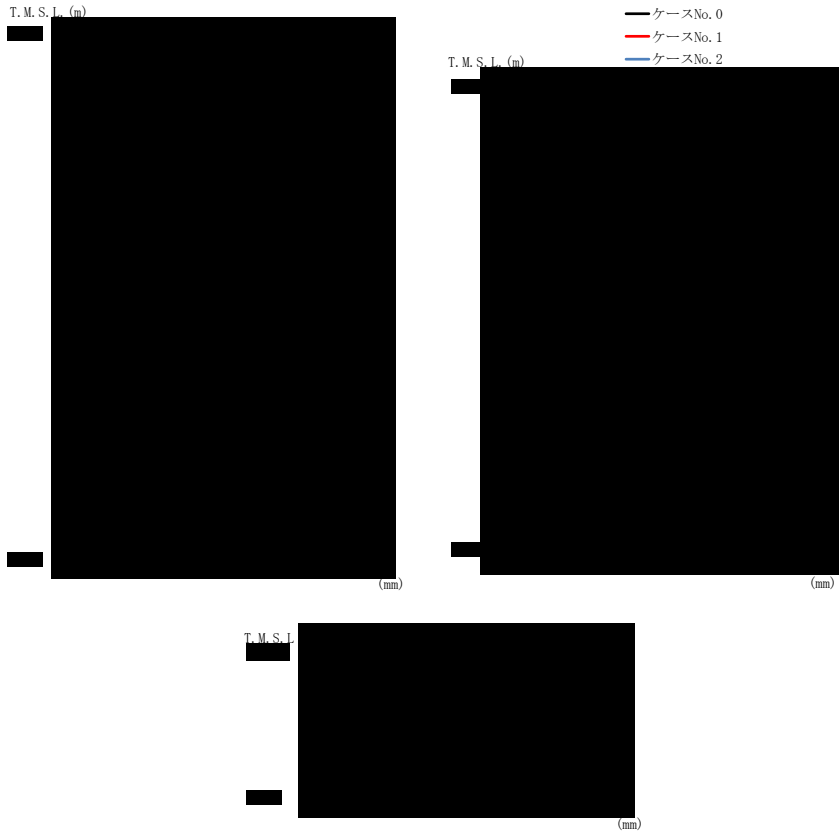

(h) S s - C 4 (E W)

第 4. 1. 3-2 図 最大応答変位 (NS 方向) (8 / 8)

第 4. 1. 3-2 表 最大応答変位一覧表 (NS 方向) (8 / 8)

(h) S s - C 4 (E W)

T. M. S. L. (m)	質 点 番 号	最大応答変位 (mm)		
		ケース No. 0	ケース No. 1	ケース No. 2
[Redacted Data]				

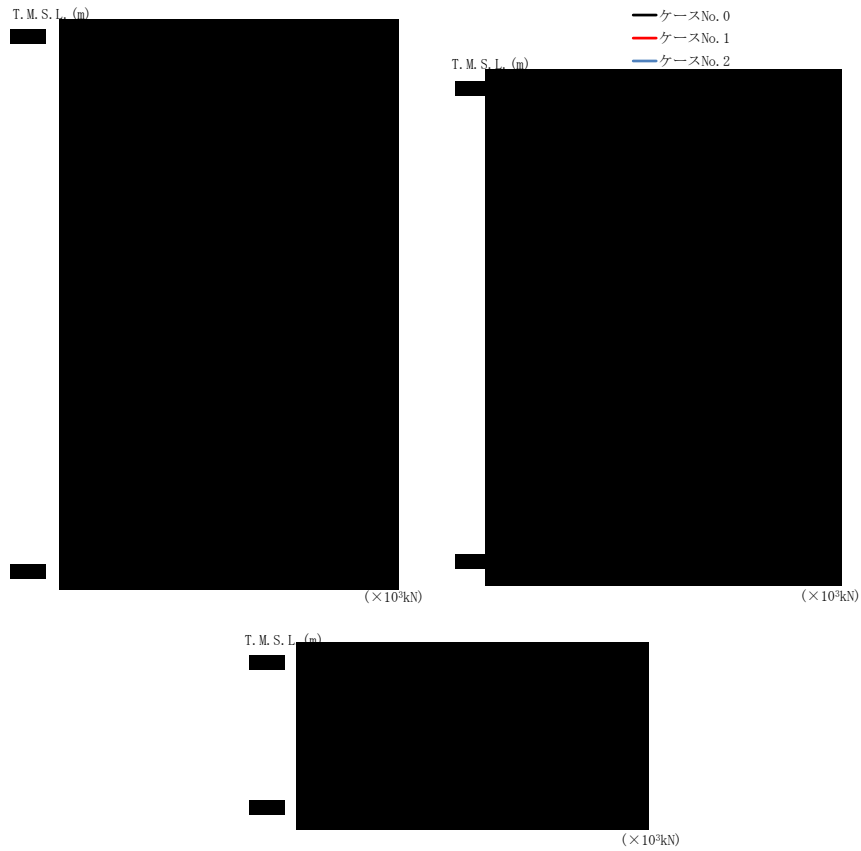

(a) S s - A (H)

第 4. 1. 3-3 図 最大応答せん断力 (NS 方向) (1/8)

第 4. 1. 3-3 表 最大応答せん断力一覧表 (NS 方向) (1/8)

(a) S s - A (H)

T. M. S. L. (m)	要素 番号	最大応答せん断力 (× 10 ³ kN)		
		ケース No. 0	ケース No. 1	ケース No. 2
[Redacted Data]				



(b) S s - B 3 (NS)

第 4. 1. 3-3 図 最大応答せん断力 (NS 方向) (2/8)

第 4. 1. 3-3 表 最大応答せん断力一覧表 (NS 方向) (2/8)

(b) S s - B 3 (NS)

T. M. S. L. (m)	要素 番号	最大応答せん断力 (×10 ³ kN)		
		ケース No. 0	ケース No. 1	ケース No. 2
[Redacted Data]				

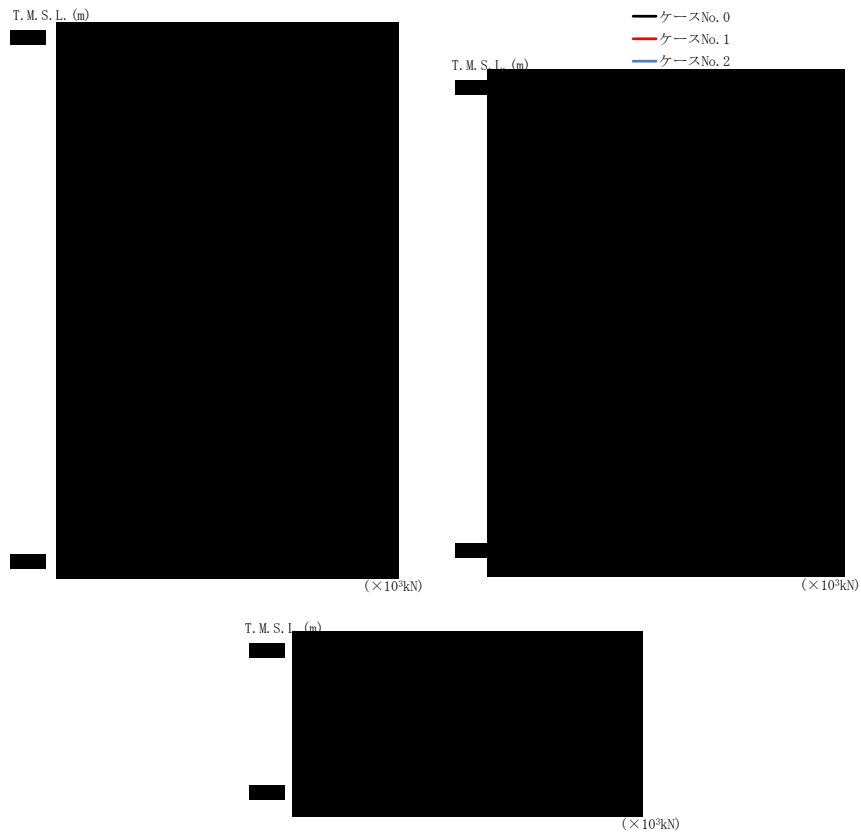

(c) S s - B 4 (NS)

第 4.1.3-3 図 最大応答せん断力 (NS 方向) (3/8)

第 4.1.3-3 表 最大応答せん断力一覧表 (NS 方向) (3/8)

(c) S s - B 4 (NS)

T. M. S. L. (m)	要素 番号	最大応答せん断力 (×10 ³ kN)		
		ケース No. 0	ケース No. 1	ケース No. 2



(d) S s - C 1 (N S E W)

第 4. 1. 3-3 図 最大応答せん断力 (NS 方向) (4/8)

第 4. 1. 3-3 表 最大応答せん断力一覧表 (NS 方向) (4/8)

(d) S s - C 1 (N S E W)

T. M. S. L. (m)	要素 番号	最大応答せん断力 (×10 ³ kN)		
		ケース No. 0	ケース No. 1	ケース No. 2
[Redacted Data]				



(e) S s - C 3 (NS)

第 4. 1. 3-3 図 最大応答せん断力 (NS 方向) (5/8)

第 4. 1. 3-3 表 最大応答せん断力一覧表 (NS 方向) (5/8)

(e) S s - C 3 (NS)

T. M. S. L. (m)	要素 番号	最大応答せん断力 (×10 ³ kN)		
		ケース No. 0	ケース No. 1	ケース No. 2
[Redacted data]				



(f) S s - C 3 (EW)

第 4. 1. 3-3 図 最大応答せん断力 (NS 方向) (6/8)

第 4. 1. 3-3 表 最大応答せん断力一覧表 (NS 方向) (6/8)

(f) S s - C 3 (EW)

T. M. S. L. (m)	要素 番号	最大応答せん断力 (×10 ³ kN)		
		ケース No. 0	ケース No. 1	ケース No. 2
[Redacted Data]				



(g) S s - C 4 (NS)

第 4. 1. 3-3 図 最大応答せん断力 (NS 方向) (7/8)

第 4. 1. 3-3 表 最大応答せん断力一覧表 (NS 方向) (7/8)

(g) S s - C 4 (NS)

T. M. S. L. (m)	要素 番号	最大応答せん断力 (×10 ³ kN)		
		ケース No. 0	ケース No. 1	ケース No. 2
[Redacted Data]				



(h) S s - C 4 (E W)

第 4. 1. 3-3 図 最大応答せん断力 (NS 方向) (8/8)

第 4. 1. 3-3 表 最大応答せん断力一覧表 (NS 方向) (8/8)

(h) S s - C 4 (E W)

T. M. S. L. (m)	要素 番号	最大応答せん断力 (×10 ³ kN)		
		ケース No. 0	ケース No. 1	ケース No. 2

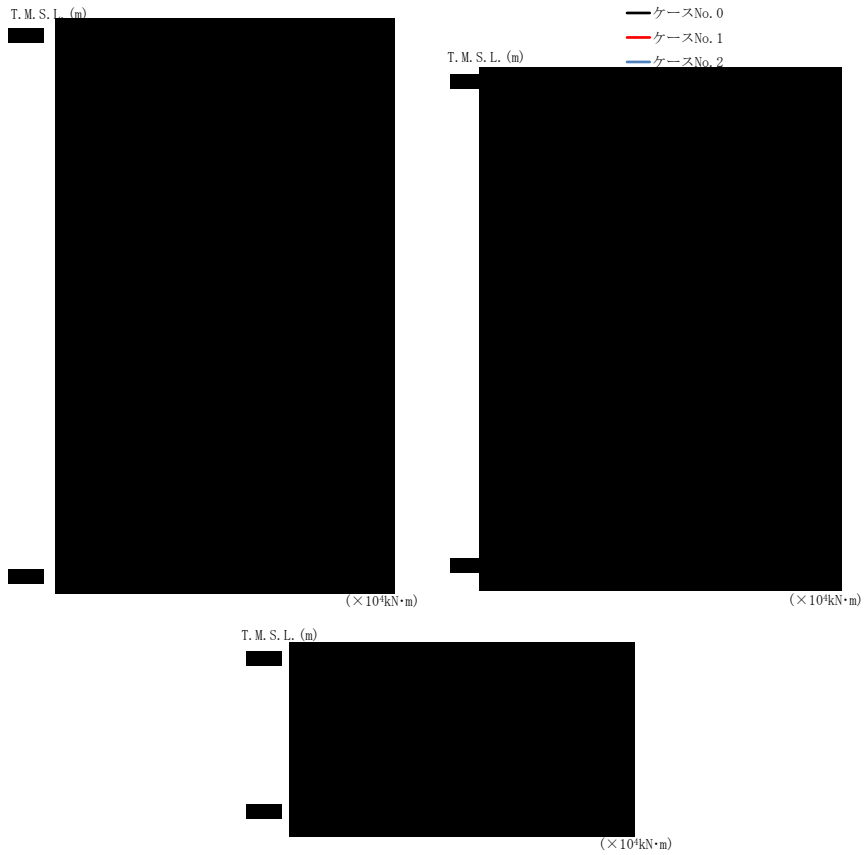

(a) S s - A (H)

第 4. 1. 3-4 図 最大応答曲げモーメント (NS 方向) (1/8)

第 4. 1. 3-4 表 最大応答曲げモーメント一覧表 (NS 方向) (1/8)

(a) S s - A (H)

T.M.S.L. (m)	要素 番号	最大応答曲げモーメント(×10 ⁴ kN·m)		
		ケース No. 0	ケース No. 1	ケース No. 2
[Redacted data]				

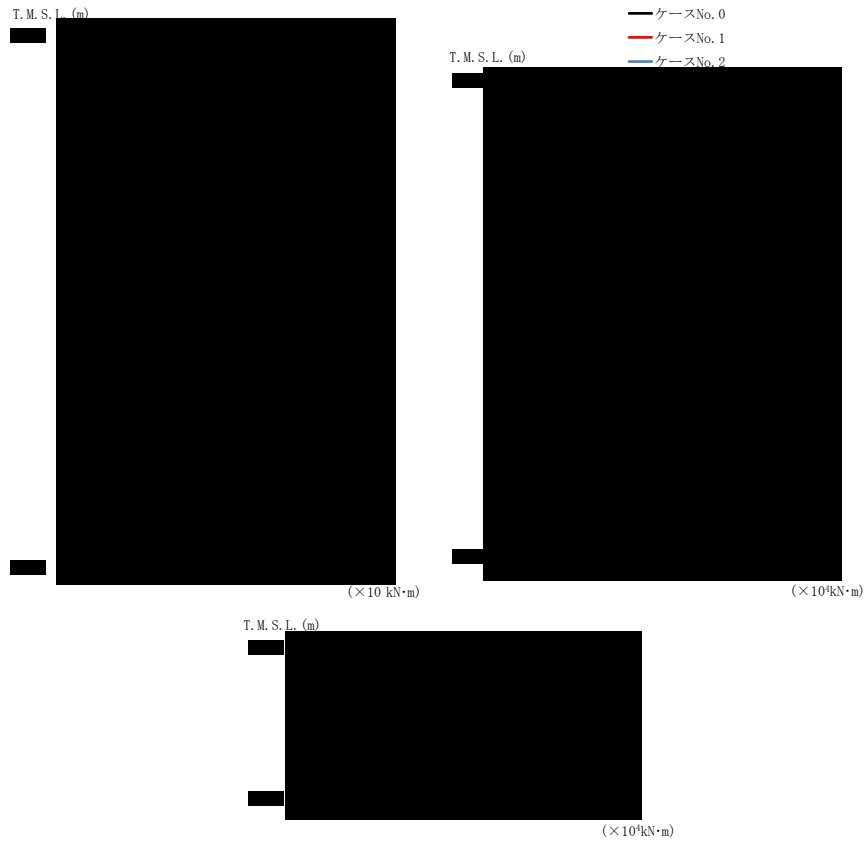

(b) S s - B 3 (NS)

第 4.1.3-4 図 最大応答曲げモーメント (NS 方向) (2/8)

第 4.1.3-4 表 最大応答曲げモーメント一覧表 (NS 方向) (2/8)

(b) S s - B 3 (NS)

T. M. S. L. (m)	要素 番号	最大応答曲げモーメント (×10 ⁴ kN·m)		
		ケース No. 0	ケース No. 1	ケース No. 2
[Redacted data]				

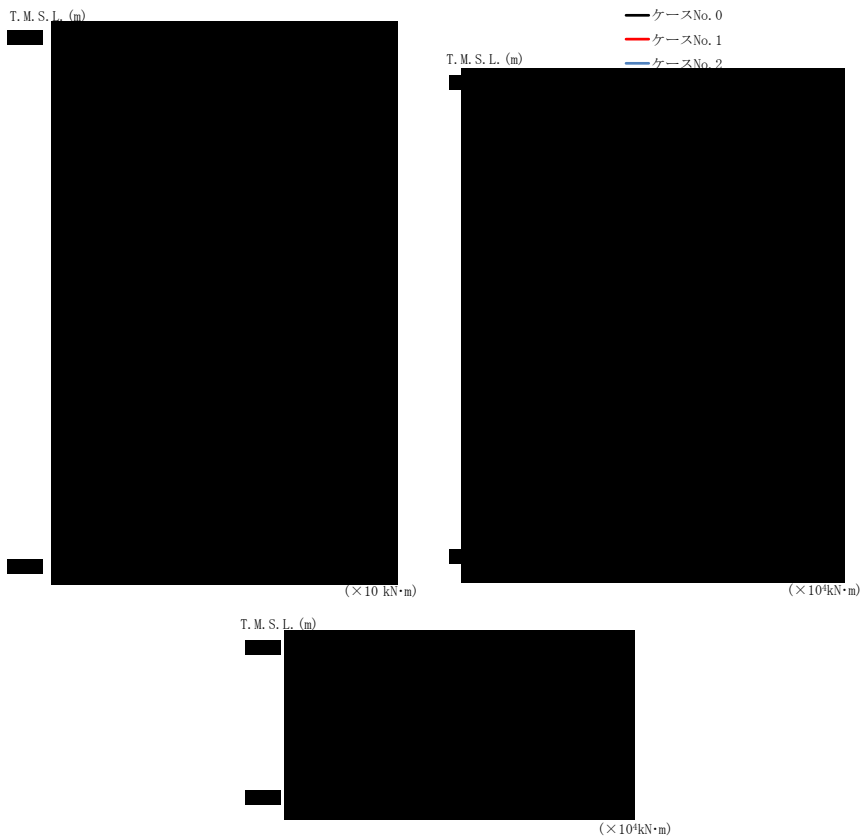

(c) S s - B 4 (NS)

第 4. 1. 3-4 図 最大応答曲げモーメント (NS 方向) (3/8)

第 4. 1. 3-4 表 最大応答曲げモーメント一覧表 (NS 方向) (3/8)

(c) S s - B 4 (NS)

T. M. S. L. (m)	要素 番号	最大応答曲げモーメント (×10 ⁴ kN·m)		
		ケース No. 0	ケース No. 1	ケース No. 2
[Redacted Data]				

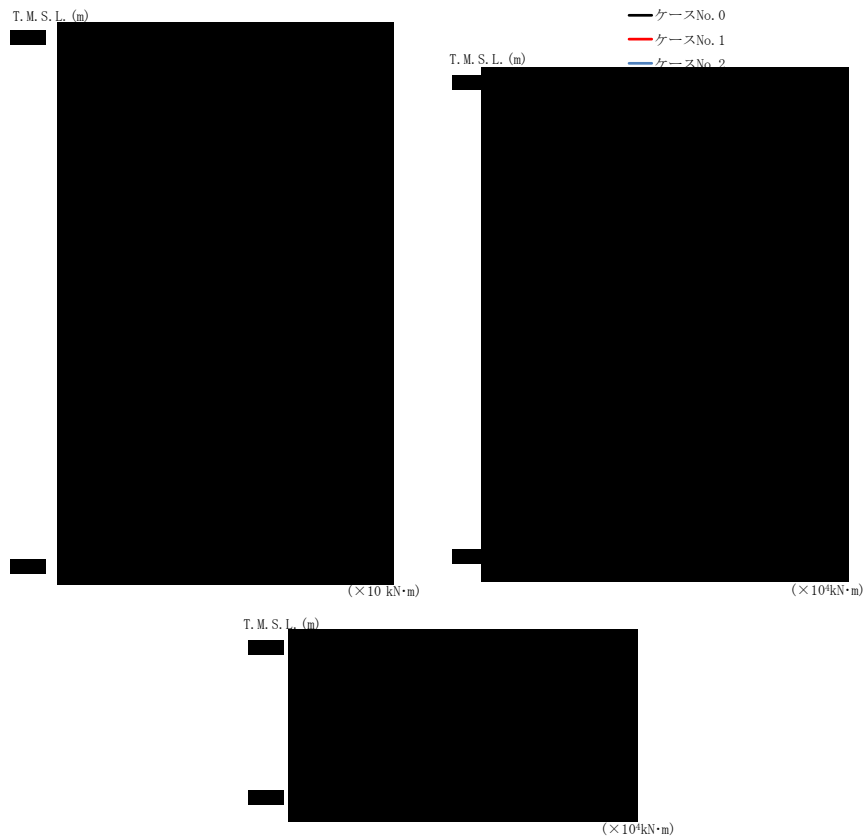

(d) S s - C 1 (N S E W)

第 4. 1. 3-4 図 最大応答曲げモーメント (NS 方向) (4/8)

第 4. 1. 3-4 表 最大応答曲げモーメント一覧表 (NS 方向) (4/8)

(d) S s - C 1 (N S E W)

T. M. S. L. (m)	要素 番号	最大応答曲げモーメント (×10 ⁴ kN·m)		
		ケース No. 0	ケース No. 1	ケース No. 2
[Redacted Data]				

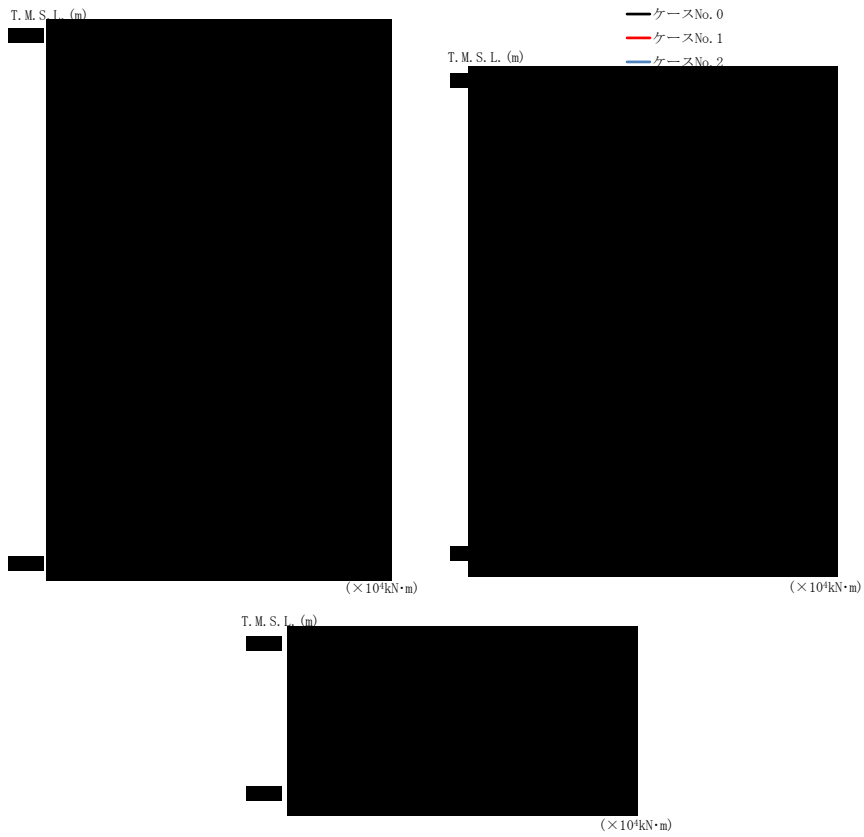

(e) S s - C 3 (NS)

第 4. 1. 3-4 図 最大応答曲げモーメント (NS 方向) (5/8)

第 4. 1. 3-4 表 最大応答曲げモーメント一覧表 (NS 方向) (5/8)

(e) S s - C 3 (NS)

T.M.S.L. (m)	要素 番号	最大応答曲げモーメント (×10 ⁴ kN·m)		
		ケース No. 0	ケース No. 1	ケース No. 2

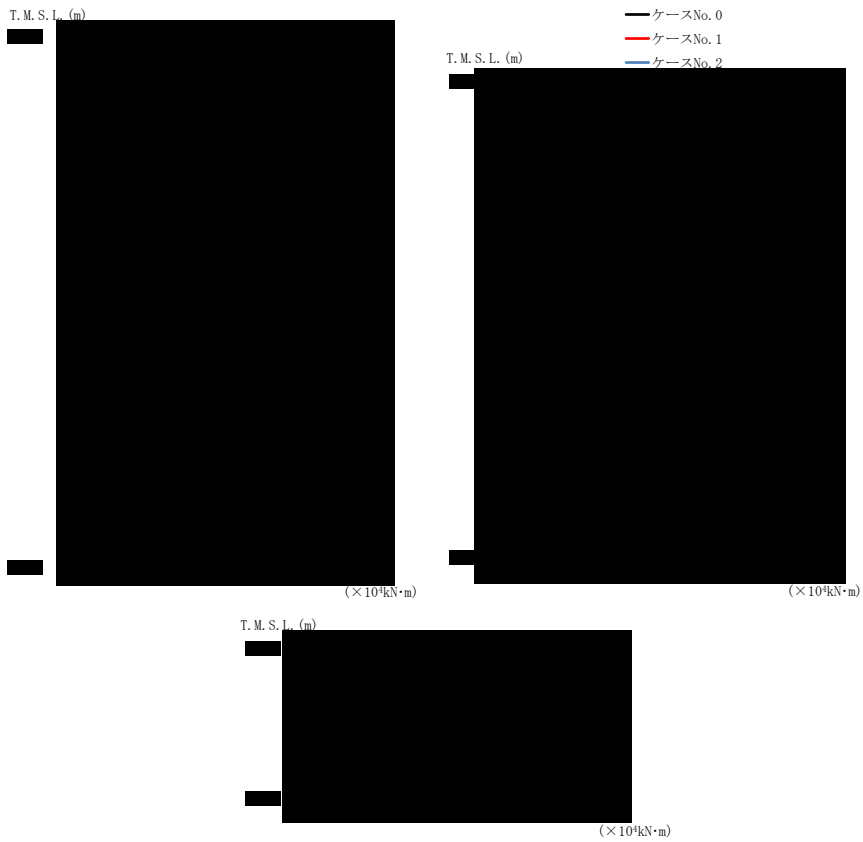

(f) S s - C 3 (EW)

第 4. 1. 3-4 図 最大応答曲げモーメント (NS 方向) (6/8)

第 4. 1. 3-4 表 最大応答曲げモーメント一覧表 (NS 方向) (6/8)

(f) S s - C 3 (EW)

T. M. S. L. (m)	要素 番号	最大応答曲げモーメント (×10 ⁴ kN·m)		
		ケース No. 0	ケース No. 1	ケース No. 2
[Redacted data]				



(g) S s - C 4 (NS)

第 4.1.3-4 図 最大応答曲げモーメント (NS 方向) (7/8)

第 4.1.3-4 表 最大応答曲げモーメント一覧表 (NS 方向) (7/8)

(g) S s - C 4 (NS)

T.M.S.L. (m)	要素 番号	最大応答曲げモーメント (×10 ⁴ kN·m)		
		ケース No. 0	ケース No. 1	ケース No. 2
[Redacted Data]				

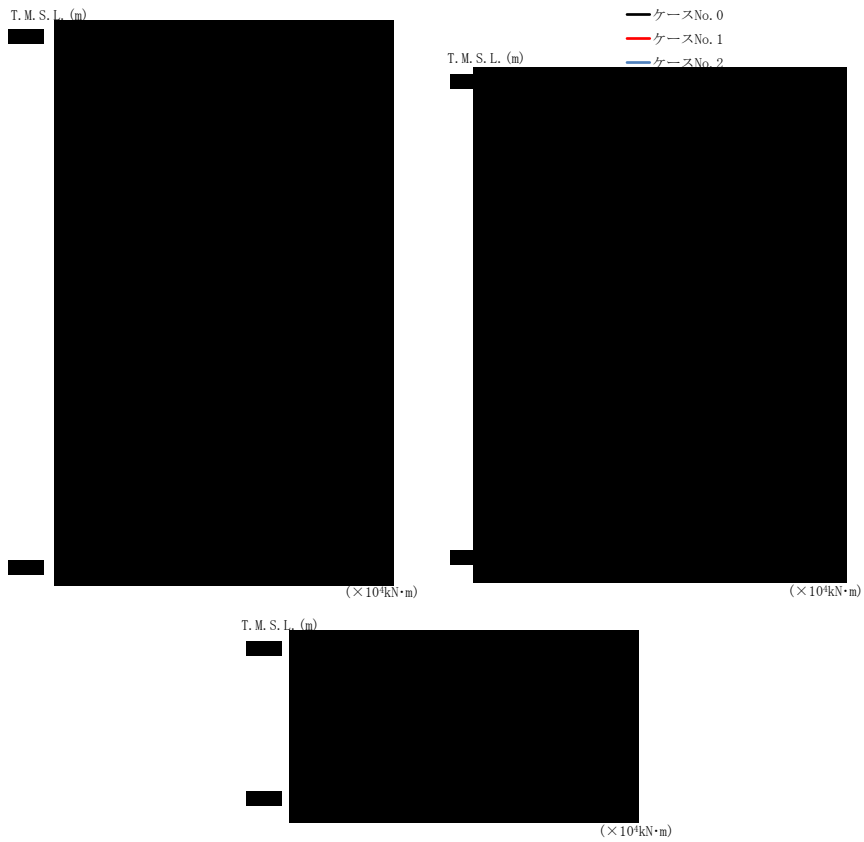

(h) S s - C 4 (E W)

第 4. 1. 3-4 図 最大応答曲げモーメント (NS 方向) (8/8)

第 4. 1. 3-4 表 最大応答曲げモーメント一覧表 (NS 方向) (8/8)

(h) S s - C 4 (E W)

T. M. S. L. (m)	要素 番号	最大応答曲げモーメント (×10 ⁴ kN·m)		
		ケース No. 0	ケース No. 1	ケース No. 2
[Redacted data]				



(a) S s - A (H)

第 4. 1. 3-5 図 最大応答加速度 (EW 方向) (1/8)

第 4. 1. 3-5 表 最大応答加速度一覧表 (EW 方向) (1/8)

(a) S s - A (H)

T. M. S. L. (m)	質点番号	最大応答加速度 (cm/s ²)		
		ケース No. 0	ケース No. 1	ケース No. 2
[Redacted Data]				

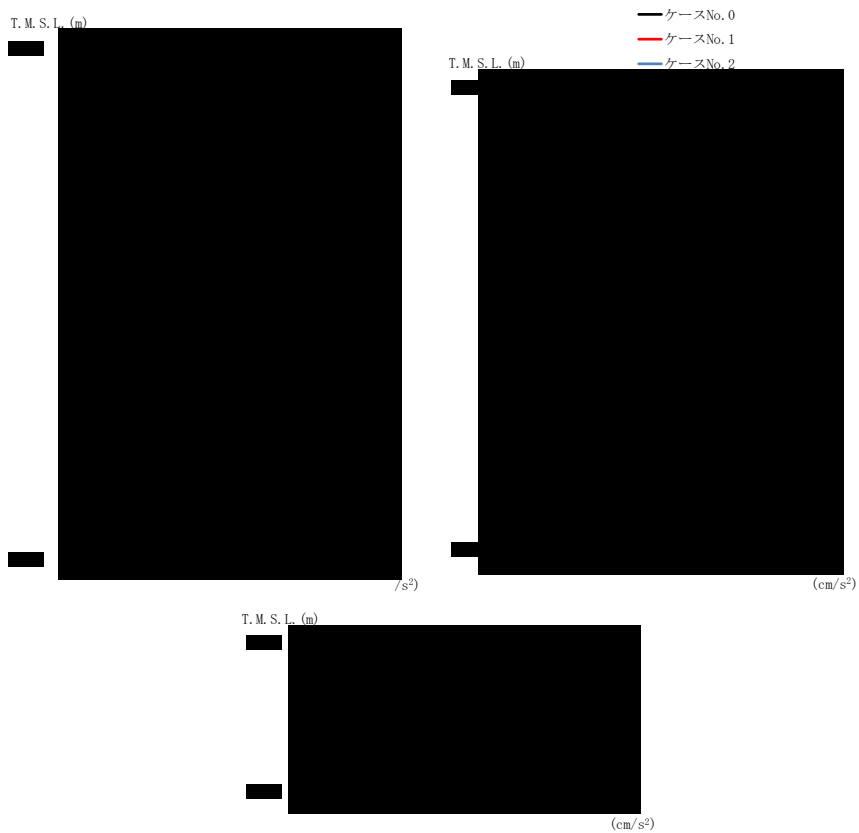

(b) S s - B 3 (EW)

第 4. 1. 3-5 図 最大応答加速度 (EW 方向) (2/8)

第 4. 1. 3-5 表 最大応答加速度一覧表 (EW 方向) (2/8)

(b) S s - B 3 (EW)

T. M. S. L. (m)	質点 番号	最大応答加速度 (cm/s ²)		
		ケース No. 0	ケース No. 1	ケース No. 2
[Redacted Data]				

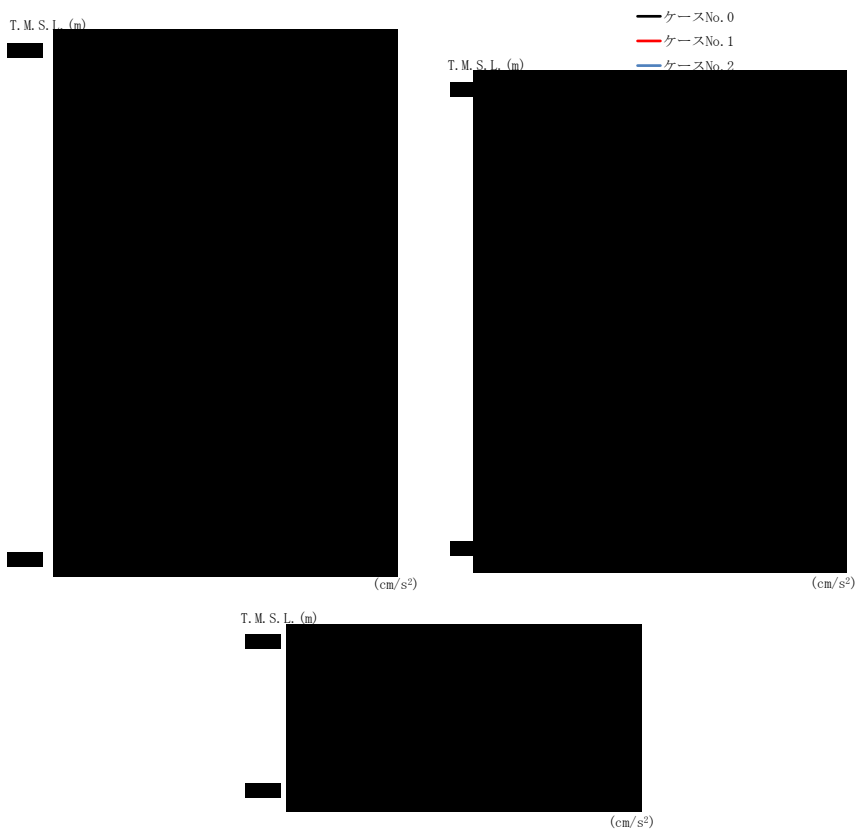

(c) S s - B 4 (EW)

第 4. 1. 3-5 図 最大応答加速度 (EW 方向) (3/8)

第 4. 1. 3-5 表 最大応答加速度一覧表 (EW 方向) (3/8)

(c) S s - B 4 (EW)

T. M. S. L. (m)	質 点 番 号	最大応答加速度 (cm/s ²)		
		ケース No. 0	ケース No. 1	ケース No. 2
[Redacted Data]				

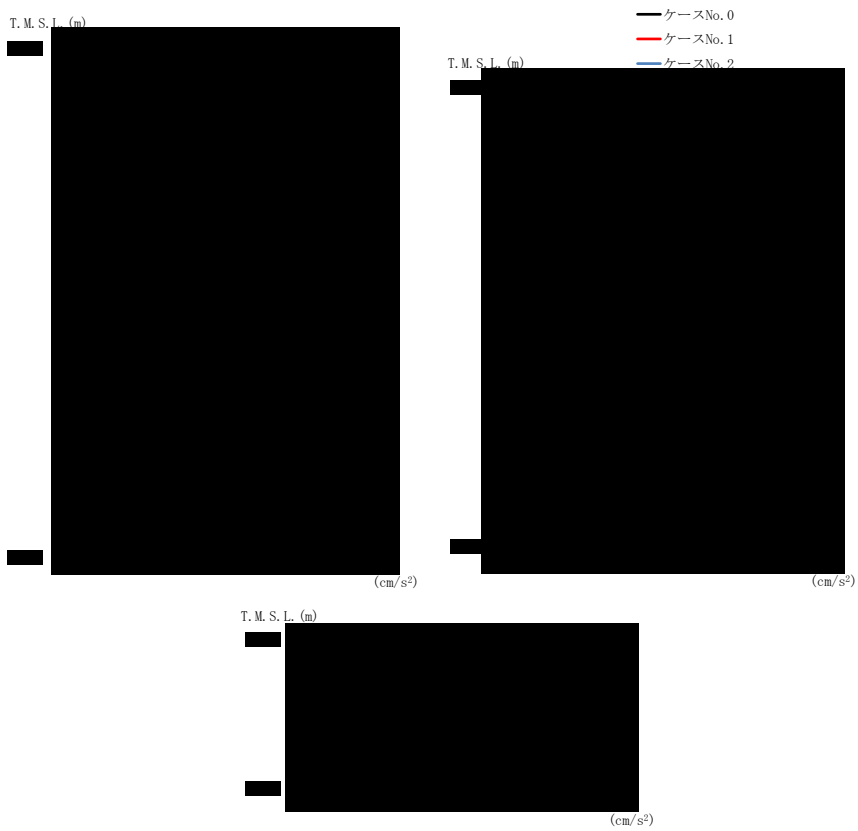

(d) S s - C 1 (N S E W)

第 4. 1. 3-5 図 最大応答加速度 (EW 方向) (4/8)

第 4. 1. 3-5 表 最大応答加速度一覧表 (EW 方向) (4/8)

(d) S s - C 1 (N S E W)

T. M. S. L. (m)	質 点 番 号	最大応答加速度 (cm/s ²)		
		ケース No. 0	ケース No. 1	ケース No. 2
[Redacted Data]				

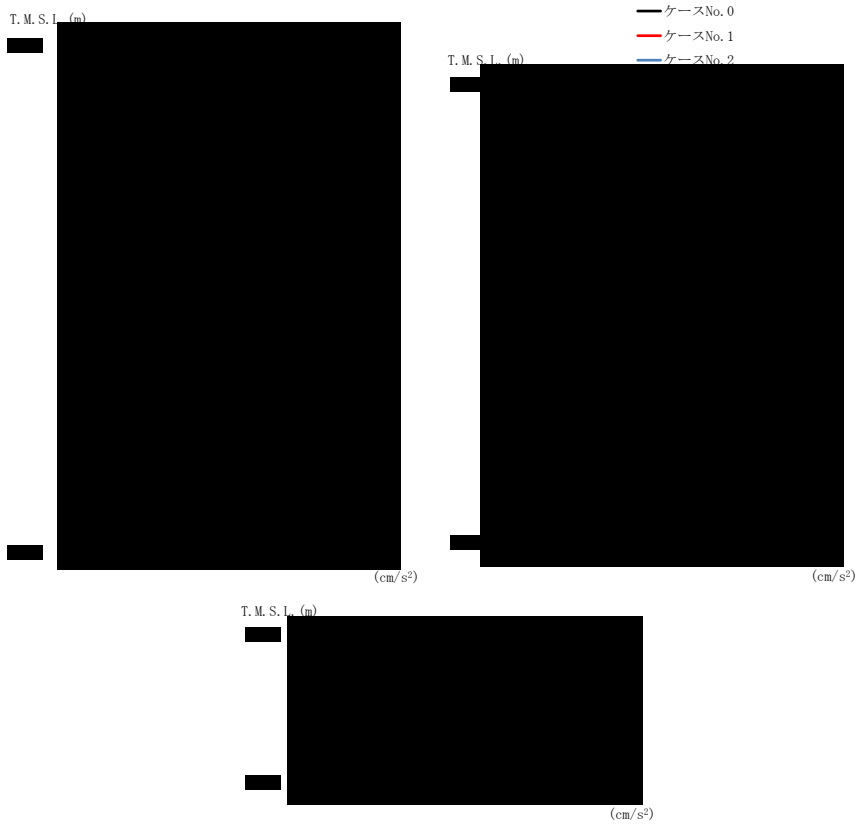

(e) S s - C 3 (NS)

第 4. 1. 3-5 図 最大応答加速度 (EW 方向) (5/8)

第 4. 1. 3-5 表 最大応答加速度一覧表 (EW 方向) (5/8)

(e) S s - C 3 (NS)

T. M. S. L. (m)	質 点 番 号	最大応答加速度 (cm/s ²)		
		ケース No. 0	ケース No. 1	ケース No. 2
[Redacted Data]				



(f) S s - C 3 (EW)

第 4. 1. 3-5 図 最大応答加速度 (EW 方向) (6/8)

第 4. 1. 3-5 表 最大応答加速度一覧表 (EW 方向) (6/8)

(f) S s - C 3 (EW)

T. M. S. L. (m)	質 点 番 号	最大応答加速度 (cm/s ²)		
		ケース No. 0	ケース No. 1	ケース No. 2
[Redacted Data]				

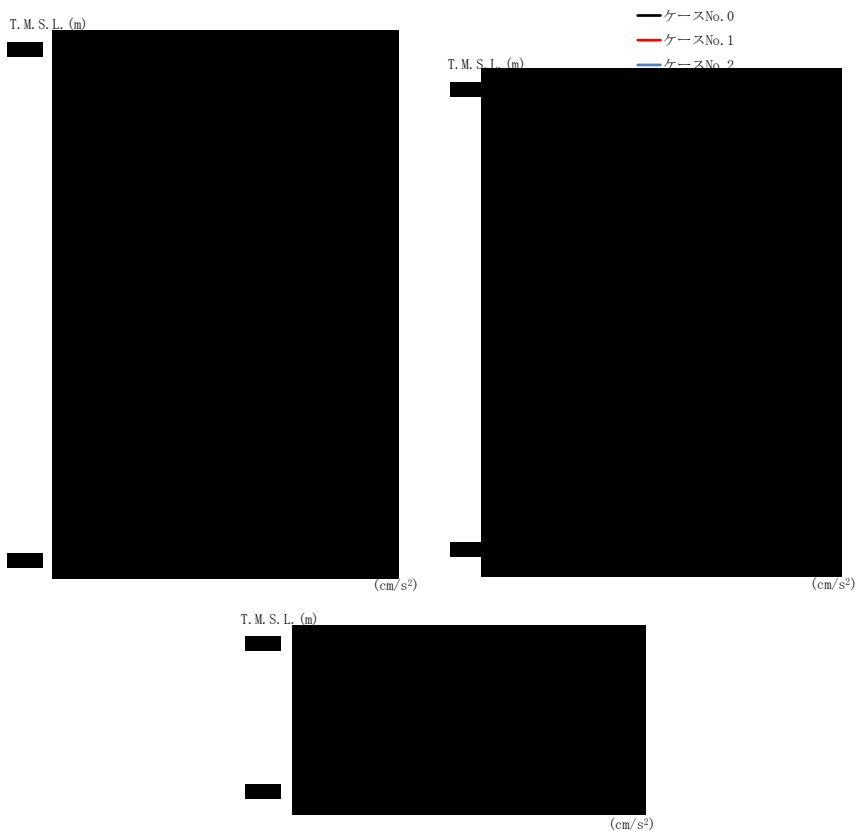

(g) S s - C 4 (NS)

第 4. 1. 3-5 図 最大応答加速度 (EW 方向) (7/8)

第 4. 1. 3-5 表 最大応答加速度一覧表 (EW 方向) (7/8)

(g) S s - C 4 (NS)

T. M. S. L. (m)	質点 番号	最大応答加速度 (cm/s ²)		
		ケース No. 0	ケース No. 1	ケース No. 2
[Redacted Data]				

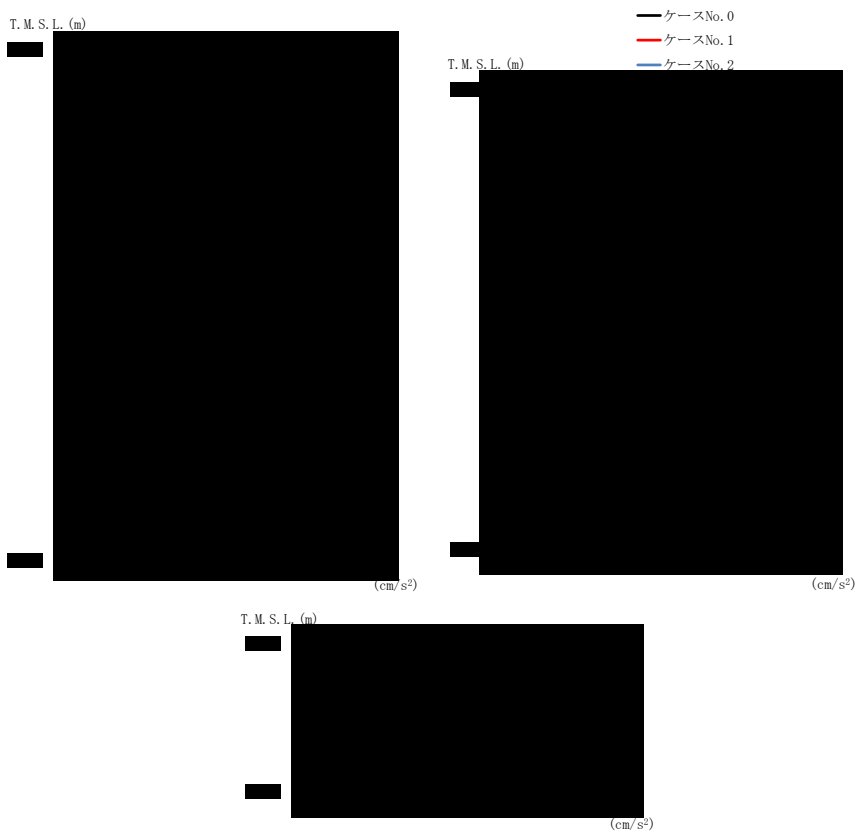

(h) S s - C 4 (EW)

第 4. 1. 3-5 図 最大応答加速度 (EW 方向) (8/8)

第 4. 1. 3-5 表 最大応答加速度一覧表 (EW 方向) (8/8)

(h) S s - C 4 (EW)

T. M. S. L. (m)	質 点 番 号	最大応答加速度 (cm/s ²)		
		ケース No. 0	ケース No. 1	ケース No. 2
[Redacted Data]				

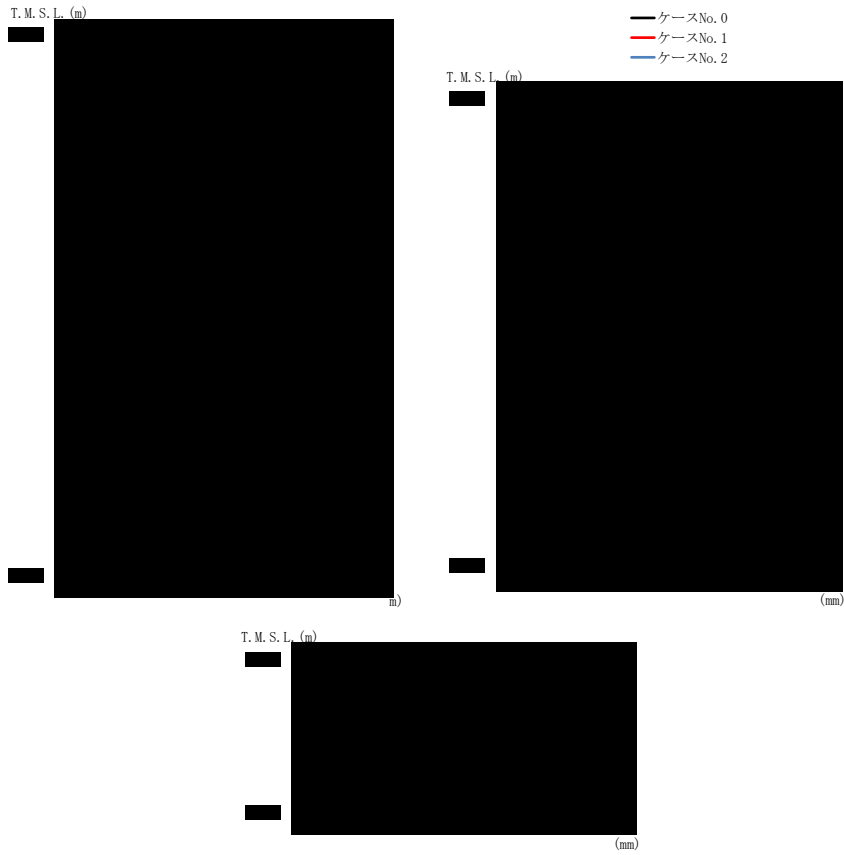

(a) S s - A (H)

第 4. 1. 3-6 図 最大応答変位 (EW 方向) (1/8)

第 4. 1. 3-6 表 最大応答変位一覧表 (EW 方向) (1/8)

(a) S s - A (H)

T. M. S. L. (m)	質 点 番 号	最大応答変位 (mm)		
		ケース No. 0	ケース No. 1	ケース No. 2

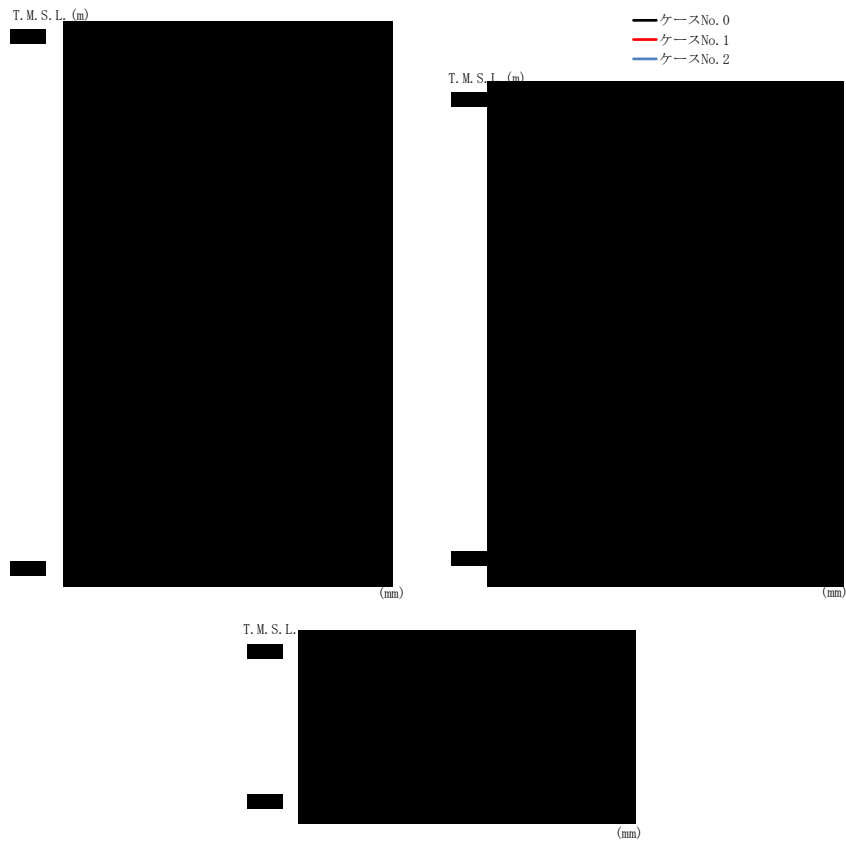

(b) S s - B 3 (EW)

第 4.1.3-6 図 最大応答変位 (EW 方向) (2/8)

第 4.1.3-6 表 最大応答変位一覧表 (EW 方向) (2/8)

(b) S s - B 3 (EW)

T.M.S.L. (m)	質 点 番 号	最大応答変位 (mm)		
		ケース No. 0	ケース No. 1	ケース No. 2

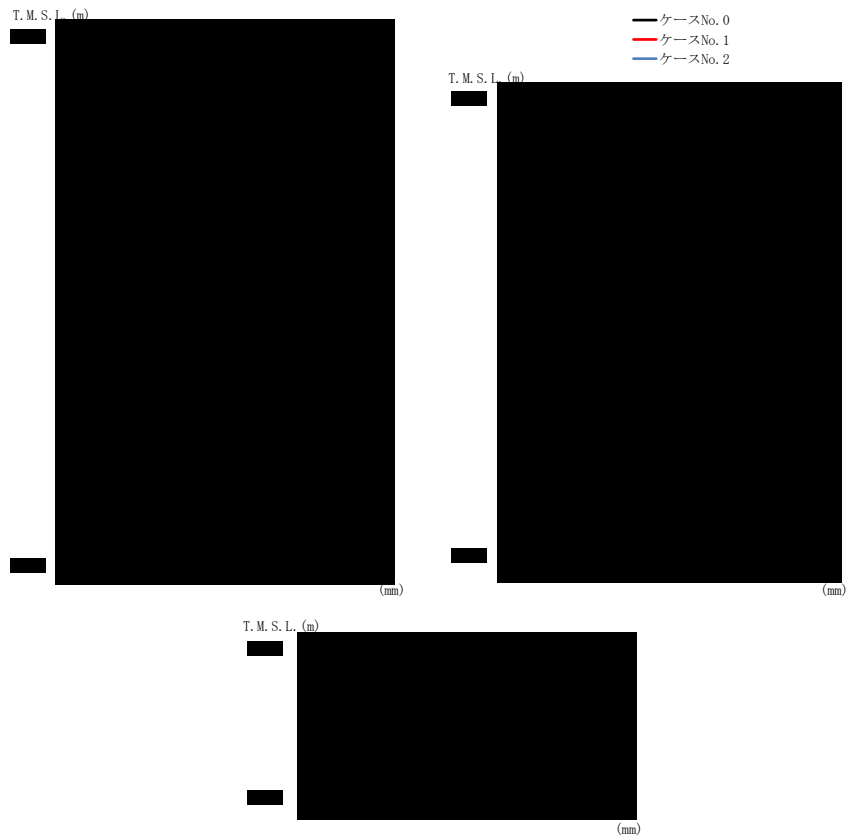

(c) S s - B 4 (EW)

第 4. 1. 3-6 図 最大応答変位 (EW 方向) (3/8)

第 4. 1. 3-6 表 最大応答変位一覧表 (EW 方向) (3/8)

(c) S s - B 4 (EW)

T. M. S. L. (m)	質 点 番 号	最大応答変位 (mm)		
		ケース No. 0	ケース No. 1	ケース No. 2

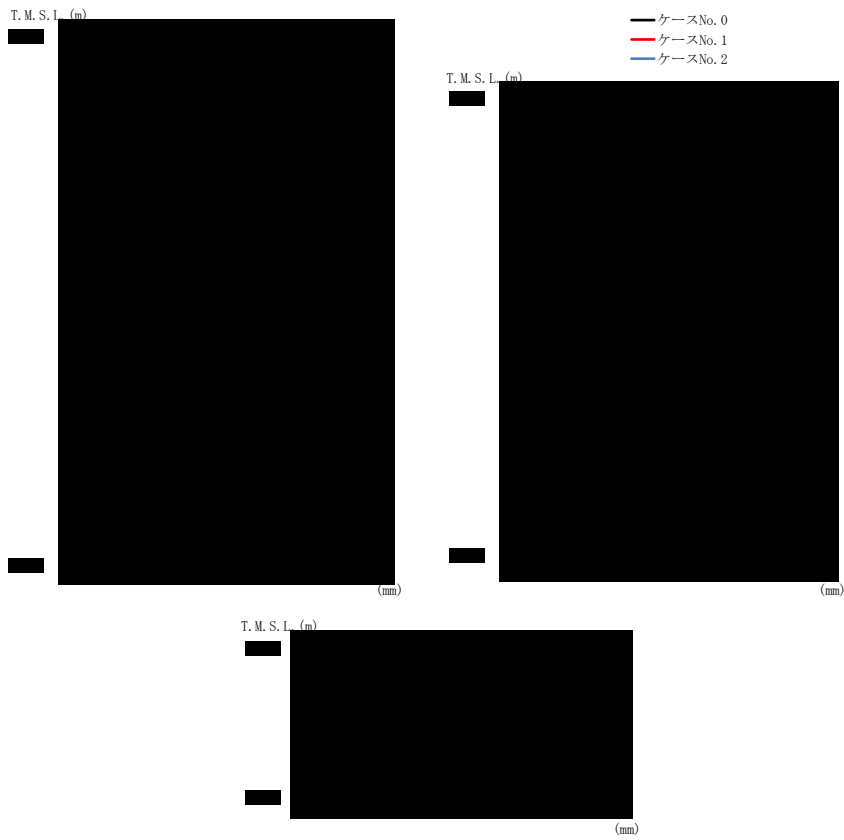

(d) S s - C 1 (N S E W)

第 4. 1. 3-6 図 最大応答変位 (EW 方向) (4/8)

第 4. 1. 3-6 表 最大応答変位一覧表 (EW 方向) (4/8)

(d) S s - C 1 (N S E W)

T. M. S. L. (m)	質 点 番 号	最大応答変位 (mm)		
		ケース No. 0	ケース No. 1	ケース No. 2
[Redacted Data]				

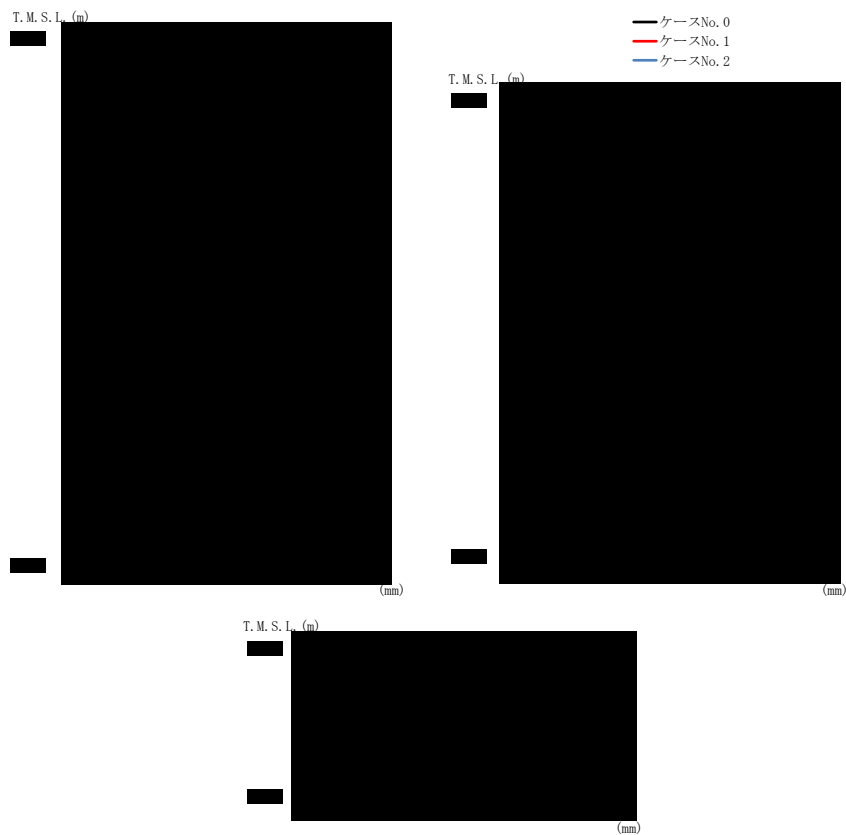

(e) S s - C 3 (NS)

第 4. 1. 3-6 図 最大応答変位 (EW 方向) (5/8)

第 4. 1. 3-6 表 最大応答変位一覧表 (EW 方向) (5/8)

(e) S s - C 3 (NS)

T. M. S. L. (m)	質点 番号	最大応答変位 (mm)		
		ケース No. 0	ケース No. 1	ケース No. 2
[Redacted Data]				

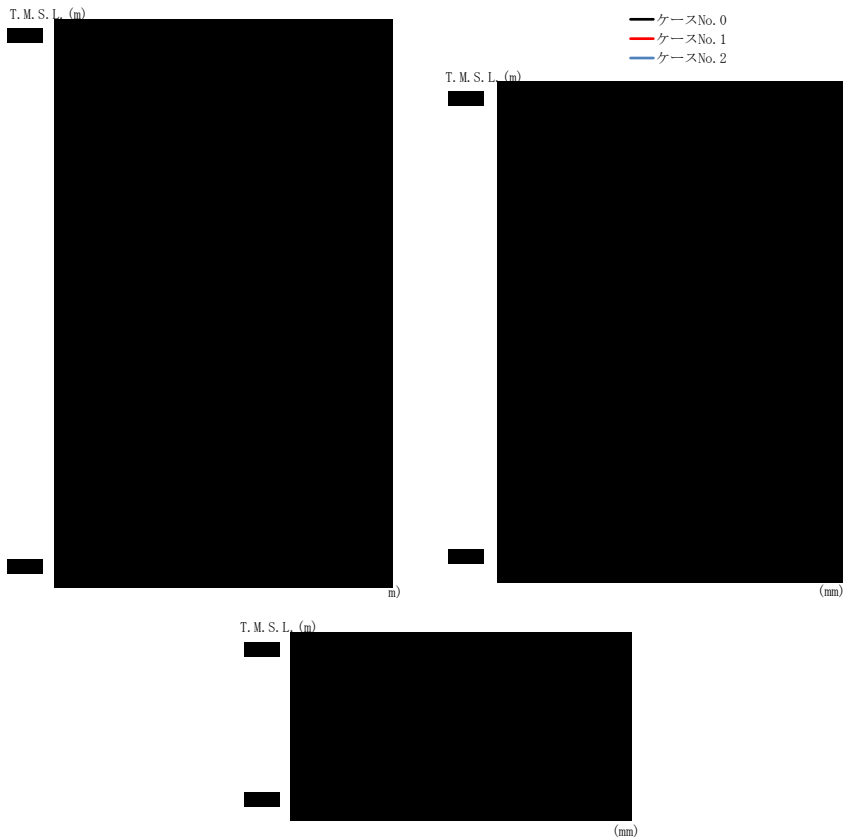

(f) S s - C 3 (EW)

第 4. 1. 3-6 図 最大応答変位 (EW 方向) (6/8)

第 4. 1. 3-6 表 最大応答変位一覧表 (EW 方向) (6/8)

(f) S s - C 3 (EW)

T. M. S. L. (m)	質 点 番 号	最大応答変位 (mm)		
		ケース No. 0	ケース No. 1	ケース No. 2

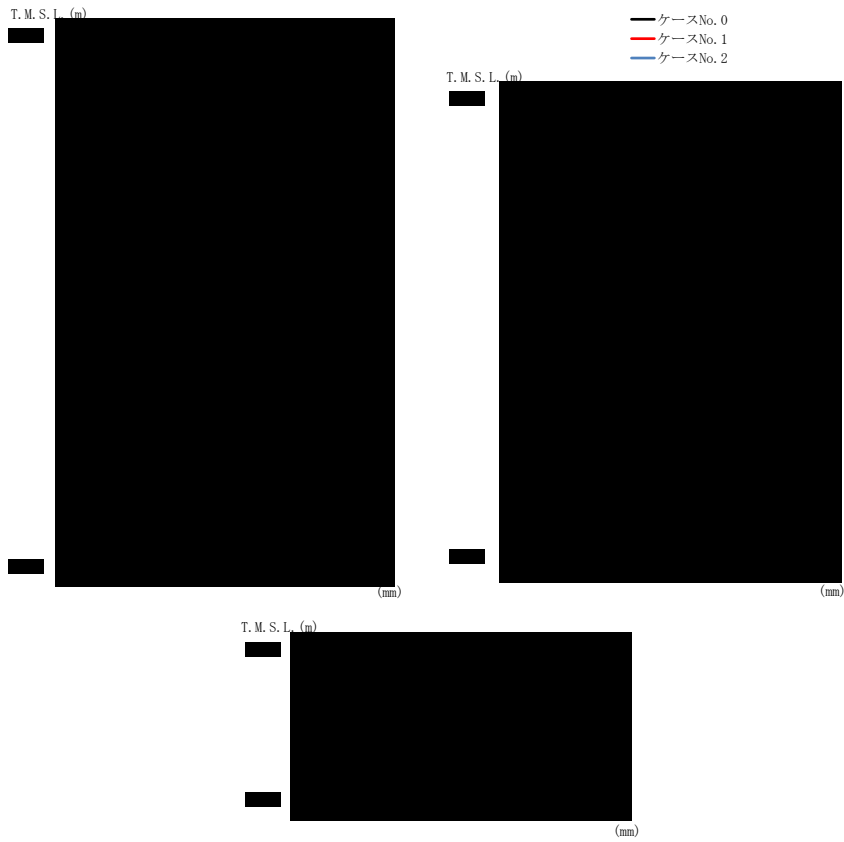

(g) S s - C 4 (NS)

第 4. 1. 3-6 図 最大応答変位 (EW 方向) (7/8)

第 4. 1. 3-6 表 最大応答変位一覧表 (EW 方向) (7/8)

(g) S s - C 4 (NS)

T. M. S. L. (m)	質 点 番 号	最大応答変位 (mm)		
		ケース No. 0	ケース No. 1	ケース No. 2

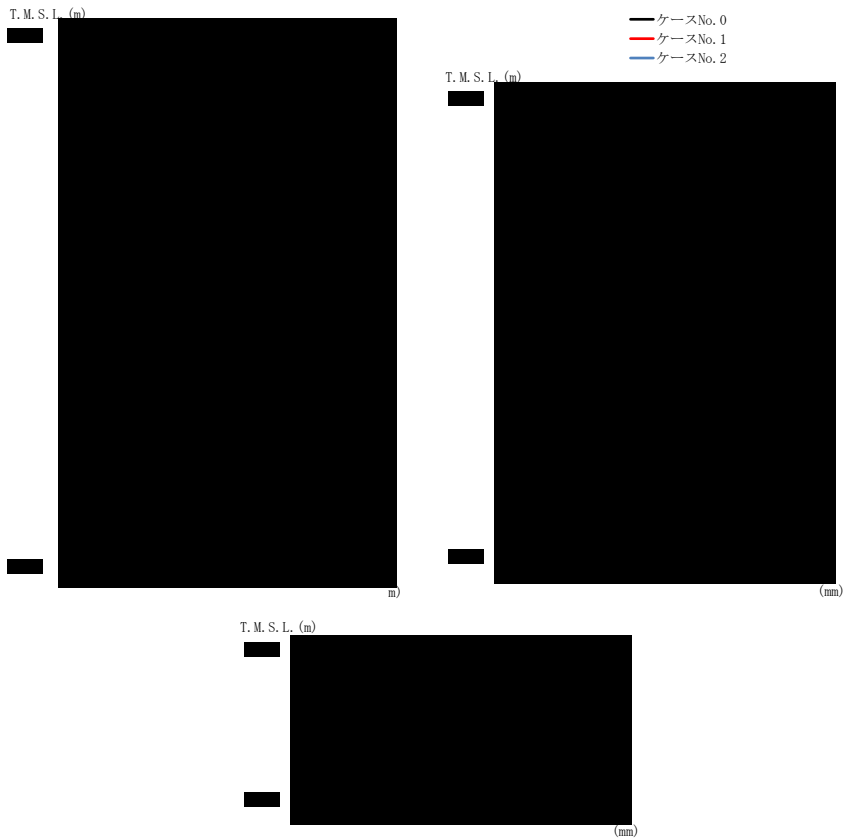

(h) S s - C 4 (EW)

第 4. 1. 3-6 図 最大応答変位 (EW 方向) (8/8)

第 4. 1. 3-6 表 最大応答変位一覧表 (EW 方向) (8/8)

(h) S s - C 4 (EW)

T. M. S. L. (m)	質 点 番 号	最大応答変位 (mm)		
		ケース No. 0	ケース No. 1	ケース No. 2
[Redacted]	[Redacted]	[Redacted]	[Redacted]	[Redacted]

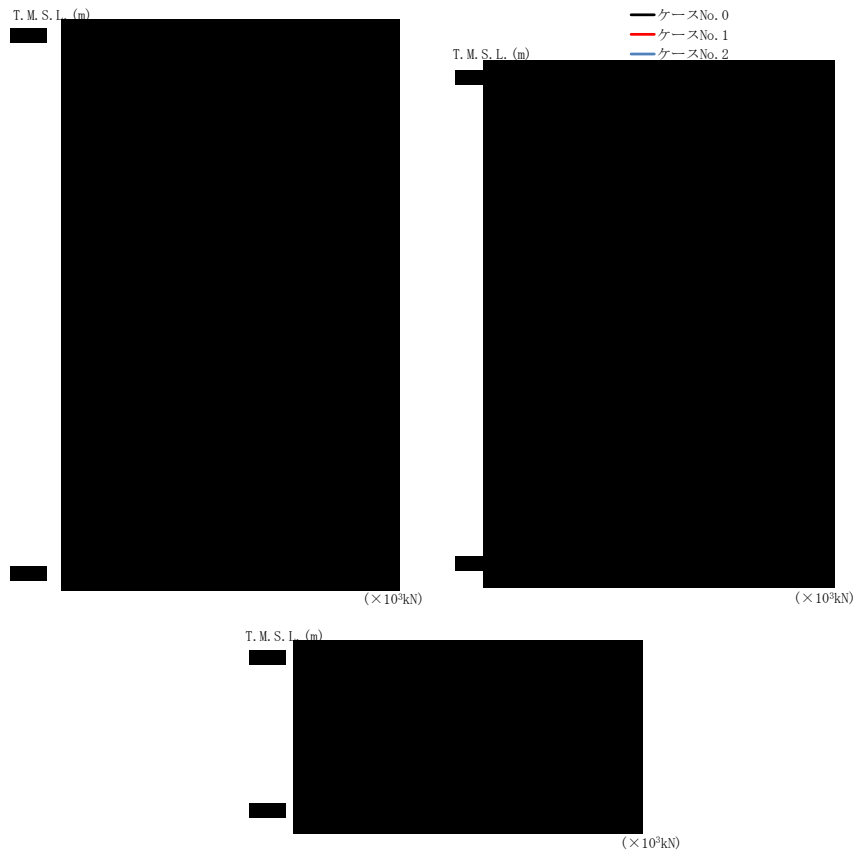

(a) S s - A (H)

第 4. 1. 3-7 図 最大応答せん断力 (EW 方向) (1/8)

第 4. 1. 3-7 表 最大応答せん断力一覧表 (EW 方向) (1/8)

(a) S s - A (H)

T. M. S. L. (m)	要素 番号	最大応答せん断力 (× 10 ³ kN)		
		ケース No. 0	ケース No. 1	ケース No. 2
[Redacted Data]				



(b) S s - B 3 (EW)

第 4. 1. 3-7 図 最大応答せん断力 (EW 方向) (2/8)

第 4. 1. 3-7 表 最大応答せん断力一覧表 (EW 方向) (2/8)

(b) S s - B 3 (EW)

T. M. S. L. (m)	要素 番号	最大応答せん断力 (×10 ³ kN)		
		ケース No. 0	ケース No. 1	ケース No. 2
[Redacted data]				

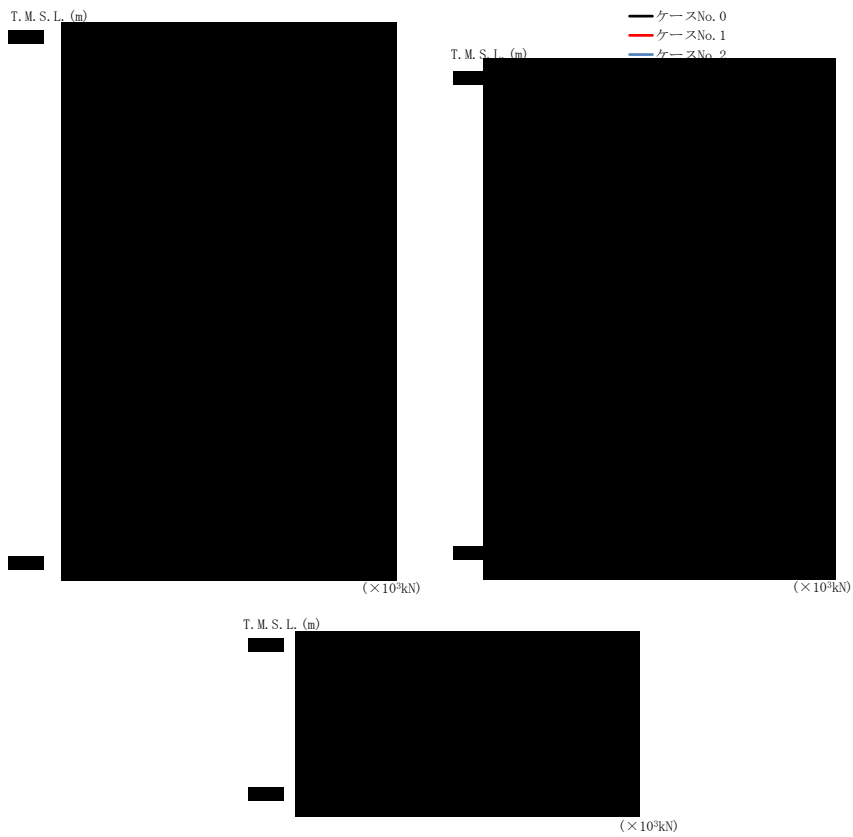

(c) S s - B 4 (EW)

第 4.1.3-7 図 最大応答せん断力 (EW 方向) (3/8)

第 4.1.3-7 表 最大応答せん断力一覧表 (EW 方向) (3/8)

(c) S s - B 4 (EW)

T. M. S. L. (m)	要素 番号	最大応答せん断力 (×10 ³ kN)		
		ケース No. 0	ケース No. 1	ケース No. 2
[Redacted Data]				

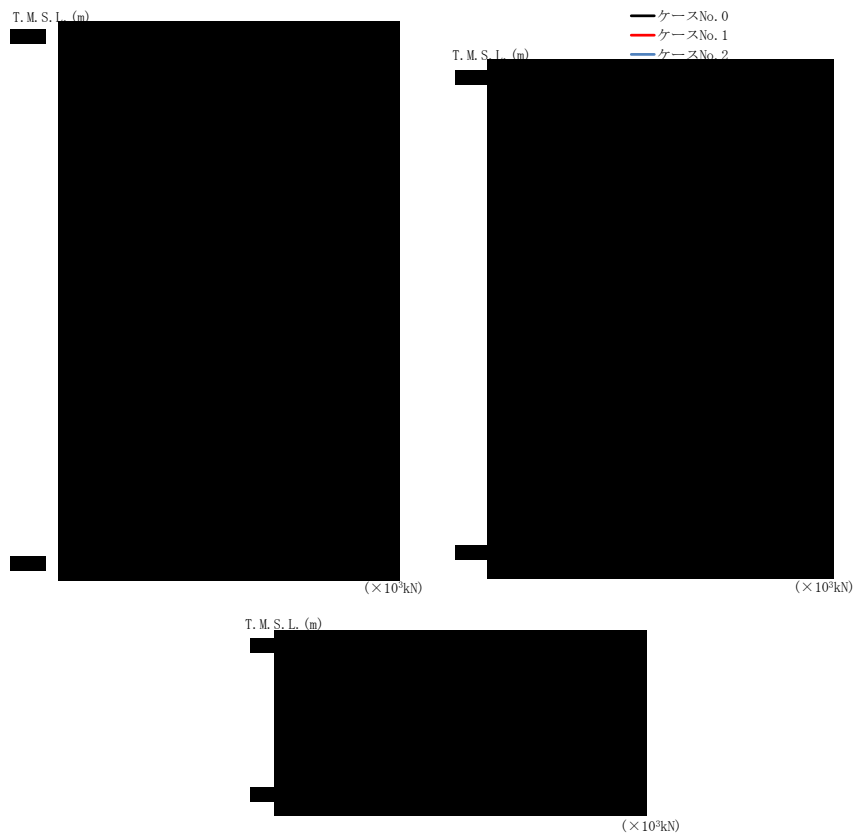

(d) S s - C 1 (N S E W)

第 4. 1. 3-7 図 最大応答せん断力 (EW 方向) (4/8)

第 4. 1. 3-7 表 最大応答せん断力一覧表 (EW 方向) (4/8)

(d) S s - C 1 (N S E W)

T. M. S. L. (m)	要素 番号	最大応答せん断力 (×10 ³ kN)		
		ケース No. 0	ケース No. 1	ケース No. 2
[Redacted Data]				



(e) S s - C 3 (NS)

第 4. 1. 3-7 図 最大応答せん断力 (EW 方向) (5/8)

第 4. 1. 3-7 表 最大応答せん断力一覧表 (EW 方向) (5/8)

(e) S s - C 3 (NS)

T. M. S. L. (m)	要素 番号	最大応答せん断力 (×10 ³ kN)		
		ケース No. 0	ケース No. 1	ケース No. 2
[Redacted Data]				



(f) S s - C 3 (EW)

第 4. 1. 3-7 図 最大応答せん断力 (EW 方向) (6/8)

第 4. 1. 3-7 表 最大応答せん断力一覧表 (EW 方向) (6/8)

(f) S s - C 3 (EW)

T. M. S. L. (m)	要素 番号	最大応答せん断力 (×10 ³ kN)		
		ケース No. 0	ケース No. 1	ケース No. 2

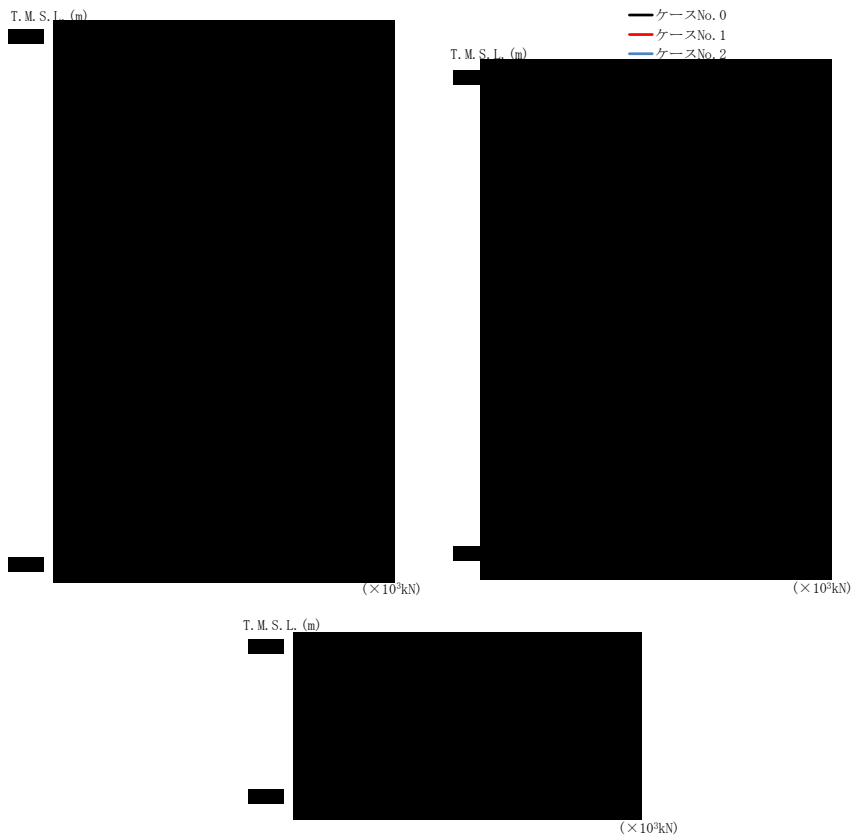

(g) S s - C 4 (NS)

第 4. 1. 3-7 図 最大応答せん断力 (EW 方向) (7/8)

第 4. 1. 3-7 表 最大応答せん断力一覧表 (EW 方向) (7/8)

(g) S s - C 4 (NS)

T. M. S. L. (m)	要素 番号	最大応答せん断力 (×10 ³ kN)		
		ケース No. 0	ケース No. 1	ケース No. 2
[Redacted Data]				



(h) S s - C 4 (EW)

第 4. 1. 3-7 図 最大応答せん断力 (EW 方向) (8/8)

第 4. 1. 3-7 表 最大応答せん断力一覧表 (EW 方向) (8/8)

(h) S s - C 4 (EW)

T. M. S. L. (m)	要素 番号	最大応答せん断力 (×10 ³ kN)		
		ケース No. 0	ケース No. 1	ケース No. 2
[Redacted Data]				



(a) S s - A (H)

第 4.1.3-8 図 最大応答曲げモーメント (EW 方向) (1/8)

第 4.1.3-8 表 最大応答曲げモーメント一覧表 (EW 方向) (1/8)

(a) S s - A (H)

T. M. S. L. (m)	要素 番号	最大応答曲げモーメント (×10 ⁴ kN·m)		
		ケース No. 0	ケース No. 1	ケース No. 2



(b) S s - B 3 (EW)

第 4.1.3-8 図 最大応答曲げモーメント (EW 方向) (2/8)

第 4.1.3-8 表 最大応答曲げモーメント一覧表 (EW 方向) (2/8)

(b) S s - B 3 (EW)

T. M. S. L. (m)	要素 番号	最大応答曲げモーメント (×10 ⁴ kN·m)		
		ケース No. 0	ケース No. 1	ケース No. 2
[Redacted Data]				

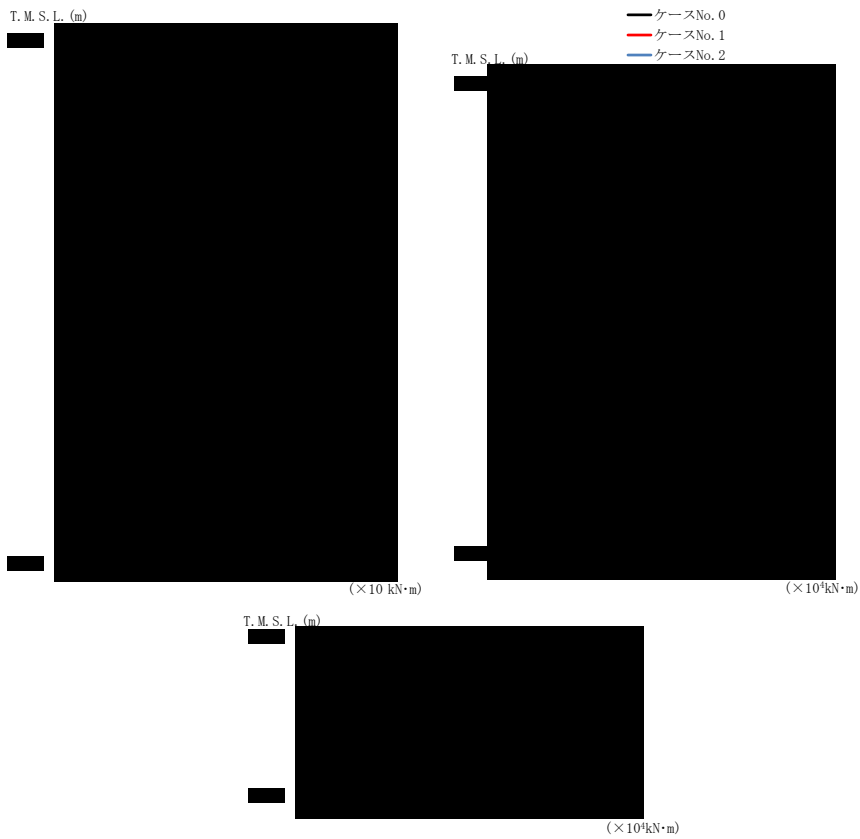

(c) S s - B 4 (EW)

第 4. 1. 3-8 図 最大応答曲げモーメント (EW 方向) (3/8)

第 4. 1. 3-8 表 最大応答曲げモーメント一覧表 (EW 方向) (3/8)

(c) S s - B 4 (EW)

T. M. S. L. (m)	要素 番号	最大応答曲げモーメント (×10 ⁴ kN·m)		
		ケース No. 0	ケース No. 1	ケース No. 2
[Redacted Data]				



(d) S s - C 1 (N S E W)

第 4. 1. 3-8 図 最大応答曲げモーメント (EW 方向) (4/8)

第 4. 1. 3-8 表 最大応答曲げモーメント一覧表 (EW 方向) (4/8)

(d) S s - C 1 (N S E W)

T. M. S. L. (m)	要素 番号	最大応答曲げモーメント (×10 ⁴ kN·m)		
		ケース No. 0	ケース No. 1	ケース No. 2
[Redacted data]				



(e) S s - C 3 (NS)

第 4.1.3-8 図 最大応答曲げモーメント (EW 方向) (5/8)

第 4.1.3-8 表 最大応答曲げモーメント一覧表 (EW 方向) (5/8)

(e) S s - C 3 (NS)

T. M. S. L. (m)	要素 番号	最大応答曲げモーメント (×10 ⁴ kN·m)		
		ケース No. 0	ケース No. 1	ケース No. 2



(f) S s - C 3 (EW)

第 4.1.3-8 図 最大応答曲げモーメント (EW 方向) (6/8)

第 4.1.3-8 表 最大応答曲げモーメント一覧表 (EW 方向) (6/8)

(f) S s - C 3 (EW)

T. M. S. L. (m)	要素 番号	最大応答曲げモーメント (×10 ⁴ kN·m)		
		ケース No. 0	ケース No. 1	ケース No. 2
[Redacted Data]				



(g) S s - C 4 (NS)

第 4. 1. 3-8 図 最大応答曲げモーメント (EW 方向) (7/8)

第 4. 1. 3-8 表 最大応答曲げモーメント一覧表 (EW 方向) (7/8)

(g) S s - C 4 (NS)

T. M. S. L. (m)	要素 番号	最大応答曲げモーメント (×10 ⁴ kN·m)		
		ケース No. 0	ケース No. 1	ケース No. 2
[Redacted Data]				



(h) S s - C 4 (EW)

第 4. 1. 3-8 図 最大応答曲げモーメント (EW 方向) (8/8)

第 4. 1. 3-8 表 最大応答曲げモーメント一覧表 (EW 方向) (8/8)

(h) S s - C 4 (EW)

T. M. S. L. (m)	要素 番号	最大応答曲げモーメント (×10 ⁴ kN·m)		
		ケース No. 0	ケース No. 1	ケース No. 2
[Redacted Data]				

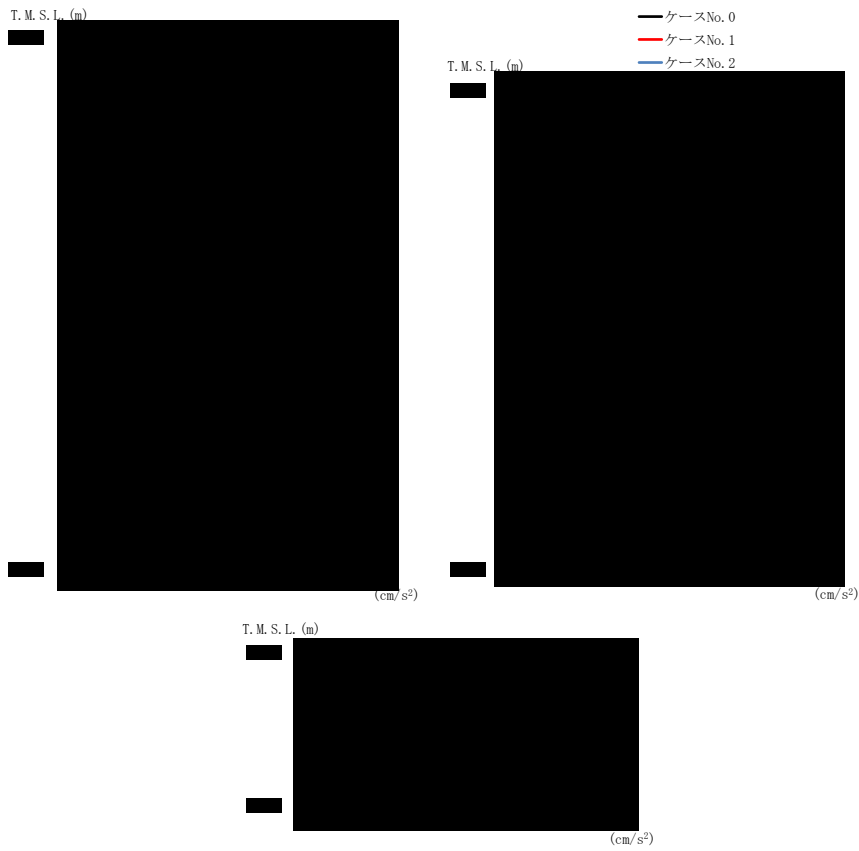

(a) S s - A (V)

第 4. 1. 3-9 図 最大応答加速度（鉛直方向）（1/5）

第 4. 1. 3-9 表 最大応答加速度一覧表（鉛直方向）（1/5）

(a) S s - A (V)

T. M. S. L. (m)	質 点 番 号	最大応答加速度 (cm/s ²)		
		ケース No. 0	ケース No. 1	ケース No. 2
[Redacted Data]				

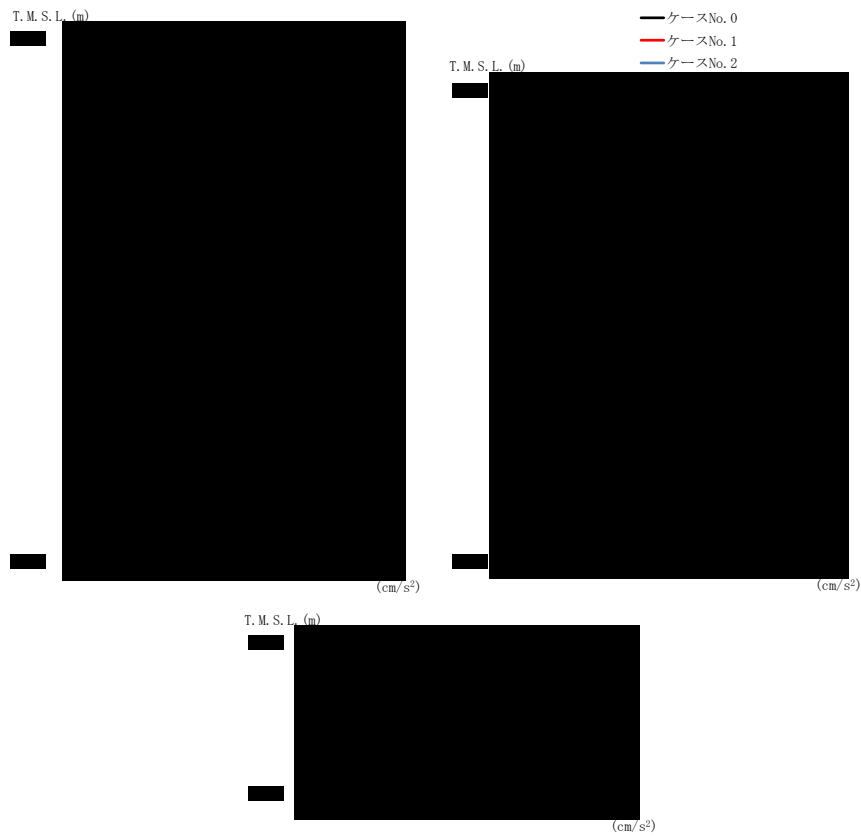

(b) S s - B 3 (UD)

第 4. 1. 3-9 図 最大応答加速度（鉛直方向）（2/5）

第 4. 1. 3-9 表 最大応答加速度一覧表（鉛直方向）（2/5）

(b) S s - B 3 (UD)

T. M. S. L. (m)	質点 番号	最大応答加速度 (cm/s ²)		
		ケース No. 0	ケース No. 1	ケース No. 2
[Redacted Data]				

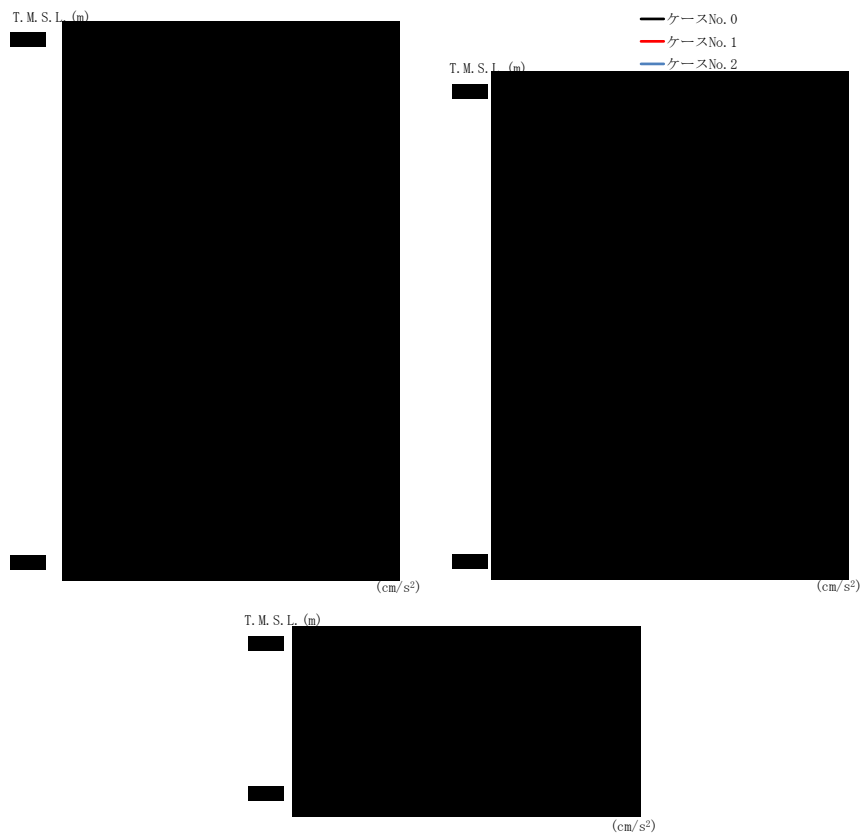

(c) S s - B 4 (UD)

第 4. 1. 3-9 図 最大応答加速度 (鉛直方向) (3/5)

第 4. 1. 3-9 表 最大応答加速度一覧表 (鉛直方向) (3/5)

(c) S s - B 4 (UD)

T. M. S. L. (m)	質 点 番 号	最大応答加速度 (cm/s ²)		
		ケース No. 0	ケース No. 1	ケース No. 2
[Redacted Data]				

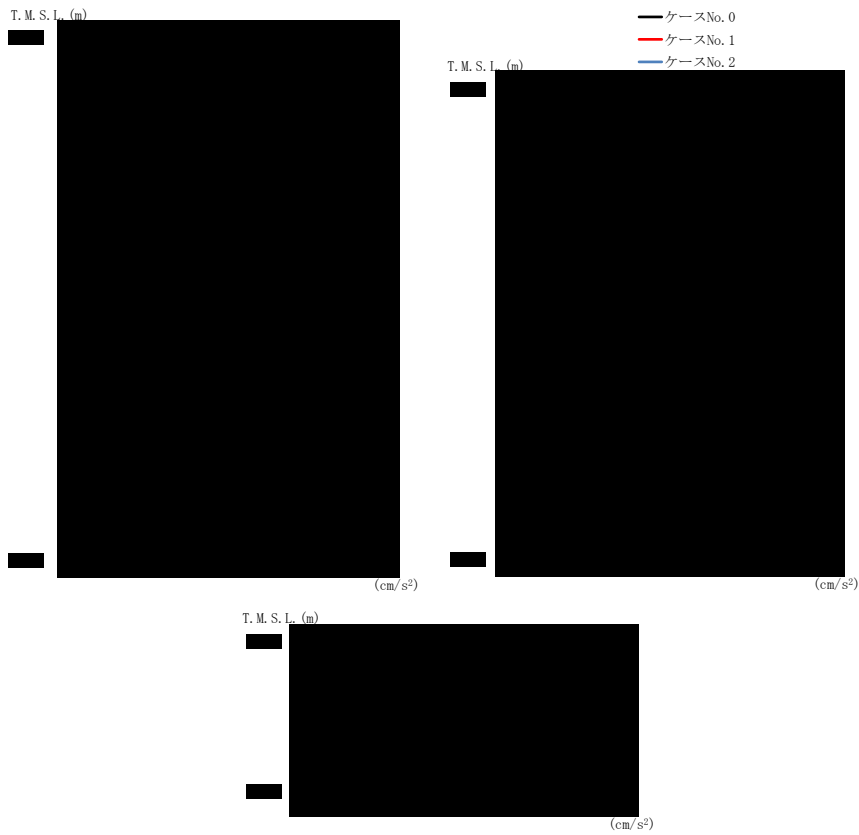

(d) S s - C 1 (UD)

第 4.1.3-9 図 最大応答加速度（鉛直方向）（4/5）

第 4.1.3-9 表 最大応答加速度一覧表（鉛直方向）（4/5）

(d) S s - C 1 (UD)

T. M. S. L. (m)	質 点 番 号	最大応答加速度 (cm/s ²)		
		ケース No. 0	ケース No. 1	ケース No. 2
[Redacted Data]				

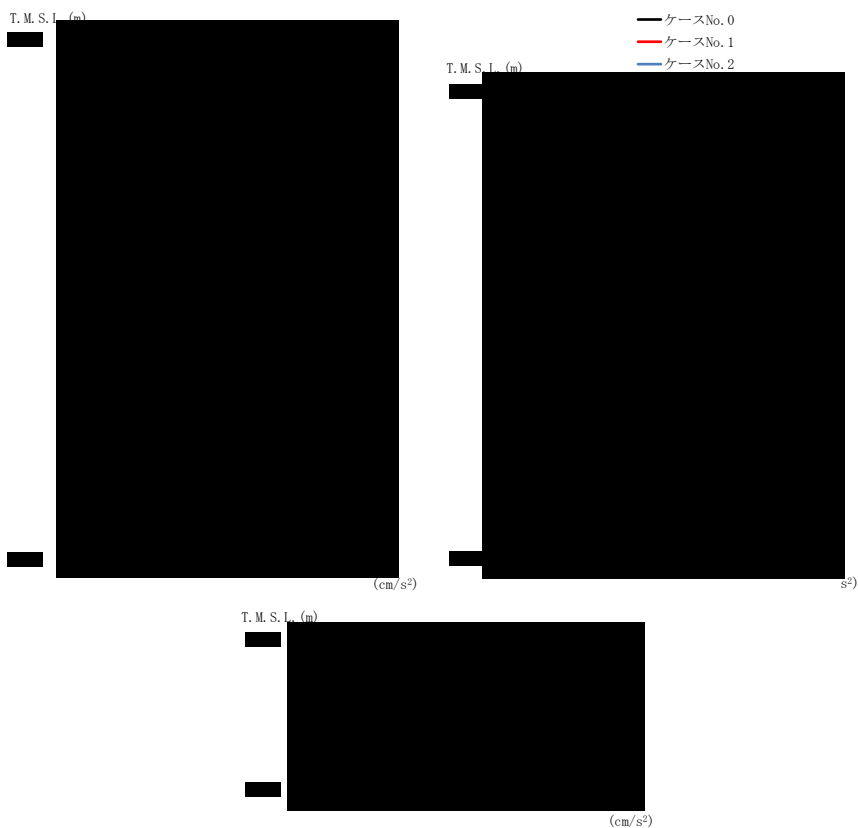

(e) S s - C 3 (UD)

第 4. 1. 3-9 図 最大応答加速度（鉛直方向）（5/5）

第 4. 1. 3-9 表 最大応答加速度一覧表（鉛直方向）（5/5）

(e) S s - C 3 (UD)

T. M. S. L. (m)	質 点 番 号	最大応答加速度 (cm/s ²)		
		ケース No. 0	ケース No. 1	ケース No. 2
[Redacted Data]				

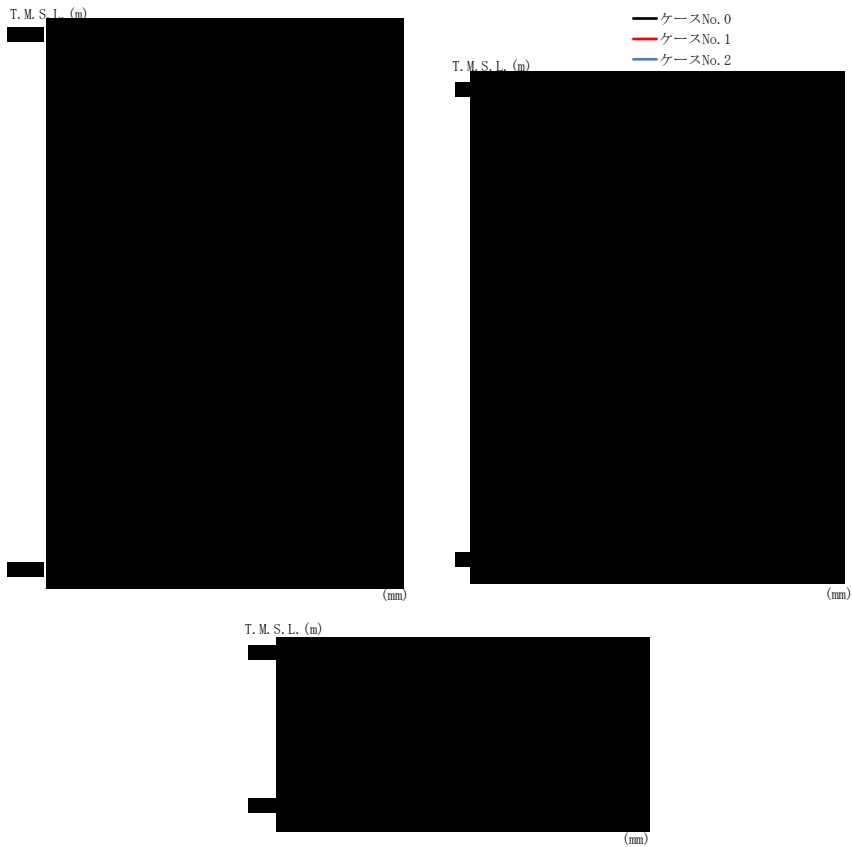

(a) S s - A (V)

第 4. 1. 3-10 図 最大応答変位 (鉛直方向) (1/5)

第 4. 1. 3-10 表 最大応答変位一覧表 (鉛直方向) (1/5)

(a) S s - A (V)

T. M. S. L. (m)	質点番号	最大応答変位 (mm)		
		ケース No. 0	ケース No. 1	ケース No. 2
[Redacted Data]				

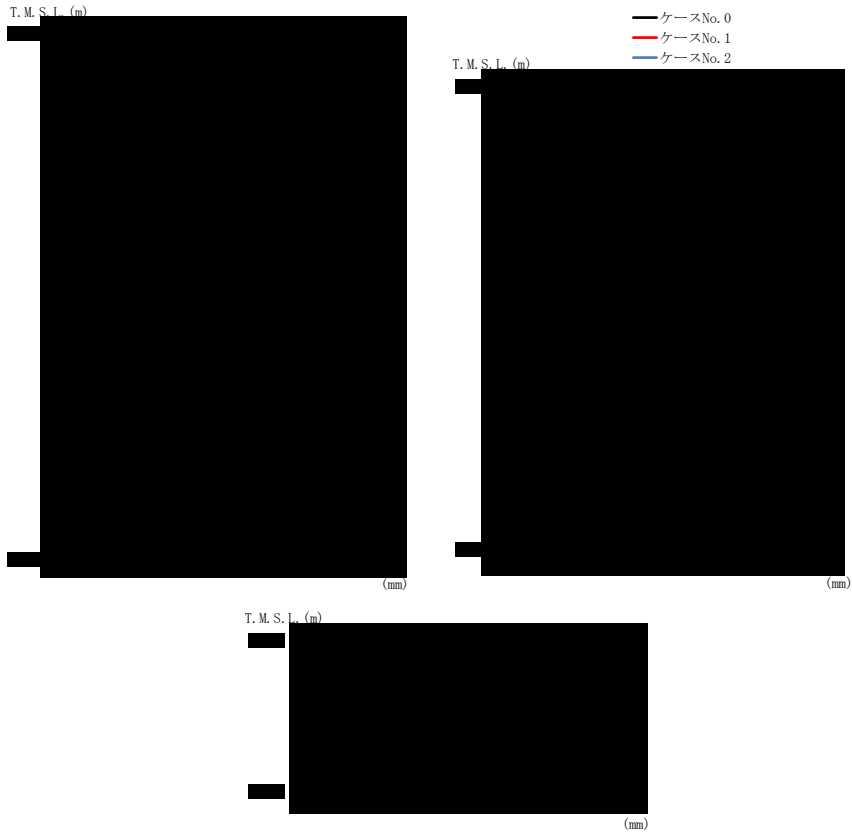

(b) S s - B 3 (UD)

第 4.1.3-10 図 最大応答変位 (鉛直方向) (2/5)

第 4.1.3-10 表 最大応答変位一覧表 (鉛直方向) (2/5)

(b) S s - B 3 (UD)

T. M. S. L. (m)	質 点 番 号	最大応答変位 (mm)		
		ケース No. 0	ケース No. 1	ケース No. 2

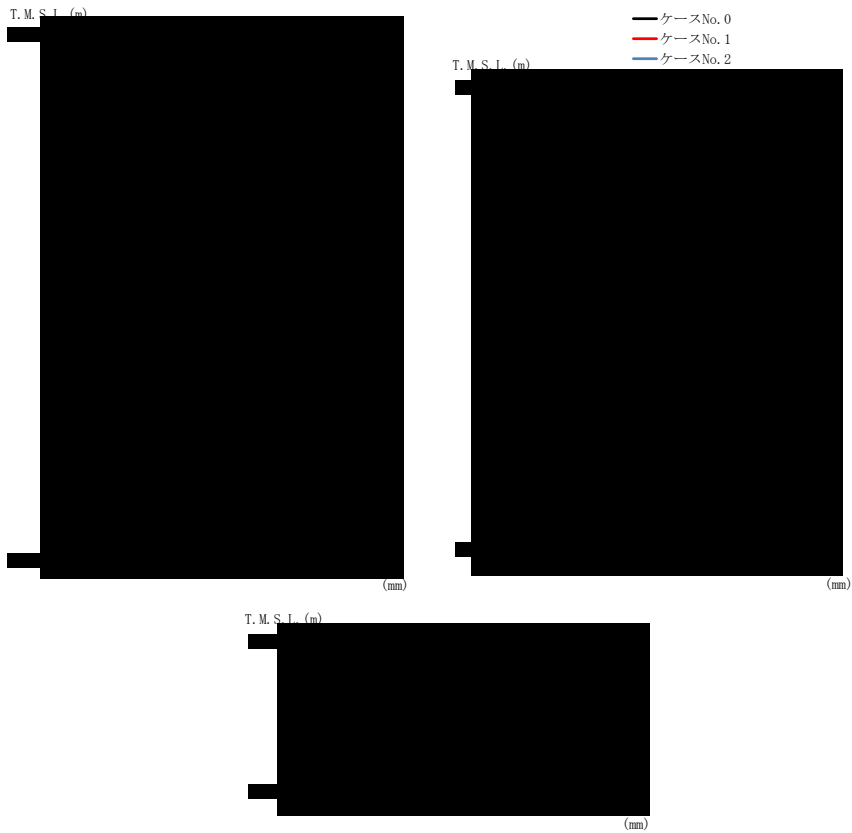

(c) S s - B 4 (UD)

第 4. 1. 3-10 図 最大応答変位 (鉛直方向) (3/5)

第 4. 1. 3-10 表 最大応答変位一覧表 (鉛直方向) (3/5)

(c) S s - B 4 (UD)

T. M. S. L. (m)	質 点 番 号	最大応答変位 (mm)		
		ケース No. 0	ケース No. 1	ケース No. 2
[Redacted Data]				

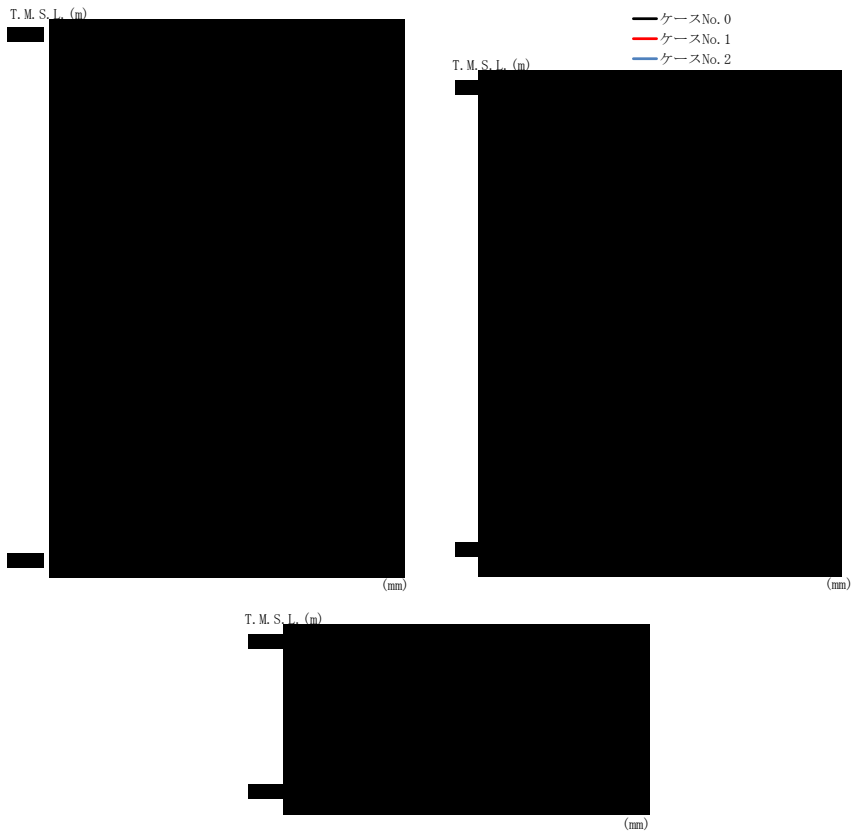

(d) S s - C 1 (UD)

第 4. 1. 3-10 図 最大応答変位 (鉛直方向) (4/5)

第 4. 1. 3-10 表 最大応答変位一覧表 (鉛直方向) (4/5)

(d) S s - C 1 (UD)

T. M. S. L. (m)	質 点 番 号	最大応答変位 (mm)		
		ケース No. 0	ケース No. 1	ケース No. 2

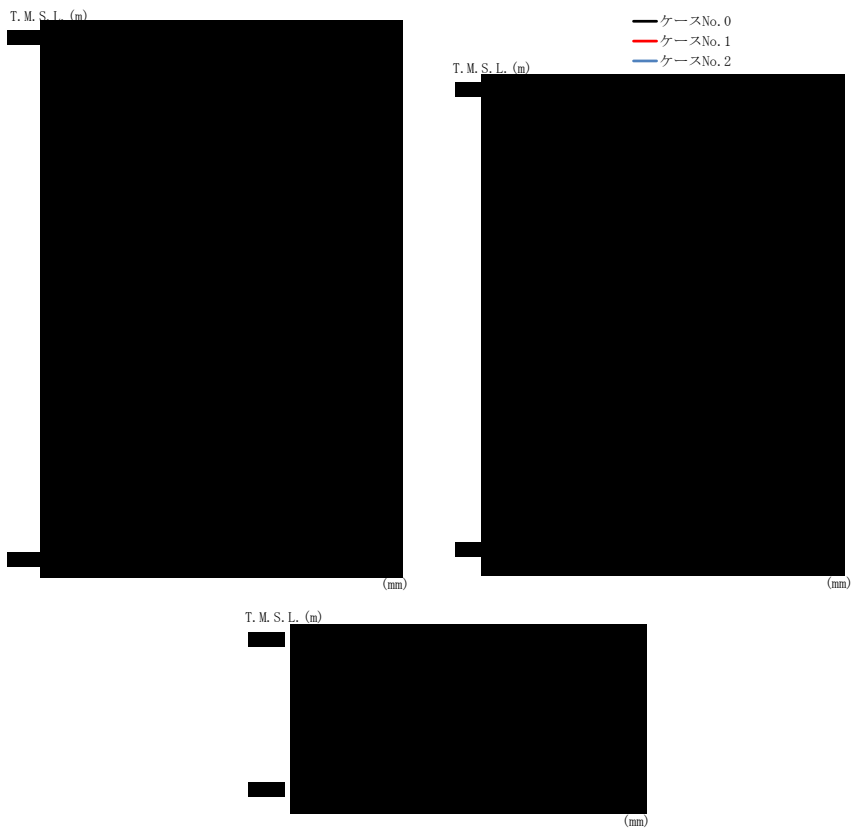

(e) S s - C 3 (UD)

第 4. 1. 3-10 図 最大応答変位 (鉛直方向) (5/5)

第 4. 1. 3-10 表 最大応答変位一覧表 (鉛直方向) (5/5)

(e) S s - C 3 (UD)

T. M. S. L. (m)	質 点 番 号	最大応答変位 (mm)		
		ケース No. 0	ケース No. 1	ケース No. 2



(a) S s - A (V)

第 4.1.3-11 図 最大応答軸力（鉛直方向）（1/5）

第 4.1.3-11 表 最大応答軸力一覧表（鉛直方向）（1/5）

(a) S s - A (V)

T.M.S.L. (m)	要素 番号	最大応答軸力 (\times 10^3 kN)		
		ケース No. 0	ケース No. 1	ケース No. 2
[Redacted Data]				



(b) S s - B 3 (UD)

第 4. 1. 3-11 図 最大応答軸力 (鉛直方向) (2/5)

第 4. 1. 3-11 表 最大応答軸力一覧表 (鉛直方向) (2/5)

(b) S s - B 3 (UD)

T. M. S. L. (m)	要素 番号	最大応答軸力 ($\times 10^3 \text{kN}$)		
		ケース No. 0	ケース No. 1	ケース No. 2
[Redacted Data]				



(c) S s - B 4 (UD)

第 4. 1. 3-11 図 最大応答軸力 (鉛直方向) (3/5)

第 4. 1. 3-11 表 最大応答軸力一覧表 (鉛直方向) (3/5)

(c) S s - B 4 (UD)

T. M. S. L. (m)	要素 番号	最大応答軸力 ($\times 10^3 \text{kN}$)		
		ケース No. 0	ケース No. 1	ケース No. 2
[Redacted Data]				



(d) S s - C 1 (UD)

第 4. 1. 3-11 図 最大応答軸力 (鉛直方向) (4/5)

第 4. 1. 3-11 表 最大応答軸力一覧表 (鉛直方向) (4/5)

(d) S s - C 1 (UD)

T. M. S. L. (m)	要素 番号	最大応答軸力 (×10 ³ kN)		
		ケース No. 0	ケース No. 1	ケース No. 2
[Redacted Data]				



(e) S s - C 3 (UD)

第 4. 1. 3-11 図 最大応答軸力 (鉛直方向) (5/5)

第 4. 1. 3-11 表 最大応答軸力一覧表 (鉛直方向) (5/5)

(e) S s - C 3 (UD)

T. M. S. L. (m)	要素 番号	最大応答軸力 ($\times 10^3 \text{kN}$)		
		ケース No. 0	ケース No. 1	ケース No. 2
[Redacted Data]				

第 4. 1. 3-12 表 浮上り検討 (基準地震動 S_s , ケース No. 1)

(a)NS 方向

地震動	浮上り限界転倒 モーメント ($\times 10^6 \text{kN}\cdot\text{m}$)	最小接地率算出時の 転倒モーメント ($\times 10^6 \text{kN}\cdot\text{m}$)	接地率 (%)
Ss-A (H)			
Ss-B3 (NS)			
Ss-B4 (NS)			
Ss-C1 (NSEW)			
Ss-C3 (NS)			
Ss-C3 (EW)			
Ss-C4 (NS)			
Ss-C4 (EW)			

(b)EW 方向

地震動	浮上り限界転倒 モーメント ($\times 10^6 \text{kN}\cdot\text{m}$)	最小接地率算出時の 転倒モーメント ($\times 10^6 \text{kN}\cdot\text{m}$)	接地率 (%)
Ss-A (H)			
Ss-B3 (EW)			
Ss-B4 (EW)			
Ss-C1 (NSEW)			
Ss-C3 (NS)			
Ss-C3 (EW)			
Ss-C4 (NS)			
Ss-C4 (EW)			

第 4. 1. 3-13 表 浮上り検討 (基準地震動 S_s , ケース No. 2)

(a)NS 方向

地震動	浮上り限界転倒 モーメント ($\times 10^6 \text{kN}\cdot\text{m}$)	最小接地率算出時の 転倒モーメント ($\times 10^6 \text{kN}\cdot\text{m}$)	接地率 (%)
Ss-A (H)			
Ss-B3 (NS)			
Ss-B4 (NS)			
Ss-C1 (NSEW)			
Ss-C3 (NS)			
Ss-C3 (EW)			
Ss-C4 (NS)			
Ss-C4 (EW)			

(b)EW 方向

地震動	浮上り限界転倒 モーメント ($\times 10^6 \text{kN}\cdot\text{m}$)	最小接地率算出時の 転倒モーメント ($\times 10^6 \text{kN}\cdot\text{m}$)	接地率 (%)
Ss-A (H)			
Ss-B3 (EW)			
Ss-B4 (EW)			
Ss-C1 (NSEW)			
Ss-C3 (NS)			
Ss-C3 (EW)			
Ss-C4 (NS)			
Ss-C4 (EW)			

第 4. 1. 3-14 表 最大接地圧 (基準地震動 S_s , ケース No. 1)

地震動	方向		最大接地圧 (kN/m ²)
S_s -A	NS	鉛直上向き	
		鉛直下向き	
	EW	鉛直上向き	
		鉛直下向き	
S_s -B3	NS	鉛直上向き	
		鉛直下向き	
	EW	鉛直上向き	
		鉛直下向き	
S_s -B4	NS	鉛直上向き	
		鉛直下向き	
	EW	鉛直上向き	
		鉛直下向き	
S_s -C1	NS	鉛直上向き	
		鉛直下向き	
	EW	鉛直上向き	
		鉛直下向き	
S_s -C3 (NS)	NS	鉛直上向き	
		鉛直下向き	
	EW	鉛直上向き	
		鉛直下向き	
S_s -C3 (EW)	NS	鉛直上向き	
		鉛直下向き	
	EW	鉛直上向き	
		鉛直下向き	
S_s -C4 (NS)	NS	—	
	EW	—	
S_s -C4 (EW)	NS	—	
	EW	—	

第 4. 1. 3-15 表 最大接地圧 (基準地震動 S_s , ケース No. 2)

地震動	方向		最大接地圧 (kN/m ²)
S_s -A	NS	鉛直上向き	-
		鉛直下向き	
	EW	鉛直上向き	
		鉛直下向き	
S_s -B3	NS	鉛直上向き	
		鉛直下向き	
	EW	鉛直上向き	
		鉛直下向き	
S_s -B4	NS	鉛直上向き	
		鉛直下向き	
	EW	鉛直上向き	
		鉛直下向き	
S_s -C1	NS	鉛直上向き	
		鉛直下向き	
	EW	鉛直上向き	
		鉛直下向き	
S_s -C3 (NS)	NS	鉛直上向き	
		鉛直下向き	
	EW	鉛直上向き	
		鉛直下向き	
S_s -C3 (EW)	NS	鉛直上向き	
		鉛直下向き	
	EW	鉛直上向き	
		鉛直下向き	
S_s -C4 (NS)	NS	—	
	EW	—	
S_s -C4 (EW)	NS	—	
	EW	—	

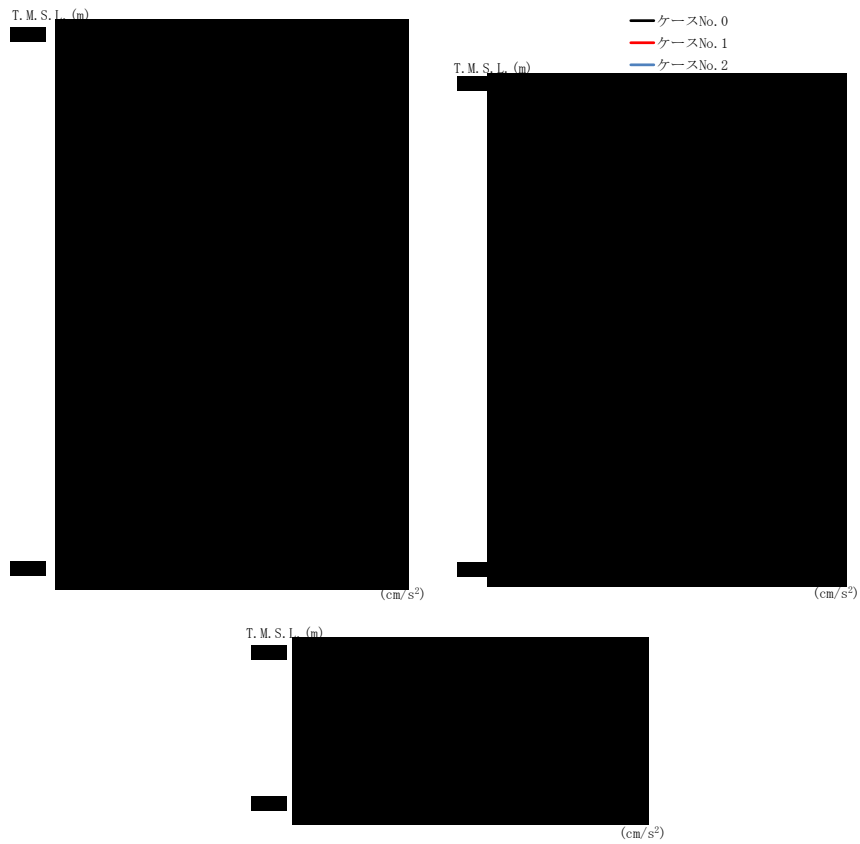

(a) S d - A (H)

第 4. 1. 3-12 図 最大応答加速度 (NS 方向) (1/6)

第 4. 1. 3-16 表 最大応答加速度一覧表 (NS 方向) (1/6)

(a) S d - A (H)

T. M. S. L. (m)	質 点 番 号	最大応答加速度 (cm/s ²)		
		ケース No. 0	ケース No. 1	ケース No. 2
[Redacted Data]				



(b) S d - C 1 (N S E W)

第 4. 1. 3-12 図 最大応答加速度 (NS 方向) (2/6)

第 4. 1. 3-16 表 最大応答加速度一覧表 (NS 方向) (2/6)

(b) S d - C 1 (N S E W)

T. M. S. L. (m)	質 点 番 号	最大応答加速度 (cm/s ²)		
		ケー ス No. 0	ケー ス No. 1	ケー ス No. 2
[Redacted Data]				

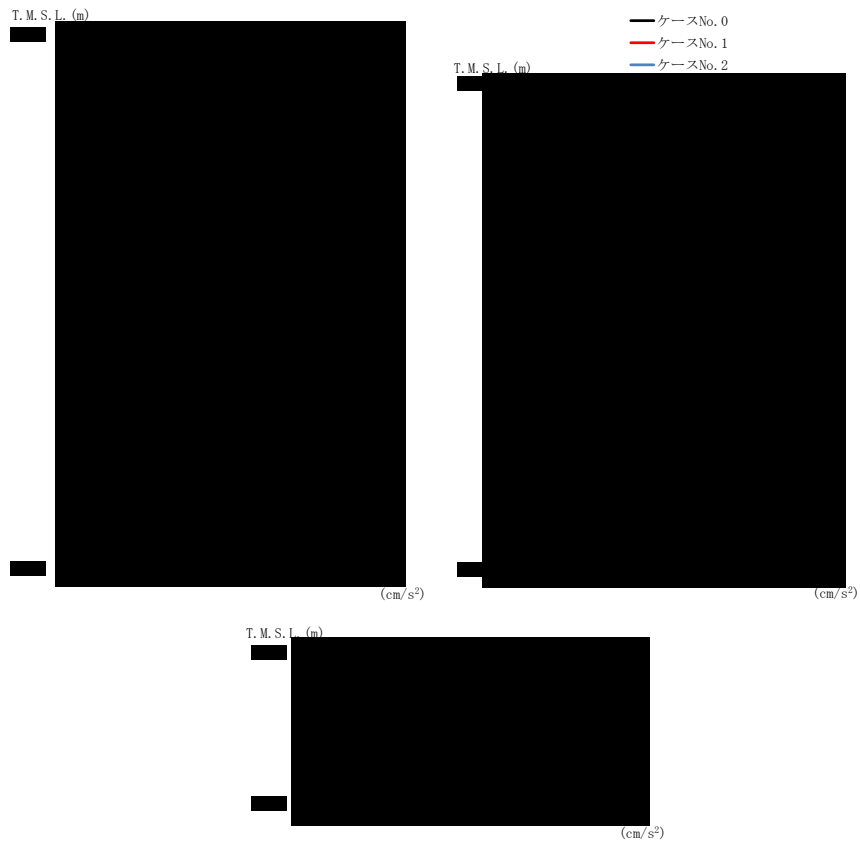

(c) S d - C 3 (NS)

第 4.1.3-12 図 最大応答加速度 (NS 方向) (3/6)

第 4.1.3-16 表 最大応答加速度一覧表 (NS 方向) (3/6)

(c) S d - C 3 (NS)

T.M.S.L. (m)	質点番号	最大応答加速度 (cm/s ²)		
		ケース No. 0	ケース No. 1	ケース No. 2
[Redacted]	[Redacted]	[Redacted]	[Redacted]	[Redacted]
[Redacted]	[Redacted]	[Redacted]	[Redacted]	[Redacted]
[Redacted]	[Redacted]	[Redacted]	[Redacted]	[Redacted]

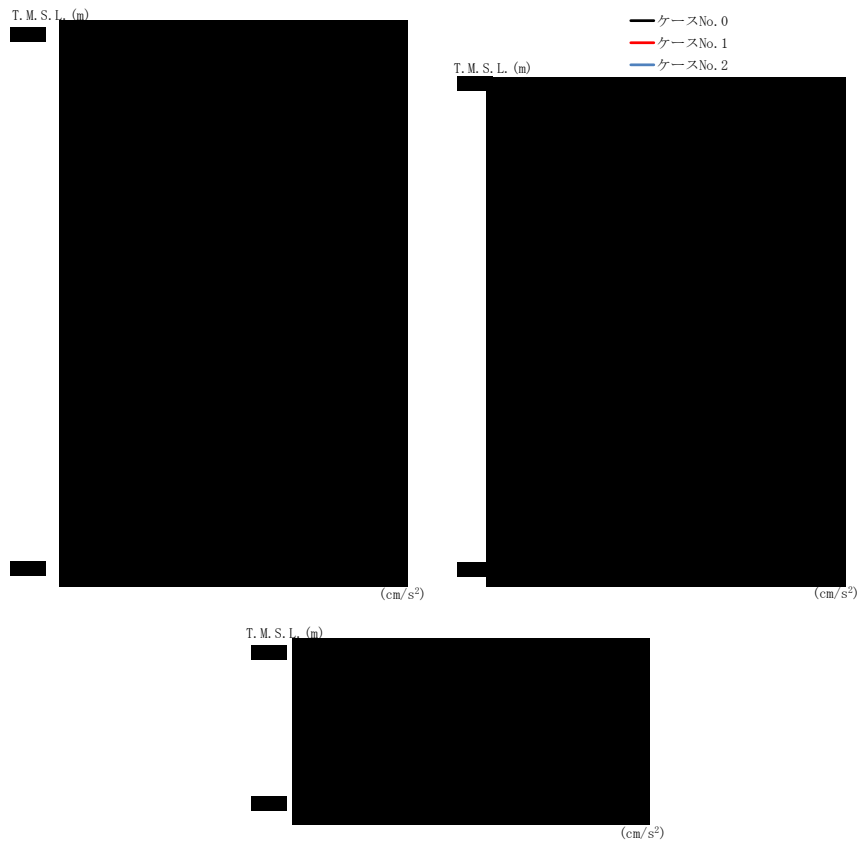

(d) S d - C 3 (EW)

第 4. 1. 3-12 図 最大応答加速度 (NS 方向) (4/6)

第 4. 1. 3-16 表 最大応答加速度一覧表 (NS 方向) (4/6)

(d) S d - C 3 (EW)

T. M. S. L. (m)	質 点 番 号	最大応答加速度 (cm/s ²)		
		ケー ス No. 0	ケー ス No. 1	ケー ス No. 2
[Redacted Data]				

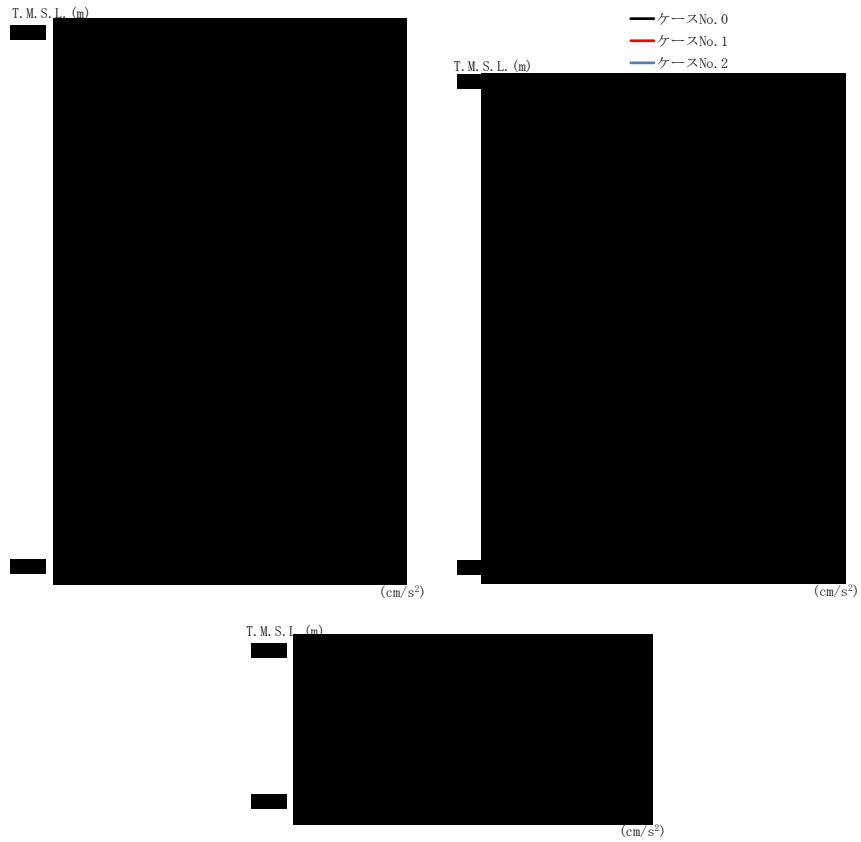

(e) S d - C 4 (N S)

第 4. 1. 3-12 図 最大応答加速度 (NS 方向) (5/6)

第 4. 1. 3-16 表 最大応答加速度一覧表 (NS 方向) (5/6)

(e) S d - C 4 (N S)

T. M. S. L. (m)	質 点 番 号	最大応答加速度 (cm/s ²)		
		ケー ス No. 0	ケー ス No. 1	ケー ス No. 2
[Redacted Data]				

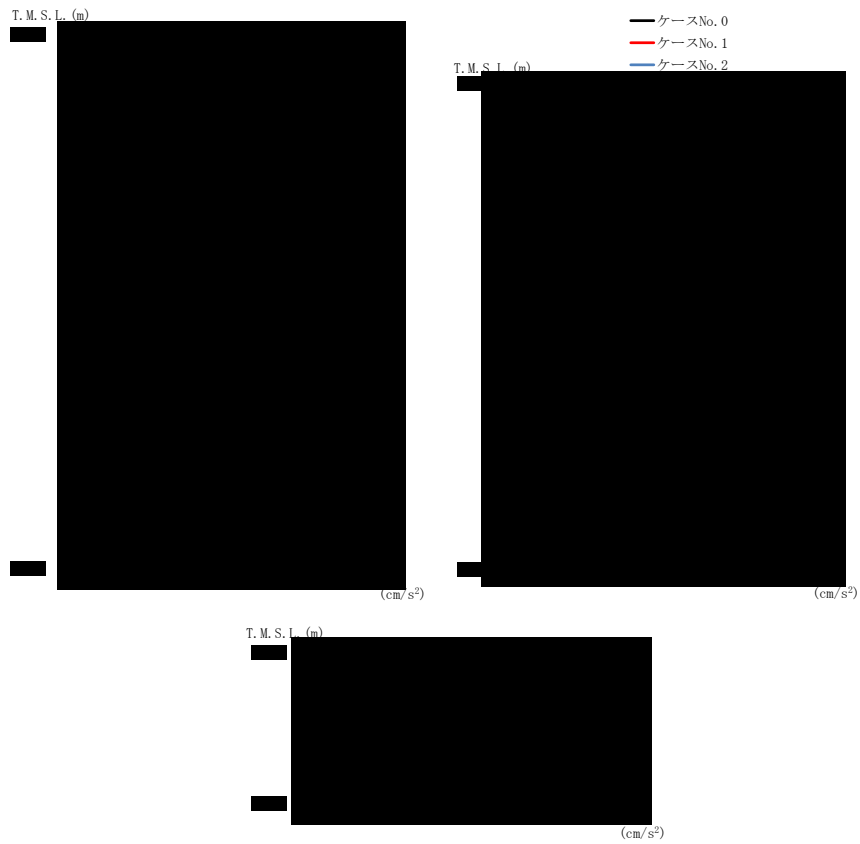

(f) S d - C 4 (E W)

第 4. 1. 3-12 図 最大応答加速度 (NS 方向) (6/6)

第 4. 1. 3-16 表 最大応答加速度一覧表 (NS 方向) (6/6)

(f) S d - C 4 (E W)

T. M. S. L. (m)	質 点 番 号	最大応答加速度 (cm/s ²)		
		ケース No. 0	ケース No. 1	ケース No. 2
[Redacted Data]				

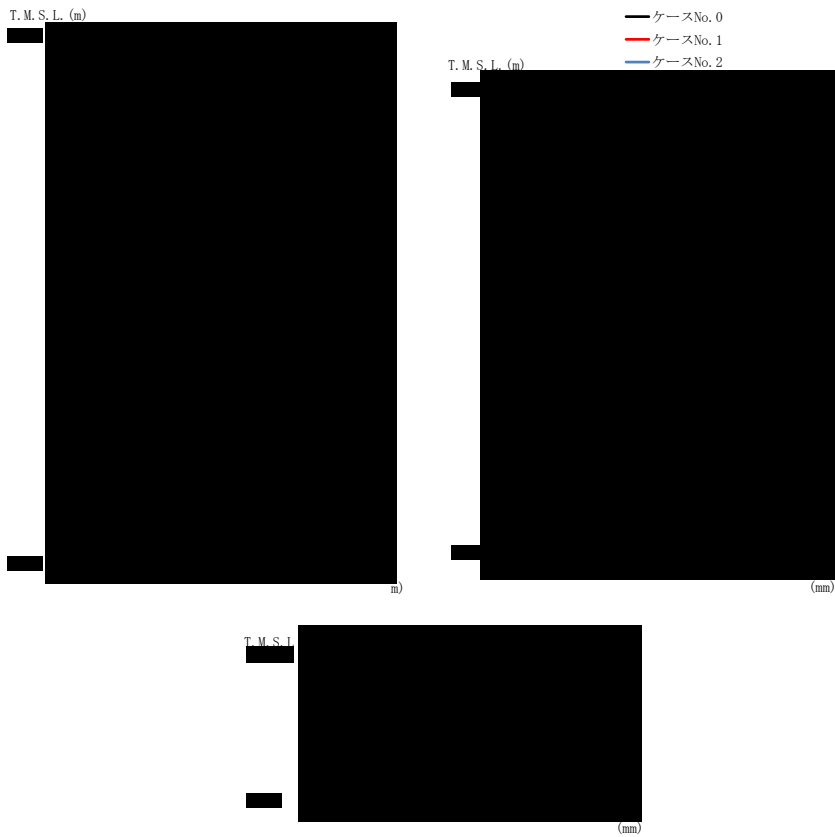

(a) S d - A (H)

第 4. 1. 3-13 図 最大応答変位 (NS 方向) (1/6)

第 4. 1. 3-17 表 最大応答変位一覧表 (NS 方向) (1/6)

(a) S d - A (H)

T. M. S. L. (m)	質 点 番 号	最大応答変位 (mm)		
		ケース No. 0	ケース No. 1	ケース No. 2
[Redacted data]				

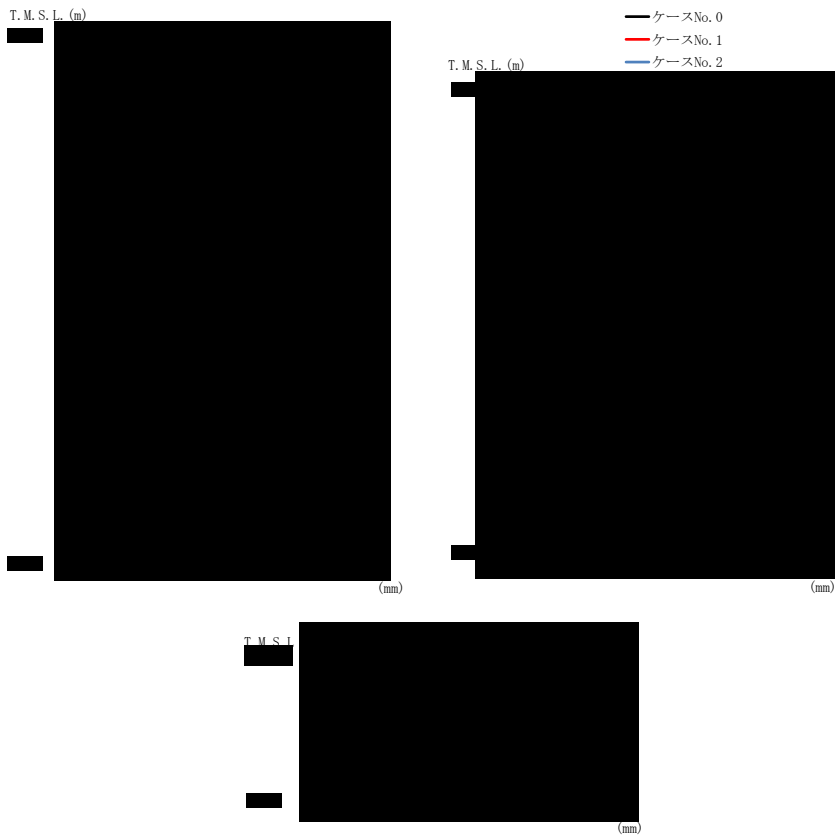

(b) S d - C 1 (N S E W)

第 4. 1. 3-13 図 最大応答変位 (NS 方向) (2/6)

第 4. 1. 3-17 表 最大応答変位一覧表 (NS 方向) (2/6)

(b) S d - C 1 (N S E W)

T. M. S. L. (m)	質 点 番 号	最大応答変位 (mm)		
		ケース No. 0	ケース No. 1	ケース No. 2
[Redacted Data]				

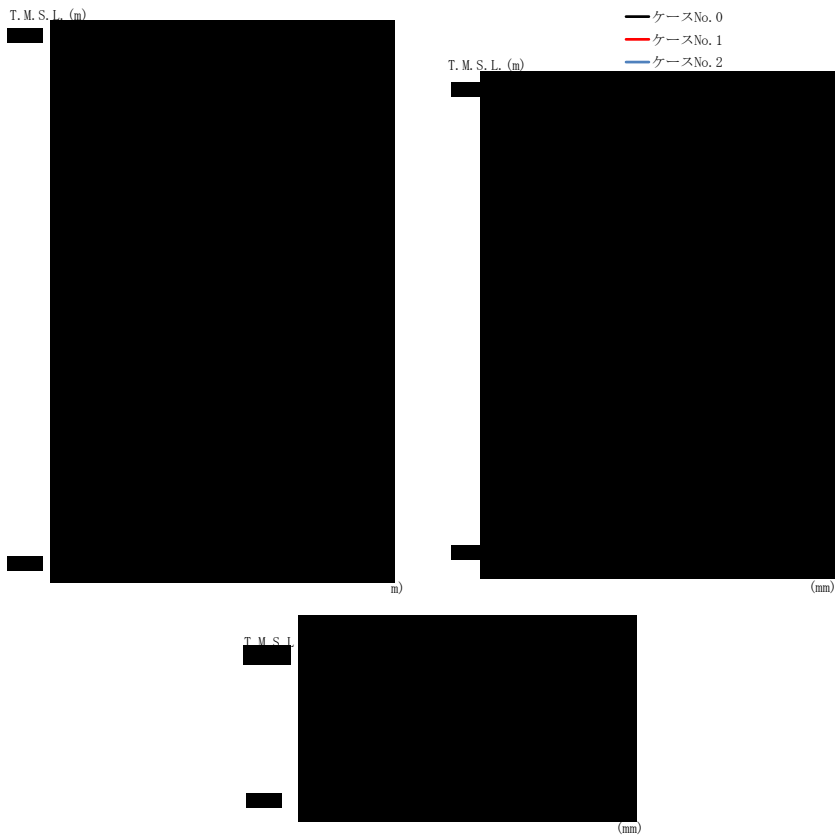

(c) S d - C 3 (NS)

第 4.1.3-13 図 最大応答変位 (NS 方向) (3/6)

第 4.1.3-17 表 最大応答変位一覧表 (NS 方向) (3/6)

(c) S d - C 3 (NS)

T. M. S. L. (m)	質 点 番 号	最大応答変位 (mm)		
		ケース No. 0	ケース No. 1	ケース No. 2

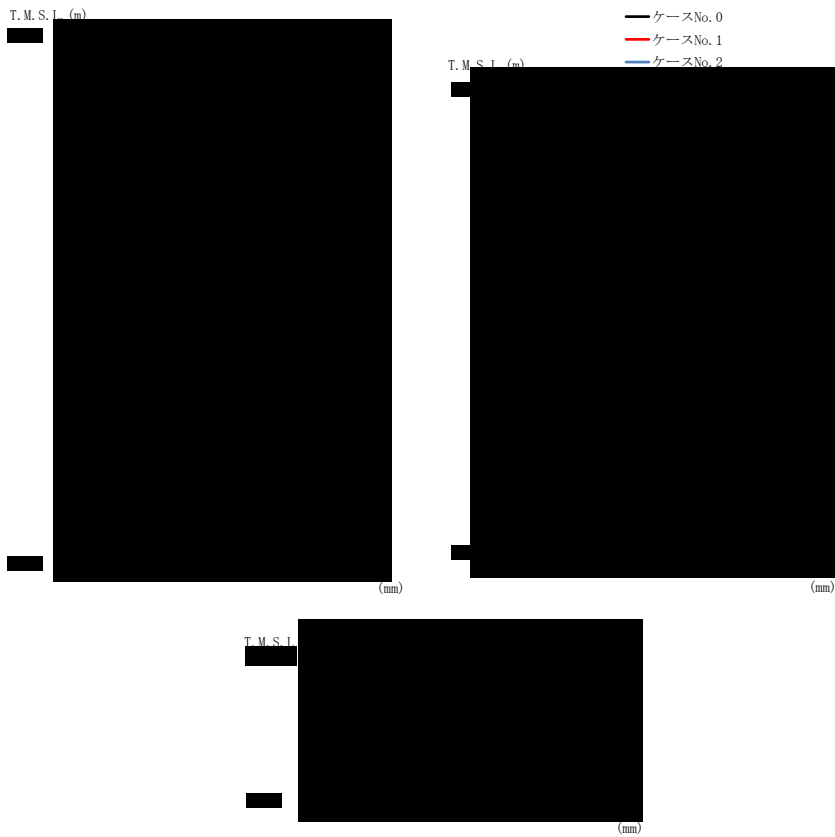

(d) S d - C 3 (E W)

第 4. 1. 3-13 図 最大応答変位 (NS 方向) (4/6)

第 4. 1. 3-17 表 最大応答変位一覧表 (NS 方向) (4/6)

(d) S d - C 3 (E W)

T. M. S. L. (m)	質 点 番 号	最大応答変位 (mm)		
		ケース No. 0	ケース No. 1	ケース No. 2

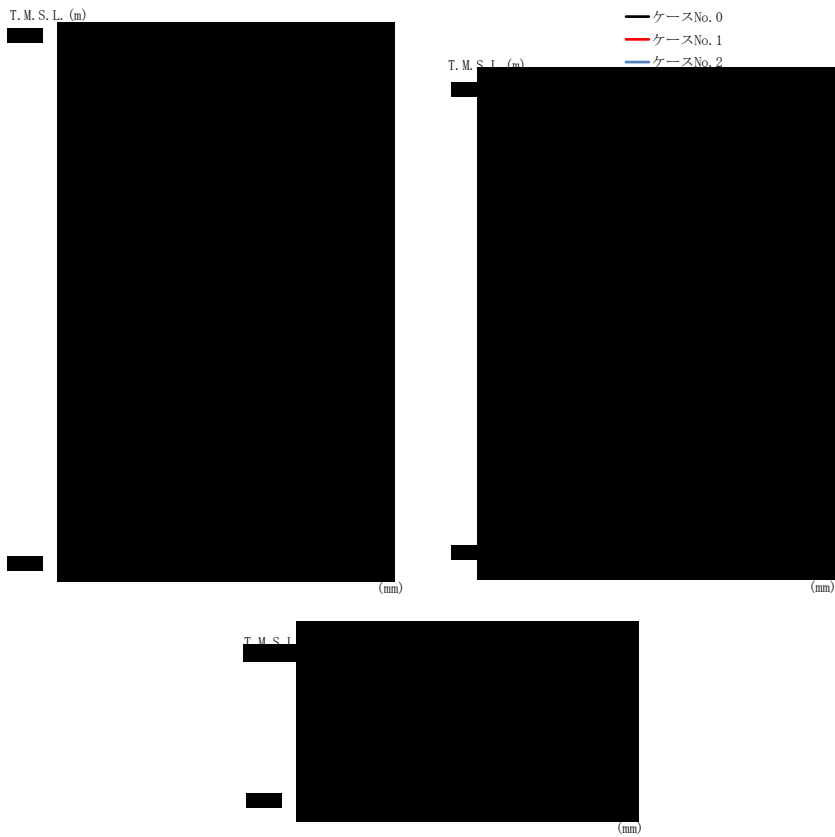

(e) S d - C 4 (N S)

第 4. 1. 3-13 図 最大応答変位 (NS 方向) (5/6)

第 4. 1. 3-17 表 最大応答変位一覧表 (NS 方向) (5/6)

(e) S d - C 4 (N S)

T. M. S. L. (m)	質 点 番 号	最大応答変位 (mm)		
		ケース No. 0	ケース No. 1	ケース No. 2
[Redacted Data]				

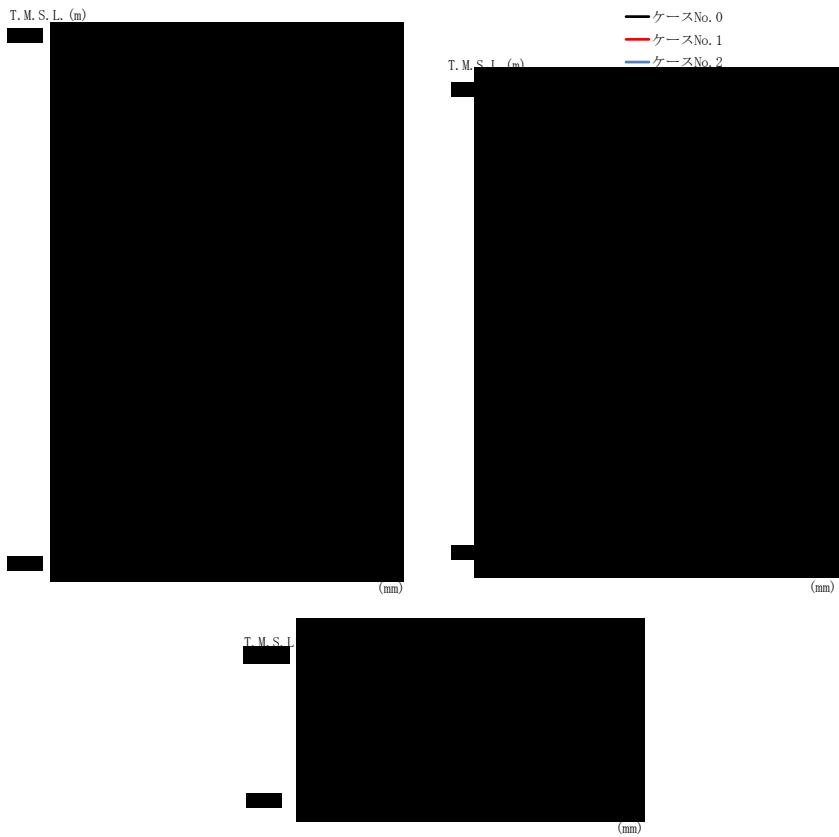

(f) S d - C 4 (E W)

第 4. 1. 3-13 図 最大応答変位 (NS 方向) (6/6)

第 4. 1. 3-17 表 最大応答変位一覧表 (NS 方向) (6/6)

(f) S d - C 4 (E W)

T. M. S. L. (m)	質 点 番 号	最大応答変位 (mm)		
		ケース No. 0	ケース No. 1	ケース No. 2

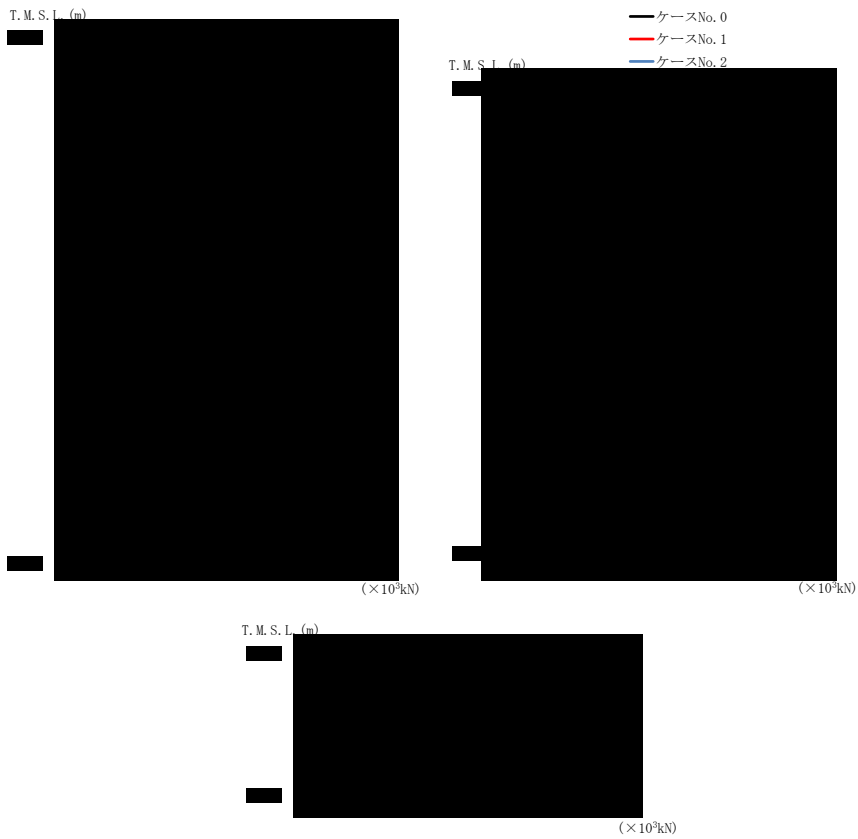

(a) S d - A (H)

第 4. 1. 3-14 図 最大応答せん断力 (NS 方向) (1/6)

第 4. 1. 3-18 表 最大応答せん断力一覧表 (NS 方向) (1/6)

(a) S d - A (H)

T. M. S. L. (m)	要素 番号	最大応答せん断力 (×10 ³ kN)		
		ケース No. 0	ケース No. 1	ケース No. 2
[Redacted Data]				

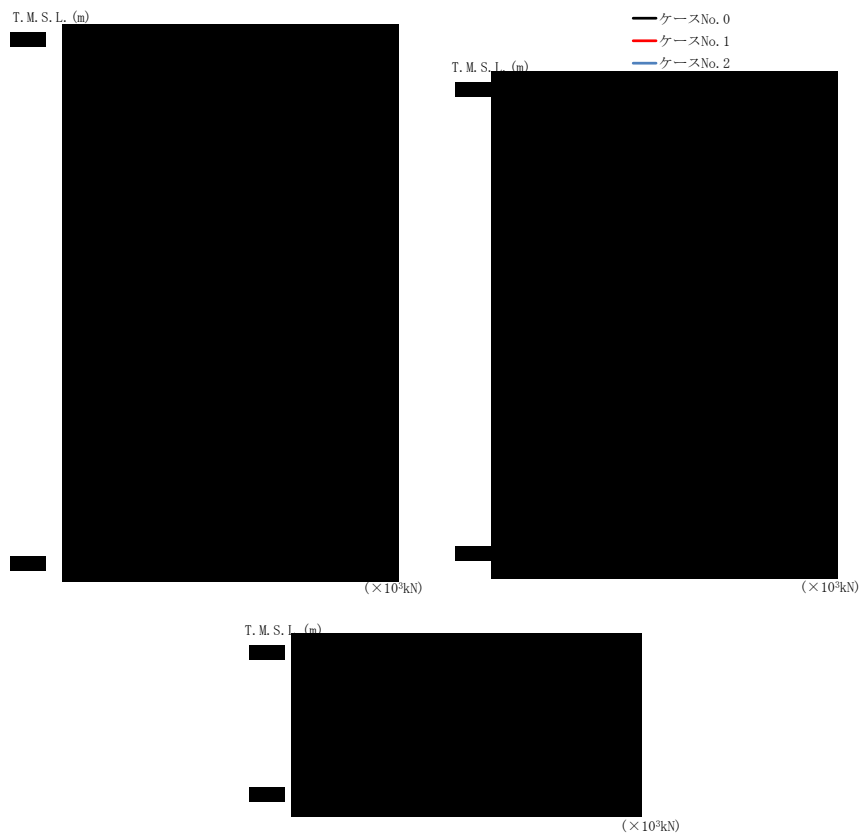

(b) S d - C 1 (N S E W)

第 4. 1. 3-14 図 最大応答せん断力 (NS 方向) (2/6)

第 4. 1. 3-18 表 最大応答せん断力一覧表 (NS 方向) (2/6)

(b) S d - C 1 (N S E W)

T. M. S. L. (m)	要素 番号	最大応答せん断力 (×10 ³ kN)		
		ケース No. 0	ケース No. 1	ケース No. 2
[Redacted Data]				

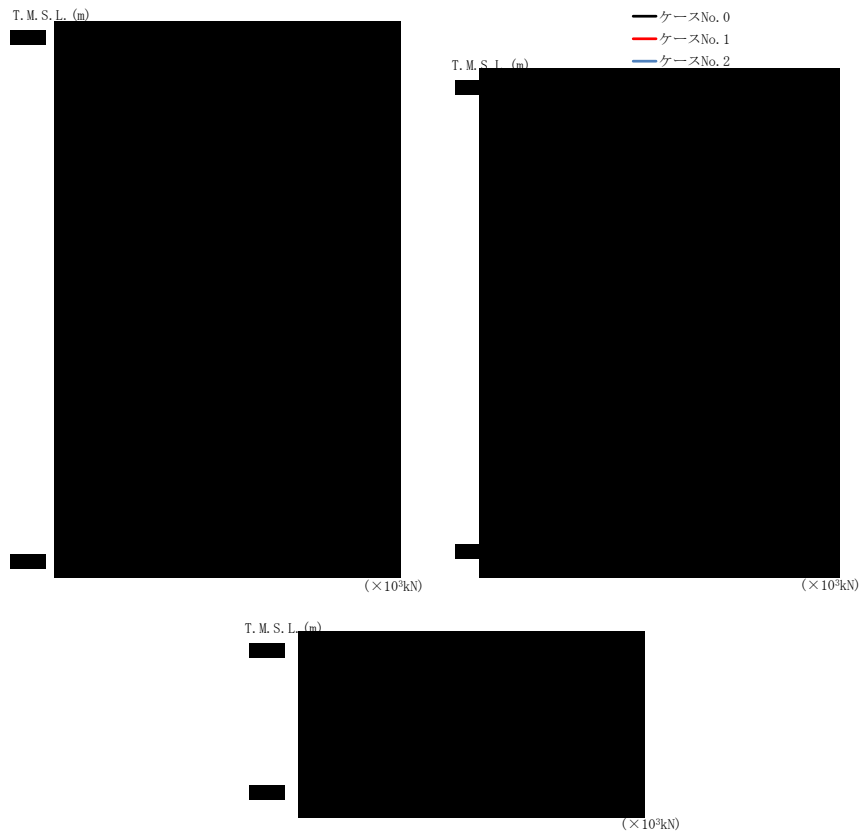

(c) S d - C 3 (NS)

第 4. 1. 3-14 図 最大応答せん断力 (NS 方向) (3/6)

第 4. 1. 3-18 表 最大応答せん断力一覧表 (NS 方向) (3/6)

(c) S d - C 3 (NS)

T. M. S. L. (m)	要素 番号	最大応答せん断力 (×10 ³ kN)		
		ケース No. 0	ケース No. 1	ケース No. 2
[Redacted Data]				

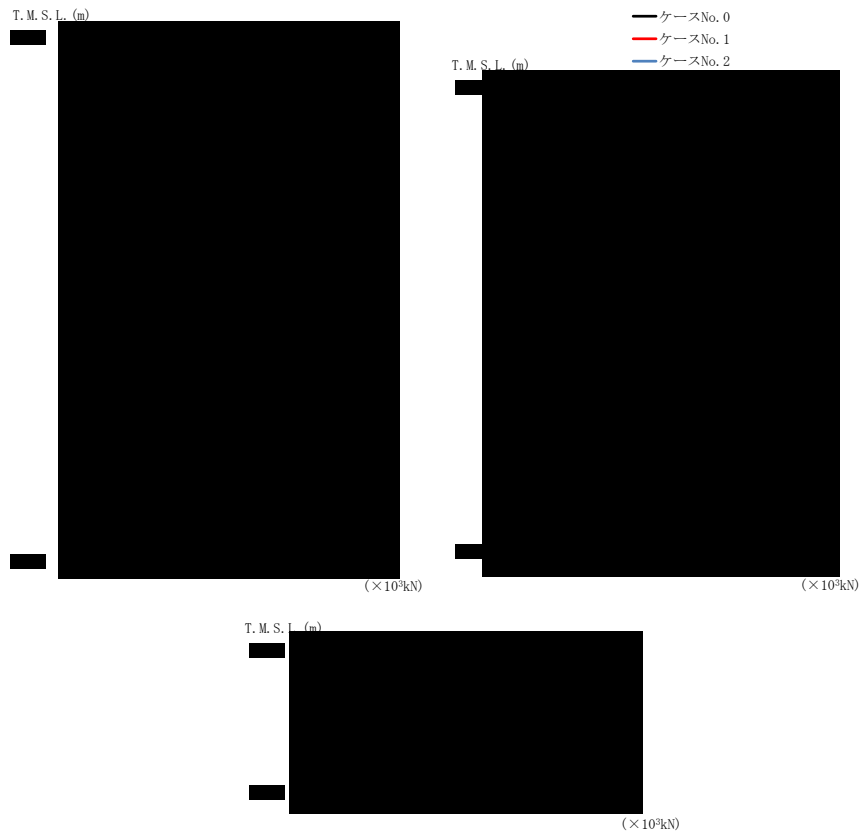

(d) S d - C 3 (E W)

第 4. 1. 3-14 図 最大応答せん断力 (NS 方向) (4/6)

第 4. 1. 3-18 表 最大応答せん断力一覧表 (NS 方向) (4/6)

(d) S d - C 3 (E W)

T. M. S. L. (m)	要素 番号	最大応答せん断力 (×10 ³ kN)		
		ケース No. 0	ケース No. 1	ケース No. 2
[Redacted data]				



(e) S d - C 4 (NS)

第 4. 1. 3-14 図 最大応答せん断力 (NS 方向) (5/6)

第 4. 1. 3-18 表 最大応答せん断力一覧表 (NS 方向) (5/6)

(e) S d - C 4 (NS)

T. M. S. L. (m)	要素 番号	最大応答せん断力 (×10 ³ kN)		
		ケース No. 0	ケース No. 1	ケース No. 2
[Redacted Data]				



(f) S d - C 4 (E W)

第 4. 1. 3-14 図 最大応答せん断力 (NS 方向) (6 / 6)

第 4. 1. 3-18 表 最大応答せん断力一覧表 (NS 方向) (6 / 6)

(f) S d - C 4 (E W)

T. M. S. L. (m)	要素 番号	最大応答せん断力 ($\times 10^3$ kN)		
		ケース No. 0	ケース No. 1	ケース No. 2
[Redacted Data]				

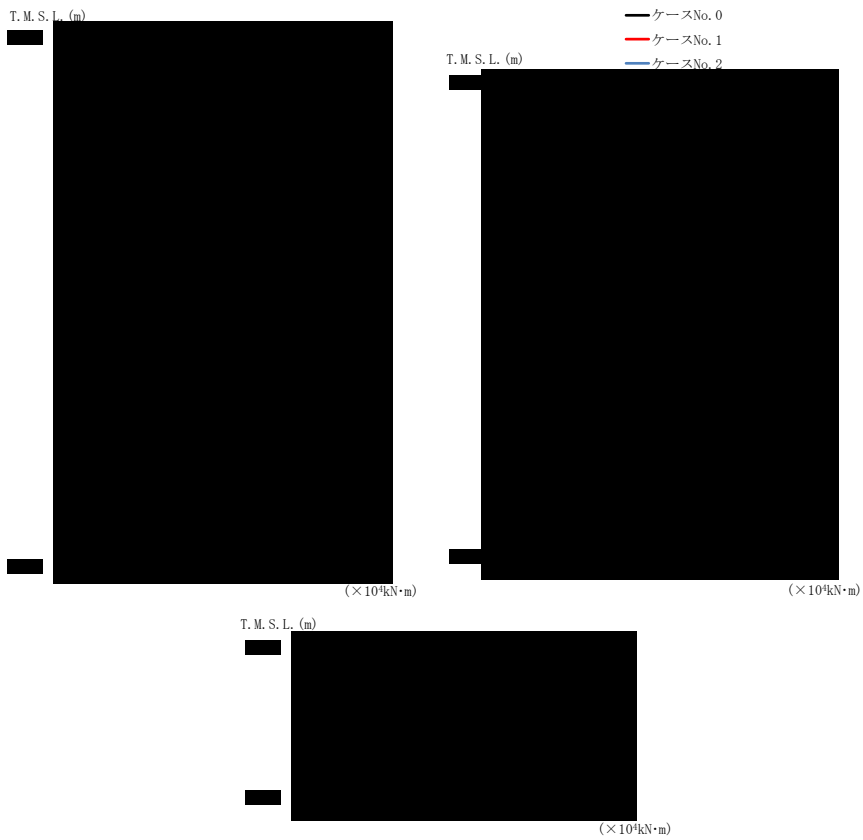

(a) S d - A (H)

第 4. 1. 3-15 図 最大応答曲げモーメント (NS 方向) (1/6)

第 4. 1. 3-19 表 最大応答曲げモーメント一覧表 (NS 方向) (1/6)

(a) S d - A (H)

T. M. S. L. (m)	要素 番号	最大応答曲げモーメント (×10 ⁴ kN·m)		
		ケース No. 0	ケース No. 1	ケース No. 2
[Redacted data]				

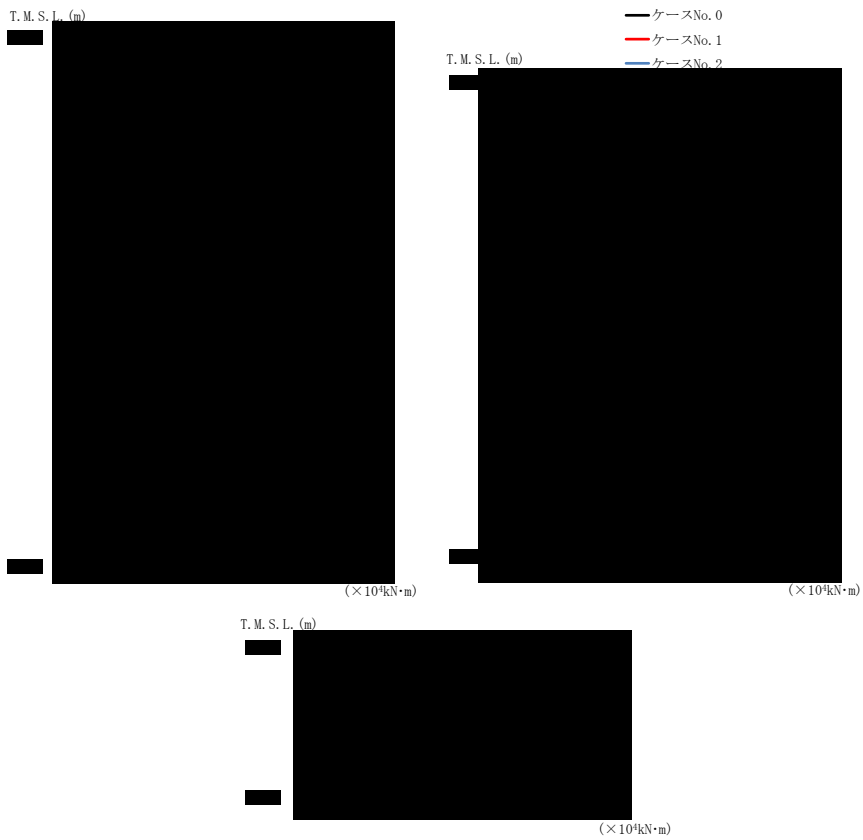

(b) S d - C 1 (N S E W)

第 4. 1. 3-15 図 最大応答曲げモーメント (NS 方向) (2/6)

第 4. 1. 3-19 表 最大応答曲げモーメント一覧表 (NS 方向) (2/6)

(b) S d - C 1 (N S E W)

T. M. S. L. (m)	要素 番号	最大応答曲げモーメント (×10 ⁴ kN·m)		
		ケース No. 0	ケース No. 1	ケース No. 2
[Redacted data]				

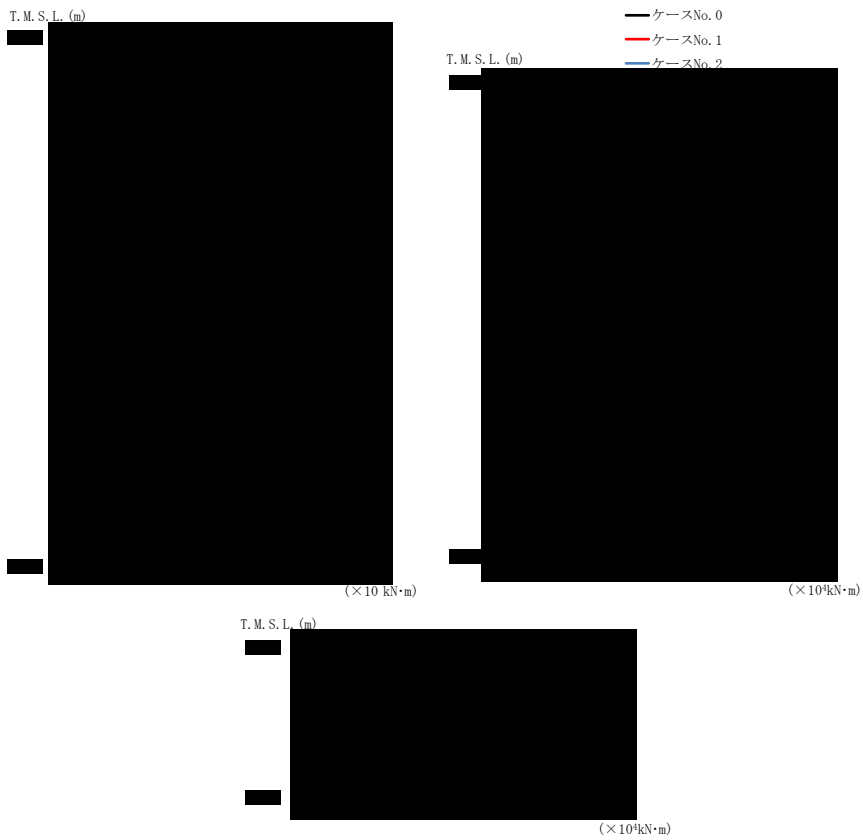

(c) S d - C 3 (NS)

第 4. 1. 3-15 図 最大応答曲げモーメント (NS 方向) (3/6)

第 4. 1. 3-19 表 最大応答曲げモーメント一覧表 (NS 方向) (3/6)

(c) S d - C 3 (NS)

T.M.S.L. (m)	要素 番号	最大応答曲げモーメント (×10 ⁴ kN·m)		
		ケース No. 0	ケース No. 1	ケース No. 2

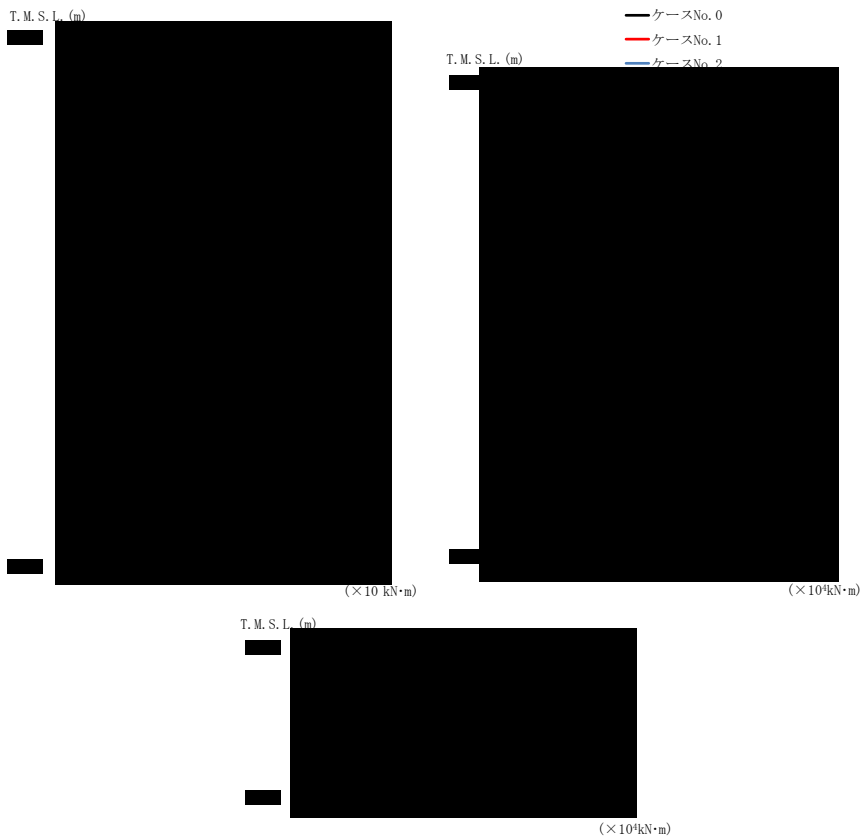

(d) S d - C 3 (E W)

第 4. 1. 3-15 図 最大応答曲げモーメント (NS 方向) (4/6)

第 4. 1. 3-19 表 最大応答曲げモーメント一覧表 (NS 方向) (4/6)

(d) S d - C 3 (E W)

T.M.S.L. (m)	要素 番号	最大応答曲げモーメント (x10^4 kN·m)		
		ケース No. 0	ケース No. 1	ケース No. 2
[Redacted data]				

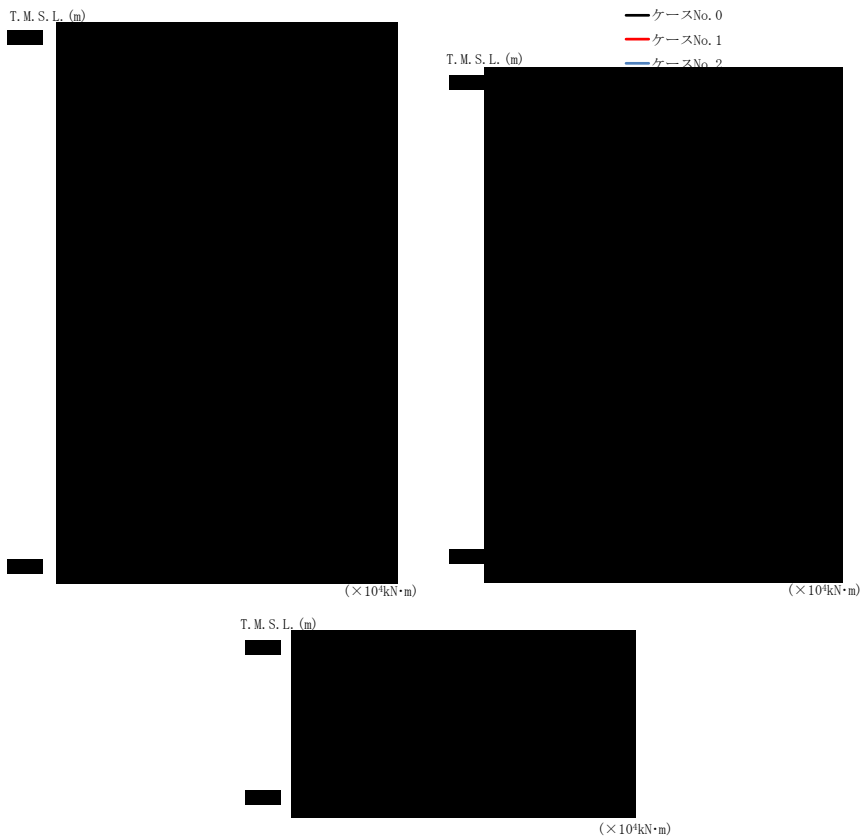

(e) S d - C 4 (N S)

第 4. 1. 3-15 図 最大応答曲げモーメント (NS 方向) (5/6)

第 4. 1. 3-19 表 最大応答曲げモーメント一覧表 (NS 方向) (5/6)

(e) S d - C 4 (N S)

T. M. S. L. (m)	要素 番号	最大応答曲げモーメント (×10 ⁴ kN·m)		
		ケース No. 0	ケース No. 1	ケース No. 2
[Redacted data]				

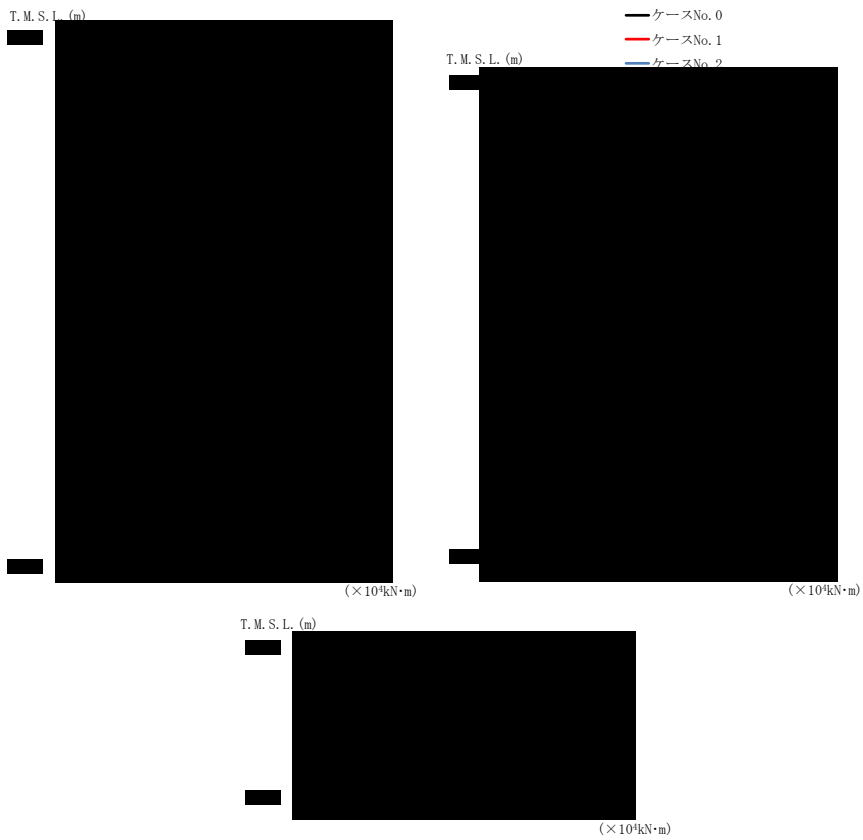

(f) S d - C 4 (E W)

第 4. 1. 3-15 図 最大応答曲げモーメント (NS 方向) (6 / 6)

第 4. 1. 3-19 表 最大応答曲げモーメント一覧表 (NS 方向) (6 / 6)

(f) S d - C 4 (E W)

T. M. S. L. (m)	要素 番号	最大応答曲げモーメント ($\times 10^4 \text{ kN}\cdot\text{m}$)		
		ケース No. 0	ケース No. 1	ケース No. 2
[Redacted data]				



(a) S d - A (H)

第 4.1.3-16 図 最大応答加速度 (EW 方向) (1/6)

第 4.1.3-20 表 最大応答加速度一覧表 (EW 方向) (1/6)

(a) S d - A (H)

T.M.S.L. (m)	質 点 番 号	最大応答加速度 (cm/s ²)		
		ケ-ス No. 0	ケ-ス No. 1	ケ-ス No. 2
[Redacted Data]				

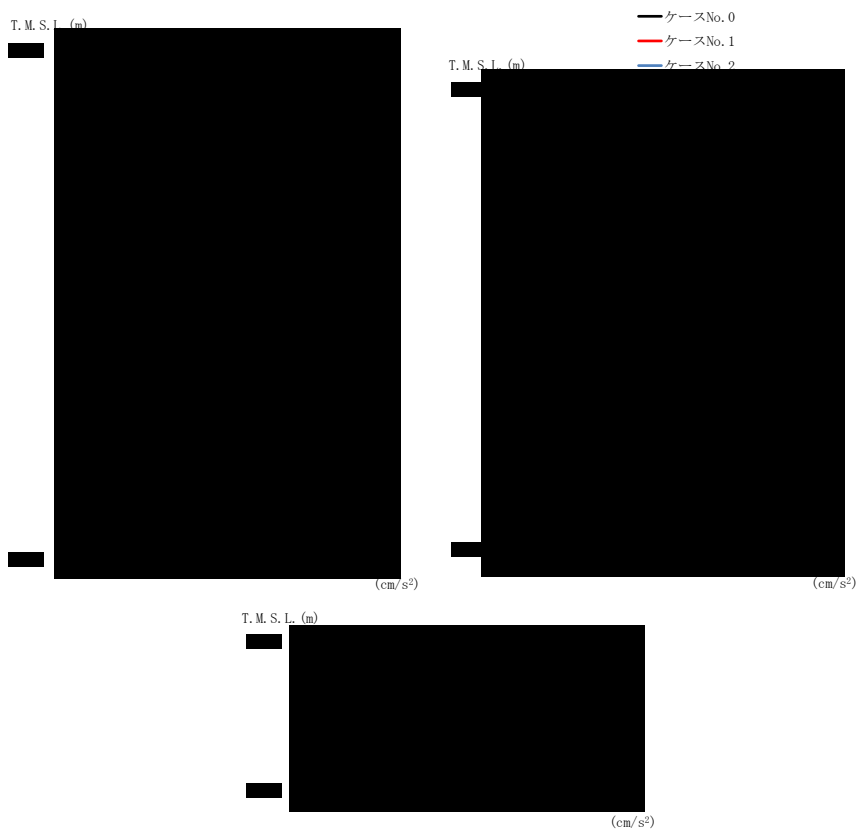

(b) S d - C 1 (N S E W)

第 4. 1. 3-16 図 最大応答加速度 (EW 方向) (2/6)

第 4. 1. 3-20 表 最大応答加速度一覧表 (EW 方向) (2/6)

(b) S d - C 1 (N S E W)

T. M. S. L. (m)	質 点 番 号	最大応答加速度 (cm/s ²)		
		ケース No. 0	ケース No. 1	ケース No. 2

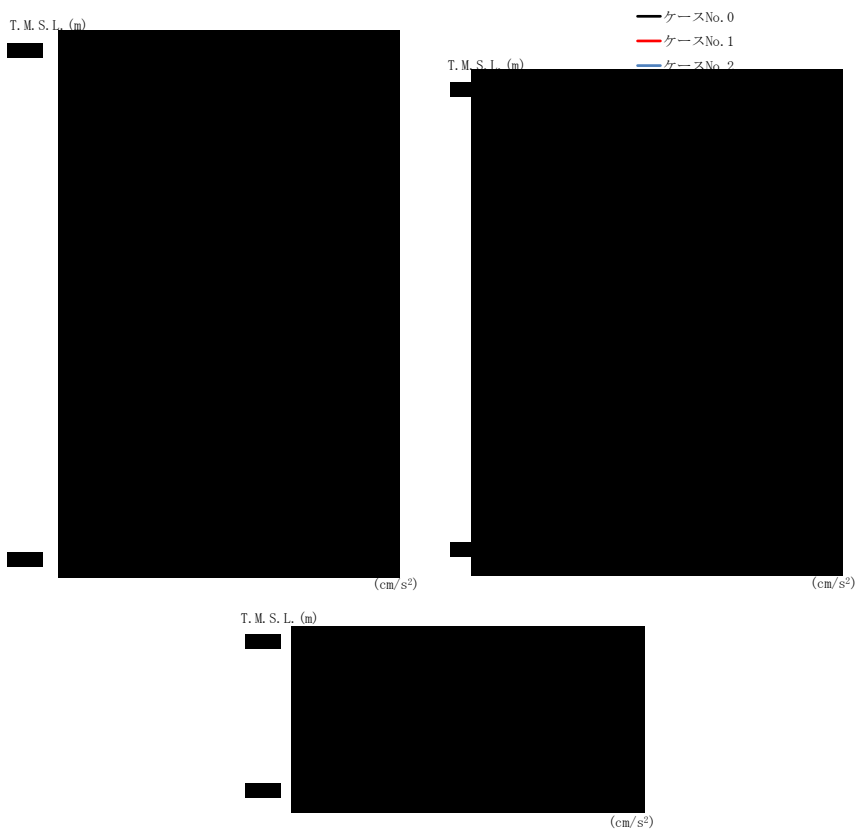

(c) S d - C 3 (N S)

第 4. 1. 3-16 図 最大応答加速度 (EW 方向) (3/6)

第 4. 1. 3-20 表 最大応答加速度一覧表 (EW 方向) (3/6)

(c) S d - C 3 (N S)

T. M. S. L. (m)	質点番号	最大応答加速度 (cm/s ²)		
		ケース No. 0	ケース No. 1	ケース No. 2
[Redacted Data]				



(d) S d - C 3 (EW)

第 4. 1. 3-16 図 最大応答加速度 (EW 方向) (4/6)

第 4. 1. 3-20 表 最大応答加速度一覧表 (EW 方向) (4/6)

(d) S d - C 3 (EW)

T. M. S. L. (m)	質 点 番 号	最大応答加速度 (cm/s ²)		
		ケース No. 0	ケース No. 1	ケース No. 2
[Redacted Data]				

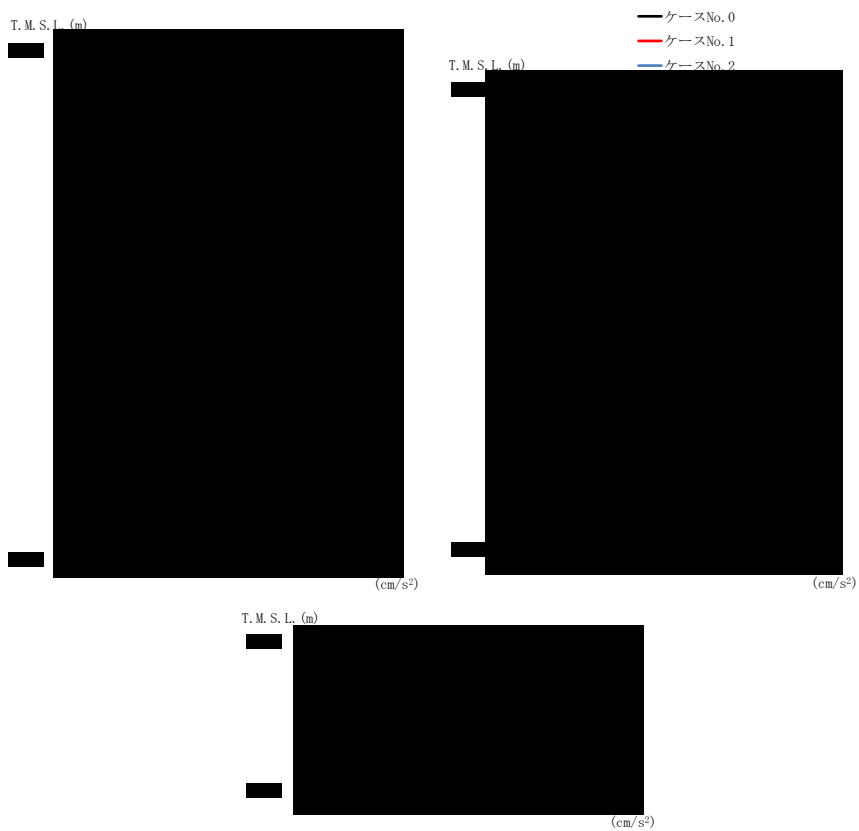

(e) S d - C 4 (N S)

第 4. 1. 3-16 図 最大応答加速度 (EW 方向) (5/6)

第 4. 1. 3-20 表 最大応答加速度一覧表 (EW 方向) (5/6)

(e) S d - C 4 (N S)

T. M. S. L. (m)	質 点 番 号	最大応答加速度 (cm/s ²)		
		ケース No. 0	ケース No. 1	ケース No. 2
[Redacted Data]				

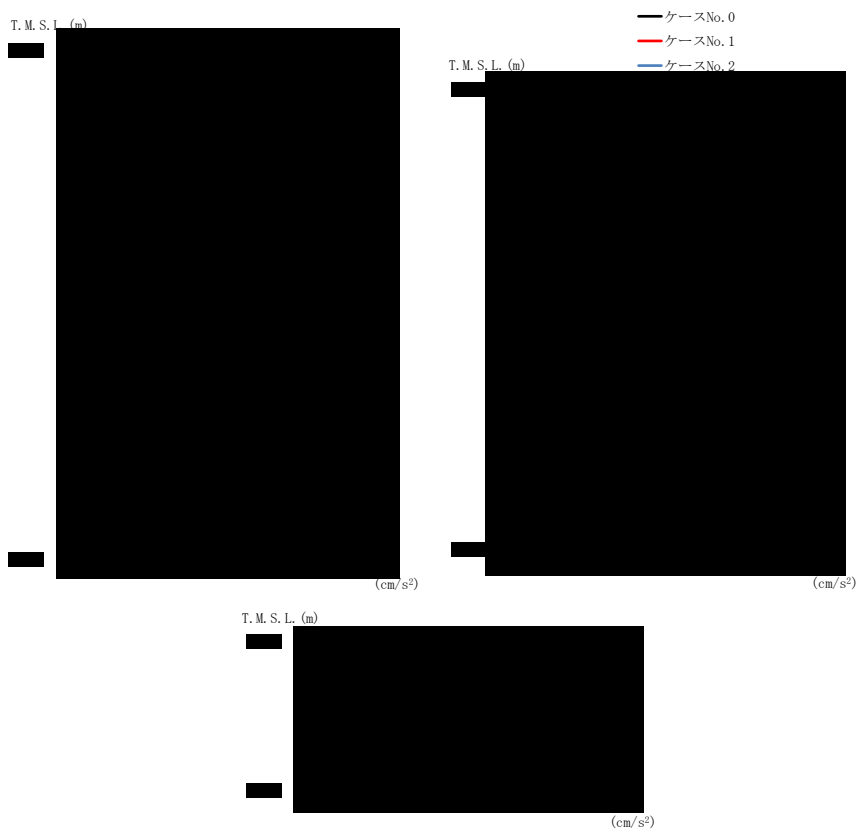

(f) S d - C 4 (EW)

第 4. 1. 3-16 図 最大応答加速度 (EW 方向) (6/6)

第 4. 1. 3-20 表 最大応答加速度一覧表 (EW 方向) (6/6)

(f) S d - C 4 (EW)

T. M. S. L. (m)	質 点 番 号	最大応答加速度 (cm/s ²)		
		ケース No. 0	ケース No. 1	ケース No. 2
[Redacted Data]				

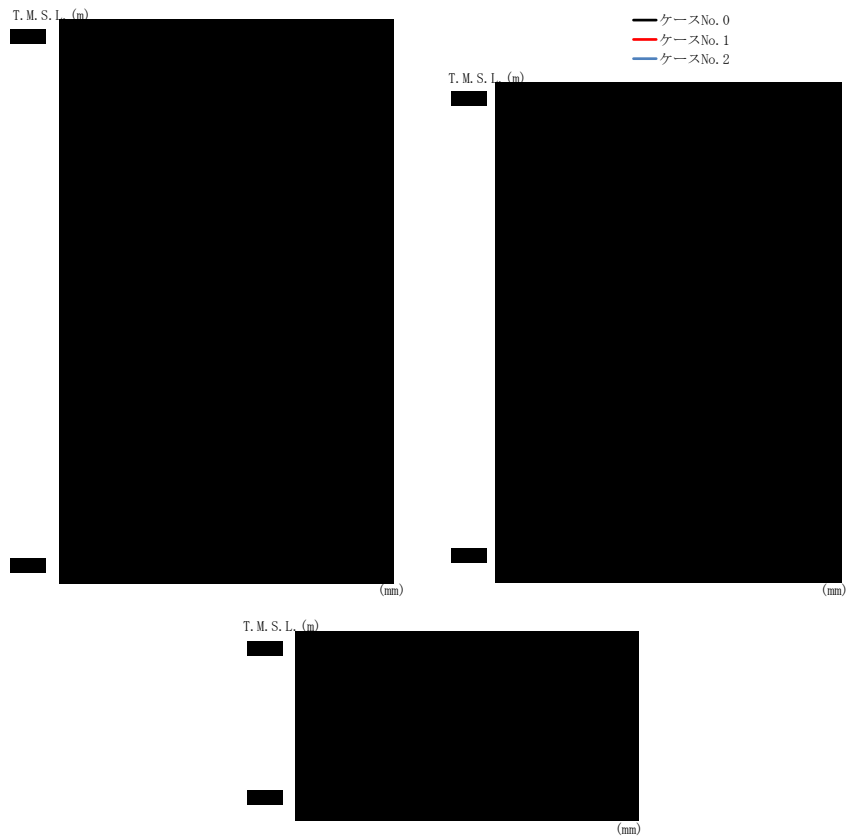

(a) S d - A (H)

第 4. 1. 3-17 図 最大応答変位 (EW 方向) (1/6)

第 4. 1. 3-21 表 最大応答変位一覧表 (EW 方向) (1/6)

(a) S d - A (H)

T. M. S. L. (m)	質 点 番 号	最大応答変位 (mm)		
		ケース No. 0	ケース No. 1	ケース No. 2
[Redacted Data]				

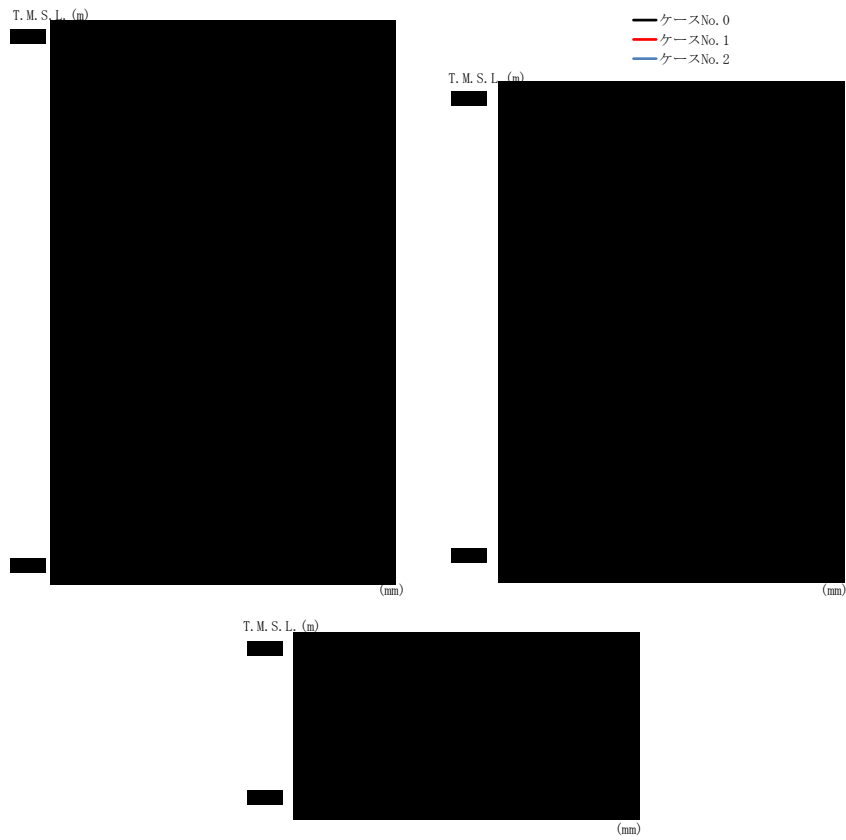

(b) S d - C 1 (N S E W)

第 4. 1. 3-17 図 最大応答変位 (EW 方向) (2/6)

第 4. 1. 3-21 表 最大応答変位一覧表 (EW 方向) (2/6)

(b) S d - C 1 (N S E W)

T. M. S. L. (m)	質 点 番 号	最大応答変位 (mm)		
		ケース No. 0	ケース No. 1	ケース No. 2

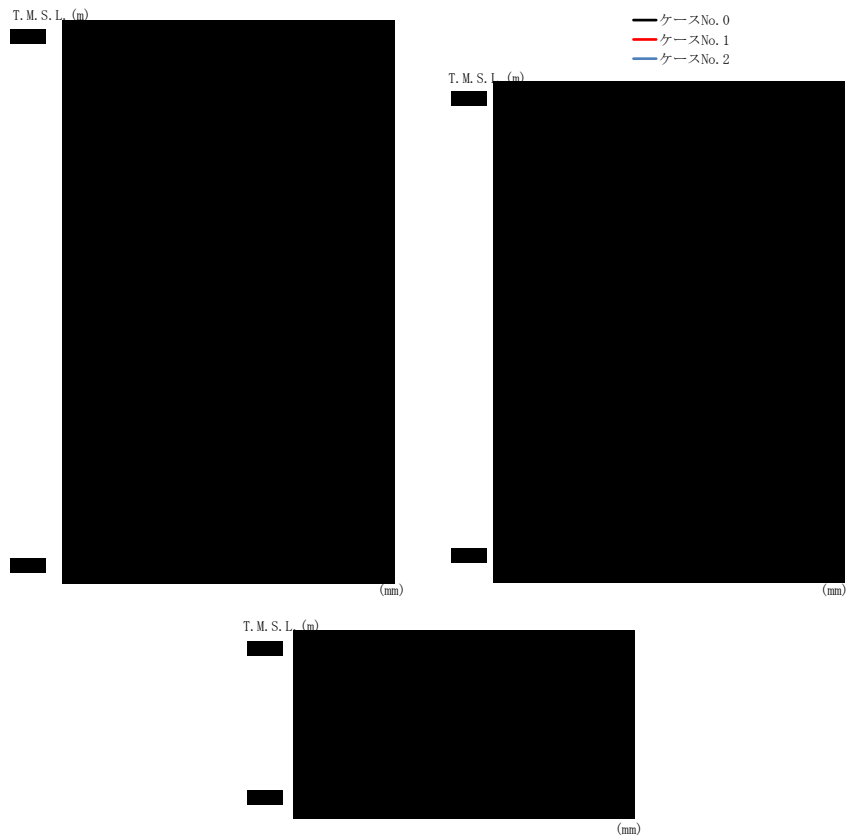

(c) S d - C 3 (N S)

第 4. 1. 3-17 図 最大応答変位 (EW 方向) (3/6)

第 4. 1. 3-21 表 最大応答変位一覧表 (EW 方向) (3/6)

(c) S d - C 3 (N S)

T. M. S. L. (m)	質 点 番 号	最大応答変位 (mm)		
		ケース No. 0	ケース No. 1	ケース No. 2

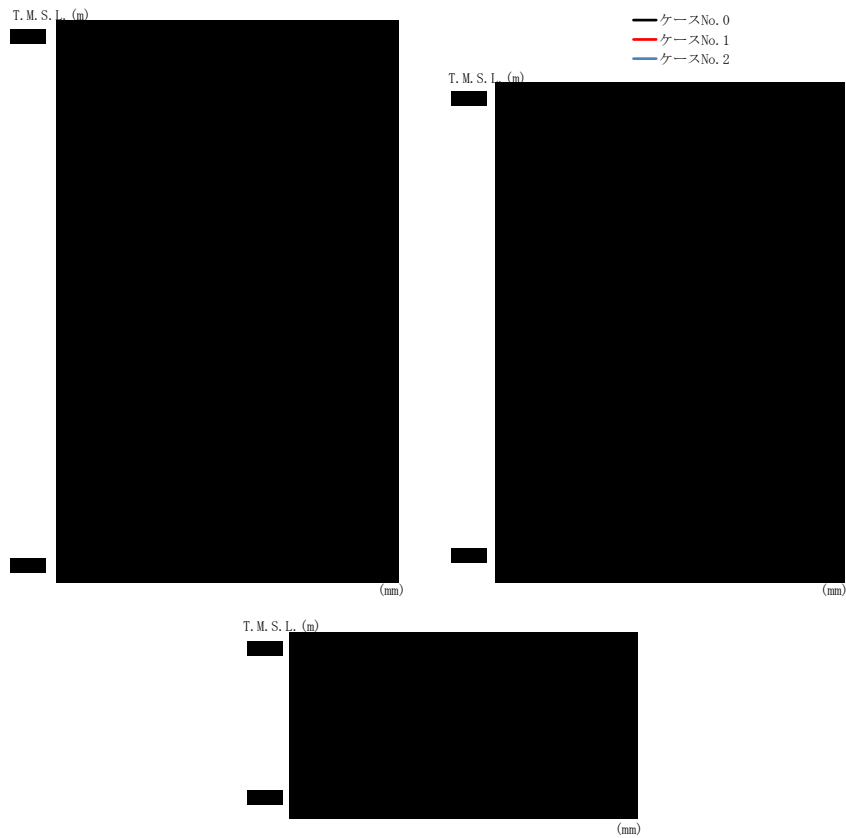

(d) S d - C 3 (EW)

第 4. 1. 3-17 図 最大応答変位 (EW 方向) (4/6)

第 4. 1. 3-21 表 最大応答変位一覧表 (EW 方向) (4/6)

(d) S d - C 3 (EW)

T. M. S. L. (m)	質 点 番 号	最大応答変位 (mm)		
		ケース No. 0	ケース No. 1	ケース No. 2

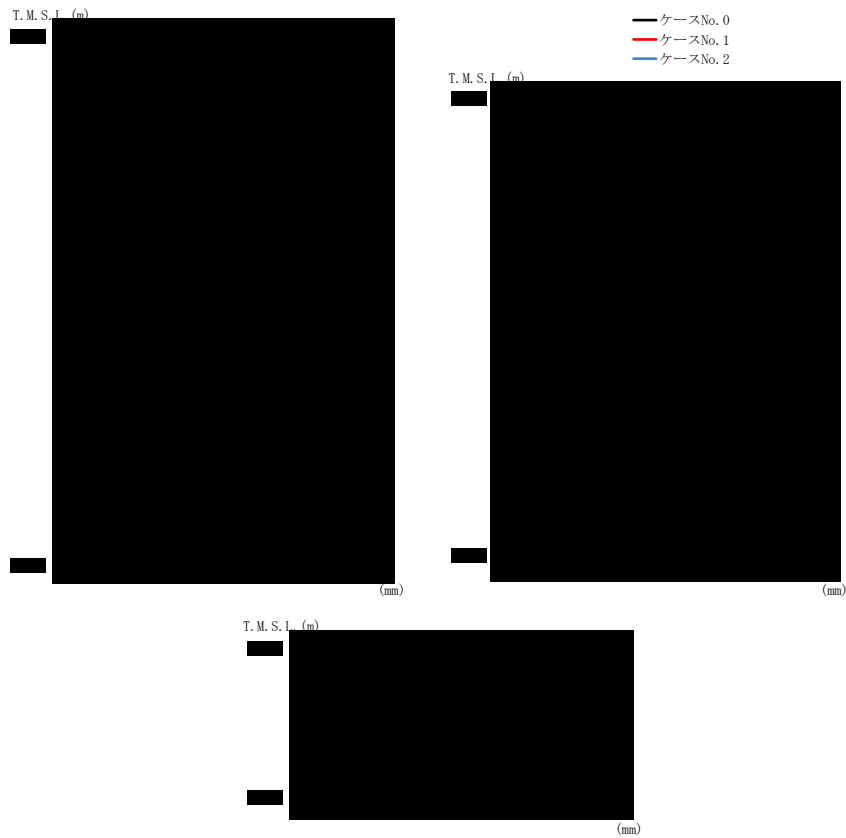

(e) S d - C 4 (N S)

第 4. 1. 3-17 図 最大応答変位 (EW 方向) (5/6)

第 4. 1. 3-21 表 最大応答変位一覧表 (EW 方向) (5/6)

(e) S d - C 4 (N S)

T. M. S. L. (m)	質 点 番 号	最大応答変位 (mm)		
		ケース No. 0	ケース No. 1	ケース No. 2

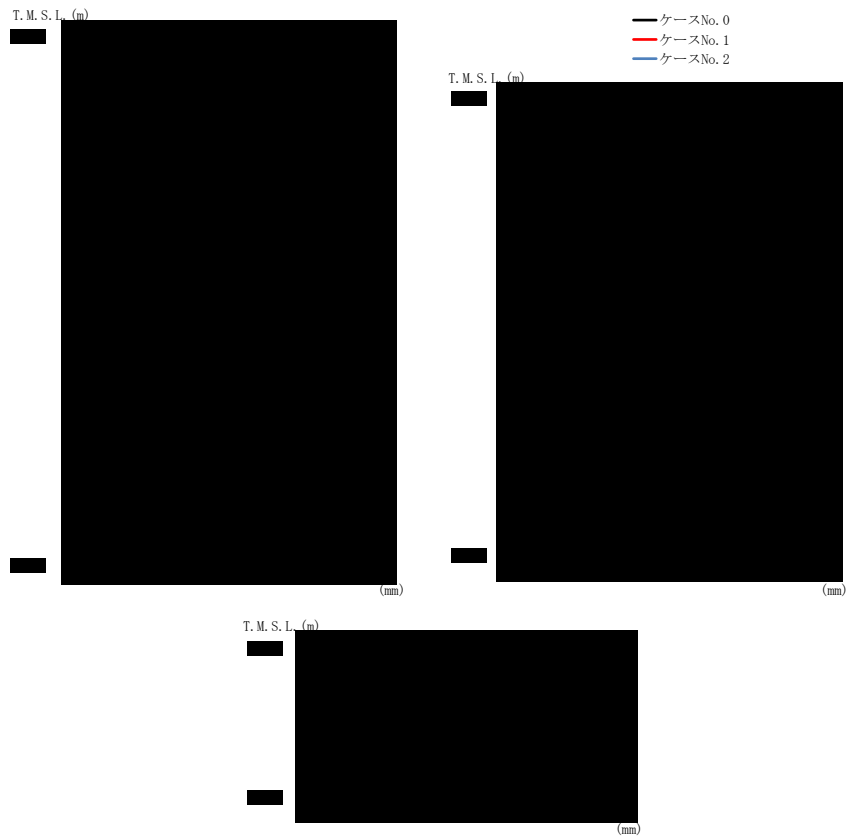

(f) S d - C 4 (EW)

第 4. 1. 3-17 図 最大応答変位 (EW 方向) (6/6)

第 4. 1. 3-21 表 最大応答変位一覧表 (EW 方向) (6/6)

(f) S d - C 4 (EW)

T. M. S. L. (m)	質 点 番 号	最大応答変位 (mm)		
		ケース No. 0	ケース No. 1	ケース No. 2

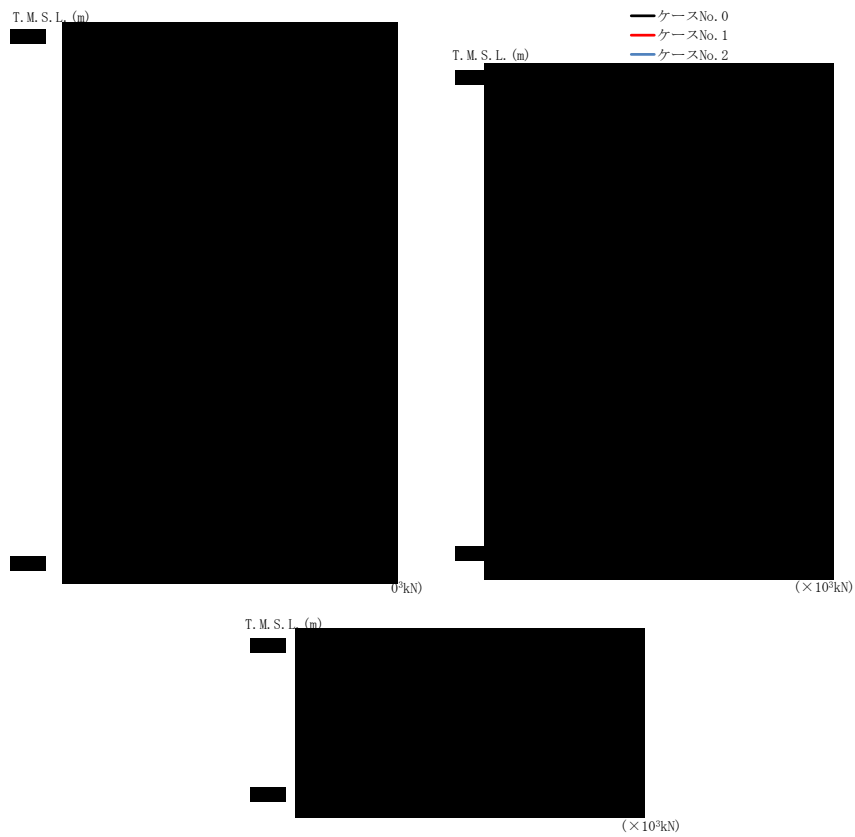

(a) S d - A (H)

第 4. 1. 3-18 図 最大応答せん断力 (EW 方向) (1/6)

第 4. 1. 3-22 表 最大応答せん断力一覧表 (EW 方向) (1/6)

(a) S d - A (H)

T. M. S. L. (m)	要素 番号	最大応答せん断力 (×10 ³ kN)		
		ケース No. 0	ケース No. 1	ケース No. 2
[Redacted Data]				



(b) S d - C 1 (N S E W)

第 4. 1. 3-18 図 最大応答せん断力 (EW 方向) (2/6)

第 4. 1. 3-22 表 最大応答せん断力一覧表 (EW 方向) (2/6)

(b) S d - C 1 (N S E W)

T. M. S. L. (m)	要素 番号	最大応答せん断力 (×10 ³ kN)		
		ケース No. 0	ケース No. 1	ケース No. 2
[Redacted Data]				



(c) S d - C 3 (NS)

第 4. 1. 3-18 図 最大応答せん断力 (EW 方向) (3/6)

第 4. 1. 3-22 表 最大応答せん断力一覧表 (EW 方向) (3/6)

(c) S d - C 3 (NS)

T. M. S. L. (m)	要素 番号	最大応答せん断力 (×10 ³ kN)		
		ケース No. 0	ケース No. 1	ケース No. 2



(d) S d - C 3 (E W)

第 4. 1. 3-18 図 最大応答せん断力 (E W 方向) (4 / 6)

第 4. 1. 3-22 表 最大応答せん断力一覧表 (E W 方向) (4 / 6)

(d) S d - C 3 (E W)

T. M. S. L. (m)	要素 番号	最大応答せん断力 ($\times 10^3$ kN)		
		ケース No. 0	ケース No. 1	ケース No. 2
[Redacted data]				

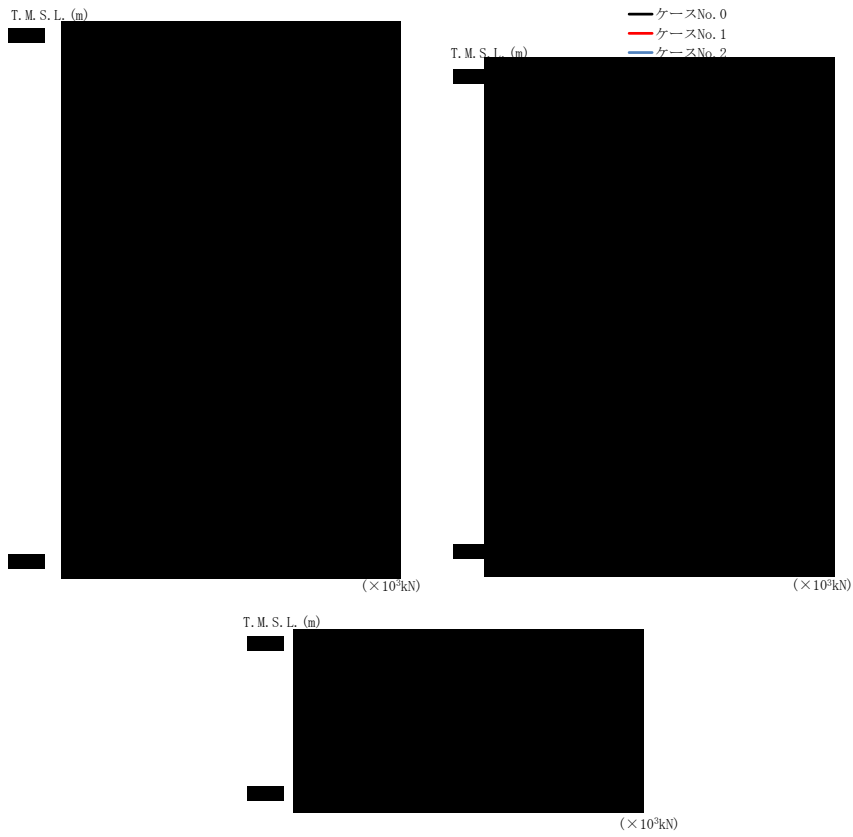

(e) S d - C 4 (N S)

第 4. 1. 3-18 図 最大応答せん断力 (EW 方向) (5/6)

第 4. 1. 3-22 表 最大応答せん断力一覧表 (EW 方向) (5/6)

(e) S d - C 4 (N S)

T. M. S. L. (m)	要素 番号	最大応答せん断力 (×10 ³ kN)		
		ケース No. 0	ケース No. 1	ケース No. 2



(f) S d - C 4 (EW)

第 4. 1. 3-18 図 最大応答せん断力 (EW 方向) (6/6)

第 4. 1. 3-22 表 最大応答せん断力一覧表 (EW 方向) (6/6)

(f) S d - C 4 (EW)

T. M. S. L. (m)	要素 番号	最大応答せん断力 (×10 ³ kN)		
		ケース No. 0	ケース No. 1	ケース No. 2
[Redacted Data]				

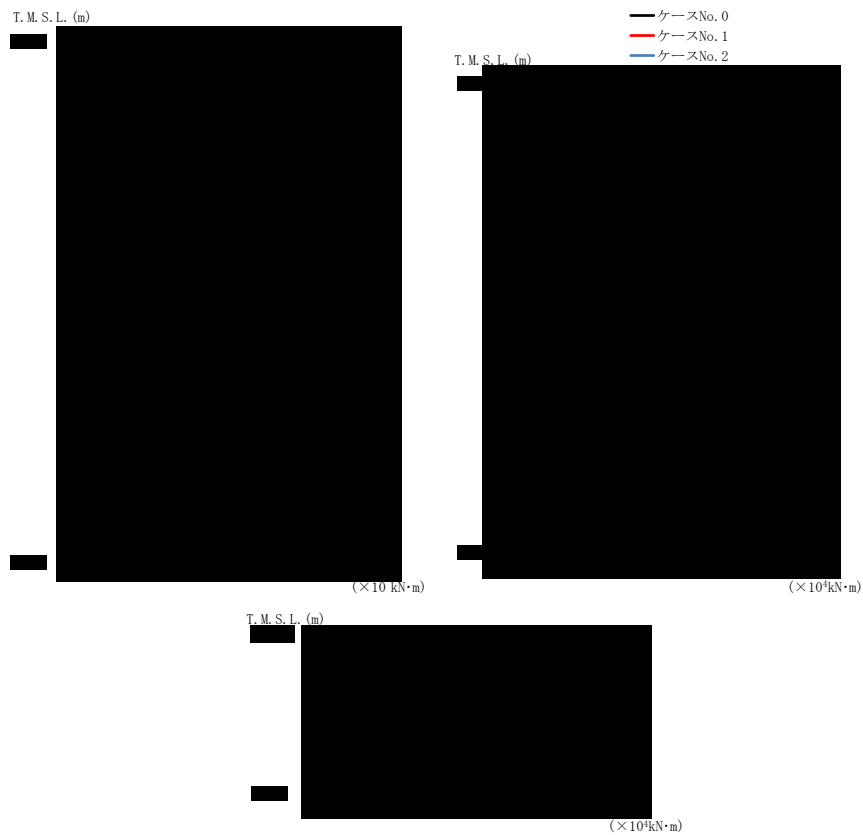

(a) S d - A (H)

第 4. 1. 3-19 図 最大応答曲げモーメント (EW 方向) (1/6)

第 4. 1. 3-23 表 最大応答曲げモーメント一覧表 (EW 方向) (1/6)

(a) S d - A (H)

T. M. S. L. (m)	要素番号	最大応答曲げモーメント (x10 ⁴ kN·m)		
		ケース No. 0	ケース No. 1	ケース No. 2
[Redacted Data]				

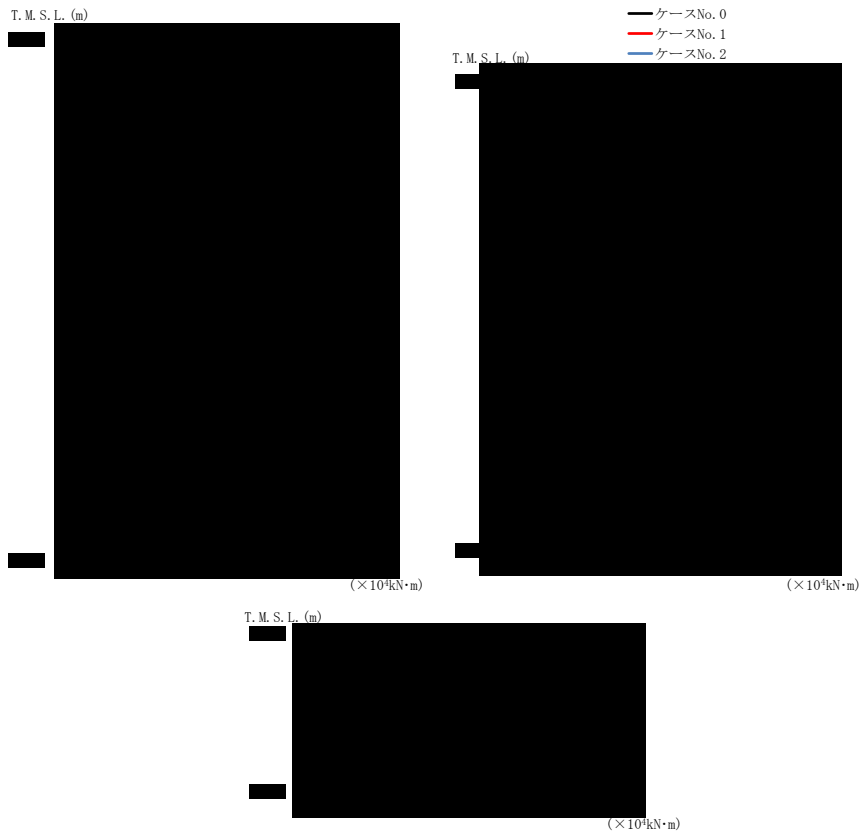

(b) S d - C 1 (N S E W)

第 4. 1. 3-19 図 最大応答曲げモーメント (EW 方向) (2/6)

第 4. 1. 3-23 表 最大応答曲げモーメント一覧表 (EW 方向) (2/6)

(b) S d - C 1 (N S E W)

T. M. S. L. (m)	要素 番号	最大応答曲げモーメント (×10 ⁴ kN·m)		
		ケース No. 0	ケース No. 1	ケース No. 2
[Redacted Data]				



(c) S d - C 3 (NS)

第 4.1.3-19 図 最大応答曲げモーメント (EW 方向) (3/6)

第 4.1.3-23 表 最大応答曲げモーメント一覧表 (EW 方向) (3/6)

(c) S d - C 3 (NS)

T. M. S. L. (m)	要素 番号	最大応答曲げモーメント (×10 ⁴ kN·m)		
		ケース No. 0	ケース No. 1	ケース No. 2
[Redacted Data]				



(d) S d - C 3 (EW)

第 4. 1. 3-19 図 最大応答曲げモーメント (EW 方向) (4/6)

第 4. 1. 3-23 表 最大応答曲げモーメント一覧表 (EW 方向) (4/6)

(d) S d - C 3 (EW)

T. M. S. L. (m)	要素 番号	最大応答曲げモーメント (×10 ⁴ kN·m)		
		ケース No. 0	ケース No. 1	ケース No. 2

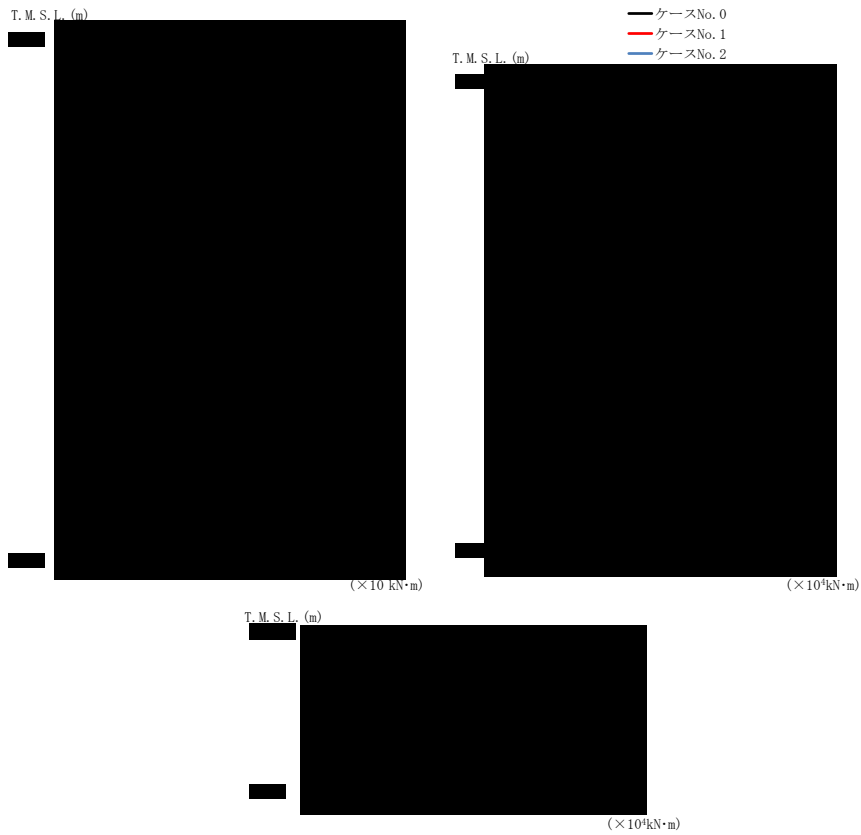

(e) S d - C 4 (NS)

第 4. 1. 3-19 図 最大応答曲げモーメント (EW 方向) (5/6)

第 4. 1. 3-23 表 最大応答曲げモーメント一覧表 (EW 方向) (5/6)

(e) S d - C 4 (NS)

T. M. S. L. (m)	要素 番号	最大応答曲げモーメント (×10 ⁴ kN·m)		
		ケース No. 0	ケース No. 1	ケース No. 2
[Redacted Data]				



(f) S d - C 4 (EW)

第 4. 1. 3-19 図 最大応答曲げモーメント (EW 方向) (6/6)

第 4. 1. 3-23 表 最大応答曲げモーメント一覧表 (EW 方向) (6/6)

(f) S d - C 4 (EW)

T. M. S. L. (m)	要素 番号	最大応答曲げモーメント (×10 ⁴ kN·m)		
		ケース No. 0	ケース No. 1	ケース No. 2



(a) S d - A (V)

第 4. 1. 3-20 図 最大応答加速度（鉛直方向）（1/3）

第 4. 1. 3-24 表 最大応答加速度一覧表（鉛直方向）（1/3）

(a) S d - A (V)

T. M. S. L. (m)	質 点 番 号	最大応答加速度 (cm/s ²)		
		ケース No. 0	ケース No. 1	ケース No. 2
[Redacted Data]				

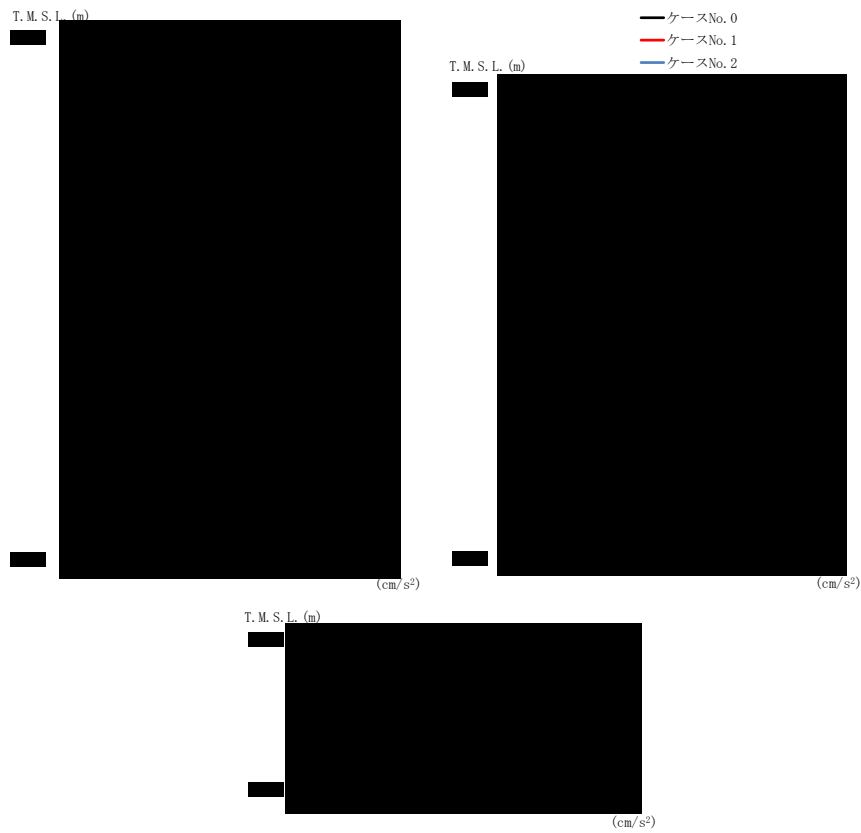

(b) S d - C 1 (UD)

第 4. 1. 3-20 図 最大応答加速度 (鉛直方向) (2/3)

第 4. 1. 3-24 表 最大応答加速度一覧表 (鉛直方向) (2/3)

(b) S d - C 1 (UD)

T. M. S. L. (m)	質 点 番 号	最大応答加速度 (cm/s ²)		
		ケース No. 0	ケース No. 1	ケース No. 2
[Redacted Data]				

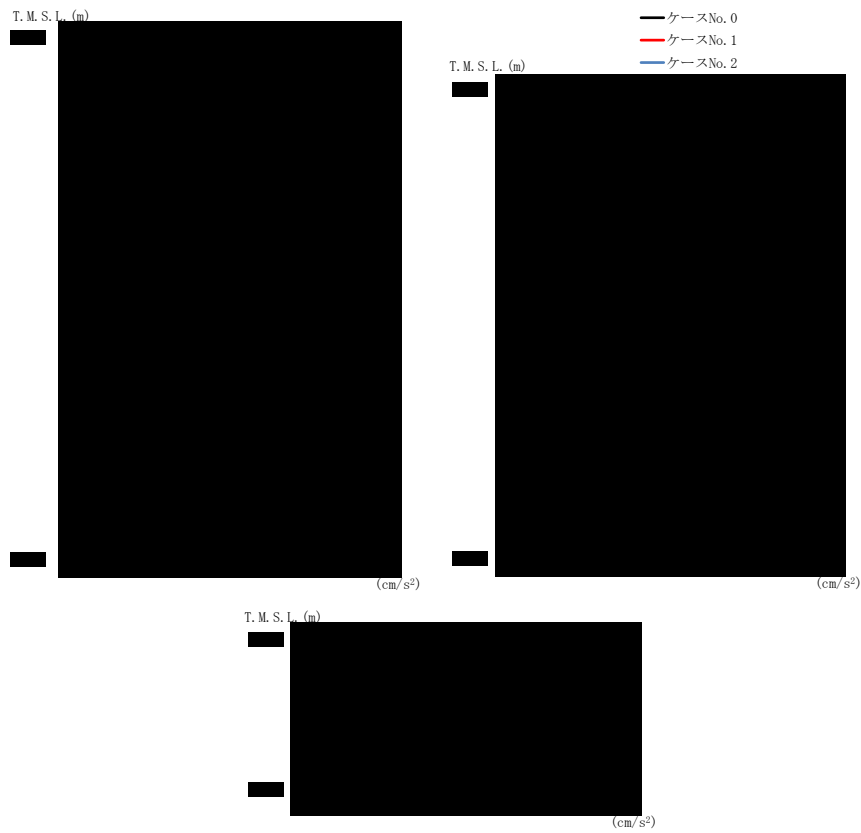

(c) S d - C 3 (UD)

第 4. 1. 3-20 図 最大応答加速度 (鉛直方向) (3/3)

第 4. 1. 3-24 表 最大応答加速度一覧表 (鉛直方向) (3/3)

(c) S d - C 3 (UD)

T. M. S. L. (m)	質 点 番 号	最大応答加速度 (cm/s ²)		
		ケース No. 0	ケース No. 1	ケース No. 2
[Redacted Data]				

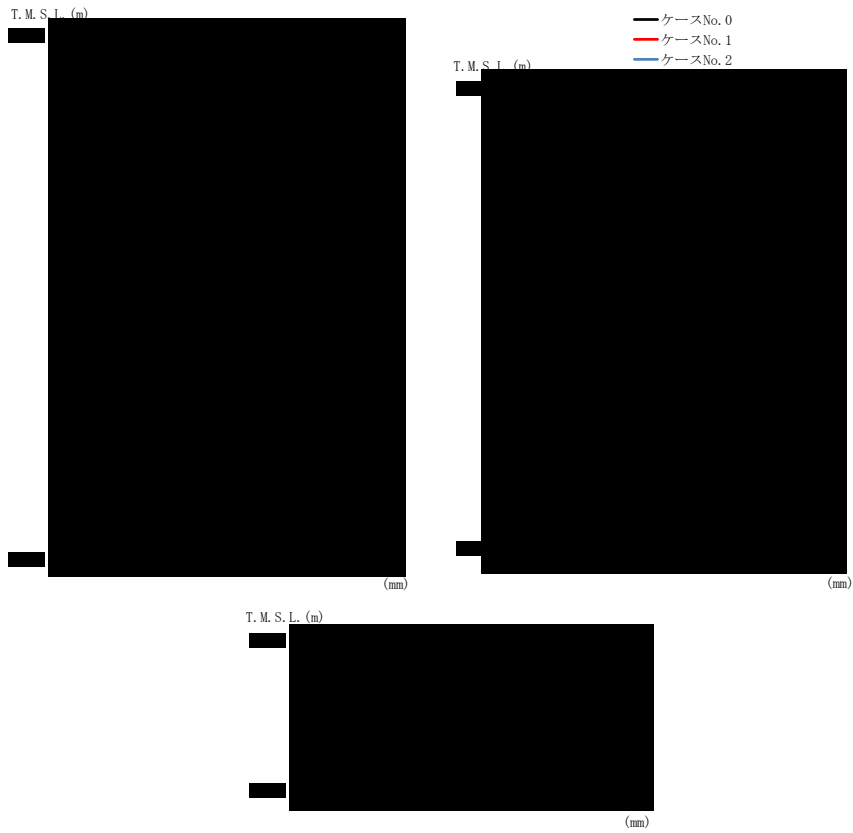

(a) S d - A (V)

第 4. 1. 3-21 図 最大応答変位（鉛直方向）（1/3）

第 4. 1. 3-25 表 最大応答変位一覧表（鉛直方向）（1/3）

(a) S d - A (V)

T. M. S. L. (m)	質 点 番 号	最大応答変位 (mm)		
		ケース No. 0	ケース No. 1	ケース No. 2
[Redacted Data]				

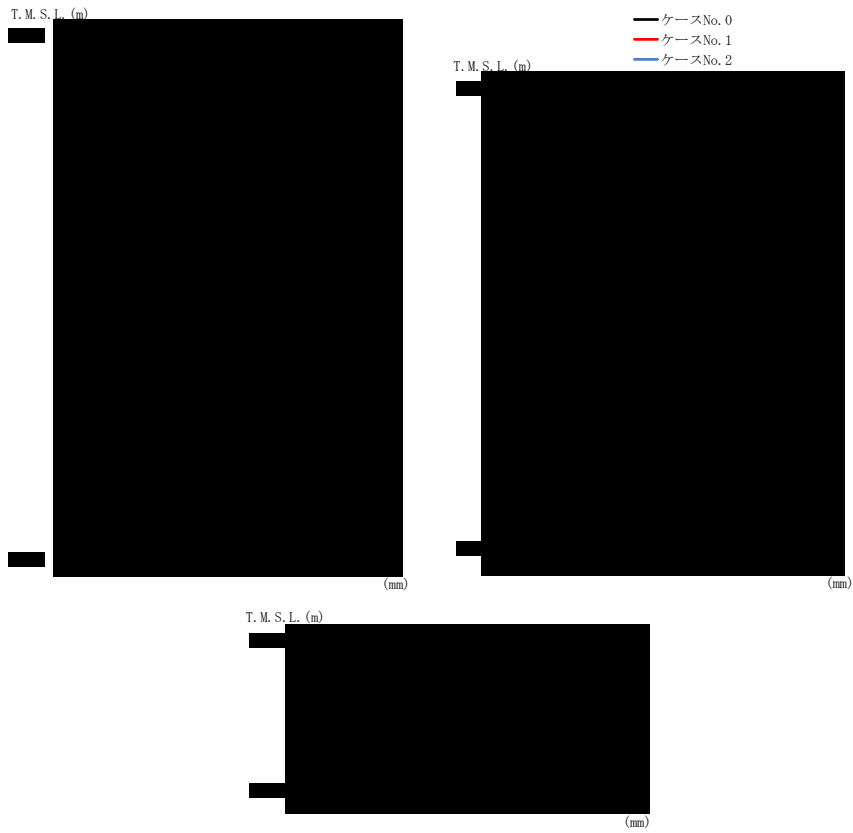

(b) S d - C 1 (UD)

第 4. 1. 3-21 図 最大応答変位 (鉛直方向) (2/3)

第 4. 1. 3-25 表 最大応答変位一覧表 (鉛直方向) (2/3)

(b) S d - C 1 (UD)

T. M. S. L. (m)	質 点 番 号	最大応答変位 (mm)		
		ケース No. 0	ケース No. 1	ケース No. 2
[Redacted Data]				



(c) S d - C 3 (UD)

第 4. 1. 3-21 図 最大応答変位 (鉛直方向) (3/3)

第 4. 1. 3-25 表 最大応答変位一覧表 (鉛直方向) (3/3)

(c) S d - C 3 (UD)

T. M. S. L. (m)	質 点 番 号	最大応答変位 (mm)		
		ケース No. 0	ケース No. 1	ケース No. 2
[Redacted Data]				



(a) S d - A (V)

第 4. 1. 3-22 図 最大応答軸力（鉛直方向）（1/3）

第 4. 1. 3-26 表 最大応答軸力一覧表（鉛直方向）（1/3）

(a) S d - A (V)

T.M.S.L. (m)	要素 番号	最大応答軸力(×10³kN)		
		ケース No. 0	ケース No. 1	ケース No. 2
[Redacted Data]				



(b) S d - C 1 (UD)

第 4. 1. 3-22 図 最大応答軸力 (鉛直方向) (2/3)

第 4. 1. 3-26 表 最大応答軸力一覧表 (鉛直方向) (2/3)

(b) S d - C 1 (UD)

T.M.S.L. (m)	要素 番号	最大応答軸力 ($\times 10^3$ kN)		
		ケース No. 0	ケース No. 1	ケース No. 2
[Redacted Data]				



(c) S d - C 3 (UD)

第 4. 1. 3-22 図 最大応答軸力 (鉛直方向) (3/3)

第 4. 1. 3-26 表 最大応答軸力一覧表 (鉛直方向) (3/3)

(c) S d - C 3 (UD)

T. M. S. L. (m)	要素 番号	最大応答軸力 ($\times 10^3 \text{kN}$)		
		ケース No. 0	ケース No. 1	ケース No. 2
[Redacted Data]				

第 4.1.3-27 表 浮上り検討 (弾性設計用地震動 S d, ケース No. 1)

(a)NS 方向

地震動	浮上り限界転倒 モーメント ($\times 10^6 \text{kN}\cdot\text{m}$)	最小接地率算出時の 転倒モーメント ($\times 10^6 \text{kN}\cdot\text{m}$)	接地率 (%)
Sd-A (H)			
Sd-C1 (NSEW)			
Sd-C3 (NS)			
Sd-C3 (EW)			
Sd-C4 (NS)			
Sd-C4 (EW)			

(b)EW 方向

地震動	浮上り限界転倒 モーメント ($\times 10^6 \text{kN}\cdot\text{m}$)	最小接地率算出時の 転倒モーメント ($\times 10^6 \text{kN}\cdot\text{m}$)	接地率 (%)
Sd-A (H)			
Sd-C1 (NSEW)			
Sd-C3 (NS)			
Sd-C3 (EW)			
Sd-C4 (NS)			
Sd-C4 (EW)			

第 4.1.3-28 表 浮上り検討 (弾性設計用地震動 S d, ケース No. 2)

(a)NS 方向

地震動	浮上り限界転倒 モーメント ($\times 10^6 \text{kN}\cdot\text{m}$)	最小接地率算出時の 転倒モーメント ($\times 10^6 \text{kN}\cdot\text{m}$)	接地率 (%)
Sd-A (H)			
Sd-C1 (NSEW)			
Sd-C3 (NS)			
Sd-C3 (EW)			
Sd-C4 (NS)			
Sd-C4 (EW)			

(b)EW 方向

地震動	浮上り限界転倒 モーメント ($\times 10^6 \text{kN}\cdot\text{m}$)	最小接地率算出時の 転倒モーメント ($\times 10^6 \text{kN}\cdot\text{m}$)	接地率 (%)
Sd-A (H)			
Sd-C1 (NSEW)			
Sd-C3 (NS)			
Sd-C3 (EW)			
Sd-C4 (NS)			
Sd-C4 (EW)			

第 4.1.3-29 表 最大接地圧（弾性設計用地震動 S d，ケース No.1）

地震動	方向		最大接地圧 (kN/m ²)
Sd-A	NS	鉛直上向き	
		鉛直下向き	
	EW	鉛直上向き	
		鉛直下向き	
Sd-C1	NS	鉛直上向き	
		鉛直下向き	
	EW	鉛直上向き	
		鉛直下向き	
Sd-C3 (NS)	NS	鉛直上向き	
		鉛直下向き	
	EW	鉛直上向き	
		鉛直下向き	
Sd-C3 (EW)	NS	鉛直上向き	
		鉛直下向き	
	EW	鉛直上向き	
		鉛直下向き	
Sd-C4 (NS)	NS	—	
	EW	—	
Sd-C4 (NS)	NS	—	
	EW	—	

第 4. 1. 3-30 表 最大接地圧 (弾性設計用地震動 S d, ケース No. 2)

地震動	方向		最大接地圧 (kN/m ²)
Sd-A	NS	鉛直上向き	
		鉛直下向き	
	EW	鉛直上向き	
		鉛直下向き	
Sd-C1	NS	鉛直上向き	
		鉛直下向き	
	EW	鉛直上向き	
		鉛直下向き	
Sd-C3 (NS)	NS	鉛直上向き	
		鉛直下向き	
	EW	鉛直上向き	
		鉛直下向き	
Sd-C3 (EW)	NS	鉛直上向き	
		鉛直下向き	
	EW	鉛直上向き	
		鉛直下向き	
Sd-C4 (NS)	NS	—	
	EW	—	
Sd-C4 (EW)	NS	—	
	EW	—	

別紙4－19

安全冷却水B冷却塔基礎の 耐震計算書

本添付書類は、別で定める方針に沿った評価・計算を示す書類であり、結果を示すものであることから、発電炉との比較は行わない。
また、図書番号や数値は最終精査中。

目 次

	ページ
1. 概要	1
2. 基本方針	2
2.1 位置	2
2.2 構造概要	3
2.3 評価方針	4
2.4 準拠規格・基準等	5
3. 地震応答解析による評価方法	6
4. 応力解析による評価方法	7
4.1 評価方針	7
4.2 荷重及び荷重の組合せ	9
4.2.1 荷重	9
4.2.2 荷重の組合せ	9
4.3 許容限界	10
4.4 評価方法	11
4.4.1 基礎スラブの評価方法	11
5. 評価結果	17
5.1 地震応答解析による評価結果	17
5.1.1 接地圧の評価結果	17
5.2 応力解析による評価結果	18
5.2.1 基礎スラブの評価結果	18

1. 概要

本資料は、「IV-1-1 耐震設計の基本方針」に基づき、安全冷却水B冷却塔基礎の地震時の構造強度及び機能維持の確認について説明するものである。その評価は、地震応答解析及び応力解析に基づいて行う。

安全冷却水B冷却塔基礎は、安全機能を有する施設において「Sクラス施設の間接支持構造物」に分類され、以下、その分類に応じた耐震評価の結果を示す。

2. 基本方針

2.1 位置

安全冷却水B冷却塔基礎の設置位置は、「IV-2-1-1-1-1-1 安全冷却水B冷却塔基礎の地震応答計算書」に示す。

2.2 構造概要

安全冷却水B冷却塔基礎の主体構造は鉄筋コンクリート造である。平面規模は主要部分で■■■m(NS)×■■■m(EW)であり、厚さは■■■mである。

主要耐震要素は、鉄筋コンクリート造の基礎スラブである。また、基礎スラブはマンメイドロックを介して岩盤に設置されている。安全冷却水B冷却塔基礎の概略平面図及び概略断面図は「IV-2-1-1-1-1-1 安全冷却水B冷却塔基礎の地震応答計算書」に示す。

2.3 評価方針

安全冷却水B冷却塔基礎の評価においては、基準地震動 S_s による地震力に対する評価（以下、「 S_s 地震時に対する評価」という。）を行うこととし、その評価は「IV-2-1-1-1-1-1 安全冷却水B冷却塔基礎の地震応答計算書」の結果を踏まえたものとする。

安全冷却水B冷却塔基礎の評価は、「IV-1-1 耐震設計の基本方針」に基づき、地震応答解析により接地圧の評価を、応力解析により断面の評価を行うことで、安全冷却水B冷却塔基礎の構造強度及び機能維持の確認を行う。評価にあたっては地盤物性のばらつきを考慮する。

安全冷却水B冷却塔基礎の評価フローを第2.3-1図に示す。

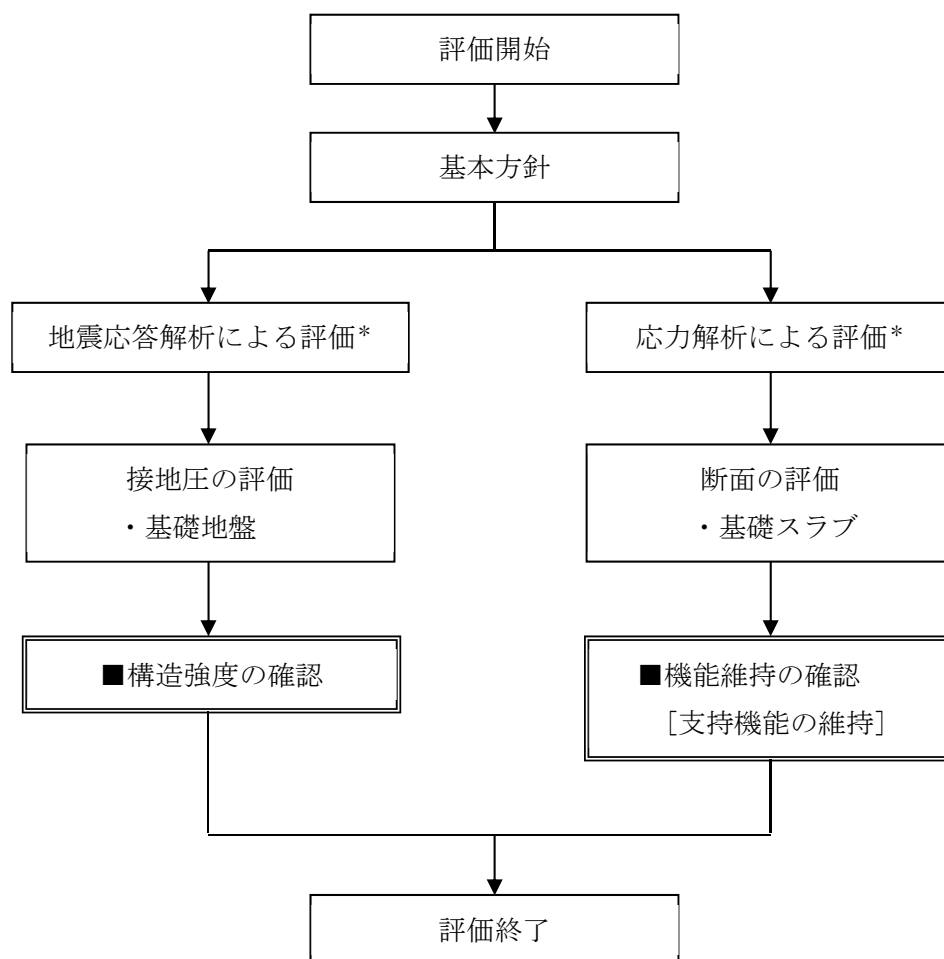

注記 *：「IV-2-1-1-1-1-1 安全冷却水B冷却塔基礎の地震応答計算書」の結果を踏まえて行う。

第2.3-1図 安全冷却水B冷却塔基礎の評価フロー

2.4 準拠規格・基準等

安全冷却水B冷却塔基礎の評価において、準拠する規格・基準等を以下に示す。

- ・建築基準法・同施行令・同告示
- ・鉄筋コンクリート構造計算規準・同解説「許容応力度設計法」
（(社)日本建築学会，1999）（以下，「RC規準」という。）
- ・原子力施設鉄筋コンクリート構造計算規準・同解説（(社)日本建築学会，2005）
（以下，「RC-N規準」という。）
- ・原子力発電所耐震設計技術指針 JEAG4601-1987（(社)日本電気協会）
- ・原子力発電所耐震設計技術指針 重要度分類・許容応力編 JEAG4601・補-1984
（(社)日本電気協会）
- ・原子力発電所耐震設計技術指針 JEAG4601-1991 追補版（(社)日本電気協会）
（以下，「JEAG4601」と記載しているものは上記3指針を指す。）

3. 地震応答解析による評価方法

地震応答解析による評価において、安全冷却水B冷却塔基礎の構造強度については、「IV-2-1-1-1-1-1 安全冷却水B冷却塔基礎の地震応答計算書」に基づき、最大接地圧が地盤の支持力を十分下回ることを確認する。

地震応答解析による評価における安全冷却水B冷却塔基礎の許容限界は、「IV-1-1 耐震設計の基本方針」に基づき、第3.-1表のとおり設定する。

第3.-1表 地震応答解析による評価における許容限界

設計上の 確認事項	地震力	部位	機能維持のための 考え方	許容限界 (評価基準値)
建物を十分に支持できること	基準 地震動 S s	基礎地盤	最大接地圧が地盤の支持力を十分下回ることを確認	極限 支持力度 2900kN/m ²

4. 応力解析による評価方法

4.1 評価方針

安全冷却水B冷却塔基礎の応力解析による評価対象部位は基礎スラブとし、S_s地震時に対して以下の方針に基づき評価を行う。

応力解析による基礎スラブ評価フローを第4.1-1図に示す。応力解析にあたっては、「IV-2-1-1-1-1-1 安全冷却水B冷却塔基礎の地震応答計算書」より得られた結果を用いる。また、地盤物性のばらつきを考慮するものとする。

基礎スラブの応力解析による評価は、S_s地震時に対して有限要素法モデル（以下、「FEMモデル」という。）を用いた弾性応力解析により行うこととし、地震力と地震力以外の荷重の組合せの結果、発生する応力が「RC-N規準」に基づく許容限界を超えないことを確認する。

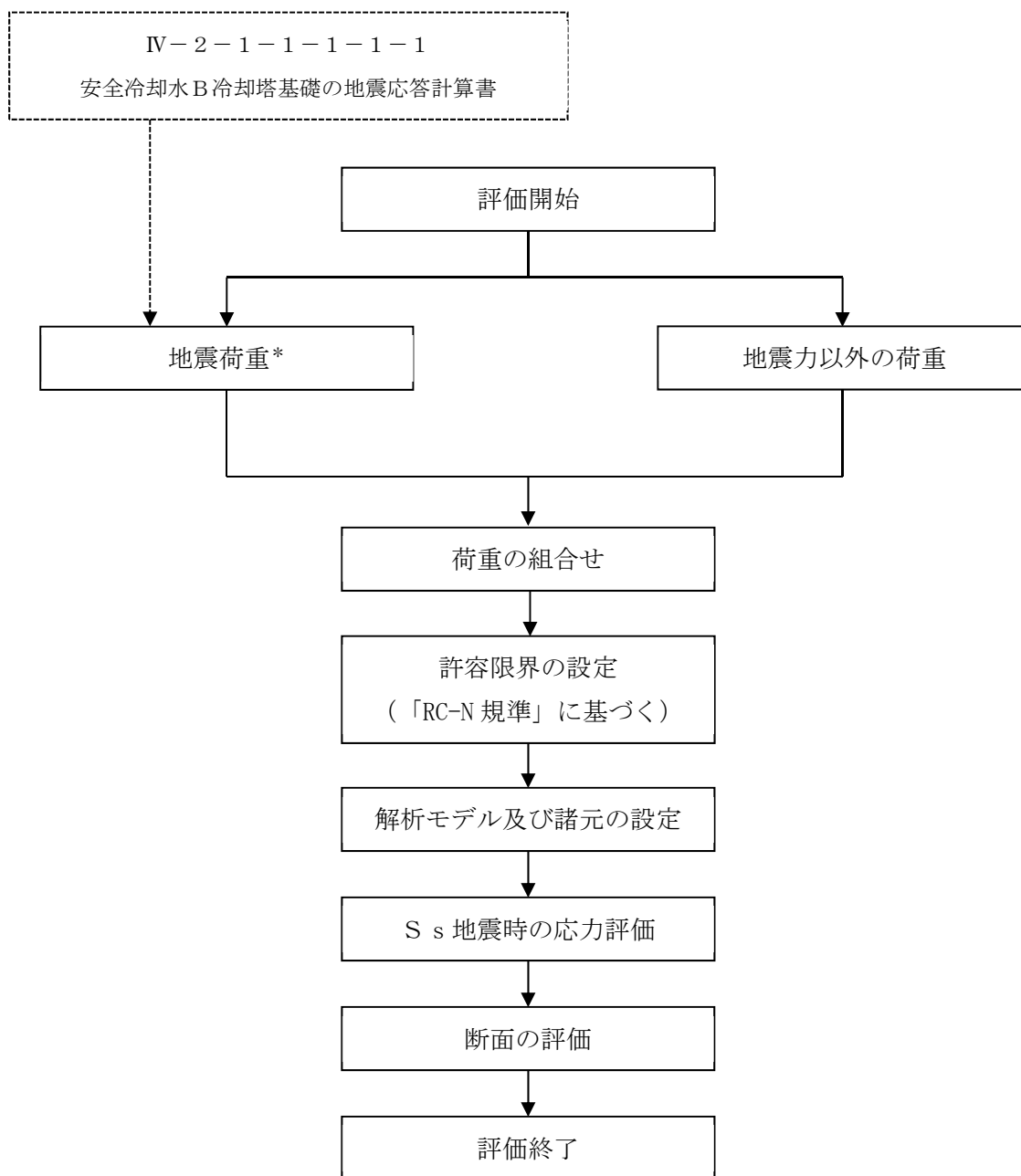

注記 *：地盤物性のばらつきを考慮する。

第4.1-1図 応力解析による基礎スラブの評価フロー

4.2 荷重及び荷重の組合せ

荷重及び荷重の組合せは、「IV-1-1 耐震設計の基本方針」にて設定している荷重及び荷重の組合せを用いる。荷重のうち、固定荷重、機器荷重及び積載荷重については、平成10年4月7日付け10安(核規)第148号にて認可を受けた設工認申請書の「IV-2-2-4-1-1-1 安全冷却水系の耐震性に関する計算書」の「(10) 安全冷却水B冷却塔基礎の耐震性に関する計算書」の「b. 安全冷却水B冷却塔基礎の耐震計算書」を踏まえたものとする。

4.2.1 荷重

各部位の評価において考慮する荷重を第4.2.1-1表に示す。

第4.2.1-1表 考慮する荷重

荷重名称		内容
鉛直荷重(VL)	固定荷重(DL)	構造物の自重
	機器荷重(EL)	構築物に作用する主要機器の荷重
	積載荷重(LL)	家具, 什器, 人員荷重の他, 機器荷重に含まれない小さな機器類の荷重
積雪荷重(SL)		積雪量 190cm 地震荷重と組み合わせる場合は0.35の係数を乗じた値とする。
地震荷重(S)		地盤物性のばらつきを考慮した地震荷重
浮力(B)		地下水位に応じた浮力による荷重

4.2.2 荷重の組合せ

基礎スラブの評価において考慮する荷重の組合せを第4.2.2-1表に示す。

第4.2.2-1表 荷重の組合せ

検討部位	荷重の組合せ
基礎スラブ	VL+SL+S+B

4.3 許容限界

応力解析による評価における基礎スラブの許容限界は、「IV-1-1-8 機能維持の基本方針」に基づき、第4.3-1表のとおり設定する。

コンクリートの圧縮強度を第4.3-2表に、鉄筋（主筋）の降伏強度を第4.3-3表に示す。

第4.3-1表 応力解析評価における基礎スラブの許容限界

要求機能	機能設計上の確認事項	地震力	部位	機能維持のための考え方	許容限界 (評価基準値)
支持機能	構造強度を有すること	基準地震動 S _s	基礎スラブ	部材に生じる応力が構造強度を確保するための許容限界を超えないことを確認	「RC-N規準」に基づく 終局耐力

第4.3-2表 コンクリートの圧縮強度

コンクリートの設計基準強度F _c (N/mm ²)	圧縮強度(N/mm ²)
23.5 (F _c =240kgf/cm ²)	23.5

第4.3-3表 鉄筋（主筋）の降伏強度

鉄筋種類	降伏強度(N/mm ²)
SD345	345

注記 : 材料強度は降伏強度を1.1倍して算出する。

4.4 評価方法

4.4.1 基礎スラブの評価方法

(1) 解析モデル

応力解析は、FEMモデルを用いた弾性応力解析を実施する。解析には、解析コード「MSC NASTRAN Ver. 2013. 1. 0」を用いる。また、解析コードの検証及び妥当性確認等の概要については、「IV-3 計算機プログラム（解析コード）の概要」に示す。

基礎スラブのモデル化においては、シェル要素にてモデル化する。また、基礎スラブ底面に水平方向及び鉛直方向の地盤ばねを設ける。なお、基礎スラブ底面に設置した地盤ばねについては、引張力が発生したときに浮上りを考慮する。基礎スラブの解析モデルを第4.4.1-1図に示す。コンクリートの物性値を第4.4.1-1表に、鉄筋コンクリートの単位体積重量を第4.4.1-2表に示す。解析モデルの節点数は146、要素数は122である。

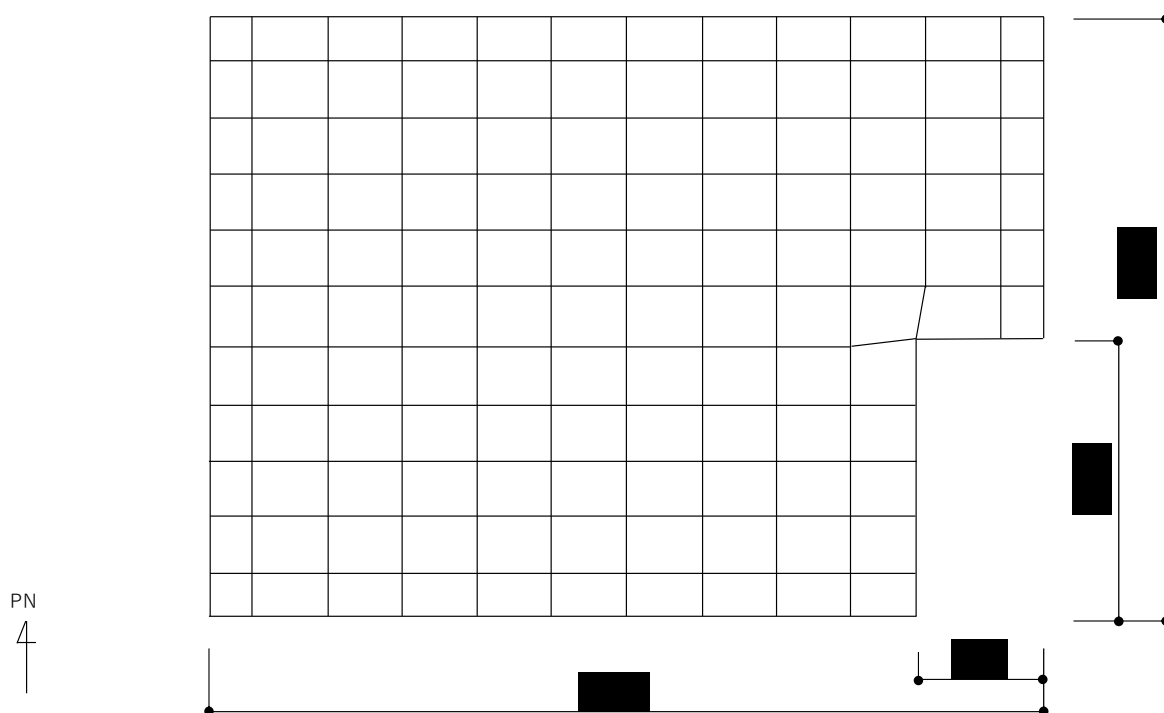

第4.4.1-1図 基礎スラブの解析モデル（単位：mm）

第4.4.1-1表 コンクリートの物性値

設計基準強度 F_c (N/mm^2)	ヤング係数 E_c (N/mm^2)	ポアソン比 ν
23.5 ($F_c=240kgf/cm^2$)	2.25×10^4	0.2

第4.4.1-2表 鉄筋コンクリートの単位体積重量

単位体積重量 (kN/m^3)
24

(2) 荷重ケース

S_s地震時の基礎スラブに作用する応力は、次の荷重ケースによる応力を組み合わせて求める。

VL	: 鉛直荷重
SL	: 積雪荷重
S _{SNS}	: NS方向のS _s 地震荷重 (N→S方向を正とする。)
S _{SEW}	: EW方向のS _s 地震荷重 (E→W方向を正とする。)
S _{SUD}	: 鉛直方向のS _s 地震荷重 (上向きを正とする。)
B	: 浮力 (上向きを正とする。)

(3) 荷重の組合せケース

荷重の組合せケースを第 4. 4. 1-3 表に示す。

水平方向と鉛直方向の荷重の組合せは、「原子力発電所耐震設計技術規程 JEAC4601-2008 ((社)日本電気協会)」を参考に、組合せ係数法(組合せ係数は 1.0 と 0.4)を用いるものとする。

第4. 4. 1-3表 荷重の組合せケース

ケースNo.	荷重の組合せ
1	$VL + SL + 1.0S_{SNS} + 0.4S_{SUD} + B$
2	$VL + SL - 1.0S_{SNS} + 0.4S_{SUD} + B$
3	$VL + SL + 1.0S_{SNS} - 0.4S_{SUD} + B$
4	$VL + SL - 1.0S_{SNS} - 0.4S_{SUD} + B$
5	$VL + SL + 1.0S_{SEW} + 0.4S_{SUD} + B$
6	$VL + SL - 1.0S_{SEW} + 0.4S_{SUD} + B$
7	$VL + SL + 1.0S_{SEW} - 0.4S_{SUD} + B$
8	$VL + SL - 1.0S_{SEW} - 0.4S_{SUD} + B$
9	$VL + SL + 0.4S_{SNS} + 1.0S_{SUD} + B$
10	$VL + SL - 0.4S_{SNS} + 1.0S_{SUD} + B$
11	$VL + SL + 0.4S_{SNS} - 1.0S_{SUD} + B$
12	$VL + SL - 0.4S_{SNS} - 1.0S_{SUD} + B$
13	$VL + SL + 0.4S_{SEW} + 1.0S_{SUD} + B$
14	$VL + SL - 0.4S_{SEW} + 1.0S_{SUD} + B$
15	$VL + SL + 0.4S_{SEW} - 1.0S_{SUD} + B$
16	$VL + SL - 0.4S_{SEW} - 1.0S_{SUD} + B$

(4) 荷重の入力方法

a. 鉛直荷重 (VL) 及び積雪荷重 (SL)

基礎スラブの重量は鉄筋コンクリートの単位体積重量を FEM モデルの各要素に与える。冷却塔から伝達される重量は、集中荷重として基礎スラブと冷却塔の脚部の取合い部の節点に入力する。

b. 地震荷重 (S)

地震荷重については、基準地震動 S_s に対する地震応答解析から得られる結果より設定する。冷却塔から基礎スラブへ伝達される荷重としては、「IV-2-1-2-1-1-1 安全冷却水 B 冷却塔の耐震計算書」における冷却塔の支持架構の地震応答解析から得られる、支持架構柱脚部のせん断力、曲げモーメント及び軸力を考慮し、支持架構柱脚部に対応する節点に入力する。また、基礎スラブの慣性力として、上記の冷却塔から基礎スラブへ伝達される荷重と基礎スラブ底面に発生する荷重の差を、FEM モデルの各節点に、その支配面積に応じて分配入力する。基礎スラブ底面に発生する荷重は、「IV-2-1-1-1-1-1 安全冷却水 B 冷却塔基礎の地震応答計算書」における安全冷却水 B 冷却塔基礎の地震応答解析から得られる、底面スウェイばねの反力であるせん断力、底面ロッキングばねの反力である曲げモーメント及び底面鉛直ばねの反力である軸力を考慮する。 S_s 地震時における基礎スラブ底面のせん断力、曲げモーメント及び軸力を第 4.4.1-4 表に示す。

c. 浮力 (B)

浮力は、地下水位面を T. M. S. L. 55.0m とし、基礎スラブに一様に上向きに等分布荷重として入力する。

第 4.4.1-4 表 S_s 地震時における基礎スラブ底面のせん断力、曲げモーメント及び軸力

水平 (NS 方向)		水平 (EW 方向)		鉛直
せん断力 ($\times 10^4 \text{kN}$)	曲げモーメント ($\times 10^5 \text{kN} \cdot \text{m}$)	せん断力 ($\times 10^4 \text{kN}$)	曲げモーメント ($\times 10^5 \text{kN} \cdot \text{m}$)	軸力 ($\times 10^4 \text{kN}$)
5.44	2.11	5.58	2.04	2.47

(5) 断面の評価方法

a. 軸力及び曲げモーメントに対する断面の評価方法

断面の評価は、「RC-N規準」に基づき、基礎スラブに生じる曲げモーメントが許容限界を超えないことを下式で確認する。

$$M \leq M_u$$

$$M_u = 0.8a_t\sigma_y D + 0.4ND \quad (N_{\min} \leq N < 0)$$

$$M_u = 0.8a_t\sigma_y D + 0.5ND \left(1 - \frac{N}{bDF_c}\right) \quad (0 \leq N \leq 0.4bDF_c)$$

$$M_u = \left(0.8a_t\sigma_y D + 0.12bD^2 F_c\right) \left(\frac{N_{\max} - N}{N_{\max} - 0.4bDF_c}\right) \quad (0.4bDF_c < N \leq N_{\max})$$

ここで、

M	: 発生曲げモーメント
M_u	: 許容限界 (曲げ終局強度)
N_{\min}	: 中心引張時終局強度
N_{\max}	: 中心圧縮時終局強度
N	: 発生軸力
a_t	: 引張主筋断面積
b	: 断面幅
D	: 断面せい
σ_y	: 鉄筋の引張に対する材料強度
F_c	: コンクリート圧縮強度

b. 面外せん断力に対する断面の評価方法

断面の評価は、「RC-N 規準」に基づき、基礎スラブに生じる面外せん断力が許容限界を超えないことを下式で確認する。

$$Q \leq Q_u$$

$$Q_u = \left\{ \frac{0.068 p_t^{0.23} (F_c + 18)}{M/(Qd) + 0.12} + 0.85 \sqrt{p_w \sigma_{wy}} + 0.1 \sigma_0 \right\} bj$$

ここで

Q	: 発生面外せん断力
Q_u	: 許容限界（面外せん断終局強度）
p_t	: 引張鉄筋比 (%)
F_c	: コンクリートの圧縮強度
M/Q	: 強度算定断面における曲げモーメントMと面外せん断力Qの比
d	: 有効せい
p_w	: 面外せん断補強筋比
σ_{wy}	: 面外せん断補強筋の降伏強度
σ_0	: 平均軸方向応力度
b	: 部材幅
j	: 応力中心間距離

5. 評価結果

5.1 地震応答解析による評価結果

5.1.1 接地圧の評価結果

S s 地震時の最大接地圧が、地盤の極限支持力度を十分下回ることを確認する。

S s 地震時の最大接地圧と地盤の極限支持力度の比較結果を第 5.1.1-1 表に示す。S s 地震時の最大接地圧は 107kN/m^2 であり、地盤の極限支持力度を十分下回ることを確認した。

第5.1.1-1表 S s 地震時の最大接地圧と地盤の極限支持力度の比較結果

最大接地圧 (kN/m^2)		極限支持力度 (kN/m^2)	判定
NS方向 (S s - A, 基本, $+1\sigma$)	EW方向 (S s - A, 基本, $+1\sigma$)		
107	95	2900	OK

5.2 応力解析による評価結果

5.2.1 基礎スラブの評価結果

基礎スラブの評価結果を、軸力及び曲げモーメントに対する評価については、許容限界に対する発生曲げモーメントの割合が最も大きい要素に対して、また、面外せん断力に対する評価については、許容限界に対する発生面外せん断力の割合が最も大きい要素に対して示す。当該要素の位置を第5.2.1-1図及び第5.2.1-2図に、評価結果を第5.2.1-1表に示す。なお、基礎スラブ厚及び配筋は、平成10年4月7日付け10安(核規)第148号にて認可を受けた設工認申請書の「IV-2-2-4-1-1-1 安全冷却水系の耐震性に関する計算書」の「(10) 安全冷却水B冷却塔基礎の耐震性に関する計算書」の「b. 安全冷却水B冷却塔基礎の耐震計算書」による。

発生曲げモーメント及び発生面外せん断力が、それぞれの許容限界を超えないことを確認した。

PN
4

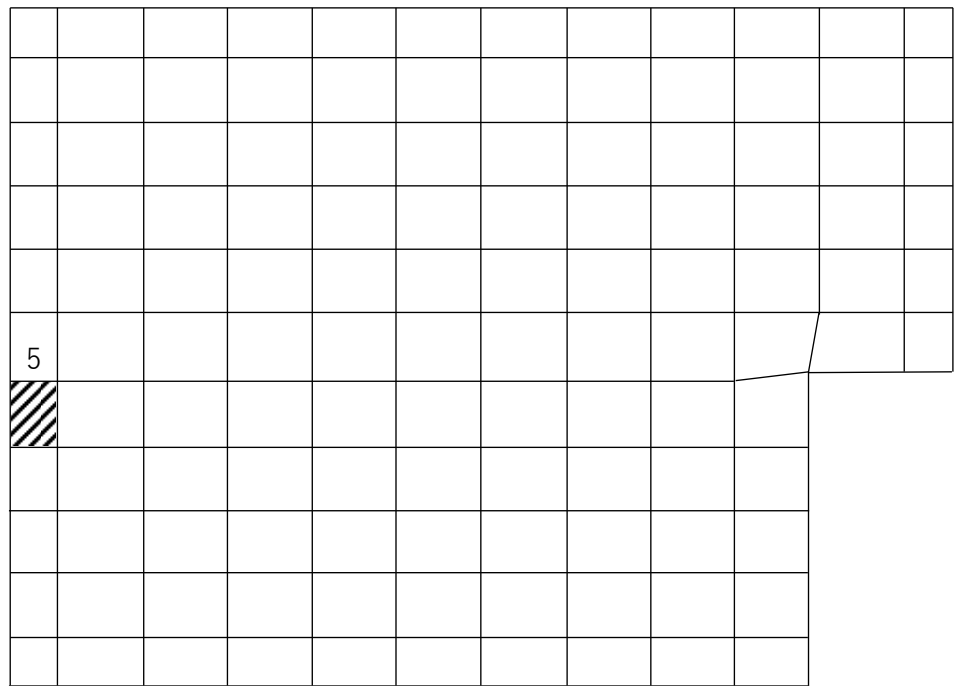

(1) NS 方向 (要素 No. 5)

PN
4

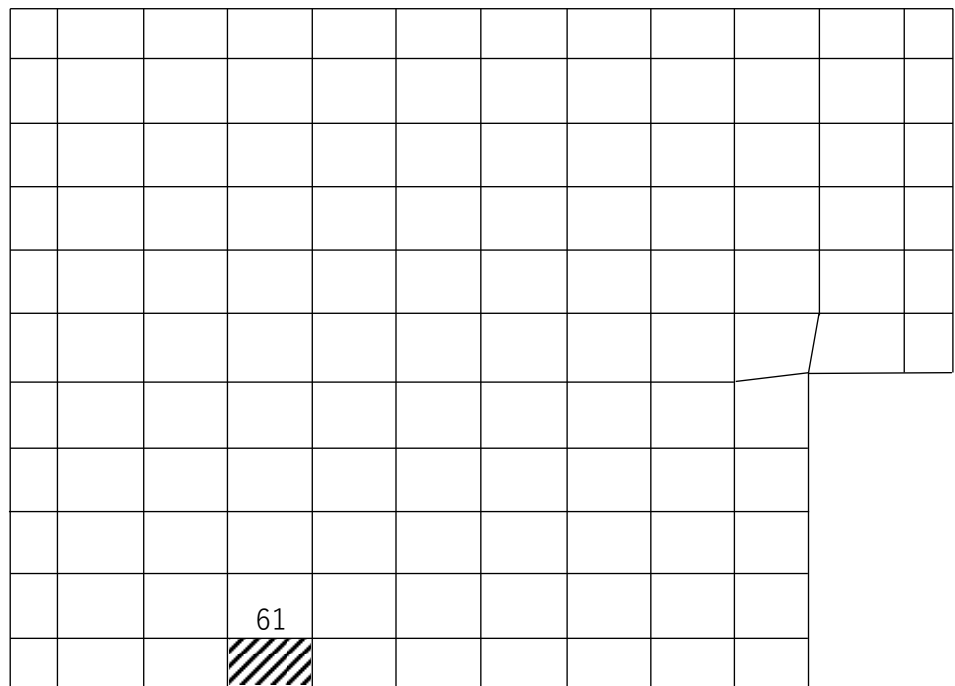

(2) EW 方向 (要素 No. 61)

第5.2.1-1図 軸力及び曲げモーメントに対する評価結果を示す要素の位置図

PN
4

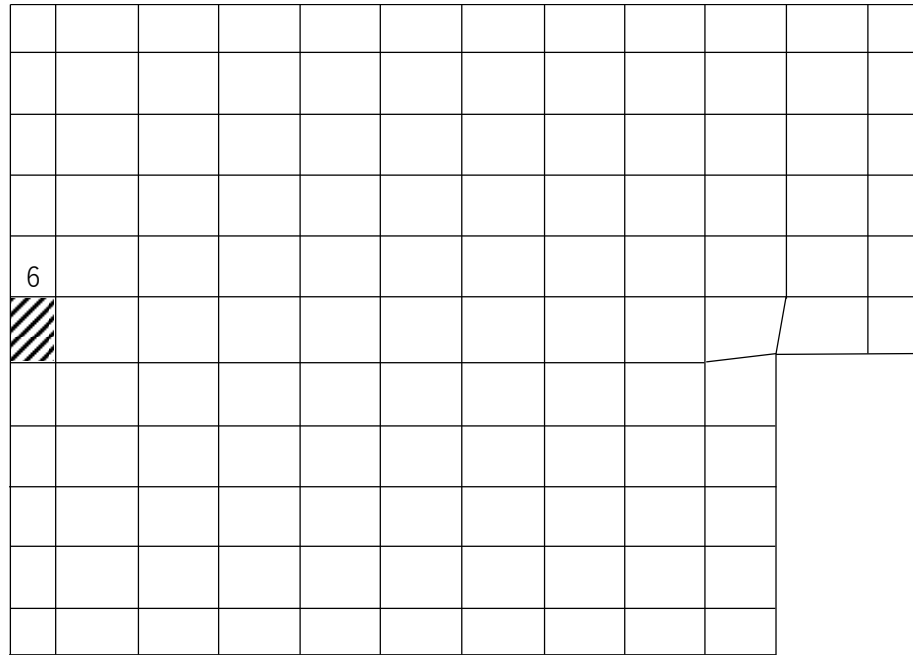

(1) NS 方向 (要素 No. 6)

PN
4

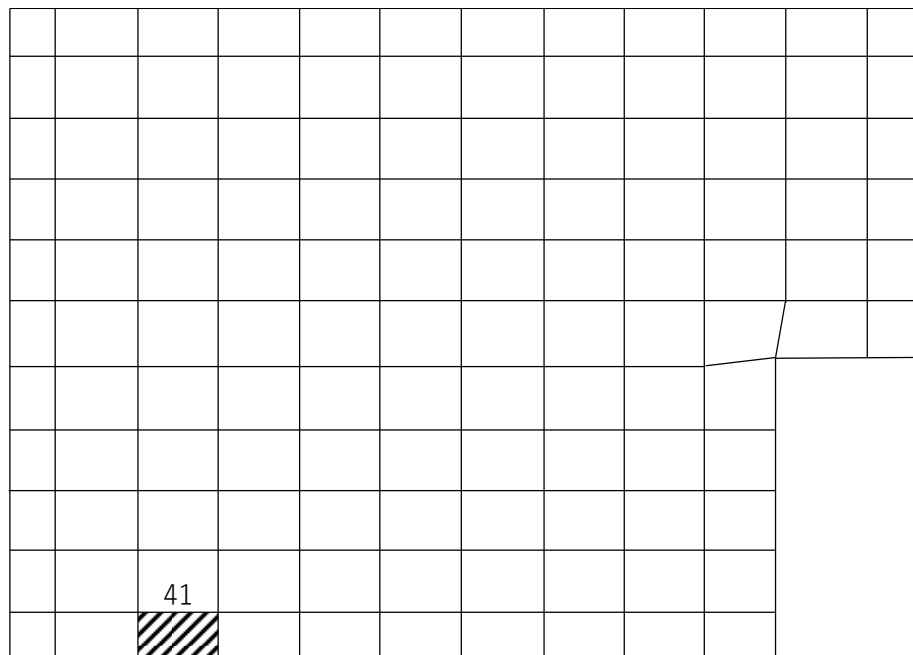

(2) EW 方向 (要素 No. 41)

第5. 2. 1-2図 面外せん断力に対する評価結果を示す要素の位置図

第5.2.1-1表 基礎スラブの評価結果

(1) 軸力及び曲げモーメントに対する評価

方向	解析結果			許容値 (kN・m/m)	検定比	判定
	要素番号	荷重組合せ ケース	発生曲げモーメント (kN・m/m)			
NS	5	2	1248	1972	0.633	OK
EW	61	6	647	2006	0.323	OK

- 注記 1：許容値は曲げ終局強度を示す。
 2：検定比＝（発生曲げモーメント）／（許容値）
 3：軸力は圧縮を正とする。

(2) 面外せん断力に対する評価

方向	解析結果			許容値 (kN/m)	検定比	判定
	要素番号	荷重組合せ ケース	発生面外せん断力 (kN/m)			
NS	6	2	388	1565	0.249	OK
EW	41	6	178	1230	0.145	OK

- 注記 1：許容値は面外せん断終局強度を示す。
 2：検定比＝（発生面外せん断力）／（許容値）

別紙4－20

安全冷却水B冷却塔の 耐震計算書

本添付書類は、別で定める方針に沿った評価・計算を示す書類であり、結果を示すものであることから、発電炉との比較は行わない。
また、図書番号や数値は最終精査中。

目 次

	ページ
1. 概要	1
2. 準拠規格	1
3. 構造強度評価	1
3.1 構造の説明	1
3.2 評価方針	1
3.2.1 計算条件	1
3.2.2 解析モデルの設定方法	1
3.2.3 荷重の組合せ及び許容応力	1
3.2.4 計算方法	1
4. 評価内容(構造強度)	2
4.1 安全冷却水B冷却塔	2
4.1.1 解析モデル	2
4.1.2 設計条件	9
4.1.3 機器要目	11
4.1.4 結論	13
5. 動的機能維持評価	15
5.1 構造の説明	15
5.2 評価方針	15
5.2.1 計算条件	15
5.2.2 解析モデルの設定方法	15
5.2.3 荷重の組合せ及び許容応力	15
5.2.4 計算方法	15
5.2.5 原動機の計算方法	15
5.2.6 評価	17
6. 評価内容(動的機能維持)	18
6.1 ファン軸	18
6.1.1 解析モデル	18
6.1.2 結論	19

1. 概要
2. 準拠規格
3. 構造強度評価
 - 3.1 構造の説明
 - 3.2 評価方針
 - 3.2.1 計算条件
 - 3.2.2 解析モデルの設定方法
 - 3.2.3 荷重の組合せ及び許容応力
 - 3.2.4 計算方法

本資料の「1. 概要」から「3.2.4 算方法」については、「IV-1-2-1 機器の耐震性に関する計算書作成の基本方針」による。

4. 評価内容(構造強度)

4.1 安全冷却水B冷却塔

4.1.1 解析モデル

(1) 構造

安全冷却水B冷却塔の構造について第4.1.1-1図に概要図を示し、各部材の構造図を第4.1.1-2図～第4.1.1-5図に示す。



□:平成10年6月9日付け9安(核規)第596号にて認可を受けた設
工認申請書の「IV-2-2-4-1-1-1 安全冷却水B冷却塔の耐震計算書」か
らの変更箇所を示す。

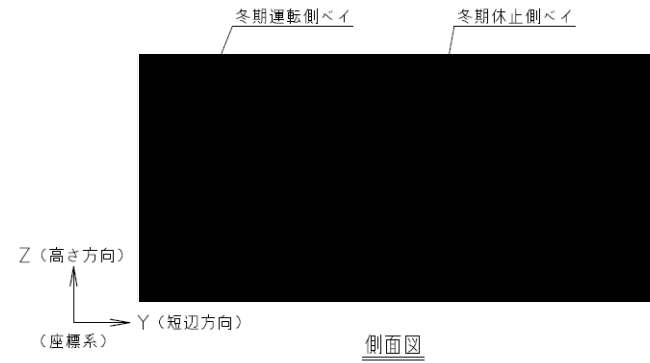
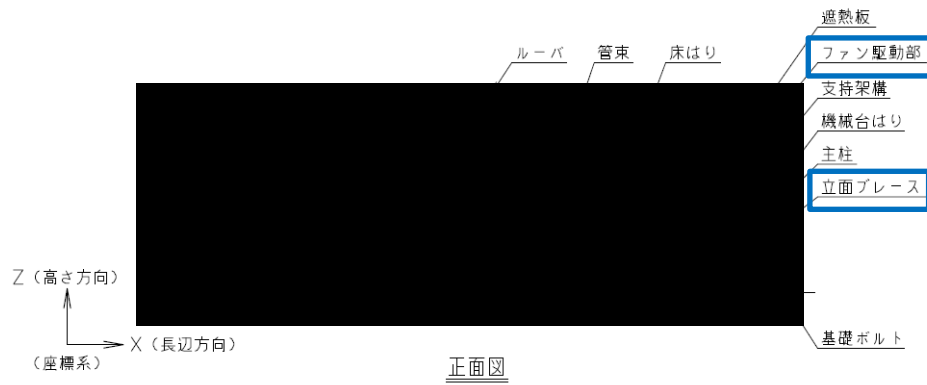

第 4. 1. 1-1 図 安全冷却水 B 冷却塔概要図

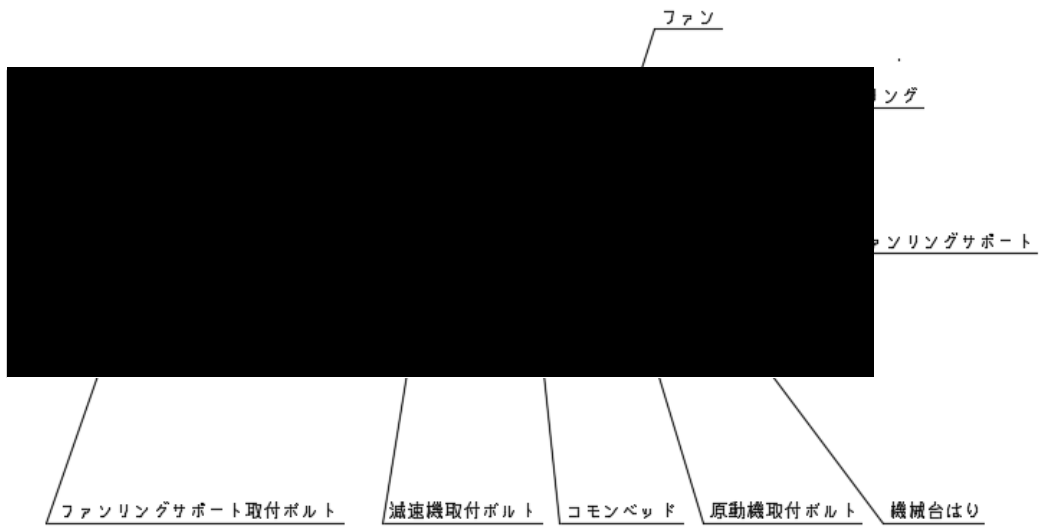
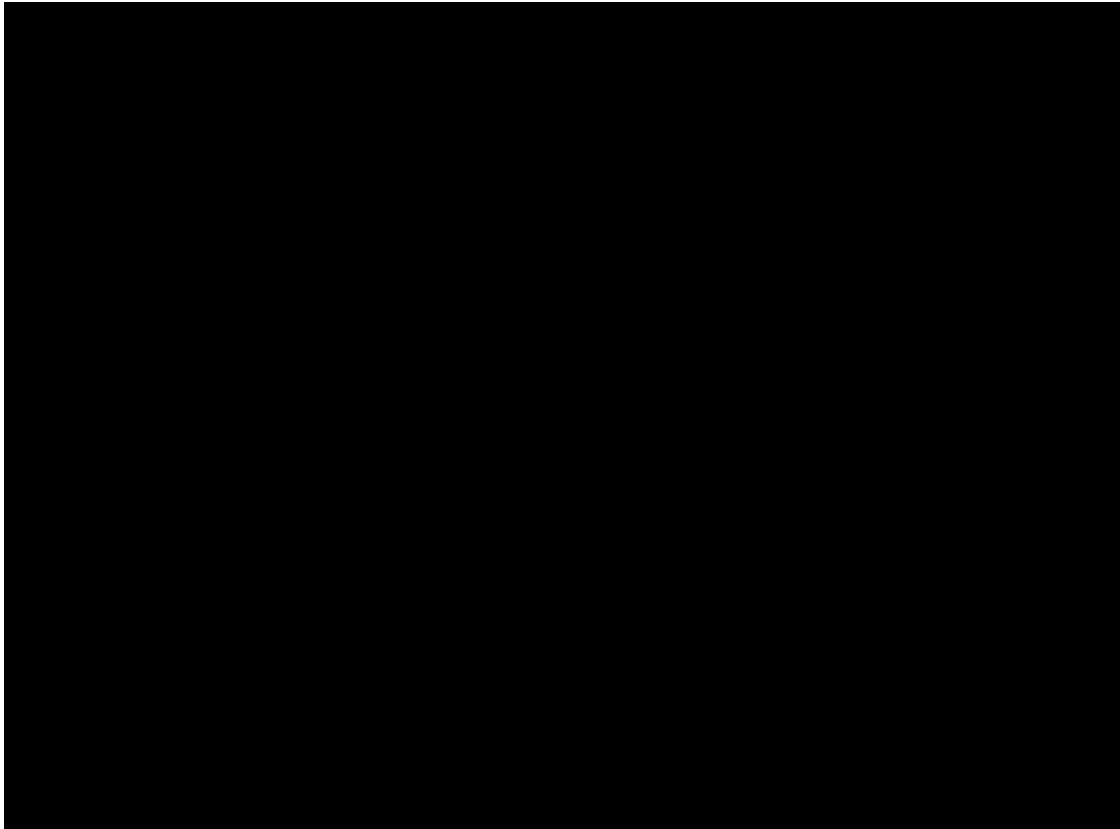

第 4.1.1-2 図 ファン駆動部構造図

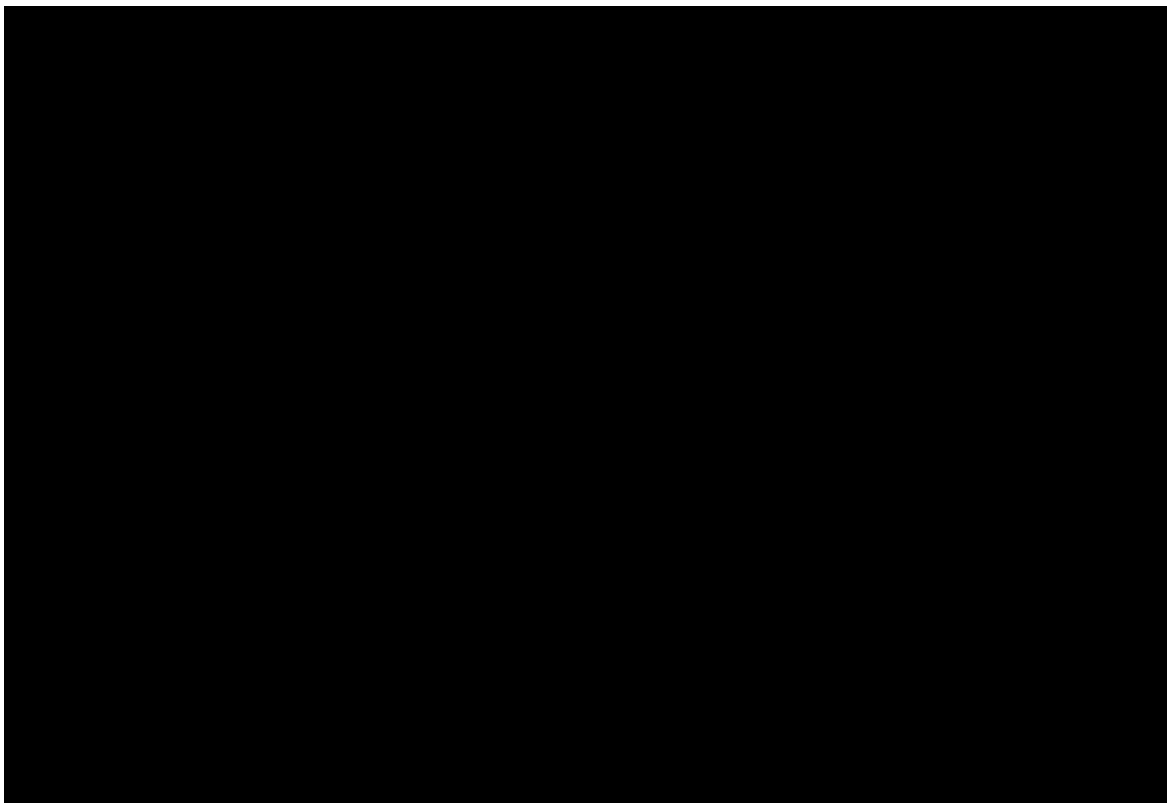

第 4.1.1-3 図 管束構造図

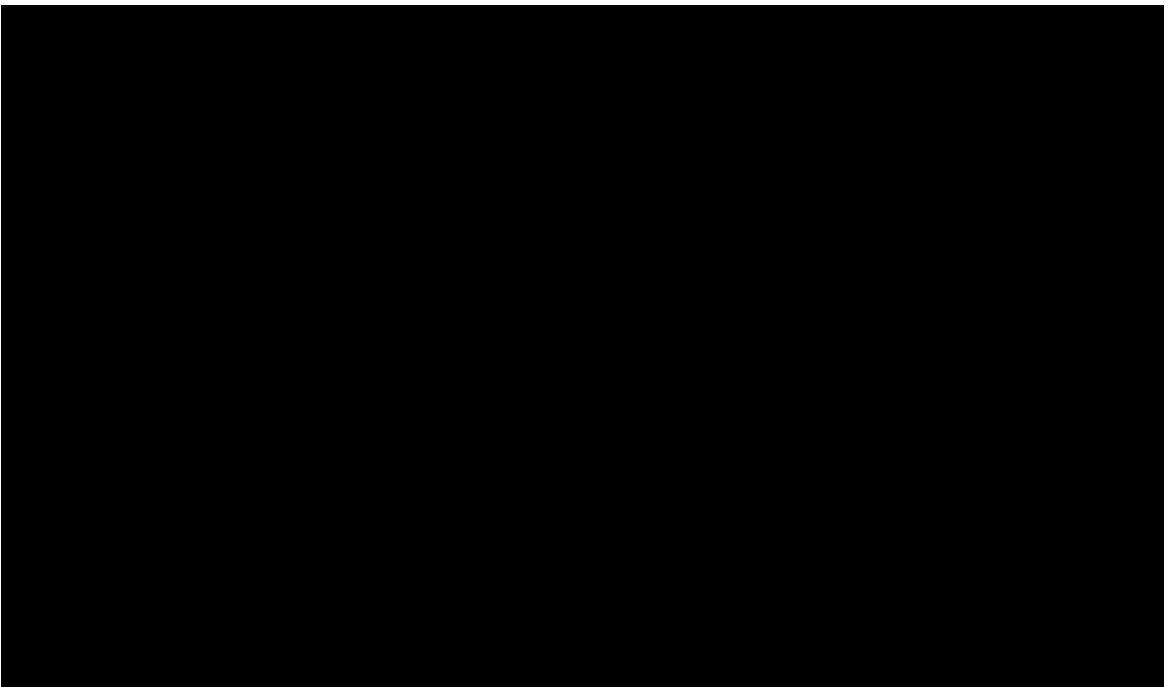

第 4.1.1-4 図 ルーバ構造図



第 4.1.1-5 图 遮热板构造图

(2) 解析モデル

安全冷却水B冷却塔の解析モデルは、「IV-1-1-5_地震応答解析の基本方針」に示す、3次元モデルに補強を行う水平ブレース、立面ブレース、ファン駆動部の剛性を反映したものとする。

支持架構の解析モデルを第4.1.1-6図、モデル諸元を第4.1.1-1表に、また、伝熱管の解析モデルを第4.1.1-7図、モデル諸元を第4.1.1-2表に示す。

計算は、解析コード「MSC.NASTRAN Ver. 2008.0.4」を使用する。なお、解析コードの検証及び妥当性確認等の概要については、「IV-3 計算機プログラム(解析コード)の概要」に示す。

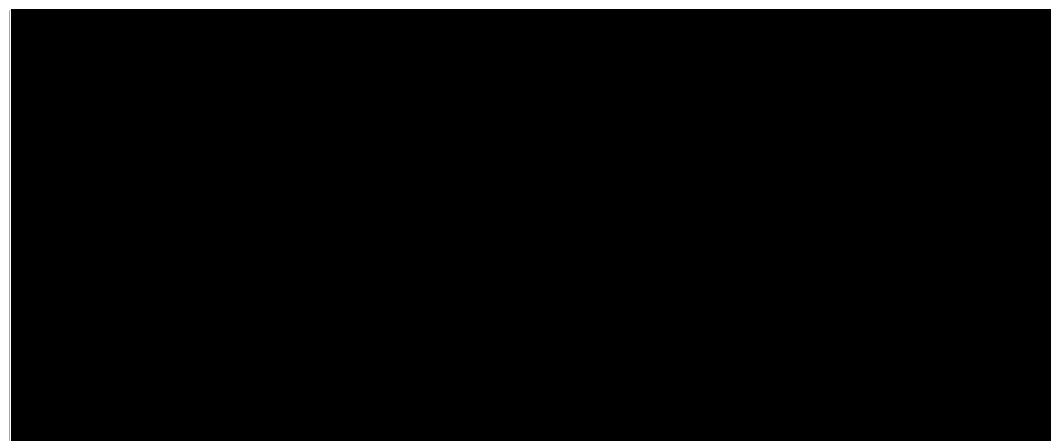
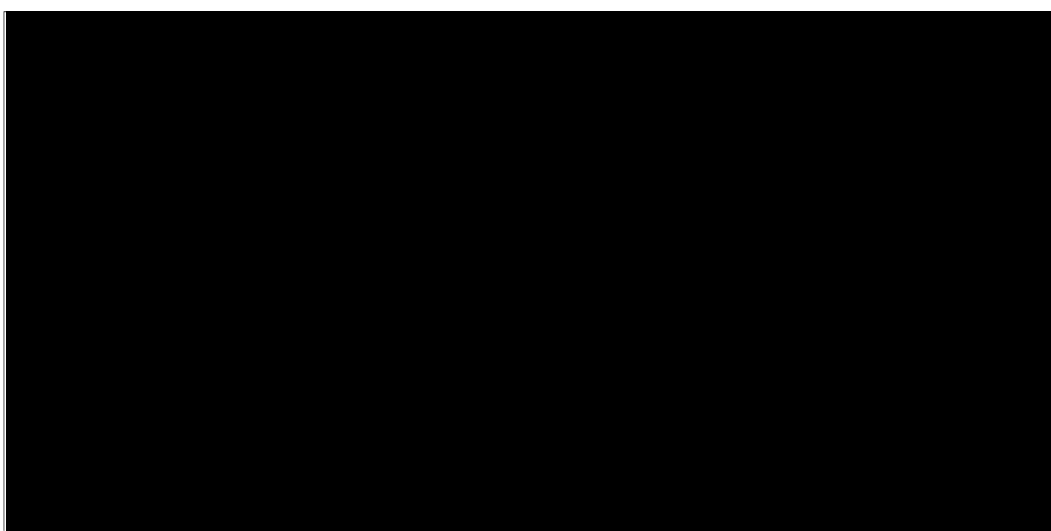

第4.1.1-6図 支持架構解析モデル

第4.1.1-1表 支持架構のモデル諸元

	冬期運転側ベイ	冬期休止側ベイ
要素数	■	■
節点数	■	■

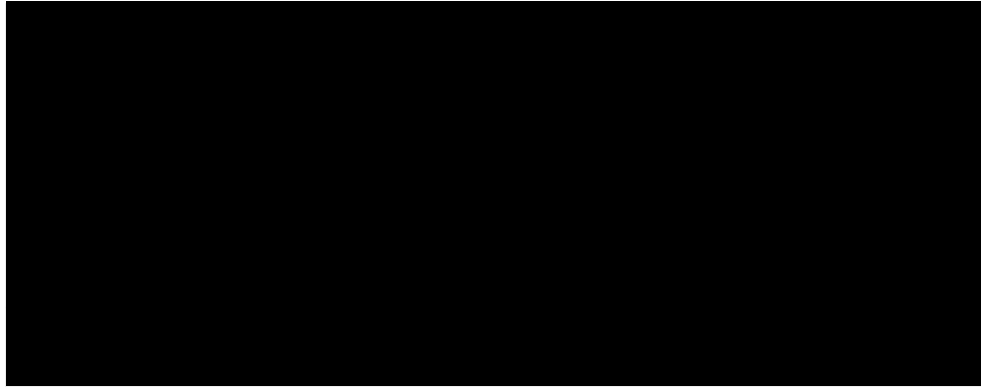

第 4.1.1-7 図 伝熱管解析モデル

第 4.1.1-2 表 伝熱管のモデル諸元

要素数	■
節点数	■

(3) 評価説明図

取付ボルト評価説明図を第 4.1.1-8 図に示す。

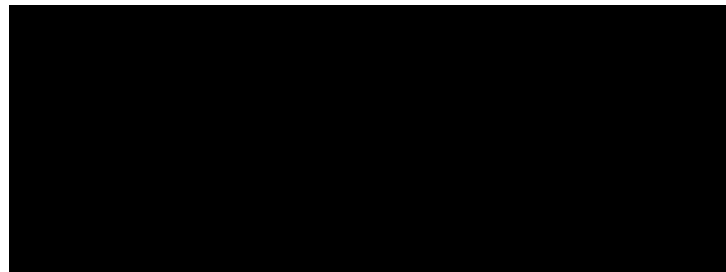
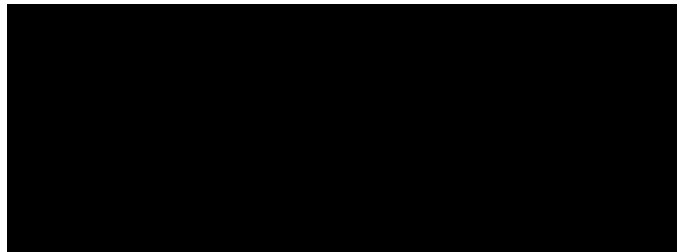

第 4.1.1-8 図 取付ボルト評価説明図

4.1.2 設計条件
(冬期運転側ベイ)

機器名称	耐震設計上の重要度分類	据付場所及び床面高さ*1 (m)	固有周期 (s)	弾性設計用地震動 S d 及び静的震度				基準地震動 S s		振動による震度 (G)	最高使用圧力 (MPa)	最高使用温度 (°C)	比重
				動的		静的		水平方向設計震度	鉛直方向設計震度				
				水平方向設計震度	鉛直方向設計震度	水平方向設計震度	鉛直方向設計震度						
安全冷却水 B 冷却塔	支持架構	S											
	ファン駆動部												原動機
													減速機
													ファンリング
	管束/伝熱管												
	ルーバ												
遮熱板													

- 注記 *1 : 基準床レベルを示す。
 *2 : 弾性設計用地震動 S d に基づく、据付面の床応答加速度を設計入力地震動とする。
 *3 : 基準地震動 S s に基づく、据付面の床応答加速度を設計入力地震動とする。
 *4 : 下記に示す。

次数	固有周期 (s)

(冬期休止側ベイ)

機器名称	耐震設計上の重要度分類	据付場所及び床面高さ*1 (m)	固有周期 (s)	弾性設計用地震動 S _d 及び静的震度				基準地震動 S _s		振動による震度 (G)	最高使用圧力 (MPa)	最高使用温度 (°C)	比重	
				動的		静的		水平方向設計震度	鉛直方向設計震度					
				水平方向設計震度	鉛直方向設計震度	水平方向設計震度	鉛直方向設計震度							
安全冷却水B冷却塔	支持架構	S												
	ファン駆動部			原動機										
				減速機										
				ファンリング										
	管束/伝熱管													
	ルーバ													
遮熱板														

- 注記 *1 : 基準床レベルを示す。
 *2 : 弾性設計用地震動 S_d に基づく、据付面の床応答加速度を設計入力地震動とする。
 *3 : 基準地震動 S_s に基づく、据付面の床応答加速度を設計入力地震動とする。
 *4 : 下記に示す。

次数	固有周期 (s)

4.1.3 機器要目

(冬期運転側ベイ)

(1) 伝熱管

D_o (mm)	t (mm)	Z_f (mm ³)	i_1 (-)	i_2 (-)

(2) 支持架構搭載機器

部材	m (kg)	h (mm)	取付ボルト 配置	L (mm)	A_b (mm ²)	n (-)	n_t (-)	F (MPa)	F^* (MPa)	M_p (N・mm)
原動機 取付ボルト										
減速機 取付ボルト										
ファンリング サポート 取付ボルト										
管束 取付ボルト										
ルーバ 取付ボルト										
遮熱板 取付ボルト										
取付ボルト										

注記 *1 : ファンリングサポート, ファンリングを含む。

*2 : ファンリングを含む。

(3) 支持架構

運転質量 (kg)	A (mm ²)	A_{sy} (mm ²)	A_{sz} (mm ²)	Z_y (mm ³)	Z_z (mm ³)	F (MPa)	F^* (MPa)

(4) 基礎ボルト

A_{ab} (mm ²)	F (MPa)	F^* (MPa)

(冬期休止側ベイ)

(1) 伝熱管

D_o (mm)	t (mm)	Z_f (mm ³)	i_1 (-)	i_2 (-)

(2) 支持架構搭載機器

部材	m (kg)	h (mm)	取付ボルト 配置	L (mm)	A_b (mm ²)	n (-)	n_t (-)	F (MPa)	F^* (MPa)	M_p (N・mm)
原動機										
取付ボルト										
減速機										
取付ボルト										
ファンリング										
サポート										
取付ボルト										
管束										
取付ボルト										
ルーバ										
取付ボルト										
遮熱板										
取付ボルト										

注記 * 1 : ファンリングサポート, ファンリングを含む。

* 2 : ファンリングを含む。

(3) 支持架構

運転質量 (kg)	A (mm ²)	A_{sy} (mm ²)	A_{sz} (mm ²)	Z_y (mm ³)	Z_z (mm ³)	F (MPa)	F^* (MPa)

(4) 基礎ボルト

A_{ab} (mm ²)	F (MPa)	F^* (MPa)

4.1.4 結論

(冬期運転側ペイ)

(単位：MPa)

部材	材料	応力	S d 又は 3.6C _i		S s		
			算出応力*1	許容応力	算出応力	許容応力	
伝熱管	[Redacted]	一次	[Redacted]	[Redacted]	[Redacted]	[Redacted]	
		一次+二次					
支持架 構搭載機器	[Redacted]	原動機 取付ボルト	[Redacted]	[Redacted]	[Redacted]	[Redacted]	
		引張					
		せん断					
		減速機 取付ボルト					引張
		せん断					
		ファンリングサポート 取付ボルト					引張
		せん断					
管束 取付ボルト	引張						
せん断							
ルーバ 取付ボルト	[Redacted]	引張	[Redacted]	[Redacted]	[Redacted]	[Redacted]	
		せん断					
遮熱板 取付ボルト	[Redacted]	引張	[Redacted]	[Redacted]	[Redacted]	[Redacted]	
		せん断					
支持架構	[Redacted]	引張	[Redacted]	[Redacted]	[Redacted]	[Redacted]	
		圧縮					
		曲げ					
		せん断					
		組合せ(引張+曲げ)					
組合せ(圧縮+曲げ)							
基礎ボルト	[Redacted]	引張	[Redacted]	[Redacted]	[Redacted]	[Redacted]	
		せん断					

注記 *1 : S s による算出応力が S d 又は 3.6C_i の許容応力以下である場合は記載を省略する。

全て許容応力以下であるので十分な耐震性が確保される。

(冬期休止側ベイ)

(単位：MPa)

部材	材料	応力	S _d 又は 3.6C _i		S _s	
			算出応力*1	許容応力	算出応力	許容応力
伝熱管		一次				
		一次+二次				
支持架 構搭 載機 器	原動機 取付ボルト	引張				
	減速機 取付ボルト	せん断				
	ファンリングサポート 取付ボルト	引張				
		せん断				
	管束 取付ボルト	引張				
		せん断				
	ルーバ 取付ボルト	引張				
遮熱板 取付ボルト	せん断					
支持架 構		引張				
		圧縮				
		曲げ				
		せん断				
		組合せ(引張+曲げ)				
	組合せ(圧縮+曲げ)					
基礎ボルト		引張				
		せん断				

注記 *1 : S_s による算出応力が S_d 又は 3.6C_i の許容応力以下である場合は記載を省略する。

全て許容応力以下であるので十分な耐震性が確保される。

5. 動的機能維持評価

5.1 構造の説明

5.2 評価方針

5.2.1 計算条件

5.2.2 解析モデルの設定方法

5.2.3 荷重の組合せ及び許容応力

5.2.4 計算方法

5.2.5 原動機の計算方法

5.2.6 評価

本資料の5.動的機能維持評価から5.2.4については、「添付IV-1-2-1 機器の耐震性に関する計算書作成の基本方針」4.動的機能維持評価による。

5.2.5 原動機の計算方法

機能確認済加速度との比較により、詳細検討が必要となった原動機の計算方法を以下に示す。

5.2.5.1 記号の説明

記号	表示内容	単位
A	原動機軸断面積	mm ²
l	原動機軸の支持間長さ	mm
M	等分布荷重により作用するモーメント	N・mm
P	原動機軸に作用する荷重	N
S _y	「JSME S NC1」付録材料図表 Part5 表8に定める値	MPa
S _u	「JSME S NC1」付録材料図表 Part5 表9に定める値	MPa
Z	断面係数	mm ³
σ _b	原動機軸に生じる曲げ応力	MPa
σ _t	原動機軸に生じる引張応力	MPa
τ	原動機軸に生じるせん断応力	MPa
σ ₁	原動機軸に生じる膜+曲げ応力	MPa
σ ₁₁	最大主応力(膜+曲げ応力)	MPa
σ ₂₁	最小主応力(膜+曲げ応力)	MPa
ω	地震力を考慮した等分布荷重	N/mm

5.2.5.2 原動機軸の応力

原動機軸に生じる応力は、次式により算出する。

(1) 引張応力

引張応力は、次式で表される。

$$\sigma_t = \frac{\omega l}{A} \dots\dots\dots (5.2.5.2-1)$$

(2) 曲げ応力

曲げ応力は、次式で表される。

$$\sigma_b = \frac{M}{Z} \dots\dots\dots (5.2.5.2-2)$$

(3) せん断応力

せん断応力は、次式で表される。

$$\tau = \frac{\omega l}{A} \dots\dots\dots (5.2.5.2-3)$$

(4) 膜+曲げ応力

膜+曲げ応力は、次式で表される。

$$\sigma_1 = \sigma_{11} - \sigma_{21} \dots\dots\dots (5.2.5.2-4)$$

$$\sigma_{11} = \frac{1}{2} \left\{ (\sigma_t + \sigma_b) + \sqrt{(\sigma_t + \sigma_b)^2 + 4\tau^2} \right\} \dots\dots\dots (5.2.5.2-5)$$

$$\sigma_{21} = \frac{1}{2} \left\{ (\sigma_t + \sigma_b) - \sqrt{(\sigma_t + \sigma_b)^2 + 4\tau^2} \right\} \dots\dots\dots (5.2.5.2-6)$$

5.2.5.3 原動機軸受荷重の計算方法

冷却塔の地震応答解析によって得られる設置場所の地震力より，軸受部に作用する荷重は，次式で表される。

$$P = \omega \cdot 1 \dots\dots\dots (5.2.5.3-1)$$

5.2.6 評価

原動機軸の評価に用いる許容値を以下に示す。

供用状態	応力の種類	許容応力
Cs	膜+曲げ応力	S_y と $0.6S_u$ の小さい方の 1.5 倍の値

6. 評価内容

6.1 ファン軸

6.1.1 解析モデル

- ・ファン軸解析モデルを第 6.1.1-1 図に，モデル諸元を第 6.1.1-1 表に示す。
- ・計算は，解析コード「MSC.NASTRAN Ver. 2008.0.0」を使用する。なお，解析コードの検証及び妥当性確認等の概要については，「IV-3 計算機プログラム(解析コード)の概要」に示す。

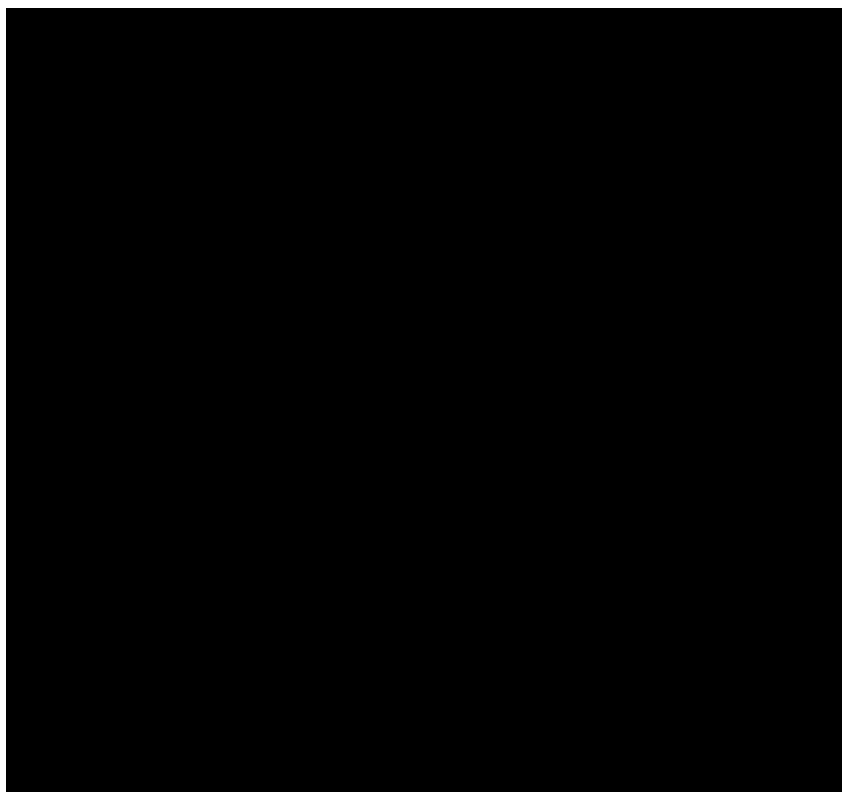

第 6.1.1-1 図 安全冷却水 B 冷却塔ファン軸解析モデル図

第 6.1.1-1 表 安全冷却水 B 冷却塔 ファン軸解析モデル諸元

要素数	■
節点数	■

6.1.2 結論

解析結果及び機器要目並びに評価結果について、第6.1.2-1表～第6.1.2-3表に示す。

第6.1.2-1表 安全冷却水B冷却塔 解析結果

		固有周期 (s)	
原動機		—*1	
減速機	本体	—*1	
	ファン軸	停止時	[Redacted]
		回転時	
ファンリング		[Redacted]	

注記 *1 : JEAG4601-1991 追補版において、十分に剛であることが示されている。

第6.1.2-2表 安全冷却水B冷却塔 機器要目

ファン軸

d (mm)	F (MPa)
[Redacted]	

原動機軸

l (mm)	A (mm ²)	Z (mm ³)	S _y (MPa)	S _u (MPa)
[Redacted]				

第 6.1.2-3 表 安全冷却水 B 冷却塔 評価結果 (1/2)

(冬期運転側ベイ)

ファン

		S s	
		算出応力 (MPa)	許容応力 (MPa)
ファン軸			
軸受		算出荷重 (N)	許容荷重 (N)
	上部軸受		
	下部軸受		
チップ クリアランス		ファン軸先端の 最大変位 (mm)	許容値 (mm)

原動機

加速度評価

	S s				
	EW	NS	UD	EW/NS	UD
加速度	応答加速度 (G)			機能確認済 加速度 (G)	機能確認済 加速度 (G)

詳細評価

		S s	
		算出応力 (MPa)	許容応力 (MPa)
原動機軸			
軸受		算出荷重 (N)	許容荷重 (N)

第 6.1.2-3 表 安全冷却水 B 冷却塔 評価結果 (2/2)

(冬期休止側ベイ)

ファン

		S s	
		算出応力 (MPa)	許容応力 (MPa)
ファン軸			
軸受		算出荷重 (N)	許容荷重 (N)
	上部軸受		
	下部軸受		
チップ クリアランス		ファン軸先端の 最大変位 (mm)	許容値 (mm)

原動機

加速度評価

	S s				
	EW	NS	UD	EW/NS	UD
加速度	応答加速度 (G)			機能確認済 加速度 (G)	機能確認済 加速度 (G)

詳細評価

		S s	
		算出応力 (MPa)	許容応力 (MPa)
原動機軸			
軸受		算出荷重 (N)	許容荷重 (N)

全て許容値以下であるので十分な耐震性が確保される。

別紙4-21

安全冷却水B冷却塔 飛来物防護ネットの計算書

本添付書類は、別で定める方針に沿った評価・計算を示す書類であり、結果を示すものであることから、発電炉との比較は行わない。

IV-2-2-2-1-2-1-1
飛来物防護ネット(再処理設備本体
用 安全冷却水系冷却塔 B)の地震
応答計算書

目 次

	ページ
1. 概要	1
2. 基本方針	2
2.1 位置	2
2.2 構造概要	3
2.3 解析方針	10
2.4 準拠規格・基準等	12
3. 解析方法	13
3.1 地震応答解析に用いる地震動	13
3.2 地震応答解析モデル	15
3.2.1 飛来物防護ネット架構	18
3.2.2 地盤	23
3.3 入力地震動	29
3.4 解析方法	30
3.5 解析条件	31
3.6 材料物性のばらつき	34
4. 解析結果	45
4.1 固有値解析結果	45
4.2 地震応答解析結果	51
4.2.1 全応力解析	51
4.2.2 有効応力解析	85

1. 概要

本資料は、添付書類「IV-1-1-4 波及的影響に係る基本方針」の「5.2 地震応答解析」に基づき、下位クラス施設に適用する方法として添付書類「IV-1-1-5 地震応答解析の基本方針」に記載の地震応答解析の方針に従い飛来物防護ネット(再処理設備本体用 安全冷却水系冷却塔B)(以下、「飛来物防護ネット架構」という。)の地震応答解析について説明するものである。

2. 基本方針

2.1 位置

飛来物防護ネット架構の設置位置を第2.1-1図に示す。

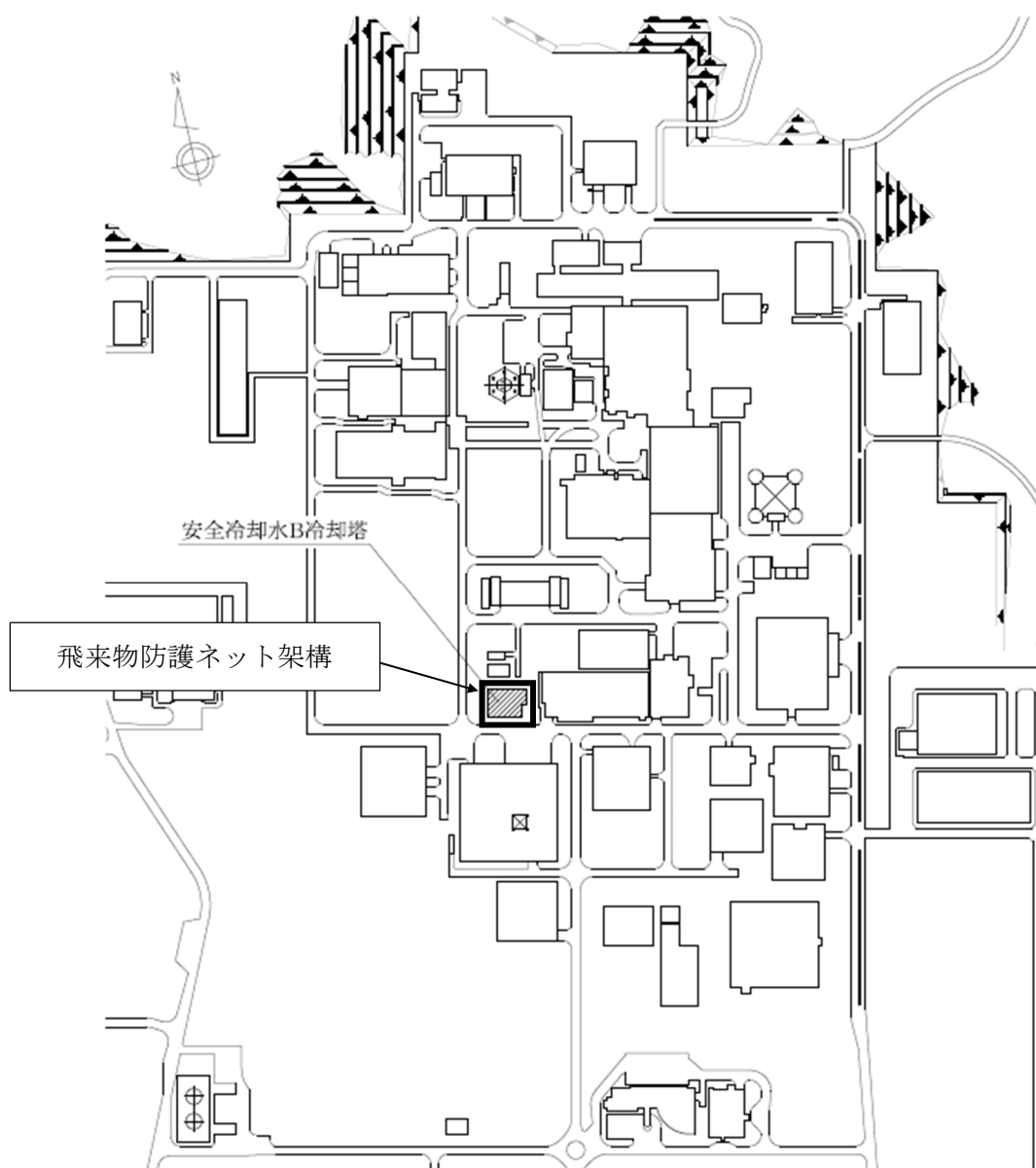

第2.1-1図 飛来物防護ネット架構の設置位置

2.2 構造概要

飛来物防護ネット架構は、鉄骨造の支持架構、鉄筋コンクリート造の基礎梁及び杭によって構成される。

支持架構は、柱、大はり、小はり、トラス柱、鉛直ブレース及び水平ブレースからなるフレーム及び座屈拘束ブレースによって構成され、平面形状は、36.00m(NS方向)×47.90m(EW方向)であり、地上高さは、20.30mである。

座屈拘束ブレースは、中心鋼材を座屈拘束材(鋼管とモルタル)で拘束し、繰り返し作用する地震荷重に対して、安定的に塑性化することでエネルギーを吸収することにより、フレームに作用する荷重を低減するものであり、支持架構にねじれが生じないように配置している。なお、採用した座屈拘束ブレースは、平成12年建設省告示1461号の制振部材及び平成17年国土交通省告示第631号のエネルギー吸収部材に係る評価を受けたものである。

基礎梁は厚さ3.00mの鉄筋コンクリート造であり、支持地盤である岩盤に場所打ちコンクリート杭(外径1.00m及び1.50m、杭長16.80m及び17.80m、113本)を介して設置している。また、液状化対策として飛来物防護ネット架構下部の支持地盤以浅の地盤はセメント系の地盤改良を実施している。

なお、飛来物防護ネット架構は防護対象となる安全冷却水B冷却塔と構造的に分離している。

支持架構の全景を第2.2-1図に、屋根伏図及び杭伏図を第2.2-2図に、概略側面図を第2.2-3図に、基礎梁及び杭の断面図を第2.2-4図に示す。

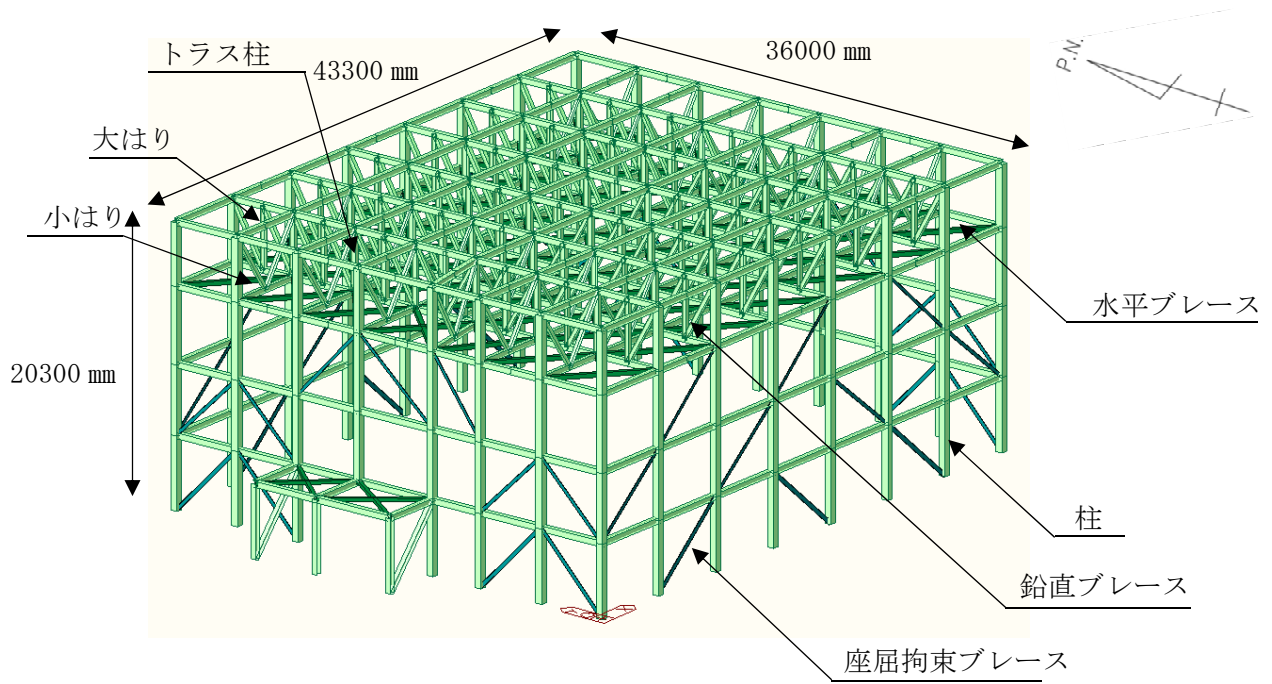

第2. 2-1図 支持架構の全景

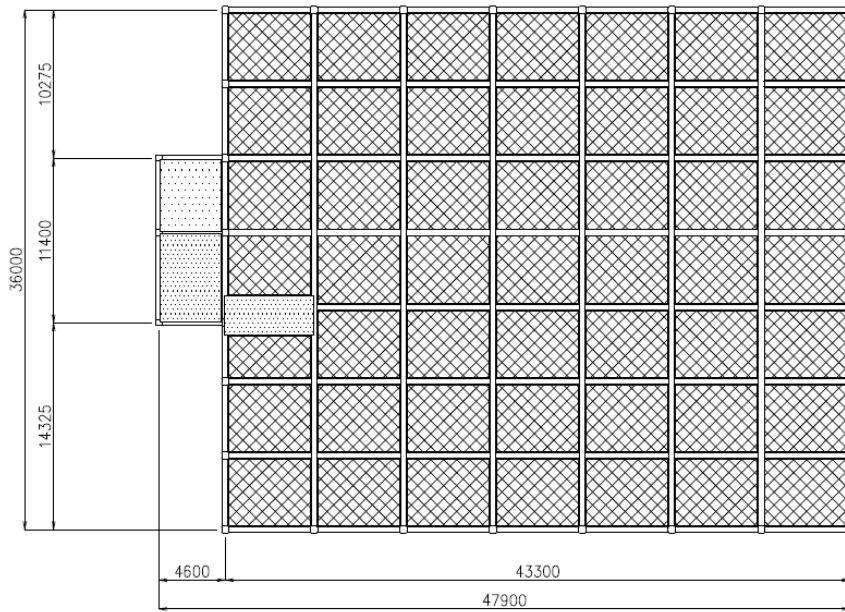

(a) 屋根伏図

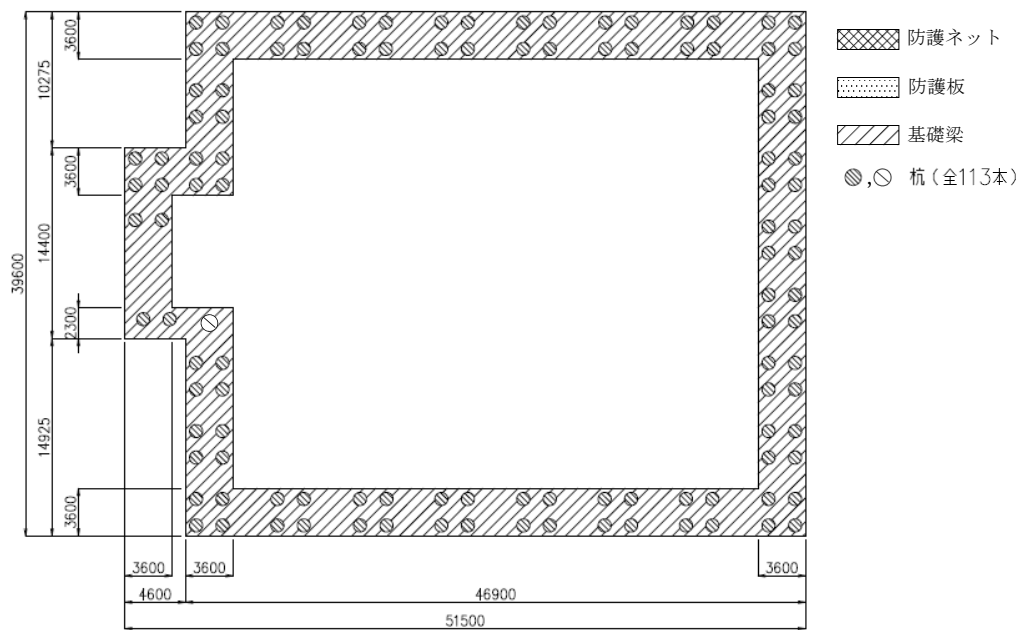

(b) 杭伏図

(単位：mm)

第2.2-2図 飛来物防護ネット架構の屋根伏図及び杭伏図

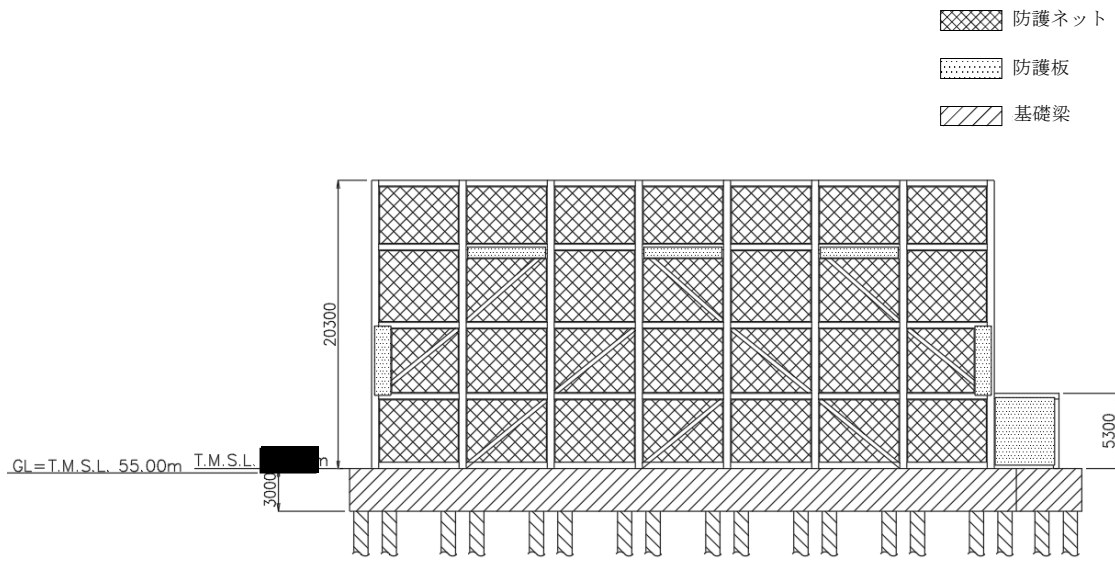

(a) 北面

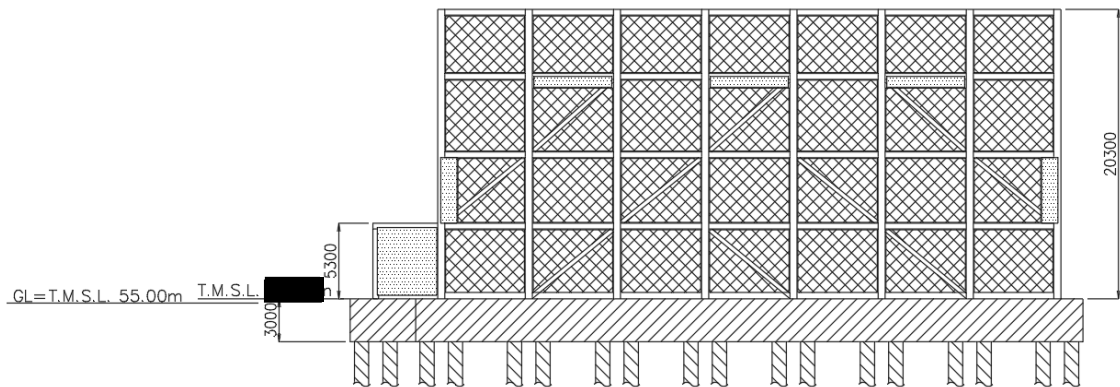

(b) 南面

(単位 : mm)

第2.2-3図 飛来物防護ネット架構の概略側面図(1/2)

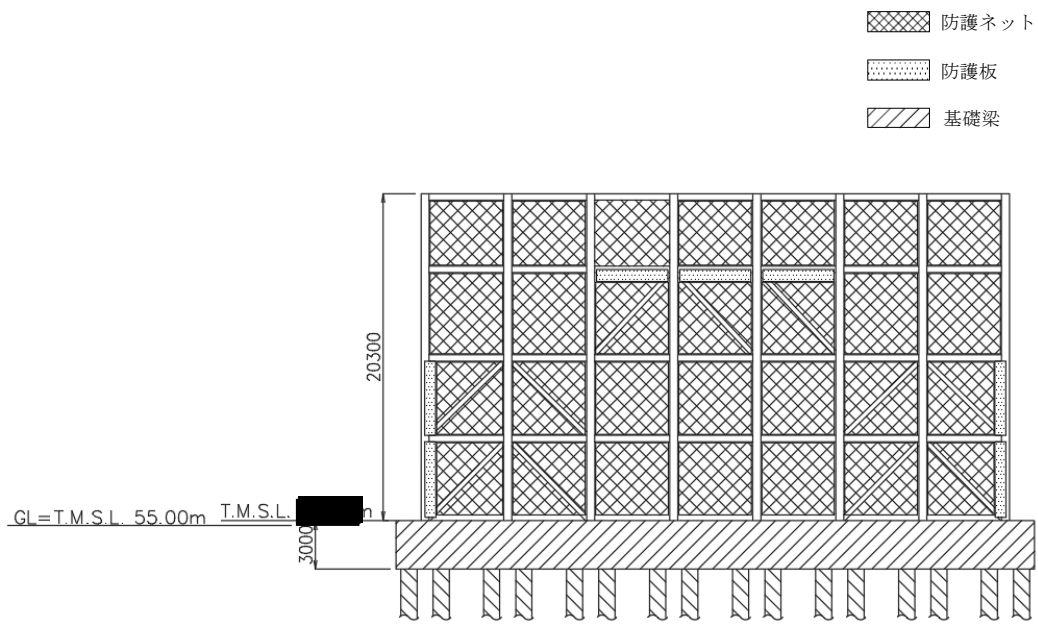

(c) 東面

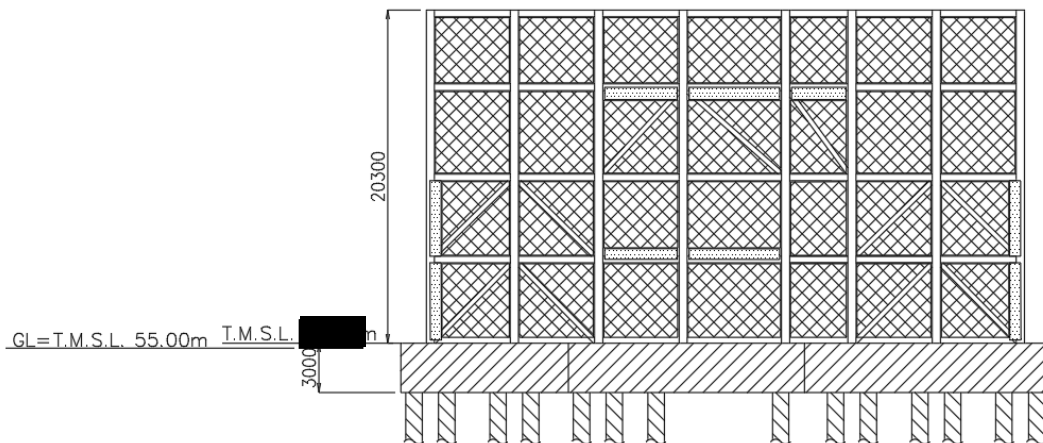

(d) 西面

(単位：mm)

第2.2-3図 飛来物防護ネット架構の概略側面図(2/2)

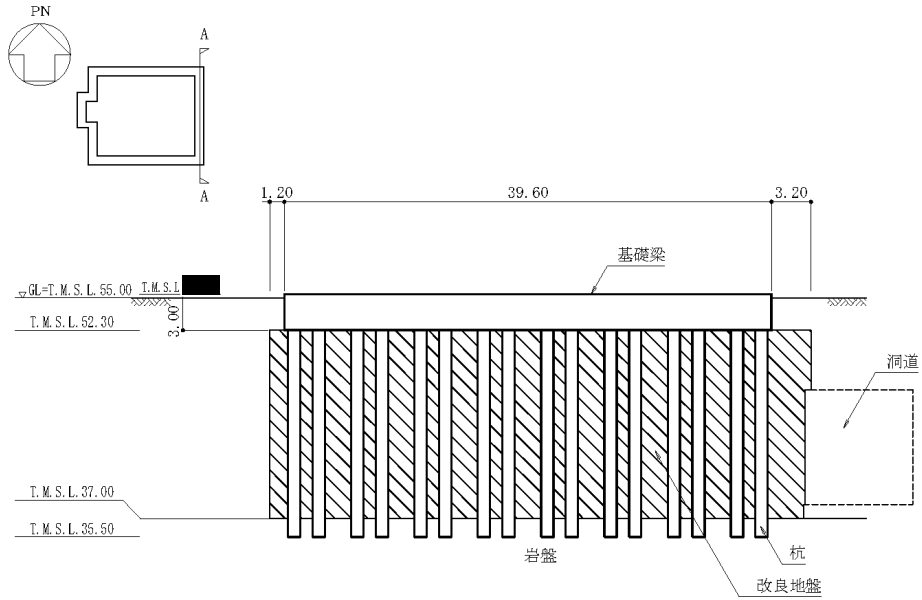

(a) A-A 断面図 (NS 方向)

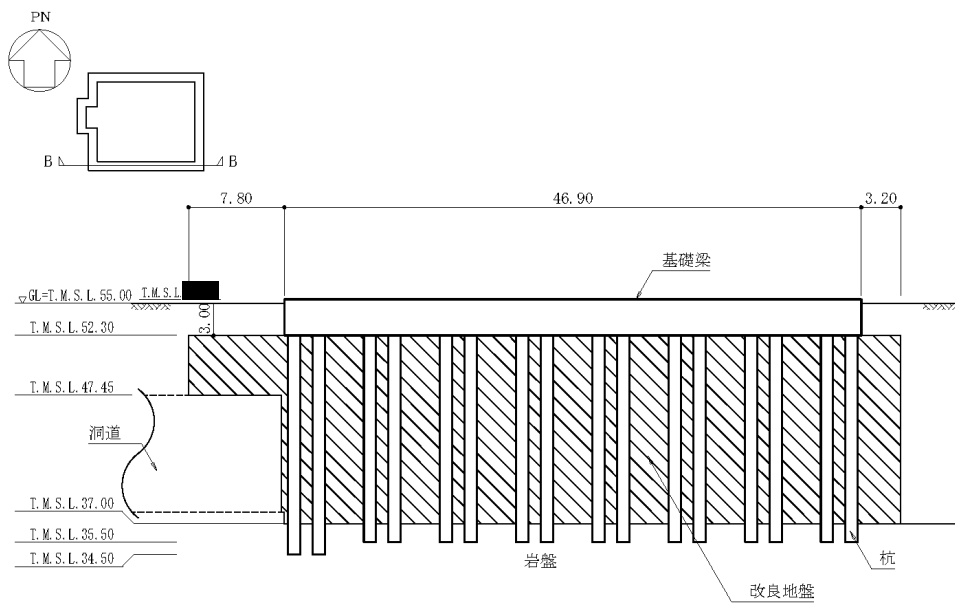

(b) B-B 断面図 (EW 方向)

(単位 : m)

第2.2-4図 基礎梁及び杭の断面図 (1/2)

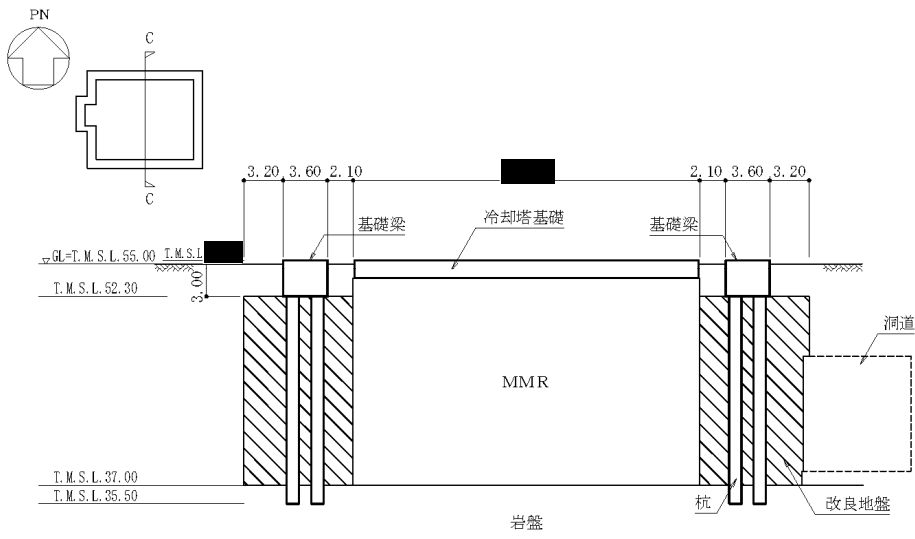

(c) C-C 断面図(NS 方向)

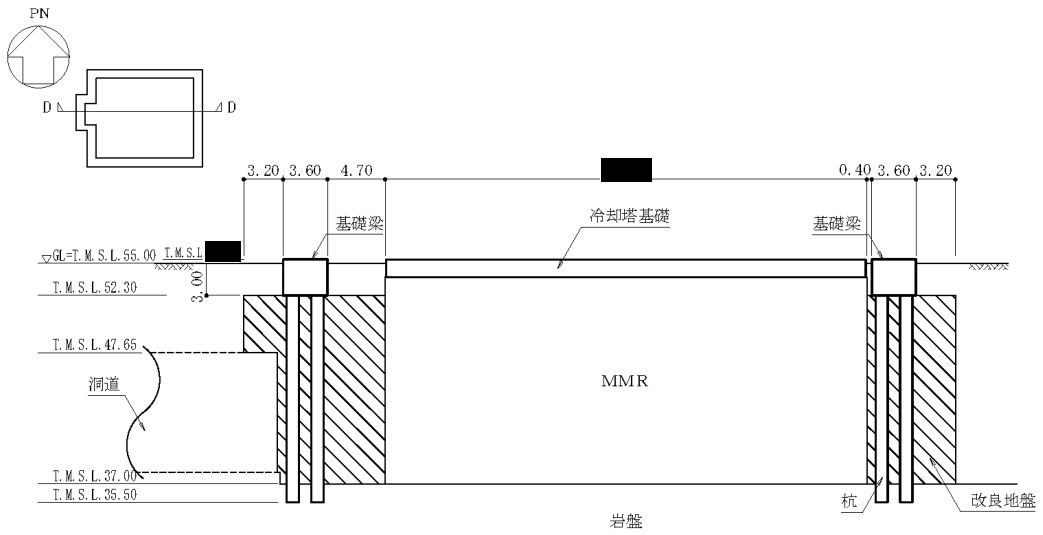

(d) D-D 断面図(EW 方向)

(単位 : m)

第2.2-4図 基礎梁及び杭の断面図(2/2)

2.3 解析方針

飛来物防護ネット架構の地震応答解析は、添付書類「IV-1-1-5 地震応答解析の基本方針」に基づいて行う。

第2.3-1図に飛来物防護ネット架構の地震応答解析フローを示す。

地震応答解析は、「3.1 地震応答解析に用いる地震動」及び「3.2 地震応答解析モデル」において設定した地震応答解析モデルに基づき、「3.3 入力地震動」において設定した入力地震動を用いて実施することとし、「3.4 解析方法」、「3.5 解析条件」及び「3.6 材料物性のばらつき」に基づき、「4. 解析結果」においては、支持架構、基礎梁及び杭の設計に係る各種応答値を算出する。

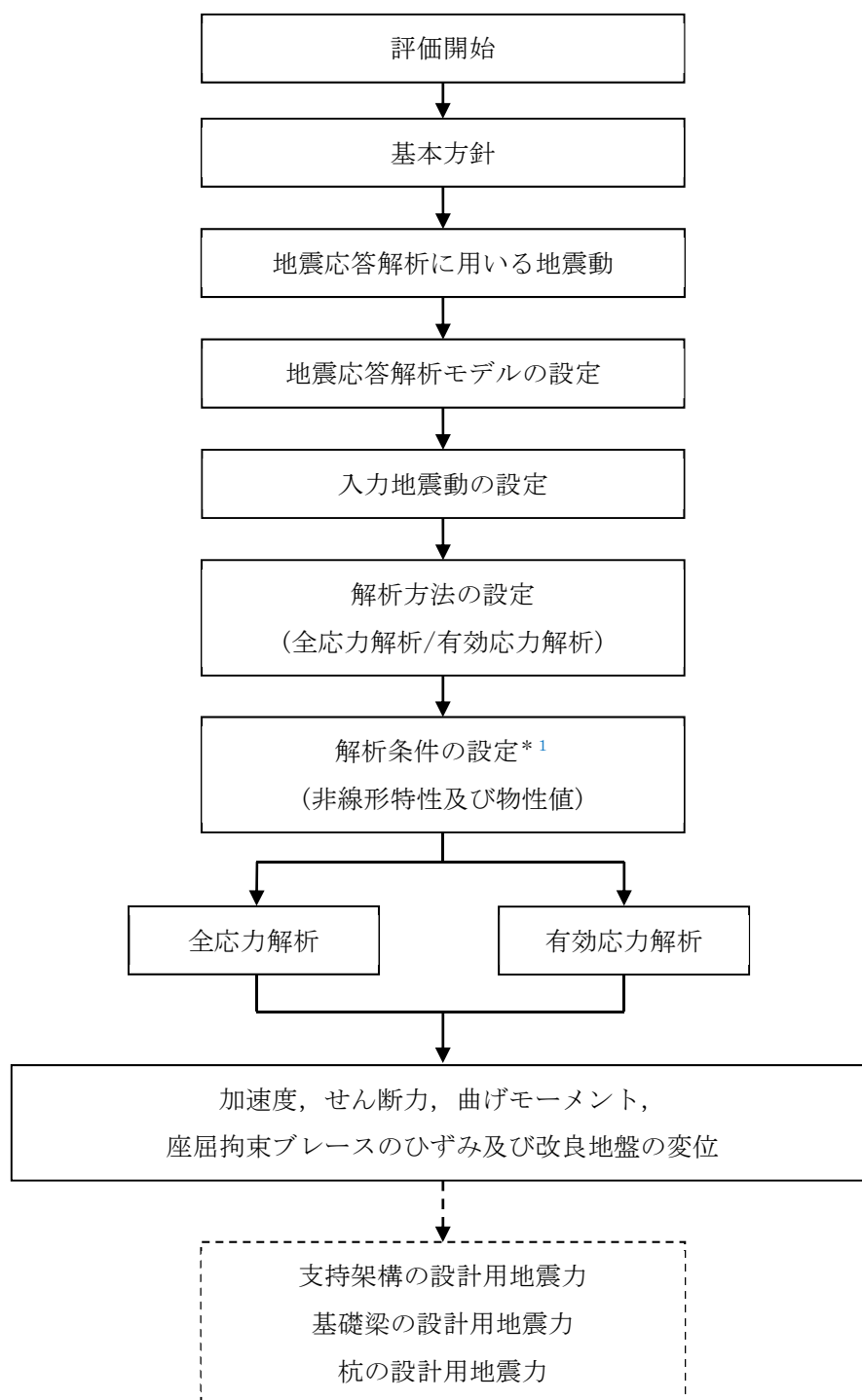

注記 * 1 : 材料物性のばらつきを考慮する。

注 : 実線部は，本資料における説明範囲を示す。

注 : 破線部は，添付書類「IV-2-2-2-1-2-1-2 飛来物防護ネット(再処理設備本体用 安全冷却水系冷却塔B)の耐震計算書」における説明範囲を示す。

第2.3-1図 飛来物防護ネット架構の地震応答解析フロー

2.4 準拠規格・基準等

地震応答解析において準拠する規格・基準等を以下に示す。

- ・ 建築基準法・同施行令
- ・ 鋼構造設計規準((社)日本建築学会, 2005)
- ・ 鉄筋コンクリート構造計算規準・同解説—許容応力度設計法—((社)日本建築学会, 1999)
- ・ 原子力発電所耐震設計技術指針 JEAG 4601-1987((社)日本電気協会)
- ・ 原子力発電所耐震設計技術指針 重要度分類・許容応力編 JEAG 4601・補—1984((社)日本電気協会)
- ・ 原子力発電所耐震設計技術指針 JEAG 4601-1991 追補版((社)日本電気協会)

3. 解析方法

3.1 地震応答解析に用いる地震動

地震応答解析に用いる地震動は、添付書類「IV-1-1-1 基準地震動 S_s 及び弾性設計用地震動 S_d の概要」に示す解放基盤表面レベルで定義された基準地震動 S_s とする。

但し、基準地震動 S_s のうち $Ss-B1\sim B5$ については、建物・構築物への入力地震動を評価する際に、プラントノース(真北に対し、時計回りに 13° の方向)に変換を行う。

また、本解析においては、水平及び鉛直を同時入力する方針としているが、基準地震動 S_s のうち $Ss-C4$ は水平方向のみの地震動であるため、 $Ss-C4$ とともに鉛直方向に一関東評価用地震動(鉛直)を入力した地震応答解析を実施する。

一関東評価用地震動(鉛直)の時刻歴加速度波形を第3.1-1図に、解放基盤表面レベルにおける設計用応答スペクトルを基準地震動 S_s の設計用応答スペクトルと併せて第3.1-2図に示す。

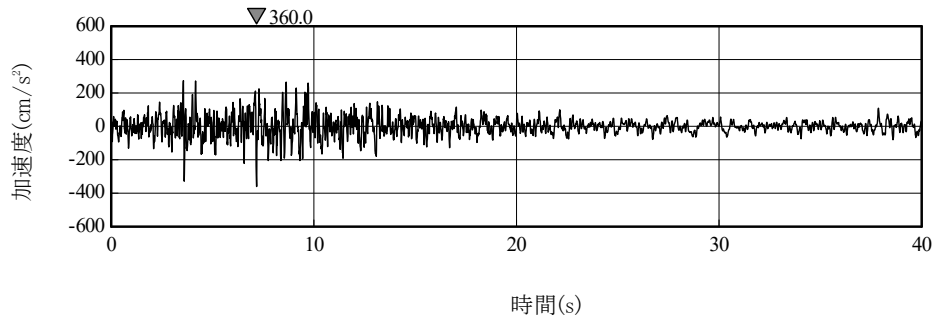

注：再処理施設の事業変更許可申請書 第 1.6-6 図から引用
 第3.1-1図 一関東評価用地震動(鉛直)の加速度時刻歴波形

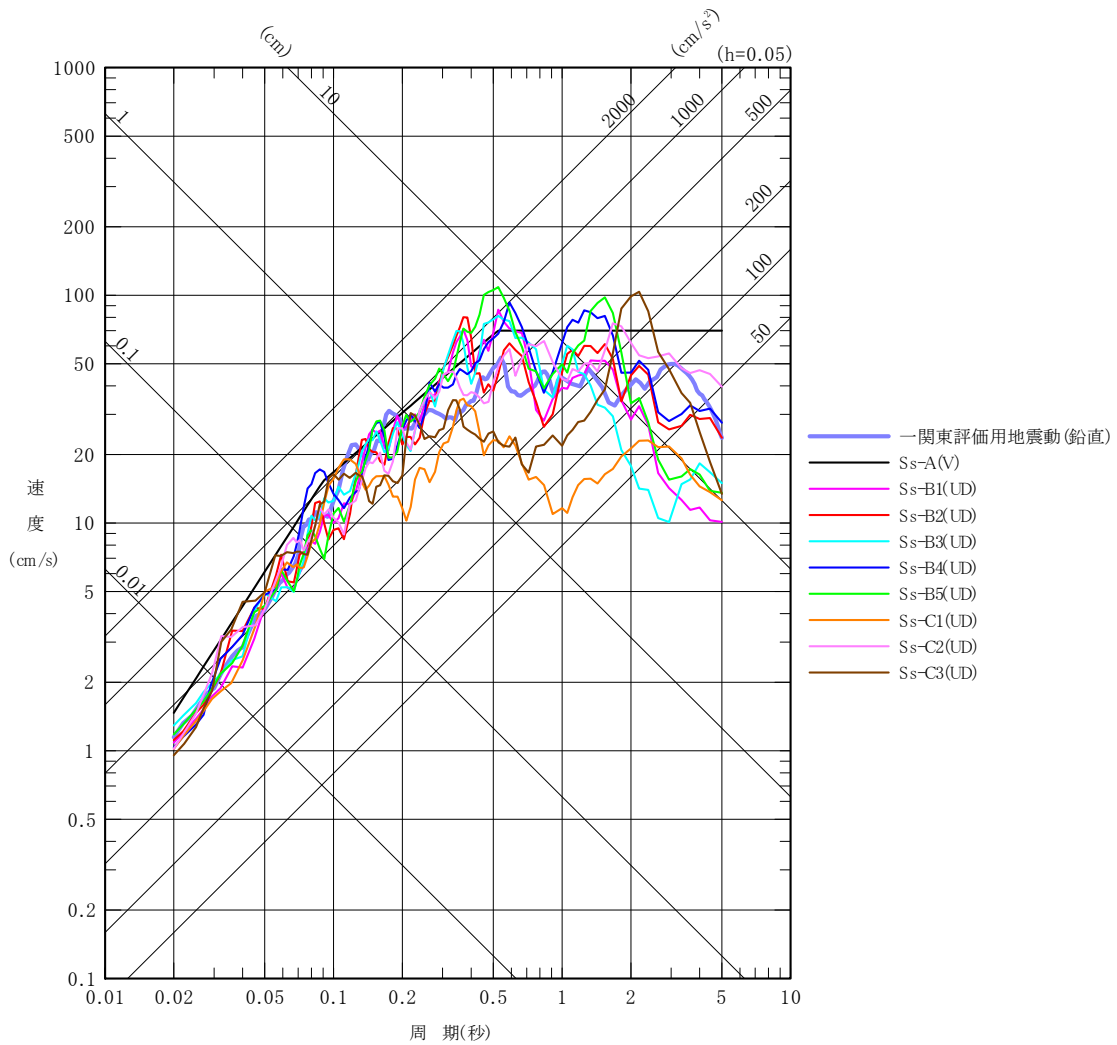

注：再処理施設の事業変更許可申請書 第 1.6-5 図から引用
 第3.1-2図 一関東評価用地震動(鉛直)の設計用応答スペクトル

3.2 地震応答解析モデル

地震応答解析は、添付書類「IV-1-1-5 地震応答解析の基本方針」に基づき、飛来物防護ネット架構と地盤の動的相互作用を考慮できる2次元動的有限要素法を用い、水平地震動と鉛直地震動の同時加振による逐次時間積分の時刻歴非線形解析を行う。また、全応力解析に加え、地震時の地盤の液状化の影響を考慮し、有効応力解析を実施する。地震応答解析モデルを第3.2-1図に示す。

地震応答解析モデル(以下、「本モデル」という。)は、解析負荷の観点から、施設の周辺状況をより詳細にモデル化した場合と比較し合理化を図っていることから、妥当性及び保守性を有していることを検証している。

妥当性の検証においては、メッシュサイズについて、支持架構の固有振動数に照らして適切であることを確認している。また、支持架構(門型ではなく1軸でモデル化)、接触剥離要素(モデル化しない)、改良地盤幅(実態より小さくモデル化)、粗粒砂岩(モデル化しない)及び基礎梁高さ(剛梁としてモデル化)について、合理化しない場合と比較し、同等又は保守的な応答となることを確認している。

保守性の検証においては、水平方向の拘束効果に着目し、水平応答が保守的になるようにモデル化しない周辺構造物、杭及びMMRについて、モデル化した場合と比較し、水平応答は保守的となる一方で鉛直応答は小さくなるものの、波及的影響評価においては、鉛直応答の寄与は相対的に小さく支障ないことを確認している。

また、地盤の剛性変化についても、①非液状化(全応力解析)及び②液状化(有効応力解析)と比較し、一部地震動で中間状態(①と②の間となるよう埋戻し土の物性値を変更した解析)の応答が大きくなるものの、波及的影響評価においては、中間状態の応答の寄与は相対的に小さく、本モデルによる①非液状化(全応力解析)及び②液状化(有効応力解析)の応答を用いて支障ないことを確認している。

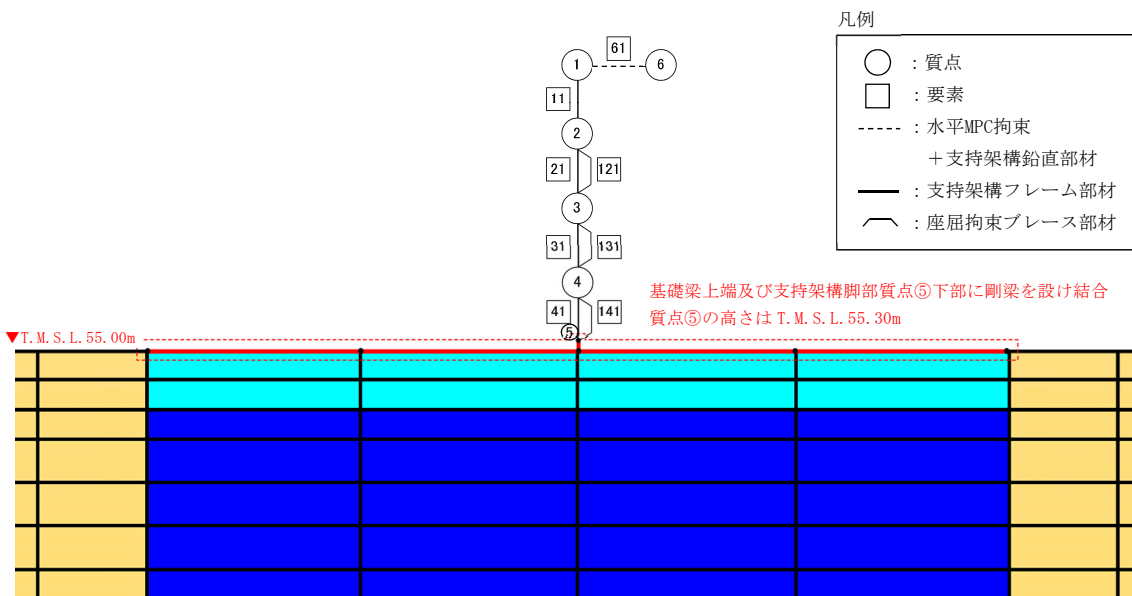
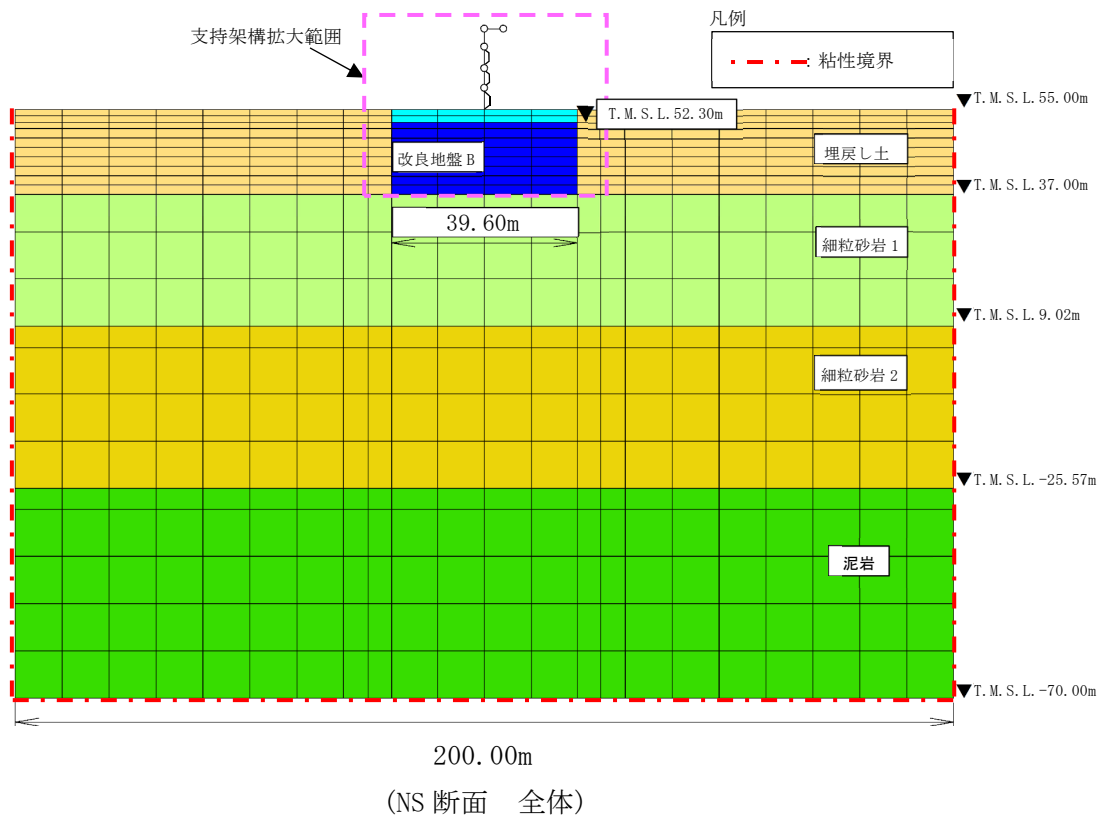

- 注：回転自由度を要する線形バネにつながる質点⑥の回転自由度を拘束
- 注：質点①と質点⑥の水平並進自由度を互いに拘束
- 注：地下水位を地表面に設定
- 注：[61]はばね要素

第3.2-1図 地震応答解析モデル(1/2)

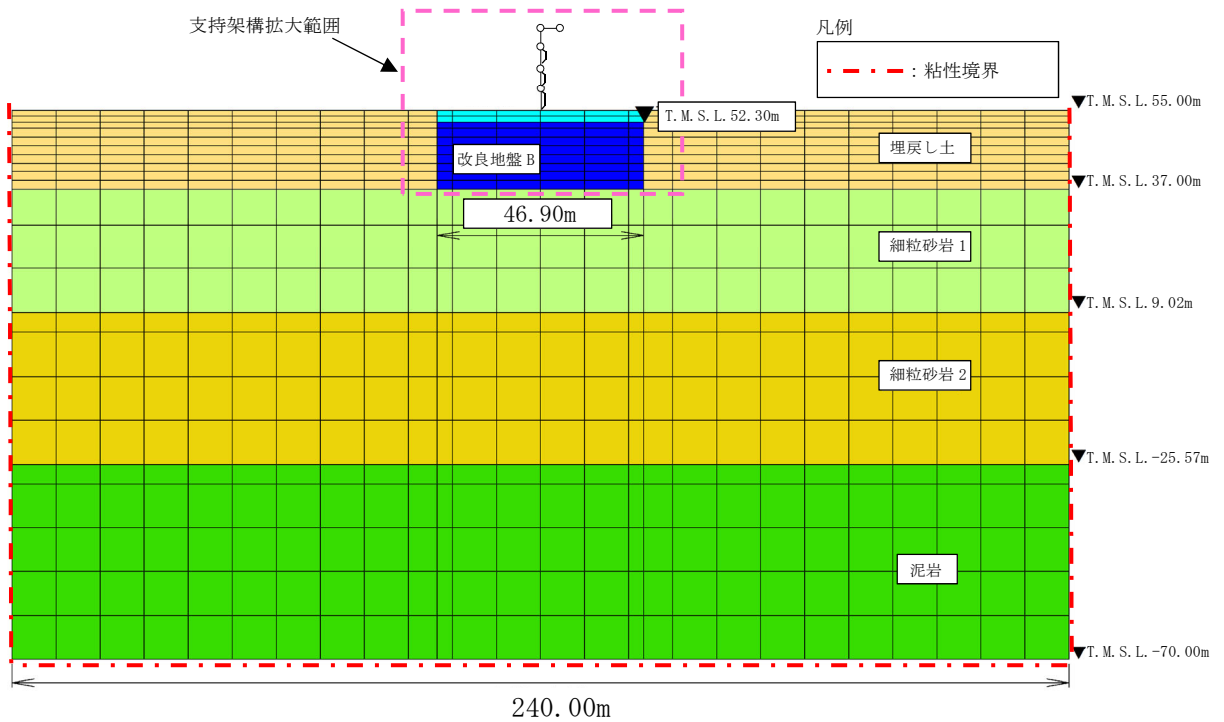

(EW 断面 全体)

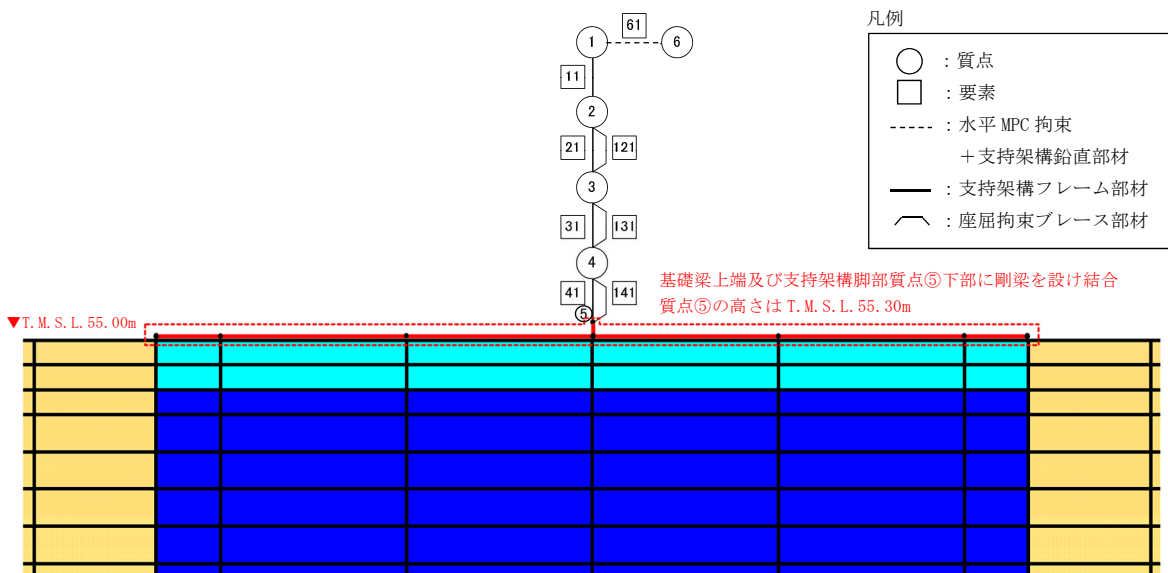

- 注：回転自由度を要する線形バネにつながる質点⑤の回転自由度を拘束
- 注：質点①と質点⑥の水平並進自由度を互いに拘束
- 注：地下水位を地表面に設定
- 注：61 はばね要素

(EW 断面 支持架構拡大)

第3.2-1図 地震応答解析モデル(2/2)

3.2.1 飛来物防護ネット架構

支持架構は質点系モデルとし、フレームは梁要素、座屈拘束ブレースは非線形特性を考慮し、ばね要素でモデル化する。基礎梁は平面ひずみ要素でモデル化し、基礎梁上端に剛梁を配置し、支持架構と結合させる。なお、杭は基礎梁直下の改良地盤と同一変形するものとし、モデル化には考慮しない。本モデルの設定に用いた支持架構及び基礎梁の使用材料の物性値を第3.2.1-1表、[解析モデル諸元](#)を第3.2.1-2表及び第3.2.1-3表に示す。

第3.2.1-1表 使用材料の物性値

部位	使用材料	ヤング 係数 E (N/mm ²)	せん断 弾性係数 G (N/mm ²)	減衰 定数 h (%)
支持 架 構	鉄骨 BCP325, G385, SN490B	2.05×10^5	7.90×10^4	2
	座屈拘束ブレース	2.05×10^5	7.90×10^4	2
基礎 梁	鉄筋コンクリート コンクリート： Fc=24(N/mm ²) 鉄筋：SD345	2.27×10^4	9.45×10^3	5
剛 梁	-	2.60×10^7	1.00×10^7	5

第3.2.1-2表 支持架構の解析モデル諸元(1/2)

(a) NS 断面

質点 番号	質点 位置 T. M. S. L. (m)	質量要素			要素 番号	要素 位置 T. M. S. L. (m)	支持架構			座屈拘束ブレース及び屋根	
		水平 (kN)	鉛直 (kN)	回転 ($\times 10^3 \text{kN} \cdot \text{m}^2$)			断面積 A (m^2)	断面2次 モーメント I ($\times 10^4 \text{m}^4$)	せん断 断面積 As (m^2)	要素 番号	ばね剛性 K ($\times 10^3 \text{kN/m}$)
⑥	75.60	0.000	398.6	0.00	—	75.60	—	—	—	61	26.8
①	75.60	476.0	238.0	43.7	11	75.60~ 71.10	0.0907	1.324	0.00179	—	—
②	71.10	321.1	160.6	43.7	21	71.10~ 65.60	0.0934	1.324	0.000814	121	54.1
③	65.60	174.1	174.1	0.00	31	65.60~ 60.60	0.0907	1.324	0.000821	131	97.2
④	60.60	199.3	199.3	0.00	41	60.60~ 55.30	0.0947	1.324	0.00115	141	102
⑤	55.30	—	—	—	剛梁	55.30~ 55.00	1.00	10.00	1.00	—	—
総重量		1171	1171	—	—	—	—	—	—	—	—

注：重量及び剛性を単位奥行きあたりでモデル化

注：質点番号⑥は、水平自由度を MPC 拘束するために、水平方向に微小質量を定義

第3.2.1-2表 支持架構の解析モデル諸元(2/2)

(b) EW 断面

質点 番号	質点 位置 T. M. S. L. (m)	質量要素			要素 番号	要素 位置 T. M. S. L. (m)	支持架構			座屈拘束ブレース及び屋根	
		水平 (kN)	鉛直 (kN)	回転 ($\times 10^3 \text{kN} \cdot \text{m}^2$)			断面積 A (m^2)	断面2次 モーメント I ($\times 10^4 \text{m}^4$)	せん断 断面積 As (m^2)	要素 番号	ばね剛性 K ($\times 10^3 \text{kN/m}$)
⑥	75.60	0.000	472.1	0.00	—	75.60	—	—	—	61	31.8
①	75.60	563.8	281.9	74.6	11	75.60~ 71.10	0.1074	1.568	0.00191	—	—
②	71.10	380.3	190.2	74.6	21	71.10~ 65.60	0.1106	1.568	0.000894	121	69.8
③	65.60	206.2	206.2	0.00	31	65.60~ 60.60	0.1074	1.568	0.000839	131	122
④	60.60	236.0	236.0	0.00	41	60.60~ 55.30	0.1121	1.568	0.00128	141	122
⑤	55.30	—	—	—	剛梁	55.30~ 55.00	1.00	10.00	1.00	—	—
総重量		1386	1386	—	—	—	—	—	—	—	—

注：重量及び剛性を単位奥行きあたりでモデル化

注：質点番号⑥は、水平自由度を MPC 拘束するために、水平方向に微小質量を定義

第3.2.1-3表 基礎梁の解析モデル諸元

質量密度* (g/cm ³)	動ポアソン比	ヤング係数 (N/mm ²)
2.86	0.2	2.27×10 ⁴

注記 * : 基礎梁上部の積雪荷重等を含めた基礎梁重量を基礎梁
体積で除した値

3.2.2 地盤

地盤は、添付書類「IV-1-1-2 地盤の支持性能に係る基本方針」に基づき、平面ひずみ要素でモデル化する。平成10年6月9日付け9安(核規)第596号にて認可を受けた設工認申請書の添付書類「IV-2-2-4-1-1-1 安全冷却水B冷却塔基礎の地震応答計算書」では、敷地内の一定範囲内のボーリング調査結果の平均的な値を地盤の物性値として用いていたが、本申請においては、構築物近傍の地盤調査結果を重視し、飛来物防護ネット架構の直下又は近傍のボーリング調査結果を参照して設定した地盤の物性値を用いることとする。埋戻し土及び改良地盤Bは非線形特性を考慮し修正Hardin-Drnevichモデルを、岩盤(細粒砂岩及び泥岩)は等価線形解析で得られる等価物性値に基づき設定した地盤定数を用いる。地盤の物性値を第3.2.2-1表～第3.2.2-5表に示す。

解析領域は、側方境界及び底面境界との距離を十分に広く設定し、解析領域の側方境界及び底面境界には、エネルギーの逸散効果を評価するため、粘性境界を設ける。

第3.2.2-1表 埋戻し土の物性値

項目	記号	設定値	単位	
質量密度* ¹	ρ	1.82+0.0028D	g/cm ³	
間隙率	n	0.46	—	
基準拘束圧	σ'_{ma}	52.3	kN/m ²	
せん断弾性係数の依存係数	m_G	0.703	—	
基準拘束圧におけるせん断弾性係数	G_{ma}	1.26×10^5	kN/m ²	
体積弾性係数の依存係数	m_K	0.703	—	
基準拘束圧における体積弾性係数	K_{ma}	3.28×10^5	kN/m ²	
ポアソン比	ν	0.33	—	
粘着力	Cu'	0.00×10^0	kN/m ²	
内部摩擦角	$\Phi u'$	39.7	度	
履歴減衰上限値	h_{max}	0.171	—	
液状化物性* ²	変相角	Φ_p	34.0	度
	液状化パラメータ	w_1	10.30	—
		p_1	0.5	—
		p_2	1.0	—
		c_1	1.81	—
		S_1	0.005	—

注記 * 1 : D : 深度(m)とし, 要素中心深度とする。

* 2 : 液状化物性は, 有効応力解析時に用いる。

第3.2.2-2表 改良地盤Bの物性値

項目	記号	設定値	単位
質量密度	ρ	1.72	g/cm ³
間隙率	n	0.55	—
基準拘束圧	σ'_{ma}	1.0	kN/m ²
せん断弾性係数の依存係数	m_G	0.00	—
基準拘束圧におけるせん断弾性係数	G_{ma}	1.10×10^6	kN/m ²
体積弾性係数の依存係数	m_K	0.00	—
基準拘束圧における体積弾性係数	K_{ma}	2.87×10^6	kN/m ²
ポアソン比	ν	0.33	—
粘着力	Cu'	3.00×10^3	kN/m ²
内部摩擦角	$\Phi u'$	0.001	度
履歴減衰上限値	h_{max}	0.167	—

第3.2.2-3表 細粒砂岩1の物性値

地震動	質量密度 (g/cm ³)	動ポアソン比	せん断弾性 係数 ($\times 10^4$ kN/m ²)	減衰定数	P波速度 V _p (m/s)	S波速度 V _s (m/s)
Ss-A	1.87	0.43	80.7	0.02	1840	657
Ss-B1	1.87	0.43	80.4	0.02	1840	656
Ss-B2	1.87	0.43	81.0	0.02	1840	658
Ss-B3	1.87	0.43	80.6	0.02	1840	656
Ss-B4	1.87	0.43	80.3	0.02	1840	655
Ss-B5	1.87	0.43	79.6	0.02	1830	653
Ss-C1	1.87	0.43	79.1	0.02	1820	650
Ss-C2	1.87	0.43	81.4	0.02	1850	660
Ss-C3	1.87	0.43	81.5	0.02	1850	660
Ss-C4	1.87	0.43	81.1	0.02	1850	659

第3.2.2-4表 細粒砂岩2の物性値

地震動	質量密度 (g/cm ³)	動ポアソン比	せん断弾性 係数 ($\times 10^4$ kN/m ²)	減衰定数	P波速度 V _p (m/s)	S波速度 V _s (m/s)
Ss-A	1.85	0.37	154	0.02	1980	914
Ss-B1	1.85	0.37	156	0.02	1990	919
Ss-B2	1.85	0.37	156	0.02	1990	918
Ss-B3	1.85	0.37	155	0.02	1990	917
Ss-B4	1.85	0.37	154	0.02	1980	911
Ss-B5	1.85	0.37	154	0.02	1980	912
Ss-C1	1.85	0.37	152	0.02	1960	905
Ss-C2	1.85	0.37	156	0.02	1990	917
Ss-C3	1.85	0.37	156	0.02	1990	917
Ss-C4	1.85	0.37	155	0.02	1990	915

第3.2.2-5表 泥岩の物性値

地震動	質量密度 (g/cm ³)	動ポアソン比	せん断弾性 係数 ($\times 10^4$ kN/m ²)	減衰定数	P波速度 V _p (m/s)	S波速度 V _s (m/s)
Ss-A	1.72	0.39	104	0.02	1850	778
Ss-B1	1.72	0.39	105	0.02	1860	781
Ss-B2	1.72	0.39	105	0.02	1860	780
Ss-B3	1.72	0.39	105	0.02	1860	780
Ss-B4	1.72	0.39	104	0.02	1850	776
Ss-B5	1.72	0.39	104	0.02	1850	777
Ss-C1	1.72	0.39	103	0.02	1840	773
Ss-C2	1.72	0.39	105	0.02	1860	780
Ss-C3	1.72	0.39	104	0.02	1850	778
Ss-C4	1.72	0.39	104	0.02	1860	779

3.3 入力地震動

地震応答解析に用いる入力地震動は、解放基盤表面レベルに想定する基準地震動 S_s とする。地震応答解析は、解析モデル下端レベル(T. M. S. L. -70.00m)に入力地震動を水平方向及び鉛直方向に同時入力することで実施する。本モデルに入力する地震動の概念図を第3.3-1図に示す。

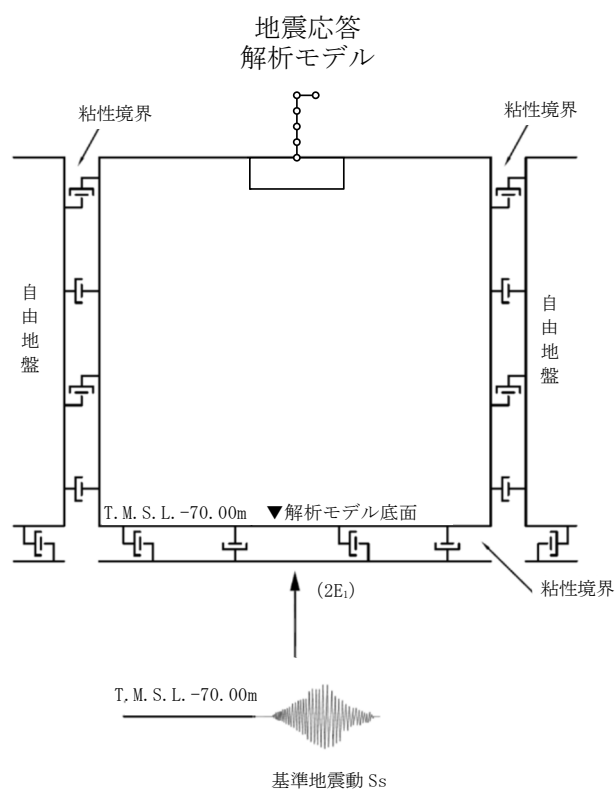

第 3.3-1 図 本モデルに入力する地震動の概念図

3.4 解析方法

飛来物防護ネット架構の地震応答解析は、全応力解析及び有効応力解析ともに、解析コード「FLIP Ver7.4.1」を用いる。

全応力解析及び有効応力解析は、添付書類「IV-1-1-5 地震応答解析の基本方針」に記載の解析方法に基づき、時刻歴応答解析により実施する。

なお、解析コードの検証及び妥当性の確認等の概要については、添付書類「IV-3 計算機プログラム(解析コード)の概要」に示す。

3.5 解析条件

座屈拘束ブレースに作用する応力-変形関係は、特性確認試験結果をもとにバイリニア型スケルトン曲線とする。

座屈拘束ブレースに作用する応力-変形関係を第3.5-1図に示す。

座屈拘束ブレースに作用する応力-変形関係の履歴特性は特性確認試験結果をもとにノーマルバイリニア型スケルトン曲線とする。

座屈拘束ブレースに作用する応力-変形関係の履歴特性を第3.5-2図に示す。

座屈拘束ブレースの非線形ばね要素諸元を第3.5-1表に示す。

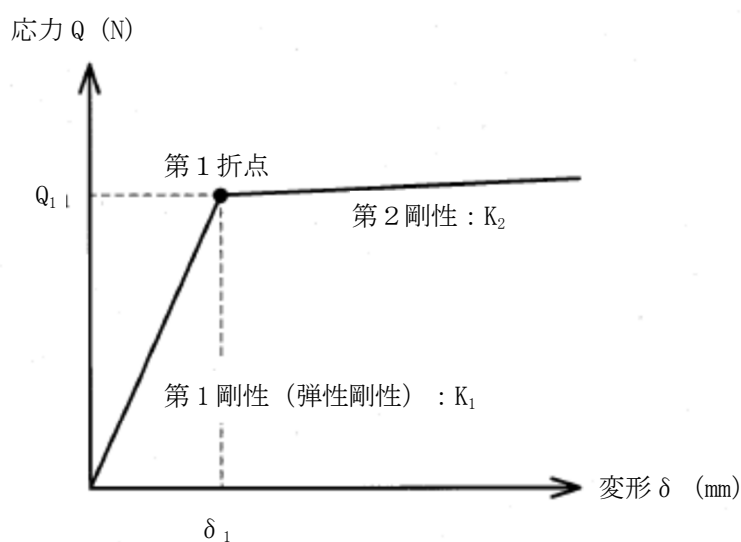

Q_1 : 第1 折点応力

δ_1 : 第1 折点変形

K_1 : 第1 剛性 (弾性剛性)

K_2 : 第2 剛性 ($K_1 \times 0.001$)

第3.5-1図 応力-変形関係(座屈拘束ブレース)

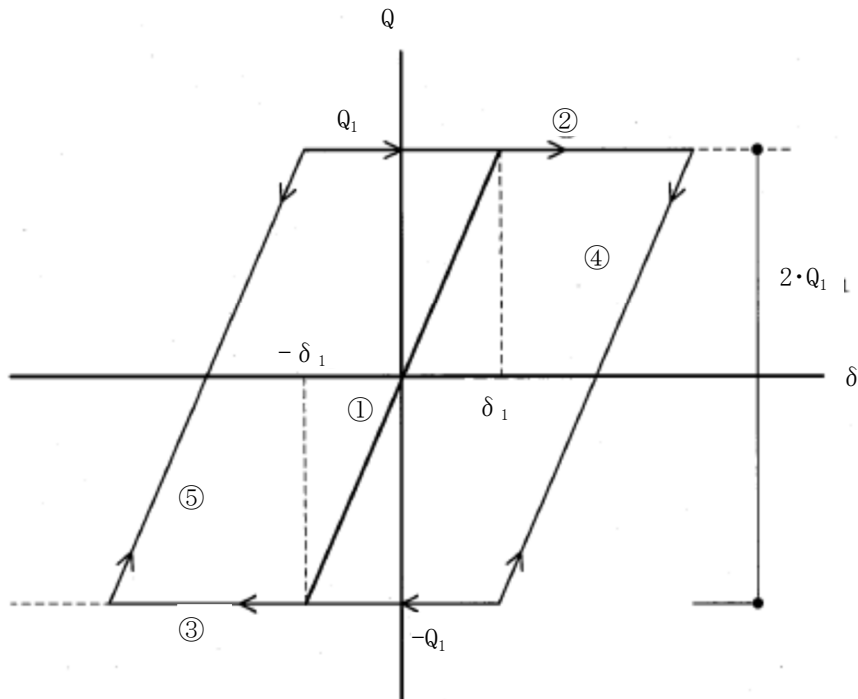

- ① : 第1剛性 (弾性剛性)
- ② : 正側第2剛性
- ③ : 負側第2剛性
- ④ : 正側第2剛性からの戻りの弾性剛性。 $2 \cdot Q_1$ 戻ると③に移る。
- ⑤ : 負側第2剛性からの戻りの弾性剛性。 $2 \cdot Q_1$ 戻ると②に移る。

第 3.5-2 図 応力-変形関係の履歴特性 (座屈拘束ブレース)

第3.5-1表 非線形ばね要素諸元

(a) NS断面

質点番号	質点位置 T. M. S. L. (m)	要素番号	要素位置 T. M. S. L. (m)	降伏変形量 δ_1 (m)	降伏せん断力 Q_1 (kN)
⑥	75.60	61	—	—	—
①	75.60	—	—	—	—
②	71.10	121	71.10~ 65.60	0.00754	408
③	65.60	131	65.60~ 60.60	0.00685	666
④	60.60	141	60.60~ 55.30	0.00726	738
⑤	55.30	—	—	—	—

(b) EW断面

質点番号	質点位置 T. M. S. L. (m)	要素番号	要素位置 T. M. S. L. (m)	降伏変形量 δ_1 (m)	降伏せん断力 Q_1 (kN)
⑥	75.60	61	—	—	—
①	75.60	—	—	—	—
②	71.10	121	71.10~ 65.60	0.00759	530
③	65.60	131	65.60~ 60.60	0.00700	854
④	60.60	141	60.60~ 55.30	0.00737	896
⑤	55.30	—	—	—	—

3.6 材料物性のばらつき

解析においては、「3.2 地震応答解析モデル」に示す物性値及び定数を基本ケースとし、材料物性のばらつきを考慮する。材料物性のばらつきを考慮した地震応答解析は、飛来物防護ネット架構の応答への影響が大きい地震動に対して実施することとし、基本ケースの地震応答解析において各応答値(屋根部の鉛直加速度、基礎梁の加速度(水平及び鉛直)、各層のせん断力、座屈拘束ブレースのひずみ、屋根部の曲げモーメント及び改良地盤の変位)が、最大となる地震動に対して実施する。

材料物性のばらつきのうち、地盤物性のばらつきについては、支持地盤及び埋戻し土ともに敷地内のボーリング調査結果等に基づき、「3.2.2 地盤」に示す地盤の物性値を基本とし、標準偏差 $\pm 1\sigma$ の変動幅を考慮する。なお、コンクリート強度のばらつきについては、コンクリート強度の実強度は設計基準強度よりも大きくなることから保守的に考慮しない。第3.6-1表～第3.6-8表に設定した地盤の物性値を示す。

材料物性のばらつきを考慮する解析ケースを、第3.6-9表及び第3.6-10表に示す。

第3.6-1表 埋戻し土の物性値(+1σ)

項目	記号	設定値	単位	
質量密度* ¹	ρ	1.82+0.0028D	g/cm ³	
間隙率	n	0.46	—	
基準拘束圧	σ'_{ma}	52.3	kN/m ²	
せん断弾性係数の依存係数	m_G	0.703	—	
基準拘束圧におけるせん断弾性係数	G_{ma}	1.83×10^5	kN/m ²	
体積弾性係数の依存係数	m_K	0.703	—	
基準拘束圧における体積弾性係数	K_{ma}	4.78×10^5	kN/m ²	
ポアソン比	ν	0.33	—	
粘着力	c_u'	0.00×10^0	kN/m ²	
内部摩擦角	Φ_u'	39.7	度	
履歴減衰上限値	h_{max}	0.171	—	
液状化物性* ²	変相角	Φ_p	34.0	度
	液状化パラメータ	w_l	10.30	—
		p^1	0.5	—
		p^2	1.0	—
		c_1	1.81	—
		S_1	0.005	—

注記 *1 : D : 深度(m)とし, 要素中心深度とする。

*2 : 液状化物性は, 有効応力解析時に使用する。

第3.6-2表 細粒砂岩1の物性値(+1 σ)

地震動	質量密度 (g/cm ³)	動ポアソン比	せん断弾性 係数 ($\times 10^4$ kN/m ²)	減衰定数	P波速度 V _p (m/s)	S波速度 V _s (m/s)
Ss-A	1.87	0.42	102	0.02	2000	738
Ss-B2	1.87	0.42	102	0.02	2000	739
Ss-B3	1.87	0.42	102	0.02	2000	737
Ss-B4	1.87	0.42	102	0.02	2000	737
Ss-B5	1.87	0.42	101	0.02	1990	734
Ss-C1	1.87	0.42	100	0.02	1980	733
Ss-C2	1.87	0.42	103	0.02	2010	741
Ss-C3	1.87	0.42	103	0.02	2010	741
Ss-C4	1.87	0.42	102	0.02	2000	739

第3.6-3表 細粒砂岩2の物性値(+1σ)

地震動	質量密度 (g/cm ³)	動ポアソン比	せん断弾性 係数 (×10 ⁴ kN/m ²)	減衰定数	P波速度 V _p (m/s)	S波速度 V _s (m/s)
S _s -A	1.85	0.35	179	0.02	2050	984
S _s -B2	1.85	0.35	180	0.02	2060	988
S _s -B3	1.85	0.35	180	0.02	2050	986
S _s -B4	1.85	0.35	179	0.02	2050	982
S _s -B5	1.85	0.35	178	0.02	2040	981
S _s -C1	1.85	0.35	177	0.02	2030	977
S _s -C2	1.85	0.35	180	0.02	2060	987
S _s -C3	1.85	0.35	181	0.02	2060	988
S _s -C4	1.85	0.35	180	0.02	2050	986

第3.6-4表 泥岩の物性値(+1 σ)

地震動	質量密度 (g/cm ³)	動ポアソン比	せん断弾性 係数 ($\times 10^4$ kN/m ²)	減衰定数	P波速度 V _p (m/s)	S波速度 V _s (m/s)
Ss-A	1.72	0.38	121	0.02	1910	839
Ss-B2	1.72	0.38	122	0.02	1920	840
Ss-B3	1.72	0.38	122	0.02	1920	840
Ss-B4	1.72	0.38	120	0.02	1910	837
Ss-B5	1.72	0.38	121	0.02	1910	838
Ss-C1	1.72	0.38	120	0.02	1900	834
Ss-C2	1.72	0.38	121	0.02	1920	840
Ss-C3	1.72	0.38	121	0.02	1910	839
Ss-C4	1.72	0.38	121	0.02	1910	839

第3.6-5表 埋戻し土の物性値(-1σ)

項目	記号	設定値	単位	
質量密度* ¹	ρ	1.82+0.0028D	g/cm ³	
間隙率	n	0.46	—	
基準拘束圧	σ'_{ma}	52.3	kN/m ²	
せん断弾性係数の依存係数	m_G	0.703	—	
基準拘束圧におけるせん断弾性係数	G_{ma}	8.62×10^4	kN/m ²	
体積弾性係数の依存係数	m_K	0.703	—	
基準拘束圧における体積弾性係数	K_{ma}	2.25×10^5	kN/m ²	
ポアソン比	ν	0.33	—	
粘着力	c_u'	0.00×10^0	kN/m ²	
内部摩擦角	$\Phi u'$	39.7	度	
履歴減衰上限値	h_{max}	0.171	—	
液状化物性* ²	変相角	Φ_p	34.0	度
	液状化パラメータ	w_l	10.30	—
		p^1	0.5	—
		p^2	1.0	—
		c_1	1.81	—
		S_1	0.005	—

注記 *1 : D : 深度(m)とし, 要素中心深度とする。

*2 : 液状化物性は, 有効応力解析時に使用する。

第3.6-6表 細粒砂岩1の物性値(-1σ)

地震動	質量密度 (g/cm ³)	動ポアソン比	せん断弾性 係数 (×10 ⁴ kN/m ²)	減衰定数	P波速度 V _p (m/s)	S波速度 V _s (m/s)
Ss-A	1.87	0.43	61.8	0.02	1680	575
Ss-B2	1.87	0.43	62.1	0.02	1690	576
Ss-B3	1.87	0.43	62.1	0.02	1690	576
Ss-B4	1.87	0.43	61.4	0.02	1680	573
Ss-B5	1.87	0.43	61.0	0.02	1670	571
Ss-C1	1.87	0.43	60.1	0.02	1660	567
Ss-C2	1.87	0.43	62.7	0.02	1700	579
Ss-C3	1.87	0.43	62.7	0.02	1700	579
Ss-C4	1.87	0.43	62.1	0.02	1690	576

第3.6-7表 細粒砂岩2の物性値(-1σ)

地震動	質量密度 (g/cm ³)	動ポアソン比	せん断弾性 係数 (×10 ⁴ kN/m ²)	減衰定数	P波速度 V _p (m/s)	S波速度 V _s (m/s)
S _s -A	1.85	0.38	131	0.02	1920	843
S _s -B2	1.85	0.38	133	0.02	1930	847
S _s -B3	1.85	0.38	133	0.02	1930	847
S _s -B4	1.85	0.38	131	0.02	1910	840
S _s -B5	1.85	0.38	131	0.02	1910	842
S _s -C1	1.85	0.38	129	0.02	1900	834
S _s -C2	1.85	0.38	133	0.02	1930	847
S _s -C3	1.85	0.38	132	0.02	1920	846
S _s -C4	1.85	0.38	132	0.02	1920	844

第3.6-8表 泥岩の物性値(-1σ)

地震動	質量密度 (g/cm ³)	動ポアソン比	せん断弾性 係数 (×10 ⁴ kN/m ²)	減衰定数	P波速度 Vp (m/s)	S波速度 Vs (m/s)
Ss-A	1.72	0.40	88.8	0.02	1790	719
Ss-B2	1.72	0.40	89.2	0.02	1790	720
Ss-B3	1.72	0.40	89.3	0.02	1800	721
Ss-B4	1.72	0.40	88.1	0.02	1780	716
Ss-B5	1.72	0.40	88.6	0.02	1790	718
Ss-C1	1.72	0.40	87.5	0.02	1780	713
Ss-C2	1.72	0.40	89.1	0.02	1790	720
Ss-C3	1.72	0.40	88.8	0.02	1790	719
Ss-C4	1.72	0.40	89.2	0.02	1790	720

第3.6-9表 材料物性のばらつきを考慮する解析ケース(全応力解析)

ケース No.	地盤の物性値	解析ケース	基準地震動 S _s	
			NS 方向	EW 方向
0	第3.2.2-1表 ～ 第3.2.2-5表	基本ケース	全波	
1	第3.2.2-2表, 第3.6-1表 ～ 第3.6-4表	地盤物性の ばらつきを考慮した ケース(+1σ)	S _s -A S _s -B3 S _s -B4 S _s -C1 S _s -C2(NS) S _s -C4(EW)	S _s -A S _s -B3 S _s -B5 S _s -C1 S _s -C2(NS)
2	第3.2.2-2表, 第3.6-5表 ～ 第3.6-8表	地盤物性の ばらつきを考慮した ケース(-1σ)	S _s -A S _s -B3 S _s -B4 S _s -C1 S _s -C2(NS) S _s -C4(EW)	S _s -A S _s -B3 S _s -B5 S _s -C1 S _s -C2(NS)

第3.6-10表 材料物性のばらつきを考慮する解析ケース(有効応力解析)

ケース No.	地盤の物性値	解析ケース	基準地震動 S _s	
			NS 方向	EW 方向
0	第3.2.2-1表 ～ 第3.2.2-5表	基本ケース	全波	
1	第3.2.2-2表, 第3.6-1表 ～ 第3.6-4表	地盤物性の ばらつきを考慮した ケース(+1σ)	S _s -A S _s -B3 S _s -C1 S _s -C2(EW)	S _s -A S _s -B2 S _s -B3 S _s -B5 S _s -C1 S _s -C2(EW)
2	第3.2.2-2表, 第3.6-5表 ～ 第3.6-8表	地盤物性の ばらつきを考慮した ケース(-1σ)	S _s -A S _s -B3 S _s -C1 S _s -C2(EW)	S _s -A S _s -B2 S _s -B3 S _s -B5 S _s -C1 S _s -C2(EW)

4. 解析結果

4.1 固有値解析結果

支持架構の固有値解析結果(固有周期, 固有振動数及び刺激係数)を第4.1-1表に示す。刺激関数図を第4.1-1図及び第4.1-2図に示す。

なお, 刺激係数は, 各次の固有ベクトル(u)に対し, 最大振幅が1.0となるように基準化した値を示す。

第4.1-1表 支持架構の固有値解析結果

NS 方向モデル				
次数	固有周期 (s)	固有振動数 (Hz)	刺激係数	備考
1	0.393	2.55	1.232	水平1次
2	0.248	4.03	1.035	鉛直1次
3	0.146	6.83	0.480	水平2次
4	0.081	12.36	0.383	水平3次
5	0.049	20.55	0.184	水平4次
6	0.042	23.84	1.199	鉛直2次
EW 方向モデル				
次数	固有周期 (s)	固有振動数 (Hz)	刺激係数	備考
1	0.395	2.53	1.239	水平1次
2	0.248	4.03	1.035	鉛直1次
3	0.151	6.63	0.519	水平2次
4	0.080	12.53	0.386	水平3次
5	0.048	20.89	0.178	水平4次
6	0.042	23.84	1.199	鉛直2次

1次モード

固有周期：0.393 (s)

振動数：2.55 (Hz)

刺激係数：1.232

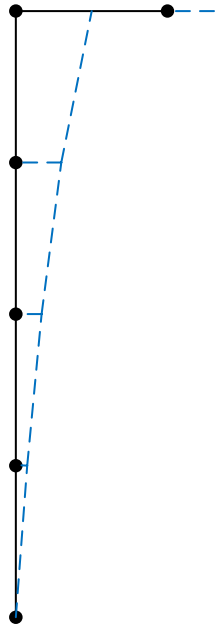

2次モード

固有周期：0.248 (s)

振動数：4.03 (Hz)

刺激係数：1.035

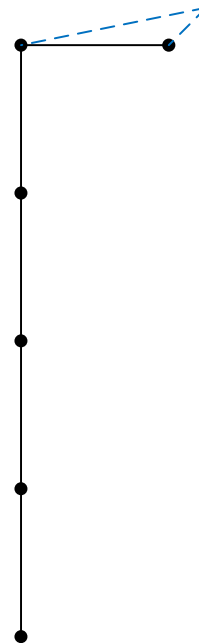

3次モード

固有周期：0.146 (s)

振動数：6.83 (Hz)

刺激係数：0.480

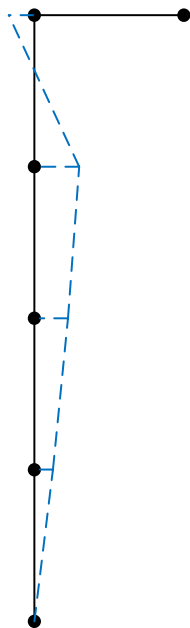

4次モード

固有周期：0.081 (s)

振動数：12.36 (Hz)

刺激係数：0.383

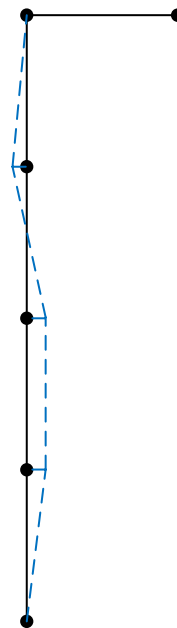

第4. 1-1図 刺激関数図 (NS方向モデル) (1/2)

5 次モード

固有周期 : 0.049 (s)

振動数 : 20.55 (Hz)

刺激係数 : 0.184

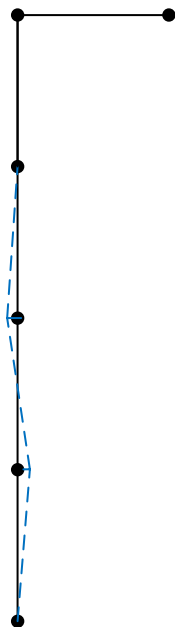

6 次モード

固有周期 : 0.042 (s)

振動数 : 23.84 (Hz)

刺激係数 : 1.199

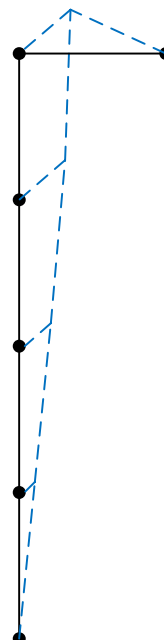

第4. 1-1図 刺激関数図 (NS方向モデル) (2/2)

1次モード

固有周期：0.395 (s)

振動数：2.53 (Hz)

刺激係数：1.239

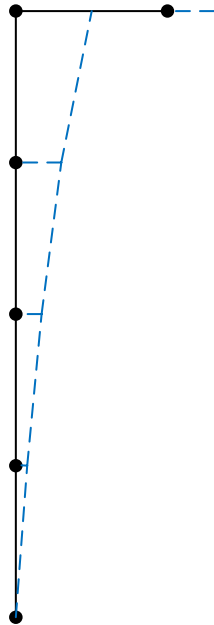

2次モード

固有周期：0.248 (s)

振動数：4.03 (Hz)

刺激係数：1.035

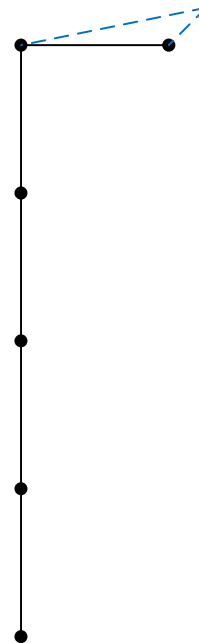

3次モード

固有周期：0.151 (s)

振動数：6.63 (Hz)

刺激係数：0.519

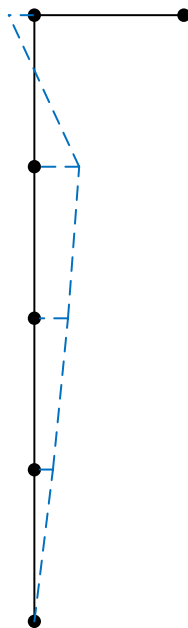

4次モード

固有周期：0.080 (s)

振動数：12.53 (Hz)

刺激係数：0.386

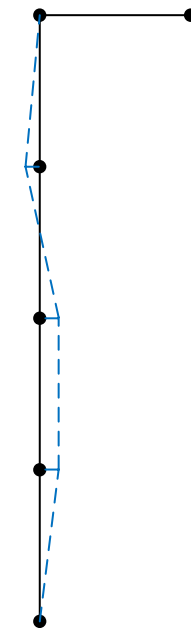

第4. 1-2図 刺激関数図 (EW方向モデル) (1/2)

5 次モード

固有周期 : 0.048 (s)

振動数 : 20.89 (Hz)

刺激係数 : 0.178

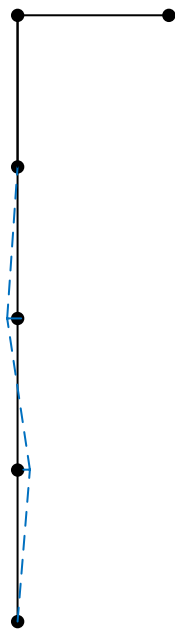

6 次モード

固有周期 : 0.042 (s)

振動数 : 23.84 (Hz)

刺激係数 : 1.199

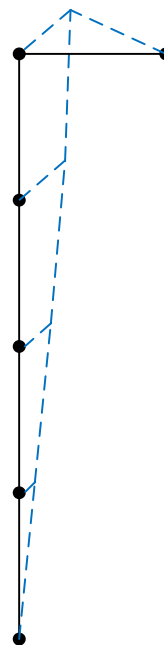

第4. 1-2図 刺激関数図 (EW方向モデル) (2/2)

4.2 地震応答解析結果

4.2.1 全応力解析

全応力解析結果のうち、飛来物防護ネット架構の最大応答値(加速度,せん断力,曲げモーメント)を第4.2.1-1図～第4.2.1-24図に,座屈拘束ブレースの荷重-ひずみ曲線図を第4.2.1-25図～第4.2.1-30図に,改良地盤の最大応答変位*を第4.2.1-31図～第4.2.1-36図に示す。

注記 * : 応答変位は,改良地盤下端(T.M.S.L. 37.00m)からの相対変位とし,各レベルでの節点変位の平均値として算定する。最大応答変位は,応答変位の時刻歴における最大値を示す。

最大応答加速度 (NS方向)

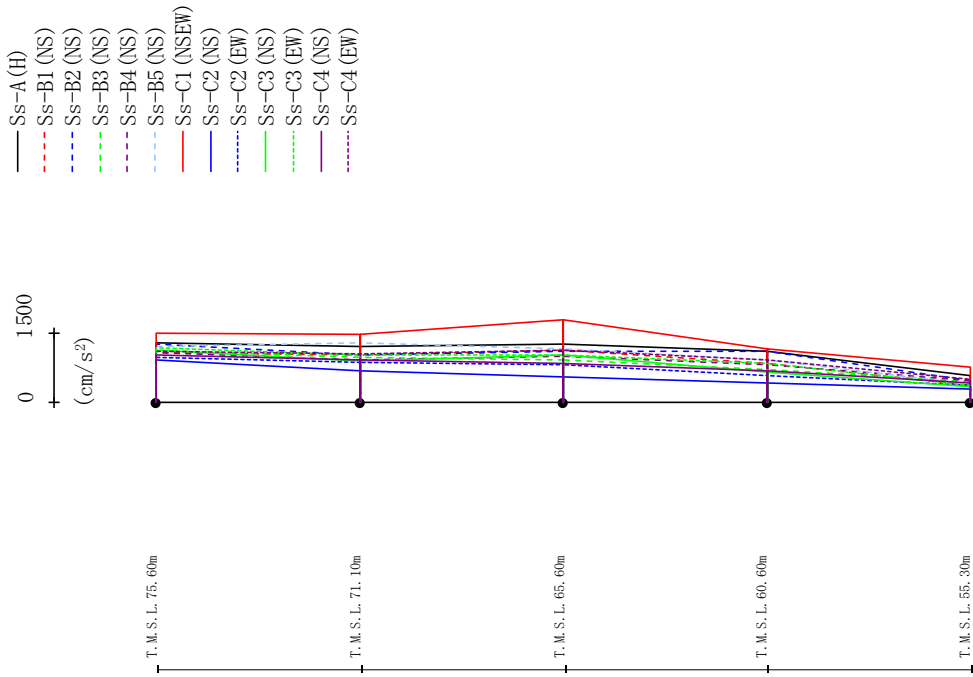

	Ss-A (H)	Ss-B1 (NS)	Ss-B2 (NS)	Ss-B3 (NS)	Ss-B4 (NS)	Ss-B5 (NS)	Ss-C1 (NSEW)	Ss-C2 (NS)	Ss-C2 (EW)	Ss-C3 (NS)	Ss-C3 (EW)	Ss-C4 (NS)	Ss-C4 (EW)
T.M.S.L. 75.60m	1281	1084	1274	1121	1074	1219	1498	921	974	1137	1193	1031	1108
T.M.S.L. 71.10m	1203	1037	1032	979	932	1279	1467	691	869	885	1013	911	1048
T.M.S.L. 65.60m	1258	1134	1095	923	1004	1161	1786	545	827	1015	1023	840	1119
T.M.S.L. 60.60m	1101	850	1096	715	824	930	1160	414	564	662	839	684	920
T.M.S.L. 55.30m	574	362	469	443	477	403	754	296	366	335	358	419	487

第4.2.1-1図 最大応答加速度 (基本ケース, NS方向, 全応力解析)

最大応答せん断力 (NS方向)

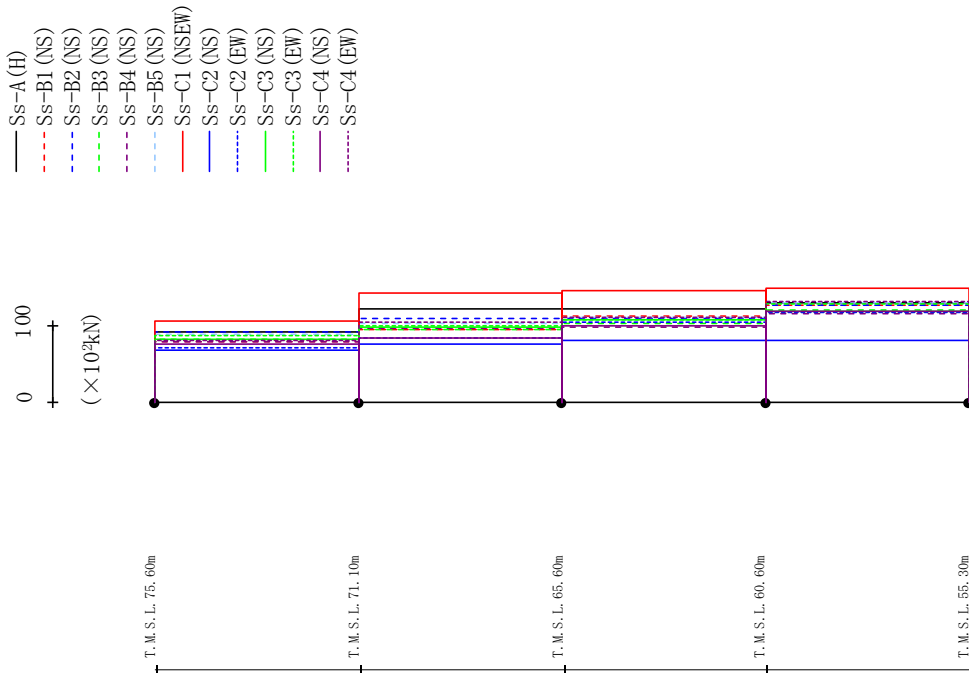

(× 10²kN)

Ss-A (H)	Ss-B1 (NS)	Ss-B2 (NS)	Ss-B3 (NS)	Ss-B4 (NS)	Ss-B5 (NS)	Ss-C1 (NSEW)	Ss-C2 (NS)	Ss-C2 (EW)	Ss-C3 (NS)	Ss-C3 (EW)	Ss-C4 (NS)	Ss-C4 (EW)
91.65	79.60	91.59	82.91	78.75	88.39	106.02	67.17	71.18	82.37	86.50	75.18	80.25
121.79	95.13	109.43	94.64	95.96	102.21	141.83	75.90	83.51	98.23	100.02	83.90	103.84
121.74	112.59	109.82	103.48	98.27	110.81	144.93	80.30	103.74	108.07	108.06	99.23	111.40
130.00	126.96	127.05	119.93	116.21	129.65	148.65	80.23	117.36	118.94	128.84	118.13	130.56

第4.2.1-2図 最大応答せん断力 (基本ケース, NS方向, 全応力解析)

最大応答曲げモーメント (NS方向)

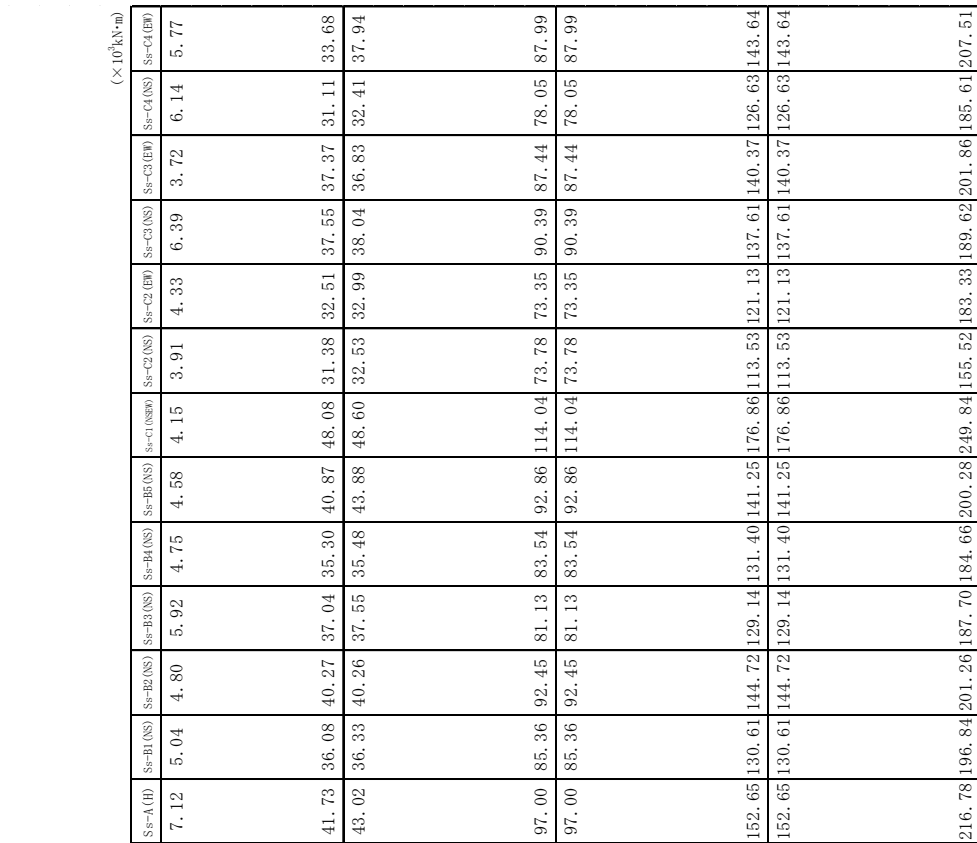

第4.2.1-3図 最大応答曲げモーメント (基本ケース, NS方向, 全応力解析)

最大応答加速度 (UD方向)

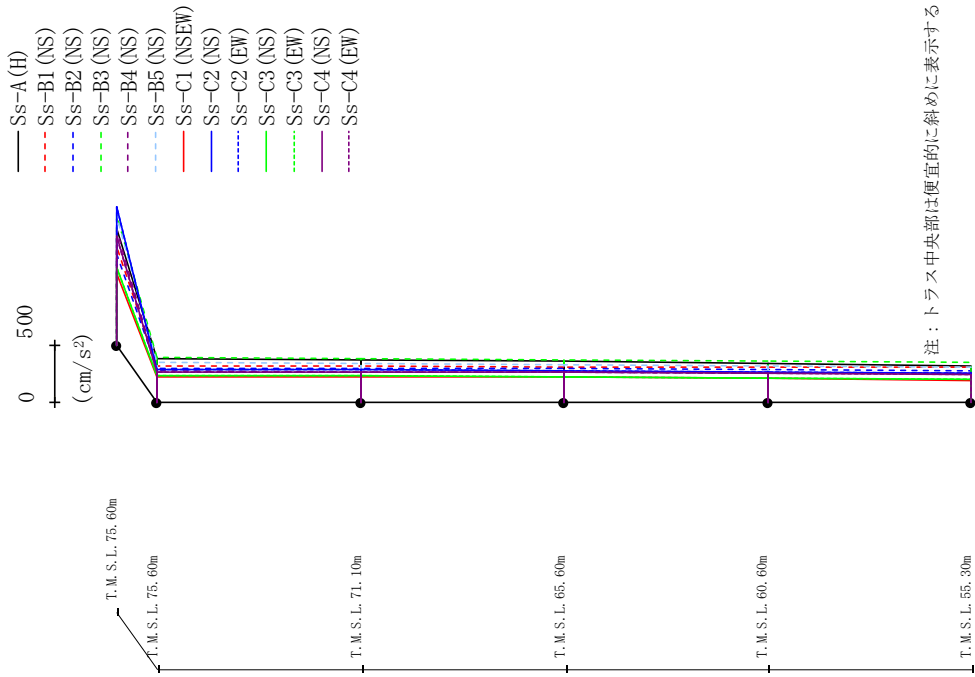

注：トラス中央部は便宜的に斜めに表示する

	Ss-A(H)	Ss-B1(NS)	Ss-B2(NS)	Ss-B3(NS)	Ss-B4(NS)	Ss-B5(NS)	Ss-C1(NSEW)	Ss-C2(NS)	Ss-C2(EW)	Ss-C3(NS)	Ss-C3(EW)	Ss-C4(NS)	Ss-C4(EW)
1006	847	784	1129	998	1119	619	1203	1198	675	674	945	940	
381	317	294	387	268	346	224	284	285	236	235	259	260	
372	311	292	381	264	340	222	280	281	231	231	259	261	
357	306	289	371	259	330	215	272	273	223	223	257	259	
338	304	284	361	253	319	206	261	262	211	211	253	254	
315	301	277	349	253	305	193	256	256	197	197	245	246	

第4.2.1-4図 最大応答鉛直加速度 (基本ケース, NS方向, 全応力解析)

最大応答加速度 (EW方向)

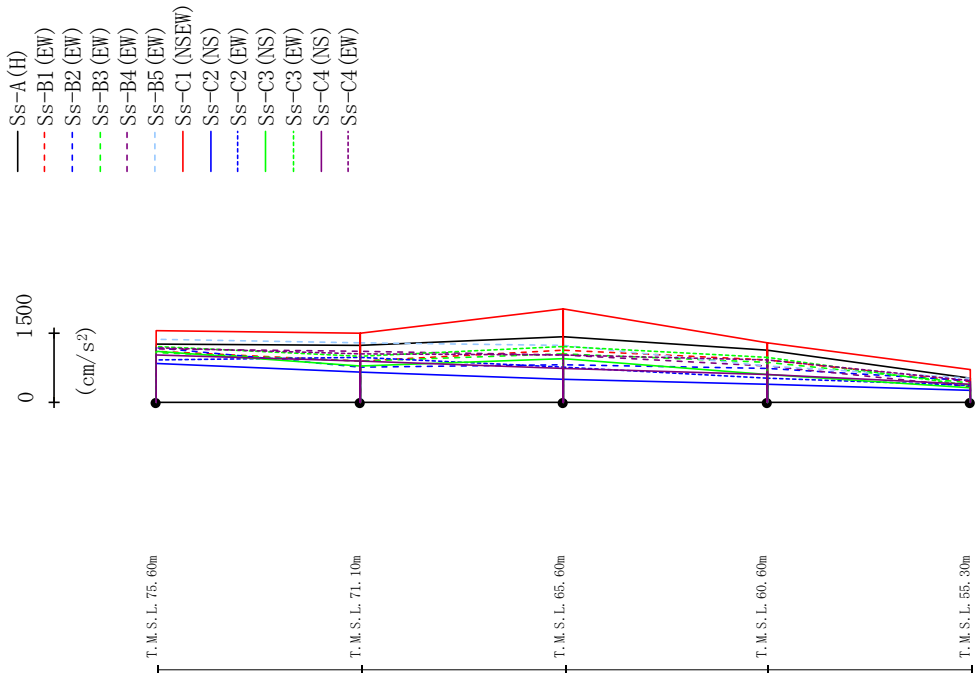

	Ss-A (H)	Ss-B1 (EW)	Ss-B2 (EW)	Ss-B3 (EW)	Ss-B4 (EW)	Ss-B5 (EW)	Ss-C1 (NSEW)	Ss-C2 (NS)	Ss-C2 (EW)	Ss-C3 (NS)	Ss-C3 (EW)	Ss-C4 (NS)	Ss-C4 (EW)
1275	1105	1186	1086	1152	1368	1554	849	931	1101	1220	1015	1177	
1233	883	772	893	1101	1283	1500	662	973	780	992	886	1059	
1416	1130	825	1054	1015	1235	2034	490	774	934	1219	745	1035	
1126	908	736	858	795	795	1284	395	536	614	963	598	918	
534	451	465	427	327	512	719	248	355	320	368	400	468	

第4.2.1-5図 最大応答加速度 (基本ケース, EW方向, 全応力解析)

最大応答せん断力 (EW方向)

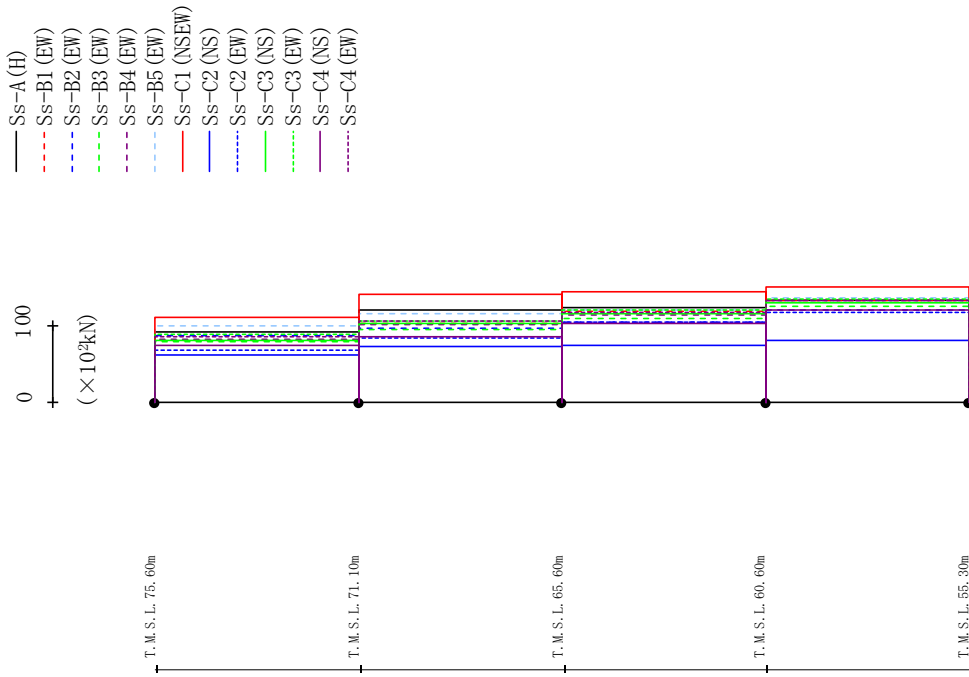

(× 10²kN)

Ss-A (H)	Ss-B1 (EW)	Ss-B2 (EW)	Ss-B3 (EW)	Ss-B4 (EW)	Ss-B5 (EW)	Ss-C1 (NSEW)	Ss-C2 (NS)	Ss-C2 (EW)	Ss-C3 (NS)	Ss-C3 (EW)	Ss-C4 (NS)	Ss-C4 (EW)
91.69	80.95	86.69	79.02	82.42	99.47	110.01	61.71	67.60	79.88	88.30	74.30	85.13
119.47	102.49	95.82	94.67	101.79	115.50	141.32	72.92	84.40	102.70	106.40	84.71	105.75
123.66	118.53	104.54	108.70	113.98	119.63	143.25	74.50	104.23	115.53	119.59	102.00	116.45
132.98	132.55	119.78	124.42	132.40	136.67	150.43	79.97	116.35	130.50	133.77	119.79	132.89

第4.2.1-6図 最大応答せん断力 (基本ケース, EW方向, 全応力解析)

最大応答曲げモーメント (EW方向)

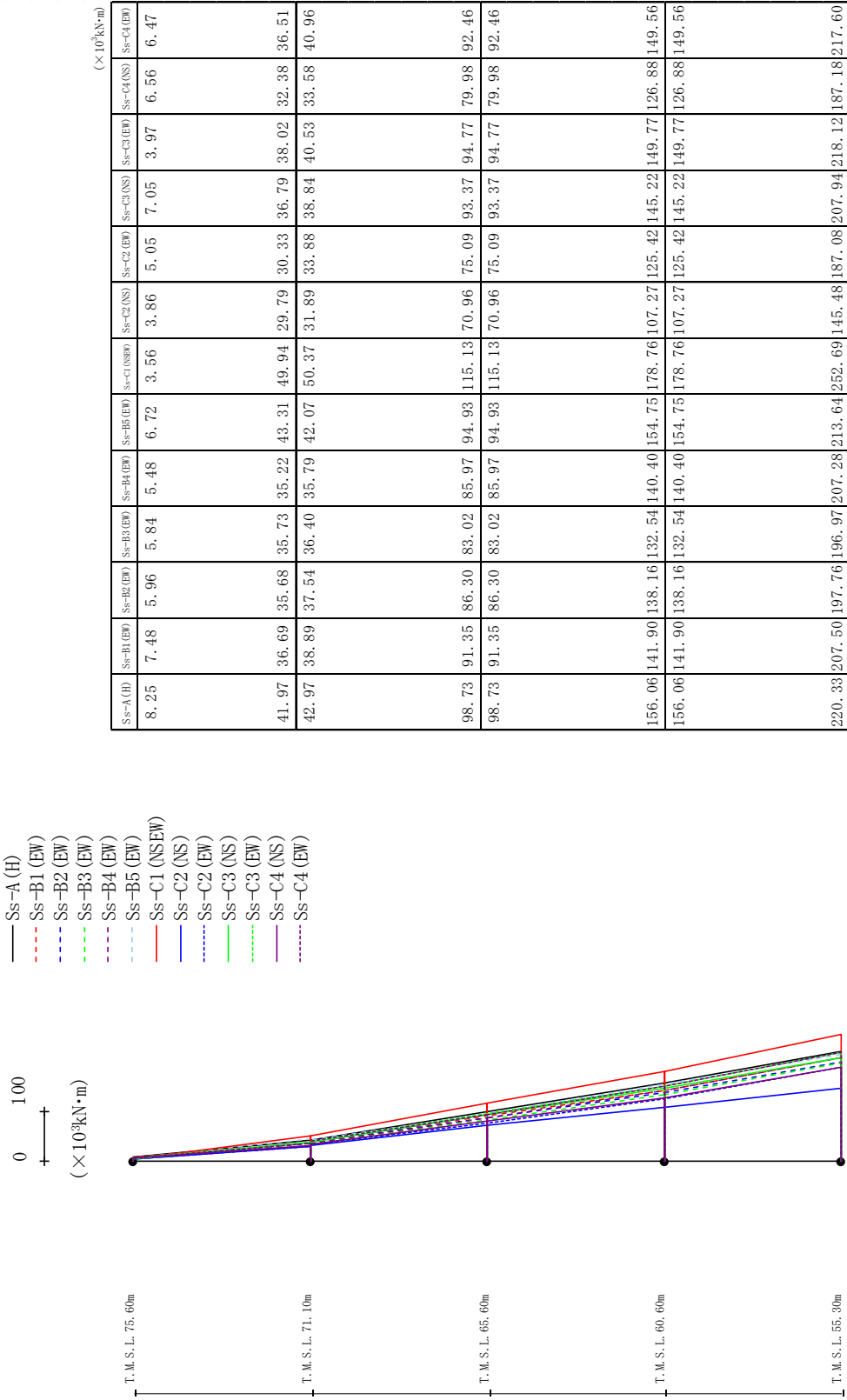

第4.2.1-7図 最大応答曲げモーメント (基本ケース, EW方向, 全応力解析)

最大応答加速度 (UD方向)

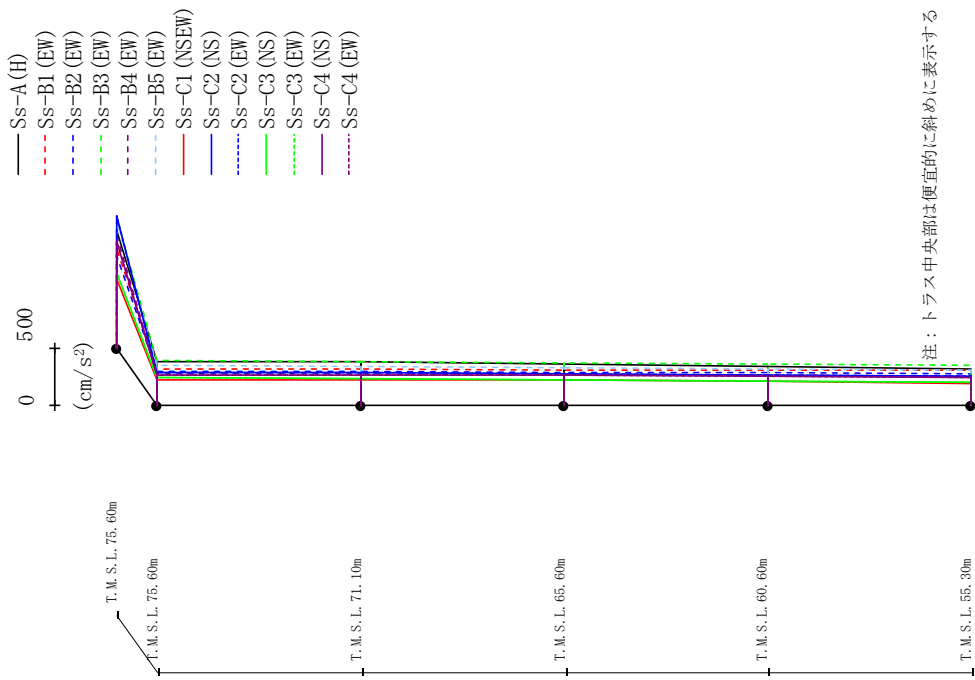

	Ss-A (H)	Ss-B1 (EW)	Ss-B2 (EW)	Ss-B3 (EW)	Ss-B4 (EW)	Ss-B5 (EW)	Ss-C1 (NSEW)	Ss-C2 (NS)	Ss-C2 (EW)	Ss-C3 (NS)	Ss-C3 (EW)	Ss-C4 (NS)	Ss-C4 (EW)
1018	861	803	1125	982	1101	595	1150	1142	647	648	929	922	
384	318	293	388	273	345	224	282	282	236	236	259	259	
375	312	292	381	269	340	221	278	279	232	232	259	260	
360	306	288	372	264	330	215	270	271	224	224	257	258	
341	304	283	361	258	319	206	261	262	212	212	253	253	
318	301	275	349	252	306	193	256	256	198	198	245	245	

第4.2.1-8図 最大応答鉛直加速度 (基本ケース, EW方向, 全応答解析)

最大芯管加速度 (NS方向)

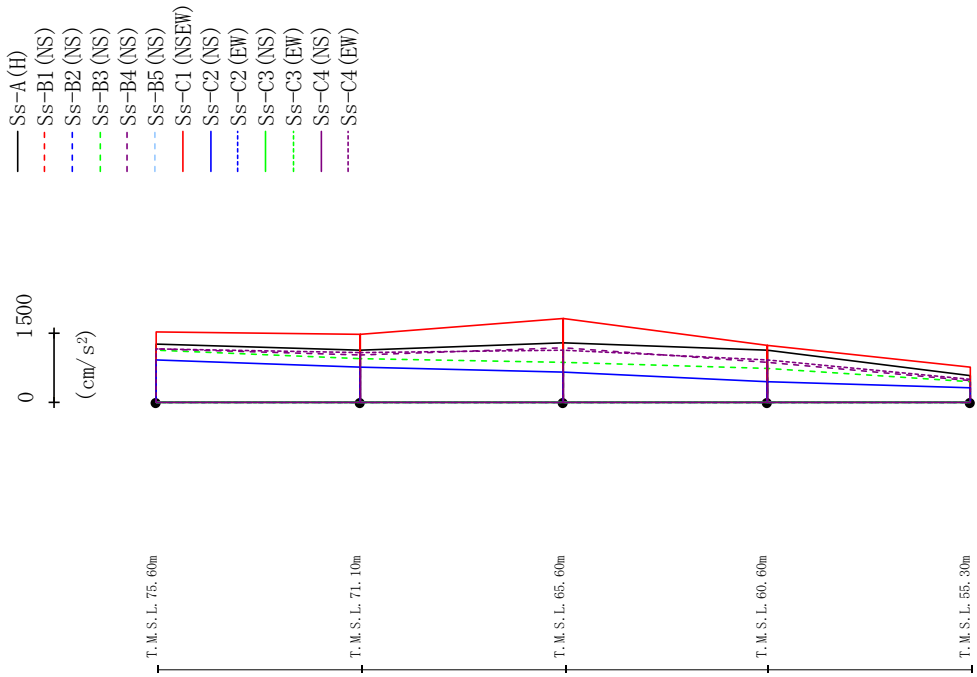

Ss-A (H)	Ss-B1 (NS)	Ss-B2 (NS)	Ss-B3 (NS)	Ss-B4 (NS)	Ss-B5 (NS)	Ss-C1 (NSEW)	Ss-C2 (NS)	Ss-C2 (EW)	Ss-C3 (NS)	Ss-C3 (EW)	Ss-C4 (NS)	Ss-C4 (EW)
1256	-	-	1142	1155	-	1527	915	-	-	-	-	1157
1133	-	-	956	1023	-	1484	772	-	-	-	-	1067
1284	-	-	866	1179	-	1812	643	-	-	-	-	1126
1125	-	-	722	866	-	1242	457	-	-	-	-	909
571	-	-	452	480	-	762	311	-	-	-	-	502

第4.2.1-9图 最大芯管加速度 (+1σ 地盤, NS方向, 全応力解析)

最大応答せん断力 (NS方向)

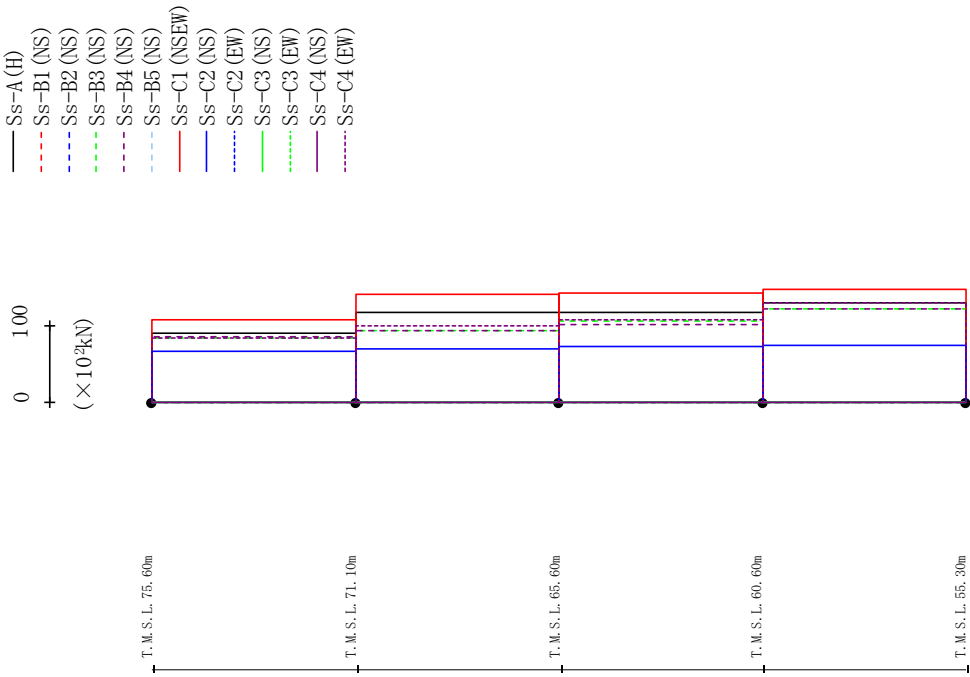

(× 10²kN)

Ss-A (H)	Ss-B1 (NS)	Ss-B2 (NS)	Ss-B3 (NS)	Ss-B4 (NS)	Ss-B5 (NS)	Ss-C1 (NSEW)	Ss-C2 (NS)	Ss-C2 (EW)	Ss-C3 (NS)	Ss-C3 (EW)	Ss-C4 (NS)	Ss-C4 (EW)
89.57	-	-	84.17	84.72	-	107.96	66.76	-	-	-	-	84.22
117.23	-	-	93.85	93.55	-	140.85	69.74	-	-	-	-	99.49
117.71	-	-	105.64	101.81	-	142.61	72.53	-	-	-	-	108.12
130.20	-	-	122.40	122.31	-	146.89	73.97	-	-	-	-	130.33

第4.2.1-10図 最大応答せん断力 (+1σ地震, NS方向, 全応力解析)

最大応答曲げモーメント (NS方向)

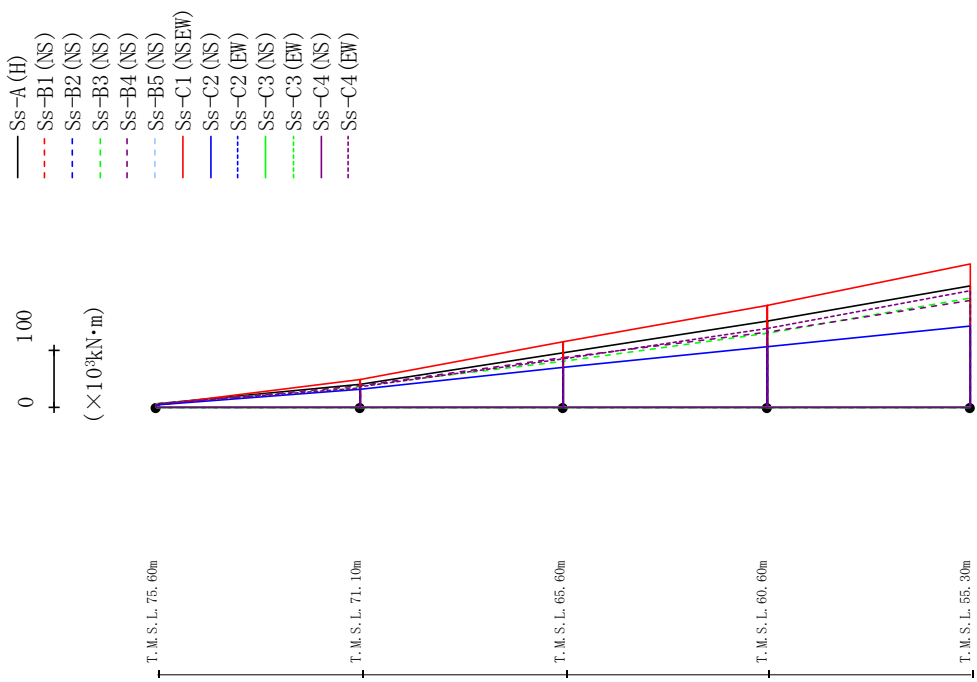

(×10³kN·m)

Ss-A (H)	Ss-B1 (NS)	Ss-B2 (NS)	Ss-B3 (NS)	Ss-B4 (NS)	Ss-B5 (NS)	Ss-C1 (N/EW)	Ss-C2 (NS)	Ss-C2 (EW)	Ss-C3 (NS)	Ss-C3 (EW)	Ss-C4 (NS)	Ss-C4 (EW)
6.96	-	6.00	4.68	-	4.10	4.11	-	-	-	-	-	5.39
40.53	-	36.43	37.59	-	47.98	31.00	-	-	-	-	-	34.44
40.86	-	37.17	37.42	-	47.37	32.39	-	-	-	-	-	36.69
94.61	-	79.73	85.61	-	113.94	70.25	-	-	-	-	-	84.44
94.61	-	79.73	85.61	-	113.94	70.25	-	-	-	-	-	84.44
149.31	-	129.27	131.43	-	176.68	104.55	-	-	-	-	-	137.82
149.31	-	129.27	131.43	-	176.68	104.55	-	-	-	-	-	137.82
210.19	-	189.73	185.35	-	249.44	141.45	-	-	-	-	-	203.18

第4.2.1-11図 最大応答曲げモーメント (+1σ地盤, NS方向, 全応力解析)

最大応答加速度 (UD方向)

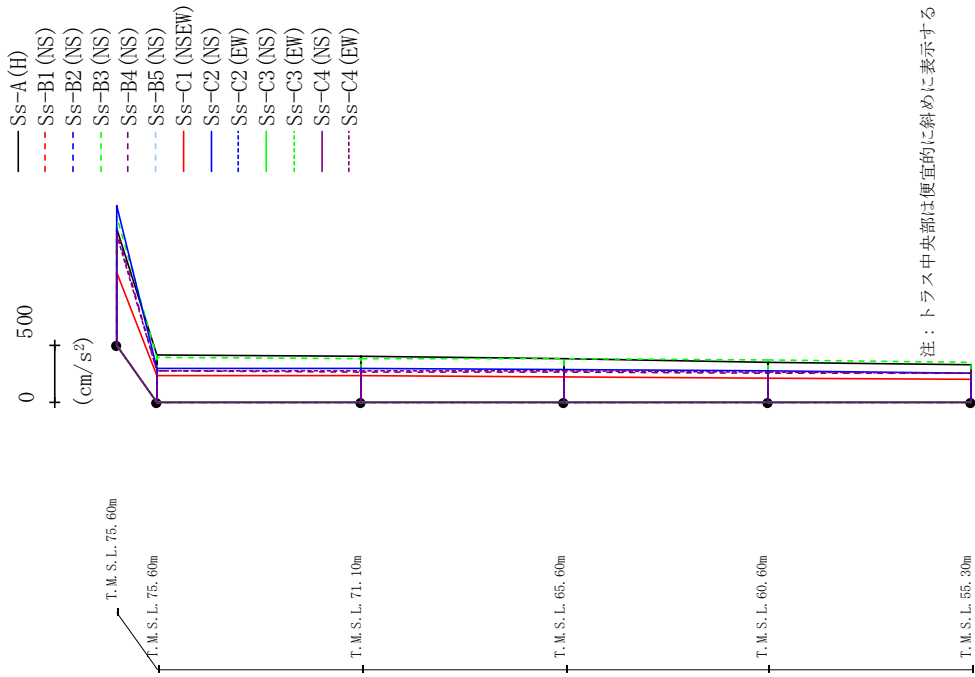

	Ss-A(H)	Ss-B1(NS)	Ss-B2(NS)	Ss-B3(NS)	Ss-B4(NS)	Ss-B5(NS)	Ss-C1(NSEW)	Ss-C2(NS)	Ss-C2(EW)	Ss-C3(NS)	Ss-C3(EW)	Ss-C4(NS)	Ss-C4(EW)
1005	-	1115	1004	-	627	-	1212	-	-	-	-	-	955
407	-	390	268	-	234	-	297	-	-	-	-	-	271
396	-	384	263	-	231	-	292	-	-	-	-	-	271
375	-	374	259	-	224	-	282	-	-	-	-	-	269
350	-	364	254	-	213	-	269	-	-	-	-	-	265
322	-	352	252	-	197	-	256	-	-	-	-	-	257

第4.2.1-12図 最大応答鉛直加速度 (+1σ地盤, NS方向, 全応答解析)

最大芯管加速度 (EW方向)

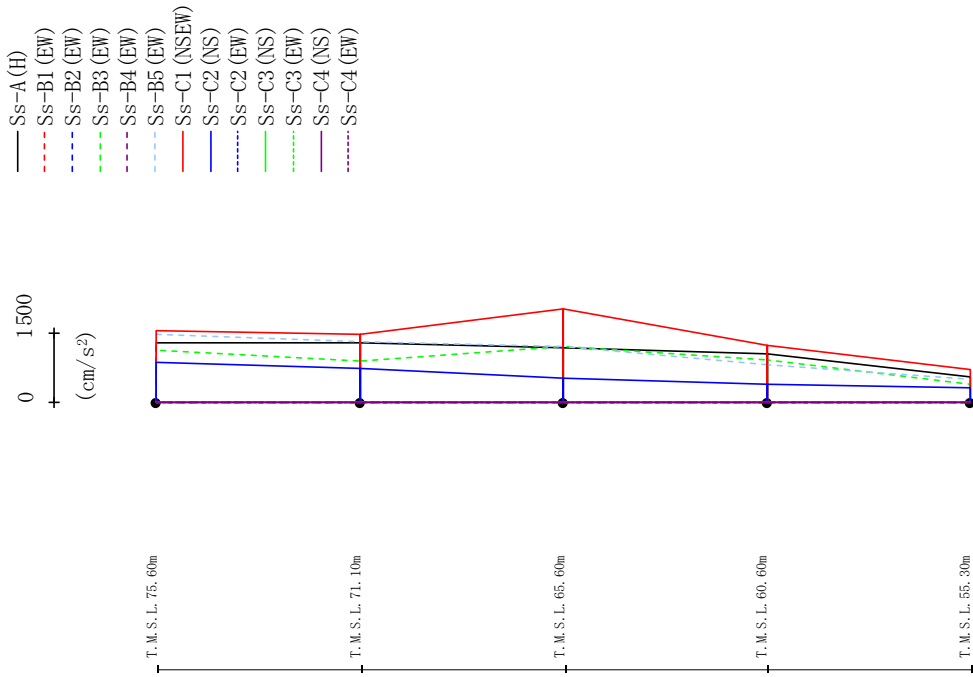

Ss-A (H)	Ss-B1 (EW)	Ss-B2 (EW)	Ss-B3 (EW)	Ss-B4 (EW)	Ss-B5 (EW)	Ss-C1 (NSEW)	Ss-C2 (NS)	Ss-C2 (EW)	Ss-C3 (NS)	Ss-C3 (EW)	Ss-C4 (NS)	Ss-C4 (EW)
1285	-	-	1129	-	1473	1549	869	-	-	-	-	-
1285	-	-	891	-	1313	1463	741	-	-	-	-	-
1195	-	-	1199	-	1204	2040	517	-	-	-	-	-
1048	-	-	917	-	824	1242	387	-	-	-	-	-
555	-	-	391	-	495	712	300	-	-	-	-	-

第4.2.1-13图 最大芯管加速度 (+1σ 地震, EW方向, 全芯力解析)

最大応答せん断力 (EW方向)

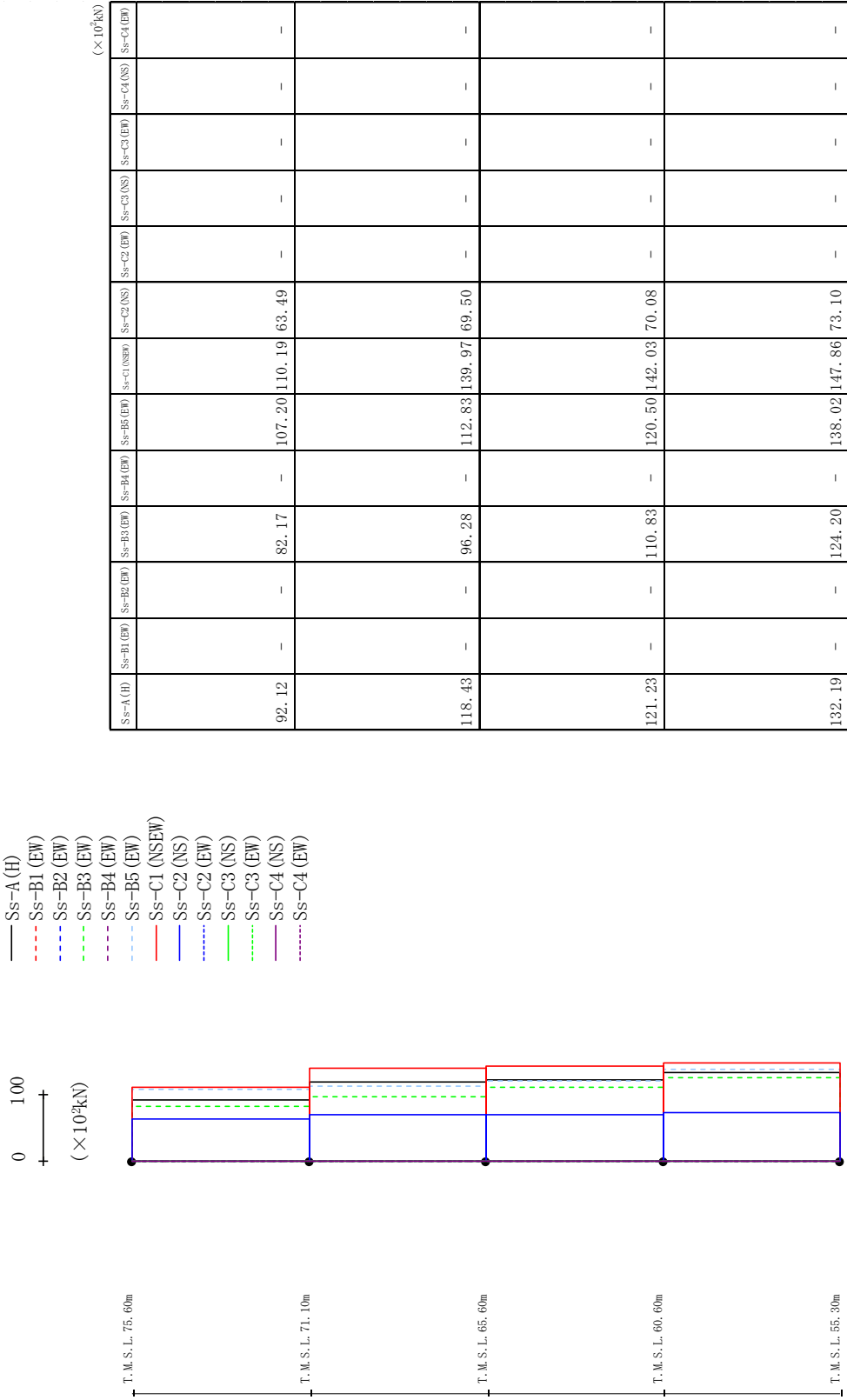

第4.2.1-14図 最大応答せん断力 (+1σ地震, EW方向, 全応力解析)

最大応答曲げモーメント (EW方向)

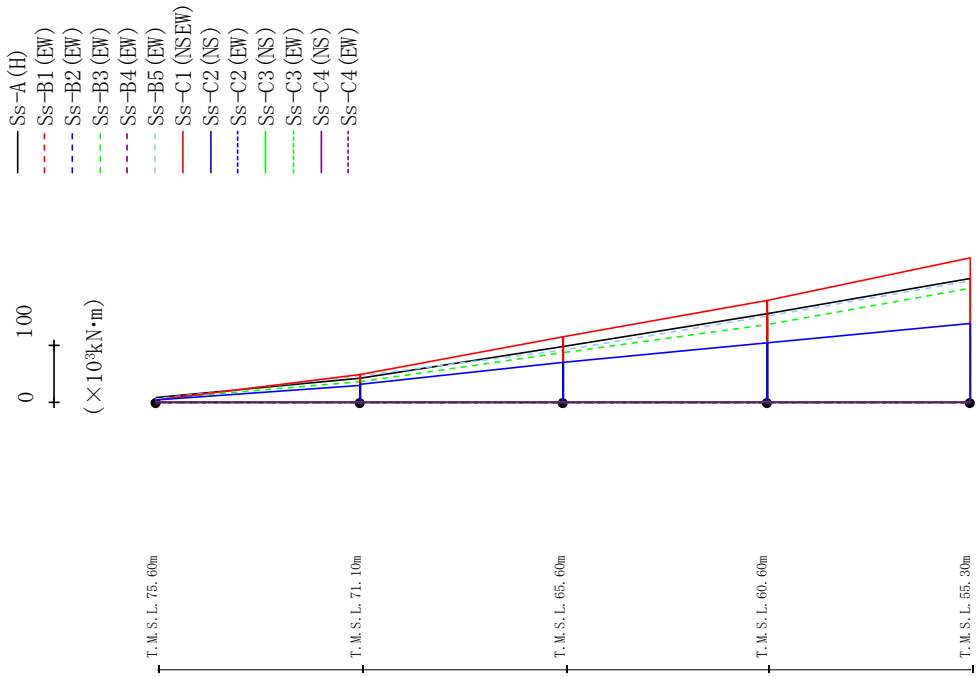

Ss-A (H)	Ss-B1 (EW)	Ss-B2 (EW)	Ss-B3 (EW)	Ss-B4 (EW)	Ss-B5 (EW)	Ss-C1 (NSEW)	Ss-C2 (NS)	Ss-C2 (EW)	Ss-C3 (NS)	Ss-C3 (EW)	Ss-C4 (NS)	Ss-C4 (EW)
8.48	-	5.83	-	5.79	4.14	3.85	-	-	-	-	-	-
41.04	-	35.78	-	47.17	48.90	30.32	-	-	-	-	-	-
42.31	-	34.97	-	46.09	48.91	32.07	-	-	-	-	-	-
97.54	-	85.64	-	91.52	114.30	68.74	-	-	-	-	-	-
97.54	-	85.64	-	91.52	114.30	68.74	-	-	-	-	-	-
154.00	-	134.92	-	150.86	177.97	102.96	-	-	-	-	-	-
154.00	-	134.92	-	150.86	177.97	102.96	-	-	-	-	-	-
216.05	-	199.40	-	210.55	252.25	138.10	-	-	-	-	-	-

第4.2.1-15図 最大応答曲げモーメント (+1σ地盤, EW方向, 全応力解析)

最大応答加速度 (UD方向)

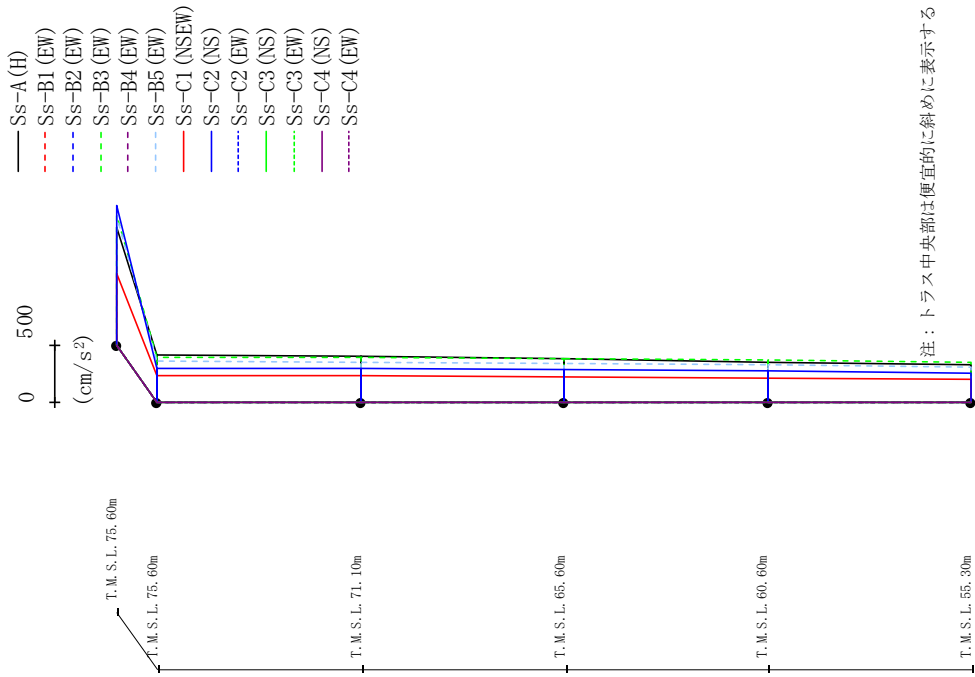

Ss-A (H)	Ss-B1 (EW)	Ss-B2 (EW)	Ss-B3 (EW)	Ss-B4 (EW)	Ss-B5 (EW)	Ss-C1 (NSEW)	Ss-C2 (NS)	Ss-C3 (NS)	Ss-C4 (NS)	Ss-C1 (NSEW)	Ss-C2 (NS)	Ss-C3 (NS)	Ss-C4 (NS)	Ss-C1 (NSEW)	Ss-C2 (NS)	Ss-C3 (NS)	Ss-C4 (NS)
1018	-	-	1131	-	1120	621	1207	-	-	-	-	-	-	-	-	-	-
408	-	-	392	-	355	234	297	-	-	-	-	-	-	-	-	-	-
397	-	-	385	-	348	230	292	-	-	-	-	-	-	-	-	-	-
377	-	-	375	-	337	223	282	-	-	-	-	-	-	-	-	-	-
352	-	-	365	-	324	212	269	-	-	-	-	-	-	-	-	-	-
322	-	-	352	-	308	197	256	-	-	-	-	-	-	-	-	-	-

第4.2.1-16図 最大応答鉛直加速度 (+1σ地盤, EW方向, 全応答解析)

最大芯管加速度 (NS方向)

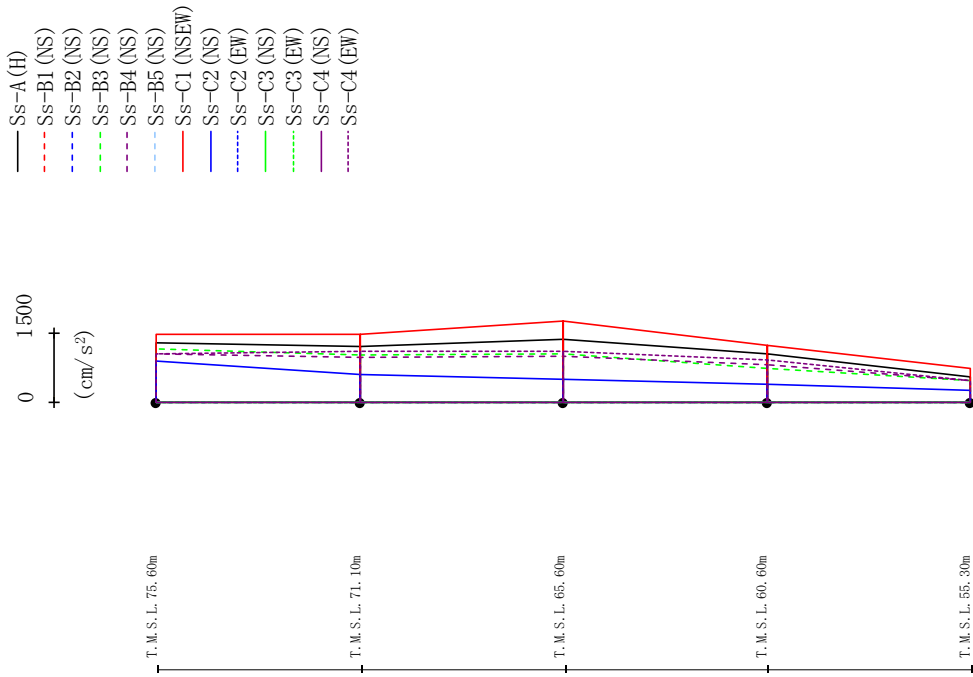

Ss-A (H)	Ss-B1 (NS)	Ss-B2 (NS)	Ss-B3 (NS)	Ss-B4 (NS)	Ss-B5 (NS)	Ss-C1 (NSEW)	Ss-C2 (NS)	Ss-C2 (EW)	Ss-C3 (NS)	Ss-C3 (EW)	Ss-C4 (NS)	Ss-C4 (EW)
1299	-	-	1159	1040	-	1488	893	-	-	-	-	1042
1209	-	-	1023	968	-	1486	591	-	-	-	-	1118
1377	-	-	1061	1002	-	1778	487	-	-	-	-	1118
1049	-	-	744	802	-	1247	391	-	-	-	-	911
549	-	-	461	477	-	744	247	-	-	-	-	468

第4.2.1-17图 最大芯管加速度 (-1σ 地震, NS方向, 全芯力解析)

最大応答せん断力 (NS方向)

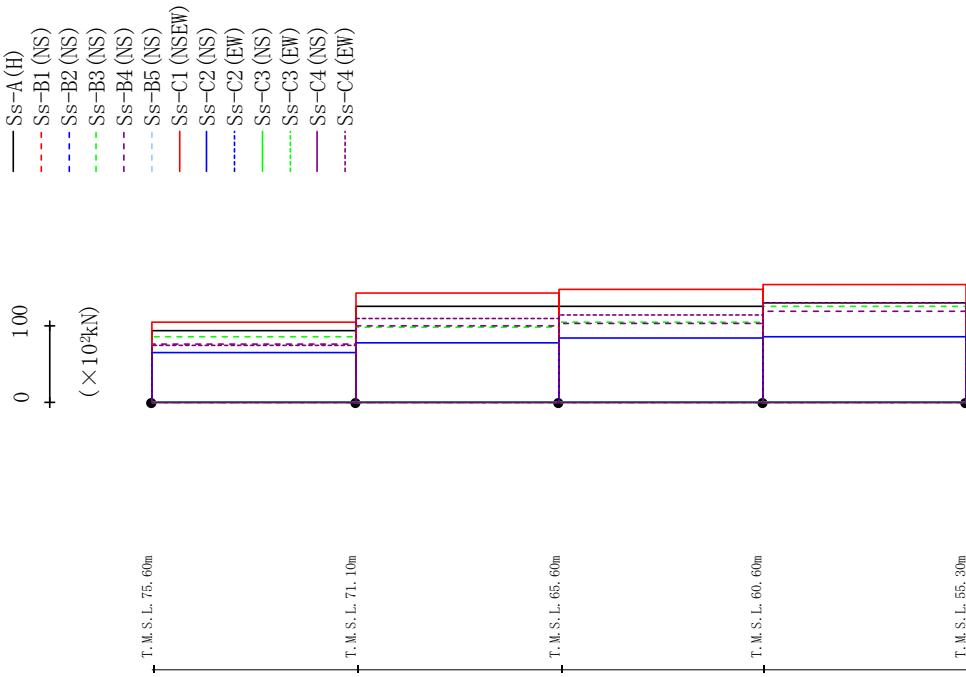

第4.2.1-18図 最大応答せん断力 (-1σ地震, NS方向, 全応力解析)

最大応答曲げモーメント (NS方向)

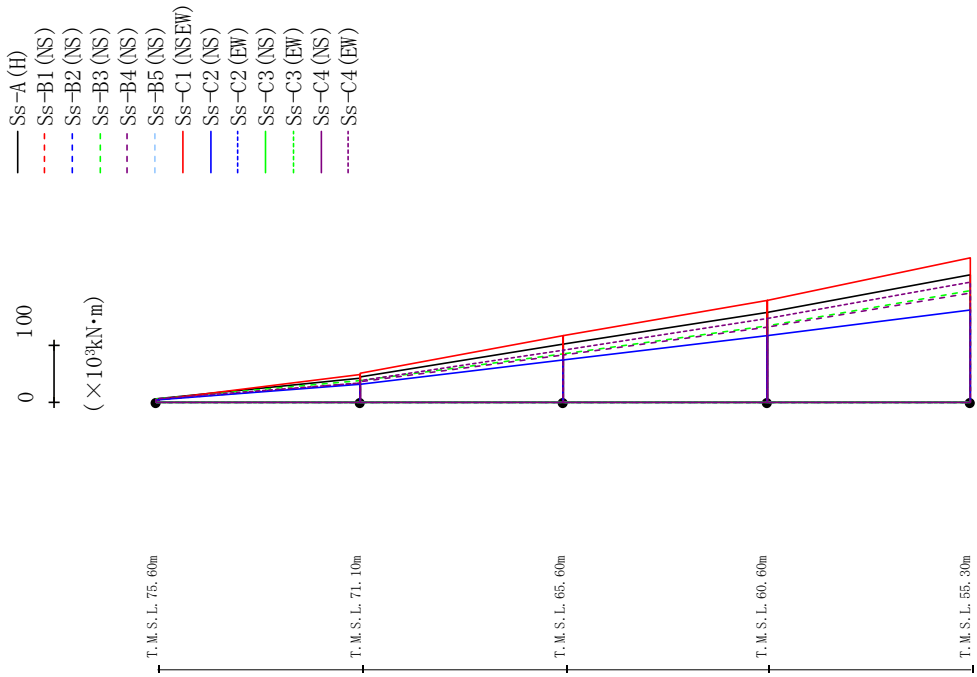

(×10³kN·m)

Ss-A (H)	Ss-B1 (NS)	Ss-B2 (NS)	Ss-B3 (NS)	Ss-B4 (NS)	Ss-B5 (NS)	Ss-C1 (NSEE)	Ss-C2 (NS)	Ss-C2 (EW)	Ss-C3 (NS)	Ss-C3 (EW)	Ss-C4 (NS)	Ss-C4 (EW)
7.01	-	5.43	4.53	-	3.41	3.44	-	-	-	-	-	5.46
42.92	-	37.98	33.95	-	48.58	30.66	-	-	-	-	-	34.17
44.65	-	38.42	36.25	-	49.85	32.06	-	-	-	-	-	38.79
100.37	-	85.09	82.51	-	115.14	73.63	-	-	-	-	-	90.02
100.37	-	85.09	82.51	-	115.14	73.63	-	-	-	-	-	90.02
155.21	-	133.68	131.10	-	177.92	115.51	-	-	-	-	-	146.36
155.21	-	133.68	131.10	-	177.92	115.51	-	-	-	-	-	146.36
221.12	-	194.75	190.26	-	251.49	160.45	-	-	-	-	-	210.10

第4.2.1-19図 最大応答曲げモーメント (-1σ地盤, NS方向, 全応力解析)

最大応答加速度 (UD方向)

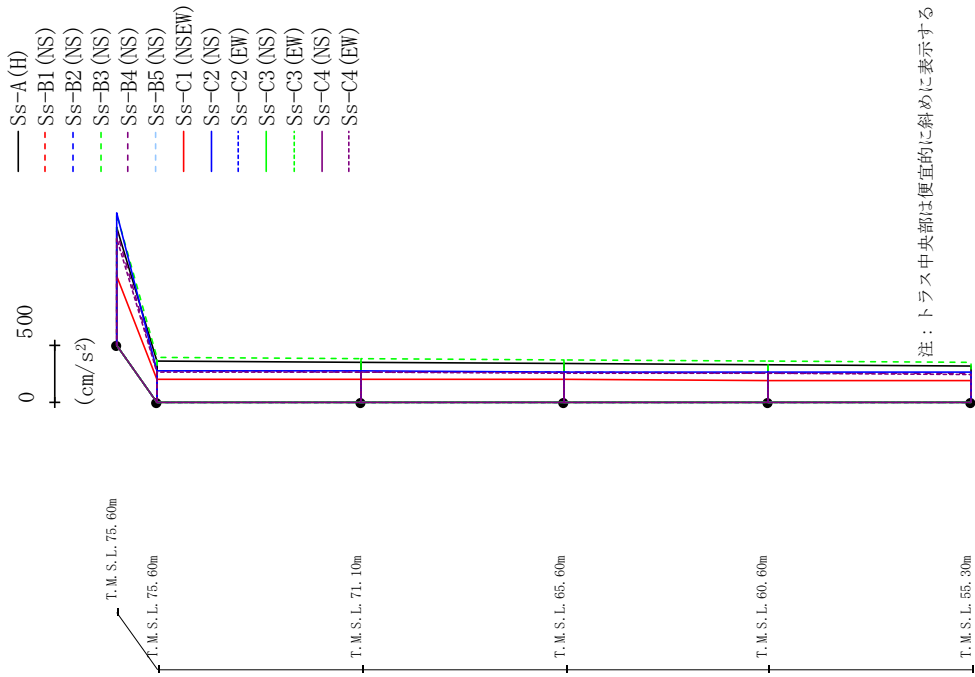

注：トラス中央部は便宜的に斜めに表示する

	Ss-A(H)	Ss-B1(NS)	Ss-B2(NS)	Ss-B3(NS)	Ss-B4(NS)	Ss-B5(NS)	Ss-C1(NSEW)	Ss-C2(NS)	Ss-C2(EW)	Ss-C3(NS)	Ss-C3(EW)	Ss-C4(NS)	Ss-C4(EW)
1023	-	1131	986	-	601	-	1152	-	-	-	-	-	920
359	-	385	270	-	204	-	275	-	-	-	-	-	257
352	-	379	267	-	202	-	271	-	-	-	-	-	258
341	-	371	261	-	199	-	267	-	-	-	-	-	255
327	-	361	256	-	192	-	262	-	-	-	-	-	251
311	-	351	254	-	183	-	257	-	-	-	-	-	243

第4.2.1-20図 最大応答鉛直加速度 (-1σ地盤, NS方向, 全応答解析)

最大芯管加速度 (EW方向)

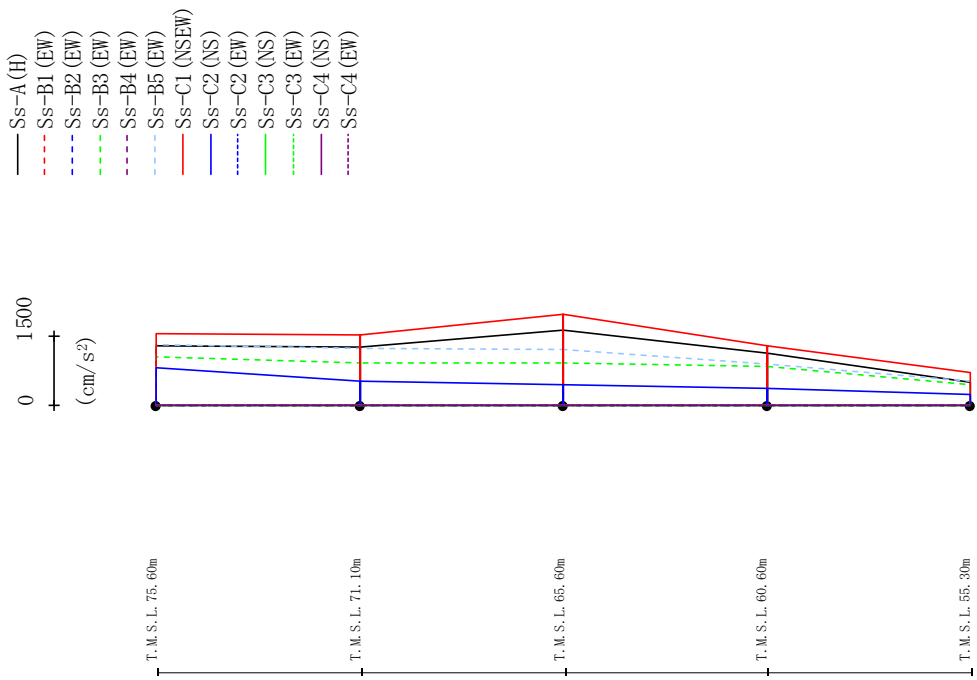

Ss-A (H)	Ss-B1 (EW)	Ss-B2 (EW)	Ss-B3 (EW)	Ss-B4 (EW)	Ss-B5 (EW)	Ss-C1 (NSEW)	Ss-C2 (NS)	Ss-C2 (EW)	Ss-C3 (NS)	Ss-C3 (EW)	Ss-C4 (NS)	Ss-C4 (EW)
1302	-	-	1059	-	1316	1558	809	-	-	-	-	-
1271	-	-	926	-	1246	1530	530	-	-	-	-	-
1622	-	-	914	-	1222	1976	451	-	-	-	-	-
1125	-	-	833	-	890	1296	376	-	-	-	-	-
511	-	-	442	-	535	710	239	-	-	-	-	-

第4.2.1-21图 最大芯管加速度 (-1σ 地震, EW方向, 全芯力解析)

最大応答せん断力 (EW方向)

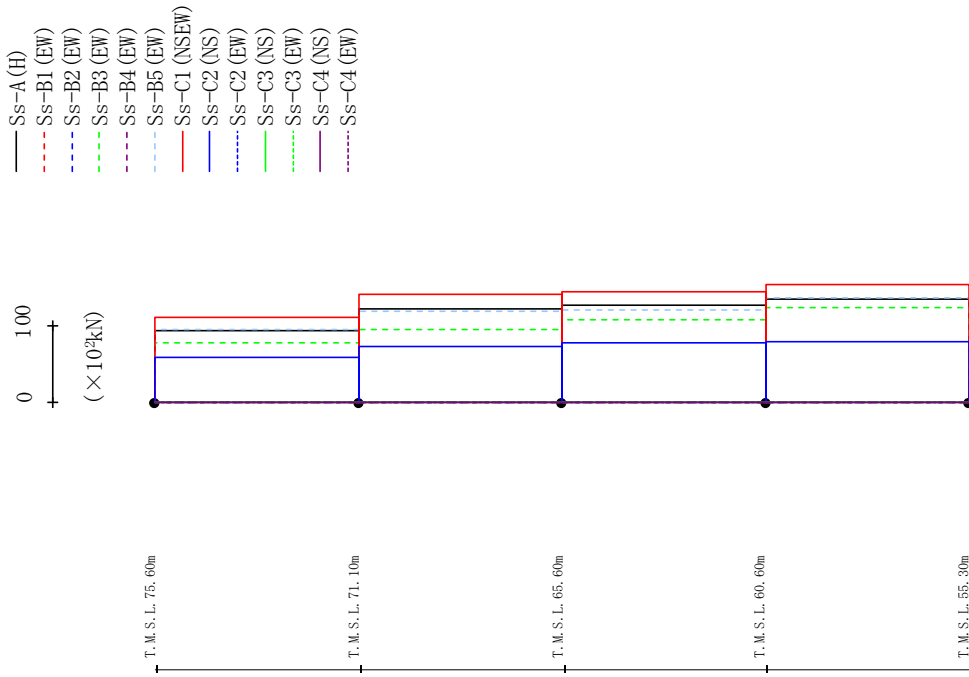

(× 10⁴kN)

Ss-A (H)	Ss-B1 (EW)	Ss-B2 (EW)	Ss-B3 (EW)	Ss-B4 (EW)	Ss-B5 (EW)	Ss-C1 (NSEW)	Ss-C2 (NS)	Ss-C2 (EW)	Ss-C3 (NS)	Ss-C3 (EW)	Ss-C4 (NS)	Ss-C4 (EW)
93.35	-	-	76.97	-	94.65	110.30	58.83	-	-	-	-	-
122.13	-	-	95.25	-	117.91	141.41	72.91	-	-	-	-	-
126.23	-	-	107.74	-	120.40	144.51	77.15	-	-	-	-	-
134.20	-	-	122.93	-	135.54	152.97	79.06	-	-	-	-	-

第4.2.1-22図 最大応答せん断力 (-1σ地震, EW方向, 全応力解析)

最大応答曲げモーメント (EW方向)

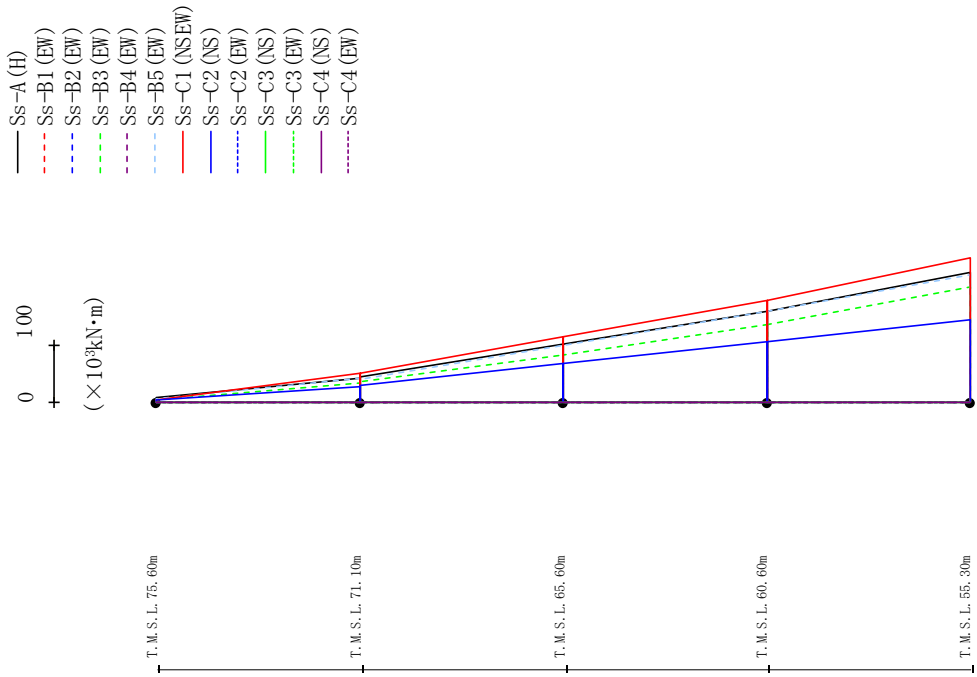

Ss-A (H)		Ss-B1 (EW)	Ss-B2 (EW)	Ss-B3 (EW)	Ss-B4 (EW)	Ss-B5 (EW)	Ss-C1 (N/EW)	Ss-C2 (NS)	Ss-C2 (EW)	Ss-C3 (NS)	Ss-C3 (EW)	Ss-C4 (NS)	Ss-C4 (EW)
7.46	-	-	5.07	-	-	6.75	4.08	4.01	-	-	-	-	-
42.76	-	-	34.55	-	-	41.63	50.41	27.52	-	-	-	-	-
43.59	-	-	35.78	-	-	40.66	51.18	28.62	-	-	-	-	-
100.48	-	-	82.93	-	-	98.13	114.26	68.25	-	-	-	-	-
100.48	-	-	82.93	-	-	98.13	114.26	68.25	-	-	-	-	-
158.26	-	-	135.05	-	-	158.33	177.38	104.88	-	-	-	-	-
158.26	-	-	135.05	-	-	158.33	177.38	104.88	-	-	-	-	-
225.28	-	-	199.89	-	-	222.32	250.85	143.48	-	-	-	-	-

第4.2.1-23図 最大応答曲げモーメント (-1σ地盤, EW方向, 全応力解析)

最大応答加速度 (UD方向)

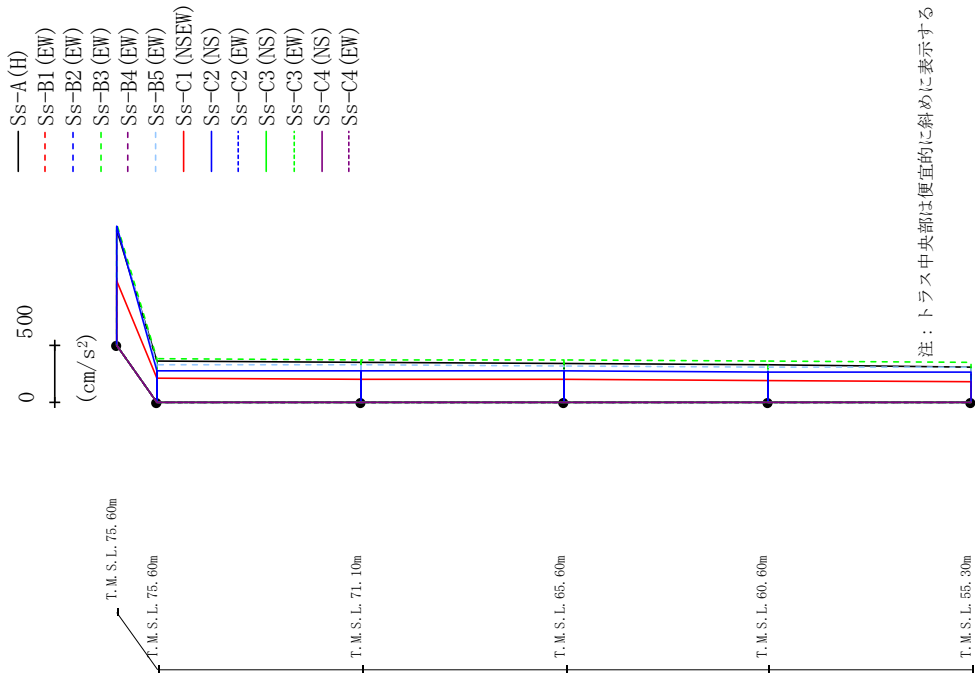

	Ss-A (H)	Ss-B1 (EW)	Ss-B2 (EW)	Ss-B3 (EW)	Ss-B4 (EW)	Ss-B5 (EW)	Ss-B4 (EW)	Ss-B5 (EW)	Ss-C1 (NSEW)	Ss-C2 (NS)	Ss-C2 (EW)	Ss-C3 (NS)	Ss-C3 (EW)	Ss-C4 (NS)	Ss-C4 (EW)	(cm/s ²)
998	-	-	1053	-	-	1030	-	557	1027	-	-	-	-	-	-	-
360	-	-	379	-	-	327	-	205	276	-	-	-	-	-	-	-
351	-	-	373	-	-	323	-	204	273	-	-	-	-	-	-	-
339	-	-	365	-	-	316	-	199	269	-	-	-	-	-	-	-
326	-	-	357	-	-	309	-	193	266	-	-	-	-	-	-	-
310	-	-	347	-	-	302	-	183	262	-	-	-	-	-	-	-

第4.2.1-24図 最大応答鉛直加速度 (-1σ地盤, EW方向, 全応答解析)

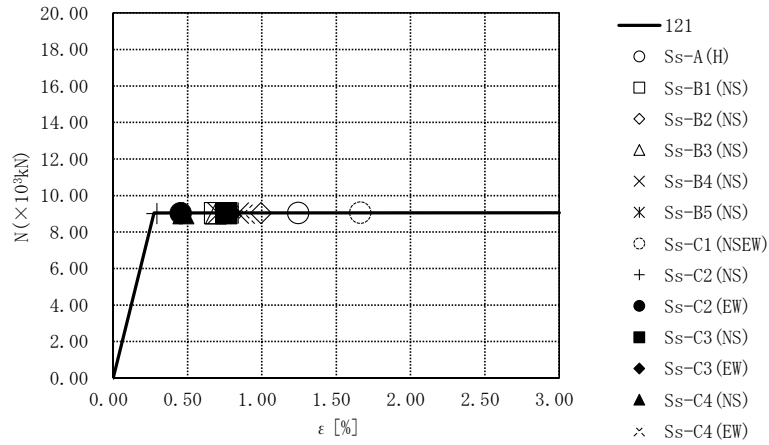

要素番号121

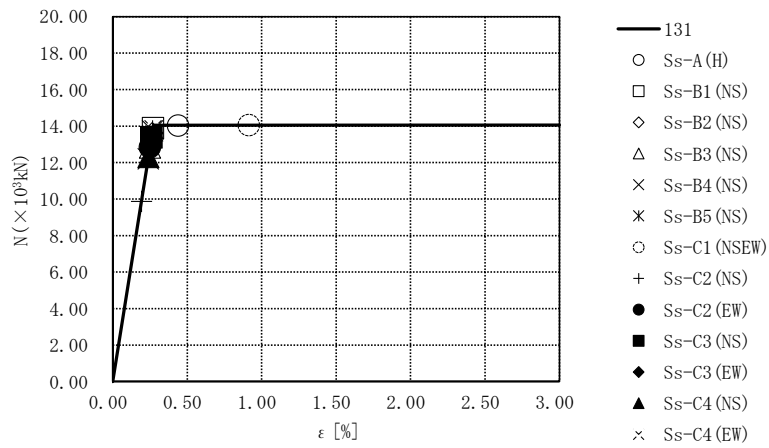

要素番号131

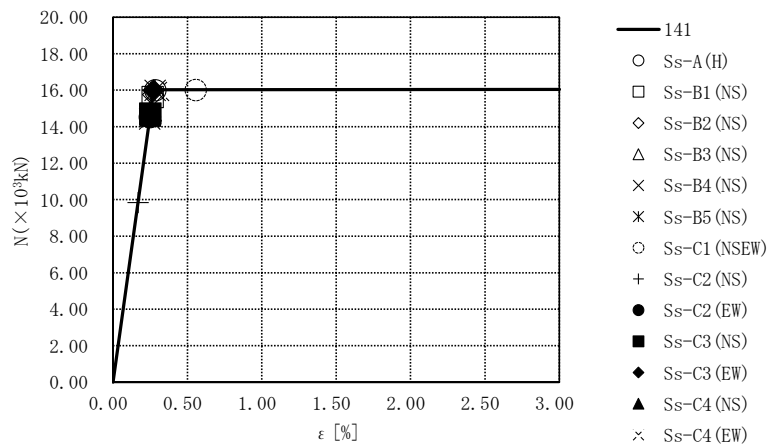

要素番号141

第4.2.1-25図 座屈拘束ブレースの荷重-ひずみ曲線
(基本ケース, NS方向, 全応力解析)

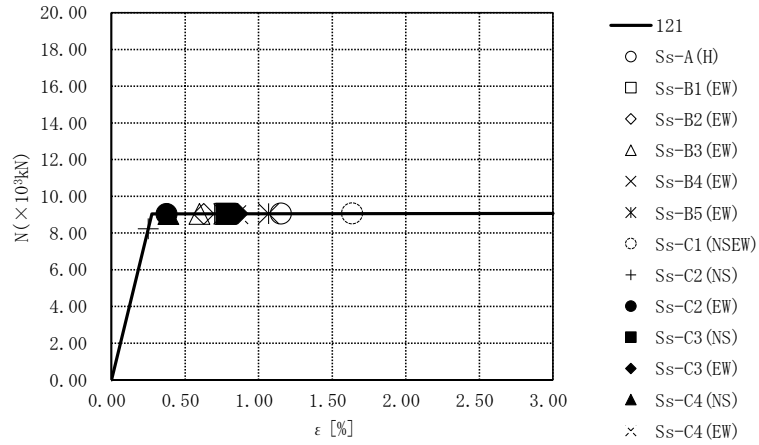

要素番号121

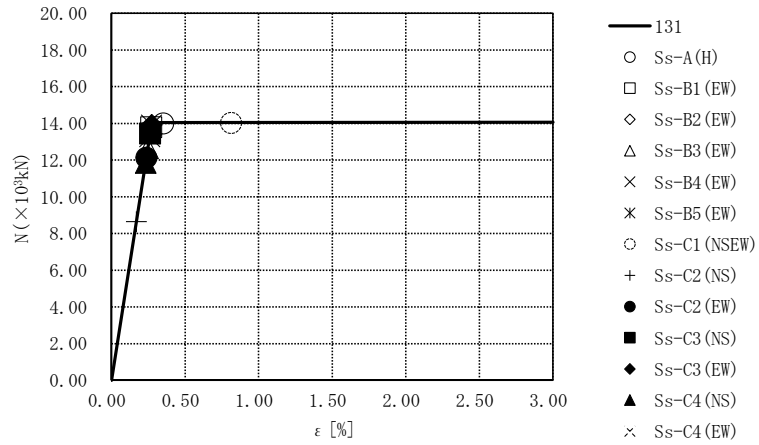

要素番号131

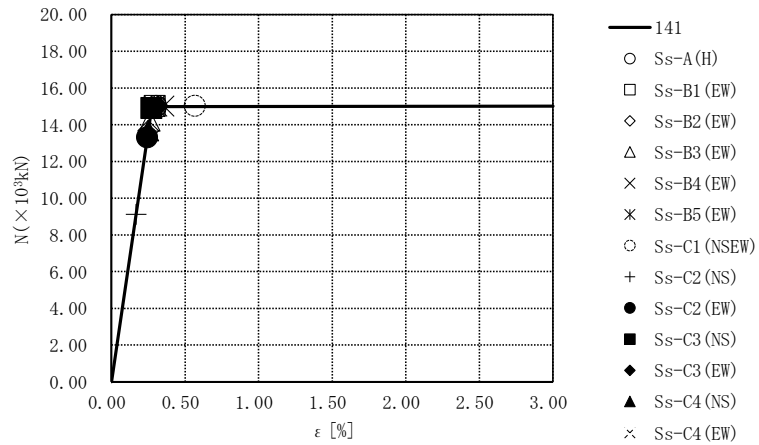

要素番号141

第4.2.1-26図 座屈拘束ブレースの荷重-ひずみ曲線
(基本ケース, EW方向, 全応力解析)

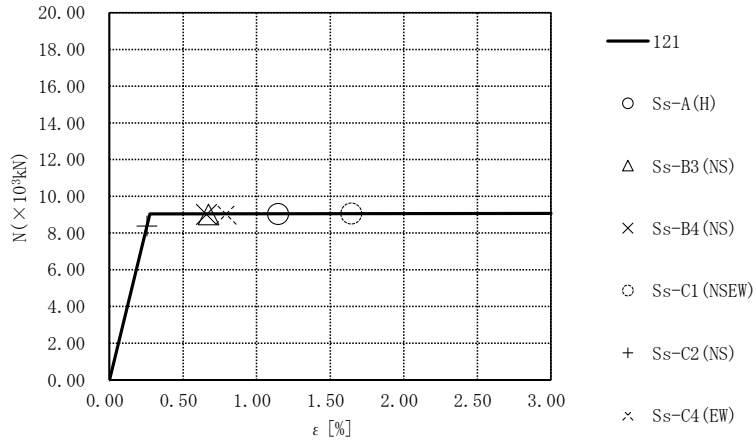

要素番号121

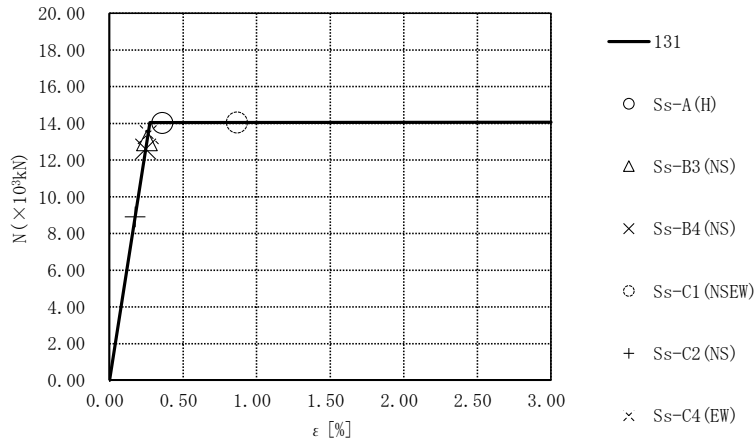

要素番号131

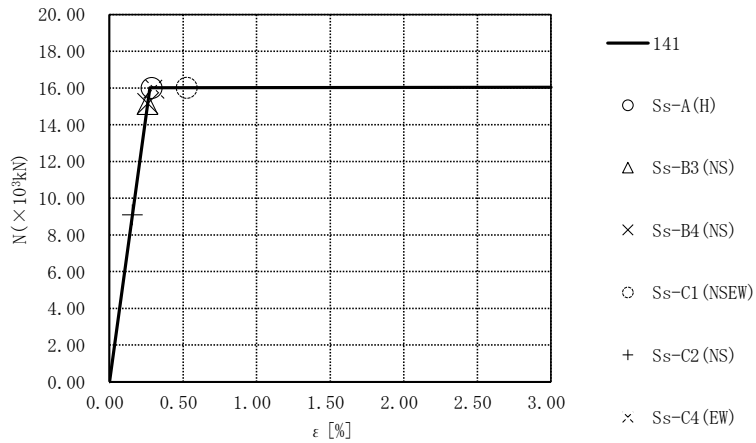

要素番号141

第4.2.1-27図 座屈拘束ブレースの荷重-ひずみ曲線
(+1 σ 地盤, NS方向, 全応力解析)

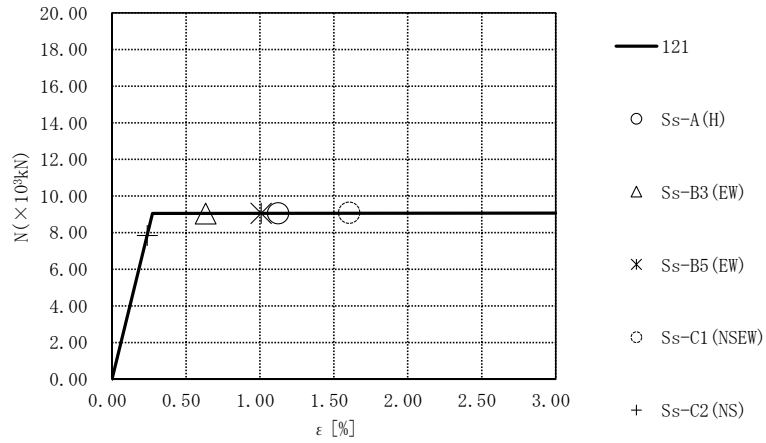

要素番号121

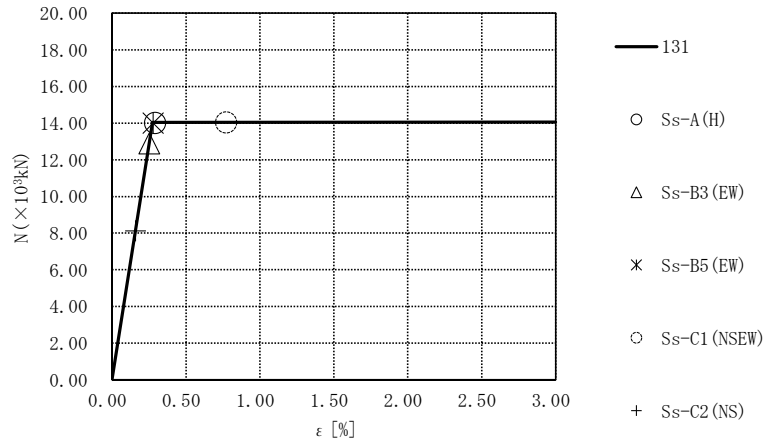

要素番号131

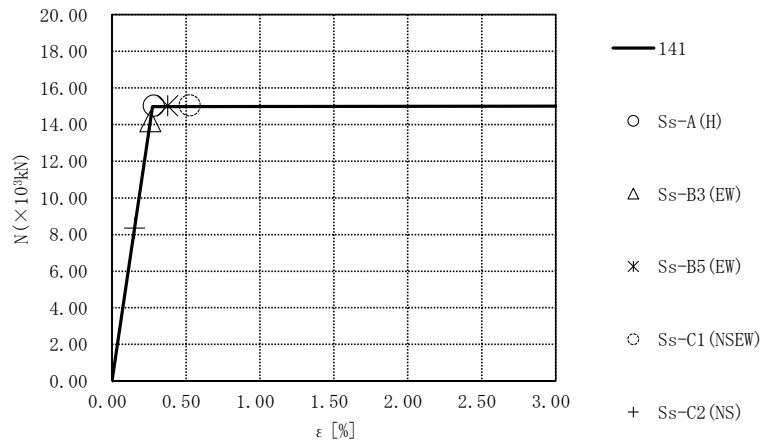

要素番号141

第4.2.1-28図 座屈拘束ブレースの荷重-ひずみ曲線
(+1 σ 地盤, EW方向, 全応力解析)

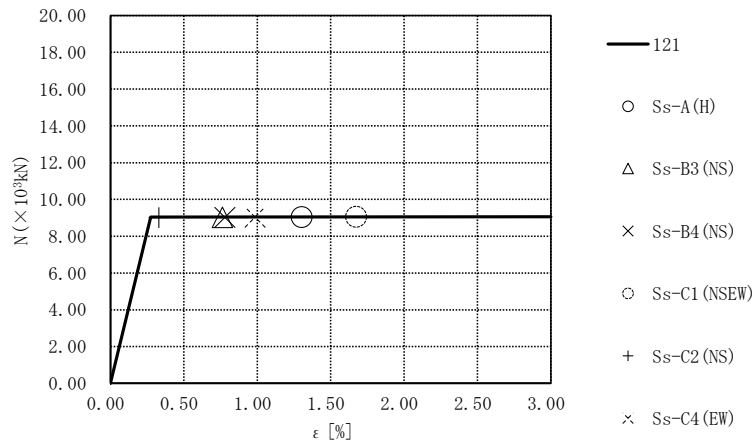

要素番号121

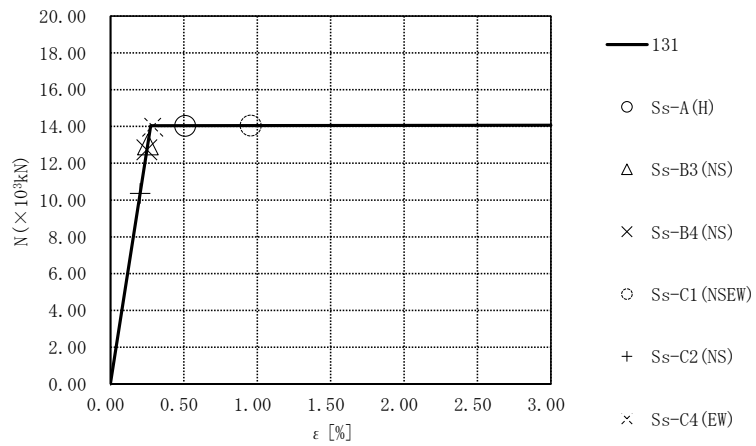

要素番号131

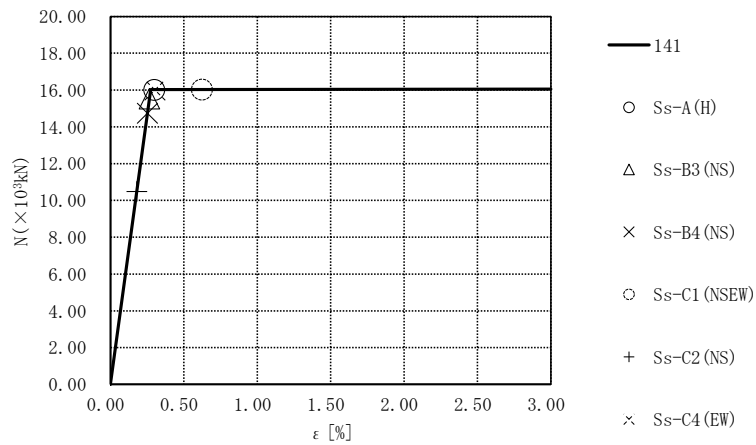

要素番号141

第4.2.1-29図 座屈拘束ブレースの荷重-ひずみ曲線
(-1σ地盤, NS方向, 全応力解析)

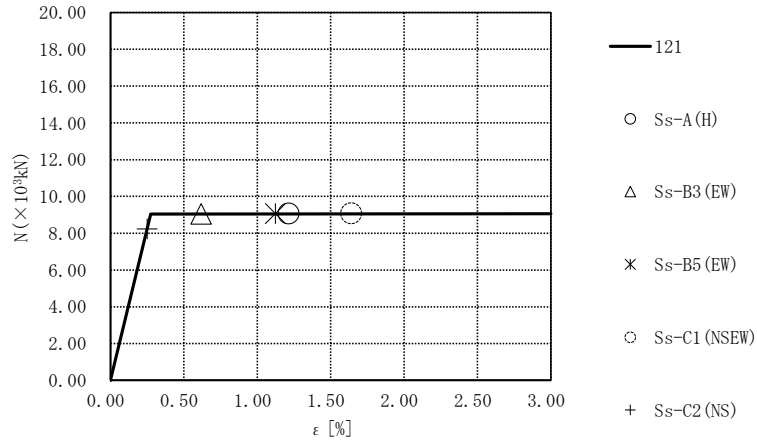

要素番号121

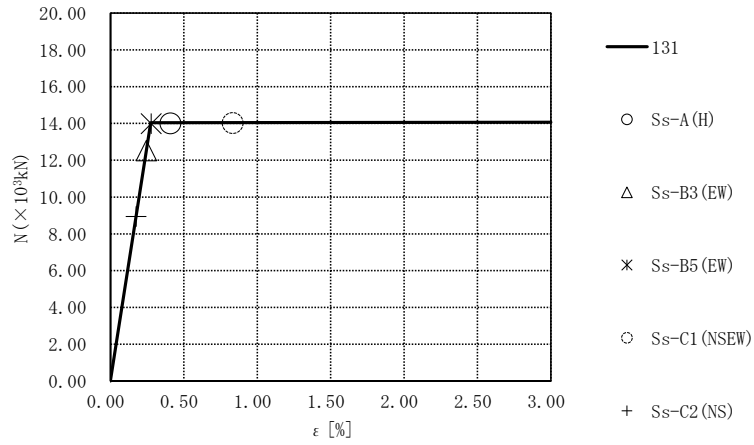

要素番号131

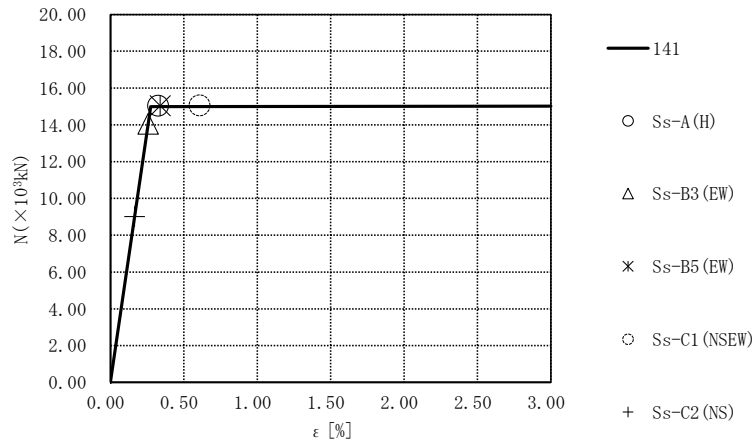

要素番号141

第4.2.1-30図 座屈拘束ブレースの荷重-ひずみ曲線
(-1σ 地盤, EW方向, 全応力解析)

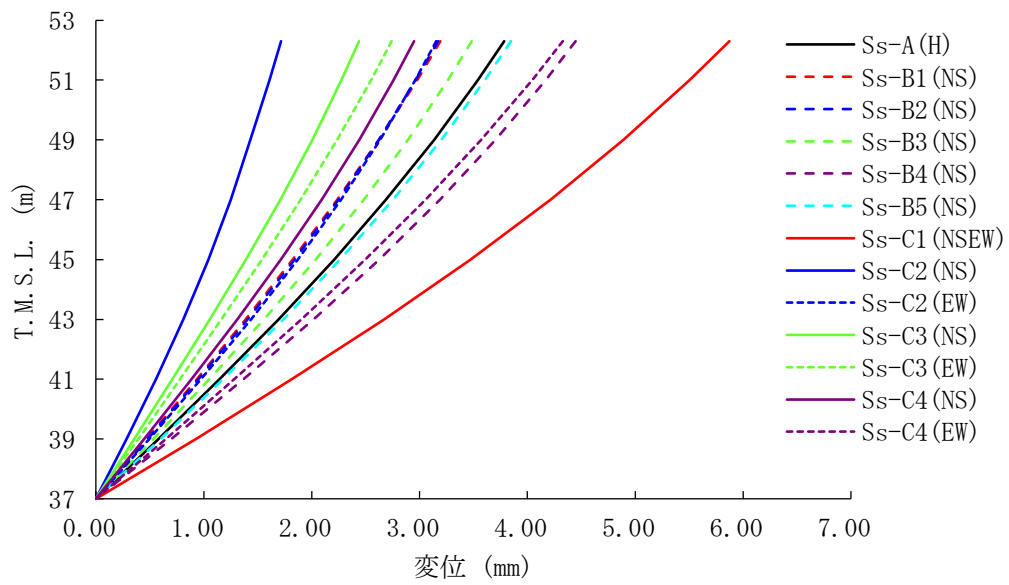

第4.2.1-31図 改良地盤の最大応答変位
(基本ケース, NS断面, 全応力解析)

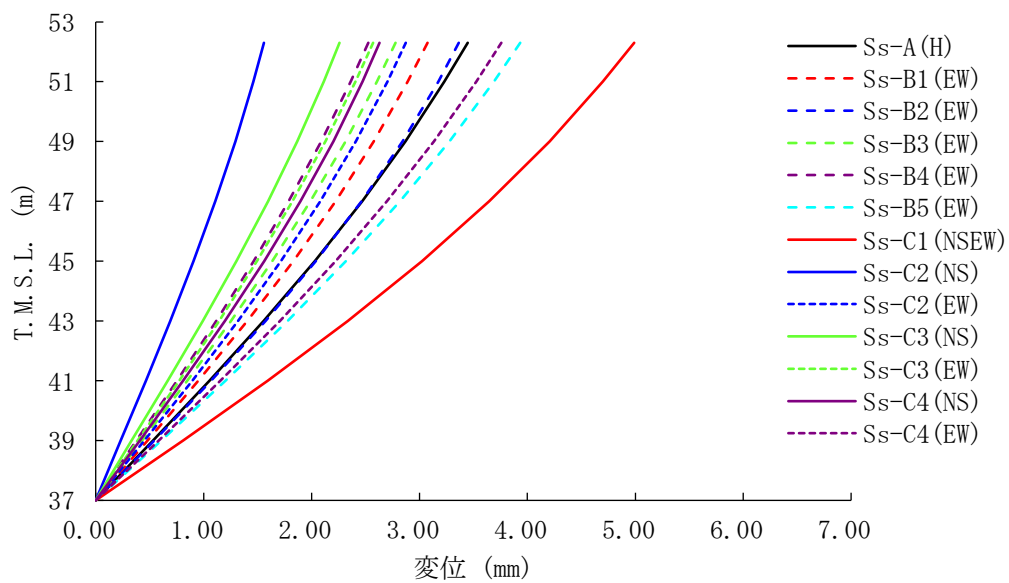

第4.2.1-32図 改良地盤の最大応答変位
(基本ケース, EW断面, 全応力解析)

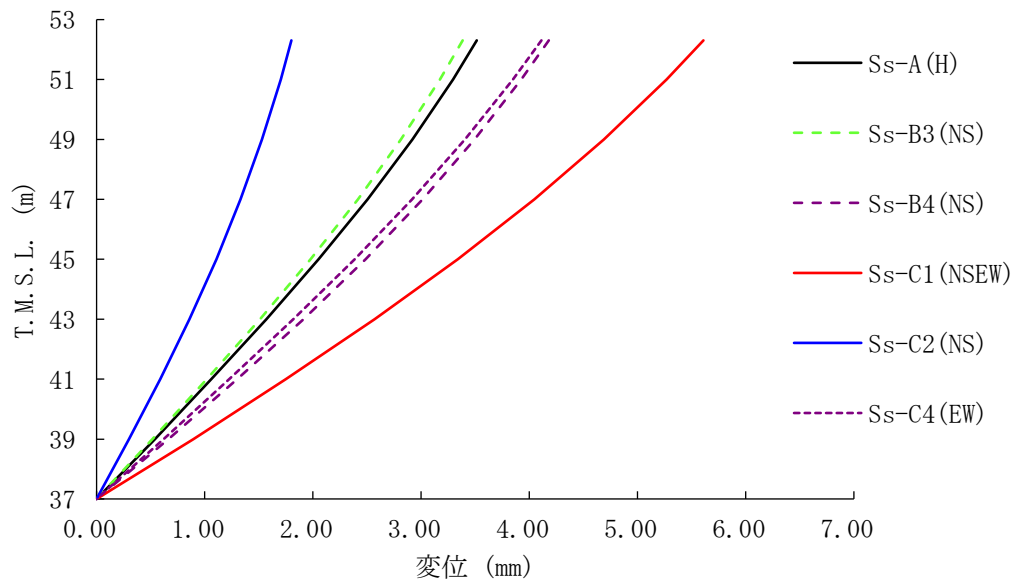

第4.2.1-33図 改良地盤の最大応答変位
(+1 σ 地盤, NS断面, 全応力解析)

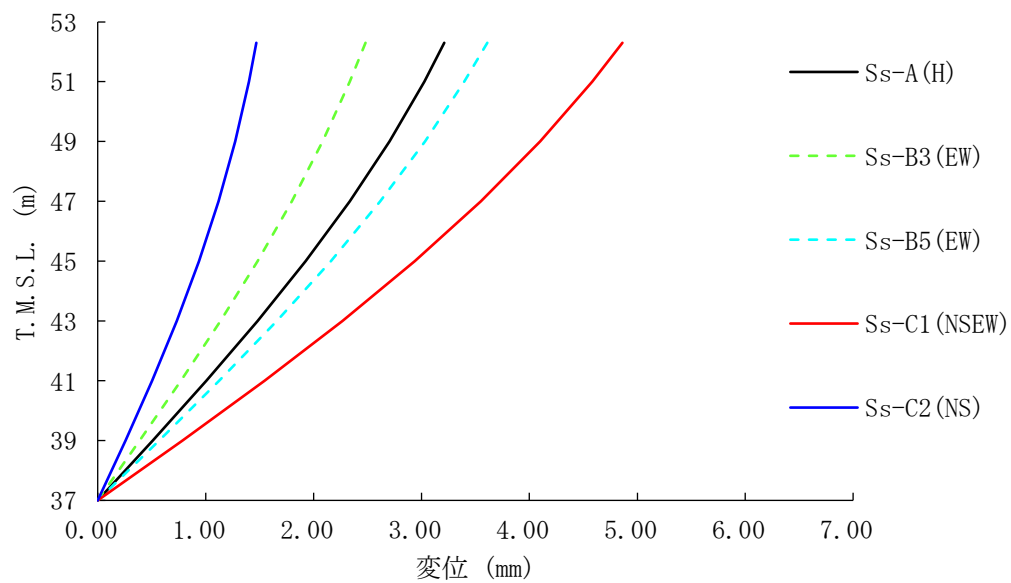

第4.2.1-34図 改良地盤の最大応答変位
(+1 σ 地盤, EW断面, 全応力解析)

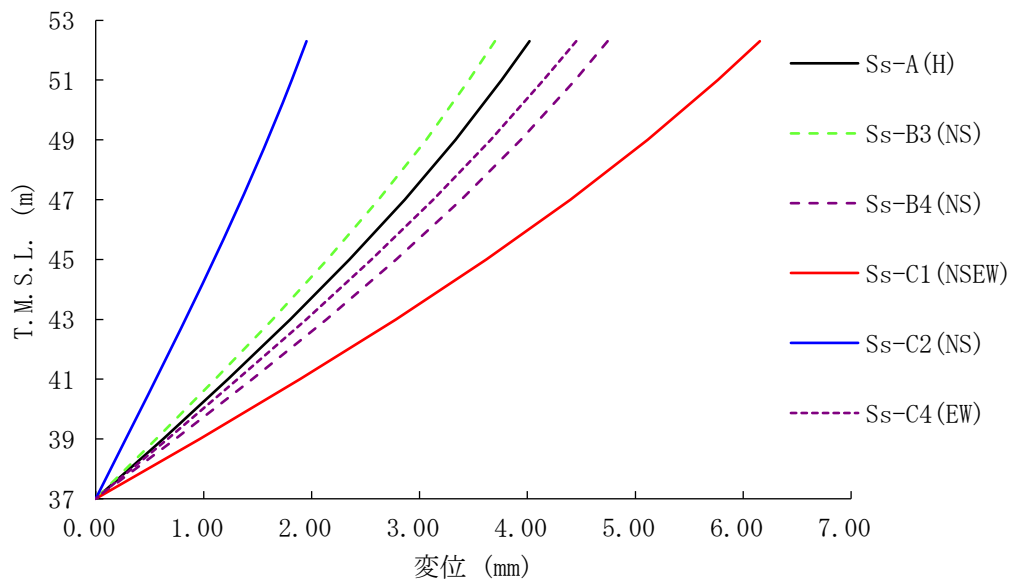

第4.2.1-35図 改良地盤の最大応答変位
(-1σ 地盤, NS断面, 全応力解析)

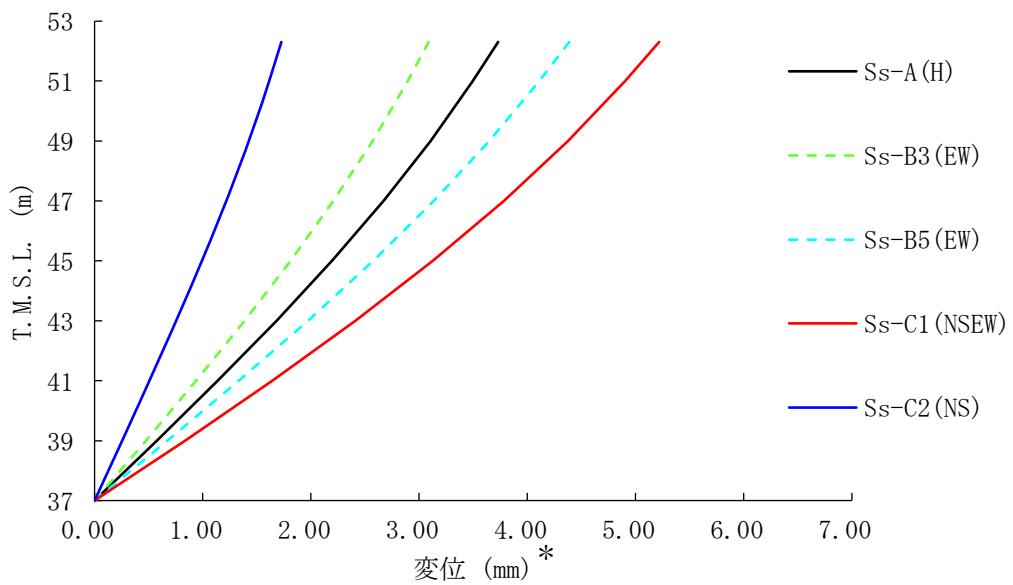

第4.2.1-36図 改良地盤の最大応答変位
(-1σ 地盤, EW断面, 全応力解析)

4.2.2 有効応力解析

有効応力解析結果のうち、飛来物防護ネット架構の最大応答値(加速度, せん断力, 曲げモーメント)を第4.2.2-1図～第4.2.2-24図に, 座屈拘束ブレースの荷重-ひずみ曲線図を第4.2.2-25図～第4.2.2-30図に, 改良地盤の最大応答変位*を第4.2.2-31図～第4.2.2-36図に示す。

注記 * : 応答変位は, 改良地盤下端(T.M.S.L. 37.00m)からの相対変位とし, 各レベルでの節点変位の平均値として算定する。最大応答変位は, 応答変位の時刻歴における最大値を示す。

最大応答加速度 (NS方向)

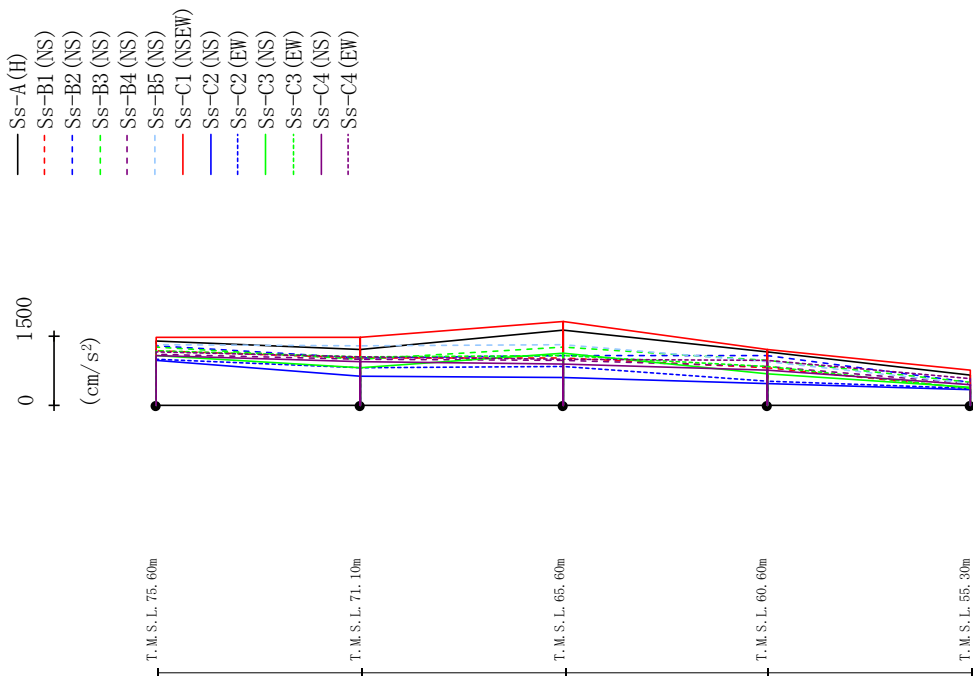

	Ss-A (H)	Ss-B1 (NS)	Ss-B2 (NS)	Ss-B3 (NS)	Ss-B4 (NS)	Ss-B5 (NS)	Ss-C1 (NSEE)	Ss-C2 (NS)	Ss-C2 (EW)	Ss-C3 (NS)	Ss-C3 (EW)	Ss-C4 (NS)	Ss-C4 (EW)
1386	1177	1284	1258	1115	1330	1475	971	1005	1085	1195	1079	1167	
1223	1023	1029	1006	997	1278	1476	624	807	826	1054	942	1046	
1633	1033	1086	1262	979	1317	1823	592	830	1121	1067	888	1004	
1169	826	1069	979	843	948	1198	471	529	688	852	759	986	
660	372	497	508	484	475	753	328	370	379	373	458	571	

第4.2.2-1図 最大応答加速度 (基本ケース, NS方向, 有効応力解析)

最大応答せん断力 (NS方向)

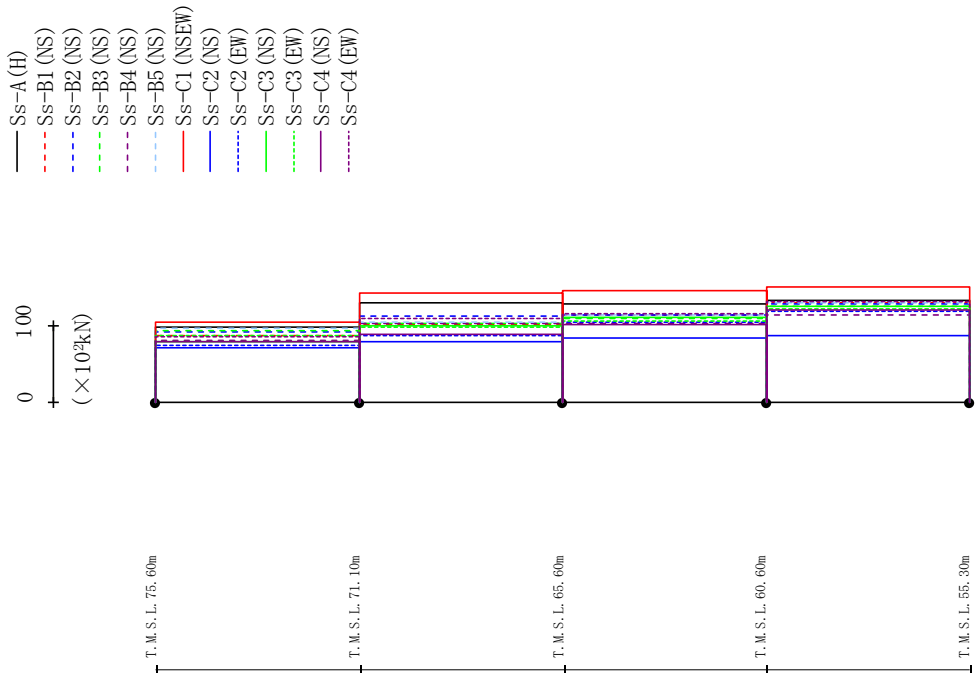

(× 10⁴kN)

Ss-A (H)	Ss-B1 (NS)	Ss-B2 (NS)	Ss-B3 (NS)	Ss-B4 (NS)	Ss-B5 (NS)	Ss-C1 (NSEW)	Ss-C2 (NS)	Ss-C2 (EW)	Ss-C3 (NS)	Ss-C3 (EW)	Ss-C4 (NS)	Ss-C4 (EW)
98.80	86.41	92.22	92.52	80.37	96.13	104.17	70.80	73.59	78.64	86.93	78.96	85.14
129.55	100.57	112.73	102.21	102.71	103.88	142.30	78.49	86.32	100.20	98.27	87.79	109.79
127.93	113.28	113.37	108.86	102.88	113.95	146.26	83.08	105.05	110.57	106.01	101.43	114.96
132.17	130.41	127.54	124.84	114.62	130.04	150.48	86.21	119.28	125.03	121.75	119.89	131.26

第4.2.2-2図 最大応答せん断力 (基本ケース, NS方向, 有効応力解析)

最大応答曲げモーメント (NS方向)

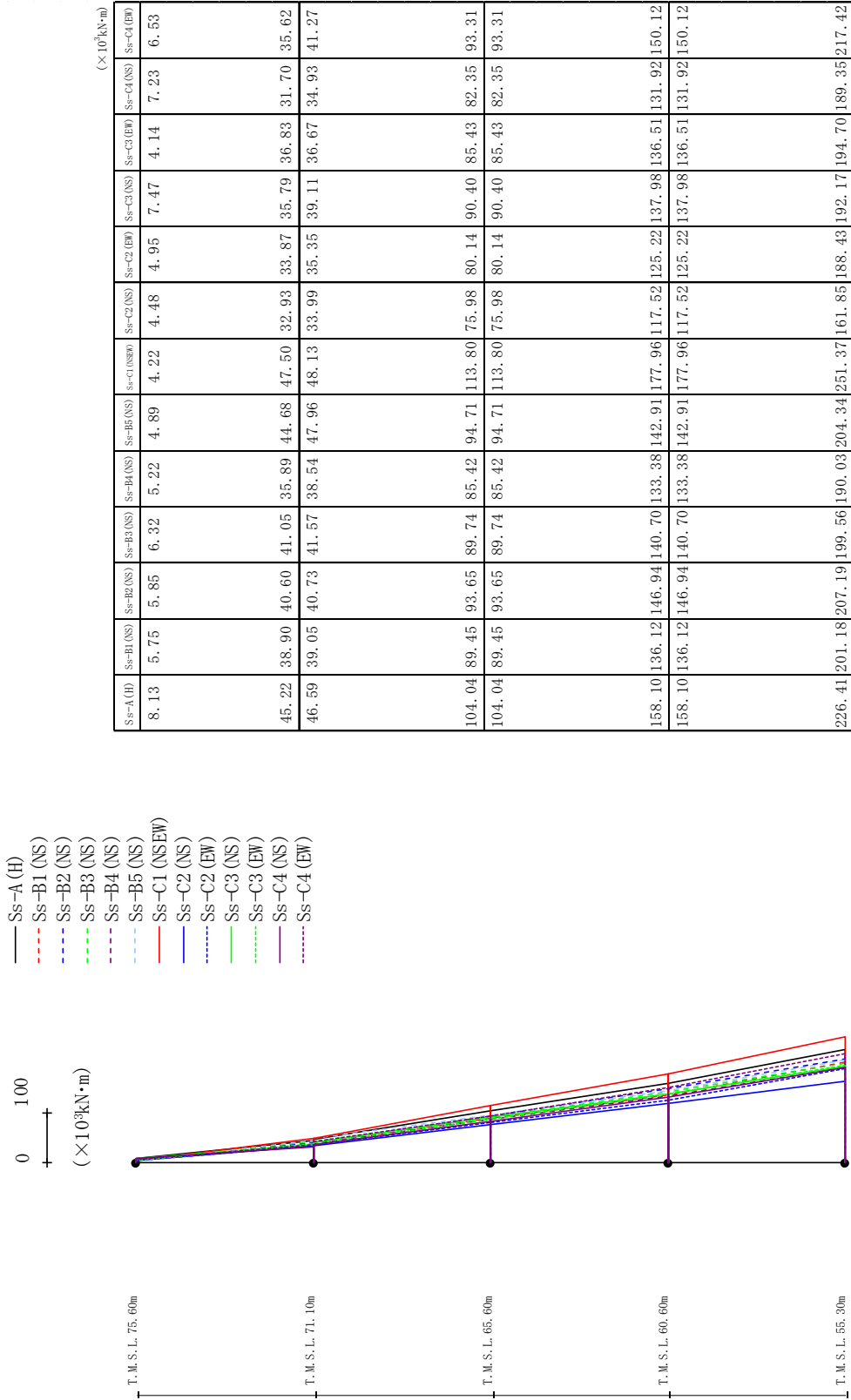

第4.2.2-3図 最大応答曲げモーメント (基本ケース, NS方向, 有効応力解析)

最大応答加速度 (UD方向)

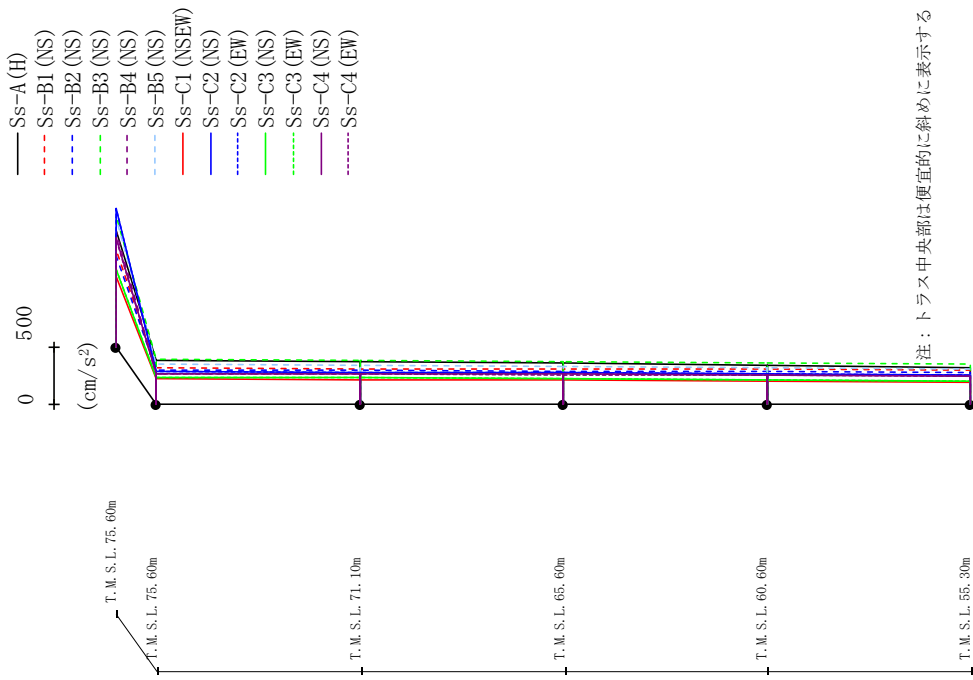

	Ss-A (H)	Ss-B1 (NS)	Ss-B2 (NS)	Ss-B3 (NS)	Ss-B4 (NS)	Ss-B5 (NS)	Ss-C1 (NSEW)	Ss-C2 (NS)	Ss-C2 (EW)	Ss-C3 (NS)	Ss-C3 (EW)	Ss-C4 (NS)	Ss-C4 (EW)
1008	847	786	1135	996	1117	614	1202	1205	673	671	943	940	
382	317	294	388	269	348	217	283	282	236	236	260	260	
374	311	292	381	265	342	215	279	278	232	232	261	260	
358	305	289	371	260	332	210	270	270	223	223	259	258	
340	304	284	361	254	320	201	260	260	212	212	254	254	
317	301	276	349	252	306	189	255	255	197	197	246	245	

第4.2.2-4図 最大応答鉛直加速度 (基本ケース, NS方向, 有効応力解析)

最大応答加速度 (EW方向)

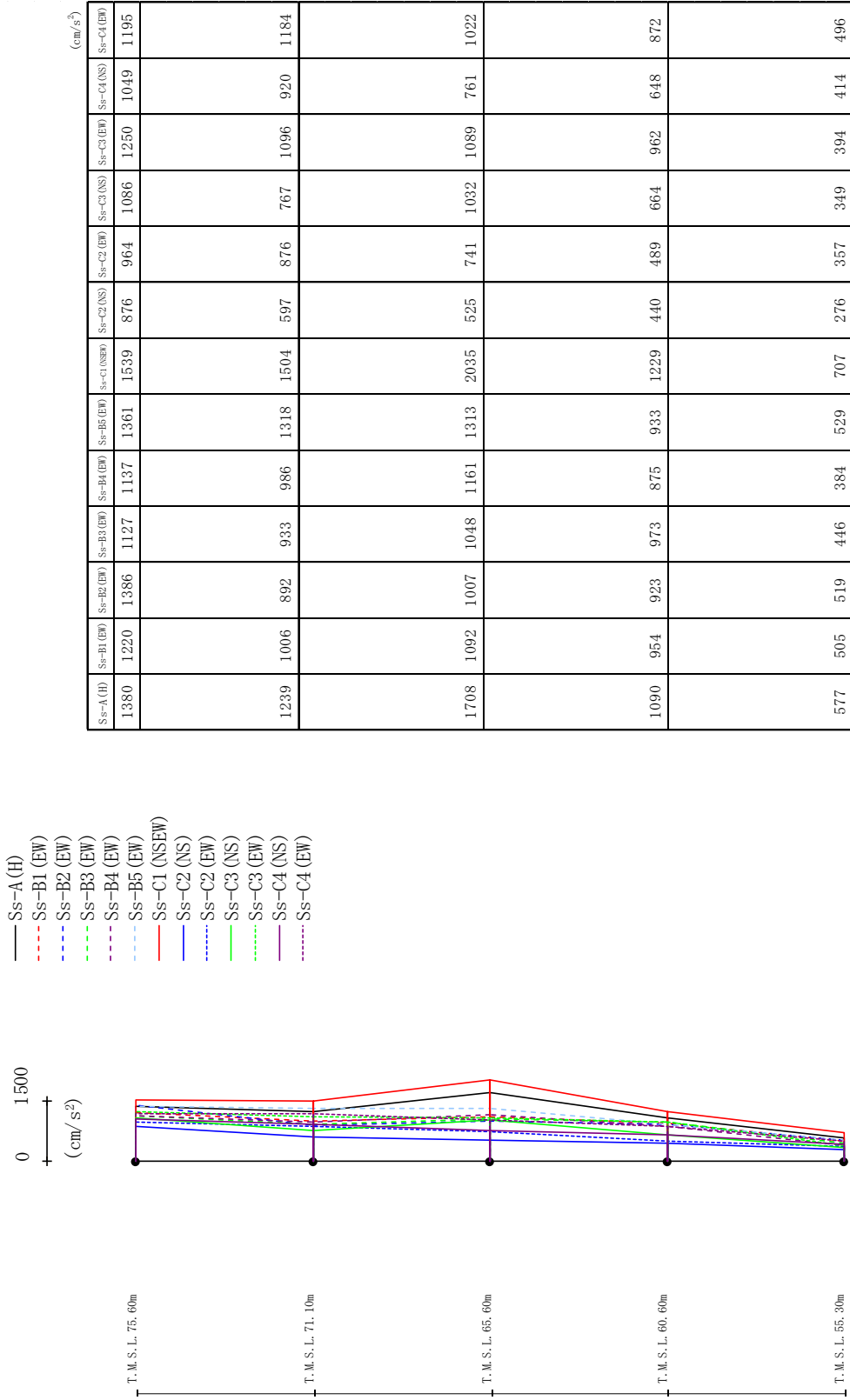

第4.2.2-5図 最大応答加速度 (基本ケース, EW方向, 有効応力解析)

最大応答せん断力 (EW方向)

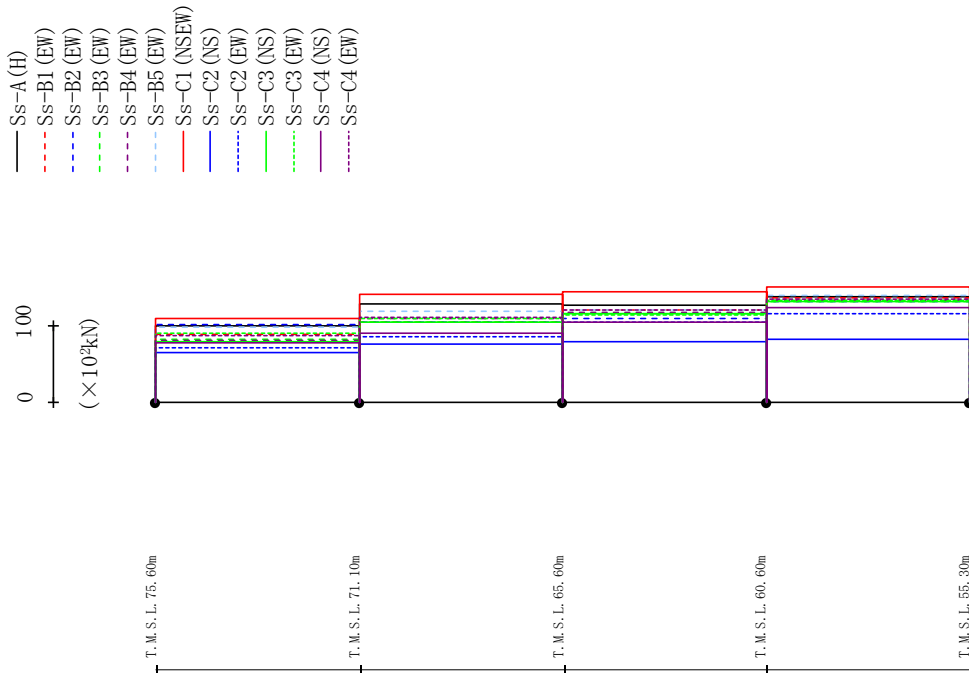

(× 10²kN)

Ss-A (H)	Ss-B1 (EW)	Ss-B2 (EW)	Ss-B3 (EW)	Ss-B4 (EW)	Ss-B5 (EW)	Ss-C1 (NSEW)	Ss-C2 (NS)	Ss-C2 (EW)	Ss-C3 (NS)	Ss-C3 (EW)	Ss-C4 (NS)	Ss-C4 (EW)
98.92	89.00	100.86	82.65	81.18	98.69	108.79	64.29	70.59	79.54	90.68	77.19	87.47
127.85	104.75	105.08	105.04	109.37	118.47	141.36	75.32	85.87	104.25	108.50	89.77	111.34
127.07	120.54	109.08	115.79	116.61	120.87	144.14	79.33	104.13	115.17	114.24	104.41	121.00
137.34	136.12	130.91	131.58	132.35	139.61	150.92	81.94	116.03	131.47	133.35	123.36	134.50

第4.2.2-6図 最大応答せん断力 (基本ケース, EW方向, 有効応力解析)

最大応答曲げモーメント (EW方向)

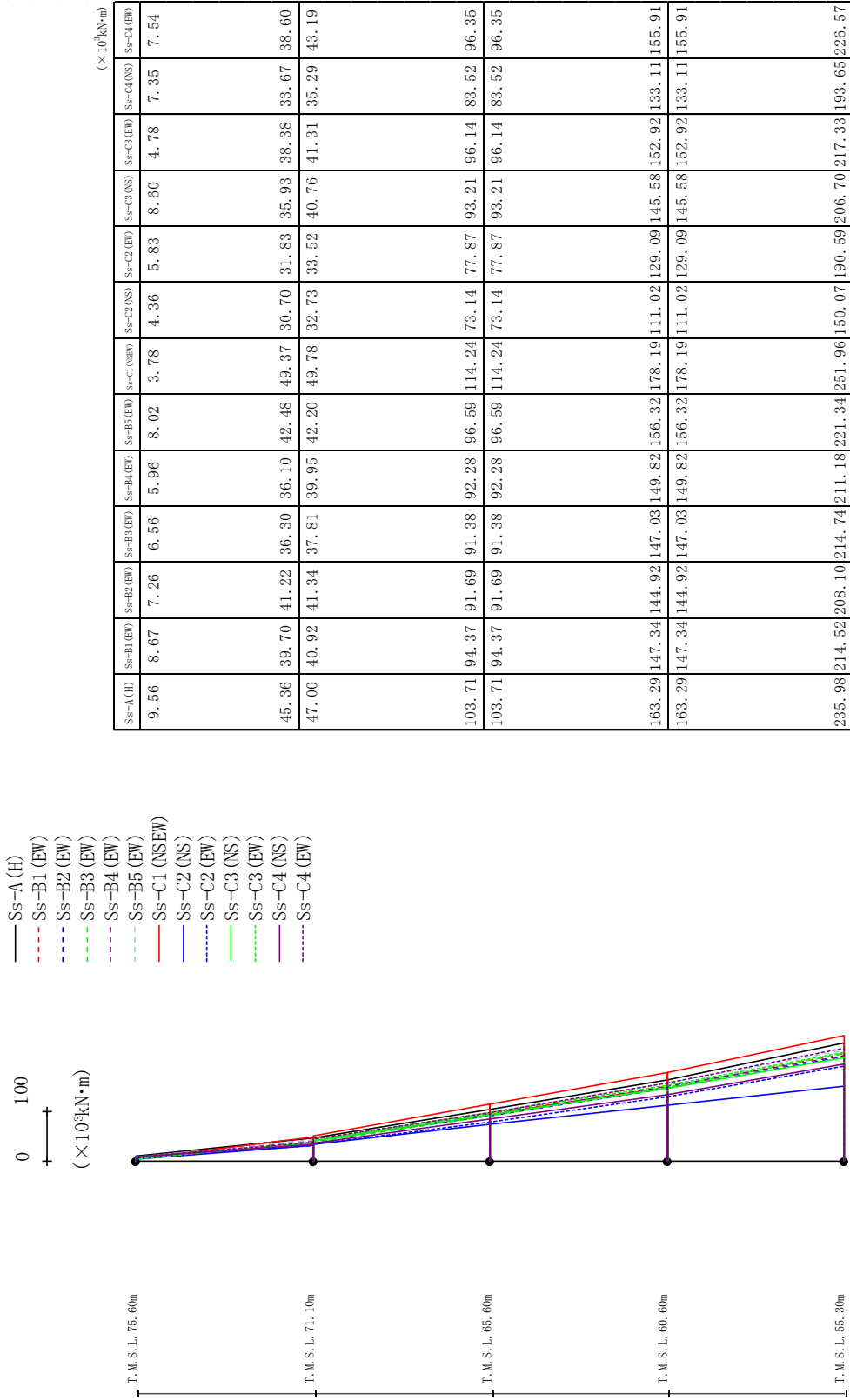

第4.2.2-7図 最大応答曲げモーメント (基本ケース, EW方向, 有効応力解析)

最大応答加速度 (UD方向)

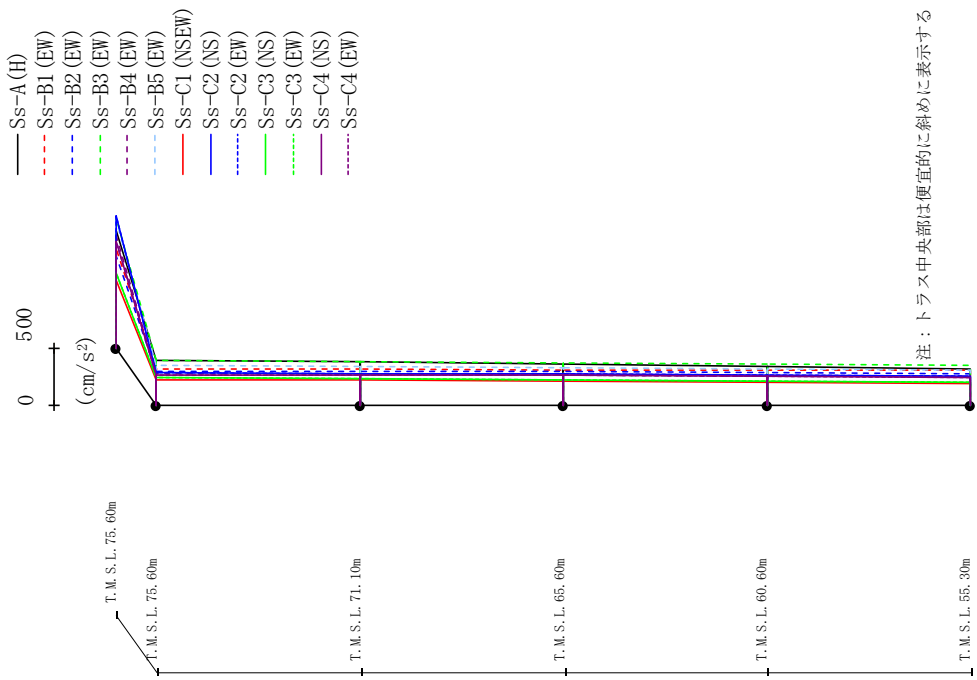

注：トラス中央部は便宜的に斜めに表示する

	Ss-A (H)	Ss-B1 (EW)	Ss-B2 (EW)	Ss-B3 (EW)	Ss-B4 (EW)	Ss-B5 (EW)	Ss-C1 (NSEW)	Ss-C2 (NS)	Ss-C2 (EW)	Ss-C3 (NS)	Ss-C3 (EW)	Ss-C4 (NS)	Ss-C4 (EW)
1018	862	802	1130	983	1105	586	1149	1152	648	646	928	926	
384	319	295	388	272	345	217	280	280	237	237	260	260	
375	313	293	381	268	339	215	276	276	233	233	260	260	
360	306	290	372	263	330	210	268	268	224	224	258	258	
342	304	285	361	257	319	202	261	262	213	213	253	253	
319	301	277	349	252	305	190	256	256	198	198	245	245	

第4.2.2-8図 最大応答鉛直加速度 (基本ケース, EW方向, 有効応力解析)

最大応答加速度 (NS方向)

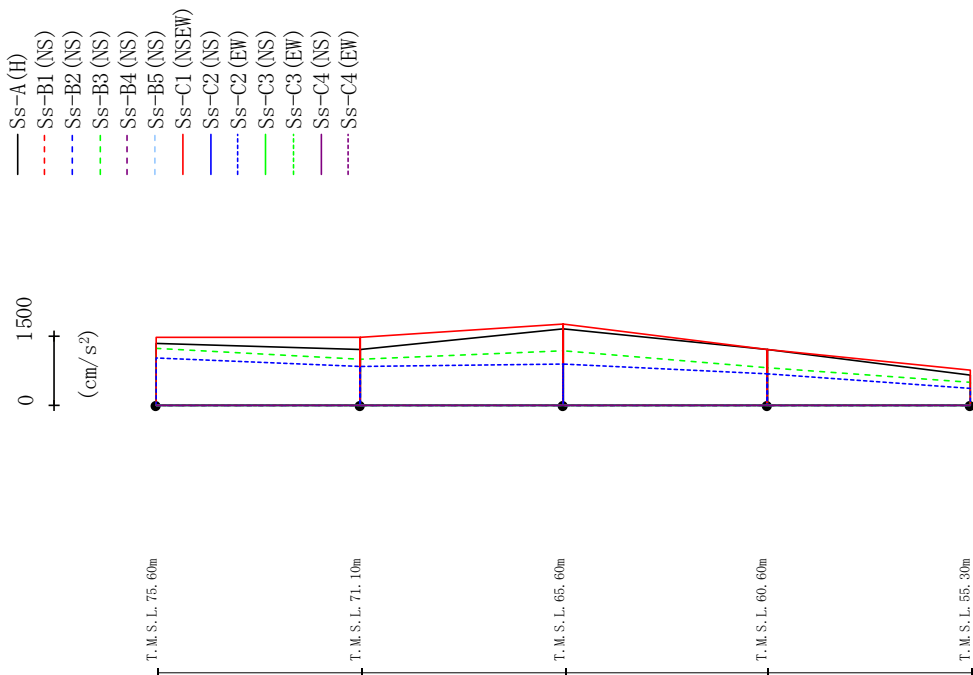

Ss-A (H)	Ss-B1 (NS)	Ss-B2 (NS)	Ss-B3 (NS)	Ss-B4 (NS)	Ss-B5 (NS)	Ss-C1 (NNEW)	Ss-C2 (NS)	Ss-C2 (EW)	Ss-C3 (NS)	Ss-C3 (EW)	Ss-C4 (NS)	Ss-C4 (EW)
1344	-	-	1247	-	-	1487	-	1038	-	-	-	-
1219	-	-	1013	-	-	1479	-	834	-	-	-	-
1673	-	-	1174	-	-	1774	-	904	-	-	-	-
1202	-	-	817	-	-	1212	-	686	-	-	-	-
663	-	-	495	-	-	767	-	356	-	-	-	-

第4.2.2-9図 最大応答加速度 (+1σ地盤, NS方向, 有効応力解析)

最大応答せん断力 (NS方向)

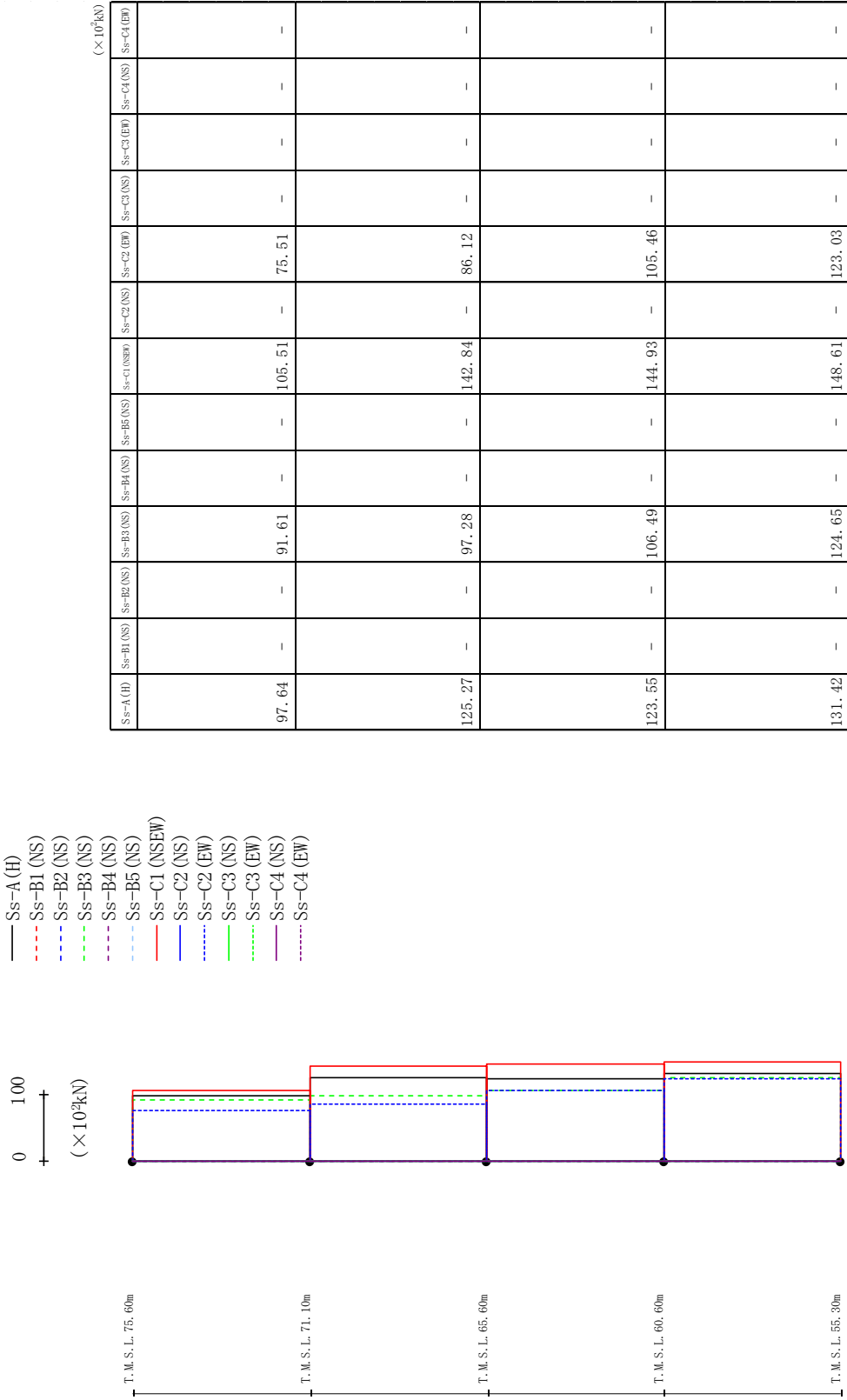

第4.2.2-10図 最大応答せん断力 (+1σ地盤, NS方向, 有効応力解析)

最大応答曲げモーメント (NS方向)

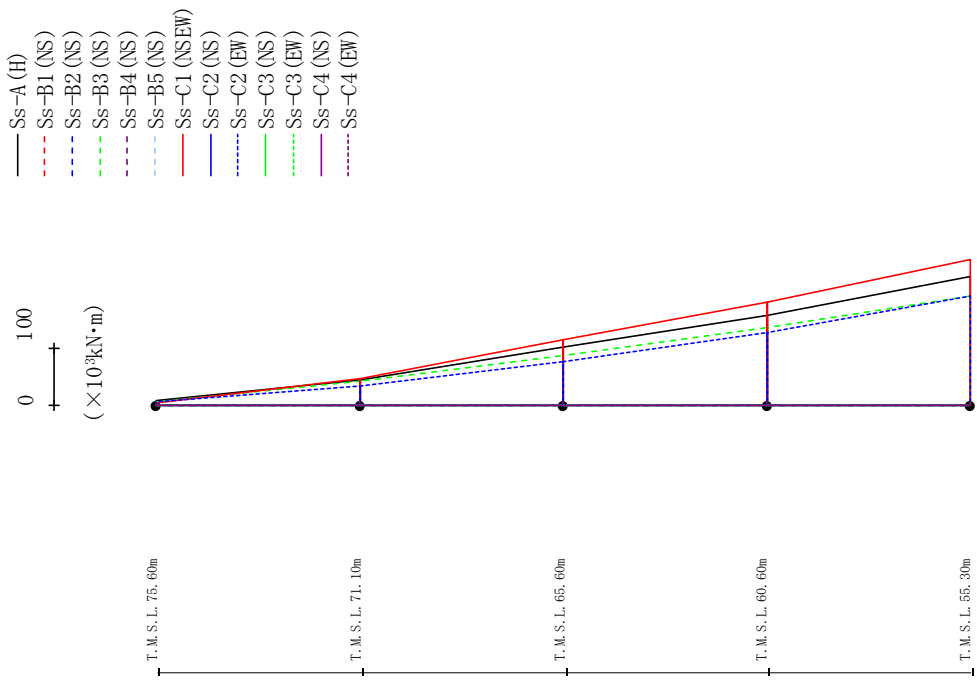

Ss-A (H)		Ss-B1 (NS)	Ss-B2 (NS)	Ss-B3 (NS)	Ss-B4 (NS)	Ss-B5 (NS)	Ss-C1 (NSEW)	Ss-C2 (NS)	Ss-C2 (EW)	Ss-C3 (NS)	Ss-C3 (EW)	Ss-C4 (NS)	Ss-C4 (EW)
8.20	-	-	7.00	-	-	-	4.37	-	-	-	-	-	-
43.29	-	-	41.12	-	-	-	46.99	-	-	-	-	-	-
45.11	-	-	42.23	-	-	-	46.88	-	-	-	-	-	-
100.49	-	-	87.52	-	-	-	113.58	-	-	-	-	-	-
100.49	-	-	87.52	-	-	-	113.58	-	-	-	-	-	-
156.77	-	-	135.53	-	-	-	178.90	-	-	-	-	-	-
156.77	-	-	135.53	-	-	-	178.90	-	-	-	-	-	-
223.84	-	-	190.45	-	-	-	252.69	-	-	-	-	-	-

(×10³kN·m)

第4.2.2-11図 最大応答曲げモーメント (+1σ地盤, NS方向, 有効応力解析)

最大応答加速度 (UD方向)

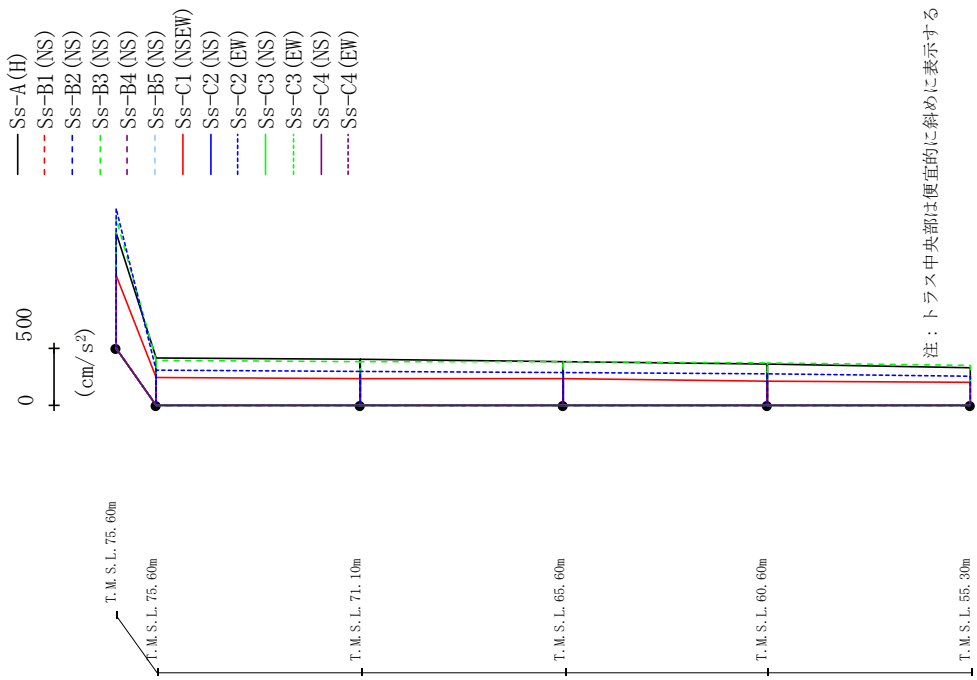

Ss-A(H)	Ss-B1(NS)	Ss-B2(NS)	Ss-B3(NS)	Ss-B4(NS)	Ss-B5(NS)	Ss-C1(NSEW)	Ss-C2(NS)	Ss-C2(EW)	Ss-C3(NS)	Ss-C3(EW)	Ss-C4(NS)	Ss-C4(EW)	Ss-C1(NS)	Ss-C1(EW)	Ss-C2(NS)	Ss-C2(EW)	Ss-C3(NS)	Ss-C3(EW)	Ss-C4(NS)	Ss-C4(EW)		
1004	-	1124	-	-	-	628	-	-	-	-	-	-	-	-	1212	-	-	-	-	-	-	-
409	-	390	-	-	-	239	-	-	-	-	-	-	-	-	300	-	-	-	-	-	-	-
398	-	-	-	-	-	235	-	-	-	-	-	-	-	-	295	-	-	-	-	-	-	-
377	-	-	-	-	-	226	-	-	-	-	-	-	-	-	284	-	-	-	-	-	-	-
353	-	-	-	-	-	214	-	-	-	-	-	-	-	-	270	-	-	-	-	-	-	-
322	-	-	-	-	-	197	-	-	-	-	-	-	-	-	257	-	-	-	-	-	-	-

第4.2.2-12図 最大応答鉛直加速度 (+1σ地震, NS方向, 有効応力解析)

最大応答加速度 (EW方向)

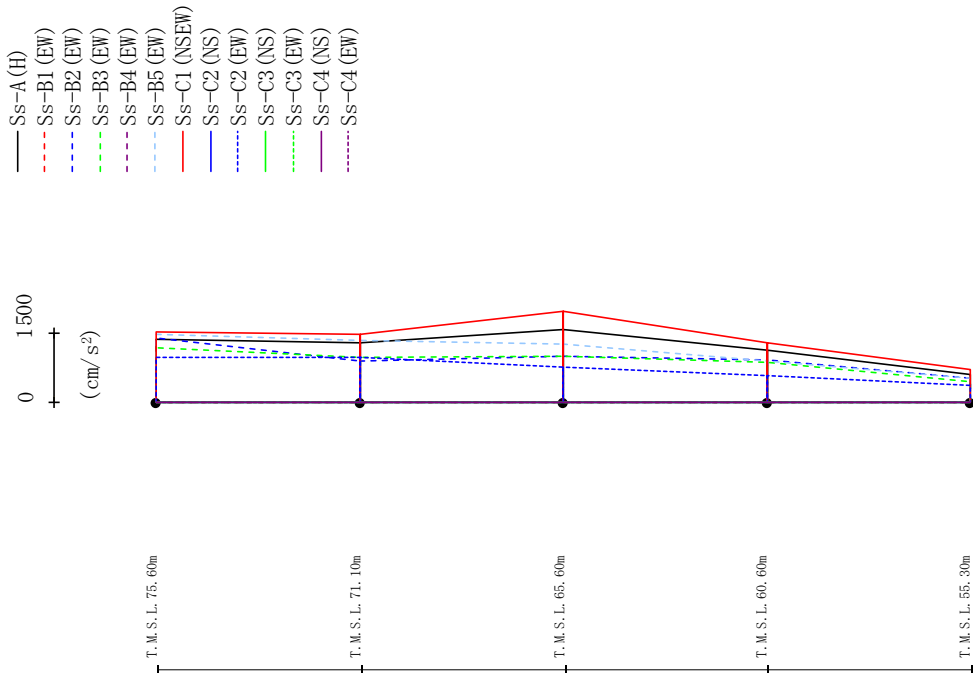

Ss-A (H)	Ss-B1 (EW)	Ss-B2 (EW)	Ss-B3 (EW)	Ss-B4 (EW)	Ss-B5 (EW)	Ss-C1 (NSEW)	Ss-C2 (NS)	Ss-C2 (EW)	Ss-C3 (NS)	Ss-C3 (EW)	Ss-C4 (NS)	Ss-C4 (EW)
1358	-	1393	1187	-	1470	1515	-	979	-	-	-	-
1291	-	899	969	-	1340	1476	-	965	-	-	-	-
1589	-	995	1012	-	1260	1973	-	761	-	-	-	-
1136	-	928	875	-	906	1281	-	566	-	-	-	-
616	-	531	453	-	519	699	-	365	-	-	-	-

第4.2.2-13図 最大応答加速度 (+1σ 地盤, EW方向, 有効応力解析)

最大応答せん断力 (EW方向)

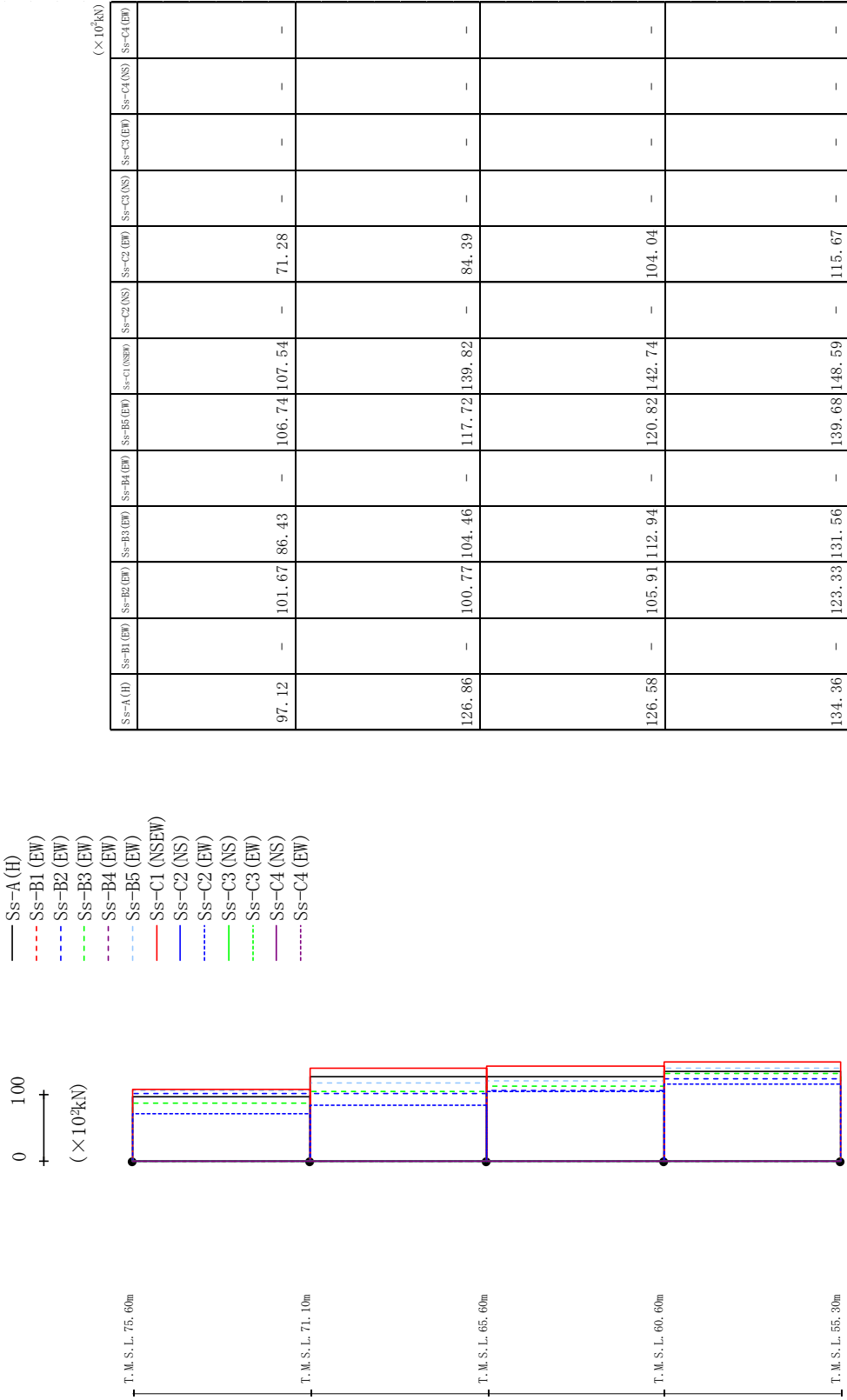

第4.2.2-14図 最大応答せん断力 (+1σ地盤, EW方向, 有効応力解析)

最大応答曲げモーメント (EW方向)

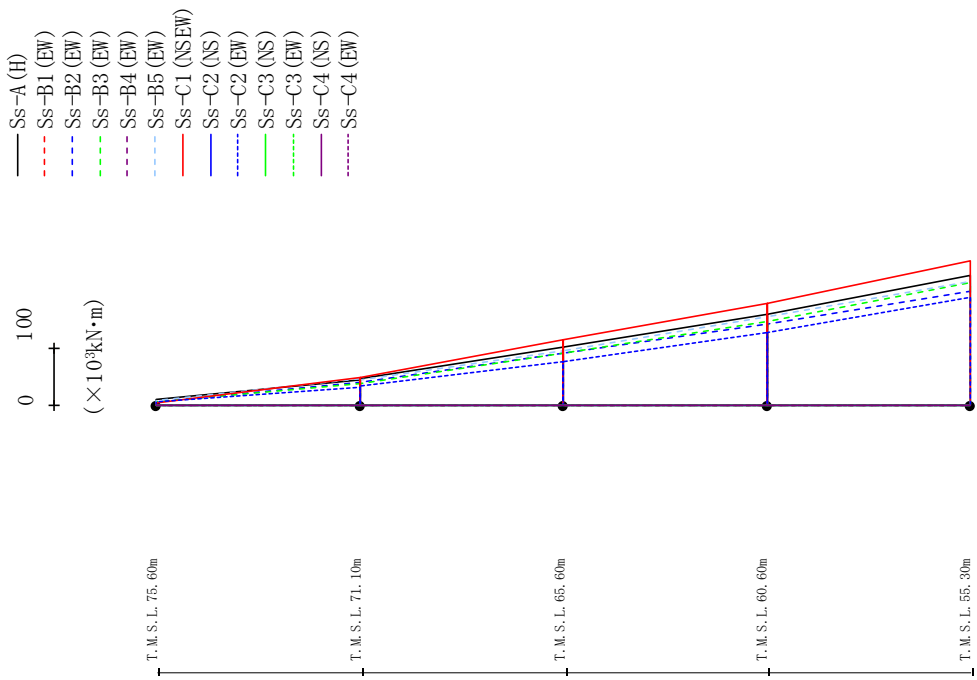

Ss-A (H)		Ss-B1 (EW)	Ss-B2 (EW)	Ss-B3 (EW)	Ss-B4 (EW)	Ss-B5 (EW)	Ss-C1 (N/EW)	Ss-C2 (NS)	Ss-C2 (EW)	Ss-C3 (NS)	Ss-C3 (EW)	Ss-C4 (NS)	Ss-C4 (EW)
10.10	-	6.46	7.07	-	-	7.33	3.98	-	6.15	-	-	-	-
43.85	-	40.25	37.18	-	-	46.06	48.18	-	30.69	-	-	-	-
45.35	-	39.15	37.98	-	-	44.08	48.55	-	33.68	-	-	-	-
100.77	-	90.80	90.30	-	-	94.98	113.06	-	76.09	-	-	-	-
100.77	-	90.80	90.30	-	-	94.98	113.06	-	76.09	-	-	-	-
159.27	-	140.68	145.92	-	-	153.92	177.51	-	126.10	-	-	-	-
159.27	-	140.68	145.92	-	-	153.92	177.51	-	126.10	-	-	-	-
226.90	-	198.32	212.38	-	-	214.98	251.56	-	186.95	-	-	-	-

(× 10³ kN·m)

第4.2.2-15図 最大応答曲げモーメント (+1σ地盤, EW方向, 有効応力解析)

最大応答加速度 (UD方向)

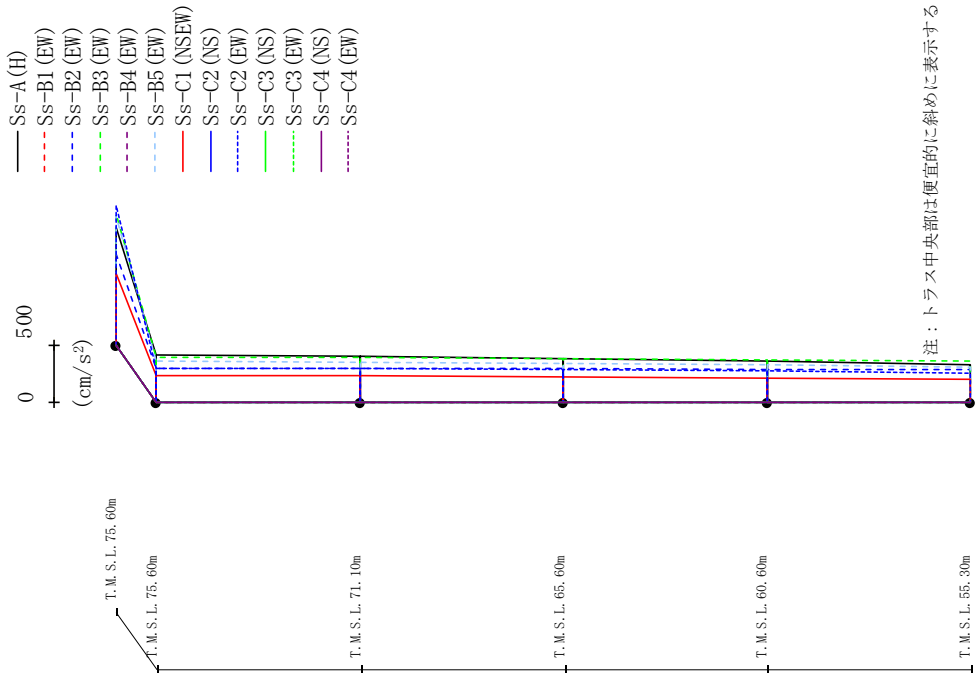

Ss-A (H)	Ss-B1 (EW)	Ss-B2 (EW)	Ss-B3 (EW)	Ss-B4 (EW)	Ss-B5 (EW)	Ss-C1 (NSEW)	Ss-C2 (NS)	Ss-C2 (EW)	Ss-C3 (NS)	Ss-C3 (EW)	Ss-C4 (NS)	Ss-C4 (EW)
1017	-	787	1133	-	1117	619	-	1207	-	-	-	-
410	-	294	392	-	355	230	-	298	-	-	-	-
399	-	293	385	-	348	227	-	293	-	-	-	-
379	-	289	376	-	337	220	-	282	-	-	-	-
354	-	285	365	-	324	209	-	269	-	-	-	-
324	-	279	352	-	308	195	-	256	-	-	-	-

第4.2.2-16図 最大応答鉛直加速度 (+1σ地震, EW方向, 有効応力解析)

最大応答加速度 (NS方向)

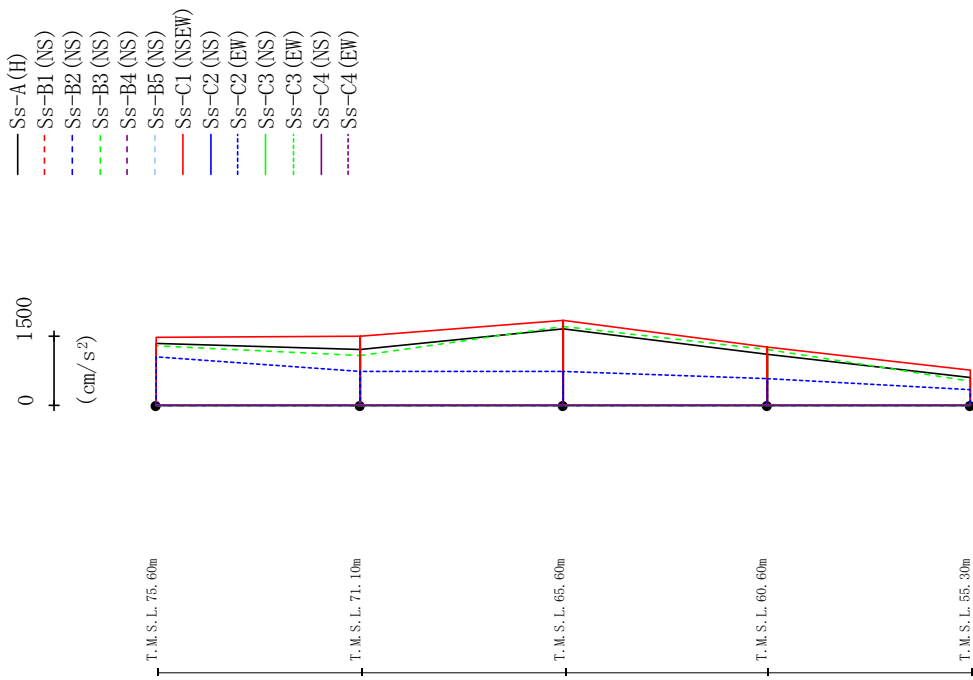

Ss-A (H)	Ss-B1 (NS)	Ss-B2 (NS)	Ss-B3 (NS)	Ss-B4 (NS)	Ss-B5 (NS)	Ss-C1 (NSEW)	Ss-C2 (NS)	Ss-C2 (EW)	Ss-C3 (NS)	Ss-C3 (EW)	Ss-C4 (NS)	Ss-C4 (EW)
1349	-	-	1282	-	-	1487	-	1040	-	-	-	-
1221	-	-	1081	-	-	1509	-	726	-	-	-	-
1666	-	-	1710	-	-	1848	-	745	-	-	-	-
1110	-	-	1219	-	-	1261	-	572	-	-	-	-
606	-	-	520	-	-	754	-	349	-	-	-	-

第4.2.2-17図 最大応答加速度 (-1σ地盤, NS方向, 有効応力解析)

最大応答せん断力 (NS方向)

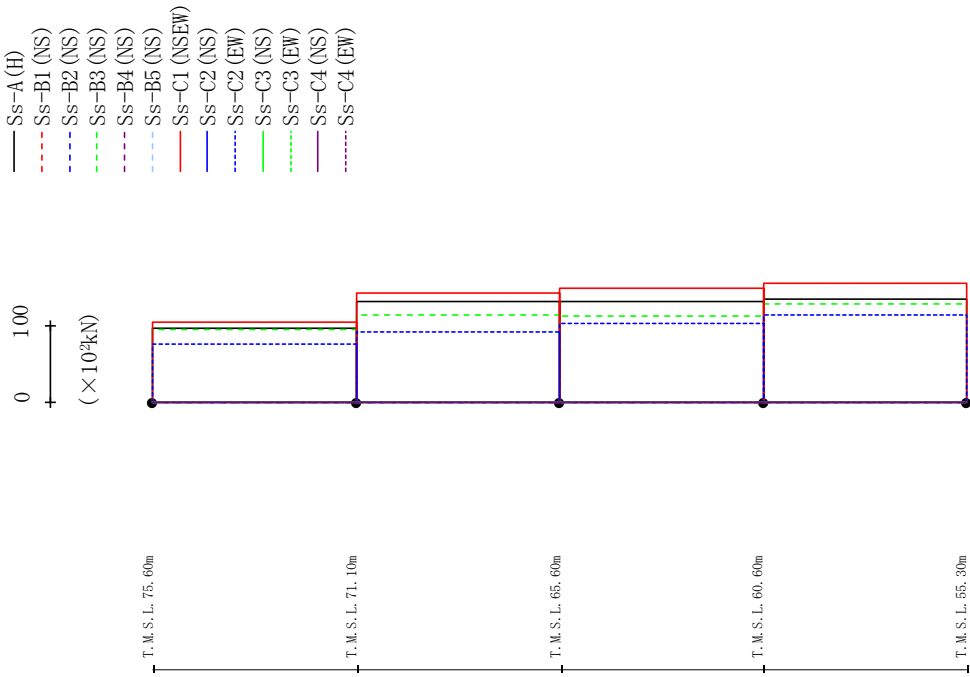

(×10⁴kN)

Ss-A (H)	Ss-B1 (NS)	Ss-B2 (NS)	Ss-B3 (NS)	Ss-B4 (NS)	Ss-B5 (NS)	Ss-C1 (NSEW)	Ss-C2 (NS)	Ss-C2 (EW)	Ss-C3 (NS)	Ss-C3 (EW)	Ss-C4 (NS)	Ss-C4 (EW)
96.10	-	94.27	-	104.97	-	75.88	-	-	-	-	-	-
130.89	-	114.49	-	143.21	-	91.70	-	-	-	-	-	-
131.81	-	112.51	-	148.33	-	102.19	-	-	-	-	-	-
134.46	-	128.26	-	154.79	-	113.23	-	-	-	-	-	-

第4.2.2-18図 最大応答せん断力 (-1σ地震, NS方向, 有効応力解析)

最大応答曲げモーメント (NS方向)

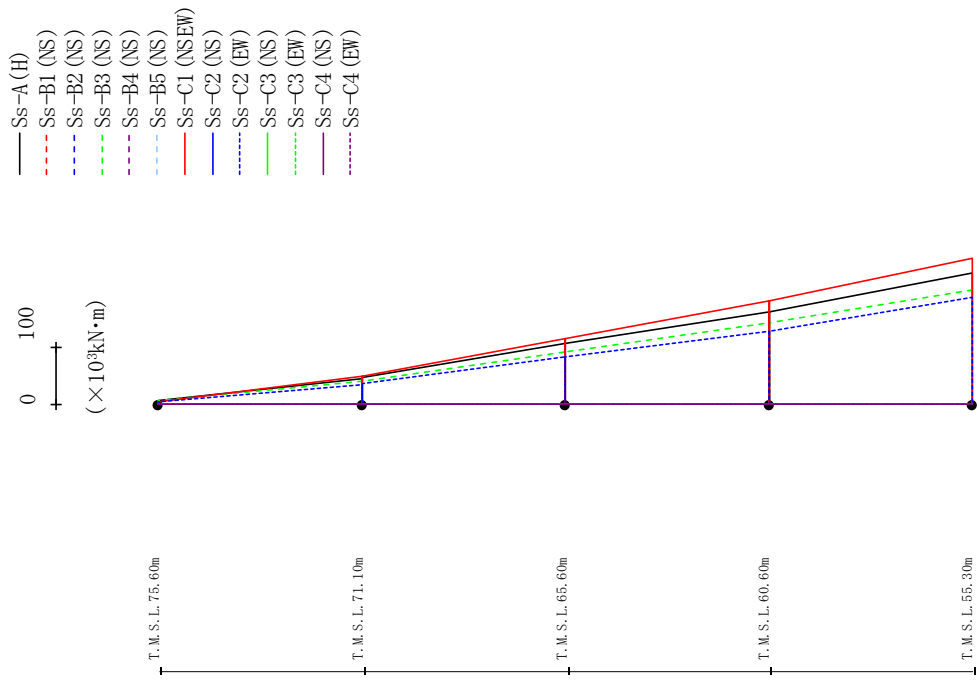

Ss-A (H)	Ss-B1 (NS)	Ss-B2 (NS)	Ss-B3 (NS)	Ss-B4 (NS)	Ss-B5 (NS)	Ss-C1 (NSEW)	Ss-C2 (NS)	Ss-C2 (EW)	Ss-C3 (NS)	Ss-C3 (EW)	Ss-C4 (NS)	Ss-C4 (EW)
7.71	-	6.40	-	-	3.63	4.43	-	-	-	-	-	-
44.97	-	41.17	-	48.53	34.90	-	-	-	-	-	-	-
46.69	-	41.00	-	49.82	36.19	-	-	-	-	-	-	-
106.18	-	91.08	-	115.06	82.52	-	-	-	-	-	-	-
106.18	-	91.08	-	115.06	82.52	-	-	-	-	-	-	-
161.02	-	141.59	-	179.42	128.06	-	-	-	-	-	-	-
161.02	-	141.59	-	179.42	128.06	-	-	-	-	-	-	-
228.97	-	199.39	-	253.69	185.44	-	-	-	-	-	-	-

(× 10³ kN·m)

第4.2.2-19図 最大応答曲げモーメント (-1σ地盤, NS方向, 有効応力解析)

最大応答加速度 (UD方向)

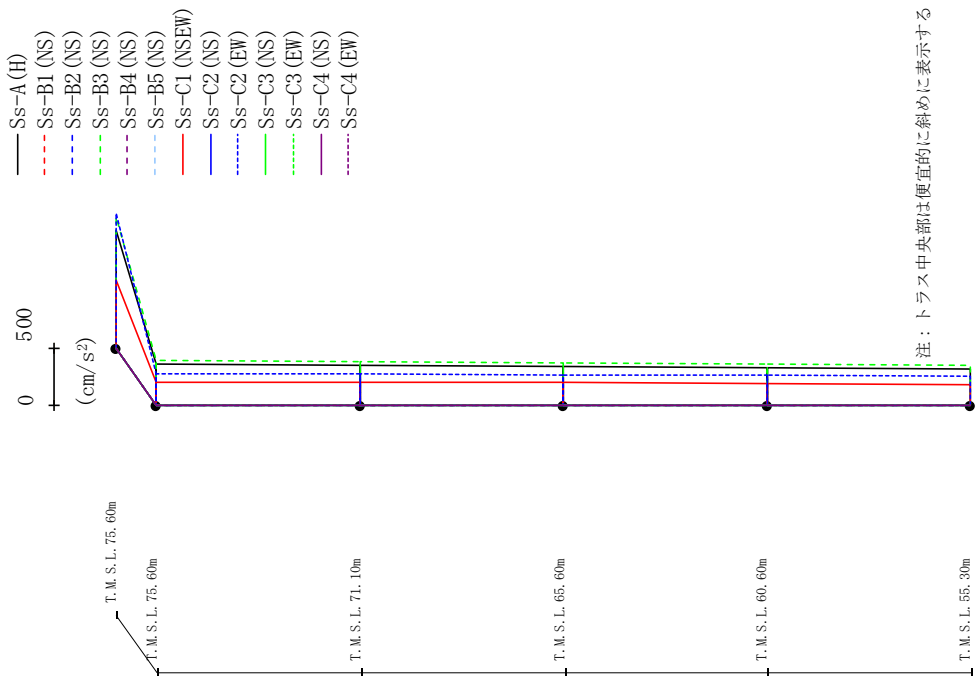

Ss-A (H)	Ss-B1 (NS)	Ss-B2 (NS)	Ss-B3 (NS)	Ss-B4 (NS)	Ss-B5 (NS)	Ss-C1 (NSEW)	Ss-C2 (NS)	Ss-C2 (EW)	Ss-C3 (NS)	Ss-C3 (EW)	Ss-C4 (NS)	Ss-C4 (EW)
1025	-	1137	-	-	587	-	1167	-	-	-	-	-
361	-	386	-	204	-	275	-	-	-	-	-	-
352	-	380	-	202	-	271	-	-	-	-	-	-
341	-	371	-	198	-	266	-	-	-	-	-	-
327	-	362	-	191	-	261	-	-	-	-	-	-
311	-	351	-	182	-	257	-	-	-	-	-	-

第4.2.2-20図 最大応答鉛直加速度 (-1σ地震, NS方向, 有効応力解析)

最大応答加速度 (EW方向)

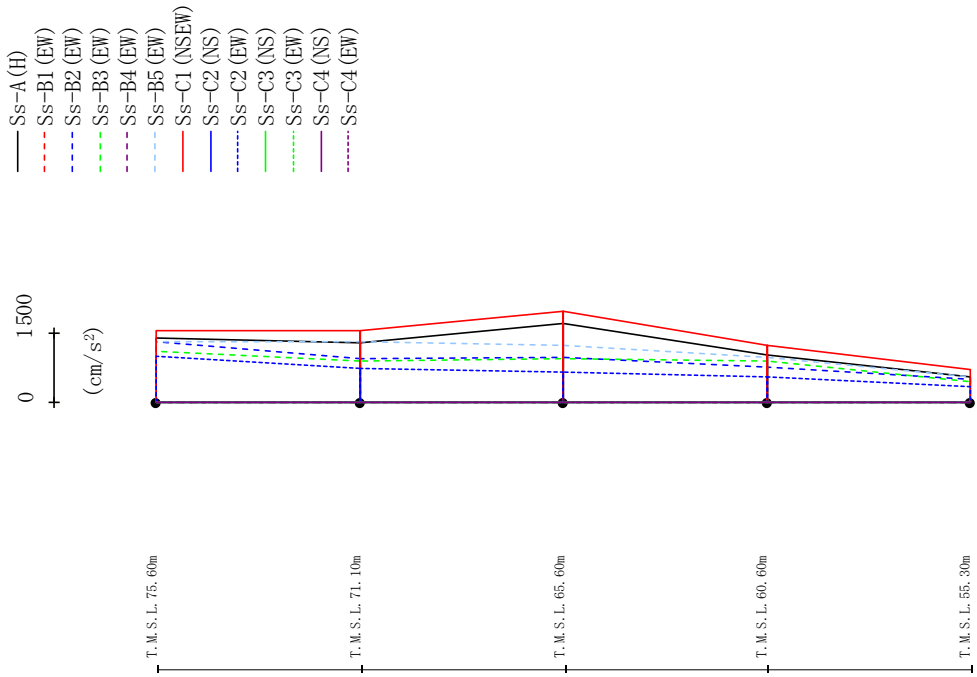

Ss-A (H)	Ss-B1 (EW)	Ss-B2 (EW)	Ss-B3 (EW)	Ss-B4 (EW)	Ss-B5 (EW)	Ss-C1 (NSEW)	Ss-C2 (NS)	Ss-C2 (EW)	Ss-C3 (NS)	Ss-C3 (EW)	Ss-C4 (NS)	Ss-C4 (EW)
1388	1309	1111	1329	1562	989	1544	723	989	-	-	-	-
1291	950	899	1311	1544	723	1544	723	723	-	-	-	-
1725	966	938	1247	1970	669	1970	669	669	-	-	-	-
1020	768	885	972	1245	559	1245	559	559	-	-	-	-
557	496	435	543	715	343	715	343	343	-	-	-	-

第4.2.2-21図 最大応答加速度 (-1σ地盤, EW方向, 有効応力解析)

最大応答せん断力 (EW方向)

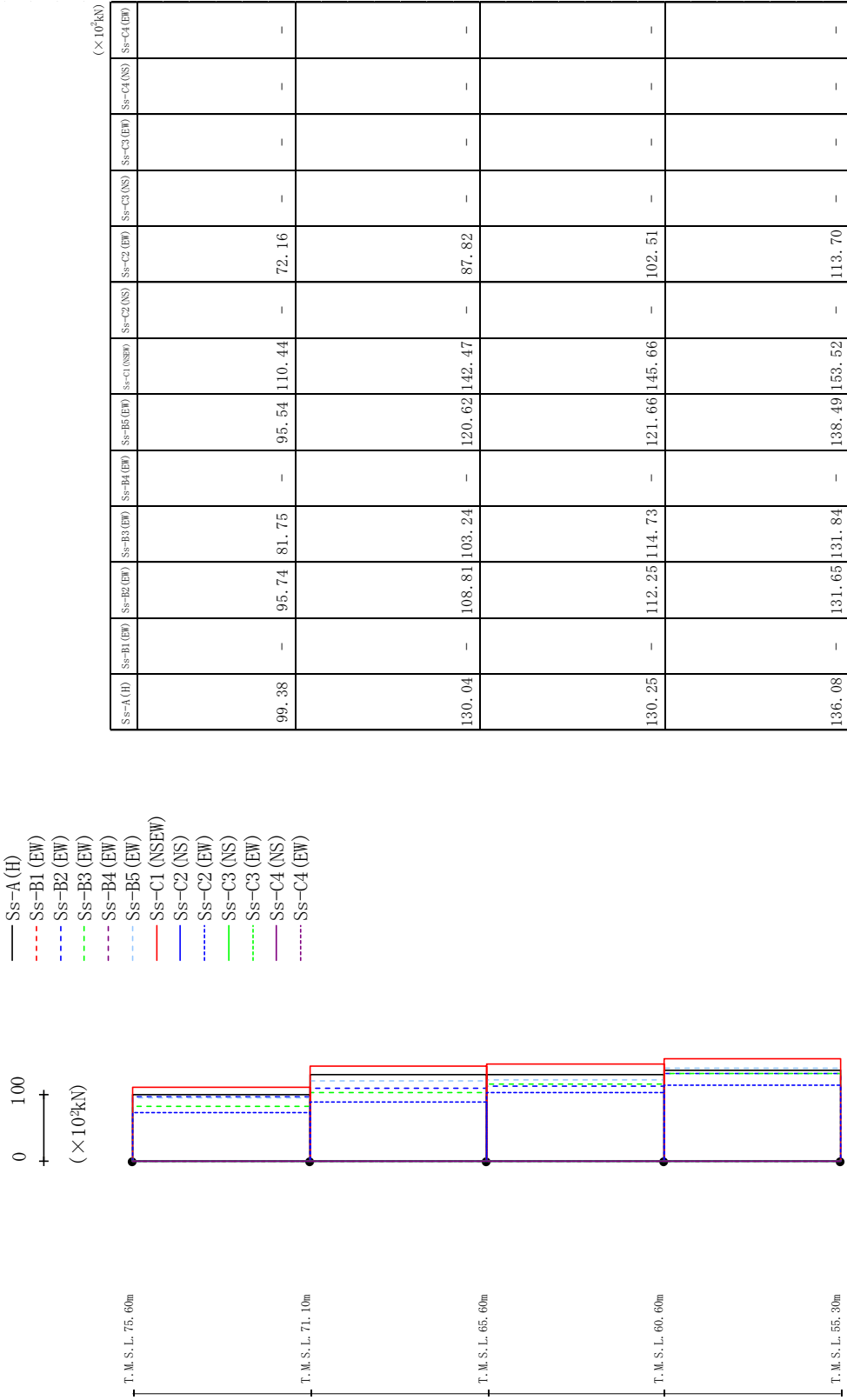

第4.2.2-22図 最大応答せん断力 (-1σ地震, EW方向, 有効応力解析)

最大応答曲げモーメント (EW方向)

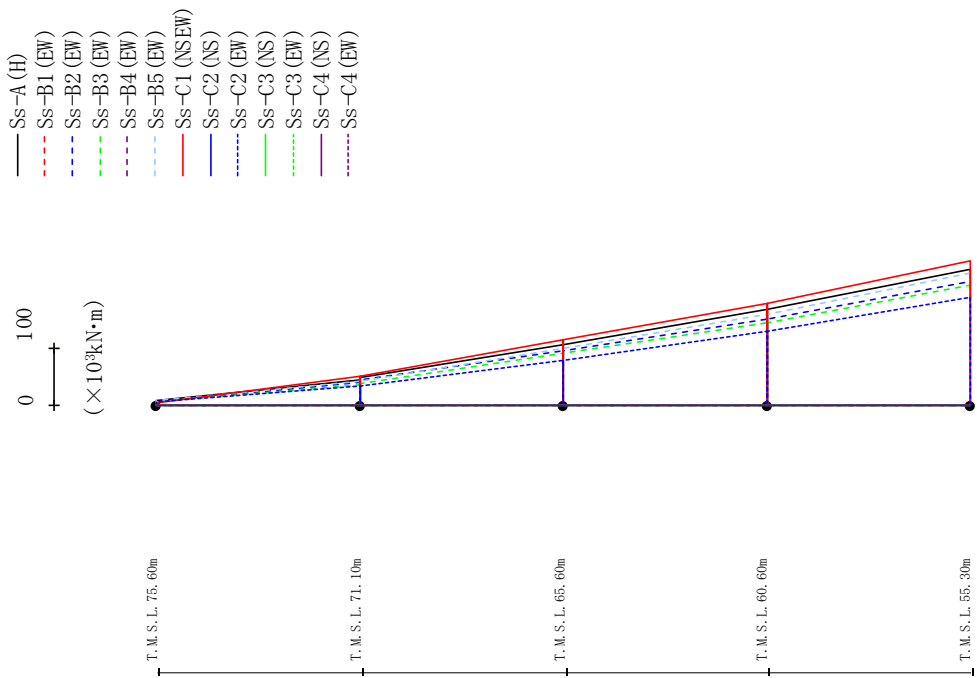

Ss-A (H)		Ss-B1 (EW)		Ss-B2 (EW)		Ss-B3 (EW)		Ss-B4 (EW)		Ss-B5 (EW)		Ss-C1 (NSEW)		Ss-C2 (NS)		Ss-C3 (NS)		Ss-C4 (NS)		Ss-C4 (EW)	
Ss-A (H)	Ss-B1 (EW)	Ss-B2 (EW)	Ss-B3 (EW)	Ss-B4 (EW)	Ss-B5 (EW)	Ss-C1 (NSEW)	Ss-C2 (NS)	Ss-C3 (NS)	Ss-C4 (NS)	Ss-C4 (EW)	Ss-C1 (NSEW)	Ss-C2 (NS)	Ss-C3 (NS)	Ss-C4 (NS)	Ss-C4 (EW)	Ss-C1 (NSEW)	Ss-C2 (NS)	Ss-C3 (NS)	Ss-C4 (NS)	Ss-C4 (EW)	
8.21	-	6.52	6.37	-	7.68	4.09	-	-	-	-	5.35	-	-	-	-	-	-	-	-	-	-
45.14	-	40.51	35.52	-	42.30	50.51	-	-	-	-	32.96	-	-	-	-	-	-	-	-	-	-
47.86	-	43.56	38.19	-	42.39	51.31	-	-	-	-	33.60	-	-	-	-	-	-	-	-	-	-
104.98	-	94.76	90.25	-	98.94	114.03	-	-	-	-	78.32	-	-	-	-	-	-	-	-	-	-
104.98	-	94.76	90.25	-	98.94	114.03	-	-	-	-	78.32	-	-	-	-	-	-	-	-	-	-
166.15	-	150.88	144.11	-	159.25	177.32	-	-	-	-	128.60	-	-	-	-	-	-	-	-	-	-
166.15	-	150.88	144.11	-	159.25	177.32	-	-	-	-	128.60	-	-	-	-	-	-	-	-	-	-
237.12	-	215.53	209.37	-	229.94	251.30	-	-	-	-	188.86	-	-	-	-	-	-	-	-	-	-

第4.2.2-23図 最大応答曲げモーメント (-1σ地盤, EW方向, 有効応力解析)

最大応答加速度 (UD方向)

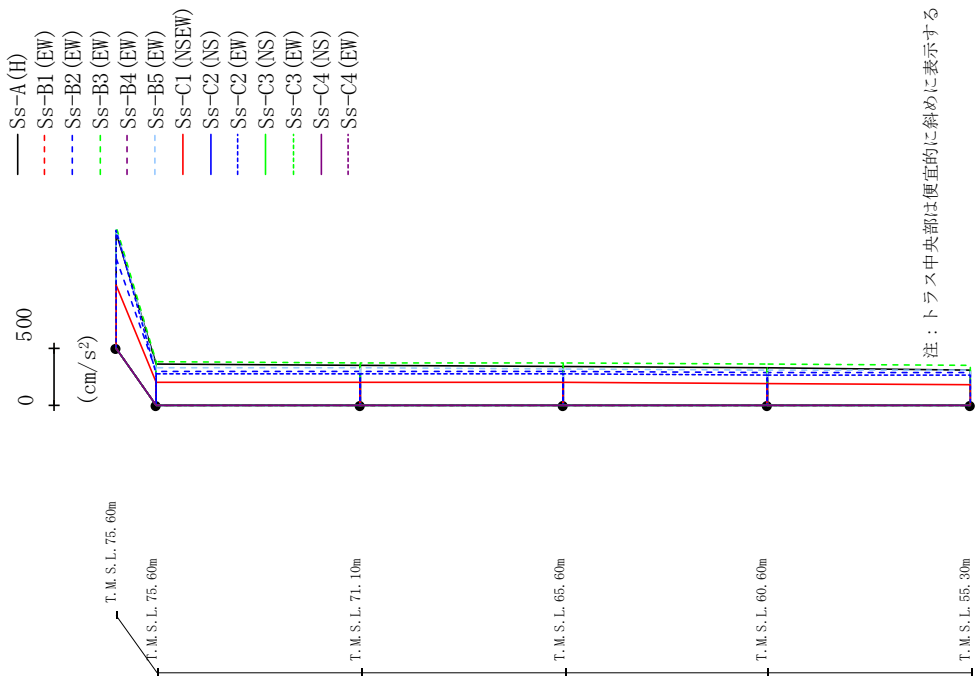

注：トラス中央部は便宜的に斜めに表示する

	Ss-A (H)	Ss-B1 (EW)	Ss-B2 (EW)	Ss-B3 (EW)	Ss-B4 (EW)	Ss-B5 (EW)	Ss-C1 (N/SEW)	Ss-C2 (NS)	Ss-C2 (EW)	Ss-C3 (NS)	Ss-C3 (EW)	Ss-C4 (NS)	Ss-C4 (EW)
998	-	781	1055	-	-	1030	542	-	1024	-	-	-	-
361	-	297	379	-	-	327	203	-	277	-	-	-	-
352	-	296	373	-	-	323	202	-	274	-	-	-	-
339	-	292	365	-	-	316	198	-	269	-	-	-	-
326	-	287	357	-	-	308	192	-	266	-	-	-	-
309	-	280	347	-	-	301	183	-	262	-	-	-	-

第4.2.2-24図 最大応答鉛直加速度 (-1σ地震, EW方向, 有効応力解析)

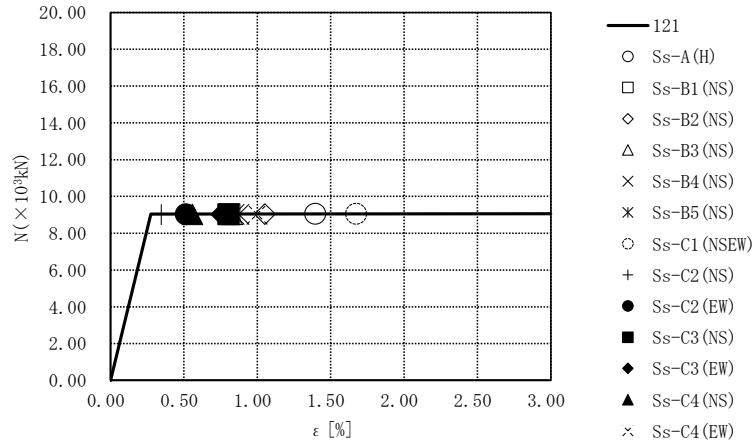

要素番号121

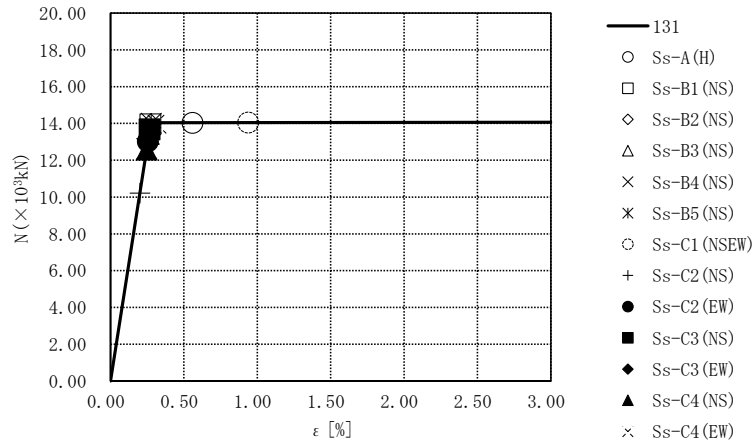

要素番号131

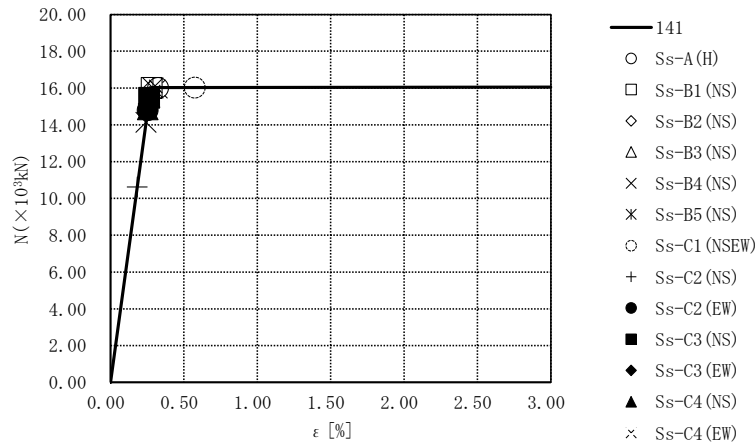

要素番号141

第4.2.2-25図 座屈拘束ブレースの荷重-ひずみ曲線
(基本ケース, NS方向, 有効応力解析)

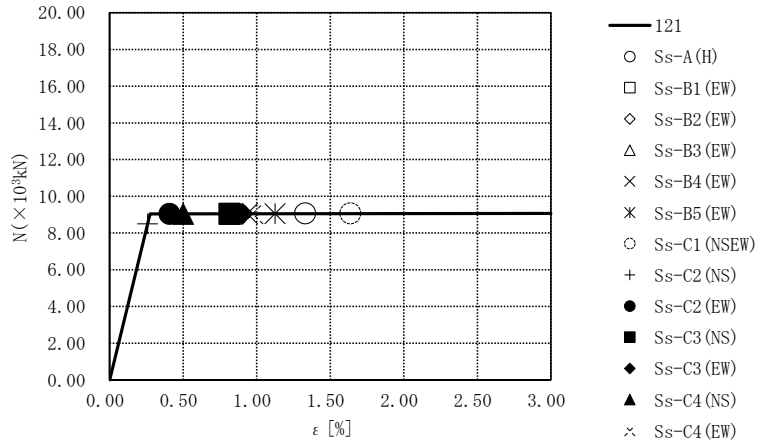

要素番号121

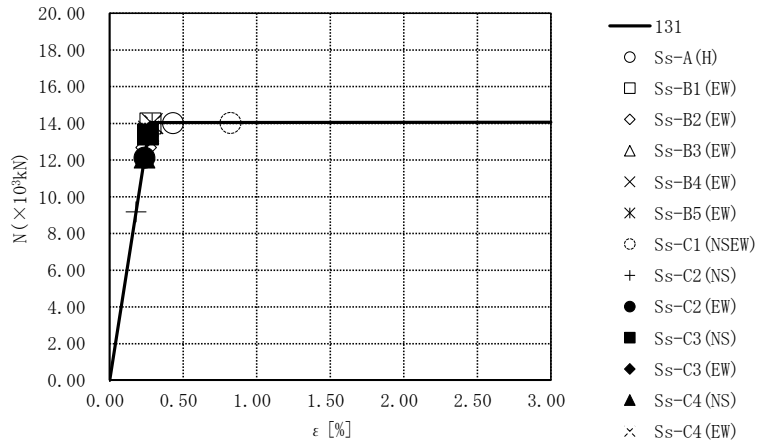

要素番号131

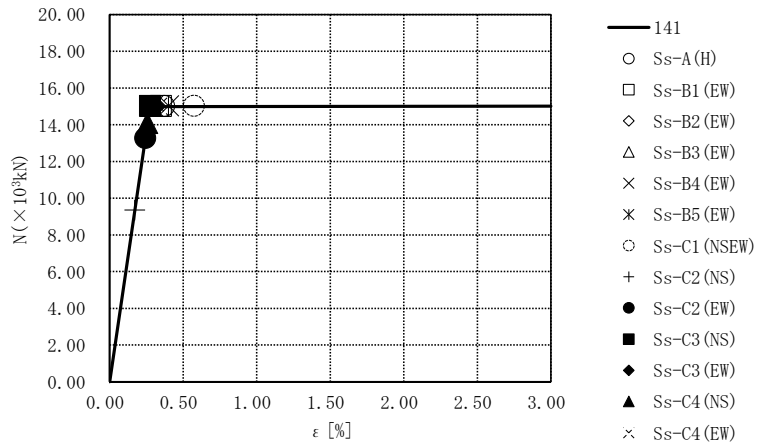

要素番号141

第4.2.2-26図 座屈拘束ブレースの荷重-ひずみ曲線
(基本ケース, EW方向, 有効応力解析)

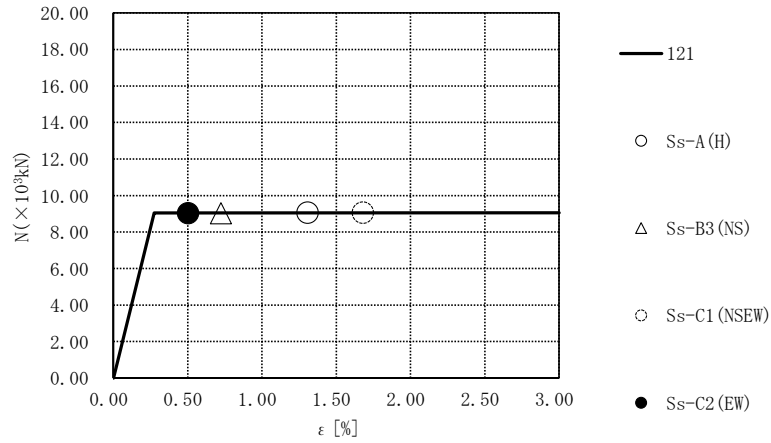

要素番号121

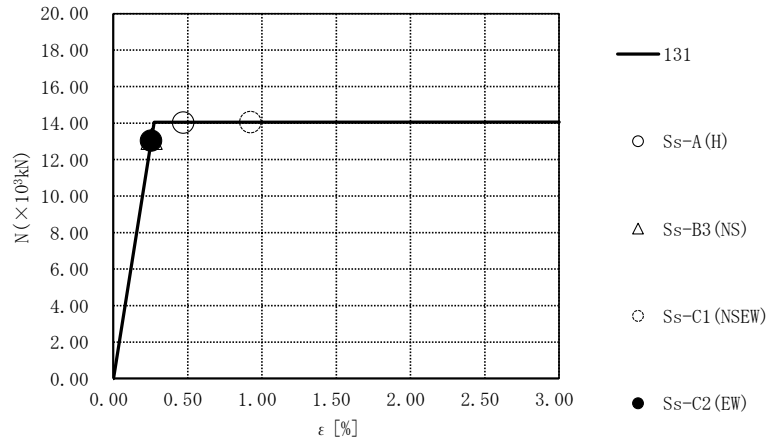

要素番号131

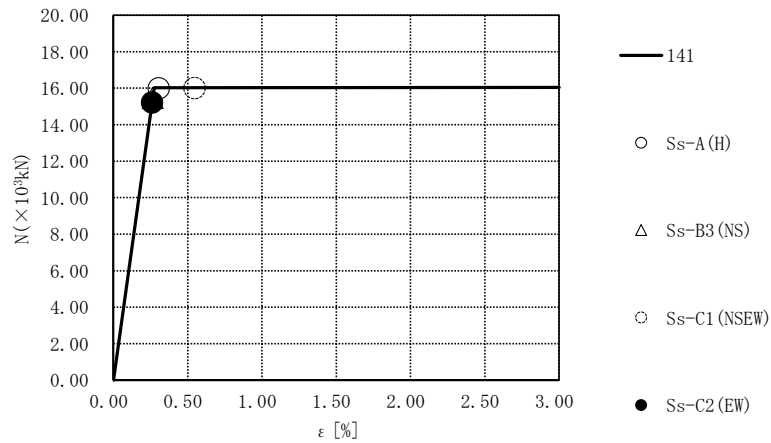

要素番号141

第4.2.2-27図 座屈拘束ブレースの荷重-ひずみ曲線
(+1 σ 地盤, NS方向, 有効応力解析)

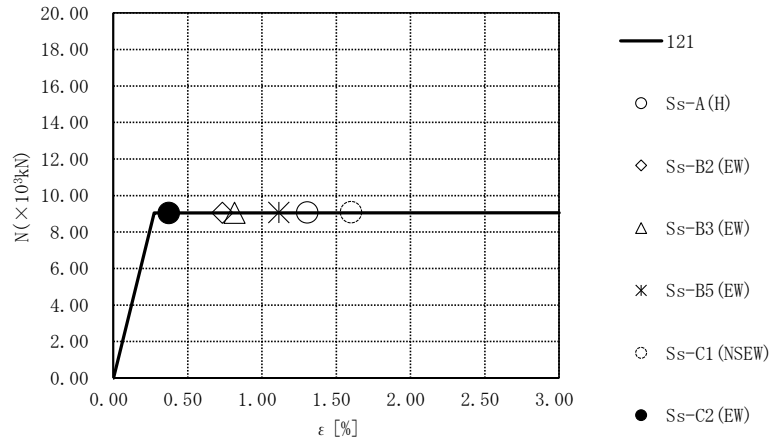

要素番号121

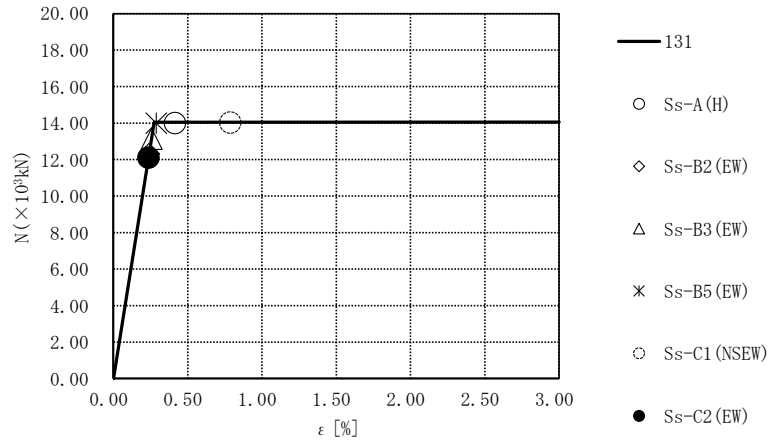

要素番号131

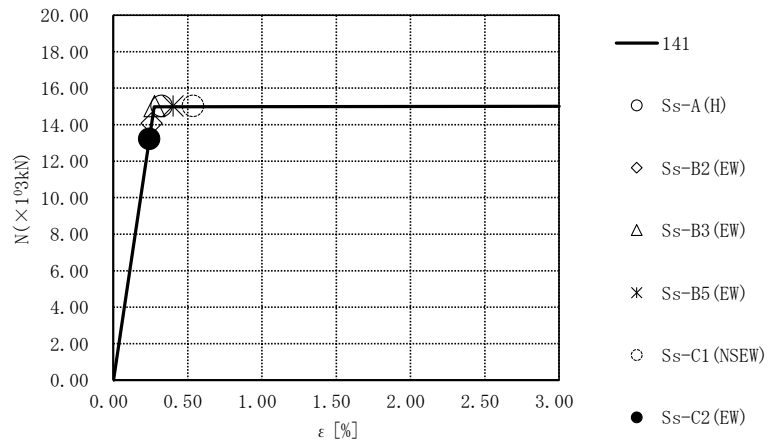

要素番号141

第4.2.2-28図 座屈拘束ブレースの荷重-ひずみ曲線
(+1 σ 地盤, EW方向, 有効応力解析)

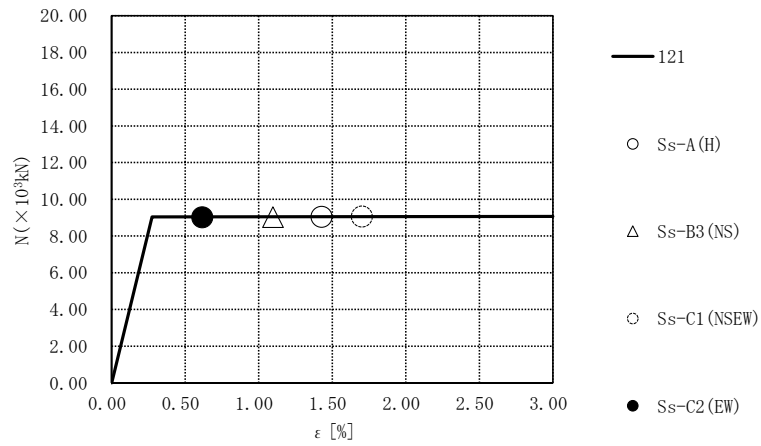

要素番号121

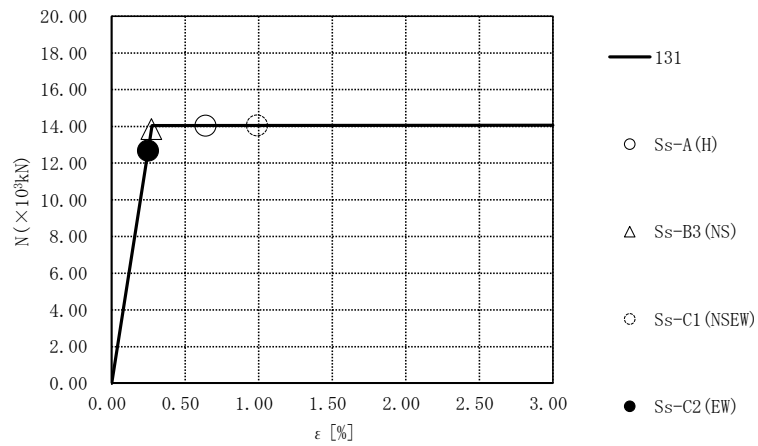

要素番号131

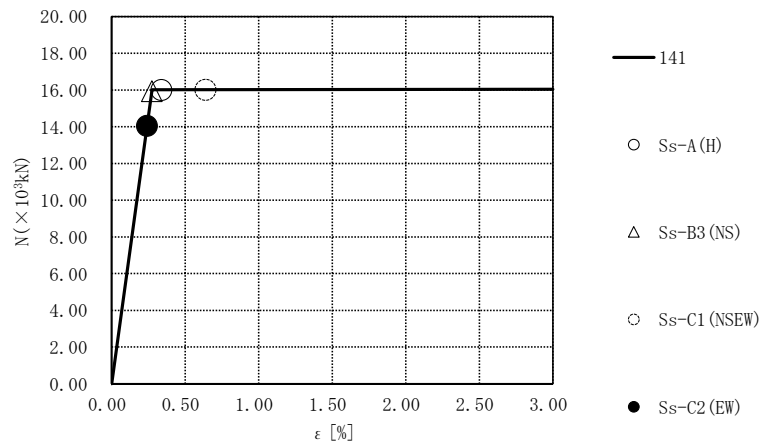

要素番号141

第4.2.2-29図 座屈拘束ブレースの荷重-ひずみ曲線
(-1σ 地盤, NS方向, 有効応力解析)

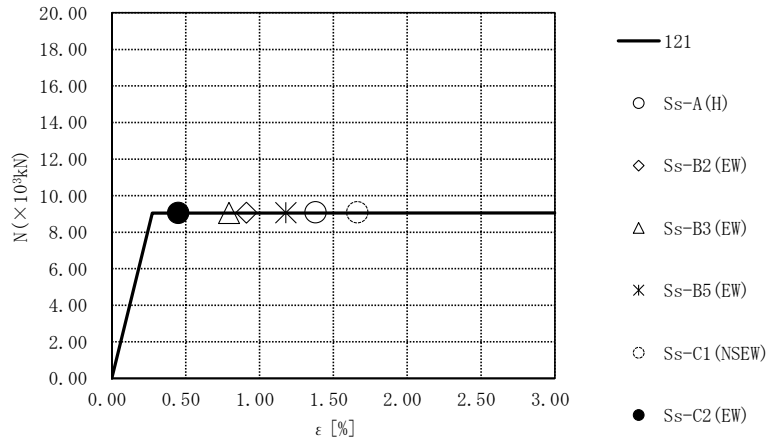

要素番号121

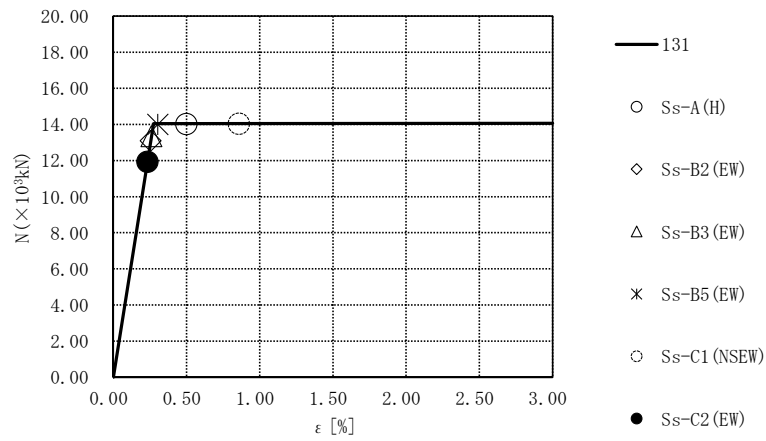

要素番号131

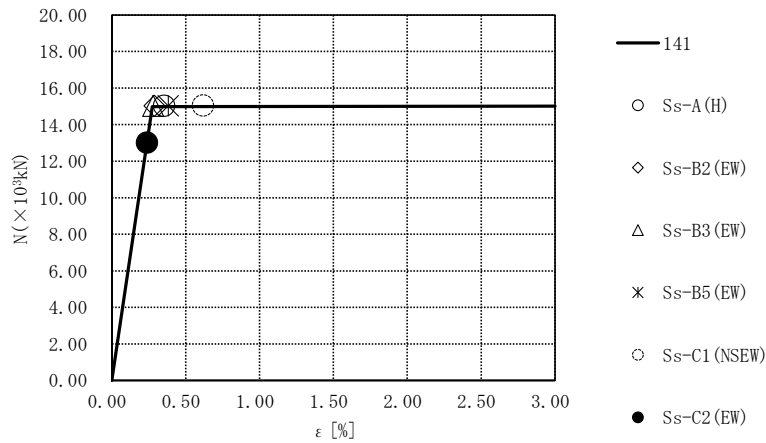

要素番号141

第4.2.2-30図 座屈拘束ブレースの荷重-ひずみ曲線
(-1σ 地盤, EW方向, 有効応力解析)

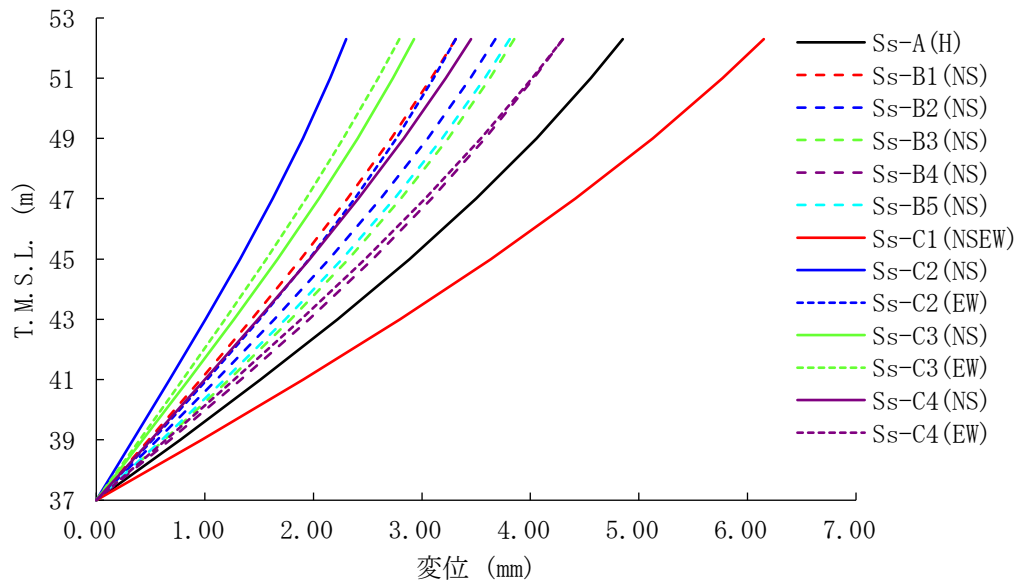

第4.2.2-31図 改良地盤の最大応答変位
(基本ケース, NS断面, 有効応力解析)

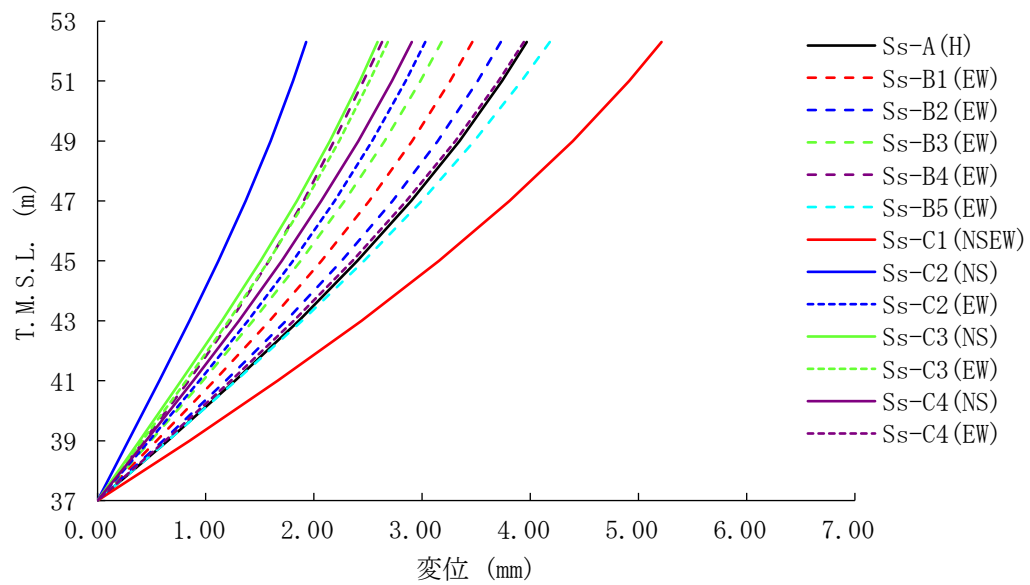

第4.2.2-32図 改良地盤の最大応答変位
(基本ケース, EW断面, 有効応力解析)

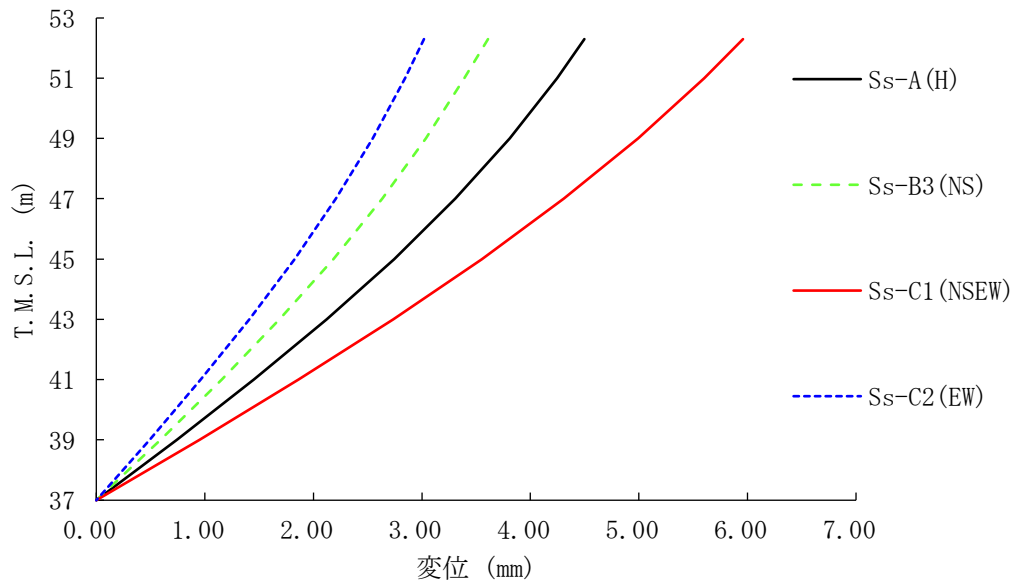

第4.2.2-33図 改良地盤の最大応答変位
(+1 σ 地盤, NS断面, 有効応力解析)

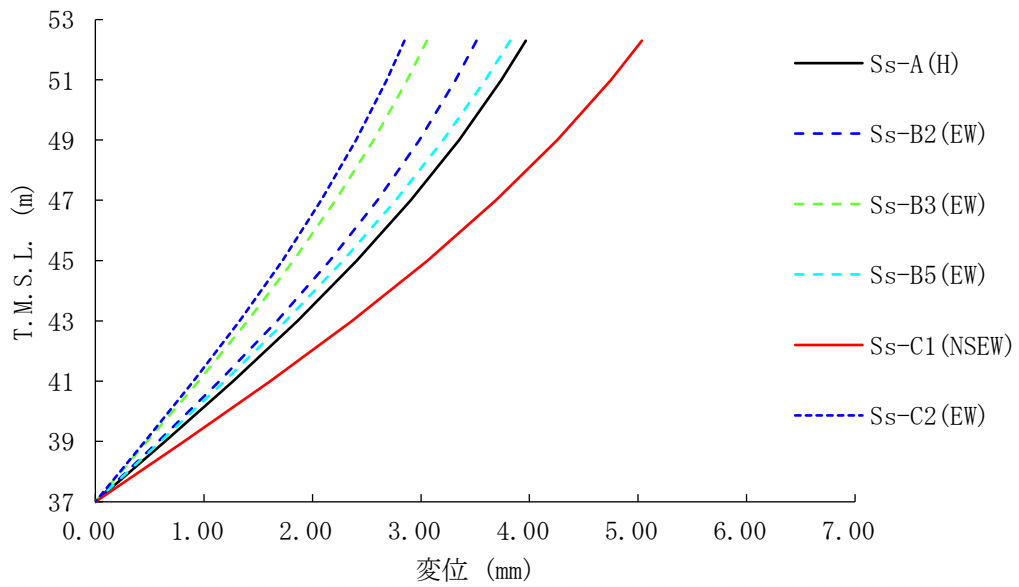

第4.2.2-34図 改良地盤の最大応答変位
(+1 σ 地盤, EW断面, 有効応力解析)

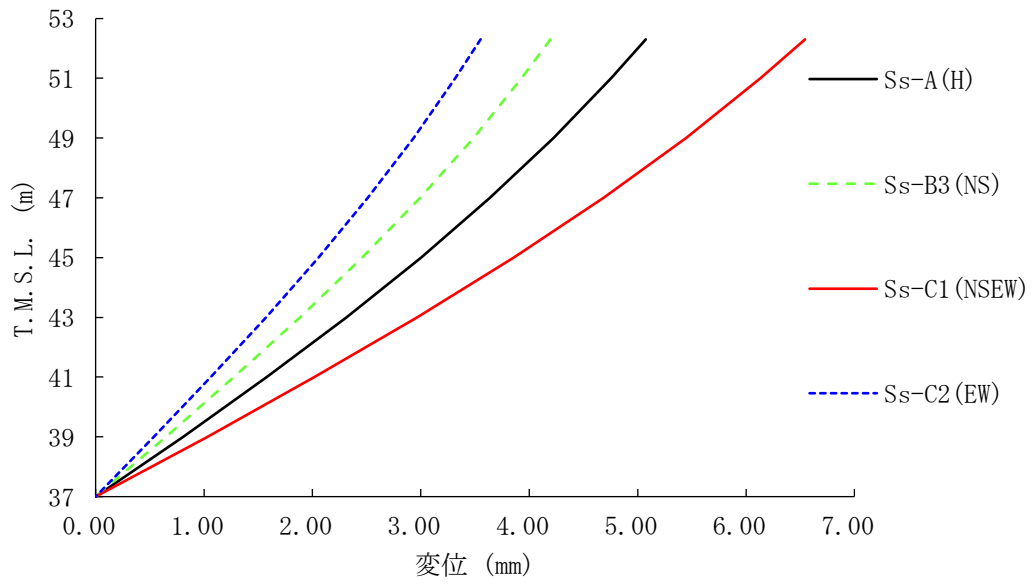

第4.2.2-35図 改良地盤の最大応答変位
(-1 σ 地盤, NS断面, 有効応力解析)

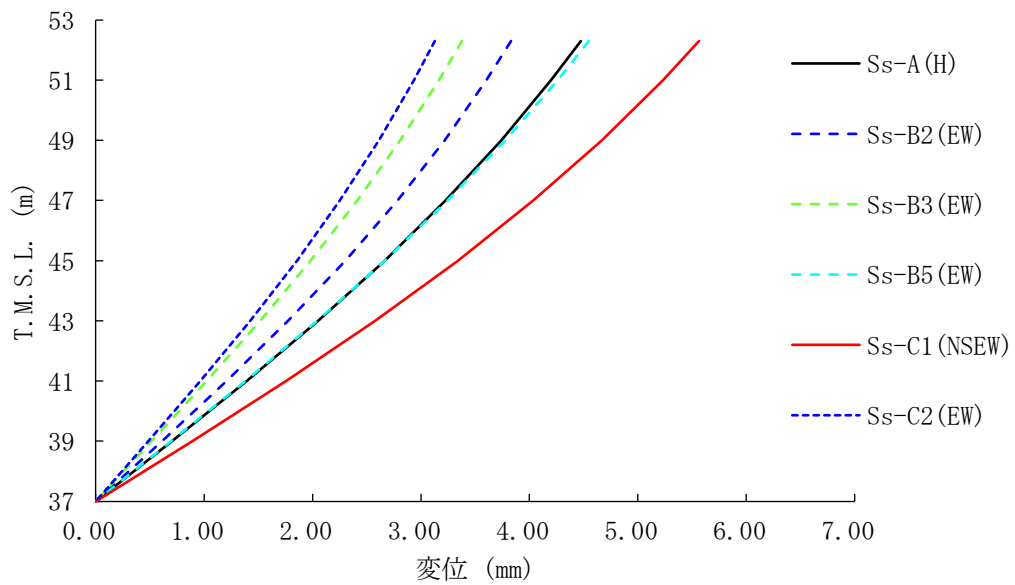

第4.2.2-36図 改良地盤の最大応答変位
(-1 σ 地盤, EW断面, 有効応力解析)

IV-2-2-2-1-2-1-2

飛来物防護ネット(再処理設備本体
用 安全冷却水系冷却塔 B)の耐震
計算書

目 次

	ページ
1. 概要	1
2. 基本方針	2
2.1 位置	2
2.2 構造概要	3
2.3 評価方針	10
2.4 準拠規格・基準等	12
3. 地震応答解析による評価方法	13
3.1 評価方針	13
3.2 評価方法	14
4. 応力解析による評価方法	16
4.1 評価対象部位及び評価方針	16
4.2 荷重及び荷重の組合せ	20
4.2.1 支持架構	21
4.2.2 基礎梁	22
4.2.3 杭	23
4.3 許容限界	24
4.4 評価方法	28
4.4.1 支持架構の評価方法	28
4.4.2 基礎梁の評価方法	38
4.4.3 杭の評価方法	45
5. 評価結果	49
5.1 地震応答解析による評価結果	49
5.2 応力解析による評価結果	51
5.2.1 支持架構の評価結果	51
5.2.2 基礎梁の評価結果	55
5.2.3 杭の評価結果	59

1. 概要

本資料は、添付書類「IV-2-2-1 波及的影響を及ぼすおそれのある下位クラス施設の耐震評価方針」に基づき、屋外に設置される安全上重要な施設である竜巻防護対象施設を防護するための設備である飛来物防護ネット(再処理設備本体用 安全冷却水系冷却塔B)(以下、「飛来物防護ネット架構」という。)が基準地震動 S_s により安全冷却水B冷却塔(以下、「冷却塔」という。)に対して波及的影響を及ぼさないことを確認するものである。

2. 基本方針

2.1 位置

飛来物防護ネット架構の設置位置を第2.1-1図に示す。

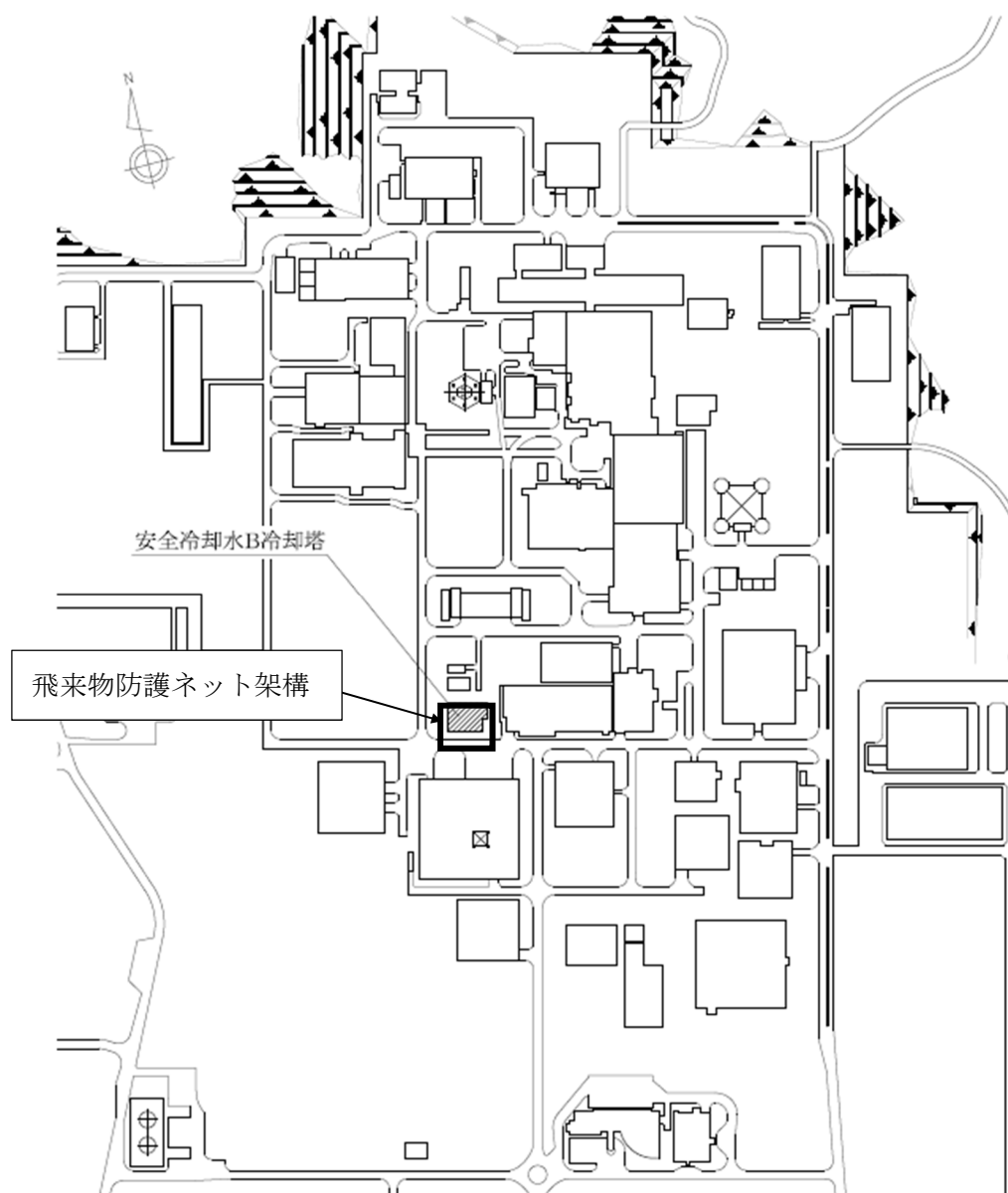

第2.1-1図 飛来物防護ネット架構の設置位置

2.2 構造概要

飛来物防護ネット架構は、鉄骨造の支持架構、鉄筋コンクリート造の基礎梁及び杭によって構成される。

支持架構は、柱、大はり、小はり、トラス柱、鉛直ブレース及び水平ブレースからなるフレーム及び座屈拘束ブレースによって構成され、平面形状は、36.00m(NS方向)×47.90m(EW方向)であり、地上高さは、20.30mである。

座屈拘束ブレースは、中心鋼材を座屈拘束材(鋼管とモルタル)で拘束し、繰り返し作用する地震荷重に対して、安定的に塑性化することでエネルギーを吸収することにより、フレームに作用する荷重を低減するものであり、支持架構にねじれが生じないように配置している。なお、採用した座屈拘束ブレースは、平成12年建設省告示1461号の制振部材及び平成17年国土交通省告示第631号のエネルギー吸収部材に係る評定を受けたものである。

基礎梁は厚さ3.00mの鉄筋コンクリート造であり、支持地盤である岩盤に場所打ちコンクリート杭(外径1.00m及び1.50m、杭長16.80m及び17.80m、113本)を介して設置している。また、液状化対策として飛来物防護ネット架構下部の支持地盤以浅の地盤はセメント系の地盤改良を実施している。

なお、飛来物防護ネット架構は防護対象となる冷却塔と構造的に分離している。

支持架構の全景を第2.2-1図に、屋根伏図及び杭伏図を第2.2-2図に、概略側面図を第2.2-3図に、基礎梁及び杭の断面図を第2.2-4図に示す。

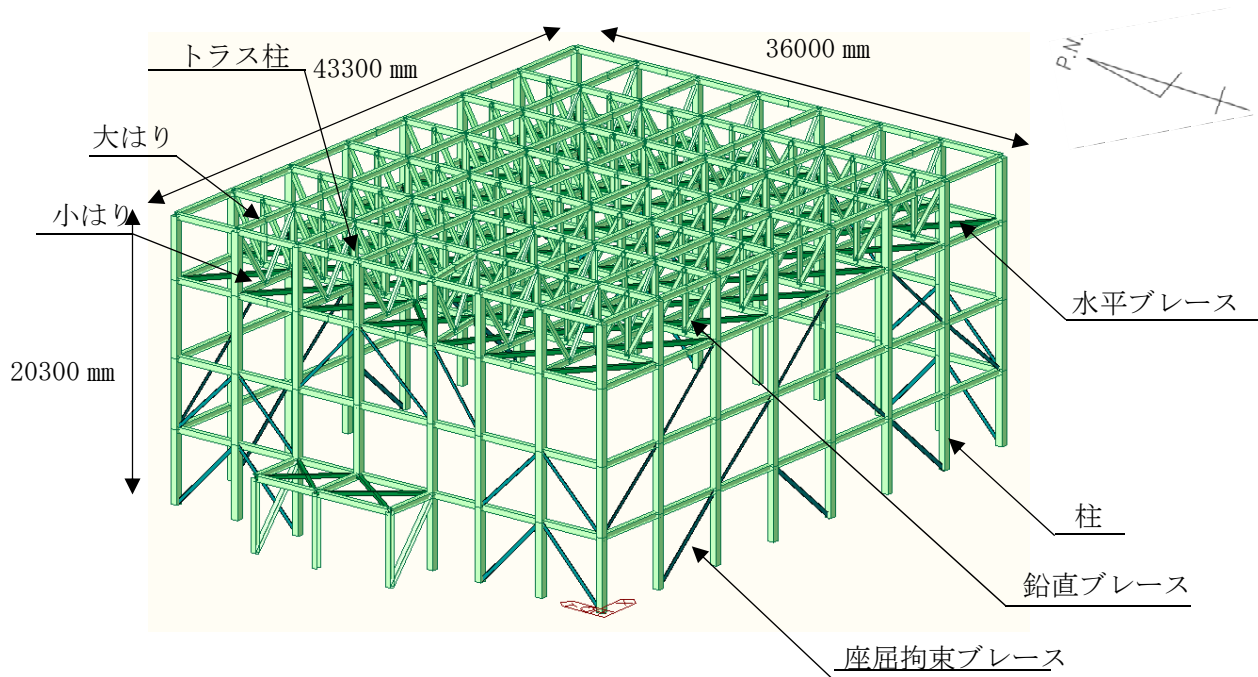

第2.2-1図 支持架構の全景

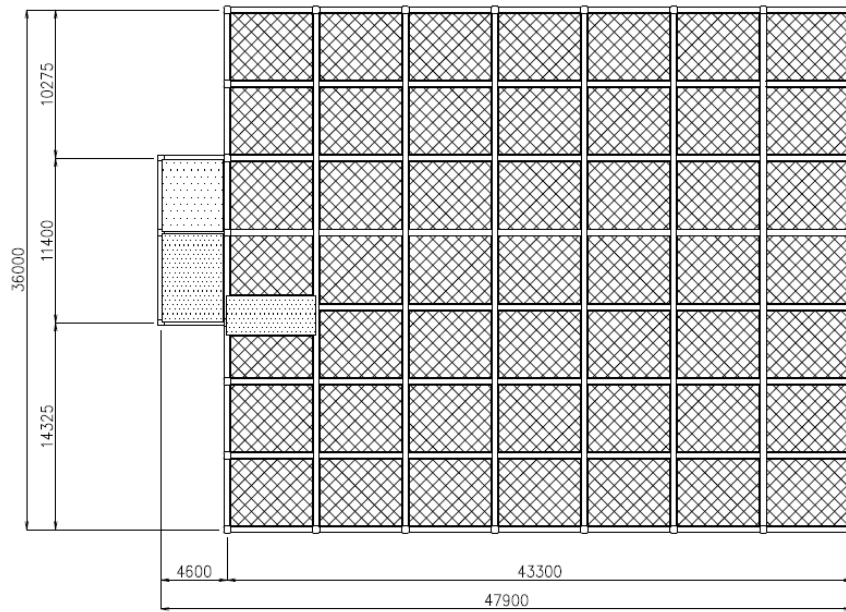

(a) 屋根伏図

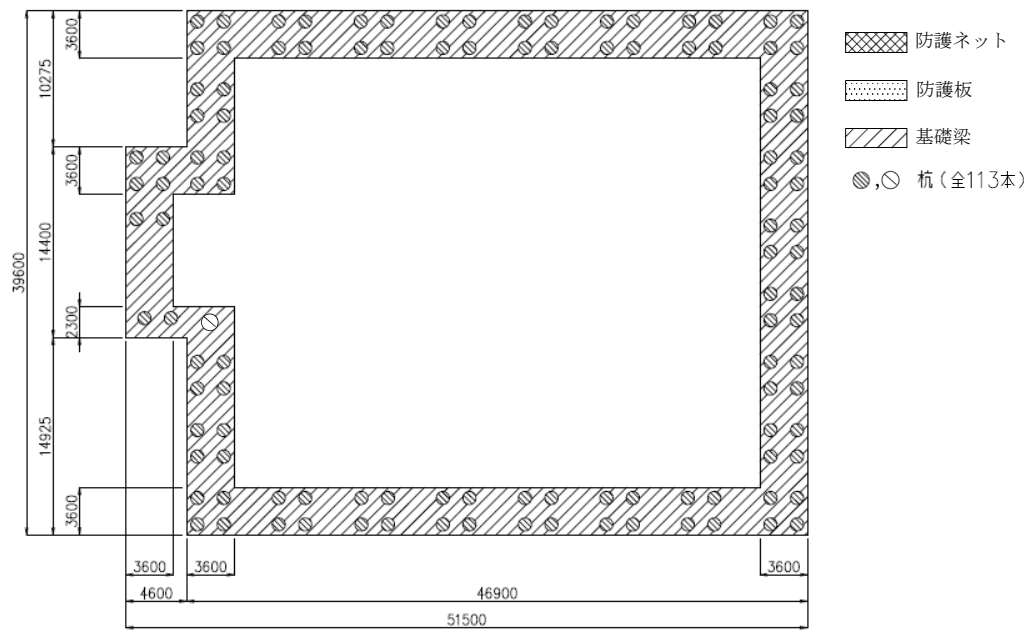

(b) 杭伏図

(単位：mm)

第2.2-2図 飛来物防護ネット架構の屋根伏図及び杭伏図

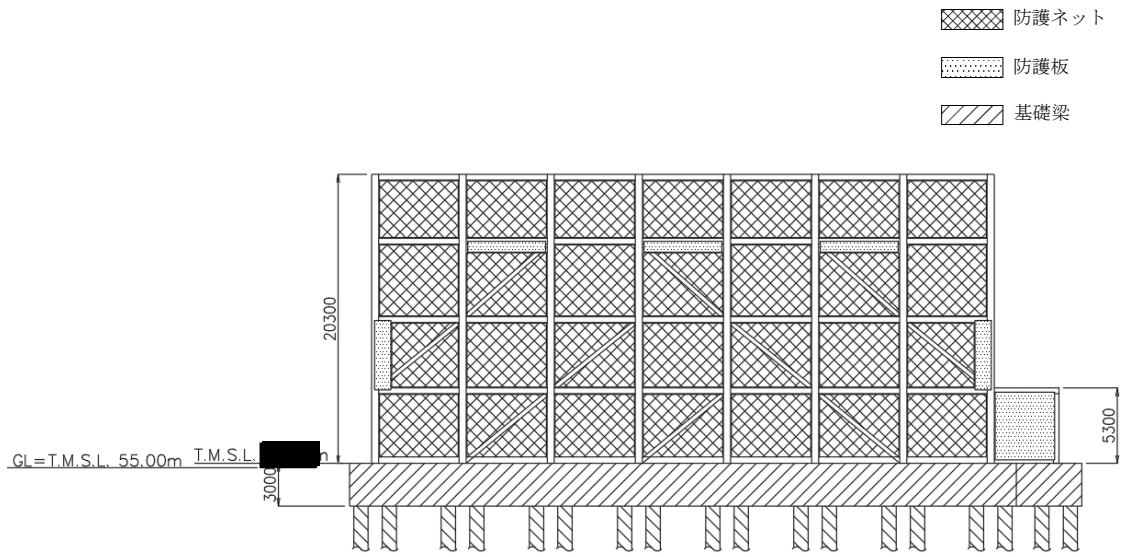

(a) 北面

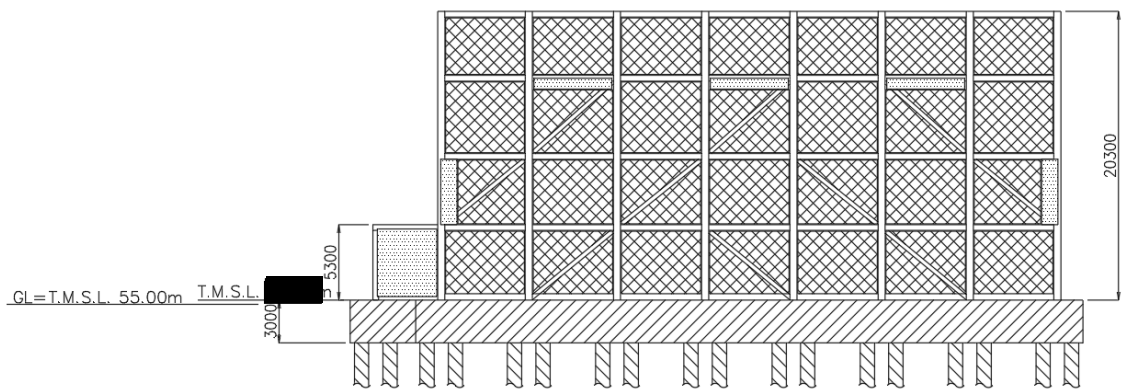

(b) 南面

(単位：mm)

第2.2-3図 飛来物防護ネット架構の概略側面図(1/2)

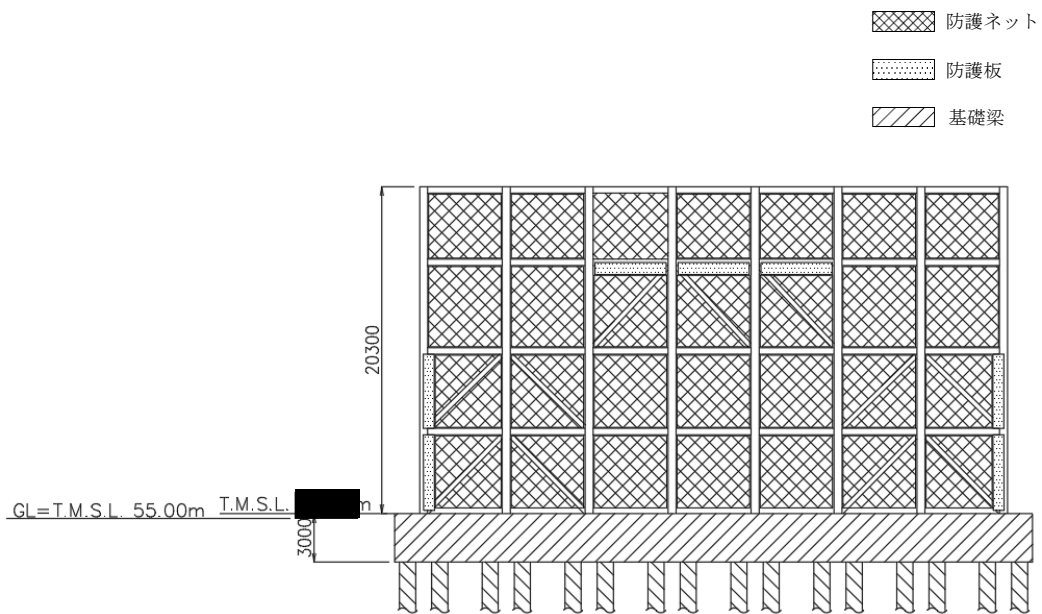

(c) 東面

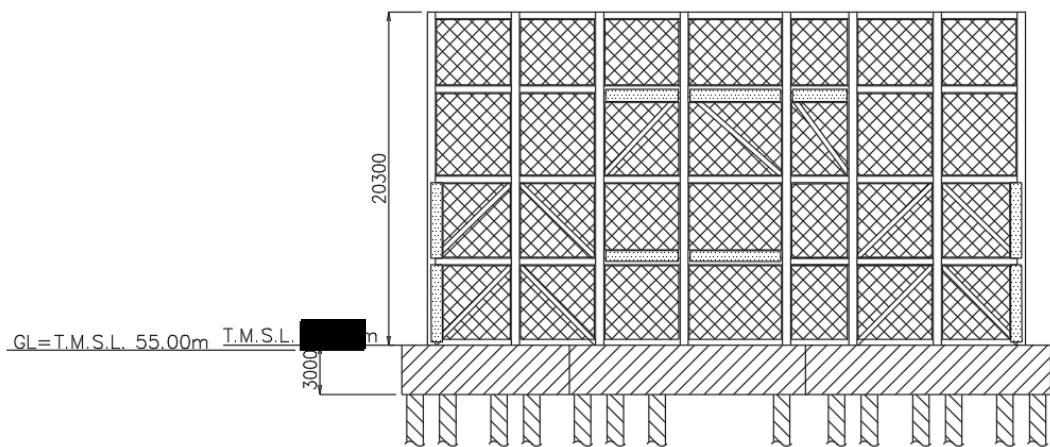

(d) 西面

(単位 : mm)

第2.2-3図 飛来物防護ネット架構の概略側面図(2/2)

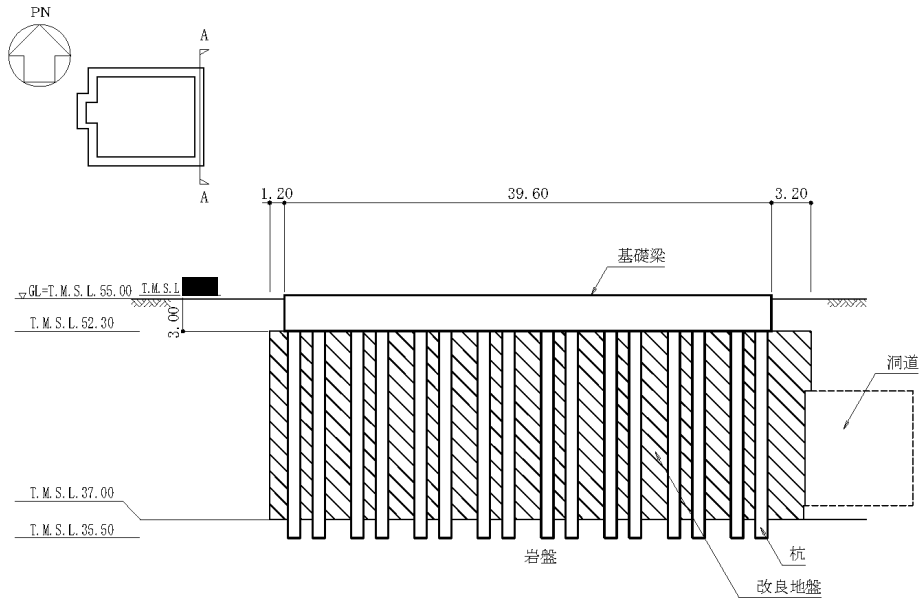

(a) A-A 断面図 (NS 方向)

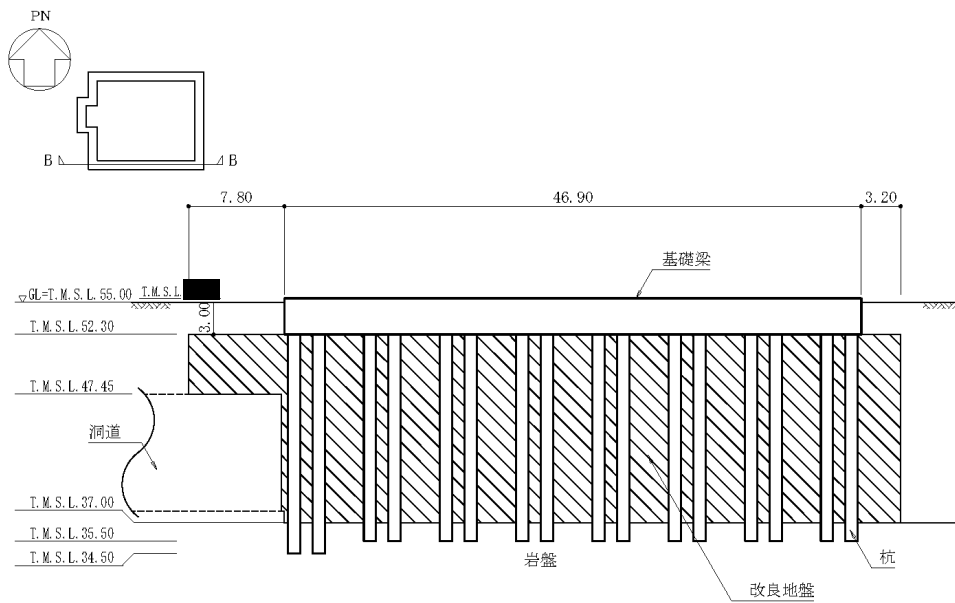

(b) B-B 断面図 (EW 方向)

(単位 : m)

第2.2-4図 基礎梁及び杭の断面図(1/2)

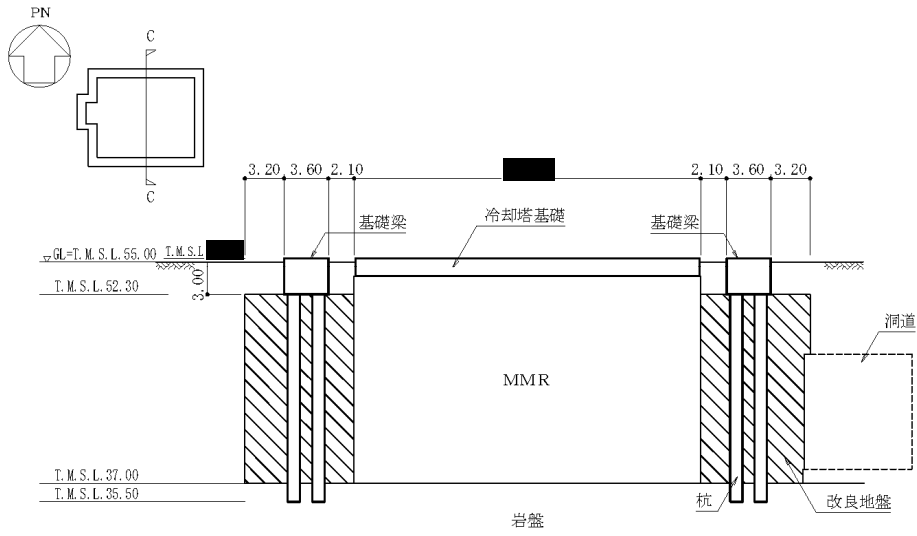

(c) C-C 断面図 (NS 方向)

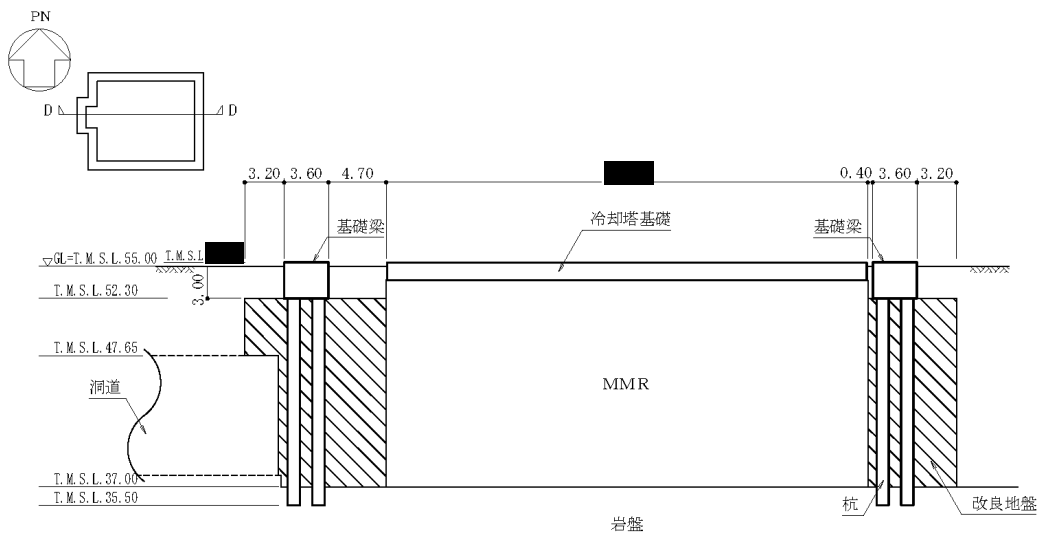

(d) D-D 断面図 (EW 方向)

(単位 : m)

第2.2-4図 基礎梁及び杭の断面図 (2/2)

2.3 評価方針

飛来物防護ネット架構の波及的影響評価においては、基準地震動 S_s による地震力(以下、「 S_s 地震時」という。)に対する評価を行うこととする。評価は、添付書類「IV-2-2-2-1-2-1-1 飛来物防護ネット(再処理設備本体用 安全冷却水系冷却塔B)の地震応答計算書」の結果を踏まえたものとする。飛来物防護ネット架構の波及的影響評価は、添付書類「IV-2-2-1 波及的影響を及ぼすおそれのある下位クラス施設の耐震評価方針」に基づき、地震応答解析及び応力解析により施設の損傷、転倒及び落下の観点並びに相対変位の観点で冷却塔への波及的影響の評価を行う。評価に当たっては地盤物性のばらつきを考慮する。

地震応答解析による評価においては、座屈拘束ブレースの評価を、応力解析による評価においては、支持架構、基礎梁及び杭の評価を行う。支持架構の評価における相対変位に対する評価においては、添付書類「IV-2-1-2-1-1-1 安全冷却水B冷却塔の耐震計算書」の結果を踏まえた評価を行う。

飛来物防護ネット架構の波及的影響評価フローを第2.3-1図に示す。

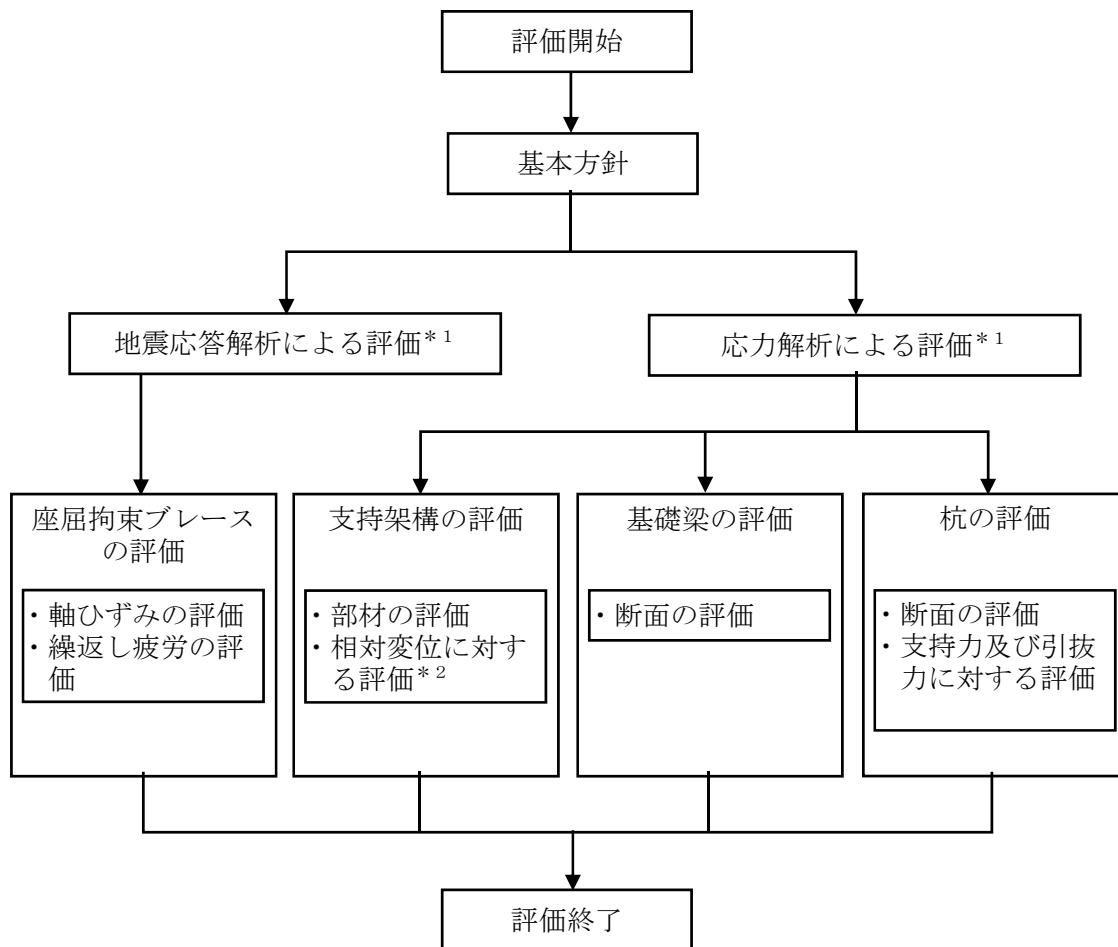

注記 *1 : 添付書類「IV-2-2-2-2-1-2-1-1 飛来物防護ネット(再処理設備 本体用 安全冷却水系冷却塔B)の地震応答計算書」の結果を踏まえた評価を行う。

*2 : 添付書類「IV-2-1-2-1-1-1 安全冷却水B冷却塔の耐震計算書」の結果を踏まえた評価を行う。

第2.3-1図 飛来物防護ネット架構の波及的影響評価フロー

2.4 準拠規格・基準等

飛来物防護ネット架構の波及的影響評価において、準拠する規格・基準等を以下に示す。

- ・ 建築基準法・同施行令・同告示
- ・ 日本産業規格
- ・ 鋼構造設計規準((社)日本建築学会, 2005)(以下, 「S規準」という。)
- ・ 鉄筋コンクリート構造計算規準・同解説 ―許容応力度設計法― ((社)日本建築学会, 1999)
- ・ 原子力施設鉄筋コンクリート構造計算規準・同解説 ((社)日本建築学会, 2005)(以下, 「RC-N規準」という。)
- ・ 建築基礎構造設計指針((社)日本建築学会, 2001)(以下, 「基礎指針」という。)
- ・ 原子力発電所耐震設計技術指針 JEAG4601-1987((社)日本電気協会)
- ・ 原子力発電所耐震設計技術指針 重要度分類・許容応力編 JEAG4601・補-1984 ((社)日本電気協会)
- ・ 原子力発電所耐震設計技術指針 JEAG4601-1991 追補版((社)日本電気協会)

3. 地震応答解析による評価方法

3.1 評価方針

地震応答解析による評価は、添付書類「IV-2-2-2-1-2-1-1 飛来物防護ネット(再処理設備本体用 安全冷却水系冷却塔B)の地震応答計算書」に基づき、地盤物性のばらつきを考慮した座屈拘束ブレースの軸ひずみ及び繰返し疲労が許容限界を超えないことを確認する。

地震応答解析による評価における飛来物防護ネット架構の許容限界は、添付書類「IV-2-2-1 波及的影響を及ぼすおそれのある下位クラス施設の耐震評価方針」に記載の許容限界に基づき、第3.1-1表のとおり設定する。

第3.1-1表 地震応答解析による評価における許容限界

設計の観点	地震力	部位	許容限界設定の考え方	許容限界 (評価基準値)
損傷、転倒 及び落下	基準地震動 S s	座屈拘束 ブレース	軸ひずみが施設の構造を保つための許容限界を超えないことを確認	軸ひずみ 3.0%*
			繰返し疲労が施設の構造を保つための許容限界を超えないことを確認	疲労係数総和 1

注記 *：日本建築センターの評定書（BCJ評定-ST0126-06）に基づき設定する。

3.2 評価方法

軸ひずみの評価については、地震応答解析にて算出される軸ひずみの時刻歴から最大軸ひずみを算出し、許容限界である3.0%を超えないことを確認する。

繰返し疲労の評価については、地震応答解析にて算出される軸ひずみの時刻歴を用いて、座屈拘束ブレースの疲労性能曲線からひずみ振幅を5種類に分類して疲労係数を算出し、許容限界である疲労係数総和1を超えないことを確認する。座屈拘束ブレースの疲労性能曲線を第3.2-1図に、疲労係数算出方法を第3.2-1表に示す。

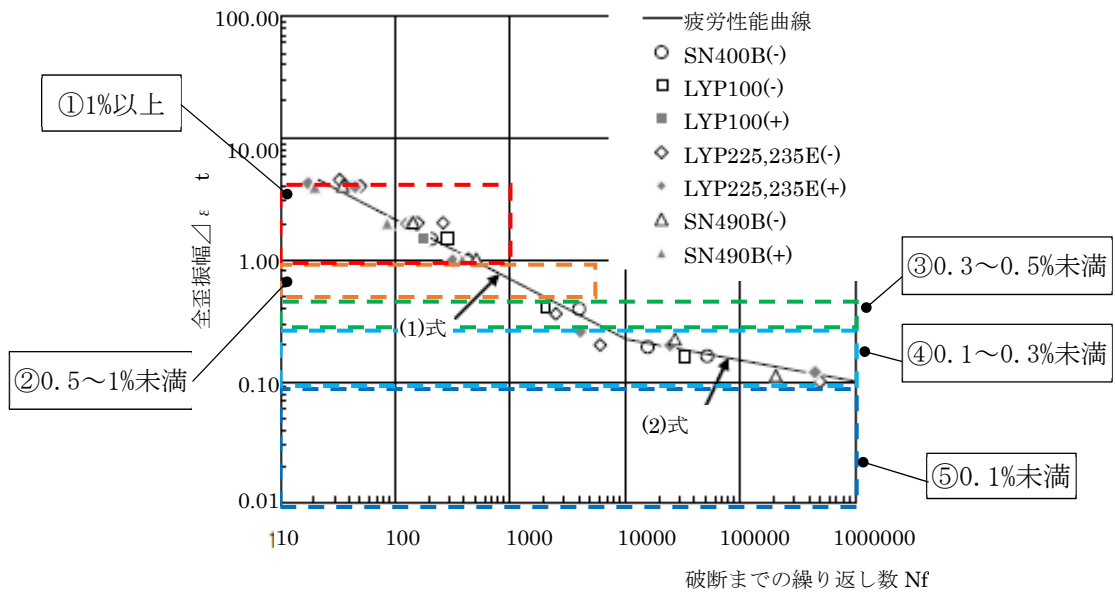

第3.2-1図 座屈拘束ブレースの疲労性能曲線

第3.2-1表 疲労係数算出方法

分類(ひずみ振幅)		疲労係数算出方法
①	1%以上	1%以上のひずみ振幅回数を算出し、最大ひずみ振幅の許容繰返し回数に対する比率を算出。
②	0.5%以上、1%未満	0.5%以上、1%未満のひずみ振幅回数を算出し、1%ひずみ振幅の許容繰返し回数に対する比率を算出。
③	0.3%以上、0.5%未満	0.3%以上、0.5%未満のひずみ振幅回数を算出し、0.5%ひずみ振幅の許容繰返し回数に対する比率を算出。
④	0.1%以上、0.3%未満	0.1%以上、0.3%未満のひずみ振幅回数を算出し、0.3%ひずみ振幅の許容繰返し回数に対する比率を算出。
⑤	0.1%未満(疲労限以下)	疲労評価の対象外とする。*

注記 * : 許容繰返し回数(100万回以上)が非常に大きいことから疲労評価の対象外とする。

4. 応力解析による評価方法

4.1 評価対象部位及び評価方針

飛来物防護ネット架構の応力解析による評価対象部位は、支持架構、基礎梁及び杭とし、S_s地震時に対して以下の方針に基づき評価を行う。

応力解析に当たっては、添付書類「IV-2-2-2-1-2-1-1 飛来物防護ネット(再処理設備本体用 安全冷却水系冷却塔B)の地震応答計算書」より得られた結果を用いて、荷重の組合せを行う。また、地震荷重の設定においては、地盤物性のばらつきを考慮する。

支持架構の評価は、3次元フレームモデルを用いた静的弾塑性応力解析によることとし、地震力と地震力以外の荷重の組合せの結果、発生する応力が「S規準」に基づき設定した終局強度を超えないこと及び相対変位が施設間の離隔距離を超えないことを確認する。相対変位に対する評価においては、添付書類「IV-2-1-2-1-1-1 安全冷却水B冷却塔の耐震計算書」より得られた結果を用いる。

基礎梁の評価は、FEMモデルを用いた静的弾性応力解析によることとし、地震力と地震力以外の荷重の組合せの結果、発生する応力が「RC-N規準」に基づき設定した許容限界を超えないことを確認する。

杭の評価は、地震応答解析結果を用いた応力解析、地震応答解析結果及び支持架構の評価結果を用いた応力計算並びに基礎梁の評価結果により応力を算定し、組み合わせた応力が「基礎指針」に基づき設定した許容限界を超えないことを確認する。

支持架構、基礎梁及び杭の応力解析による評価フローを、それぞれ第4.1-1図、第4.1-2図及び第4.1-3図に示す。

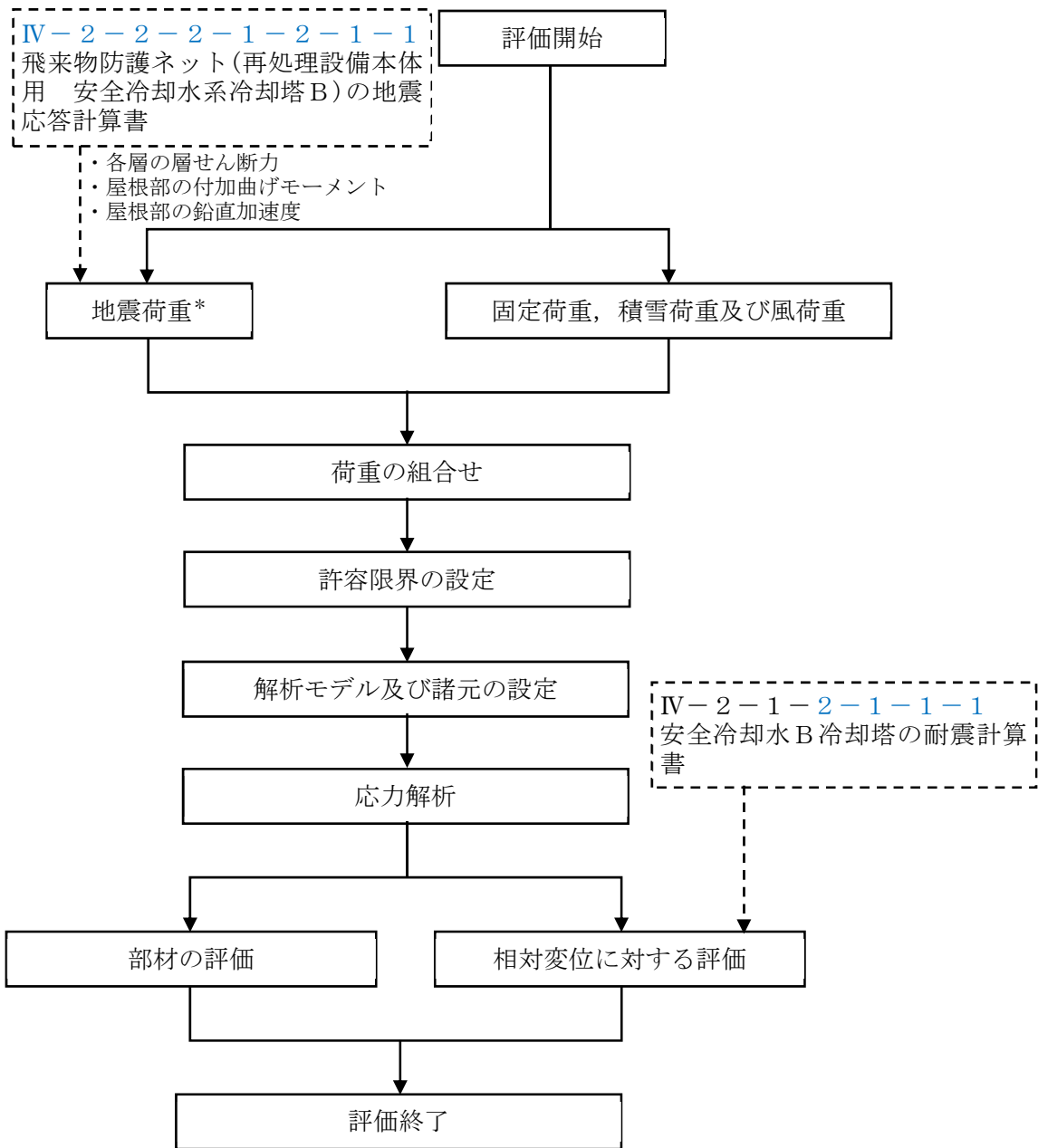

注記 * : 地盤物性のばらつきを考慮する。

第4.1-1図 支持架構の応力解析による評価フロー

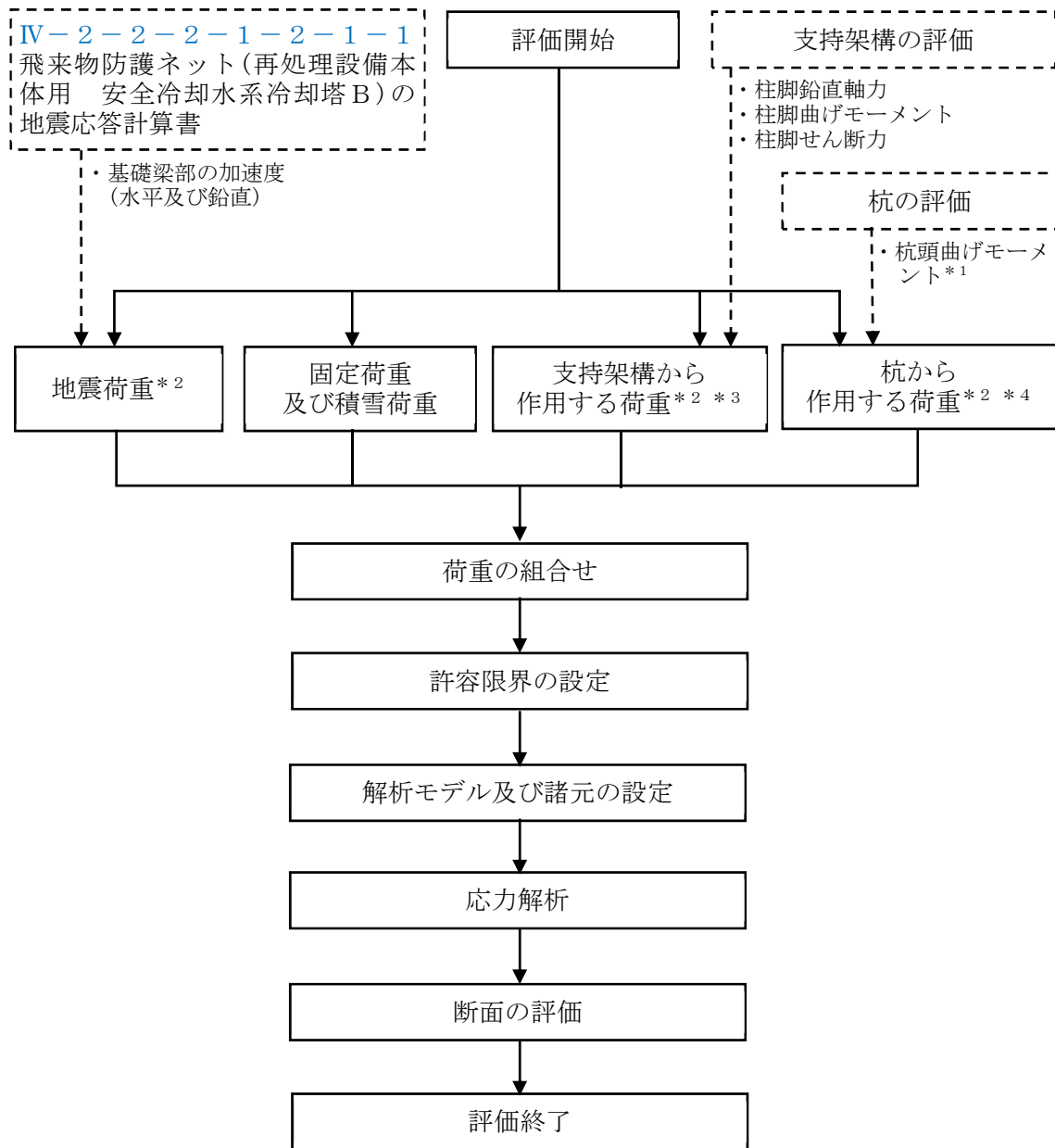

- 注記 * 1 : 第4.1-3図における「応力解析」及び「応力計算」により算定する杭の「曲げモーメント」のうち、杭頭の曲げモーメントを用いる。
- * 2 : 地盤物性のばらつきを考慮する。
- * 3 : 固定荷重，積雪荷重，地震荷重及び風荷重を含む。
- * 4 : 地震荷重及び風荷重を含む。

第4.1-2図 基礎梁の応力解析による評価フロー

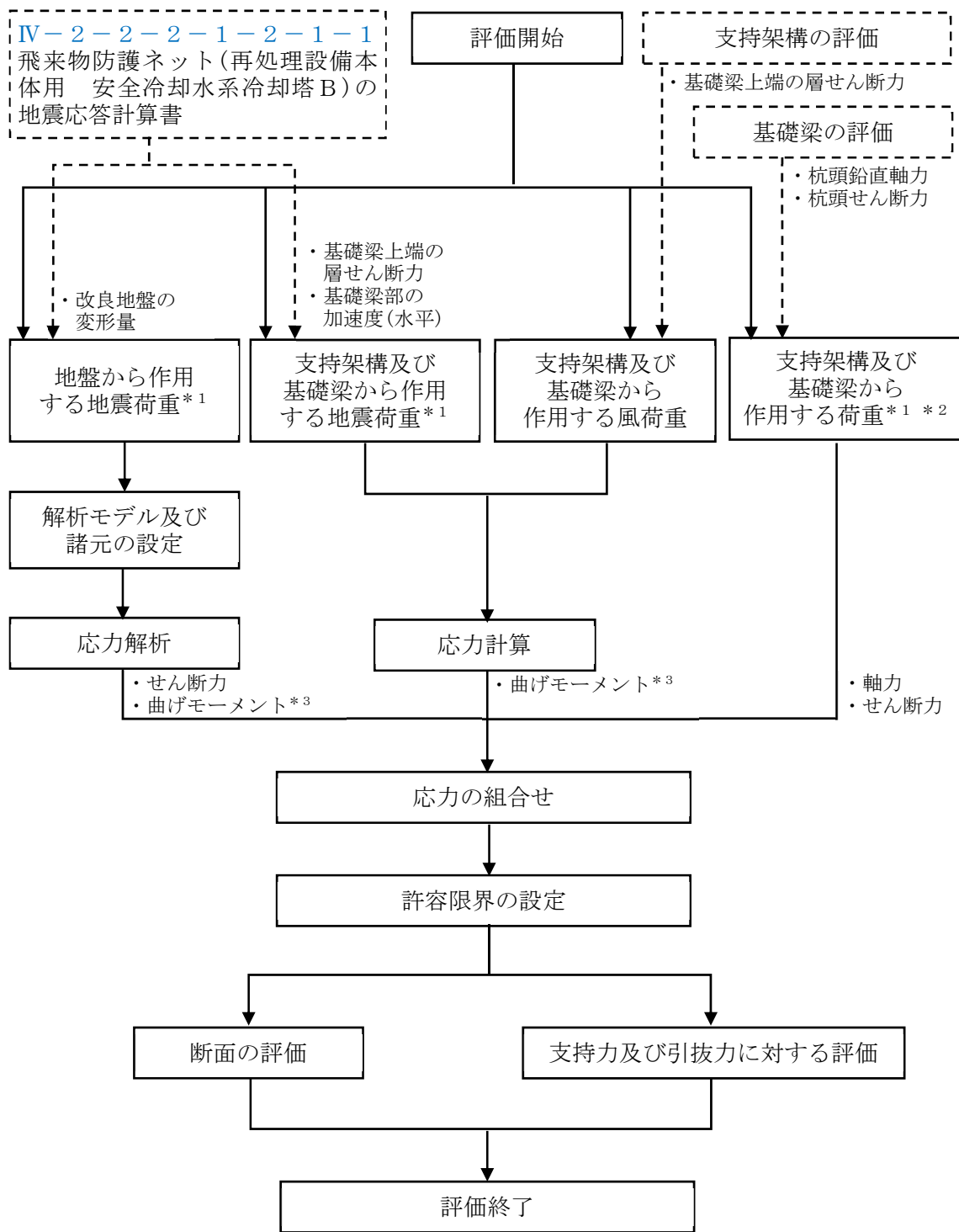

注記 *1 : 地盤物性のばらつきを考慮する。

*2 : 固定荷重, 積雪荷重, 地震荷重及び風荷重を含む。

*3 : これらの「曲げモーメント」のうち杭頭の曲げモーメントを第4.1-2図における「杭頭曲げモーメント」に用いる。

第4.1-3図 杭の応力解析による評価フロー

4.2 荷重及び荷重の組合せ

各部位の評価における荷重及び荷重の組合せは、添付書類「IV-2-2-1 波及的影響を及ぼすおそれのある下位クラス施設の耐震評価方針」にて設定している荷重及び荷重の組合せを用いる。

4.2.1 支持架構

支持架構の評価において考慮する荷重を第4.2.1-1表に、荷重の組合せを第4.2.1-2表に示す。

第4.2.1-1表 考慮する荷重

荷重名称	内容
固定荷重(D)	構造物(支持架構等)の自重
積雪荷重(Ls)	積雪量190cm 地震荷重と組み合わせる場合は0.35の係数を乗じた値とする。
地震荷重(Ss)	地震応答解析結果による地震荷重 <ul style="list-style-type: none"> ・各層の層せん断力 ・屋根部の付加曲げモーメント ・屋根部の鉛直加速度より設定する鉛直震度
風荷重(W _L)	建築基準法・同施行令・同告示による風荷重

第4.2.1-2表 荷重の組合せ

外力の状態	荷重の組合せ
S s 地震時	$D + 0.35L_s + S_s + W_L$

4.2.2 基礎梁

基礎梁の評価において考慮する荷重を第4.2.2-1表に、荷重の組合せを第4.2.2-2表に示す。

第4.2.2-1表 考慮する荷重

荷重名称	内容
固定荷重(D)	構造物(基礎梁)の自重
積雪荷重(Ls)	積雪量190cm 地震荷重と組み合わせる場合は0.35の係数を乗じた値とする。
地震荷重(Ss)	地震応答解析結果による地震荷重 ・基礎梁部の加速度(水平及び鉛直)より設定する震度 支持架構の評価結果による荷重*1 ・柱脚鉛直軸力 ・柱脚曲げモーメント ・柱脚せん断力 杭の評価結果による荷重*2 ・杭頭曲げモーメント
風荷重(W _L)	建築基準法・同施行令・同告示の規定による風荷重*3

注記 *1：支持架構に作用する固定荷重，積雪荷重，地震荷重及び風荷重を含む。

*2：杭に作用する地震荷重及び風荷重を含む。

*3：支持架構の評価において支持架構に作用する風荷重を考慮しているため，本表の「地震荷重(Ss)」のうち「支持架構の評価結果による荷重」により，基礎梁に風荷重が考慮される。

第4.2.2-2表 荷重の組合せ

外力の状態	荷重の組合せ
S s 地震時	$D + 0.35Ls + Ss + W_L$

4.2.3 杭

杭の評価において考慮する荷重を第4.2.3-1表に、荷重の組合せを第4.2.3-2表に示す。

第4.2.3-1表 考慮する荷重

荷重名称	内容
固定荷重(D)	構造物(支持架構及び基礎梁)の自重* ¹
積雪荷重(Ls)	積雪量 190cm* ¹ 地震荷重と組み合わせる場合は0.35の係数を乗じた値とする。
地震荷重(Ss)	地震応答解析結果による地盤から作用する地震荷重 <ul style="list-style-type: none"> 改良地盤の変形量より算定するせん断力及び曲げモーメント 地震応答解析結果による支持架構及び基礎梁から作用する地震荷重 <ul style="list-style-type: none"> 基礎梁上端の層せん断力より算定する曲げモーメント 基礎梁部の加速度(水平)より算定する曲げモーメント 基礎梁の評価結果による荷重* ² <ul style="list-style-type: none"> 杭頭鉛直軸力より算定する軸力 杭頭せん断力より算定するせん断力
風荷重(W _L)	支持架構の評価結果による風荷重 <ul style="list-style-type: none"> 基礎梁上端の層せん断力より算定する曲げモーメント*³

注記 *1：基礎梁の評価において支持架構及び基礎梁に作用する固定荷重及び積雪荷重を考慮しているため、本表の「地震荷重(Ss)」のうち「基礎梁の評価結果による荷重」により、杭に固定荷重及び積雪荷重が考慮される。

*2：支持架構及び基礎梁に作用する固定荷重，積雪荷重，地震荷重及び風荷重を含む。

*3：基礎梁の評価において支持架構に作用する風荷重を考慮しているため，せん断力については，本表の「地震荷重(Ss)」のうち「基礎梁の評価結果による荷重」に含まれる。

第4.2.3-2表 荷重の組合せ

外力の状態	荷重の組合せ
S s 地震時	D+0.35Ls+Ss+W _L

4.3 許容限界

応力解析による評価における飛来物防護ネット架構の許容限界は、添付書類「IV-2-2-1 波及的影響を及ぼすおそれのある下位クラス施設の耐震評価方針」に記載の許容限界に基づき、第4.3-1表のとおり設定する。

また、各部位に対する許容限界等を第4.3-2表～第4.3-6表及び第4.3-1図に示す。

第4.3-1表 応力解析による評価における許容限界

設計の観点	地震力	部位	許容限界設定の考え方	許容限界 (評価基準値)
損傷、転倒 及び落下	基準地震動 S _s	フレーム	部材に生じる応力が施設の構造を保つための許容限界を超えないことを確認	「S規準」に基づく終局強度*
		基礎梁		「RC-N規準」に基づく終局強度
		杭		「基礎指針」に基づく終局強度
相対変位	基準地震動 S _s	支持 架構	施設間の離隔による防護を講じるための許容限界を超えないことを確認	施設間の 離隔距離

注記 *：短期許容応力度の鋼材の基準強度Fを建築基準法・同施行令・同告示に基づき1.1倍した強度とする。

第4.3-2表 フレーム部材の基準強度

使用材料	基準強度 F (N/mm ²)
SN490B	325
BCP325	
G385	325*

注記 * : G385の基準強度は385N/mm²であるが、保守的に
325N/mm²として評価を行う。

第4.3-3表 コンクリートの設計基準強度

部位	設計基準強度 F _c (N/mm ²)
基礎梁	24
杭	27

第4.3-4表 鉄筋の降伏強度

鉄筋種類	引張及び圧縮* (N/mm ²)	せん断補強 (N/mm ²)
SD345	345	345

注記 * : 材料強度は降伏強度を1.1倍して算出する。

第4.3-5表 杭の支持力及び引抜力に関する許容限界

杭径 ϕ (mm)	杭の極限支持力 Ru (kN)	
	1000 (P1, P1A)	鉛直
	引抜	5022
1500 (P2)	鉛直	21898
	引抜	7672

第4.3-6表 杭の許容せん断力

杭径 ϕ (mm)	終局せん断耐力 Qsu (kN)
1000 (P1, P1A)	1838
1500 (P2)	4594

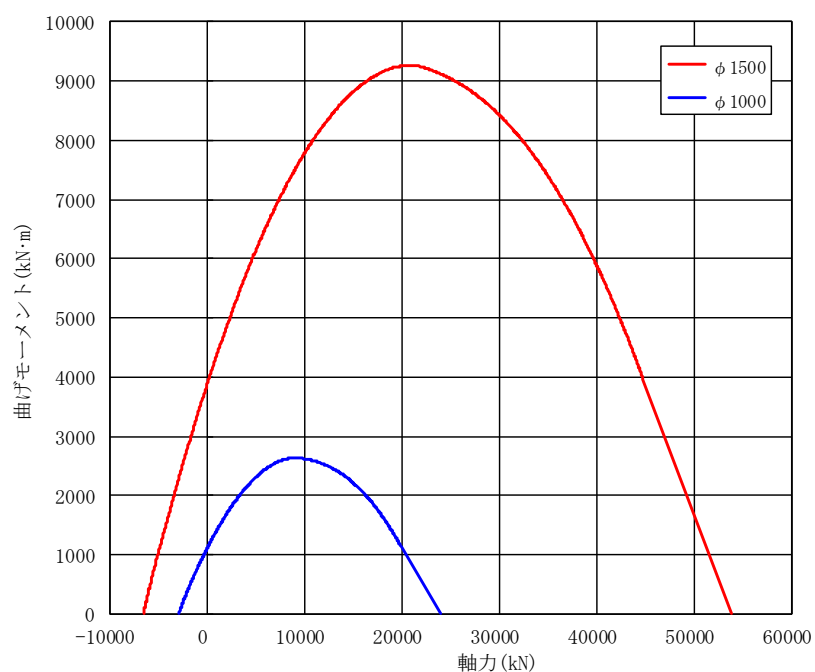

第4.3-1図 杭の終局強度(曲げモーメント-軸力相関)

4.4 評価方法

4.4.1 支持架構の評価方法

(1) 解析モデル

応力解析は、3次元フレームモデルを用いた静的弾塑性応力解析を実施する。解析には、解析コード「midas iGen(ver.845)」を用いる。また、解析コードの検証及び妥当性確認等の概要については、添付書類「IV-3 計算機プログラム(解析コード)の概要」に示す。

支持架構の解析モデル図を第4.4.1-1図に、使用材料の物性値を第4.4.1-1表に、部材リストを第4.4.1-2表に、座屈拘束ブレースの非線形特性を第4.4.1-2図に示す。

モデル化範囲は、基礎梁下端(T.M.S.L.52.30m)より上部とする。各部材は梁要素にてモデル化し、座屈拘束ブレースには非線形性を考慮する。解析モデルの節点数は438、要素数は1065である。

水平ブレース及び座屈拘束ブレースは両端ピン接合とし、基礎梁下端をピン支持とする。

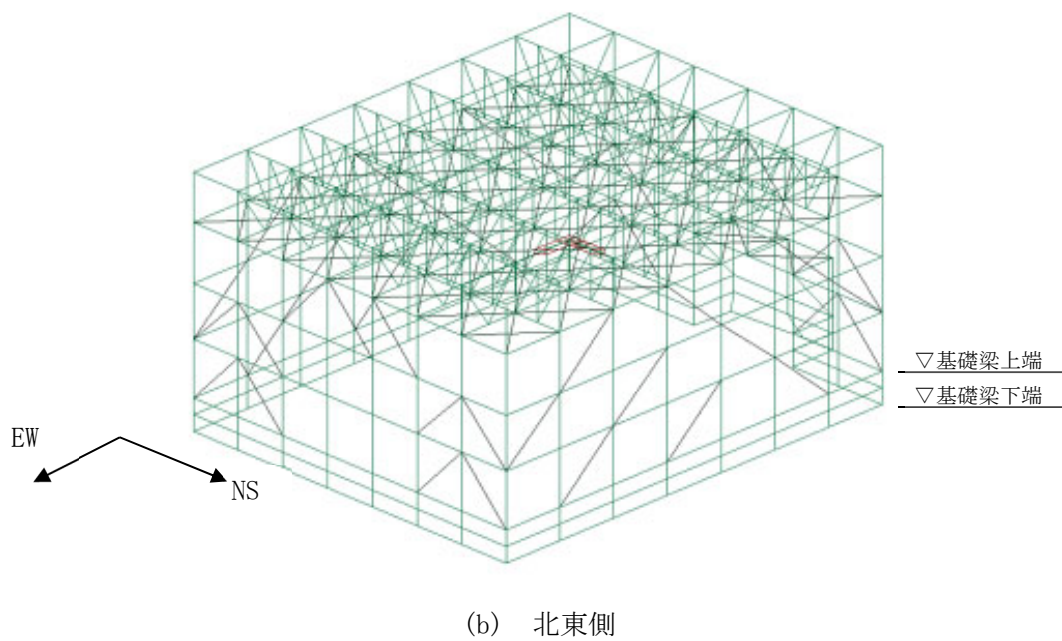
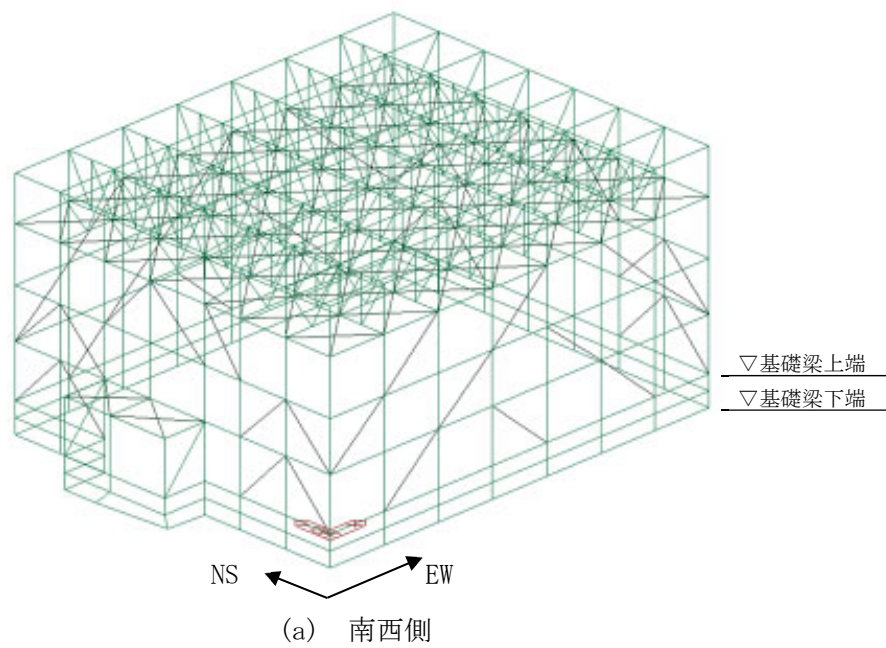

第4.4.1-1図 支持架構の解析モデル図

第4.4.1-1表 使用材料の物性値

使用材料	ヤング係数 (N/mm ²)	ポアソン比
鉄骨： BCP325, G385, SN490B	2.05×10^5	0.3
座屈拘束ブレース： 中心鋼材 BT-LYP225	2.05×10^5	0.3

第4.4.1-2表 部材リスト

部材種別	材質	寸法
柱	G385B	□-500×500×32
	BCP325	□-500×500×28
	SN490B	H-400×400×13×21
大はり	SN490B	H-428×407×20×35
	SN490B	H-414×405×18×28
	SN490B	H-400×400×13×21
小はり	SN490B	H-400×400×13×21
	SN490B	H-390×300×10×16
トラス柱	SN490B	H-400×400×13×21
	SN490B	H-390×300×10×16
	SN490B	H-300×300×10×15
鉛直ブレース	SN490B	H-350×350×12×19
	SN490B	H-300×300×10×15
	SN490B	H-250×250×9×14
	SN490B	H-200×200×8×12
水平ブレース	SN490B	H-300×300×10×15
	SN490B	H-250×250×9×14
座屈拘束 ブレース (中心鋼材)	BT-LYP225	PL-32×208
	BT-LYP225	PL-32×243
	BT-LYP225	PL-32×278
	BT-LYP225	PL-36×308

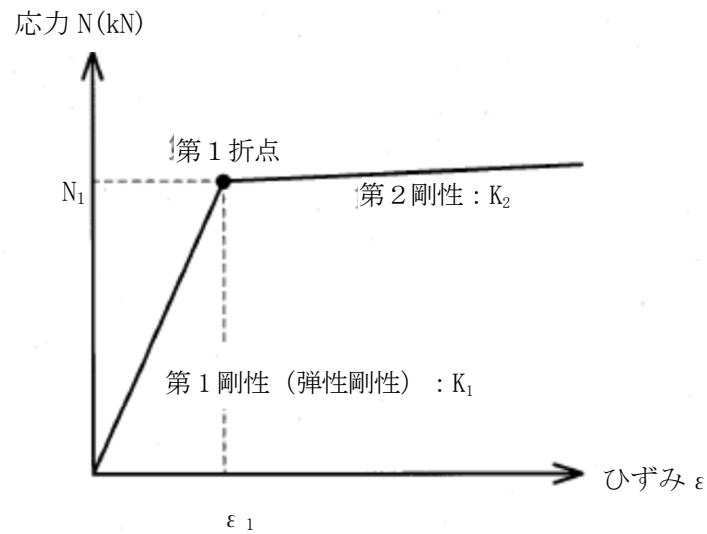

N_1 : 第1折れ点応力
 ϵ_1 : 第1折れ点ひずみ*¹
 K_1 : 第1剛性(弾性剛性)*²
 K_2 : 第2剛性

中心鋼材寸法	種別	第1折れ点応力 N_1 (kN)	二次勾配倍率* ³ (-)
PL-32×208	SV150	1500	0.001
PL-32×243	SV175	1750	
PL-32×278	SV200	2000	
PL-36×308	SV250	2500	

注記 *¹ : 第1折れ点応力 N_1 を第1剛性 K_1 で除すことにより設定する。
 *² : 第4.4.1-1表のヤング係数に中心鋼材の断面積を乗じて設定する。
 *³ : 第1剛性 K_1 に対する第2剛性 K_2 の倍率を示す。

第4.4.1-2図 座屈拘束ブレースの非線形特性

(2) 荷重の組合せ

支持架構に作用する応力は、次の荷重を組み合わせて求める。地震荷重は、 S_s -C1による地震荷重、その他の地震による地震荷重(S_s -C1以外包絡)の2種類を設定する。

- D : 固定荷重
- L_s : 積雪荷重
- S_{SNS} : NS方向の地震荷重(S→N方向を正とする。)
- S_{SEW} : EW方向の地震荷重(W→E方向を正とする。)
- S_{SID} : 鉛直方向の地震荷重(上向きを正とする。)
- W_{LNS} : NS方向の風荷重(S→N方向を正とする。)
- W_{LEW} : EW方向の風荷重(W→E方向を正とする。)

(3) 荷重の組合せケース

荷重の組合せケースを第4.4.1-3表に示す。

水平方向と鉛直方向の荷重の組合せは、「原子力発電所耐震設計技術規程JEAC 4601-2008((社)日本電気協会)」を参考に、組合せ係数法(組合せ係数は1.0と0.4)を用いるものとする。

第4.4.1-3表 荷重の組合せケース

ケース	荷重組合せ	地震荷重
1-1	$D+0.35Ls+1.0S_{SNS}+0.4S_{SUD}+W_{LNS}$	Ss-C1による 地震荷重
1-2	$D+0.35Ls-1.0S_{SNS}+0.4S_{SUD}-W_{LNS}$	
1-3	$D+0.35Ls+1.0S_{SNS}-0.4S_{SUD}+W_{LNS}$	
1-4	$D+0.35Ls-1.0S_{SNS}-0.4S_{SUD}-W_{LNS}$	
1-5	$D+0.35Ls+0.4S_{SNS}+1.0S_{SUD}+W_{LNS}$	
1-6	$D+0.35Ls-0.4S_{SNS}+1.0S_{SUD}-W_{LNS}$	
1-7	$D+0.35Ls+0.4S_{SNS}-1.0S_{SUD}+W_{LNS}$	
1-8	$D+0.35Ls-0.4S_{SNS}-1.0S_{SUD}-W_{LNS}$	
1-9	$D+0.35Ls+1.0S_{SEW}+0.4S_{SUD}+W_{LEW}$	
1-10	$D+0.35Ls-1.0S_{SEW}+0.4S_{SUD}-W_{LEW}$	
1-11	$D+0.35Ls+1.0S_{SEW}-0.4S_{SUD}+W_{LEW}$	
1-12	$D+0.35Ls-1.0S_{SEW}-0.4S_{SUD}-W_{LEW}$	
1-13	$D+0.35Ls+0.4S_{SEW}+1.0S_{SUD}+W_{LEW}$	
1-14	$D+0.35Ls-0.4S_{SEW}+1.0S_{SUD}-W_{LEW}$	
1-15	$D+0.35Ls+0.4S_{SEW}-1.0S_{SUD}+W_{LEW}$	
1-16	$D+0.35Ls-0.4S_{SEW}-1.0S_{SUD}-W_{LEW}$	
2-1	$D+0.35Ls+1.0S_{SNS}+0.4S_{SUD}+W_{LNS}$	その他の地震による 地震荷重 (Ss-C1以外 包絡)
2-2	$D+0.35Ls-1.0S_{SNS}+0.4S_{SUD}-W_{LNS}$	
2-3	$D+0.35Ls+1.0S_{SNS}-0.4S_{SUD}+W_{LNS}$	
2-4	$D+0.35Ls-1.0S_{SNS}-0.4S_{SUD}-W_{LNS}$	
2-5	$D+0.35Ls+0.4S_{SNS}+1.0S_{SUD}+W_{LNS}$	
2-6	$D+0.35Ls-0.4S_{SNS}+1.0S_{SUD}-W_{LNS}$	
2-7	$D+0.35Ls+0.4S_{SNS}-1.0S_{SUD}+W_{LNS}$	
2-8	$D+0.35Ls-0.4S_{SNS}-1.0S_{SUD}-W_{LNS}$	
2-9	$D+0.35Ls+1.0S_{SEW}+0.4S_{SUD}+W_{LEW}$	
2-10	$D+0.35Ls-1.0S_{SEW}+0.4S_{SUD}-W_{LEW}$	
2-11	$D+0.35Ls+1.0S_{SEW}-0.4S_{SUD}+W_{LEW}$	
2-12	$D+0.35Ls-1.0S_{SEW}-0.4S_{SUD}-W_{LEW}$	
2-13	$D+0.35Ls+0.4S_{SEW}+1.0S_{SUD}+W_{LEW}$	
2-14	$D+0.35Ls-0.4S_{SEW}+1.0S_{SUD}-W_{LEW}$	
2-15	$D+0.35Ls+0.4S_{SEW}-1.0S_{SUD}+W_{LEW}$	
2-16	$D+0.35Ls-0.4S_{SEW}-1.0S_{SUD}-W_{LEW}$	

(4) 荷重の入力方法

a. 固定荷重(D)

鉄骨の自重については、各要素に密度として入力する。その他については、各節点又は各要素に集中荷重又は分布荷重として入力する。

b. 積雪荷重(Ls)

水平面の各要素に分布荷重として入力する。

c. 地震荷重(Ss)

各層の層せん断力については、各節点の支配重量に応じて離散化して集中荷重として入力する。

屋根部の付加曲げモーメントについては、鉛直方向の偶力に置換し、各節点の回転中心からの距離に応じて離散化して集中荷重として入力する。

屋根部の鉛直加速度については、各節点及び各要素に鉛直震度として入力する。地震応答解析結果から得られる地震荷重を第4.4.1-4表に示す。

d. 風荷重(W_L)

鉛直面の各要素に分布荷重として入力する。

第4.4.1-4表 地震応答解析結果から得られる支持架構の地震荷重

(a) 層せん断力

階層	NS方向 (kN)		EW方向 (kN)	
	Ss-C1	Ss-C1以外	Ss-C1	Ss-C1以外
4層目	10796	9880	11044	10720
3層目	14321	13089	14247	13004
2層目	14833	13181	14566	13025
1層目	15479	13446	15352	13968

(b) 付加曲げモーメント

階層	NS方向 (kN・m)		EW方向 (kN・m)	
	Ss-C1	Ss-C1以外	Ss-C1	Ss-C1以外
4層目	4380	8200	4150	10110
3層目	1270	2740	810	700
2層目	—	—	—	—
1層目	—	—	—	—

(c) 鉛直震度

Ss-C1	Ss-C1以外
0.65	1.25

注：震度は屋根部の最大応答加速度より設定し、3次元フレームモデル全体に入力する。

(5) 部材の評価方法

a. 軸力及び曲げモーメントに対する評価方法

軸力及び曲げモーメントが生じる部材は，座屈を考慮し，部材に生じる軸応力度及び曲げ応力度の組合せ応力が許容限界を超えないことを下式により確認する。

$$\frac{\sigma_c}{f_c} + \frac{\sigma_b}{f_b} \leq 1.0 \quad \text{又は} \quad \frac{\sigma_t}{f_t} + \frac{\sigma_b}{f_b} \leq 1.0$$

ここで，

- σ_c : 圧縮応力度
- σ_b : 曲げ応力度
- σ_t : 引張応力度
- f_c : 許容圧縮応力度
- f_b : 許容曲げ応力度
- f_t : 許容引張応力度

b. せん断力に対する評価方法

せん断力が生じる部材は，部材に生じるせん断応力度が，下式により許容限界を超えないことを確認する。

$$\frac{\tau_s}{f_s} \leq 1.0$$

ここで，

- τ_s : せん断応力度
- f_s : 許容せん断応力度

(6) 相対変位に対する評価方法

支持架構と冷却塔の最大変位の合計値により算出した相対変位が、第4.4.1-3図に示す冷却塔までの離隔距離(水平方向及び鉛直方向)を超えないことを確認する。このときの最大変位の合計値には、地盤の変位も考慮する。

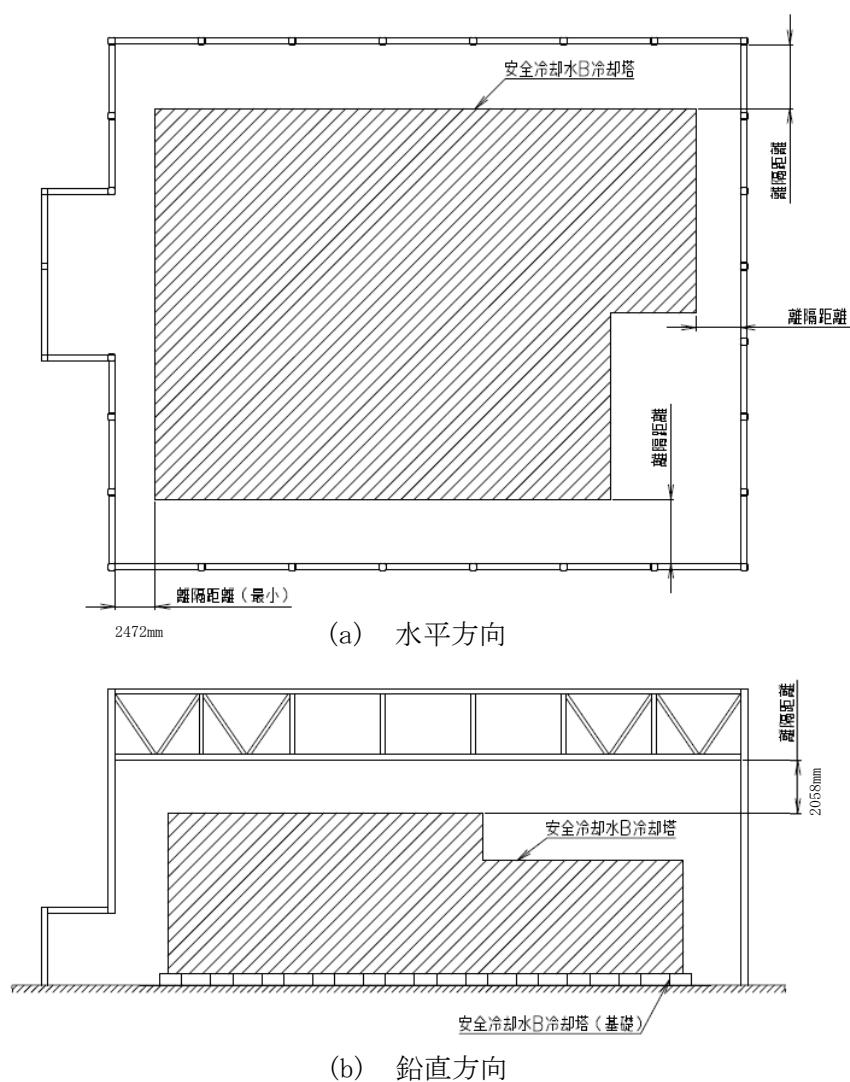

第4.4.1-3図 離隔距離イメージ図

4.4.2 基礎梁の評価方法

(1) 解析モデル

応力解析は、FEMモデルを用いた静的弾性応力解析を実施する。解析には、解析コード「midas iGen Ver.845」を用いる。また、解析コードの検証及び妥当性確認等の概要については、添付書類「IV-3 計算機プログラム(解析コード)の概要」に示す。

基礎梁の解析モデルを第4.4.2-1図に、使用材料の物性値を第4.4.2-1表に示す。

モデル化範囲は、基礎梁下端から上端まで(T.M.S.L. 52.30m~55.30m)とし、シェル要素にてモデル化する。解析モデルの節点数は959、要素数は771である。

杭位置の節点について、水平方向は並進を拘束し、鉛直方向はばね要素を設ける。ばね要素の剛性は、杭のコンクリートのヤング係数に杭の断面積を乗じ、杭の長さで除すことにより設定する。剛性を算出する際の杭の長さは、基礎梁下端(T.M.S.L. 52.30m)から支持地盤(T.M.S.L. 37.00m)までの長さとする。

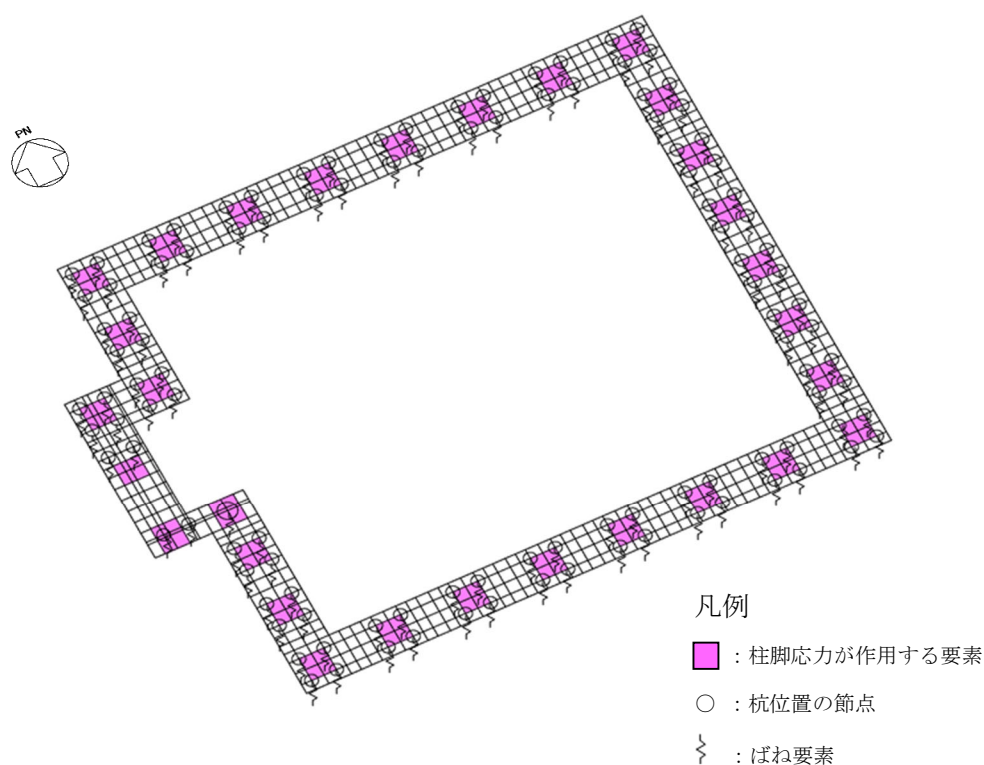

第4.4.2-1図 基礎梁の解析モデル

第4.4.2-1表 使用材料の物性値

部位	設計基準強度 Fc (N/mm ²)	ヤング係数 Ec (N/mm ²)	ポアソン比 ν
基礎梁	24	2.27×10 ⁴	0.2
杭	27	2.36×10 ⁴	0.2

(2) 荷重ケース

基礎梁に作用する応力は、次の荷重ケースによる応力を組み合わせて求める。

VL : 鉛直荷重(固定荷重 D+積雪荷重 L_s)
(積雪荷重は係数 0.35 を乗じたもの)

S_{SNS} : NS 方向の S_s 地震荷重(S→N 方向を正とする。)

S_{SEW} : EW 方向の S_s 地震荷重(W→E 方向を正とする。)

S_{SID} : 鉛直方向の S_s 地震荷重(上向きを正とする。)

W_{LNS} : NS 方向の風荷重(S→N 方向を正とする。)

W_{LEW} : EW 方向の風荷重(W→E 方向を正とする。)

(3) 荷重の組合せケース

荷重の組合せケースを第4.4.2-2表に示す。

水平方向と鉛直方向の荷重の組合せは、「原子力発電所耐震設計技術規程JEAC 4601-2008((社)日本電気協会)」を参考に、組合せ係数法(組合せ係数は1.0と0.4)を用いるものとする。

第4.4.2-2表 荷重の組合せケース

ケース	荷重組合せ	地震荷重
1-1	$VL + 1.0S_{SNS} + 0.4S_{SUD} + W_{LNS}$	Ss-C1による 地震荷重
1-2	$VL - 1.0S_{SNS} + 0.4S_{SUD} - W_{LNS}$	
1-3	$VL + 1.0S_{SNS} - 0.4S_{SUD} + W_{LNS}$	
1-4	$VL - 1.0S_{SNS} - 0.4S_{SUD} - W_{LNS}$	
1-5	$VL + 0.4S_{SNS} + 1.0S_{SUD} + W_{LNS}$	
1-6	$VL - 0.4S_{SNS} + 1.0S_{SUD} - W_{LNS}$	
1-7	$VL + 0.4S_{SNS} - 1.0S_{SUD} + W_{LNS}$	
1-8	$VL - 0.4S_{SNS} - 1.0S_{SUD} - W_{LNS}$	
1-9	$VL + 1.0S_{SEW} + 0.4S_{SUD} + W_{LEW}$	
1-10	$VL - 1.0S_{SEW} + 0.4S_{SUD} - W_{LEW}$	
1-11	$VL + 1.0S_{SEW} - 0.4S_{SUD} + W_{LEW}$	
1-12	$VL - 1.0S_{SEW} - 0.4S_{SUD} - W_{LEW}$	
1-13	$VL + 0.4S_{SEW} + 1.0S_{SUD} + W_{LEW}$	
1-14	$VL - 0.4S_{SEW} + 1.0S_{SUD} - W_{LEW}$	
1-15	$VL + 0.4S_{SEW} - 1.0S_{SUD} + W_{LEW}$	
1-16	$VL - 0.4S_{SEW} - 1.0S_{SUD} - W_{LEW}$	
2-1	$VL + 1.0S_{SNS} + 0.4S_{SUD} + W_{LNS}$	その他の地震に よる地震荷重 (Ss-C1以外包絡)
2-2	$VL - 1.0S_{SNS} + 0.4S_{SUD} - W_{LNS}$	
2-3	$VL + 1.0S_{SNS} - 0.4S_{SUD} + W_{LNS}$	
2-4	$VL - 1.0S_{SNS} - 0.4S_{SUD} - W_{LNS}$	
2-5	$VL + 0.4S_{SNS} + 1.0S_{SUD} + W_{LNS}$	
2-6	$VL - 0.4S_{SNS} + 1.0S_{SUD} - W_{LNS}$	
2-7	$VL + 0.4S_{SNS} - 1.0S_{SUD} + W_{LNS}$	
2-8	$VL - 0.4S_{SNS} - 1.0S_{SUD} - W_{LNS}$	
2-9	$VL + 1.0S_{SEW} + 0.4S_{SUD} + W_{LEW}$	
2-10	$VL - 1.0S_{SEW} + 0.4S_{SUD} - W_{LEW}$	
2-11	$VL + 1.0S_{SEW} - 0.4S_{SUD} + W_{LEW}$	
2-12	$VL - 1.0S_{SEW} - 0.4S_{SUD} - W_{LEW}$	
2-13	$VL + 0.4S_{SEW} + 1.0S_{SUD} + W_{LEW}$	
2-14	$VL - 0.4S_{SEW} + 1.0S_{SUD} - W_{LEW}$	
2-15	$VL + 0.4S_{SEW} - 1.0S_{SUD} + W_{LEW}$	
2-16	$VL - 0.4S_{SEW} - 1.0S_{SUD} - W_{LEW}$	

(4) 荷重の入力方法

a. 鉛直荷重(VL)

各要素に単位体積重量として入力する。

b. 地震荷重(Ss)及び風荷重(W_L)

地震応答解析結果による地震荷重については、各要素に水平震度及び鉛直震度として入力する。地震応答解析から得られる地震荷重を第4.4.2-3表に示す。

支持架構の評価結果による支持架構から作用する荷重については、支持架構の柱脚位置の節点に集中荷重として入力する。この荷重には、固定荷重、積雪荷重、地震荷重及び風荷重を含む。

杭の評価結果による杭から作用する荷重については、杭位置の節点に集中荷重として入力する。この荷重には、地震荷重及び風荷重を含む。

第4.4.2-3表 地震応答解析結果から得られる地震荷重

方向	NS方向		EW方向	
	Ss-C1	Ss-C1以外	Ss-C1	Ss-C1以外
水平震度	0.80	0.70	0.75	0.65
鉛直震度	0.21	0.36	0.21	0.36

(5) 断面の評価方法

a. 軸力及び曲げモーメントに対する断面の評価方法

各断面は、軸力及び曲げモーメントを受ける鉄筋コンクリート造長方形仮想柱として算定する。断面の評価は、「RC-N規準」に基づき、評価対象部位に生じる曲げモーメントが曲げ終局強度を超えないことを下式により確認する。

$$M \leq M_u$$

$$M_u = 0.8a_t \sigma_y D + 0.4ND \quad (N_{\min} \leq N \leq 0)$$

$$M_u = 0.8a_t \sigma_y D + 0.5ND \left(1 - \frac{N}{bDF_c}\right) \quad (0 \leq N \leq 0.4bDF_c)$$

$$M_u = \left(0.8a_t \sigma_y D + 0.12bD^2F_c\right) \left(\frac{N_{\max} - N}{N_{\max} - 0.4bDF_c}\right) \quad (0.4bDF_c \leq N \leq N_{\max})$$

ここで、

M : 曲げモーメント

M_u : 許容限界(曲げ終局強度)

N_{\min} : 中心引張時終局強度であり、下式による値

$$N_{\min} = -a_g \sigma_y$$

N_{\max} : 中心圧縮時終局強度であり、下式による値

$$N_{\max} = bDF_c + a_g \sigma_y$$

N : 軸力

a_t : 引張主筋断面積

a_g : 主筋全断面積

b : 断面幅

D : 断面せい

σ_y : 鉄筋の引張に対する材料強度

F_c : コンクリート圧縮強度

b. 面外せん断力に対する断面の評価方法

断面の評価は、「RC-N規準」に基づき、評価対象部位に生じる面外せん断力が許容限界を超えないことを下式により確認する。

$$Q \leq Q_u$$
$$Q_u = \left\{ \frac{0.068 p_t^{0.23} (F_c + 18)}{M / (Qd) + 0.12} + 0.85 \sqrt{p_w \sigma_{wy}} + 0.1 \sigma_0 \right\} b j$$

ここで、

Q : 面外せん断力

Q_u : 許容限界(面外せん断終局強度)

p_t : 引張鉄筋比

F_c : コンクリートの圧縮強度

M/Q : 強度算定断面における曲げモーメントMと面外せん断力Qの比

d : 有効せい

p_w : 面外せん断補強筋比

σ_{wy} : 面外せん断補強筋の降伏強度

σ_0 : 平均軸方向応力度

b : 部材幅

j : 応力中心間距離

4.4.3 杭の評価方法

(1) 応力解析

地盤から作用する地震荷重による応力は、応力解析により算定する。

応力解析は、梁要素と地盤ばねによるモデルを用いた応答変位法による応力解析を実施する。解析には、解析コード「TDAPⅢ Ver. 3.07」を用いる。また、解析コードの検証及び妥当性確認等の概要については、添付書類「IV-3 計算機プログラム(解析コード)の概要」に示す。

杭の解析モデルを第4.4.3-1図に、杭及び地盤ばねの諸元を第4.4.3-1表及び第4.4.3-2表に示す。

モデル化範囲は、改良地盤と岩盤との境界面から基礎梁下端まで(T. M. S. L. 37.00m～52.30m)とする。杭は梁要素としてモデル化する。

杭先端位置ではピン支持とし、杭周には三軸圧縮試験結果から「基礎指針」に基づき設定した水平地盤ばねを設ける。

地盤から作用する地震荷重として、地震応答解析結果による改良地盤の各時刻の変形量を地盤ばねの固定位置に強制変位として入力する。ここで、改良地盤の変形量は、杭先端位置に対する相対変位とし、基礎梁の回転角も考慮する。

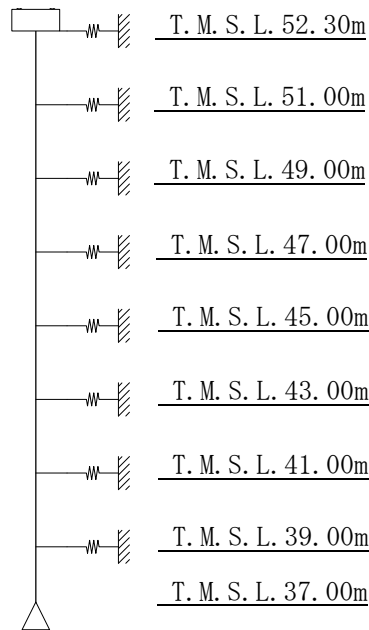

第4.4.3-1図 杭の解析のモデル

第4.4.3-1表 杭の諸元

諸元	P1, P1A	P2
設計基準強度 (N/mm ²)	27	27
比重 (kN/m ³)	24	24
ヤング係数 (N/mm ²)	23600	23600
杭径 (mm)	1000	1500
断面積 (m ²)	0.785	1.77
長さ (m)	15.3	15.3
軸剛性 (kN/m)	1210000	2720000

第4.4.3-2表 地盤ばねの諸元

諸元	P1, P1A	P2
変形係数E ₀ (kN/m ²)	614000	614000
評価法によって決まる定数α (m ⁻¹)	80	80
群杭の影響を考慮した係数ξ	0.4	1.0
水平地盤反力係数k _h (kN/m ³)	1960000	3620000
地盤ばね剛性 (kN/m ²)	1960000	5430000

(2) 応力計算

支持架構及び基礎梁から作用する地震荷重並びに風荷重による応力については、応力計算により算定する。

応力計算は、「基礎指針」に基づき、下式により実施する。

支持架構及び基礎梁から作用する地震荷重として、地震応答解析結果による基礎梁上端の層せん断力及び基礎梁部の加速度(水平)から求めた慣性力を考慮した各時刻の杭頭せん断力を用いる。また、支持架構及び基礎梁から作用する風荷重として、支持架構の応力解析による基礎梁上端の層せん断力を考慮した杭頭せん断力を用いる。

$$M_0 = \frac{H}{2\beta}$$

$$\beta = \left(\frac{k_h \cdot B}{4EI} \right)^{\frac{1}{4}}$$

$$k_h = 3.16 \cdot k_{h0} : 0.0 \leq y \leq 0.1$$

$$k_h = k_{h0} \cdot y^{\left(-\frac{1}{2}\right)} : 0.1 < y$$

$$k_{h0} = \alpha \cdot \xi \cdot E_0 \cdot \bar{B}^{-\frac{3}{4}}$$

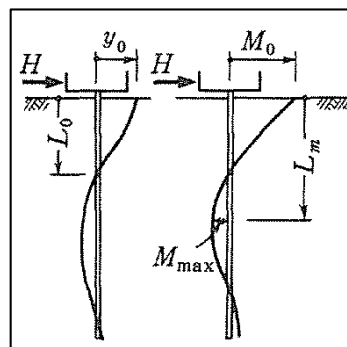

ここで、

M_0 : 杭頭曲げモーメント (kN・m)

H : 杭頭せん断力 (kN)

β : 杭の特性係数 (m^{-1})

k_h : 水平地盤反力係数 (kN/m^3)

B : 杭径 (m)

E : 杭のコンクリートのヤング係数 (kN/m^2)

I : 杭の断面 2 次モーメント (m^4)

k_{h0} : 基準水平地盤反力係数 (kN/m^3)

y : 無次元化水平変位 (水平変位量を cm で表した無次元量)

α : 評価法によって決まる定数 (m^{-1})。 $\alpha=80$ とする。

ξ : 群杭の影響を考慮した係数。最小の杭間距離から算定する。

E_0 : 変形係数 (kN/m^2)。岩盤の三軸圧縮試験の結果から算定する。

\bar{B} : 無次元化杭径 (杭径を cm で表した無次元数値)

(3) 応力の組合せ

軸力については、「4.4.2 基礎梁の評価方法」による基礎梁の応力解析結果における杭位置の反力を用いる。引張軸力については浮力を考慮する。

曲げモーメントについては、「(1) 応力解析」及び「(2) 応力計算」による結果を各時刻で組み合わせ、その最大値を用いる。

せん断力については、「4.4.2 基礎梁の評価方法」による基礎梁の応力解析結果における杭位置の反力と「(1) 応力解析」による結果の最大値を組み合わせる。

(4) 断面の評価方法

a. 軸力及び曲げモーメントに対する断面の評価方法

軸力及び曲げモーメントに対する評価は、「基礎指針」に基づき、杭に生じる軸力及び曲げモーメントが、第4.3-1図に示す杭の終局強度を超えないことを確認する。

b. せん断力に対する評価

せん断力に対する評価は、「基礎指針」に基づき、杭に生じるせん断力が第4.3-6表に示す許容限界を超えないことを確認する。

(5) 支持力及び引抜力に対する評価方法

支持力及び引抜力に対する評価は、「基礎指針」に基づき、杭に生じる最大軸力及び最小軸力が第4.3-5表に示す杭の極限支持力を超えないことを確認する。最小軸力の算定においては浮力を考慮する。

5. 評価結果

5.1 地震応答解析による評価結果

「3.2 評価方法」に基づいた評価結果を以下に示す。

軸ひずみが最大となる座屈拘束ブレースの評価結果を第5.1-1表に示す。座屈拘束ブレースの軸ひずみは最大で1.70%であり、許容限界を下回ることを確認した。

疲労係数総和が最も大きい座屈拘束ブレースの疲労評価結果を第5.1-2表に示す。疲労係数総和は最大で0.5950であり、許容限界を下回ることを確認した。

第5.1-1表 軸ひずみの評価結果(Ss-C1, -1 σ 地盤, 有効応力解析, NS方向, 要素No.121)

軸ひずみ(%)	許容限界(%)	検定比	判定
1.70	3.0	0.57	OK

第5.1-2表 疲労評価結果(Ss-A, -1 σ 地盤, 有効応力解析, NS方向, 要素No.121)

ひずみ振幅 (0.1%-0.3%)		ひずみ振幅 (0.3%-0.5%)		ひずみ振幅 (0.5%-1.0%)		ひずみ振幅 (1.0%-2.7%)		疲労係数総和	許容限界	判定
許容繰返し回数N : 5537回		許容繰返し回数N : 1952回		許容繰返し回数N : 474回		許容繰返し回数N : 62回				
繰返し数n	疲労係数 n/N	繰返し数n	疲労係数 n/N	繰返し数n	疲労係数 n/N	繰返し数n	疲労係数 n/N			
105	0.0190	91	0.0466	98	0.2068	20	0.3226	0.5950	1	OK

50

5.2 応力解析による評価結果

5.2.1 支持架構の評価結果

(1) 部材の評価

「4.4.1(5) 部材の評価方法」に基づいた評価結果を以下に示す。

評価結果は、部材種別ごとに検定比が最も大きい部材に対して示す。当該部材の位置を第5.2.1-1図に、評価結果を第5.2.1-1表に示す。

発生応力度が、許容限界を超えないことを確認した。

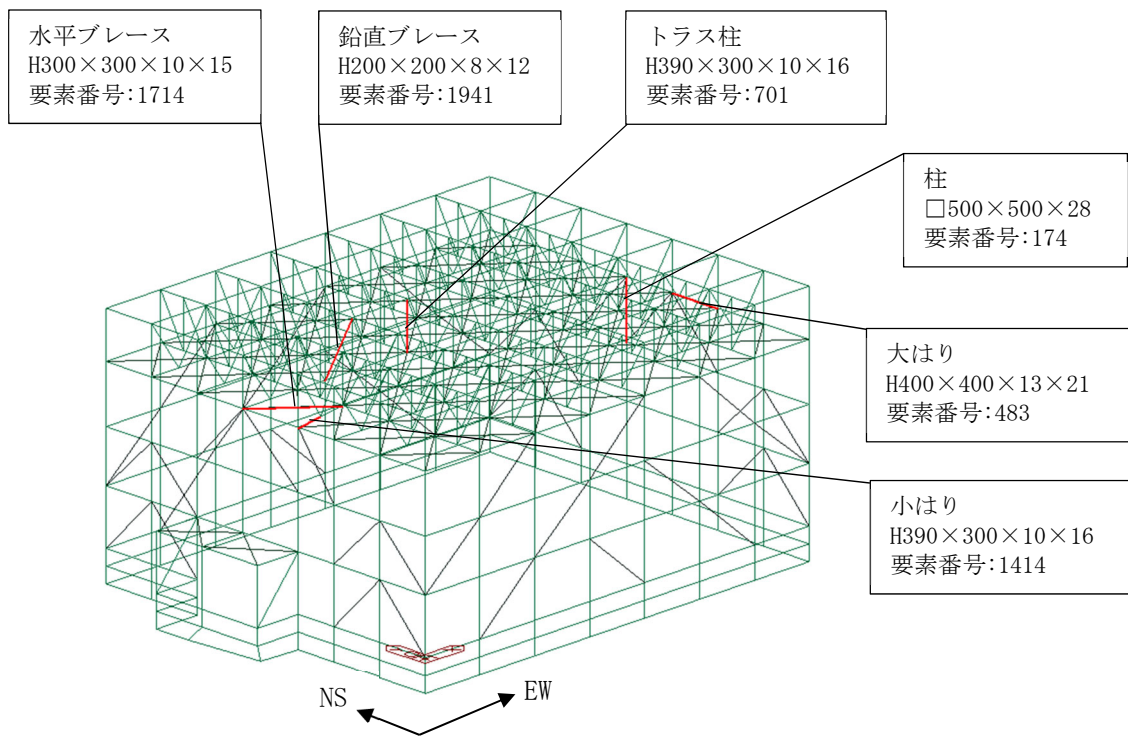

(a) 軸力+曲げ

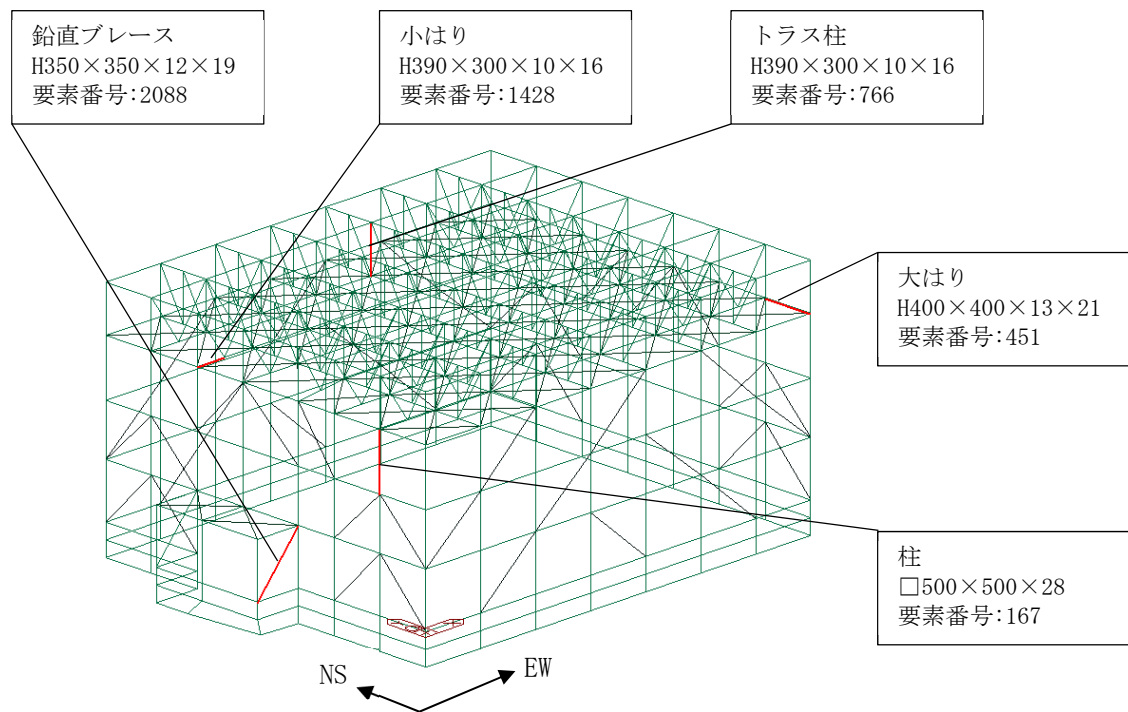

(b) せん断

第5.2.1-1図 評価結果を記載する位置

第5.2.1-1表 部材の評価結果

部材種別	要素番号	ケース	応力度	発生応力度 (N/mm ²)	許容限界 (N/mm ²)	検定比	判定
柱	167	1-4	せん断	34.0	206.0	0.17	OK
	174	1-4	軸力+曲げ	(検定比) 0.89	(許容値) 1.00	0.89	OK
大はり	451	1-4	せん断	70.1	206.0	0.34	OK
	483	1-4	軸力+曲げ	(検定比) 0.87	(許容値) 1.00	0.87	OK
小はり	1428	1-12	せん断	38.5	206.0	0.19	OK
	1414	1-12	軸力+曲げ	(検定比) 0.87	(許容値) 1.00	0.87	OK
トラス柱	766	2-7	せん断	13.5	206.0	0.07	OK
	701	1-12	軸力+曲げ	(検定比) 0.72	(許容値) 1.00	0.72	OK
鉛直 ブレース	2088	1-12	せん断	10.3	206.0	0.05	OK
	1941	2-12	軸力+曲げ	(検定比) 0.69	(許容値) 1.00	0.69	OK
水平 ブレース	1714	1-1	軸力+曲げ	(検定比) 0.30	(許容値) 1.00	0.30	OK

(2) 相対変位に対する評価

「4.4.1(6) 相対変位に対する評価方法」に基づいた評価結果を以下に示す。

水平方向及び鉛直方向の相対変位に対する評価結果を第5.2.1-2表に示す。支持架構と冷却塔の相対変位が、許容限界を下回ることを確認した。

第5.2.1-2表 相対変位に対する評価結果

方向	相対変位*1 (mm)	許容限界(mm)	検定比	判定
水平方向	■	2472	■	OK
鉛直方向	■	2058	■	OK

注記 *1：支持架構と冷却塔との相対変位(*2 + *4) + (*3 + *4) (第5.2.1-2図参照)。

*2：支持架構の応力解析における全節点の最大変位。

*3：冷却塔の最大変位。

*4：地震応答解析における地盤の最大変位。冷却塔の直下は剛性の高いMMRであるが、保守的に改良地盤の変位を用いて評価する。

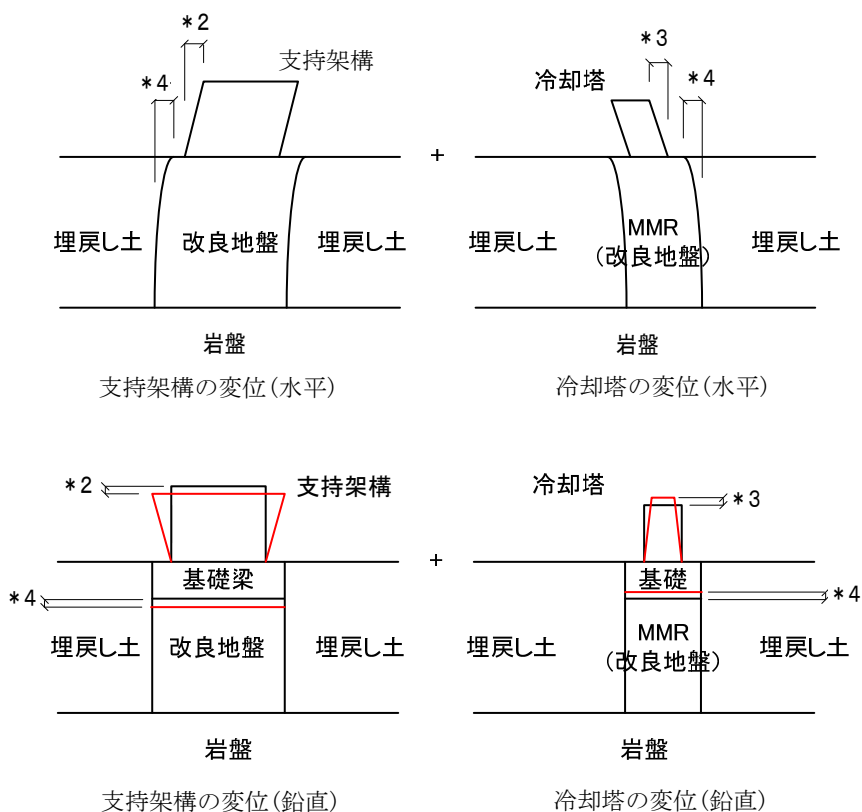

第5.2.1-2図 相対変位のイメージ図

5.2.2 基礎梁の評価結果

「4.4.2(5) 断面の評価方法」に基づいた評価結果を以下に示す。また、基礎梁の配筋を第5.2.2-1図及び第5.2.2-2図に示す。

断面の評価結果は、許容限界に対する曲げモーメント及び面外せん断力の割合が最も大きい要素に対して示す。当該要素の位置を第5.2.2-3図に、評価結果を第5.2.2-1表に示す。

曲げモーメント及び面外せん断力が、それぞれの許容限界を超えないことを確認した。

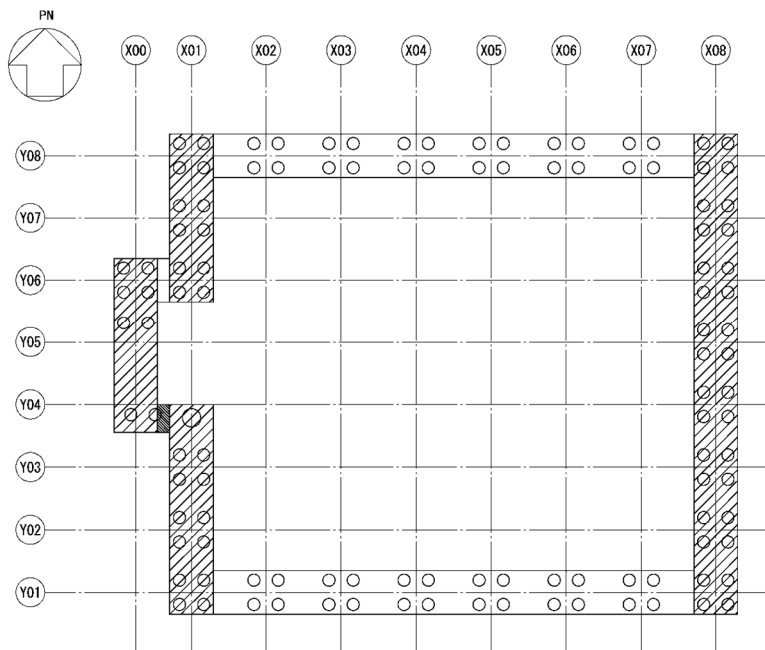

領域	主筋	せん断補強筋
	上端 24-D32	D22Ⅲ-@200
	下端 30-D32	
	上端 D22@200	D22Ⅲ-@200
	下端 D22@200	
	上端 D19@200	D19Ⅲ-@200
	下端 D19@200	

第5.2.2-1図 基礎梁の配筋(NS方向)

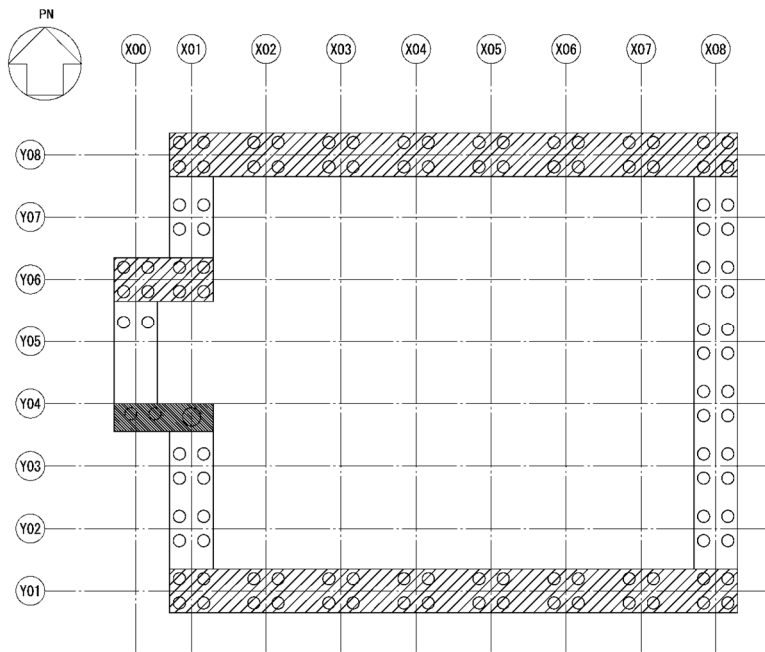

領域	主筋	せん断補強筋
	上端 24-D32	D22Ⅲ-@200
	下端 30-D32	
	上端 D22@200	D22Ⅲ-@200
	下端 D22@200	
	上端 18-D32	D19Ⅲ-@200
	上端 18-D32	

第5.2.2-2図 基礎梁の配筋(EW方向)

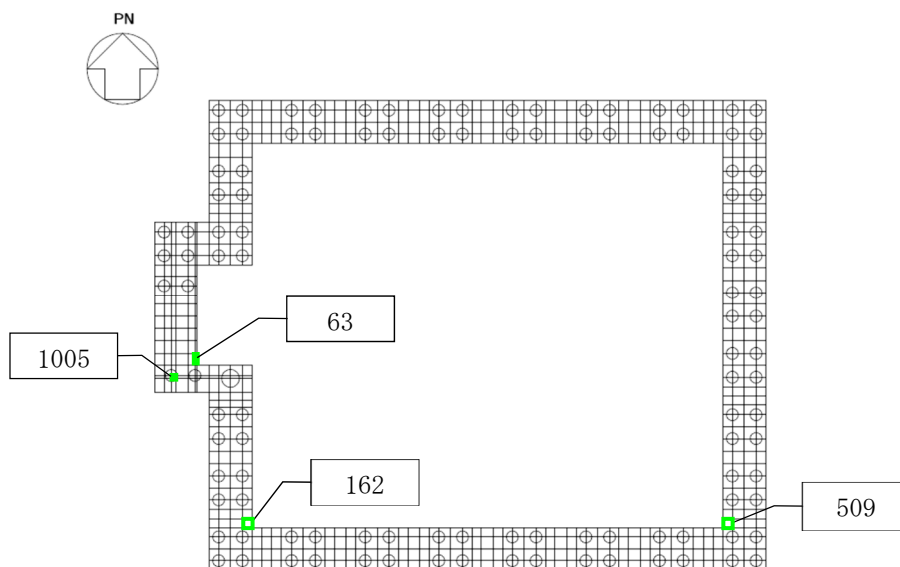

注： 内の数値は要素番号

第5.2.2-3図 評価結果を記載する要素の位置

第5.2.2-1表 基礎梁の評価結果

(a) 軸力及び曲げモーメントに対する評価

方向	解析結果			許容限界 (kN・m/m)	検定比	判定
	要素番号	ケース	曲げモーメント (kN・m/m)			
NS	162	1-4	3527	4791	0.74	OK
EW	509	1-10	1274	1755	0.73	OK

(b) 面外せん断力に対する評価

方向	解析結果			許容限界 (kN/m)	検定比	判定
	要素番号	ケース	面外せん断力 (kN/m)			
NS	63	1-4	2236	5661	0.40	OK
EW	1005	1-12	2061	5874	0.36	OK

5.2.3 杭の評価結果

(1) 断面の評価結果

「4.4.3(4) 断面の評価方法」に基づいた評価結果を以下に示す。また、杭の配筋を第5.2.3-1表に示す。

断面の評価結果は、杭種ごとに、許容限界に対する曲げモーメント並びにせん断力の割合が最も大きい杭に対して示す。当該の杭の位置を第5.2.3-1図に、評価結果を第5.2.3-2表及び第5.2.3-2図に示す。

曲げモーメント及びせん断力が、それぞれの許容限界を超えないことを確認した。

第5.2.3-1表 杭の配筋一覧

杭種	主筋	帯筋
P1, P1A	8-D35	D16@150
P2	18-D35	D16@150

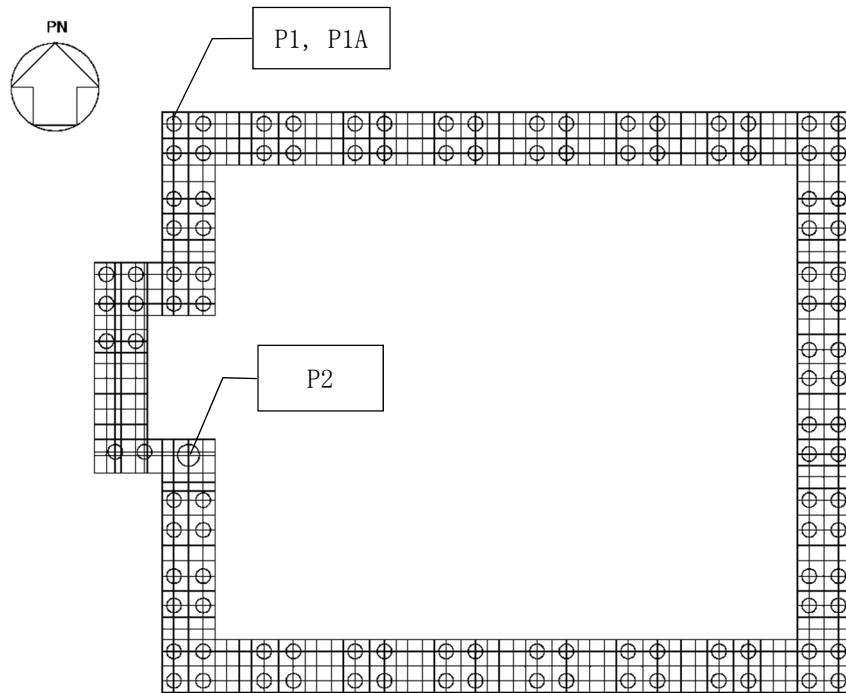

第5.2.3-1図 評価結果を記載する杭の位置

第5.2.3-2表 断面の評価結果

(a) 軸力及び曲げモーメントに対する評価

杭種	応力の組合せ結果			許容限界 (kN・m)	検定比	判定
	節点 番号*	ケース*	曲げモーメント (kN・m)			
P1, P1A	189	1-2	400	706	0.57	OK
P2	1207	1-2	1520	3583	0.43	OK

(b) せん断力に対する評価

杭種	応力の組合せ結果		許容限界 (kN)	検定比	判定
	ケース*	せん断力 (kN)			
P1, P1A	1-2	540	1838	0.30	OK
P2	1-2	1730	4594	0.38	OK

注記 * : 基礎梁の評価における節点番号及びケースを示す。

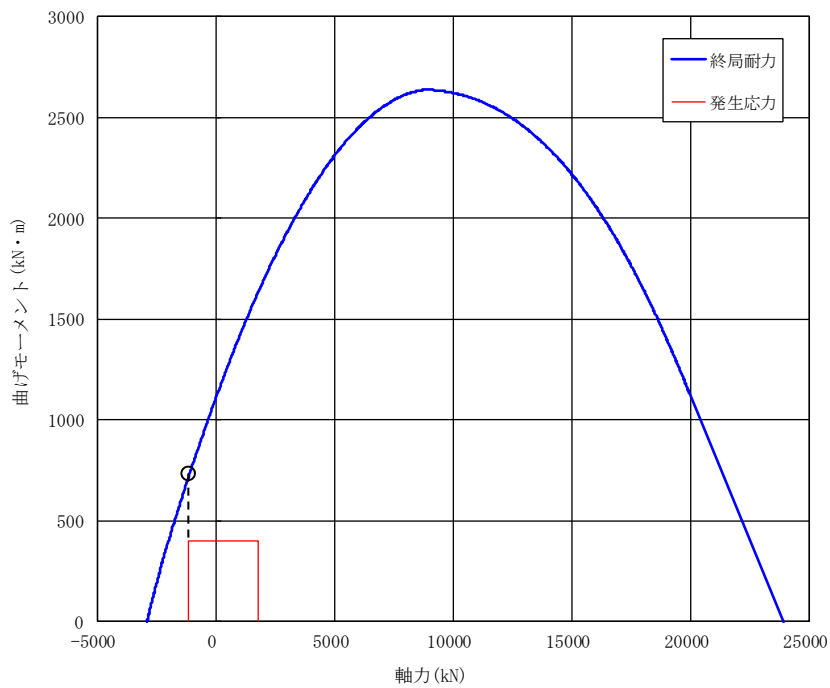

(a) P1, P1A

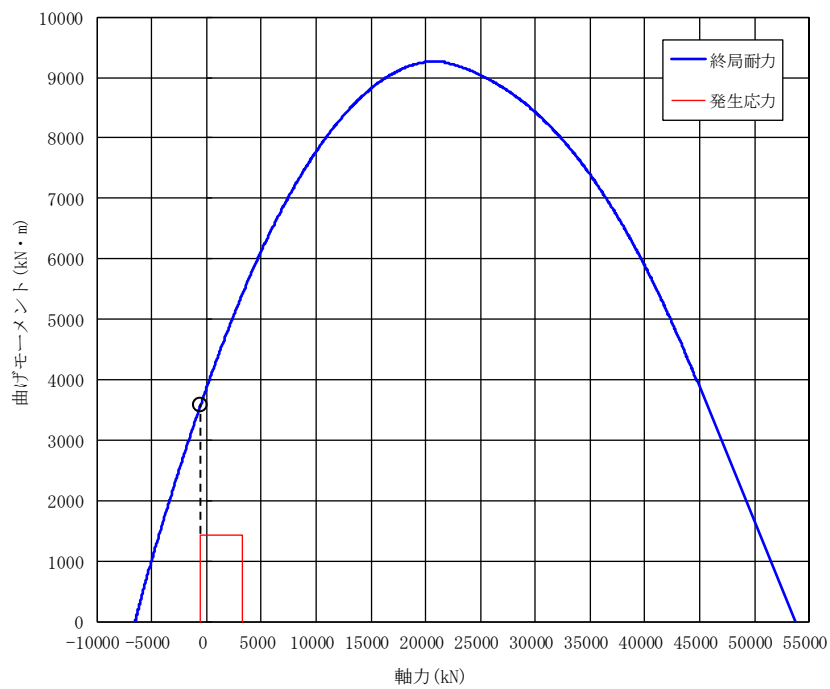

(b) P2

第5.2.3-2図 杭の軸力及び曲げモーメントに対する評価結果

(2) 支持力及び引抜力に対する評価結果

「4.4.3(5) 支持力及び引抜力に対する評価方法」に基づいた評価結果を以下に示す。

支持力及び引抜力に対する評価結果は、杭種ごとに、許容限界に対する軸力の割合が最も大きい杭に対して示す。当該の杭の位置を第5.2.3-3図に、評価結果を第5.2.3-3表に示す。

支持力及び引抜力が、それぞれの許容限界を超えないことを確認した。

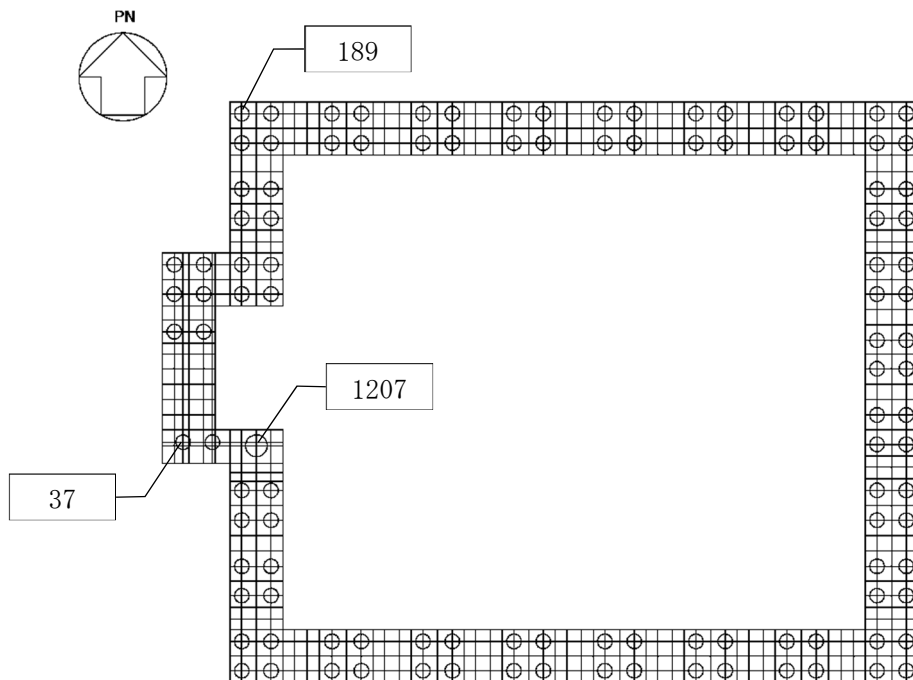

注：□内の数値は節点番号

第5.2.3-3図 評価結果を記載する杭の位置

第5.2.3-3表 支持力及び引抜力に対する評価結果

項目	杭種	応力の組合せ結果			許容限界 (kN)	検定比	判定
		節点 番号*1	ケース*1	軸力*2 (kN)			
支持力	P1, P1A	37	1-12	1959	12635	0.16	OK
	P2	1207	1-3	3422	21898	0.16	OK
引抜力	P1, P1A	189	1-2	-1173	5022	0.24	OK
	P2	1207	1-2	-561	7672	0.08	OK

注記 *1：基礎梁の評価における節点番号及びケースを示す。

*2：軸力は正が圧縮，負が引張を示す。

別紙4-22

水平2方向及び鉛直方向地震力の 組合せに関する影響評価結果 建物・構築物 建物及び屋外機械基礎

本添付書類は、別で定める方針に沿った評価・計算を示す書類であり、結果を示すものであることから、発電炉との比較は行わない。
また、図書番号や数値は最終精査中。

目 次

	ページ
1. 概要	1
2. 水平 2 方向及び鉛直方向地震力の組合せによる影響評価に用いる地震動	1
3. 水平 2 方向及び鉛直方向地震力の組合せによる影響評価結果	1
3.1 影響評価部位の抽出	1
3.2 影響評価部位の抽出結果	8
3.3 影響評価	9
3.4 影響評価結果	9
3.5 まとめ	9
IV-2-3-1-1-1 別紙 1 安全冷却水 B 冷却塔基礎の水平 2 方向及び鉛直方向地震力の組合せに関する影響評価結果	

1. 概要

本資料は、「IV-1-1 耐震設計の基本方針」及び「IV-1-1-7 水平2方向及び鉛直方向地震力の組合せに関する影響評価方針」に基づき、水平2方向及び鉛直方向地震力の組合せにより、建物・構築物(本資料においては、建物及び屋外機械基礎とし、洞道、竜巻防護対策設備及び排気筒は含まない。)(以下、「建物・構築物」という。)が有する耐震性に及ぼす影響について評価した結果を説明するものである。

2. 水平2方向及び鉛直方向地震力の組合せによる影響評価に用いる地震動

水平2方向及び鉛直方向地震力の組合せによる影響評価には、基準地震動 S_s を用いる。基準地震動 S_s は、「IV-1-1-1 基準地震動 S_s 及び弾性設計用地震動 S_d の概要」による。

ここで、水平2方向及び鉛直方向地震力の組合せによる影響評価に用いる基準地震動 S_s は、複数の基準地震動 S_s における地震動の特性及び包絡関係を、施設の特性による影響も考慮した上で確認し、本影響評価に用いる。

3. 水平2方向及び鉛直方向地震力の組合せによる影響評価結果

3.1 影響評価部位の抽出

建物・構築物において、従来設計手法に対して水平2方向及び鉛直方向地震力の組合せを考慮した場合に影響を受ける可能性がある部位を抽出し影響検討を行う。

(1) 耐震評価上の構成部位の整理

建物・構築物の耐震評価上の構成部位を整理し、該当する耐震評価上の構成部位を網羅的に確認した。確認した結果を第3.1-1表に示す。

(2) 水平2方向及び鉛直方向地震力の影響が想定される応答特性の整理

建物・構築物における耐震評価上の構成部位について、水平2方向及び鉛直方向地震力の組合せによる影響が想定される応答特性を整理した。応答特性は、荷重の組合せによる影響が想定されるもの及び3次元的な建屋挙動から影響が想定されるものに分けて整理した。整理した結果を第3.1-2表及び第3.1-3表に示す。

(3) 荷重の組合せによる応答特性が想定される部位の抽出

第3.1-1表に示す耐震評価上の構成部位のうち、第3.1-2表に示す荷重の組合せによる応答特性により、水平2方向及び鉛直方向地震力の組合せによる影響が想定される部位を抽出した。抽出した結果を第3.1-4表に示す。

応答特性①-1「直交する水平2方向の荷重が、応力として集中」する部位として、安全冷却水B冷却塔基礎の基礎スラブを抽出した。

応答特性①-2「面内方向の荷重を負担しつつ、面外方向の荷重が作用」する部位は抽出されなかった。

(4) 3次元的な応答特性が想定される部位の整理

第 3.1-1 表に示す耐震評価上の構成部位のうち、第 3.1-3 表に示す 3 次元的な応答特性により、水平 2 方向及び鉛直方向地震力の影響が想定される部位を整理した。整理した結果を第 3.1-5 表に示す。

応答特性②-1「面内方向の荷重に加え、面外慣性力の影響が大きい」可能性がある部位として、該当する部位はなかった。

応答特性②-2「加振方向以外の方向に励起される振動が発生する」可能性がある部位として、該当する部位はなかった。

第 3.1-1 表 建物・構築物における耐震評価上の構成部位の整理

対象評価部位		安全冷却水B冷却塔基礎
		RC造（基礎）
柱	一般部	—
	地下部	—
	隅部	—
梁	一般部	—
	地下部	—
	鉄骨 トラス	—
壁	一般部	—
	地下部	—
	鉄骨 ブレース	—
床屋根	一般部	—
基礎 スラブ	矩形	○
	矩形以外	—

凡例 ○：対象の構造部材が存在する

—：対象の部材が存在しない

第 3.1-2 表 水平 2 方向及び鉛直方向地震力の組合せによる影響が想定される応答特性
(荷重の組合せによる応答特性)

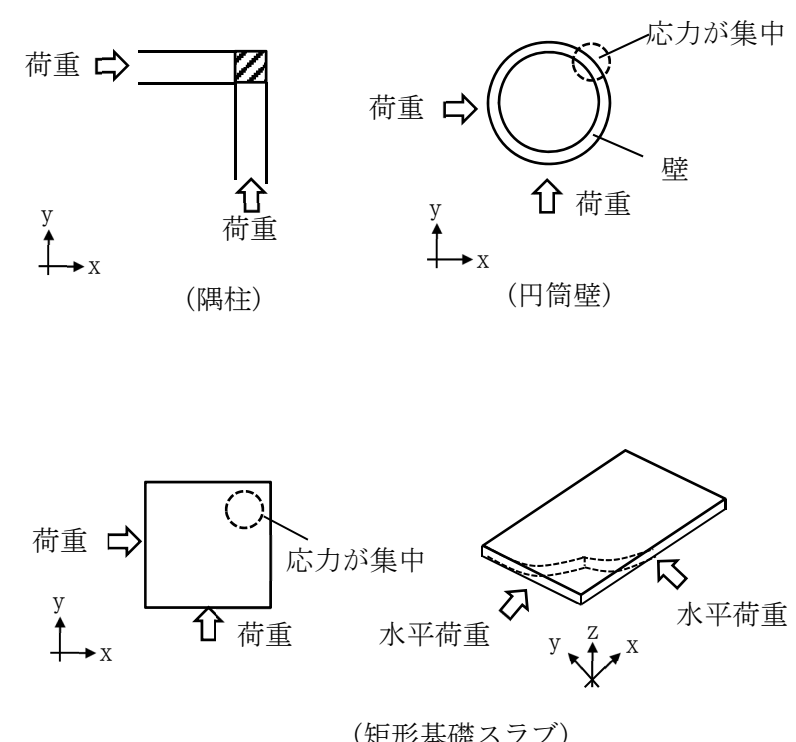
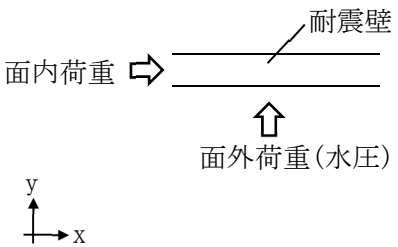
荷重の組合せによる 応答特性	影響想定部位
<p>①-1</p> <p>直交する水平 2 方向の荷重 が、応力とし て集中</p>	<p>応力の集中する隅柱等 (例)</p>  <p>荷重 → (隅柱) ↑ 荷重</p> <p>応力が集中 壁 ↑ 荷重 (円筒壁)</p> <p>応力が集中 ↑ 荷重 水平荷重 (矩形基礎スラブ) 水平荷重</p>
<p>①-2</p> <p>面内方向の荷 重を負担しつ つ、面外方向 の荷重が作用</p>	<p>水圧を負担するプール等 (例)</p>  <p>面内荷重 → 耐震壁 ↑ 面外荷重(水圧)</p>

第 3.1-3 表 水平 2 方向及び鉛直方向地震力の組合せによる影響が想定される応答特性
(3 次元的な応答特性)

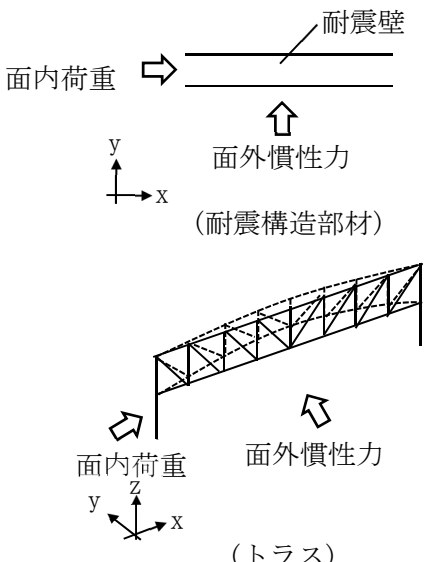
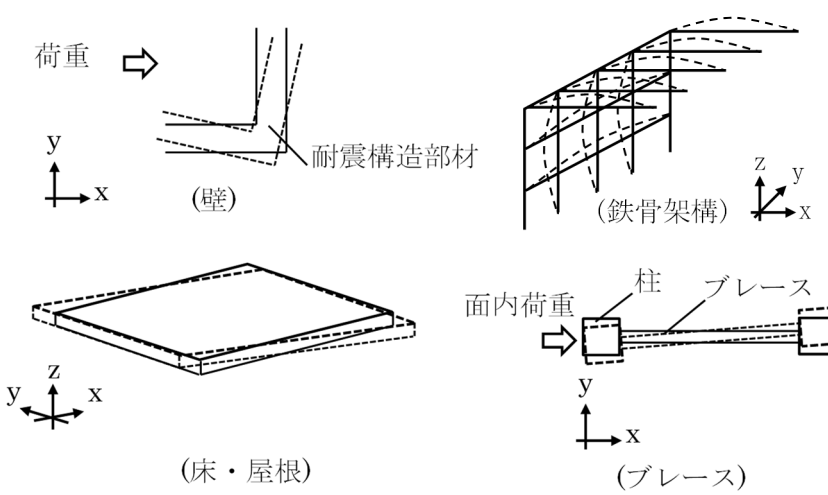
3 次元的な 応答特性	影響想定部位
<p>②-1</p> <p>面内方向の荷重に加え、面外慣性力の影響が大きい</p>	<p>大スパンや吹き抜け部に設置された部位 (例)</p>  <p>耐震壁</p> <p>面内荷重</p> <p>面外慣性力 (耐震構造部材)</p> <p>面内荷重</p> <p>面外慣性力 (トラス)</p>
<p>②-2</p> <p>加振方向以外の方に励起される振動</p>	<p>塔状構造物などを含む、ねじれ挙動が想定される建物・構築物 (例)</p>  <p>荷重</p> <p>耐震構造部材 (壁)</p> <p>(床・屋根)</p> <p>面内荷重</p> <p>柱 ブレース (ブレース)</p> <p>(鉄骨架構)</p>

第 3.1-4 表 水平 2 方向及び鉛直方向地震力の組合せによる
影響の確認が必要な部位の抽出
(荷重の組合せによる応答特性を踏まえたスクリーニング)

対象評価部位		安全冷却水B冷却塔基礎
		RC造（基礎）
柱	一般部	—
	地下部	—
	隅部	—
梁	一般部	—
	地下部	—
	鉄骨 トラス	—
壁	一般部	—
	地下部	—
	鉄骨 ブレース	—
床屋根	一般部	—
基礎 スラブ	矩形	①-1要
	矩形以外	—

凡例 ①-1 要：応答特性①-1「直交する水平 2 方向の荷重が、応力として集中」
—：対象の構造部材が存在しない

第 3.1-5 表 水平 2 方向及び鉛直方向地震力の組合せによる
影響の確認が必要な部位の抽出
(3 次元的な応答特性を踏まえたスクリーニング)

対象評価部位		安全冷却水B冷却塔基礎
		RC造（基礎）
柱	一般部	—
	地下部	—
	隅部	—
梁	一般部	—
	地下部	—
	鉄骨 トラス	—
壁	一般部	—
	地下部	—
	鉄骨 ブレース	—
床屋根	矩形	—
基礎 スラブ	矩形以外	該当無し
	矩形以外	—

凡例 該当無し：応答特性②-1 または②-2 に該当しない

—：対象の構造部位が存在しない

3.2 影響評価部位の抽出結果

(1) 建物・構築物における影響評価部位の抽出結果

建物・構築物において、水平 2 方向及び鉛直方向地震力の組合せによる影響が想定されるとして抽出した部位を第 3.2-1 表に示す。

応答特性①-1「直交する水平 2 方向の荷重が、応力として集中」する部位のうち、安全冷却水 B 冷却塔基礎の基礎スラブについて、水平 2 方向及び鉛直方向地震力の組合せによる影響評価を行う。

第 3.2-1 表 水平 2 方向及び鉛直方向地震力の組合せによる影響評価部位の抽出結果

応答特性	耐震評価部位		対象建物・構築物
	基礎スラブ	矩形	
①-1	基礎スラブ	矩形	安全冷却水 B 冷却塔基礎

凡例 ①-1：応答特性①-1「直交する水平 2 方向の荷重が、応力として集中」

(2) 機器・配管系への影響が考えられる部位の抽出結果

水平 2 方向及び鉛直方向地震力の組合せの影響評価対象として抽出した耐震評価上の構成部位のうち、間接支持構造物のものについて、3 次元的な挙動による応答増幅の観点から機器・配管系への影響の可能性が想定される部位を抽出する。

安全冷却水 B 冷却塔の基礎スラブについては、水平 2 方向及び鉛直方向地震力の組合せにより応力集中する部位であり、水平 2 方向及び鉛直方向地震力の組合せによる応答値への影響がないため、機器・配管系への影響の可能性はない。

3.3 影響評価

荷重の組合せによる応答特性より影響が想定される部位として抽出された部位については、構造部材の発生応力等を適切に組合せることで、各部位の設計上の許容値に対する評価を実施し、各部位の耐震性への影響を評価する。

水平 2 方向及び鉛直方向地震力の組合せによる影響評価においては、水平 2 方向及び鉛直方向地震力を組合せる方法として、米国 REGULATORY GUIDE 1.92 の「2. Combining Effects Caused by Three Spatial Components of an Earthquake」を参考として、組合せ係数法(1.0:0.4:0.4)に基づいて地震力を設定する。なお、組合せる荷重又は応力としては、水平 1 方向及び鉛直方向地震力の組合せによる局部評価の荷重又は応力の算出結果を用いる。

3.4 影響評価結果

建物・構築物の水平 2 方向及び鉛直方向地震力の組合せによる影響評価結果は、「IV-2-3-1-1-1 別紙 1 安全冷却水 B 冷却塔基礎の水平 2 方向及び鉛直方向地震力の組合せに関する影響評価結果」に示す。

3.5 まとめ

安全冷却水 B 冷却塔の基礎において、水平 2 方向及び鉛直方向地震力の組合せによる影響を受ける可能性がある耐震評価部位を抽出し、その部位における従来の水平 1 方向及び鉛直方向地震力の組合せによる設計に対して影響を確認した。その結果、水平 2 方向及び鉛直方向地震力の組合せによる応力は、水平 1 方向及び鉛直方向地震力の組合せに対し、増加する傾向にあるが、水平 2 方向及び鉛直方向地震力の組合せによる応力が許容値を満足することを確認した。

以上より、水平 2 方向及び鉛直方向地震力の組合せについては、安全冷却水 B 冷却塔の基礎が有する耐震性への影響がないことを確認した。

IV—2—3—1—1—1

別紙1 安全冷却水B冷却塔基礎の
水平2方向及び鉛直方向地震力の組
合せに関する影響評価結果

目 次

	ページ
1. 構造概要	1
2. 基礎スラブの評価	2

1. 構造概要

安全冷却水B冷却塔基礎の主体構造は鉄筋コンクリート造である。平面規模は主要部分で■■■m(NS)×■■■m(EW)であり、厚さは■■■mである。

主要耐震要素は、鉄筋コンクリート造の基礎スラブである。また、基礎スラブはマンメイドロックを介して岩盤に設置されている。安全冷却水B冷却塔基礎の概略平面図及び概略断面図は「IV-2-1-1-1-1-1 安全冷却水B冷却塔基礎の地震応答計算書」に示す。

2. 基礎スラブの評価

S_s地震時を対象として、直交する水平2方向の荷重が、応力として集中する部位である安全冷却水B冷却塔基礎の基礎スラブについて、水平2方向及び鉛直方向地震力の組合せによる影響評価を実施する。

基礎スラブについて、基準地震動S_sによる地震力を水平2方向及び鉛直方向に作用させ、FEMモデルを用いた弾性応力解析を実施する。FEM解析による断面の評価は、「IV-2-1-1-1-1-2 安全冷却水B冷却塔基礎の耐震計算書」に基づくこととする。

地震荷重は、「IV-2-1-1-1-1-1 安全冷却水B冷却塔基礎の地震応答計算書」にて、基準地震動S_sにより算定される動的地震力を用いる。

地震荷重以外の荷重については「IV-2-1-1-1-1-2 安全冷却水B冷却塔基礎の耐震計算書」に基づいて評価を実施する。

荷重の組合せは「IV-2-1-1-1-1-2 安全冷却水B冷却塔基礎の耐震計算書」にて設定されている荷重及び荷重の組合せを用いる。

基礎スラブのモデル化においては、シェル要素にてモデル化する。また、基礎スラブ底面に水平方向及び鉛直方向の地盤ばねを設ける。なお、基礎スラブ底面に設置した地盤ばねについては、引張力が発生したときに浮上りを考慮する。解析モデルの節点数は146、要素数は122である。解析モデルを第2.-1図に示す。コンクリートの物性値を第2.-1表に、鉄筋コンクリートの単位体積重量を第2.-2表に示す。

評価方法として、軸力及び曲げモーメントと面外せん断力に対して応力評価を行い、発生する応力が「原子力施設鉄筋コンクリート構造計算規準・同解説((社)日本建築学会, 2005)」に基づく許容限界を超えないことを確認する。

評価結果を記載する要素の位置(許容限界に対する解析結果の割合が最大となる要素)を第2.-2図及び第2.-3図、評価結果を第2.-3表及び第2.-4表に示す。

評価の結果、S_s地震時における水平2方向及び鉛直方向地震力の組合せによる発生曲げモーメント及び発生面外せん断力が、それぞれの許容限界を超えないこと確認した。

ここで、水平1方向及び鉛直方向地震力の組合せに対する評価結果と水平2方向及び鉛直方向地震力の組合せに対する評価結果を比較すると、水平2方向及び鉛直方向地震力の組合せによる発生応力は、水平1方向及び鉛直方向地震力の組合せに対し、増加する傾向であるが、水平2方向及び鉛直方向地震力の組合せによる応力が許容値を満足することを確認した。

以上のことから、水平2方向及び鉛直方向地震力の組合せに対し、基礎スラブが有する耐震性への影響はないことを確認した。

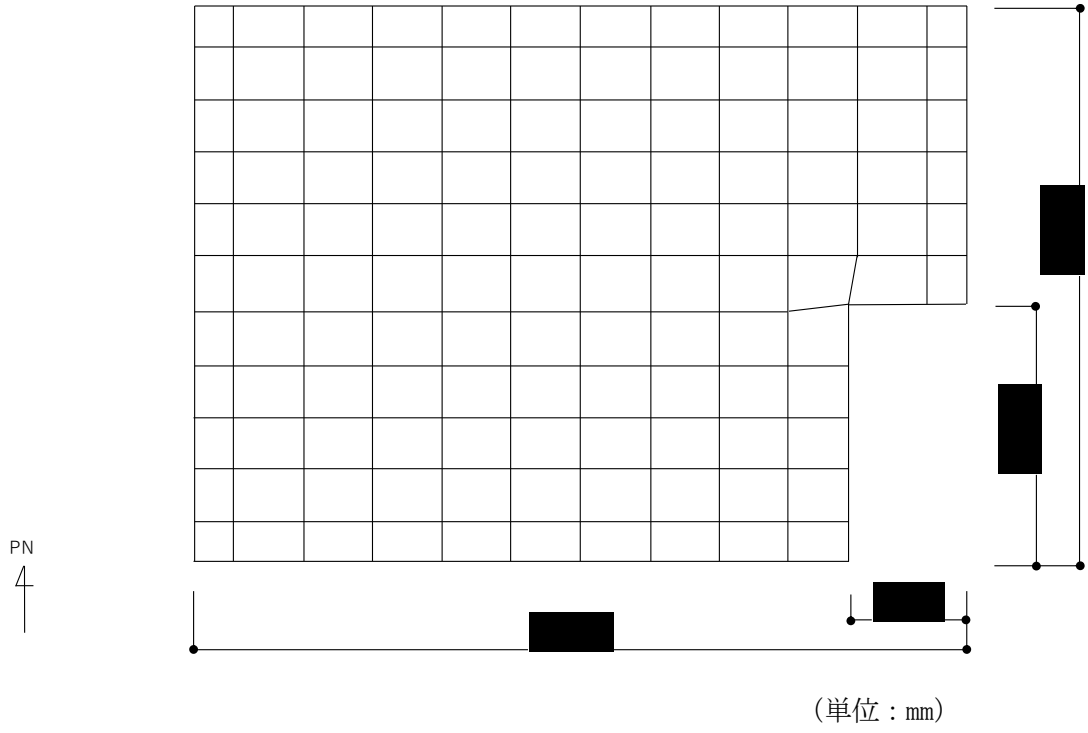

第 2. -1 図 解析モデル

第 2. -1 表 コンクリートの物性値

設計基準強度 Fc (N/mm ²)	ヤング係数 Ec (N/mm ²)	ポアソン比 ν
23.5 (Fc=240kgf/cm ²)	2.25×10 ⁴	0.2

第2. -2表 鉄筋コンクリートの単位体積重量

単位体積重量 (kN/m ³)
24

PN
4
|

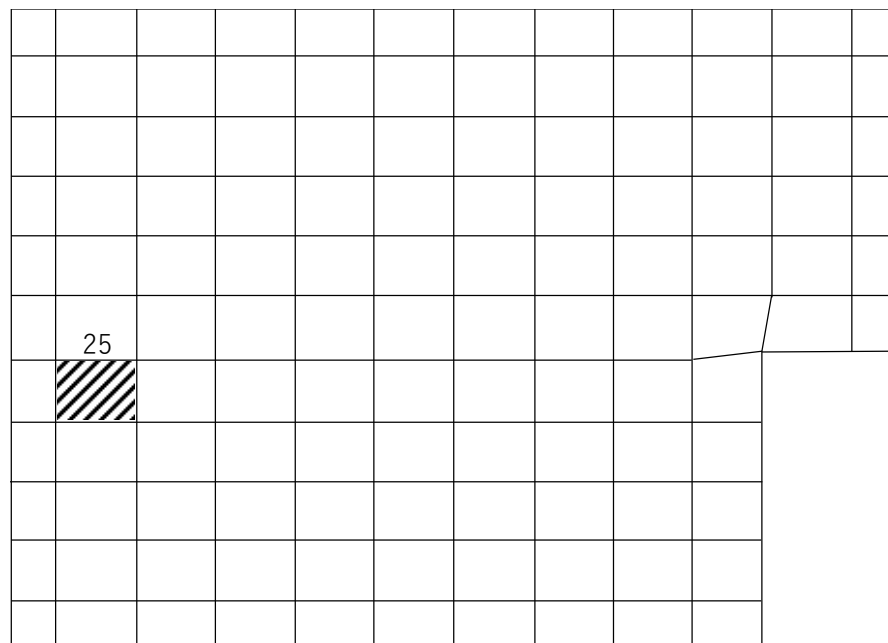

(a) NS方向 水平2方向+鉛直
(要素 No. 25)

PN
4
|



(b) NS方向 水平1方向+鉛直
(要素No. 5)

第2.-2図 軸力及び曲げモーメントに対する評価結果を示す要素の位置図(1/2)

PN
4
↑

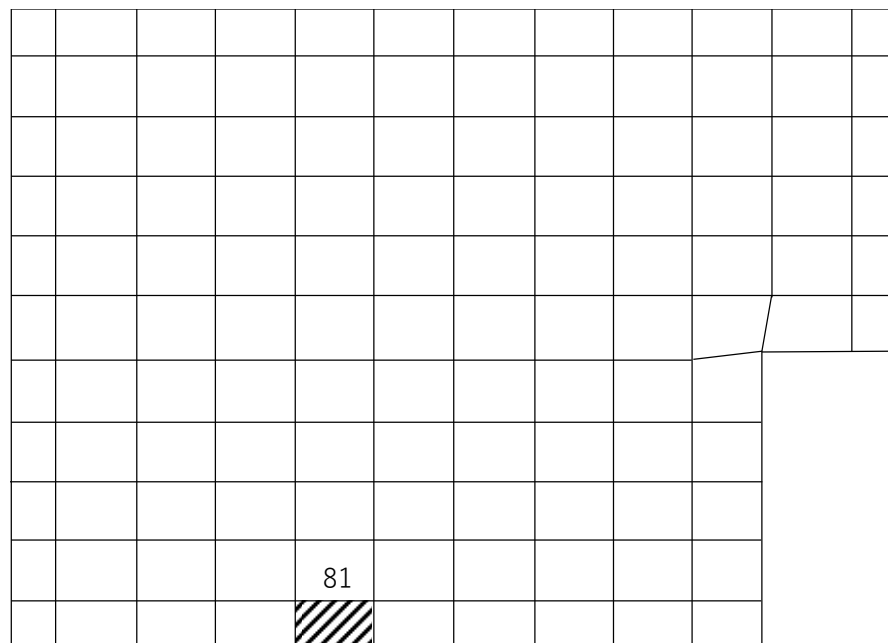

(c) EW方向 水平2方向+鉛直
(要素No. 81)

PN
4
↑

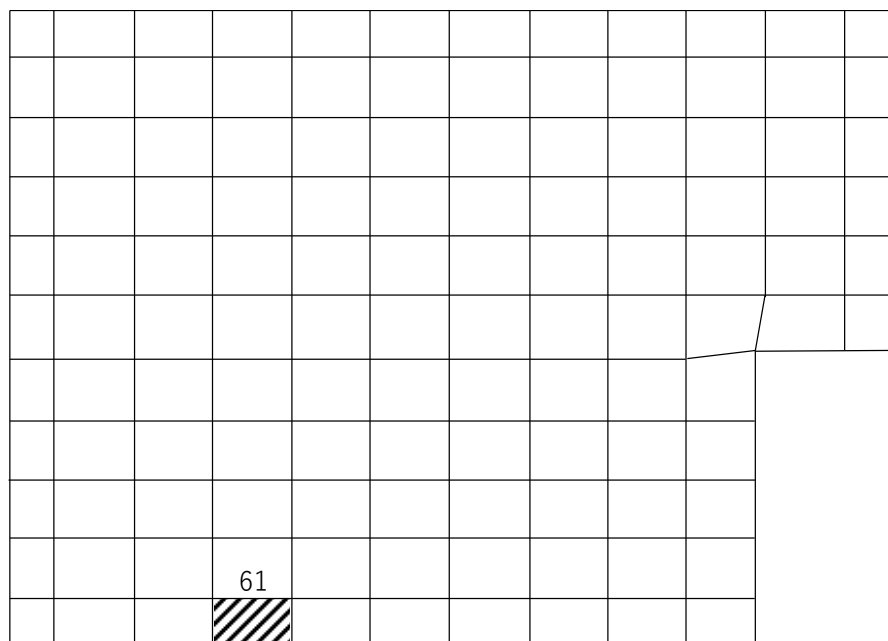

(d) EW方向 水平1方向+鉛直
(要素No. 61)

第2.-2図 軸力及び曲げモーメントに対する評価結果を示す要素の位置図(2/2)

PN
4
|

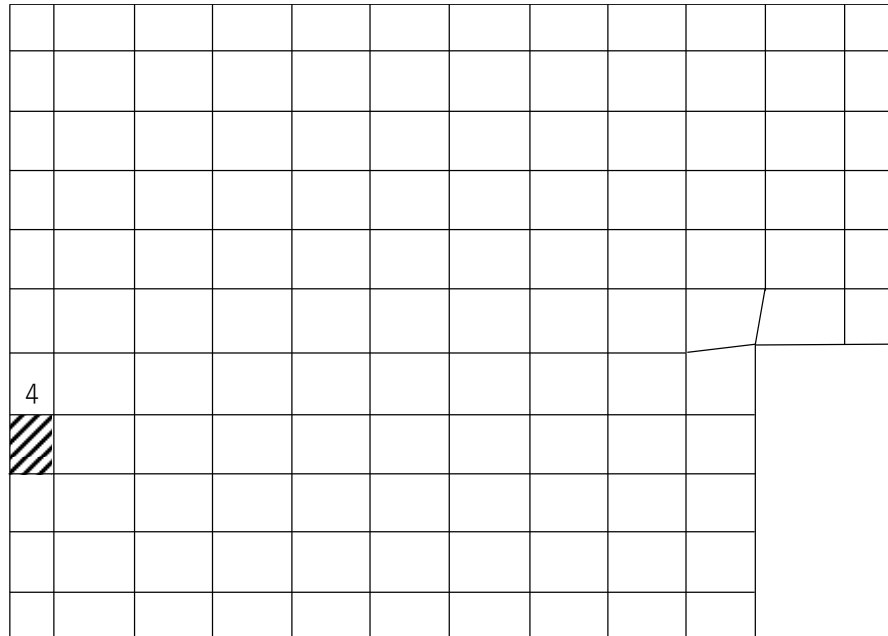

(a) NS方向 水平2方向+鉛直
(要素 No. 4)

PN
4
|



(b) NS方向 水平1方向+鉛直
(要素 No. 6)

第2.-3図 面外せん断力に対する評価結果を示す要素の位置図(1/2)

PN
4
|

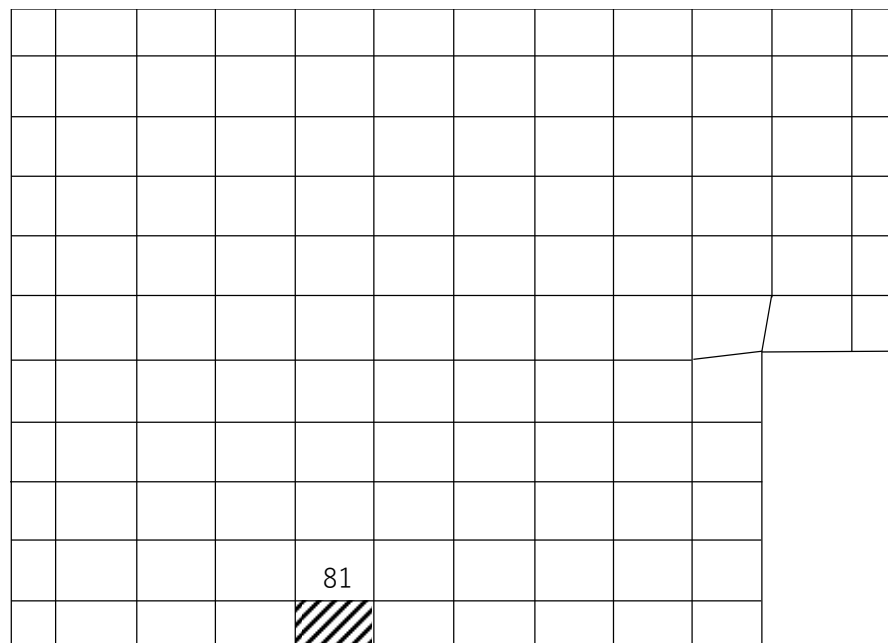

(c) EW方向 水平2方向+鉛直
(要素 No. 81)

PN
4
|

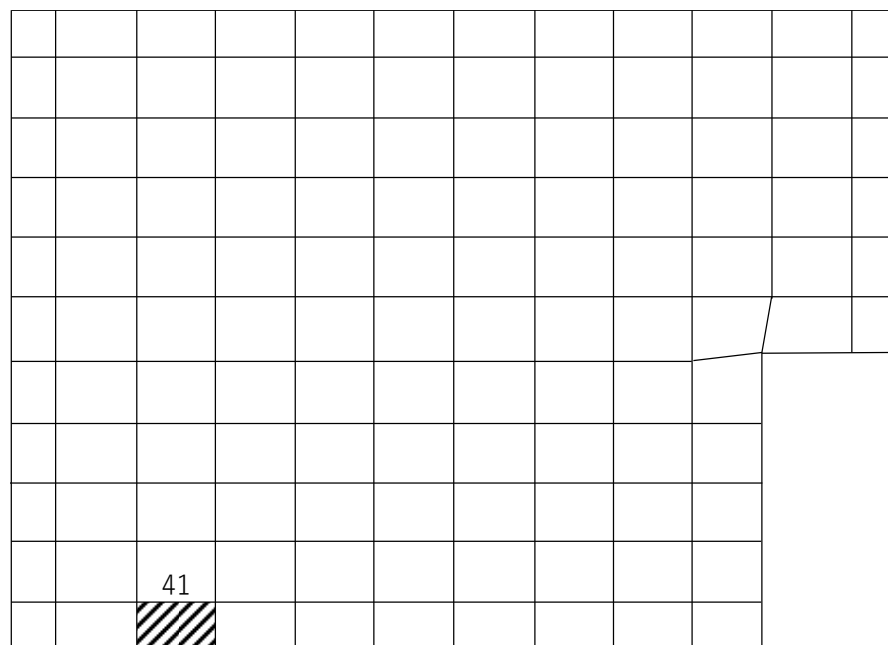

(d) EW方向 水平1方向+鉛直
(要素 No. 41)

第2.-3図 面外せん断力に対する評価結果を示す要素の位置図(2/2)

第2.-3表 軸力及び曲げモーメントに対する評価結果

(a) 水平2方向及び鉛直方向地震力の組合せ

方向	解析結果		許容値 (kN・m/m)	検定比	判定
	要素番号	発生曲げモーメント (kN・m/m)			
NS	25	1540	1806	0.853	OK
EW	81	884	1884	0.470	OK

注記 1：許容値は曲げ終局強度を示す。

2：検定比＝(発生曲げモーメント)/(許容値)

3：軸力は圧縮を正とする。

(b) 水平1方向及び鉛直方向地震力の組合せ

方向	解析結果		許容値 (kN・m/m)	検定比	判定
	要素番号	発生曲げモーメント (kN・m/m)			
NS	5	1248	1972	0.633	OK
EW	61	647	2006	0.323	OK

注記 1：許容値は曲げ終局強度を示す。

2：検定比＝(発生曲げモーメント)/(許容値)

3：軸力は圧縮を正とする。

第2.-4表 面外せん断力に対する評価結果

(a) 水平2方向及び鉛直方向地震力の組合せ

方向	解析結果		許容値 (kN/m)	検定比	判定
	要素番号	発生面外せん断力 (kN/m)			
NS	4	327	850	0.385	OK
EW	81	208	783	0.266	OK

注記 1：許容値は面外せん断終局強度を示す。

2：検定比＝(発生面外せん断力)/(許容値)

(b) 水平1方向及び鉛直方向地震力の組合せ

方向	解析結果		許容値 (kN/m)	検定比	判定
	要素番号	発生面外せん断力 (kN/m)			
NS	6	388	1565	0.249	OK
EW	41	178	1230	0.145	OK

注記 1：許容値は面外せん断終局強度を示す。

2：検定比＝(発生面外せん断力)/(許容値)

別紙4－23

水平2方向及び鉛直方向地震力の 組合せに関する影響評価結果 建物・構築物 竜巻防護対策設備

本添付書類は、別で定める方針に沿った評価・計算を示す書類であり、結果を示すものであることから、発電炉との比較は行わない。

目 次

ページ

1. 概要	1
2. 水平 2 方向及び鉛直方向地震力の組合せによる影響評価に用いる地震動	1
3. 水平 2 方向及び鉛直方向地震力の組合せによる影響評価結果	1
3.1 影響評価部位の抽出	1
3.2 影響評価部位の抽出結果	8
4. 影響評価	11
5. 影響評価結果	11
6. まとめ	11

1. 概要

本資料は、添付書類「IV-1-1 耐震設計の基本方針」及び添付書類「IV-1-1-7 水平2方向及び鉛直方向地震力の組合せに関する影響評価方針」に基づき、水平2方向及び鉛直方向地震力の組合せにより、竜巻防護対策設備が有する耐震性に及ぼす影響について評価した結果を説明するものである。

2. 水平2方向及び鉛直方向地震力の組合せによる影響評価に用いる地震動

水平2方向及び鉛直方向地震力の組合せによる影響評価には、基準地震動 S_s を用いる。基準地震動 S_s は、添付書類「IV-1-1-1 基準地震動 S_s 及び弾性設計用地震動 S_d の概要」による。

ここで、水平2方向及び鉛直方向地震力の組合せによる影響評価に用いる基準地震動 S_s は、複数の基準地震動 S_s における地震動の特性及び包絡関係を、施設の特性による影響も考慮した上で確認し、本影響評価に用いる。

3. 水平2方向及び鉛直方向地震力の組合せによる影響評価結果

3.1 影響評価部位の抽出

竜巻防護対策設備において、従来設計手法に対して水平2方向及び鉛直方向地震力の組合せを考慮した場合に影響を受ける可能性がある部位を抽出し影響検討を行う。

なお、後次回申請の竜巻防護対策設備に対する結果については、各申請回次で示す。

(1) 耐震評価上の構成部位の整理

竜巻防護対策設備の耐震評価上の構成部位を整理し、該当する耐震評価上の構成部位を網羅的に確認した。確認した結果を第3.1-1表に示す。

(2) 水平2方向及び鉛直方向地震力の影響が想定される応答特性の整理

竜巻防護対策設備における耐震評価上の構成部位について、水平2方向及び鉛直方向地震力の組合せによる影響が想定される応答特性を整理した。応答特性は、荷重の組合せによる影響が想定されるもの及び3次元的な建屋挙動から影響が想定されるものに分けて整理した。整理した結果を第3.1-2表及び第3.1-3表に示す。

(3) 荷重の組合せによる応答特性が想定される部位の抽出

第 3.1-1 表に示す耐震評価上の構成部位のうち、第 3.1-2 表に示す荷重の組合せによる応答特性により、水平 2 方向及び鉛直方向地震力の組合せによる影響が想定される部位を抽出した。抽出した結果を第 3.1-4 表に示す。

応答特性①-1「直交する水平 2 方向の荷重が、応力として集中」する部位として、飛来物防護ネット(再処理設備本体用 安全冷却水系冷却塔 B)の柱(隅部)、梁(一般部及び鉄骨トラス)、壁(鉄骨ブレース)、基礎梁及び杭を抽出した。

応答特性①-2「面内方向の荷重を負担しつつ、面外方向の荷重が作用」する部位は抽出されなかった。

(4) 3 次元的な応答特性が想定される部位の抽出

第 3.1-1 表に示す耐震評価上の構成部位のうち、第 3.1-3 表に示す 3 次元的な応答特性により、3 方向の応答の同時性を考慮することによる応答への影響が想定される部位を抽出した。抽出した結果を第 3.1-5 表に示す。

応答特性②-1「面内方向の荷重に加え、面外慣性力の影響が大きい」可能性のある部位は抽出されなかった。

応答特性②-2「加振方向以外の方向に励起される振動が発生する」可能性のある部位は抽出されなかった。

なお、後次回申請の竜巻防護対策設備に対する抽出結果については、各申請回次において精査した結果を示す。

第 3.1-1 表 竜巻防護対策設備における耐震評価上の構成部位の整理

対象評価部位		飛来物防護ネット (再処理設備本体用 安全冷却水系冷却塔 B)
		支持架構：鉄骨造 基礎梁, 杭：RC 造
柱	一般部	—
	地下部	—
	隅部	○
梁	一般部	○
	地下部	—
	鉄骨 トラス	○
壁	一般部	—
	地下部	—
	鉄骨 ブレース	○
床屋根	一般部	—
基礎スラブ	矩形	—
	矩形以外	—
基礎梁		○
杭		○

凡例 ○：対象の構造部材有り,
—：対象の部材なし

第 3.1-2 表 水平 2 方向及び鉛直方向地震力の組合せによる影響が想定される応答特性
(荷重の組合せによる応答特性)

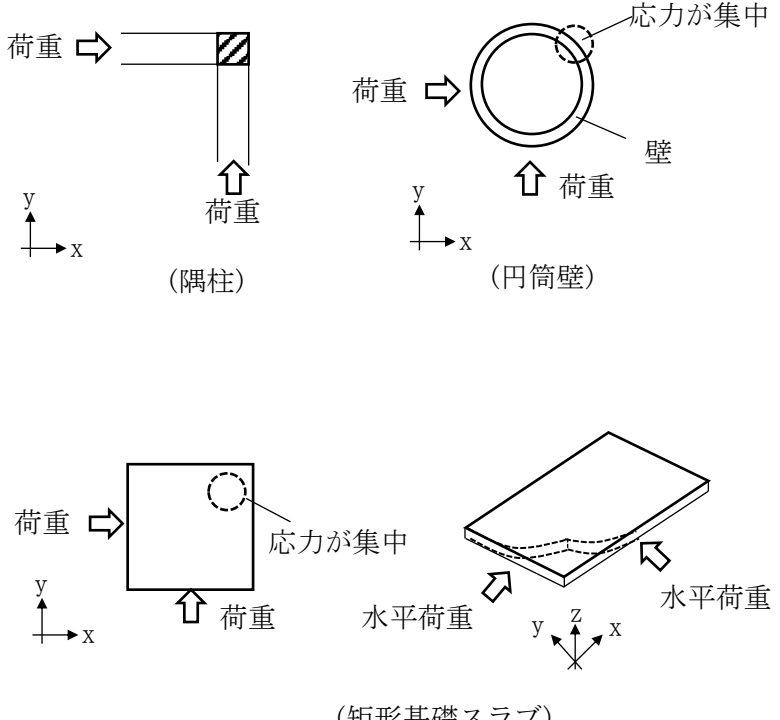
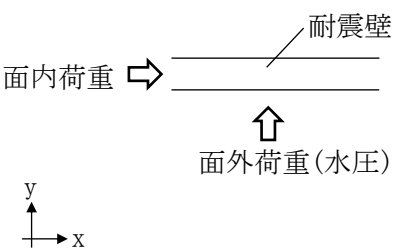
荷重の組合せによる 応答特性	影響想定部位
<p>①-1</p> <p>直交する水平 2 方向の荷重が、応力として集中</p>	<p>応力の集中する隅柱等 (例)</p>  <p>荷重 → (隅柱)</p> <p>応力が集中</p> <p>壁</p> <p>荷重 → (円筒壁)</p> <p>↑ 荷重</p> <p>応力が集中</p> <p>水平荷重</p> <p>水平荷重</p> <p>(矩形基礎スラブ)</p>
<p>①-2</p> <p>面内方向の荷重を負担しつつ、面外方向の荷重が作用</p>	<p>水圧を負担するプール等 (例)</p>  <p>面内荷重 →</p> <p>耐震壁</p> <p>↑</p> <p>面外荷重(水圧)</p>

第 3.1-3 表 水平 2 方向及び鉛直方向地震力の組合せによる影響が想定される応答特性
(3 次元的な応答特性)

3 次元的な応答特性		影響想定部位
②-1	面内方向の荷重に加え、面外慣性力の影響が大きい	<p>大スパンや吹き抜け部に設置された部位 (例)</p> <p>耐震壁</p> <p>面内荷重</p> <p>面外慣性力</p> <p>(耐震構造部材)</p> <p>面内荷重</p> <p>面外慣性力</p> <p>(トラス)</p>
②-2	加振方向以外の方向に励起される振動	<p>塔状構造物などを含む、ねじれ挙動が想定される建物・構築物 (例)</p> <p>荷重</p> <p>耐震構造部材</p> <p>(壁)</p> <p>(鉄骨架構)</p> <p>(床・屋根)</p> <p>柱</p> <p>ブレース</p> <p>面内荷重</p> <p>(ブレース)</p>

第 3.1-4 表 水平 2 方向及び鉛直方向地震力の組合せによる
影響の確認が必要な部位の抽出
(荷重の組合せによる応答特性を踏まえたスクリーニング)

対象評価部位		飛来物防護ネット (再処理設備本体用 安全冷却水系冷却塔 B)
		支持架構：鉄骨造 基礎梁，杭：RC 造
柱	一般部	—
	地下部	—
	隅部	①-1 要
梁	一般部	①-1 要
	地下部	—
	鉄骨 トラス	①-1 要
壁	一般部	—
	地下部	—
	鉄骨 ブレース	①-1 要
床屋根	一般部	—
基礎スラブ	矩形	—
	矩形以外	—
基礎梁		①-1 要
杭		①-1 要

凡例 ①-1 要：応答特性①-1「直交する水平 2 方向の荷重が応力として集中」

①-2 要：応答特性①-2「面内方向の荷重を負担しつつ，面外方向の荷重が作用」

—：対象の構造部位が存在しない

第 3.1-5 表 水平 2 方向及び鉛直方向地震力の組合せによる
影響の確認が必要な部位の抽出
(3 次元的な応答特性を踏まえたスクリーニング)

対象評価部位		飛来物防護ネット (再処理設備本体用 安全冷却水系冷却塔 B)
		支持架構：鉄骨造 基礎梁，杭：RC 造
柱	一般部	—
	地下部	—
	隅部	①-1 要
梁	一般部	①-1 要
	地下部	—
	鉄骨 トラス	①-1 要
壁	一般部	—
	地下部	—
	鉄骨 ブレース	①-1 要
床屋根	一般部	—
基礎スラブ	矩形	—
	矩形以外	—
基礎梁		①-1 要
杭		①-1 要

凡例 ①-1要：応答特性①-1「直交する水平 2 方向の荷重が応力として集中」でのスクリーニングで抽出済み

①-2要：応答特性①-2「面内方向の荷重を負担しつつ，面外方向の荷重が作用」でのスクリーニングで抽出済み

—：対象の構造部位が存在しない

3.2 影響評価部位の抽出結果

(1) 荷重の組合せによる応答特性が想定される部位の抽出結果

竜巻防護対策設備において、荷重の組合せによる応答特性による影響が想定される部位を抽出した結果を第3.2-1表に示す。

応答特性①-1「直交する水平2方向の荷重が、応力として集中」する部位として、飛来物防護ネット(再処理設備本体用 安全冷却水系冷却塔B)の柱(隅部)、梁(一般部及び鉄骨トラス)、壁(鉄骨ブレース)、基礎梁及び杭を抽出した。

飛来物防護ネット(再処理設備本体用 安全冷却水系冷却塔B)においては、応答特性①-2「面内方向の荷重を負担しつつ、面外方向の荷重が作用」する部位としては、抽出されなかった。

なお、後次回申請の竜巻防護対策設備に対する抽出結果については、各申請回次で示す。

第3.2-1表 水平2方向及び鉛直方向地震力の組合せによる
影響評価部位の抽出結果

応答特性	耐震評価部位		対象竜巻防護対策設備
	柱	隅部	
①-1	梁	一般部	飛来物防護ネット(再処理設備本体用 安全冷却水系冷却塔B)
		鉄骨トラス	
	壁	鉄骨ブレース	
	基礎梁		
	杭		
①-2	該当なし		

(2) 3次元的な応答特性が想定される部位の抽出

竜巻防護対策設備において、「3.2(1) 荷重の組合せによる応答特性が想定される部位の抽出結果」で抽出されなかった部位に対し、3次元的な応答特性による影響が想定される部位を抽出した結果を第3.2-2表に示す。

飛来物防護ネット(再処理設備本体用 安全冷却水系冷却塔B)においては、「3.2(1) 荷重の組合せによる応答特性が想定される部位の抽出結果」で抽出されなかった部位は存在しないため、3次元的な応答特性による影響が想定される部位としては、抽出されなかった。

なお、後次回申請の竜巻防護対策設備に対する抽出結果については、各申請回次で示す。

第3.2-2表 水平2方向及び鉛直方向地震力の組合せによる
影響評価部位の抽出結果

応答特性	耐震評価部位	対象竜巻防護対策設備
2-①	該当無し	飛来物防護ネット(再処理設備本体用 安全冷却水系冷却塔B)
2-②	該当無し	

(3) 水平2方向及び鉛直方向地震力の影響評価部位の抽出結果一覧

竜巻防護対策設備の水平2方向及び鉛直方向地震力の組合せによる影響が想定される部位の抽出結果一覧を第3.2-3表に示す。

なお、後次回申請の竜巻防護対策設備においては、部位に作用する荷重を水平2方向及び鉛直方向に適切に組み合わせて耐震性への影響検討を行った結果を改めて示す。

第 3.2-3 表 竜巻防護対策設備における水平 2 方向及び鉛直方向地震力の
組合せによる影響評価部位の抽出結果一覧

応答 特性	耐震評価部位		対象竜巻防護対策設備
	①-1	柱	隅部
梁		一般部	・飛来物防護ネット(再処理設備本体用 安全冷却水 系冷却塔 B) 後次回申請にて示す
		鉄骨 トラス	・飛来物防護ネット(再処理設備本体用 安全冷却水 系冷却塔 B) 後次回申請にて示す
壁		鉄骨 ブレース	・飛来物防護ネット(再処理設備本体用 安全冷却水 系冷却塔 B) 後次回申請にて示す
基礎梁		・飛来物防護ネット(再処理設備本体用 安全冷却水 系冷却塔 B) 後次回申請にて示す	
杭		・飛来物防護ネット(再処理設備本体用 安全冷却水 系冷却塔 B) 後次回申請にて示す	
①-2	—	—	後次回申請にて示す
②-1	—	—	後次回申請にて示す
②-2	—	—	後次回申請にて示す

- 凡例 ①-1：応答特性①-1「直交する 2 方向の荷重が，応力として集中」
 ①-2：応答特性①-2「面内方向の荷重を負担しつつ，面外方向の荷重が作用」
 ②-1：応答特性②-1「面内方向の荷重に加え，面外慣性力の影響が大きい」
 ②-2：応答特性②-2「加振方向以外の方向に励起される振動」

4. 影響評価

荷重の組合せによる応答特性より影響が想定される部位として抽出された部位については、構造部材の発生応力等を適切に組合せることで、各部位の設計上の許容値に対する評価を実施し、各部位の耐震性への影響を評価する。

水平2方向及び鉛直方向地震力の組合せによる影響評価においては、水平2方向及び鉛直方向地震力を組合せる方法として、米国 REGULATORY GUIDE 1.92 の「2. Combining Effects Caused by Three Spatial Components of an Earthquake」を参考として、組合せ係数法(1.0:0.4:0.4)に基づいて地震力を設定する。なお、組合せる荷重又は応力としては、水平1方向及び鉛直方向地震力の組合せによる局部評価の荷重又は応力の算出結果を用いる。

5. 影響評価結果

飛来物防護ネット(再処理設備本体用 安全冷却水系冷却塔B)の水平2方向及び鉛直方向地震力の組合せによる影響評価結果は、別紙に示す。

なお、後次回申請の竜巻防護対策設備に対する結果については、各申請回次で示す。

6. まとめ

飛来物防護ネット(再処理設備本体用 安全冷却水系冷却塔B)において、水平2方向及び鉛直方向地震力の組合せによる影響を受ける可能性がある耐震評価部位を抽出し、その部位における従来の水平1方向及び鉛直方向地震力の組合せによる設計に対して影響を確認した。その結果、水平2方向及び鉛直方向地震力の組合せによる応力が許容値を満足することを確認した。

以上より、水平2方向及び鉛直方向地震力の組合せについては、飛来物防護ネット(再処理設備本体用 安全冷却水系冷却塔B)が有する耐震性への影響がないことを確認した。

なお、後次回申請の竜巻防護対策設備に対する結果については、各申請回次で示す。

IV-2-3-1-3-1 別紙1
飛来物防護ネット（再処理設備本体
用 安全冷却水系冷却塔B）の水平
2方向及び鉛直方向地震力の組合せ
に関する影響評価結果

目 次

ページ

1. 構造概要	1
2. 飛来物防護ネットの評価	8
2.1 支持架構の評価	8
2.2 基礎梁の評価	17
2.3 杭の評価	24
3. まとめ	33

1. 構造概要

飛来物防護ネット(再処理設備本体用 安全冷却水系冷却塔B)は、鉄骨造の支持架構、鉄筋コンクリート造の基礎梁及び杭によって構成される。

支持架構は、柱、大はり、小はり、トラス柱、鉛直ブレース及び水平ブレースからなるフレーム及び座屈拘束ブレースによって構成され、平面形状は、36.00m(NS方向)×47.90m(EW方向)であり、地上高さは、20.30mである。

座屈拘束ブレースは、中心鋼材を座屈拘束材(鋼管とモルタル)で拘束し、繰り返し作用する地震荷重に対して、安定的に塑性化することでエネルギーを吸収することにより、フレームに作用する荷重を低減するものであり、支持架構にねじれが生じないように配置している。なお、採用した座屈拘束ブレースは、平成12年建設省告示1461号の制振部材及び平成17年国土交通省告示第631号のエネルギー吸収部材に係る評定を受けたものである。

基礎梁は厚さ3.00mの鉄筋コンクリート造であり、支持地盤である岩盤に場所打ちコンクリート杭(外径1.00m及び1.50m、杭長16.80m及び17.80m、113本)を介して設置している。また、液状化対策として飛来物防護ネット架構下部の支持地盤以浅の地盤はセメント系の地盤改良を実施している。

なお、飛来物防護ネット(再処理設備本体用 安全冷却水系冷却塔B)は防護対象となる安全冷却水B冷却塔と構造的に分離している。

飛来物防護ネット(再処理設備本体用 安全冷却水系冷却塔B)の支持架構の全景を第1-1図に、屋根伏図及び杭伏図を第1-2図に、概略側面図を第1-3図に、基礎梁及び杭の断面図を第1-4図に示す。

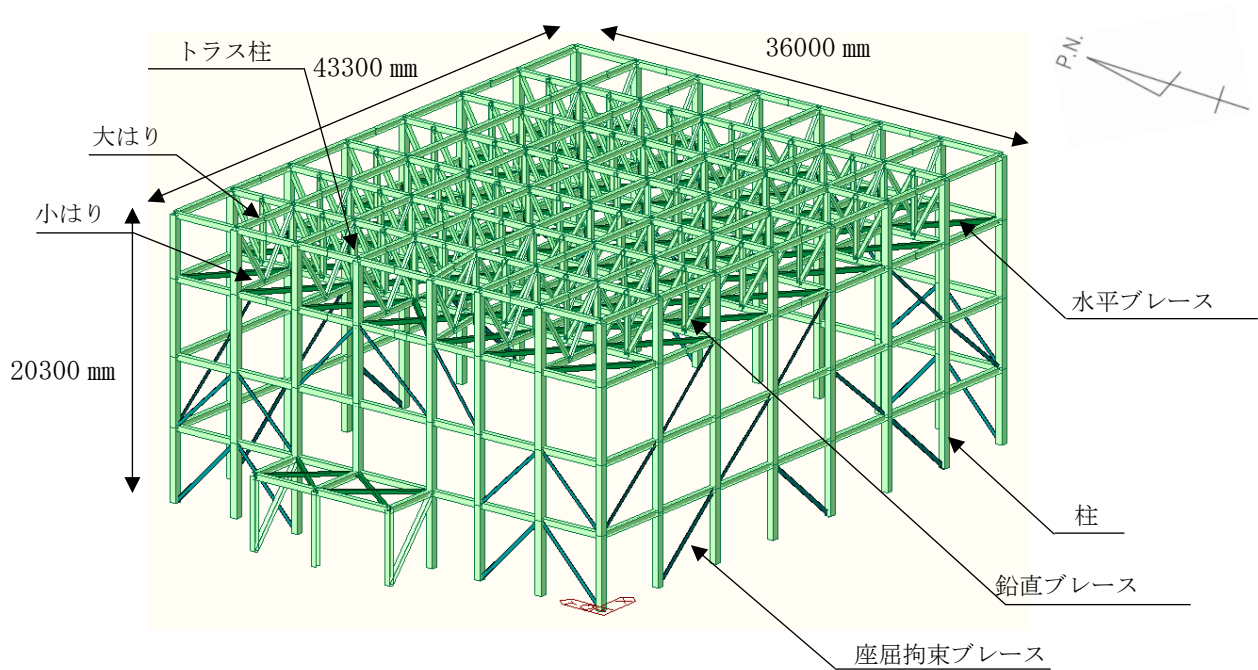

第 1-1 図 支持架構の全景

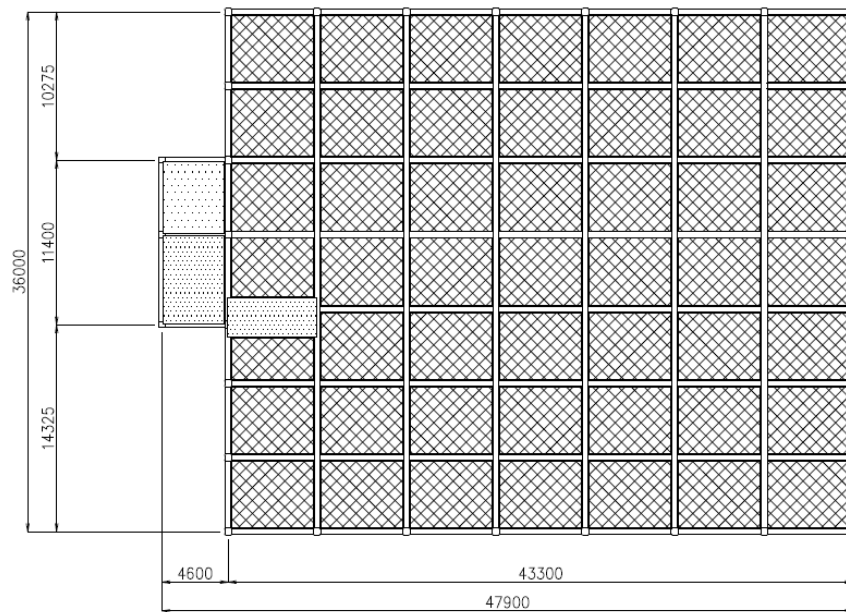

(a) 屋根伏図

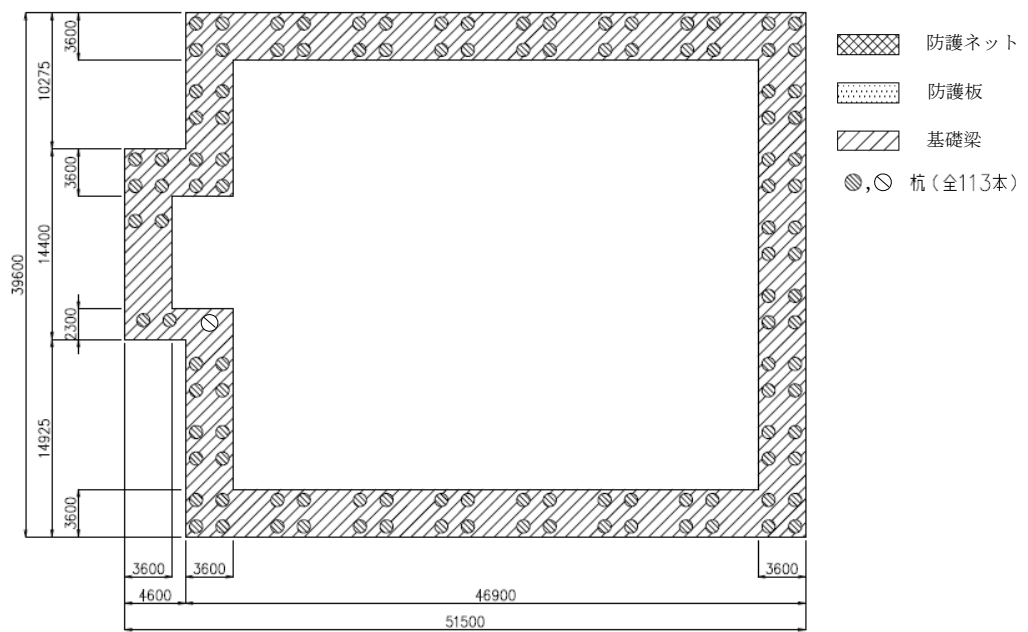

(b) 杭伏図

(単位：mm)

第1-2図 飛来物防護ネット(再処理設備本体用 安全冷却水系冷却塔B)の屋根伏図及び杭伏図

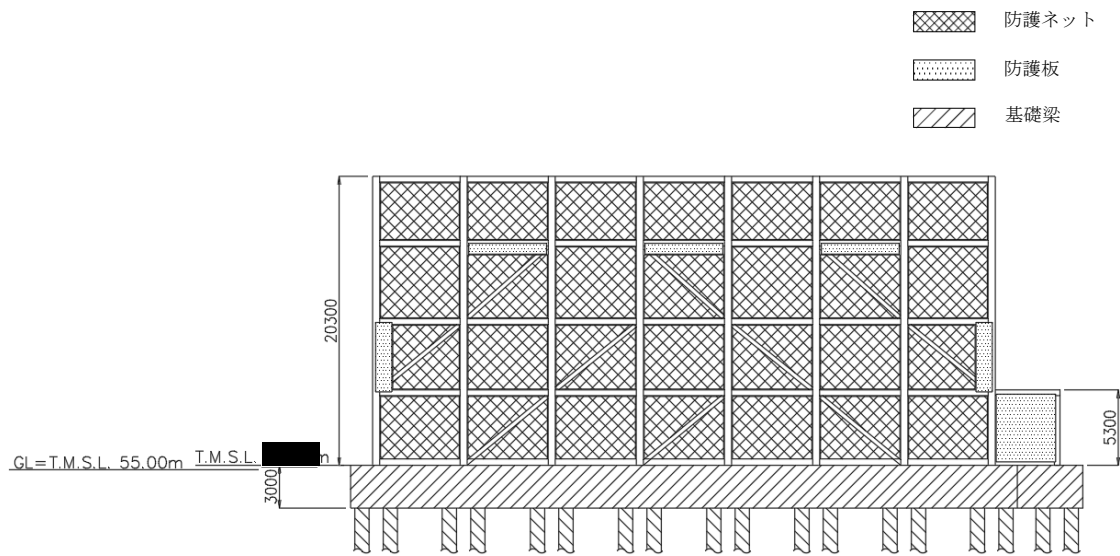

(a) 北面

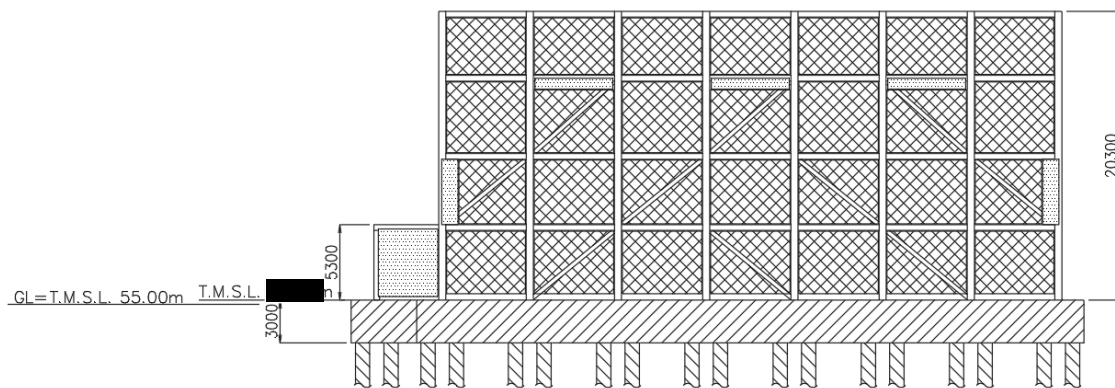

(b) 南面

(単位：mm)

第 1-3 図 飛来物防護ネット(再処理設備本体用 安全冷却水系冷却塔 B)
の概略側面図(1/2)

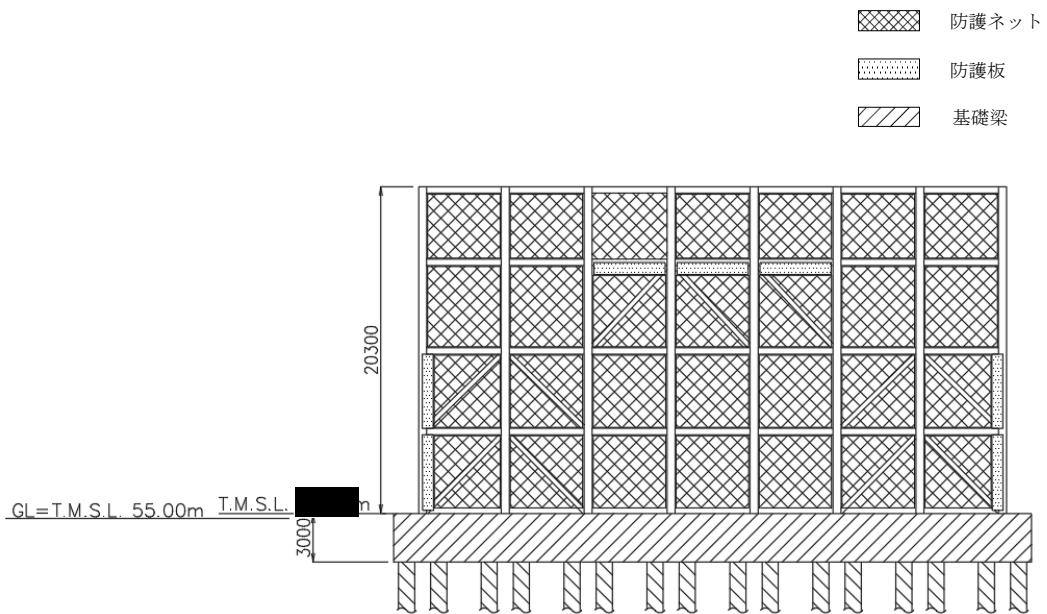

(c) 東面

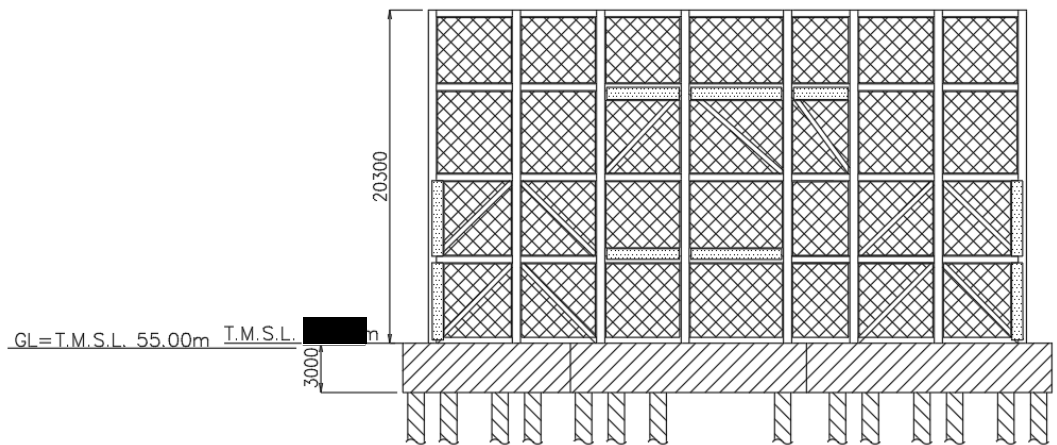

(d) 西面

(単位 : mm)

第 1-3 図 飛来物防護ネット(再処理設備本体用 安全冷却水系冷却塔 B)の概略側面図 (2/2)

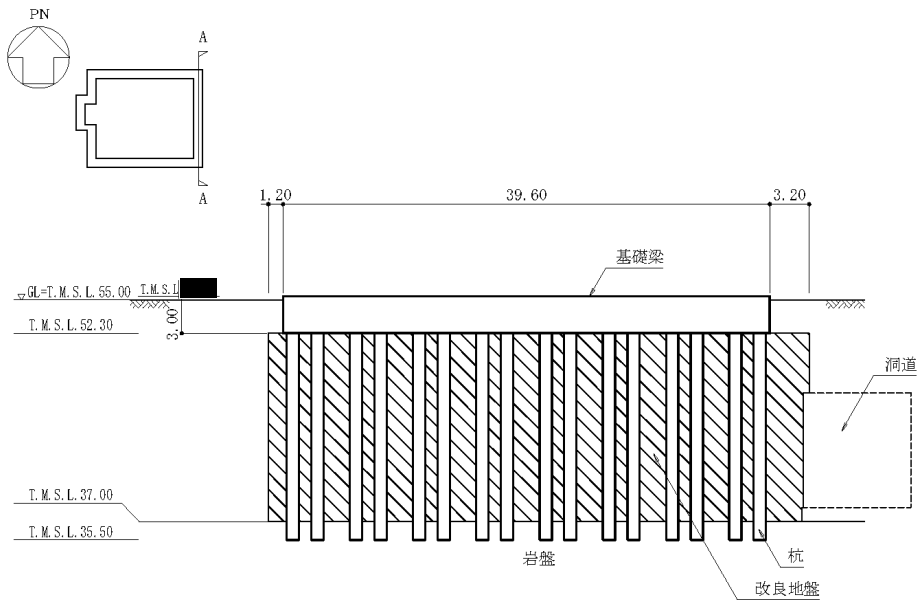

(a) A-A 断面図(NS 方向)

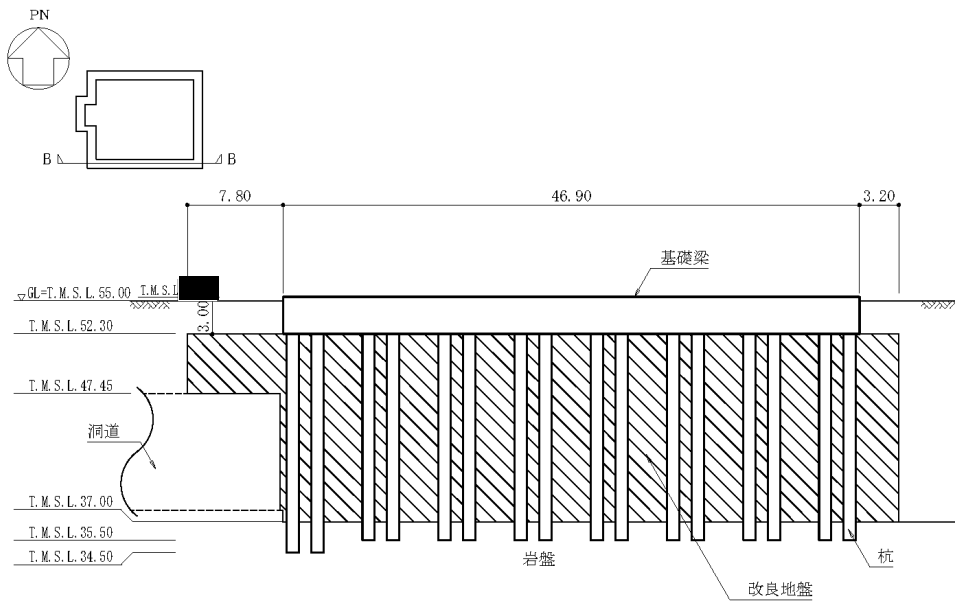

(b) B-B 断面図(EW 方向)

(単位 : m)

第1-4図 基礎梁及び杭の断面図(1/2)

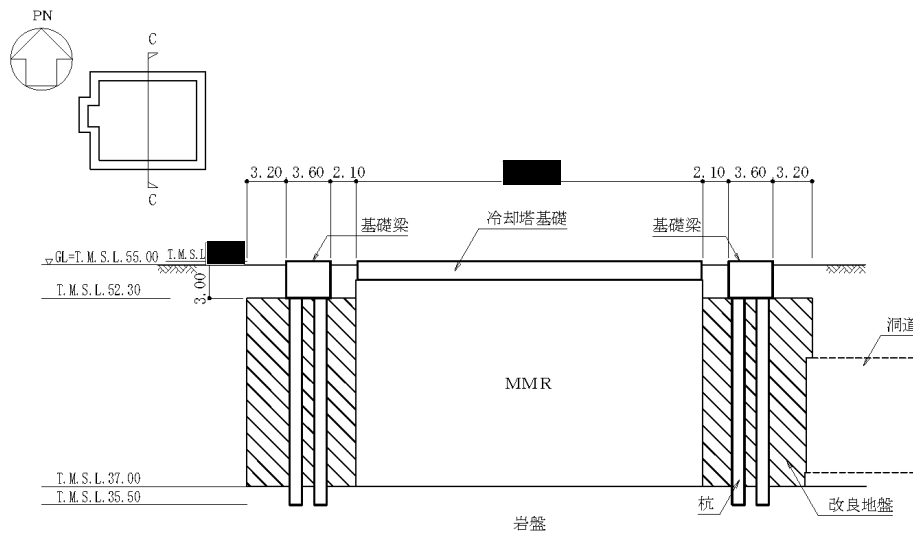

(c) C-C 断面図 (NS 方向)

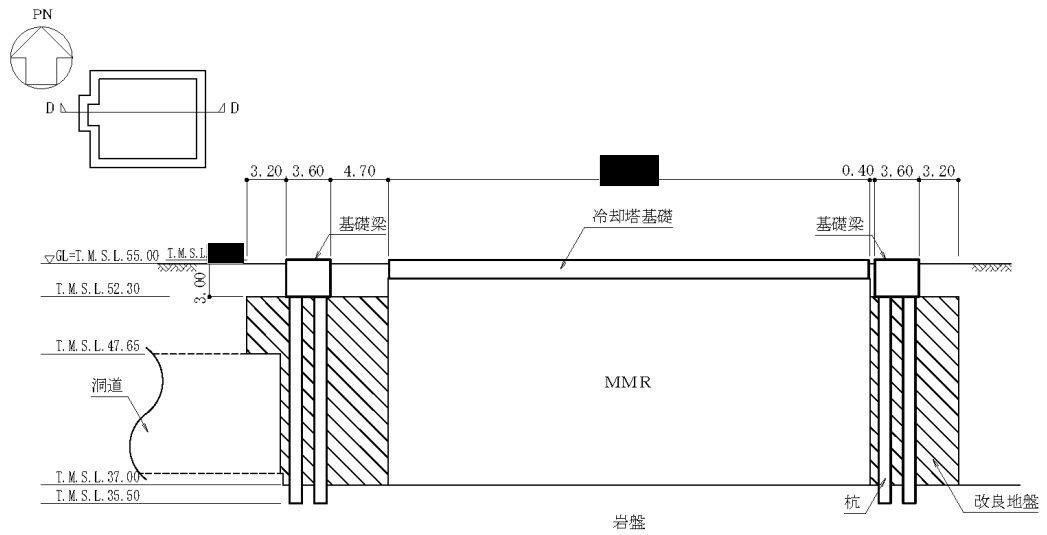

(d) D-D 断面図 (EW 方向)

(単位 : m)

第1-4図 基礎梁及び杭の断面図 (2/2)

2. 飛来物防護ネットの評価

添付書類「IV-2-2-2-1-2-1-2 飛来物防護ネット（再処理設備本体用 安全冷却水系冷却塔B）の耐震計算書」（以下、「耐震計算書」という。）における支持架構，基礎梁及び杭の耐震評価について，水平2方向及び鉛直方向地震力の組合せによる影響を確認する。なお，[準拠規格・基準等](#)については，「耐震計算書」の「2.4 準拠規格・基準等」と同様とする。

2.1 支持架構の評価

支持架構の直交する水平2方向の荷重が応力として集中する部位である柱(隅部)，梁(一般部及び鉄骨トラス)，壁(鉄骨ブレース)について，水平2方向及び鉛直方向地震力の組合せによる影響評価を実施する。

(1) 評価方針

支持架構の応力解析による評価について，許容限界を超えないことを確認する。

(2) 荷重及び荷重の組合せ

荷重の組合せは，「耐震計算書」の「4.2 荷重及び荷重の組合せ」にて設定している荷重及び荷重の組合せを用いる。支持架構の評価において考慮する荷重を第2.1-1表に，荷重の組合せを第2.1-2表に示す。

第2.1-1表 考慮する荷重

荷重名称	内容
固定荷重(D)	構造物(支持架構等)の自重
積雪荷重(Ls)	積雪量190cm 地震荷重と組み合わせる場合は0.35の係数を乗じた値とする。
地震荷重(Ss)*	地震応答解析結果による地震荷重 ・各層の層せん断力 ・屋根部の付加曲げモーメント ・屋根部の鉛直加速度より設定する鉛直震度
風荷重(WL)	建築基準法・同施行令・同告示による風荷重

注記 *：保守的に座屈拘束ブレースのばらつきの考慮をする。

第 2.1-2 表 荷重の組合せ

外力の状態	荷重の組合せ
S s 地震時	$D+0.35L_s+S_s+W_L$

(3) 許容限界

許容限界は、「耐震計算書」の「4.3 許容限界」にて設定している許容限界を用いる。

(4) 評価方法

支持架構の評価は、3次元フレームモデルを用いた静的弾塑性応力解析により実施する。解析モデル図を第 2.1-1 図に示す。解析モデルは、「耐震計算書」の「4.4.1(1) 解析モデル」に基づき、設定する。

支持架構に作用する応力は、次の荷重を組み合わせで求める。

D	: 固定荷重
L_s	: 積雪荷重
$S_{S_{NS}}$: NS方向の地震荷重(S→N方向を正とする。)
$S_{S_{EW}}$: EW方向の地震荷重(W→E方向を正とする。)
$S_{S_{UD}}$: 鉛直方向の地震荷重(上向きを正とする。)
$W_{L_{NS}}$: NS方向の風荷重(S→N方向を正とする。)
$W_{L_{EW}}$: EW方向の風荷重(W→E方向を正とする。)

水平方向と鉛直方向の荷重の組合せは、「耐震計算書」の「4.4.1(3) 荷重の組合せケース」にて設定されている荷重及び荷重の組合せを用いる。

荷重の組合せケースを第 2.1-3 表に示す。なお、水平方向を 1.0 とする場合については、 S_s-C1 による地震荷重とその他の地震による地震荷重(S_s-C1 以外包絡)による 2 種類の組合せケースを設定しているが、鉛直方向を 1.0 とする場合は、解析ケース数を少なくするため、全ての地震を包絡した地震荷重による 1 種類の組合せケースとしている。

荷重の入力方法は、「耐震計算書」の「4.4.1(4) 荷重の入力方法」に基づき、各節点又は各要素に各荷重を入力する。

部材の評価方法は、「耐震計算書」の「4.4.1(5) 部材の評価方法」に基づき、部材に生じる軸応力度及び曲げ応力度の組合せ応力が許容限界を超えないことを確認する。

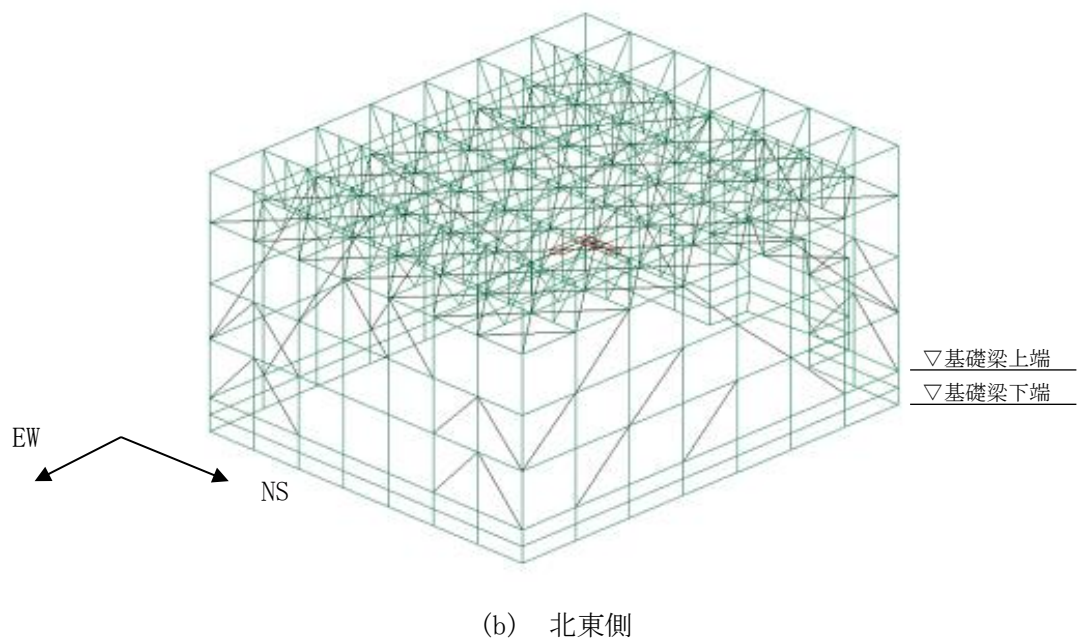
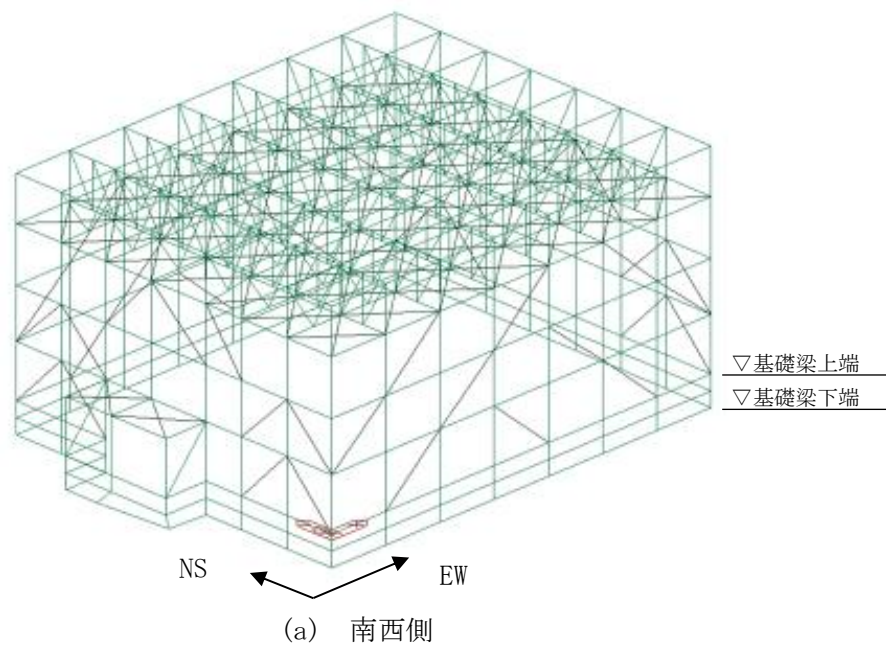

第2.1-1図 支持架構の解析モデル図

第2.1-3表 荷重の組合せケース(1/2)

ケース	荷重組合せ	地震荷重
1-1	$D + 0.35 L_s + 1.0 S_{S_{NS}} + 0.4 S_{S_{EW}} + 0.4 S_{S_{UD}} + 1.0 W_{LNS}$	Ss-C1による 地震荷重
1-2	$D + 0.35 L_s - 1.0 S_{S_{NS}} + 0.4 S_{S_{EW}} + 0.4 S_{S_{UD}} - 1.0 W_{LNS}$	
1-3	$D + 0.35 L_s + 1.0 S_{S_{NS}} + 0.4 S_{S_{EW}} - 0.4 S_{S_{UD}} + 1.0 W_{LNS}$	
1-4	$D + 0.35 L_s - 1.0 S_{S_{NS}} + 0.4 S_{S_{EW}} - 0.4 S_{S_{UD}} - 1.0 W_{LNS}$	
1-5	$D + 0.35 L_s + 1.0 S_{S_{NS}} - 0.4 S_{S_{EW}} + 0.4 S_{S_{UD}} + 1.0 W_{LNS}$	
1-6	$D + 0.35 L_s - 1.0 S_{S_{NS}} - 0.4 S_{S_{EW}} + 0.4 S_{S_{UD}} - 1.0 W_{LNS}$	
1-7	$D + 0.35 L_s + 1.0 S_{S_{NS}} - 0.4 S_{S_{EW}} - 0.4 S_{S_{UD}} + 1.0 W_{LNS}$	
1-8	$D + 0.35 L_s - 1.0 S_{S_{NS}} - 0.4 S_{S_{EW}} - 0.4 S_{S_{UD}} - 1.0 W_{LNS}$	
1-9	$D + 0.35 L_s + 0.4 S_{S_{NS}} + 1.0 S_{S_{EW}} + 0.4 S_{S_{UD}} + 1.0 W_{LEW}$	
1-10	$D + 0.35 L_s - 0.4 S_{S_{NS}} + 1.0 S_{S_{EW}} + 0.4 S_{S_{UD}} + 1.0 W_{LEW}$	
1-11	$D + 0.35 L_s + 0.4 S_{S_{NS}} + 1.0 S_{S_{EW}} - 0.4 S_{S_{UD}} + 1.0 W_{LEW}$	
1-12	$D + 0.35 L_s - 0.4 S_{S_{NS}} + 1.0 S_{S_{EW}} - 0.4 S_{S_{UD}} + 1.0 W_{LEW}$	
1-13	$D + 0.35 L_s + 0.4 S_{S_{NS}} - 1.0 S_{S_{EW}} + 0.4 S_{S_{UD}} - 1.0 W_{LEW}$	
1-14	$D + 0.35 L_s - 0.4 S_{S_{NS}} - 1.0 S_{S_{EW}} + 0.4 S_{S_{UD}} - 1.0 W_{LEW}$	
1-15	$D + 0.35 L_s + 0.4 S_{S_{NS}} - 1.0 S_{S_{EW}} - 0.4 S_{S_{UD}} - 1.0 W_{LEW}$	
1-16	$D + 0.35 L_s - 0.4 S_{S_{NS}} - 1.0 S_{S_{EW}} - 0.4 S_{S_{UD}} - 1.0 W_{LEW}$	
1-17	$D + 0.35 L_s + 1.0 S_{S_{NS}} + 0.4 S_{S_{EW}} + 0.4 S_{S_{UD}} + 1.0 W_{LNS}$	その他の 地震による 地震荷重 (Ss-C1以外 包絡)
1-18	$D + 0.35 L_s - 1.0 S_{S_{NS}} + 0.4 S_{S_{EW}} + 0.4 S_{S_{UD}} - 1.0 W_{LNS}$	
1-19	$D + 0.35 L_s + 1.0 S_{S_{NS}} + 0.4 S_{S_{EW}} - 0.4 S_{S_{UD}} + 1.0 W_{LNS}$	
1-20	$D + 0.35 L_s - 1.0 S_{S_{NS}} + 0.4 S_{S_{EW}} - 0.4 S_{S_{UD}} - 1.0 W_{LNS}$	
1-21	$D + 0.35 L_s + 1.0 S_{S_{NS}} - 0.4 S_{S_{EW}} + 0.4 S_{S_{UD}} + 1.0 W_{LNS}$	
1-22	$D + 0.35 L_s - 1.0 S_{S_{NS}} - 0.4 S_{S_{EW}} + 0.4 S_{S_{UD}} - 1.0 W_{LNS}$	
1-23	$D + 0.35 L_s + 1.0 S_{S_{NS}} - 0.4 S_{S_{EW}} - 0.4 S_{S_{UD}} + 1.0 W_{LNS}$	
1-24	$D + 0.35 L_s - 1.0 S_{S_{NS}} - 0.4 S_{S_{EW}} - 0.4 S_{S_{UD}} - 1.0 W_{LNS}$	
1-25	$D + 0.35 L_s + 0.4 S_{S_{NS}} + 1.0 S_{S_{EW}} + 0.4 S_{S_{UD}} + 1.0 W_{LEW}$	
1-26	$D + 0.35 L_s - 0.4 S_{S_{NS}} + 1.0 S_{S_{EW}} + 0.4 S_{S_{UD}} + 1.0 W_{LEW}$	
1-27	$D + 0.35 L_s + 0.4 S_{S_{NS}} + 1.0 S_{S_{EW}} - 0.4 S_{S_{UD}} + 1.0 W_{LEW}$	
1-28	$D + 0.35 L_s - 0.4 S_{S_{NS}} + 1.0 S_{S_{EW}} - 0.4 S_{S_{UD}} + 1.0 W_{LEW}$	
1-29	$D + 0.35 L_s + 0.4 S_{S_{NS}} - 1.0 S_{S_{EW}} + 0.4 S_{S_{UD}} - 1.0 W_{LEW}$	
1-30	$D + 0.35 L_s - 0.4 S_{S_{NS}} - 1.0 S_{S_{EW}} + 0.4 S_{S_{UD}} - 1.0 W_{LEW}$	
1-31	$D + 0.35 L_s + 0.4 S_{S_{NS}} - 1.0 S_{S_{EW}} - 0.4 S_{S_{UD}} - 1.0 W_{LEW}$	
1-32	$D + 0.35 L_s - 0.4 S_{S_{NS}} - 1.0 S_{S_{EW}} - 0.4 S_{S_{UD}} - 1.0 W_{LEW}$	

第2.1-3表 荷重の組合せケース(2/2)

ケース	荷重組合せ	地震荷重
1-33	$D + 0.35 L_s + 0.4 S_{SNS} + 0.4 S_{SEW} + 1.0 S_{SUD} + 1.0 W_{LNS}$	全地震包絡
1-34	$D + 0.35 L_s - 0.4 S_{SNS} + 0.4 S_{SEW} + 1.0 S_{SUD} - 1.0 W_{LNS}$	
1-35	$D + 0.35 L_s + 0.4 S_{SNS} + 0.4 S_{SEW} - 1.0 S_{SUD} + 1.0 W_{LNS}$	
1-36	$D + 0.35 L_s - 0.4 S_{SNS} + 0.4 S_{SEW} - 1.0 S_{SUD} - 1.0 W_{LNS}$	
1-37	$D + 0.35 L_s + 0.4 S_{SNS} - 0.4 S_{SEW} + 1.0 S_{SUD} + 1.0 W_{LNS}$	
1-38	$D + 0.35 L_s - 0.4 S_{SNS} - 0.4 S_{SEW} + 1.0 S_{SUD} - 1.0 W_{LNS}$	
1-39	$D + 0.35 L_s + 0.4 S_{SNS} - 0.4 S_{SEW} - 1.0 S_{SUD} + 1.0 W_{LNS}$	
1-40	$D + 0.35 L_s - 0.4 S_{SNS} - 0.4 S_{SEW} - 1.0 S_{SUD} - 1.0 W_{LNS}$	
1-41	$D + 0.35 L_s + 0.4 S_{SNS} + 0.4 S_{SEW} + 1.0 S_{SUD} + 1.0 W_{LEW}$	
1-42	$D + 0.35 L_s - 0.4 S_{SNS} + 0.4 S_{SEW} + 1.0 S_{SUD} + 1.0 W_{LEW}$	
1-43	$D + 0.35 L_s + 0.4 S_{SNS} + 0.4 S_{SEW} - 1.0 S_{SUD} + 1.0 W_{LEW}$	
1-44	$D + 0.35 L_s - 0.4 S_{SNS} + 0.4 S_{SEW} - 1.0 S_{SUD} + 1.0 W_{LEW}$	
1-45	$D + 0.35 L_s + 0.4 S_{SNS} - 0.4 S_{SEW} + 1.0 S_{SUD} - 1.0 W_{LEW}$	
1-46	$D + 0.35 L_s - 0.4 S_{SNS} - 0.4 S_{SEW} + 1.0 S_{SUD} - 1.0 W_{LEW}$	
1-47	$D + 0.35 L_s + 0.4 S_{SNS} - 0.4 S_{SEW} - 1.0 S_{SUD} - 1.0 W_{LEW}$	
1-48	$D + 0.35 L_s - 0.4 S_{SNS} - 0.4 S_{SEW} - 1.0 S_{SUD} - 1.0 W_{LEW}$	

(5) 評価結果

「(4) 評価方法」に基づいた評価結果を以下に示す。

評価結果を記載する部材は、部材種別ごとに検定比が最も大きいものを対象とする。当該部材の位置を第2.1-2図に、評価結果を第2.1-4表に示す。なお、参考に耐震計算書の水平1方向及び鉛直地震力の組合せの結果を第2.1-4表に併せて示す。

応答特性①-1「直交する水平2方向の荷重が、応力として集中」で抽出した飛来物防護ネット（再処理設備本体用 安全冷却水系冷却塔B）の結果を以下に示す。

- ・柱(隅部)について、柱の検定比が1.0を下回っており、許容限界を超えないことを確認した。
- ・梁(鉄骨トラス)について、大はり、小はり、トラス柱、鉛直ブレース、水平ブレースの検定比が1.0を下回っており、許容限界を超えないことを確認した。
- ・梁(一般部)については、梁(鉄骨トラス)の大はりの最大検定比を下回っており、許容限界を超えないことを確認した。
- ・壁(鉄骨ブレース)の軸力+曲げの評価は、梁(鉄骨トラス)の鉛直ブレースの最大検定比を下回っている。また、せん断の評価は検定比が1.0を下回っている。よって、許容限界を超えないことを確認した。

以上のことから、支持架構の耐震性評価において、水平2方向及び鉛直方向地震力の組合せによる影響がないことを確認した。

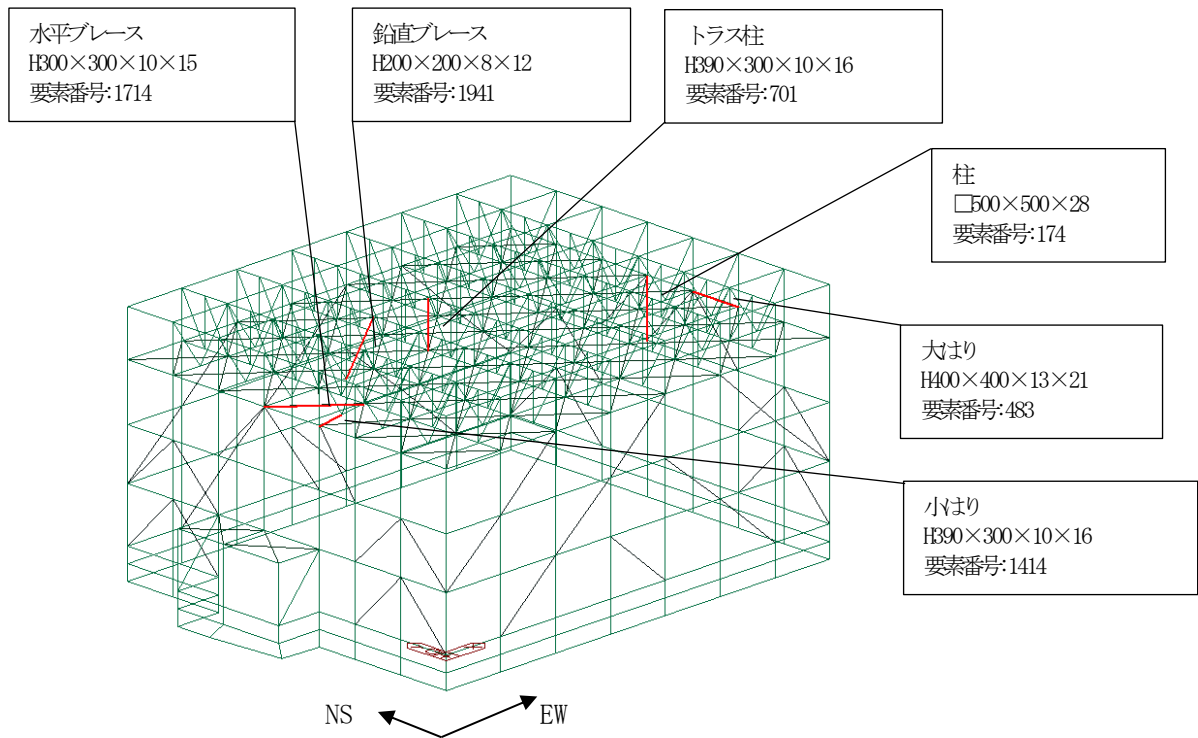

(a) 軸力+曲げ

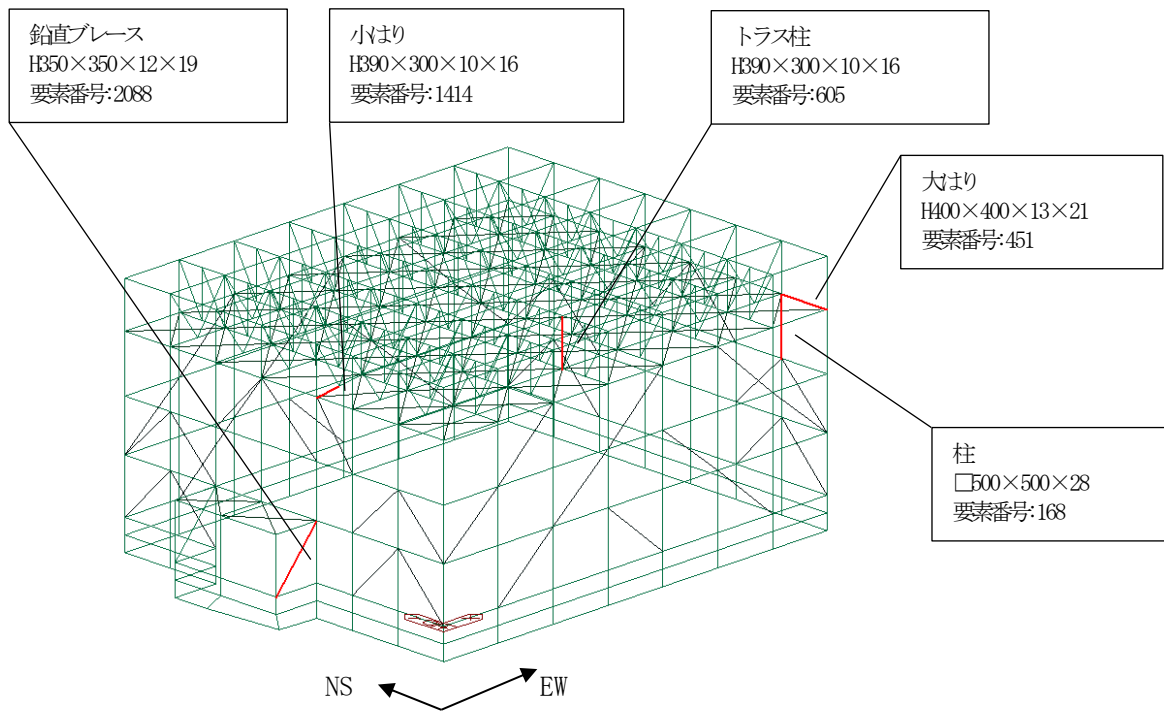

(b) せん断

第2.1-2図 評価結果を記載する位置(水平2方向及び鉛直地震力の組合せ)

第2.1-4表 部材の評価結果(1/2)

(a) 水平2方向及び鉛直地震力の組合せ

部材種別	要素番号	ケース	応力度	発生応力度 (N/mm ²)	許容限界 (N/mm ²)	検定比	判定
柱	168	1-4	せん断	35.4	206.0	0.18	OK
	174	1-4	軸力+曲げ	(検定比) 0.94	(許容値) 1.00	0.94	OK
大はり	451	1-8	せん断	72.5	206.0	0.36	OK
	483	1-4	軸力+曲げ	(検定比) 0.92	(許容値) 1.00	0.92	OK
小はり	1414	1-16	せん断	38.9	206.0	0.19	OK
	1414	1-16	軸力+曲げ	(検定比) 0.95	(許容値) 1.00	0.95	OK
トラス柱	605	1-36	せん断	14.4	206.0	0.07	OK
	701	1-15	軸力+曲げ	(検定比) 0.77	(許容値) 1.00	0.77	OK
鉛直 ブレース	2088	1-16	せん断	10.3	206.0	0.05	OK
	1941	1-16	軸力+曲げ	(検定比) 0.71	(許容値) 1.00	0.71	OK
水平 ブレース	1714	1-1	軸力+曲げ	(検定比) 0.32	(許容値) 1.00	0.32	OK

第2.1-4表 部材の評価結果(2/2)

(b) 水平1方向及び鉛直地震力の組合せ

部材種別	要素番号	ケース	応力度	発生応力度 (N/mm ²)	許容限界 (N/mm ²)	検定比	判定
柱	167	1-4	せん断	34.0	206.0	0.17	OK
	174	1-4	軸力+曲げ	(検定比) 0.89	(許容値) 1.00	0.89	OK
大はり	451	1-4	せん断	70.1	206.0	0.34	OK
	483	1-4	軸力+曲げ	(検定比) 0.87	(許容値) 1.00	0.87	OK
小はり	1428	1-12	せん断	38.5	206.0	0.19	OK
	1414	1-12	軸力+曲げ	(検定比) 0.87	(許容値) 1.00	0.87	OK
トラス柱	766	2-7	せん断	13.5	206.0	0.07	OK
	701	1-12	軸力+曲げ	(検定比) 0.72	(許容値) 1.00	0.72	OK
鉛直 ブレース	2088	1-12	せん断	10.3	206.0	0.05	OK
	1941	2-12	軸力+曲げ	(検定比) 0.69	(許容値) 1.00	0.69	OK
水平 ブレース	1714	1-1	軸力+曲げ	(検定比) 0.30	(許容値) 1.00	0.30	OK

2.2 基礎梁の評価

直交する水平 2 方向の荷重が応力として集中する部位である基礎梁について、水平 2 方向及び鉛直方向地震力の組合せによる影響評価を実施する。

(1) 評価方針

基礎梁の応力解析による評価について、許容限界を超えないことを確認する。

(2) 荷重及び荷重の組合せ

荷重の組合せは、「耐震計算書」の「4.2 荷重及び荷重の組合せ」にて設定している荷重及び荷重の組合せを用いる。基礎梁の評価において考慮する荷重を第 2.2-1 表に、荷重の組合せを第 2.2-2 表に示す。

第2.2-1表 考慮する荷重

荷重名称	内容
固定荷重(D)	構造物(基礎梁)の自重
積雪荷重(Ls)	積雪量190cm 地震荷重と組み合わせる場合は0.35の係数を乗じた値とする。
地震荷重(Ss)*4	地震応答解析結果による地震荷重 ・基礎梁部の加速度(水平及び鉛直)より設定する震度 支持架構の評価結果による荷重*1 ・柱脚鉛直軸力 ・柱脚曲げモーメント ・柱脚せん断力 杭の評価結果による荷重*2 ・杭頭曲げモーメント
風荷重(WL)	建築基準法・同施行令・同告示の規定による風荷重*3

注記 *1: 支持架構に作用する固定荷重, 積雪荷重, 地震荷重及び風荷重を含む。

*2: 杭に作用する地震荷重及び風荷重を含む。

*3: 支持架構の評価において支持架構に作用する風荷重を考慮しているため, 本表の「地震荷重(Ss)」のうち「支持架構の評価結果による荷重」により, 基礎梁に風荷重が考慮される。

*4: 保守的に座屈拘束ブレースのばらつきの考慮をする。

第2.2-2表 荷重の組合せ

外力の状態	荷重の組合せ
S s 地震時	$D + 0.35Ls + Ss + WL$

(3) 許容限界

許容限界は, 「耐震計算書」の「4.3 許容限界」にて設定している許容限界を用いる。

(4) 評価方法

基礎梁の評価は、FEM モデルを用いた静的弾性応力解析により実施する。解析モデル図を第 2.2-1 図に示す。解析モデルは、「耐震計算書」の「4.4.2(1) 解析モデル」に基づき、設定する。

基礎梁に作用する応力は、支持架構と同様の荷重の組合せとする。

荷重の入力方法は、「耐震計算書」の「4.4.2(4) 荷重の入力方法」に基づき、各節点又は各要素に各荷重を入力する。ただし、支持架構から作用する荷重については、2.1 項における応力解析結果を用いる。また、杭から作用する荷重については、「耐震計算書」の「4.4.3(3) 応力の組合せ」において算定した NS 方向の応力と EW 方向の応力を用い、支持架構と同様の 2.1 項の第 2.1-3 表の地震荷重の組合せ係数に対応した組合せ係数を考慮して用いる。

断面の評価方法は、「耐震計算書」の「4.4.2(5) 断面の評価方法」に基づき、曲げモーメント及び面外せん断力が許容限界を超えないことを確認する。

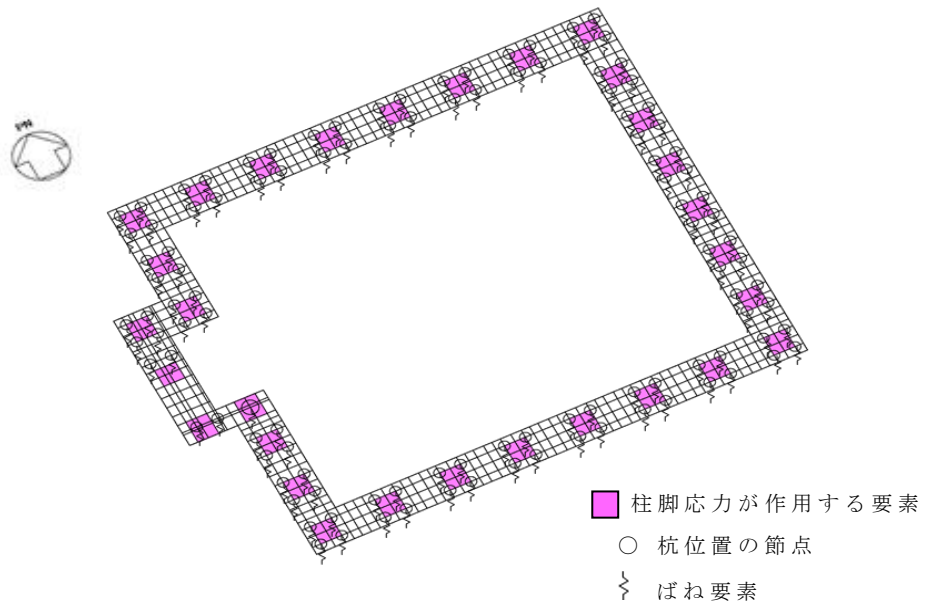

第2.2-1図 基礎梁の解析モデル

(5) 評価結果

「(4) 評価方法」に基づいた評価結果を以下に示す。

断面の評価結果を記載する要素は、許容限界に対する曲げモーメント及び面外せん断力の割合が最も大きいものを対象とする。当該要素の位置を第 2.2-2 図に、評価結果を第 2.2-3 表に示す。なお、参考に耐震計算書の水平 1 方向及び鉛直地震力の組合せの結果を第 2.2-4 表に併せて示す。

応答特性①-1「直交する水平 2 方向の荷重が、応力として集中」で抽出した飛来物防護ネット（再処理設備本体用 安全冷却水系冷却塔 B）の基礎梁の検定比が 1.0 を下回っており、許容限界を超えないことを確認した。

以上のことから、基礎梁の耐震性評価において、水平 2 方向及び鉛直方向地震力の組合せによる影響がないことを確認した。

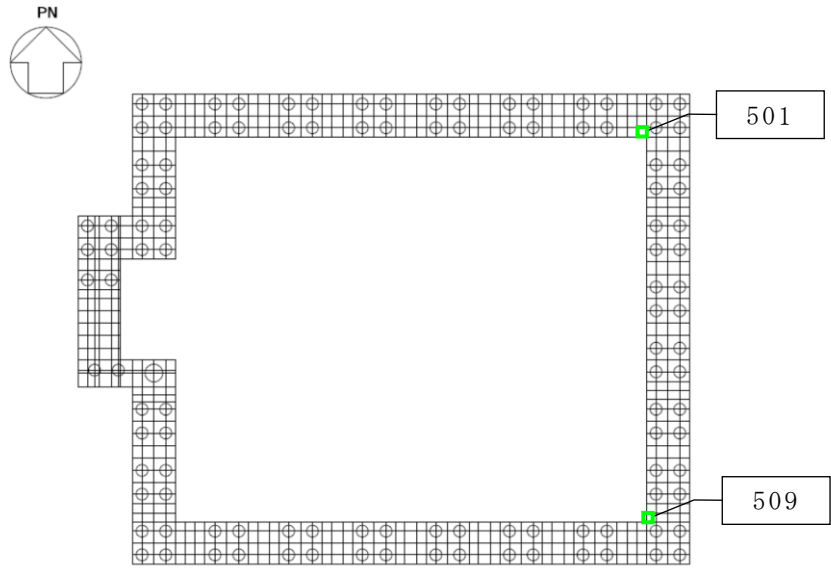

注： 内の数値は要素番号

第2.2-2図 評価結果を記載する要素の位置
(水平2方向及び鉛直地震力の組合せ)

第2.2-3表 基礎梁の評価結果
 (水平2方向及び鉛直地震力の組合せ)
 (a) 軸力及び曲げモーメントに対する評価

方向	解析結果			許容限界 (kN・m/m)	検定比	判定
	要素番号	ケース	曲げモーメント (kN・m/m)			
NS	509	1-4	3656	4812	0.76	OK
EW	509	1-12	1317	1745	0.76	OK

(b) 面外せん断力に対する評価

方向	解析結果			許容限界 (kN/m)	検定比	判定
	要素番号	ケース	面外せん断力 (kN/m)			
NS	509	1-11	2630	5648	0.47	OK
EW	501	1-4	2529	5644	0.45	OK

第2.2-4表 基礎梁の評価結果
 (水平1方向及び鉛直地震力の組合せ)
 (a) 軸力及び曲げモーメントに対する評価

方向	解析結果			許容限界 (kN・m/m)	検定比	判定
	要素番号	ケース	曲げモーメント (kN・m/m)			
NS	162	1-4	3527	4791	0.74	OK
EW	509	1-10	1274	1755	0.73	OK

(b) 面外せん断力に対する評価

方向	解析結果			許容限界 (kN/m)	検定比	判定
	要素番号	ケース	面外せん断力 (kN/m)			
NS	63	1-4	2236	5661	0.40	OK
EW	1005	1-12	2061	5874	0.36	OK

2.3 杭の評価

直交する水平2方向の荷重が、応力として集中する部位である杭について、水平2方向及び鉛直方向地震力の組合せによる影響評価を実施する。

(1) 評価方針

杭の応力解析による評価について、許容限界を超えないことを確認する。

(2) 荷重及び荷重の組合せ

荷重の組合せは、「耐震計算書」の「4.2 荷重及び荷重の組合せ」にて設定している荷重及び荷重の組合せを用いる。杭の評価において考慮する荷重を第2.3-1表に、荷重の組合せを第2.3-2表に示す。

第2.3-1表 考慮する荷重

荷重名称	内容
固定荷重(D)	構造物(支持架構及び基礎梁)の自重* ¹
積雪荷重(Ls)	積雪量 190cm* ¹ 地震荷重と組み合わせる場合は0.35の係数を乗じた値とする。
地震荷重(Ss)* ⁴	地震応答解析結果による地盤から作用する地震荷重 ・改良地盤の変形量より算定するせん断力及び曲げモーメント 地震応答解析結果による支持架構及び基礎梁から作用する地震荷重 ・基礎梁上端の層せん断力より算定する曲げモーメント ・基礎梁部の加速度(水平)より算定する曲げモーメント 基礎梁の評価結果による荷重* ² ・杭頭鉛直軸力より算定する軸力 ・杭頭せん断力より算定するせん断力
風荷重(W _L)	支持架構の評価結果による風荷重 ・基礎梁上端の層せん断力より算定する曲げモーメント* ³

注記 *1: 基礎梁の評価において支持架構及び基礎梁に作用する固定荷重及び積雪荷重を考慮しているため、本表の「地震荷重(Ss)」のうち「基礎梁の評価結果による荷重」により、杭に固定荷重及び積雪荷重が考慮される。

*2: 支持架構及び基礎梁に作用する固定荷重、積雪荷重、地震荷重及び風荷重を含む。

*3: 基礎梁の評価において支持架構に作用する風荷重を考慮しているため、せん断力については、本表の「地震荷重(Ss)」のうち「基礎梁の評価結果による荷重」に含まれる。

*4: 保守的に座屈拘束ブレースのばらつきの考慮をする。

第2.3-2表 荷重の組合せ

外力の状態	荷重の組合せ
S s 地震時	D + 0.35Ls + Ss + W _L

(3) 許容限界

許容限界は、「耐震計算書」の「4.3 許容限界」にて設定している許容限界を用いる。

(4) 評価方法

杭の評価は、「耐震計算書」の「4.4.3(1) 応力解析」及び「4.4.3(2) 応力計算」により算定した応力と基礎梁から作用する荷重による応力を組み合わせて実施する。

「4.4.3(1) 応力解析」及び「(2) 応力計算」により算定した地震荷重による応力（せん断力及び曲げモーメント）については、NS 方向と EW 方向の応力に組合せ係数 1.0 : 0.4 を考慮した上で二乗和平方根により算出する。

「4.4.3(2) 応力計算」により算定した風荷重による応力（せん断力及び曲げモーメント）については、そのまま用いる。

基礎梁から作用する荷重による応力（せん断力及び軸力）については、2.2 項における応力解析結果を用いる。

断面及び支持力に対する評価方法は、「耐震計算書」の「4.4.3(4) 断面の評価方法」及び「4.4.3(5) 支持力及び引抜力に対する評価方法」に基づき、曲げモーメント、せん断力、支持力及び引抜力が許容限界を超えないことを確認する。

(5) 評価結果

「(4) 評価方法」に基づいた評価結果を以下に示す。

a. 断面の評価結果

断面の評価結果を記載する杭は、杭種ごとに、許容限界に対する曲げモーメント並びにせん断力の割合が最も大きいものを対象とする。当該の杭の位置を第2.3-1図に、評価結果を第2.3-3表、第2.3-2図に示す。なお、参考に耐震計算書の水平1方向及び鉛直地震力の組合せの結果を第2.3-4表及び第2.3-3図に併せて示す。

b. 支持力及び引抜力に対する評価結果

支持力及び引抜力に対する評価結果を記載する杭は、杭種ごとに、許容限界に対する軸力の割合が最も大きいものを対象とする。当該の杭の位置を第2.3-4図に、評価結果を第2.3-5表に示す。なお、参考に耐震計算書の水平1方向及び鉛直地震力の組合せの結果を第2.3-5表に併せて示す。

a. 及びb. から、応答特性①-1「直交する水平2方向の荷重が、応力として集中」で抽出した飛来物防護ネット(再処理設備本体用 安全冷却水系冷却塔B)の杭の検定比が1.0を下回っており、許容限界を超えないことを確認した。

以上のことから、杭の耐震性評価において、水平2方向及び鉛直方向地震力の組合せによる影響がないことを確認した。

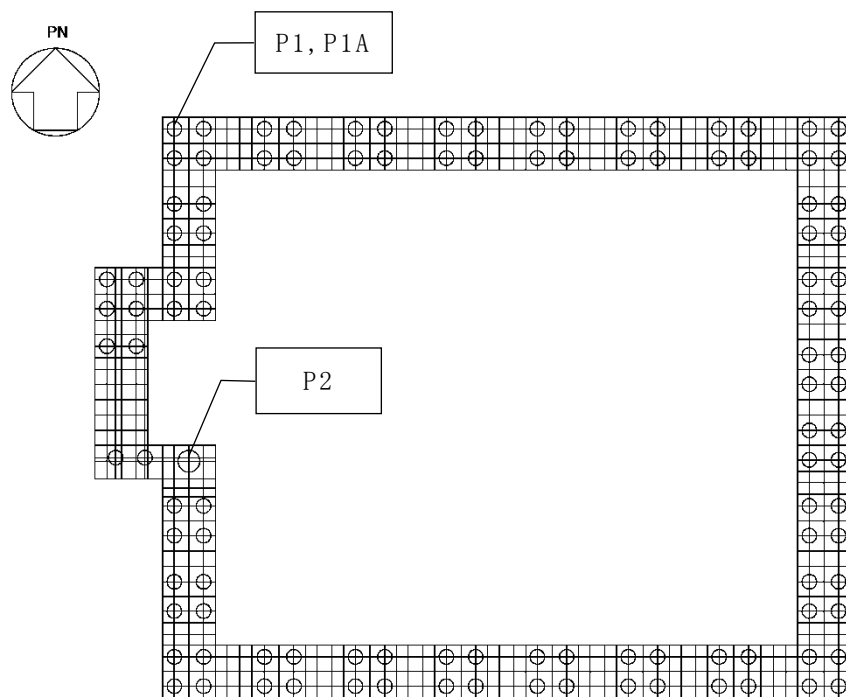

第2.3-1図 評価結果を記載する杭の位置

第2.3-3表 断面の評価結果
(水平2方向及び鉛直地震力の組合せ)

(a) 軸力及び曲げモーメントに対する評価

杭種	応力の組合せ結果		許容限界 (kN・m)	検定比	判定
	ケース*	曲げモーメント (kN・m)			
P1, P1A	1-2	430	577	0.75	OK
P2	1-6	1660	3316	0.51	OK

(b) せん断力に対する評価

杭種	応力の組合せ結果		許容限界 (kN)	検定比	判定
	ケース*	せん断力 (kN)			
P1, P1A	1-2	580	1809	0.33	OK
P2	1-6	1870	4523	0.42	OK

注記 * : 基礎梁の応力解析におけるケースを示す。

第2.3-4表 断面の評価結果
(水平1方向及び鉛直地震力の組合せ)

(a) 軸力及び曲げモーメントに対する評価

杭種	応力の組合せ結果		許容限界 (kN・m)	検定比	判定
	ケース*	曲げモーメント (kN・m)			
P1, P1A	1-2	400	706	0.57	OK
P2	1-2	1520	3583	0.43	OK

(b) せん断力に対する評価

杭種	応力の組合せ結果		許容限界 (kN)	検定比	判定
	ケース*	せん断力 (kN)			
P1, P1A	1-2	540	1838	0.30	OK
P2	1-2	1730	4594	0.38	OK

注記 * : 基礎梁の応力解析におけるケースを示す。

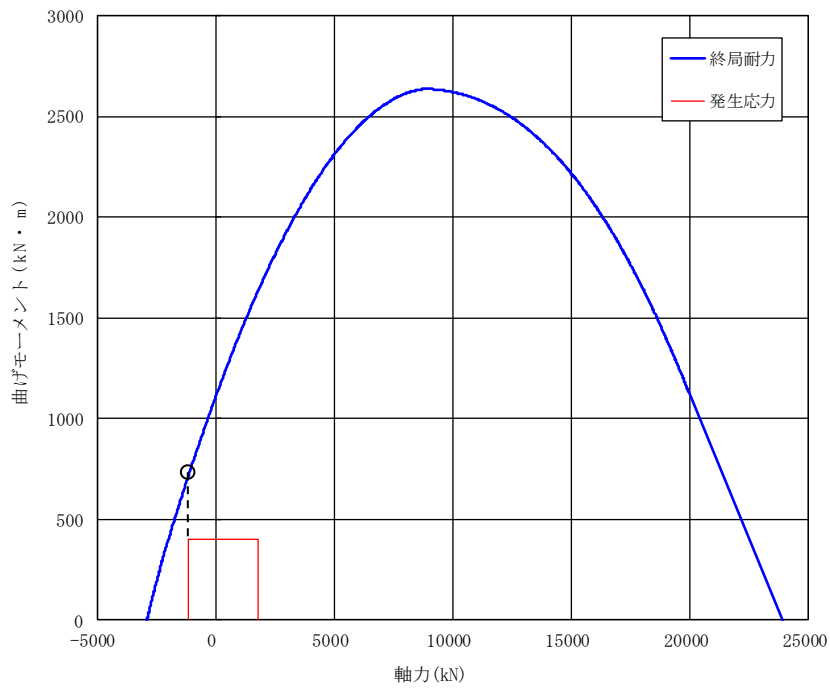

(a) P1, P1A

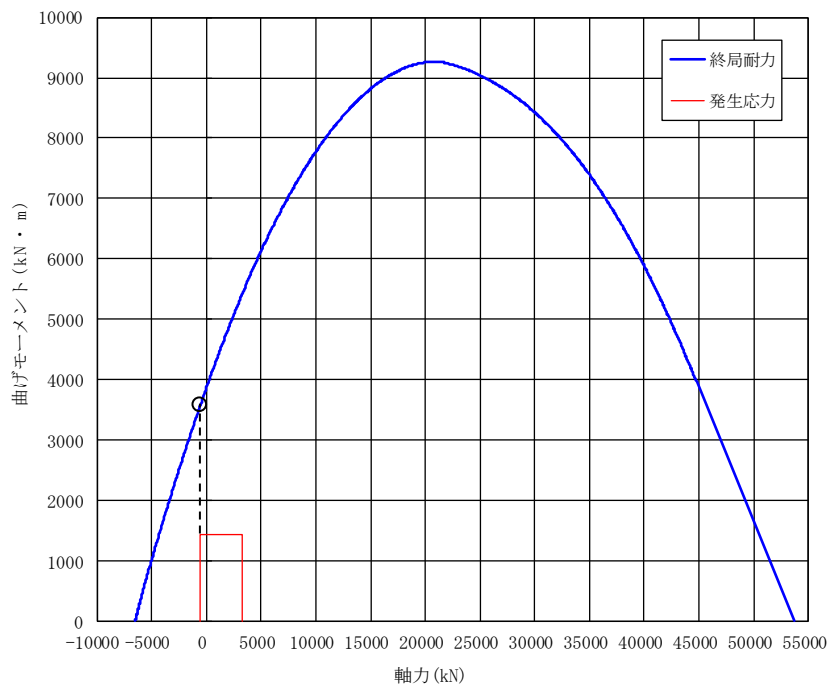

(b) P2

第2.3-2図 杭の軸力及び曲げモーメントに対する評価結果
(水平2方向及び鉛直地震力の組合せ)

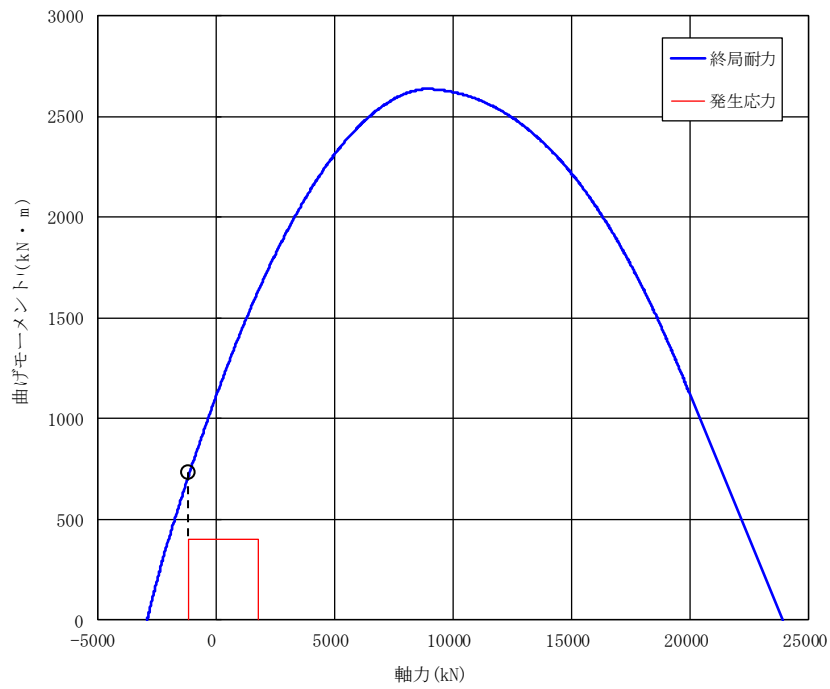

(a) P1, P1A

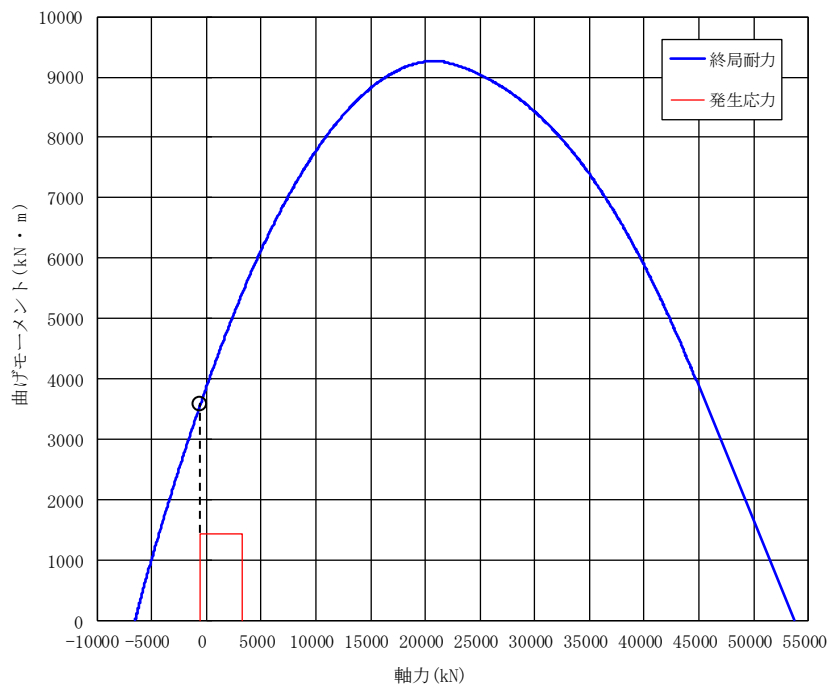

(b) P2

第2.3-3図 杭の軸力及び曲げモーメントに対する評価結果
(水平1方向及び鉛直地震力の組合せ)

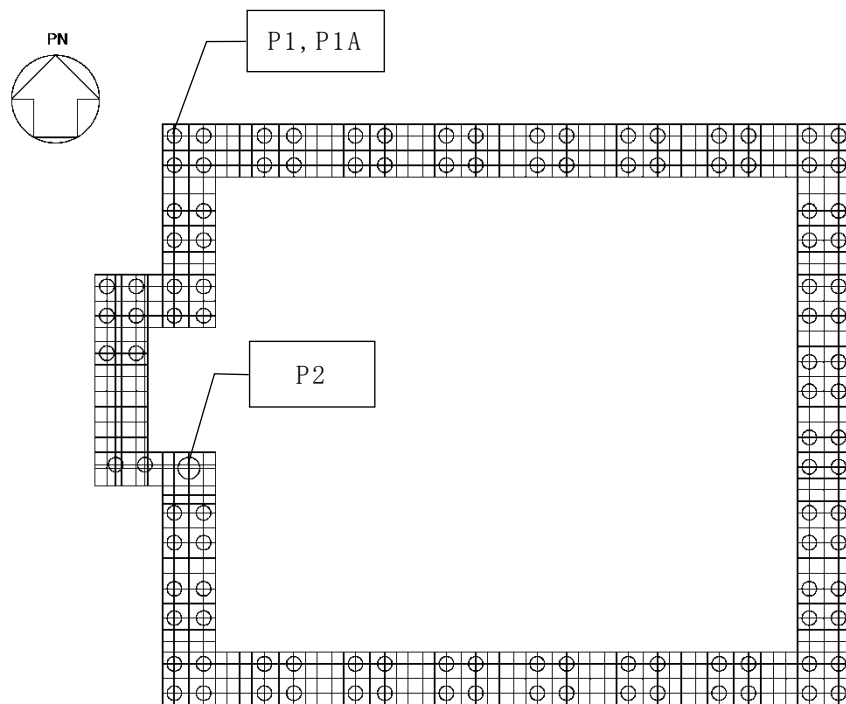

第2.3-4図 評価結果を記載する杭の位置

第2.3-5表 支持力及び引抜力に対する評価結果

(a) 水平2方向及び鉛直地震力の組合せ

項目	杭種	応力の組合せ結果		許容限界 (kN)	検定比	判定
		ケース*1	軸力*2 (kN)			
支持力	P1, P1A	1-7	2305	12635	0.19	OK
	P2	1-3	3926	21898	0.18	OK
引抜力	P1, P1A	1-2	-1525	5022	0.31	OK
	P2	1-6	-1064	7672	0.14	OK

(b) 水平1方向及び鉛直地震力の組合せ

項目	杭種	応力の組合せ結果		許容限界 (kN)	検定比	判定
		ケース*1	軸力*2 (kN)			
支持力	P1, P1A	1-12	1959	12635	0.16	OK
	P2	1-3	3422	21898	0.16	OK
引抜力	P1, P1A	1-2	-1173	5022	0.24	OK
	P2	1-2	-561	7672	0.08	OK

注記 *1: 基礎梁の応力解析におけるケースを示す。

*2: 軸力は正が圧縮, 負が引張を示す。

3. まとめ

飛来物防護ネット（再処理設備本体用 安全冷却水系冷却塔 B）において、水平 2 方向及び鉛直方向地震力の組合せによる影響を受ける可能性がある部位について、耐震成立性への影響を確認した。その結果、水平 2 方向及び鉛直方向地震力の組合せによる応力が許容値を満足することを確認した。

以上のことから、水平 2 方向及び鉛直方向地震力の組合せに対し、飛来物防護ネット（再処理設備本体用 安全冷却水系冷却塔 B）が有する耐震性への影響はないことを確認した。

別紙4-24

水平2方向及び鉛直方向地震力の組合せに関する影響評価結果 機器・配管系

本添付書類は、別で定める方針に沿った評価・計算を示す書類であり、結果を示すものであることから、発電炉との比較は行わない。
また、図書番号や数値は最終精査中。

目 次

	ページ
1. 概要	1
2. 水平 2 方向及び鉛直方向地震力の組合せによる影響評価に用いる地震動	1
3. 各施設における水平 2 方向及び鉛直方向地震力の組合せに対する検討結果	1
3.1 水平 2 方向及び鉛直方向地震力の組合せの評価設備(部位)の抽出	1
3.2 建物・構築物の検討結果を踏まえた機器・配管系の設備の抽出	3
3.3 水平 2 方向及び鉛直方向地震力の評価部位の抽出結果	3
3.4 水平 2 方向及び鉛直方向地震力の組合せの影響評価	3
3.5 水平 2 方向及び鉛直方向地震力の影響評価結果	4

1. 概要

本資料は、「IV-1-1 耐震設計の基本方針」のうち、「4.1 地震力の算定方法 4.1.2 動的地震力」及び「IV-1-1-7 水平2方向及び鉛直方向地震力の組合せに関する影響評価方針」に基づき、水平2方向及び鉛直方向地震力の組合せの影響の可能性のある設備及び評価部位の抽出内容について説明するものである。

2. 水平2方向及び鉛直方向地震力の組合せによる影響評価に用いる地震動

本影響評価に用いる地震動については、「IV-2-3-1-1-1 建物及び屋外機械基礎の水平2方向及び鉛直方向の地震力の組合せに関する影響評価結果」の「2. 水平2方向及び鉛直方向地震力の組合せによる影響評価に用いる地震動」に従う。

3. 各施設における水平2方向及び鉛直方向地震力の組合せに対する検討結果

3.1 水平2方向及び鉛直方向地震力の組合せの評価設備(部位)の抽出

評価対象設備を機種ごとに分類した結果を、第3.1-1表に示す。機種ごとに分類した設備の各評価部位、応力分類に対し構造上の特徴から水平2方向の地震力による影響を以下の項目より検討し、影響の可能性のある設備を抽出した。

(1) 水平2方向の地震力が重複する観点

水平1方向の地震力に加えて、さらに水平直交方向に地震力が重複した場合、水平2方向の地震力による影響を検討し、影響が軽微な設備以外の影響検討が必要となる可能性があるものを抽出する。以下の場合、水平2方向の地震力による影響が軽微な設備であると整理した。

なお、ここでの影響が軽微な設備とは、構造上の観点から発生応力への影響に着目し、その増分が1割程度以下となる設備を分類しているが、水平1方向地震力による裕度(許容応力/発生応力)が1.1未満の設備については個別に検討を行うこととする。

a. 水平2方向の地震力を受けた場合でも、その構造により水平1方向の地震力しか負担しないもの

横置きの容器等は、水平2方向の地震力を想定した場合、水平1方向を拘束する構造であることや、水平各方向で振動特性及び荷重の負担断面が異なる構造であることにより、特定の方向の地震力の影響を受ける部位であるため、水平1方向の地震力しか負担しないものとして分類した。

b. 水平2方向の地震力を受けた場合、その構造により最大応力の発生箇所が異なるもの

一様断面を有する容器類の胴板等は、水平2方向の地震力を想定した場合、それぞれの水平方向地震力に応じて応力が最大となる箇所があることから、最大応力の発生箇所が異なり、水平2方向の地震力を組み合わせても影響が軽微であるものとして分類した。

その他の設備についても同様の理由から最大応力の発生箇所が異なり、水平2方向の地震力を組み合わせても影響が軽微であるものとして分類した。

- c. 水平2方向の地震力を組み合わせても水平1方向の地震による応力と同等と言えるもの

標準支持間隔法を適用した配管は建物応答軸に沿った配管配置では、水平1方向の地震力のみが曲げ荷重となるため、水平2方向の地震力の大きさを1:1と仮定しても水平1方向の地震力と同等となる。

配管と同様に水平2方向による荷重の寄与が1方向に限定されることが明確である他の設備においても水平2方向の地震力を組み合わせても1方向の地震力による応力と同等のものとして分類した。

- (2) 水平方向とその直交方向が相関する振動モード(ねじれ振動等)が生じる観点

水平方向とその直交方向が相関する振動モードが生じることで有意な影響が生じる可能性のある設備を抽出する。

機器・配管系設備のうち、円筒形容器のように水平方向の各軸方向に対して均等な構造となっている機器は、評価上有意なねじれ振動は生じない。

一方、3次元的な広がりを持つ配管系等は、系全体として考えた場合、有意なねじれ振動が発生する可能性がある。

- (3) 水平1方向及び鉛直方向地震力に対する水平2方向及び鉛直方向地震力の増分の観点

(1)(2)において影響の可能性のある設備について、水平2方向の地震力が各方向1:1で入力された場合に各部にかかる荷重や応力を求め、従来の水平1方向及び鉛直方向地震力の設計手法による発生値と比較し、その増分により影響の程度を確認し、耐震性への影響が懸念される設備を抽出した。

水平1方向に対する水平2方向の地震力による発生値の増分の検討は、機種ごとの分類に対して地震力の寄与度に配慮し耐震裕度が小さい設備(部位)を対象とする。水平2方向の地震力の組合せは米国 Regulatory Guide 1.92の「2. Combining Effects Caused by Three Spatial Components of an Earthquake」を参考として非同時性を考慮した Square-Root-of-the-Sum-of-the-Squares (以下「非同時性を考慮した SRSS 法」という。)又は組合せ係数法(1.0:0.4:0.4)により組み合わせ、発生値の増分を算出する。増分の算出は、従来の評価で考慮している保守性により増分が低減又は包絡されることも考慮する。

- ・従来の評価データを用いた簡易的な算出では、地震・地震以外の応力に分離可能なものは地震による発生値のみを組み合わせ後、地震以外による応力と組み合わせ

せて算出する。

- ・応答軸が明確な設備で、設備の応答軸の方向あるいは厳しい応力が発生する向きへ地震力を入力している場合は、耐震性への影響が懸念されないものとして扱う。

3.2 建物・構築物の検討結果を踏まえた機器・配管系の設備の抽出

建物・構築物の影響評価において、「IV-1-1-7 水平2方向及び鉛直方向地震力の組合せに関する影響評価方針」のうち、「4.1 建物・構築物（洞道以外）」における「機器・配管系への影響検討」に基づき、機器・配管系への影響を検討し、水平2方向及び鉛直方向地震力の組合せによる応答値への影響がある場合は、当該応答値による影響検討結果を示す。

3.3 水平2方向及び鉛直方向地震力の評価部位の抽出結果

3.1項で検討した、水平2方向の地震力が重複する観点、水平方向とその直交方向が相関する振動モード(ねじれ振動等)が生じる観点、水平1方向及び鉛直方向地震力に対する水平2方向及び鉛直方向地震力の増分の観点で、水平2方向の地震力による影響の可能性のある設備の評価部位を抽出した結果を第3.3-1表に示す。

第1回申請範囲については影響軽微であり、設備が有する耐震性に影響のないことを確認した。

3.4 水平2方向及び鉛直方向地震力の組合せの影響評価

3.1項の観点から3.3項で抽出された設備について、水平2方向及び鉛直方向地震力を想定した発生値を以下の方法により算出する。

発生値の算出における水平2方向及び鉛直方向地震力の組合せは、米国 Regulatory Guide 1.92 の「2. Combining Effects Caused by Three Spatial Components of an Earthquake」を参考として非同時性を考慮した SRSS 法を適用する。

(1) 従来評価データを用いた算出

従来の水平1方向及び鉛直方向地震力を組み合わせた評価結果を用いて、以下の条件により水平2方向及び鉛直方向地震力に対する発生値を算出することを基本とする。

- ・水平各方向及び鉛直方向地震力をそれぞれ個別に用いて従来の発生値を算出している設備は、水平2方向及び鉛直方向地震力を組み合わせて水平2方向を考慮した発生値の算出を行う。
- ・水平1方向と鉛直方向の地震力を組合せた上で従来の発生値を各方向で算出している設備は、鉛直方向を含んだ水平各方向別の発生値を組み合わせて水平2方向を考慮した発生値の算出を行う。
- ・水平各方向を包絡した床応答曲線による地震力と鉛直方向の地震力を組み合わせた上で従来の発生値を算出している設備は、鉛直方向を含んだ水平各方向同一の

発生値を組み合わせて水平2方向を考慮した発生値の算出を行う。

また、算出にあたっては必要に応じて以下も考慮する。

- ・発生値が地震以外の応力成分を含む場合、地震による応力成分と地震以外の応力成分を分けて算出する。

3.2項の観点から3.3項で抽出された設備について、以下のいずれかの方法を用いて影響評価を行う。

- ① 3次元FEMモデルにより得られた壁及び床の応答震度に係数を掛け、影響評価用の震度を推定し、従来評価に用いている震度(設計条件)又は耐震裕度に包絡されることを確認する。
- ② 運転時の異常な過渡変化時の状態、設計基準事故時の状態及び重大事故等時の状態で施設に作用する荷重のうち、地震によって引き起こされるおそれがある事象によって作用する荷重と基準地震動による地震力。

3.5 水平2方向及び鉛直方向地震力の影響評価結果

影響評価確認結果については、影響評価を実施する設備の申請に合わせて次回以降に詳細を説明する。

第3.1-1表 水平2方向及び鉛直方向地震力の組合せの影響検討対象設備

設備	部位
冷却塔	支持架構
	伝熱管
	基礎ボルト、取付ボルト
配管(標準支持間隔法)	直管配管(水平)
	直管配管(鉛直)
	曲がり部、分岐部

第 3.3-1 表 水平 2 方向及び鉛直方向地震力の評価部位の抽出結果

設備	部位	応力分類	(1) 水平 2 方向の地震力が重複する形状	(2) 水平 2 方向の振動モードによりねじれ振動が生じる形状	(3) 水平 2 方向及び鉛直方向地震力の組合せにより応力が増化する形状 (応答軸が明確)	影響評価の要否 (1) 又は(2) で△かつ (3) で○の場合は 影響評価を実施
			△：影響の可能性有 ×：影響軽微	△：ねじれ振動発生の可能性有 ×：発生しない	○：応答軸が明確ではない ×：応答軸が明確	影響評価実施 又は影響軽微
冷却塔	支持架構	組合せ	×	×	×	影響軽微
	伝熱管	一次応力	×			
		一次+二次応力	×			
	基礎ボルト, 取付ボルト	引張	×			
		せん断	×			
配管 (標準支持間隔法)	直管配管 (水平)	一次応力	×	×	×	影響軽微
	直管配管 (鉛直)	一次応力	×			
	曲がり部 分岐部	一次応力	×			

別紙4-25

一 関東評価用地震動(鉛直)に関する 影響評価結果 建物・構築物 建物及び屋外機械基礎

本添付書類は、別で定める方針に沿った評価・計算を示す書類であり、結果を示すものであることから、発電炉との比較は行わない。
また、図書番号や数値は最終精査中。

目 次

	ページ
1. 概要	1
2. 一関東評価用地震動（鉛直）の概要	2
3. 影響評価方針	4
4. 評価対象部位の抽出と評価方法	6
4.1 評価対象部位の抽出	6
4.2 評価対象部位の評価方法	8
5. まとめ	10
IV-2-4-1-1-1-1 別紙1 安全冷却水B冷却塔基礎の一関東評価用地震動 （鉛直）に関する影響評価結果	

1. 概要

本資料は、「IV-1-1 耐震設計の基本方針」に基づき、建物・構築物の耐震評価において、一関東評価用地震動（鉛直）を考慮した場合の影響について、以下の添付書類とあわせて説明するものである。

影響評価の方法については、各計算書に示す耐震評価結果に、鉛直方向の地震荷重として一関東評価用地震動（鉛直）による影響を考慮した比率を乗じ、その評価結果が許容限界の範囲内に留まることを確認する。影響評価の方法についての詳細は「3. 影響評価方針」に示す。

本資料では、一関東評価用地震動（鉛直）を用いた影響評価を行うにあたって、評価対象部位の抽出とその評価方法を示すとともに、各建物・構築物の影響評価結果を示す。なお、各建物・構築物の影響評価結果については、本文においては概要のみを示すこととし、その詳細については別紙に示す。

- ・「IV-2-1-1-1-1-1 安全冷却水B冷却塔基礎の地震応答計算書」
- ・「IV-2-1-1-1-1-2 安全冷却水B冷却塔基礎の耐震計算書」

2. 一関東評価用地震動（鉛直）の概要

影響評価に用いる一関東評価用地震動（鉛直）について、解放基盤表面位置で一関東評価用地震動（鉛直）の設計用応答スペクトルを、基準地震動 S_s の設計用応答スペクトルと併せて第2.-1図に、設計用模擬地震波の加速度時刻歴波形を第2.-2図に示す。

事業変更許可申請書に示すとおり、一関東評価用地震動（鉛直）は、一関東観測点における岩手・宮城内陸地震の水平方向の地震観測記録の応答スペクトルに、水平方向に対する鉛直方向の地震動の比率として2/3を乗じた応答スペクトルから、一関東観測点における岩手・宮城内陸地震で得られた鉛直方向の地中記録の位相を用いて作成した地震動である。

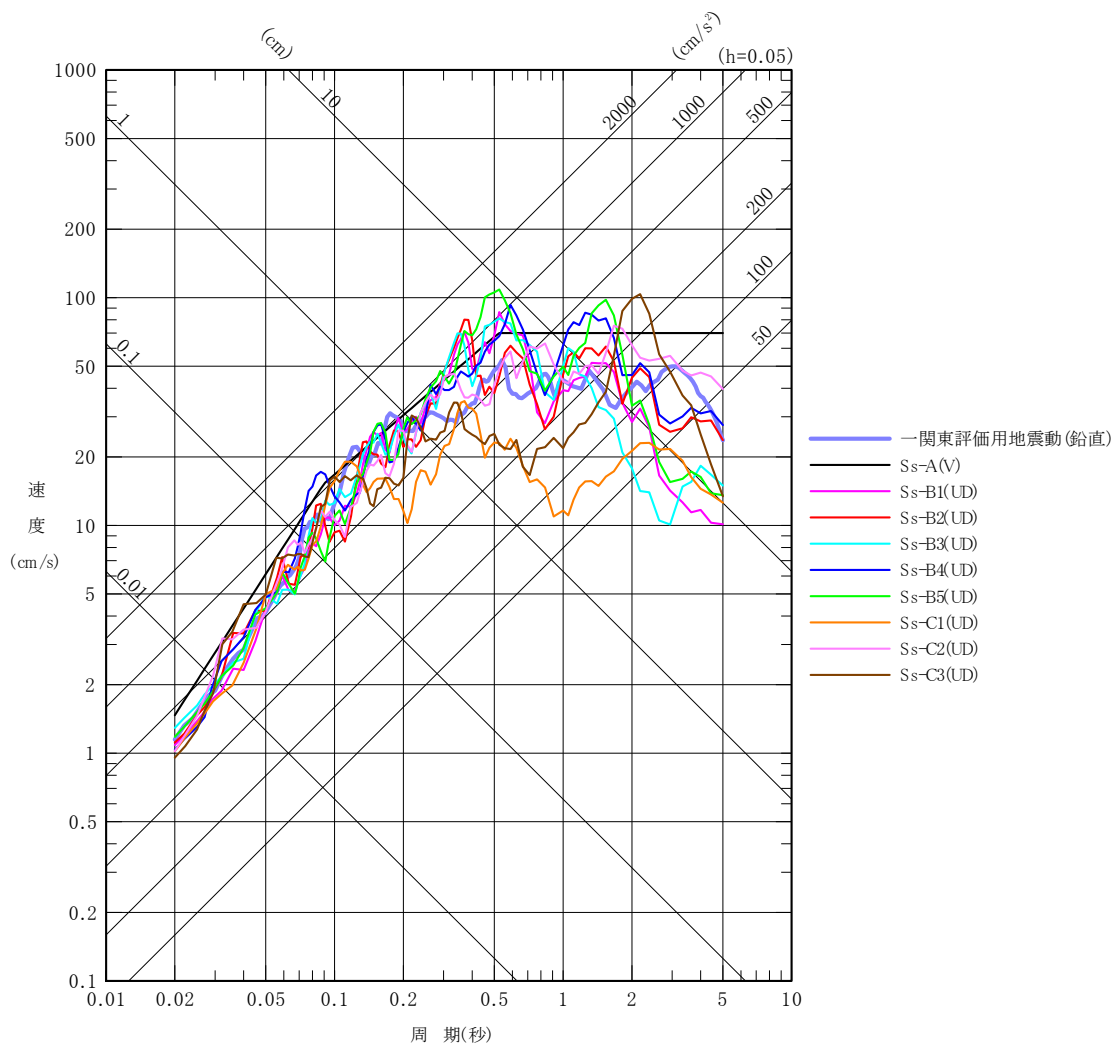

第2.-1図 一関東評価用地震動（鉛直）の設計用応答スペクトル

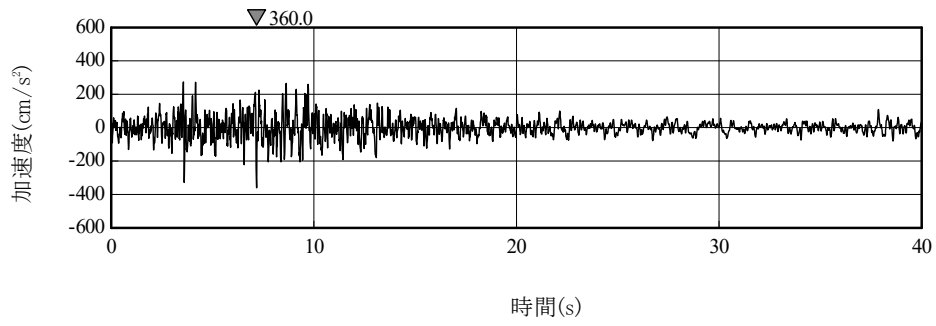

第 2. -2 図 一関東評価用地震動（鉛直）の加速度時刻歴波形

3. 影響評価方針

本章では、建物・構築物の耐震評価において、鉛直方向の地震荷重として一関東評価用地震動（鉛直）及び一関東評価用地震動（鉛直）に対して係数0.5を乗じた地震動（以下、「 $0.5 \times$ 一関東評価用地震動（鉛直）」という。）を考慮した場合の影響評価の方針について示す。

各計算書に示す耐震評価結果は、 S_s 地震時に対する評価及び S_d 地震時に対する評価において地盤物性のばらつきを考慮し、水平方向及び鉛直方向の各地震力を包絡した結果となっている。

そこで、影響評価の方法は、評価対象部位に対して、一関東評価用地震動（鉛直）、または $0.5 \times$ 一関東評価用地震動（鉛直）による影響を考慮した割増係数を、各計算書に示す地盤物性のばらつきを考慮した耐震評価結果（検定比）に乘じ、その検定比が1.000を超えないことで保守的に確認することを基本とした。なお、割増係数については、 S_s 地震時に対する評価及び S_d 地震時に対する評価それぞれについて基本ケースの解析結果による応答比率から算出する。具体的には、 S_s 地震時に対する評価については、各建物・構築物の応答解析モデルに、基準地震動 S_s （鉛直）を入力した場合に対する一関東評価用地震動（鉛直）を入力した場合のそれぞれの最大応答値による応答比率から算出する。 S_d 地震時に対する評価については、各建物・構築物の応答解析モデルに、弾性設計用地震動 S_d （鉛直）を入力した場合に対する $0.5 \times$ 一関東評価用地震動（鉛直）を入力した場合のそれぞれの最大応答値の応答比率から算出する。基準地震動 S_s （鉛直）及び弾性設計用地震動 S_d （鉛直）の最大応答値については全波をそれぞれ入力した場合の各々の波に対する最大応答値の包絡値を示す。

また、本検討は、鉛直方向の影響検討であることから、水平方向の地震力が寄与する部分への割増しは不要であるが、保守的に水平方向と鉛直方向の両方向の地震力を考慮した検定比に対して、一律割増しを行う。

ここで、一関東評価用地震動（鉛直）及び $0.5 \times$ 一関東評価用地震動（鉛直）による地震応答解析に用いる応答解析モデルは、「IV-2-1-1-1-1-1 安全冷却水B冷却塔基礎の地震応答計算書」に示す地震応答解析モデル（鉛直方向）とする。

評価対象部位は、各計算書において耐震評価を実施している部位のうち、鉛直方向の地震力の影響を受ける部位とし、詳細は「4.1 評価対象部位の抽出」に示す。

抽出した評価対象部位に対する評価方法の詳細は、「4.2 評価対象部位の評価方法」に示す。

また、割増係数を乗じた検定比が1.000を超える場合、即ち、安全上支障がないと言えない場合は、詳細評価として、基準地震動 $S_s - C4$ （水平）と一関東評価用地震動（鉛直）、または弾性設計用地震動 S_d （水平）と $0.5 \times$ 一関東評価用地震動（鉛直）を組み合わせた地震荷重を用いた応力解析による評価を実施する。

上記を踏まえた、評価フローを第3.-1図に示す。

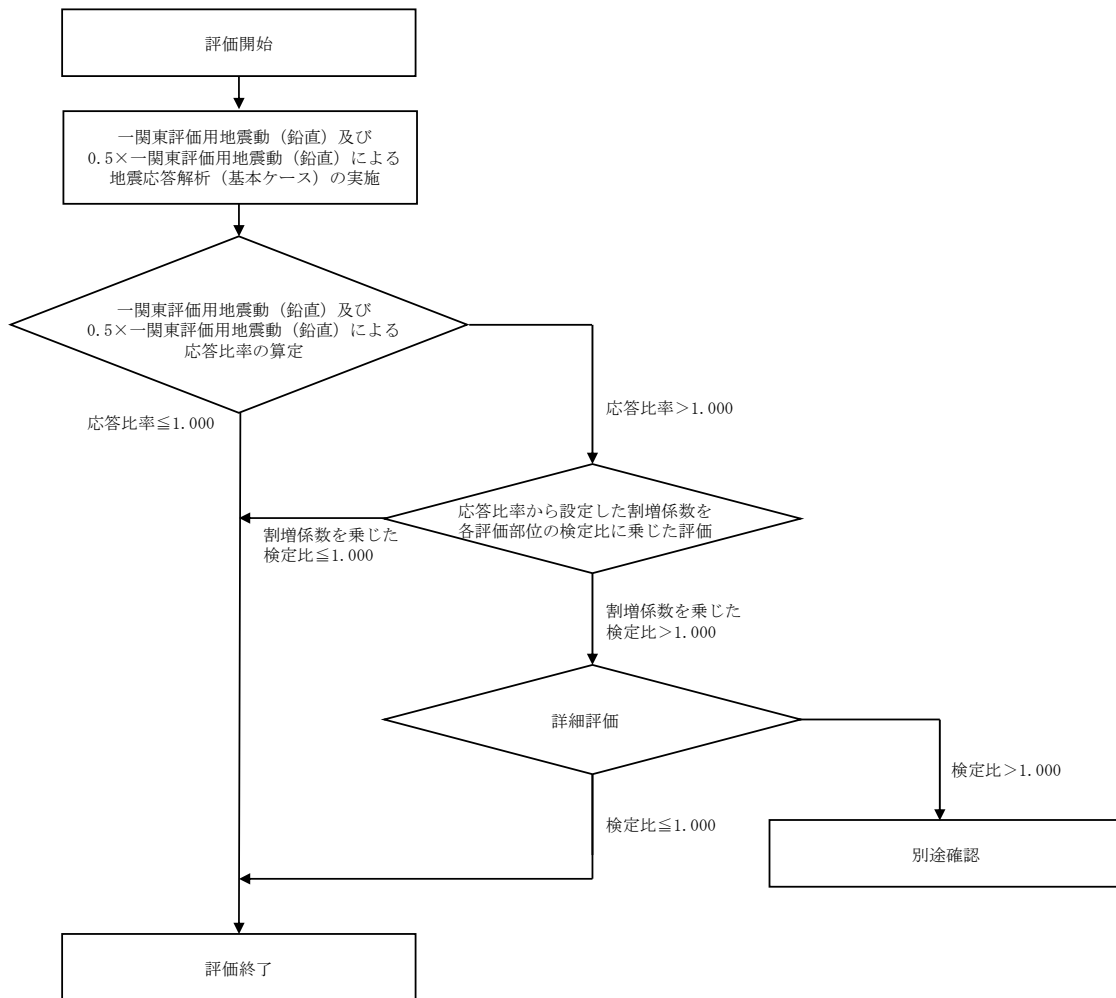

第3.-1図 評価フロー

4. 評価対象部位の抽出と評価方法

4.1 評価対象部位の抽出

「3. 影響評価方針」に示すとおり、評価対象部位は、各計算書において耐震評価を実施している部位のうち、鉛直方向の地震力の影響を受ける部位とする。

計算書において耐震評価結果を示す部位としては、耐震壁、地盤（接地圧）、基礎スラブ、Sクラスの壁及び床*、屋根鉄骨及び屋根トラスが存在する。このうち、耐震評価において鉛直方向の地震荷重を組み合わせる耐震評価を行っている、地盤（接地圧）、基礎スラブ、Sクラスの壁及び床、屋根鉄骨及び屋根トラスを本評価における評価対象部位として抽出した。

耐震壁、並びにSクラスの壁のうちセル壁、貯蔵区域の壁、受入れ室の壁及び貯蔵室等の壁（以下、「セル壁等」という。）については、S_s地震時に対する評価において、水平方向の地震荷重により求まる各層の最大せん断ひずみ度が許容限界を超えないことを確認することで、構造強度、機能維持の確認が可能であり、鉛直方向の地震荷重は組み合わせしていない。以上のことから、耐震壁及びセル壁等のS_s地震時に対する評価については本評価の対象外とする。

また、Sクラスの床についてはS_d地震時に対する評価及びS_s地震時に対する評価の判定値は短期許容応力度であり、弾性設計用地震動S_dによる地震力よりも基準地震動S_sによる地震力の方が大きいことから、S_s地震時の評価にS_d地震時の評価が包含されるため、本評価ではS_s地震時の評価を対象とする。

各建物・構築物の評価対象部位及び応答比率の算定に用いる地震動の整理結果を第4.1-1表に示す。

注記 *：セル壁及び床、貯蔵区域の壁及び床、受入れ室の壁及び床、貯蔵室等の壁及び床、プールの壁及び床

第4. 1-1表 評価対象部位及び応答比率の算定に用いる地震動の整理結果

施設区分	評価対象部位及び 応答比率の算定に用いる地震動 建物・構造物名称		地盤 (接地圧)	基礎スラブ	耐震壁	Sクラス壁		Sクラス床		屋根鉄骨 屋根トラス
			基準地震動S _s (鉛直)と 一関東評価用地震動 (鉛直)	基準地震動S _s (鉛直)と 一関東評価用地震動 (鉛直)	基準地震動S _g (鉛直)と 一関東評価用地震動 (鉛直)	基準地震動S _s (鉛直)と 一関東評価用地震動 (鉛直)	弾性設計用地震動S _d (鉛直)と 0.5×一関東評価用地震動 (鉛直)	基準地震動S _s (鉛直)と 一関東評価用地震動 (鉛直)	弾性設計用地震動S _d (鉛直)と 0.5×一関東評価用地震動 (鉛直)	基準地震動S _s (鉛直)と 一関東評価用地震動 (鉛直)
再処理施設	安全冷却水B冷却塔 (基礎)	A4基礎	○	○	—	—	—	—	—	—

○：対象建屋に当該評価対象部位が存在する場合
 —：対象建屋に当該評価対象部位が存在しない場合

4.2 評価対象部位の評価方法

① 地盤（接地圧）

地盤（接地圧）については、 S_s 地震時に対する評価として、水平地震力及び鉛直地震力の組合せにより算出していることから、基礎スラブの要素の最大応答軸力の応答比率（一関東評価用地震動（鉛直）/基準地震動 S_s （鉛直））を割増係数として設定し、各計算書に示す最大接地圧の検定比に乗じて検定比が1.000を超えないことを確認する。

② 基礎スラブ

基礎スラブについては、 S_s 地震時に対する評価として、上部構造からの水平地震力及び鉛直地震力の組合せ応力を考慮することから、基礎スラブの直上の要素における最大応答軸力の応答比率（一関東評価用地震動（鉛直）/基準地震動 S_s （鉛直））の最大値を割増係数として設定し、各計算書に示す応力評価結果の検定比に乗じて検定比が1.000を超えないことを確認する。

③ Sクラスの壁及び床

a. Sクラスの壁

Sクラスの壁のうち、セル壁等については、 S_d 地震時に対する評価として、水平地震力及び鉛直地震力の組合せ応力を考慮することから、セル壁等の位置する要素における最大応答軸力の応答比率（ $0.5 \times$ 一関東評価用地震動（鉛直）/弾性設計用地震動 S_d （鉛直））の最大値を割増係数として設定し、各計算書に示す応力評価結果の検定比に乗じて検定比が1.000を超えないことを確認する。

Sクラスの壁のうち、プールの壁については、 S_s 地震時に対する評価及び S_d 地震時に対する評価として、水平地震力及び鉛直地震力の組合せ応力を考慮することから、プールの壁の位置する要素における最大軸応力度の応答比率（ S_s 地震時の評価の場合は一関東評価用地震動（鉛直）/基準地震動 S_s （鉛直）、 S_d 地震時の評価の場合は $0.5 \times$ 一関東評価用地震動（鉛直）/弾性設計用地震動 S_d （鉛直））の最大値を割増係数として設定し、各計算書に示す応力評価結果の検定比に乗じて検定比が1.000を超えないことを確認する。

b. Sクラスの床

Sクラスの床については、 S_s 地震時に対する評価として、鉛直方向の地震荷重として慣性力を考慮することから、Sクラスの床の位置する質点における鉛直方向の最大応答加速度の応答比率（一関東評価用地震動（鉛直）/基準地震動 S_s （鉛直））の最大値を割増係数として設定し、各計算書に示す応力評価結果の検定比に乗じて検定比が1.000を超えないことを確認する。

④ 屋根鉄骨，屋根トラス

屋根鉄骨，屋根トラスの S_s 地震時に対する評価として，屋根鉄骨，屋根トラスを支持する柱部材までモデル化した立体フレームモデルへの入力地震動に柱脚部の時刻歴応答加速度（水平方向及び鉛直方向）を用いることから，柱脚部レベルの質点における最大応答加速度の応答比率（一関東評価用地震動（鉛直）/基準地震動 S_s （鉛直））の最大値を割増係数として設定し，各計算書に示す応力評価結果の検定比に乗じて検定比が1.000を超えないことを確認する。

なお，①～④の評価において，応答比率の最大値が1.000を超えない場合は，その時点で評価終了とする。また，割増係数に乗じた検定比が1.000を超える場合は，詳細評価として，水平方向の基準地震動 $S_s - C4$ と一関東評価用地震動（鉛直），または水平方向の弾性設計用地震動 $S_d - C4$ と $0.5 \times$ 一関東評価用地震動（鉛直）を組み合わせた地震荷重を用いた応力解析による評価を実施することとし，その評価方法は，各計算書の評価方法に倣うものとする。

5. まとめ

各建物・構築物について、一関東評価用地震動（鉛直）及び0.5×一関東評価用地震動（鉛直）の影響評価結果の概要を第5.-1表に示す。（影響評価結果の詳細は別紙を参照。）

各建物・構築物の評価対象部位について、応答比率が1.000を超えないこと、または応答比率が1.000を超える場合は、割増係数を乗じた検定比が1.000を超えないことを確認した。

以上のことから、各建物・構築物の耐震評価について、鉛直方向の地震荷重として一関東評価用地震動（鉛直）及び0.5×一関東評価用地震動（鉛直）を考慮した場合においても影響はなく、安全上支障がないことを確認した。

第5.-1表 一関東評価用地震動（鉛直）及び0.5×一関東評価用地震動（鉛直）の
影響評価結果（検定比一覧）

申請 回次	建物・構築物名称		影響評価結果*1*2				
			地盤 (接地圧)	基礎スラブ	Sクラスの 壁	Sクラスの 床	屋根鉄骨 屋根トラス
再処理施設	安全冷却水B冷却塔（基礎）	A4基礎	影響なし	影響なし	—	—	—

注記 *1：応答比率が1.000を超えない場合、又は応答比率が1.000を超える場合でも割増係数を考慮した検定比が1.000を超えない場合は、「影響なし」と表記する。

*2：各計算書に示す応力評価結果の検定比に応答比率から設定した割増係数を乗じた時の値を示す。

IV-2-4-1-1-1-1

別紙1 安全冷却水B冷却塔基礎の
一関東評価用地震動（鉛直）に関する
影響評価結果

目 次

	ページ
1. 概要	1
2. 一関東評価用地震動（鉛直）による入力地震動	2
3. 応答比率の算定	3
4. 評価結果	6

1. 概要

本資料は、「IV-2-4-1-1-1-1 建物及び屋外機械基礎の一関東評価用地震動（鉛直）に関する影響評価結果」本文の「3. 影響評価方針」に基づき、安全冷却水B冷却塔（基礎）の耐震評価における鉛直方向の地震力の影響を受ける評価対象部位について、鉛直方向の地震荷重として一関東評価用地震動（鉛直）を考慮した場合の影響評価結果の詳細を示す。

2. 一関東評価用地震動（鉛直）による入力地震動

本文の「3. 影響評価方針」に示すとおり、割増係数の算出に用いる応答比率を算定するために、一関東評価用地震動（鉛直）を用いた鉛直方向の地震応答解析（基本ケース）を実施する。

一関東評価用地震動（鉛直）について、安全冷却水B冷却塔の鉛直方向の入力地震動として用いる、基礎底面位置（T.M.S.L. 53.80m）における地盤応答の加速度応答スペクトルを、基準地震動 S_s の同位置における地盤応答の加速度応答スペクトルと併せて第2.-1図に示す。

なお、鉛直方向の入力地震動は基本ケースの地盤物性を用い、「IV-2-1-1-1-1-1 安全冷却水B冷却塔基礎の地震応答計算書」に示す手法と同様に、1次元波動論に基づき、解放基盤表面で定義される一関東評価用地震動（鉛直）に対する構築物基礎底面レベルでの地盤の応答として評価したものである。

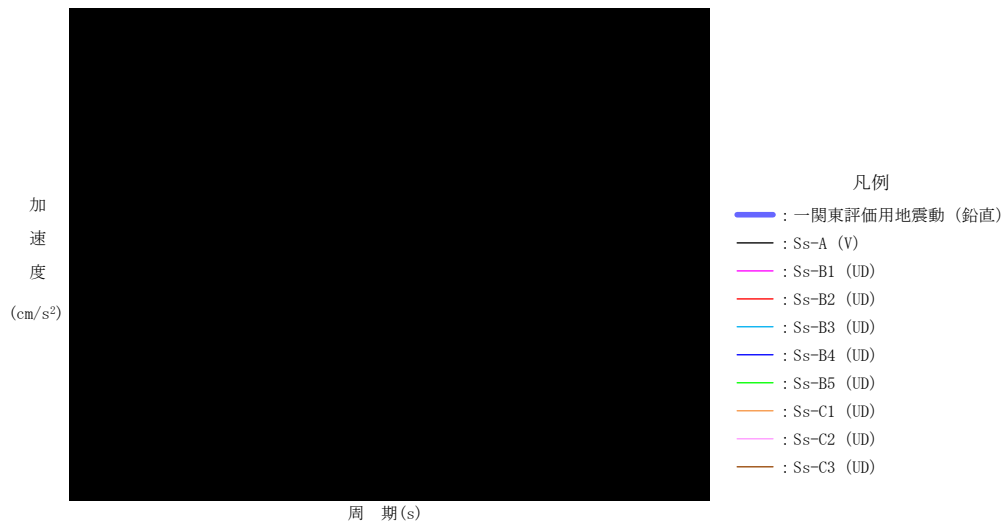

第2.-1図 一関東評価用地震動（鉛直）による入力地震動の加速度応答スペクトル
(T.M.S.L. 53.80m)



第3.-1図 地震応答解析モデル (鉛直方向)

第3.-1表 基準地震動S_s（鉛直）と一関東評価用地震動（鉛直）の
最大応答加速度の比較

T. M. S. L. (m)	質点番号	最大応答加速度 (cm/s ²) * ¹		応答比率* ² (②/①)
		①基準地震動S _s (鉛直) 全波包絡	②一関東評価用 地震動 (鉛直)	

注記 *1：基本ケースの結果，網掛けは最大値を示す

*2：小数第4位を保守的に切上げ

第3.-2表 基準地震動S_s（鉛直）と一関東評価用地震動（鉛直）の最大応答軸力の比較

T. M. S. L. (m)	要素番号	最大応答軸力 (×10 ³ kN) * ¹		応答比率* ² (②/①)
		①基準地震動S _s (鉛直) 全波包絡	②一関東評価用 地震動 (鉛直)	

注記 *1：基本ケースの結果，網掛けは最大値を示す

*2：小数第4位を保守的に切上げ

4. 評価結果

安全冷却水B冷却塔（基礎）について地盤（接地圧）、基礎スラブの評価を実施した。

鉛直方向の地震力の影響を受ける評価対象部位について、以下のとおり一関東評価用地震動（鉛直）の影響評価結果を示す。

(1) 地盤（接地圧）

地盤（接地圧）については、鉛直方向の地震荷重として軸力を考慮することから、基礎スラブが位置するT. M. S. L. ■■■■m～■■■■m（要素番号3）の最大応答軸力の応答比率を割増係数として設定する。第4. -1表に応答比率及び割増係数を示す。

第4. -1表より、応答比率は■■■■であり1.000を超えないことから、地盤（接地圧）の評価に及ぼす影響がないことを確認した。

(2) 基礎スラブ

基礎スラブは、鉛直方向の地震荷重として上部構造から基礎への軸力を考慮することから、基礎スラブ上層T. M. S. L. ■■■■m～■■■■m（要素番号1～2）の最大応答軸力の応答比率を割増係数として設定する。第4. -2表に応答比率及び割増係数を示す。

第4. -2表より、応答比率は■■■■であり1.000を超えないことから、基礎スラブの耐震評価に及ぼす影響がないことを確認した。

以上より、安全冷却水B冷却塔（基礎）の耐震評価について、鉛直方向の地震荷重として一関東評価用地震動（鉛直）を考慮した場合においても、安全上支障がないことを確認した。

第4.-1表 最大応答軸力の応答比率及び割増係数（地盤（接地圧））

T. M. S. L. (m)	要素 番号	最大応答軸力（×10 ³ kN）* ¹		応答比率* ² (②/①)	割増 係数* ³	割増係数 を乗じた 評価の要 否
		①基準地震動 Ss（鉛直） 全波包絡	②一関東評価 用地震動 （鉛直）			
					-	不要

注記 *1：基本ケースの結果，網掛けは最大値を示す

*2：小数第4位を保守的に切上げ

*3：応答比率が1.000を超えない場合は「-」とする

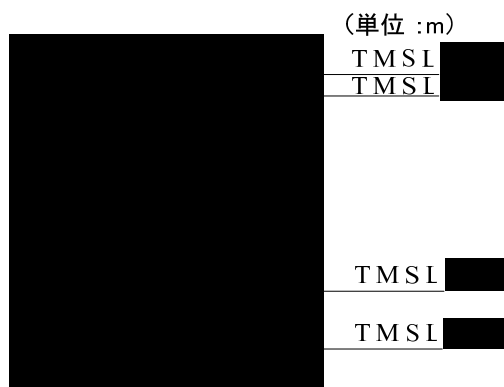

注記 1：○数字は質点番号を示す。

2：□数字は要素番号を示す。

3：破線囲みは該当する要素番号を示す。

第4.-2表 最大応答軸力の応答比率及び割増係数（基礎スラブ）

T. M. S. L. (m)	要素 番号	最大応答軸力（×10 ³ kN）* ¹		応答比率* ² (②/①)	割増 係数* ³	割増係数 を乗じた 評価の要 否
		①基準地震動 Ss（鉛直） 全波包絡	②一関東評価 用地震動 （鉛直）			
					-	不要

注記 *1：基本ケースの結果，網掛けは最大値を示す

*2：小数第4位を保守的に切上げ

*3：応答比率が1.000を超えない場合は「-」とする

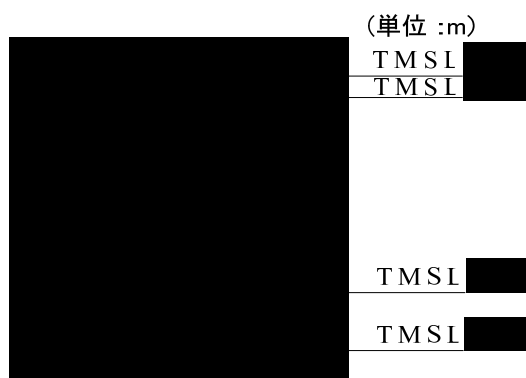

注記 1：○数字は質点番号を示す。

2：□数字は要素番号を示す。

3：破線囲みは該当する要素番号を示す。

別紙4-26

一関東評価用地震動(鉛直)に関する 影響評価結果 建物・構築物 竜巻防護対策設備

本添付書類は、別で定める方針に沿った評価・計算を示す書類であり、結果を示すものであることから、発電炉との比較は行わない。

安全冷却水B冷却塔飛来物防護ネットは地盤応答を設計用モデルで実施しており、鉛直応答が低くなる特徴を踏まえて、評価に用いた基準地震動13波に一関東評価用地震動(鉛直)を考慮した地震動で耐震評価を以下にて実施している。

- ・別紙4-21 安全冷却水B冷却水 飛来物防護ネットの計算書

別紙4-27

一 関東評価用地震動(鉛直)に関する 影響評価結果 機器・配管系

本添付書類は、別で定める方針に沿った評価・計算を示す書類であり、結果を示すものであることから、発電炉との比較は行わない。
また、図書番号や数値は最終精査中。

注) 本資料は、「IV-2 再処理施設の耐震性に関する計算書」に示している計算結果を用いて影響評価結果を示しているため、以下の関連する補足説明資料の考え方から記載内容の見直し。

- ・補足説明資料「[補足耐 20] 耐震機電 09 耐震性設計の基本方針に係る耐震 S クラス設備の耐震計算書における S d 評価結果の記載方法」にて説明している基準地震動 S s の発生値を用いた弾性設計用地震動 S d に対する健全性の示し方の考えから影響評価結果の示し方について適正化。
- ・補足説明資料「[補足耐 40] 耐震機電 16 配管系の評価手法(定ピッチスパン法)について」にて説明している実施工配管の評価に対して設計方針である標準支持間隔法が保守性を有している設計手法であることを踏まえ、「IV-1-1-11 配管系の支持方針」の標準支持間隔の解析結果に対しては影響評価の対象には含めないこととした。

目 次

1. 概要	1
2. 影響評価方針	1
3. 影響評価内容	1
4. 影響評価結果	2

別紙 1 安全冷却水 B 冷却塔

1. 概要

本資料は、「IV-2-4-1-1 建物・構築物」にて示している一関東評価用地震動(鉛直)を考慮した地震応答解析の結果を踏まえ、機器・配管系の耐震安全性への影響について説明するものである。

2. 影響評価方針

一関東評価用地震動(鉛直)の影響評価の方針としては、「IV-2-1 再処理設備本体等に係る耐震性に関する計算書」(以下「耐震計算書」という。)に示している設備の耐震評価結果の算出に用いた地震力については、添付書類「IV-1-1-6 設計用床応答曲線の作成方針」に基づき作成した設計用床応答曲線(FRS)又は最大床応答加速度(ZPA)による地震力(以下「設計用地震力」という。)を用いて評価を行っている。

これに対するに一関東評価用地震動(鉛直)の影響評価の方法としては、耐震計算書に示している耐震安全性に影響を与えないことの確認として、設計用地震力と一関東評価用地震動(鉛直)を考慮した地震力(以下「一関東(鉛直)地震力」という。)の比較により行う。

3. 影響評価内容

設計用地震力と一関東(鉛直)地震力の比較による影響評価の内容としては、設計用地震力と一関東(鉛直)地震力の重ね合わせを行い、設計用地震力に対して一関東(鉛直)地震力が超過する場合は、超過する周期帯(以下「超過周期帯」という。)に固有周期を有する設備を特定し、超過周期帯の最大加速度比と耐震計算書の評価結果の耐震裕度を用いて耐震安全性に影響がないことを確認する。

なお、剛な設備については、設計用地震力と一関東(鉛直)地震力の最大床応答加速度の加速度比較を行い、超過する場合には加速度比と耐震計算書の評価結果の耐震裕度を用いて耐震安全性に影響がないことを確認する。

一関東(鉛直)地震力の影響評価対応フローを第3-1図に示す。

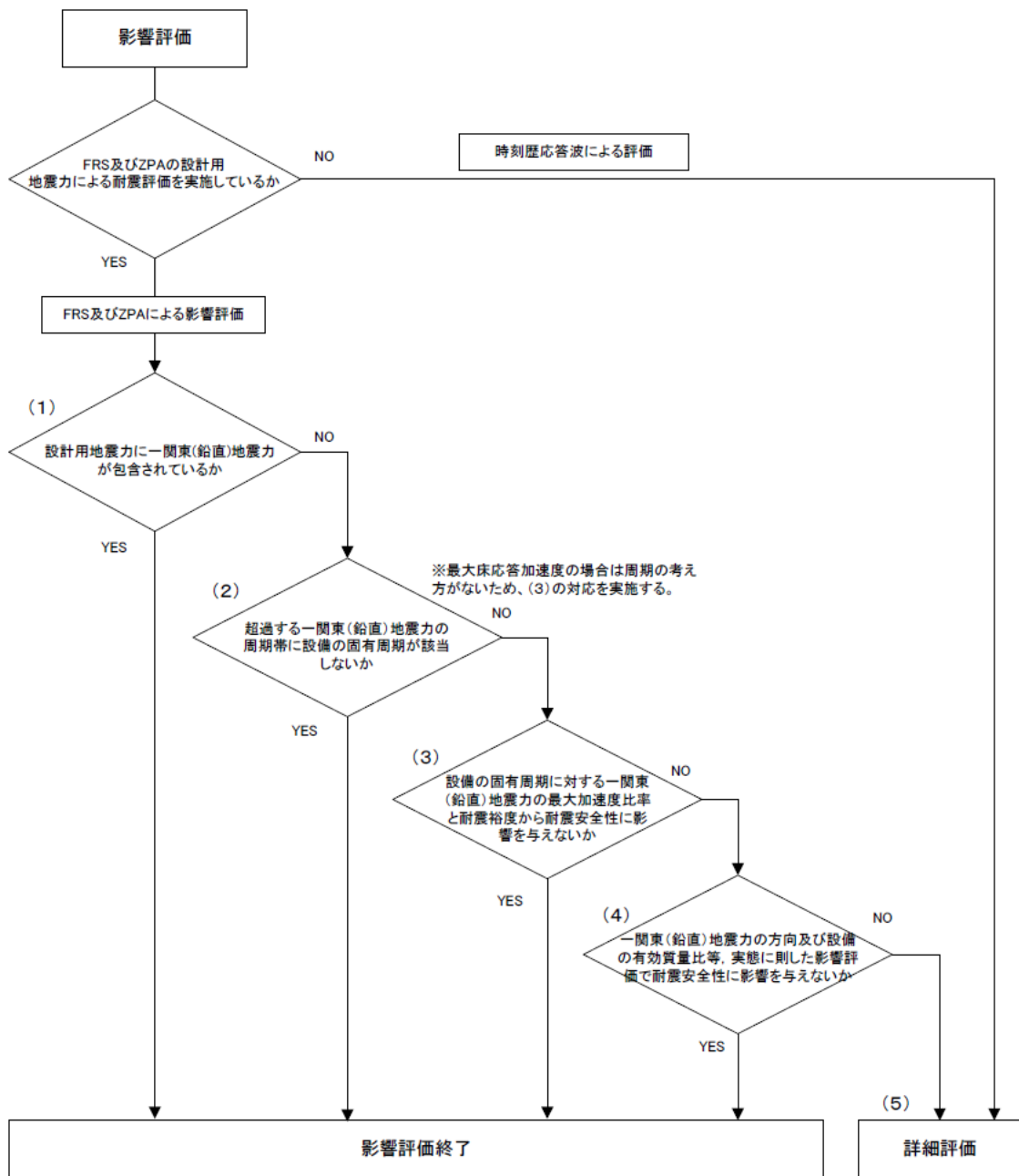

第 3-1 図 一関東評価用地震動(鉛直)の影響を考慮した影響評価対応フロー

4. 影響評価結果

影響評価方針に基づく一関東(鉛直)地震力との比較による耐震安全性への影響評価結果を別紙 1 に示す。

IV-2-4-1-2 別紙 1

安全冷却水 B 冷却塔

一関東評価用地震力(鉛直)に対する影響評価結果

IV-2 再処理施設の耐震性に関する計算書					確認結果*1								
添付書類番号	添付書類名称		発生応力 (MPa) *2	許容応力 (MPa)	1次固有周 期(s)	簡易評価				(5) 詳細評価			
						(1)	(2)	(3)		(4)		発生応力 (MPa)	応力比
								発生応力 (MPa)	応力比	発生応力 (MPa)	応力比		
IV-2-1-2-1-1-1 *3	安全冷却水B冷 却塔の耐震計算 書					○	/	/	/	/	/	/	
	支持架構 支持架構搭載 機器					○	/	/	/	/	/	/	
IV-1-1-11-1-1 別紙1	安全機能を有する施設の直管部標 準支持間隔*4					○	/	/	/	/	/	/	/

- *1: 「IV-2-4-1-2-1 機器・配管系の一関東評価用地震動(鉛直)に関する影響評価結果」の「3. 影響評価内容 第3-1 図」において、「YES」となった結果を「○」又は数値で示す。
- *2: 「IV-2 再処理施設の耐震性に関する計算書」に示す機器・配管系の各計算書において最大応力比となった評価部位に対する計算結果を示す。
- *3: IV-2-1-2-1-1-1 安全冷却水B冷却塔の耐震計算書に示す評価結果のうち、固有周期の異なる支持架構(基礎ボルト含む)及び支持架構搭載機器(伝熱管含む)について、最大応力比の評価部位に対して影響確認結果を示す。
- *4: 直管部標準支持間隔については、最大応力比の支持間隔に対して標準支持間隔の最長固有周期までの最大の加速度比率を用いた影響確認結果を示す。

別紙4-28

隣接建屋に関する影響評価結果 建物・構築物 建物及び屋外機械基礎 安全冷却水B冷却塔の隣接建屋に 関する影響評価結果

本添付書類は、別で定める方針に沿った評価・計算を示す書類であり、結果を示すものであることから、発電炉との比較は行わない。
また、図書番号や数値は最終精査中。

目 次

	ページ
1. 概要	1
1.1 位置	2
1.2 構造概要	3
1.3 検討方針	4
1.4 準拠規格・基準等	5
2. 隣接建屋の影響を考慮した地震応答解析	6
2.1 検討ケース	6
2.2 建屋のモデル化	9
2.3 地盤モデルの詳細	15
2.4 建屋-地盤間の境界条件の詳細	18
2.5 検討用地震動及び検討用モデルへの入力方法	19
2.6 地震応答解析結果	21
3. 建物・構築物の応答増幅の評価	28
3.1 検討対象部位及び検討方法	28
3.1.1 検討対象部位	28
3.1.2 地盤（接地圧）の検討方法	29
3.1.3 基礎スラブの検討方法	30
3.2 検討結果	30

1. 概要

本資料は、「IV-1-1 耐震設計の基本方針」, 「IV-1-1-2 地盤の支持性能に係る基本方針」, 「IV-1-1-5 地震応答解析の基本方針」及び「IV-1-1-8 機能維持の基本方針」に基づく隣接建屋の影響を考慮した地震応答解析及び建物・構築物の耐震性について、以下の添付書類とあわせて説明するものである。なお、機器・配管系の耐震評価に対する隣接建屋の影響については、本資料で示す隣接建屋の影響を考慮した地震応答解析より得られた床応答に基づき、「IV-2-4-2 隣接建屋に関する影響評価結果」のうち、「IV-2-4-2-2 機器・配管系」で説明する。

- ・「IV-2-1-1-1-1-1 安全冷却水B冷却塔基礎の地震応答計算書」
- ・「IV-2-1-1-1-1-2 安全冷却水B冷却塔基礎の耐震計算書」

1.1 位置

評価対象建屋である安全冷却水B冷却塔基礎と、隣接建屋と設定する分析建屋の配置位置を第1.1-1図に示す。

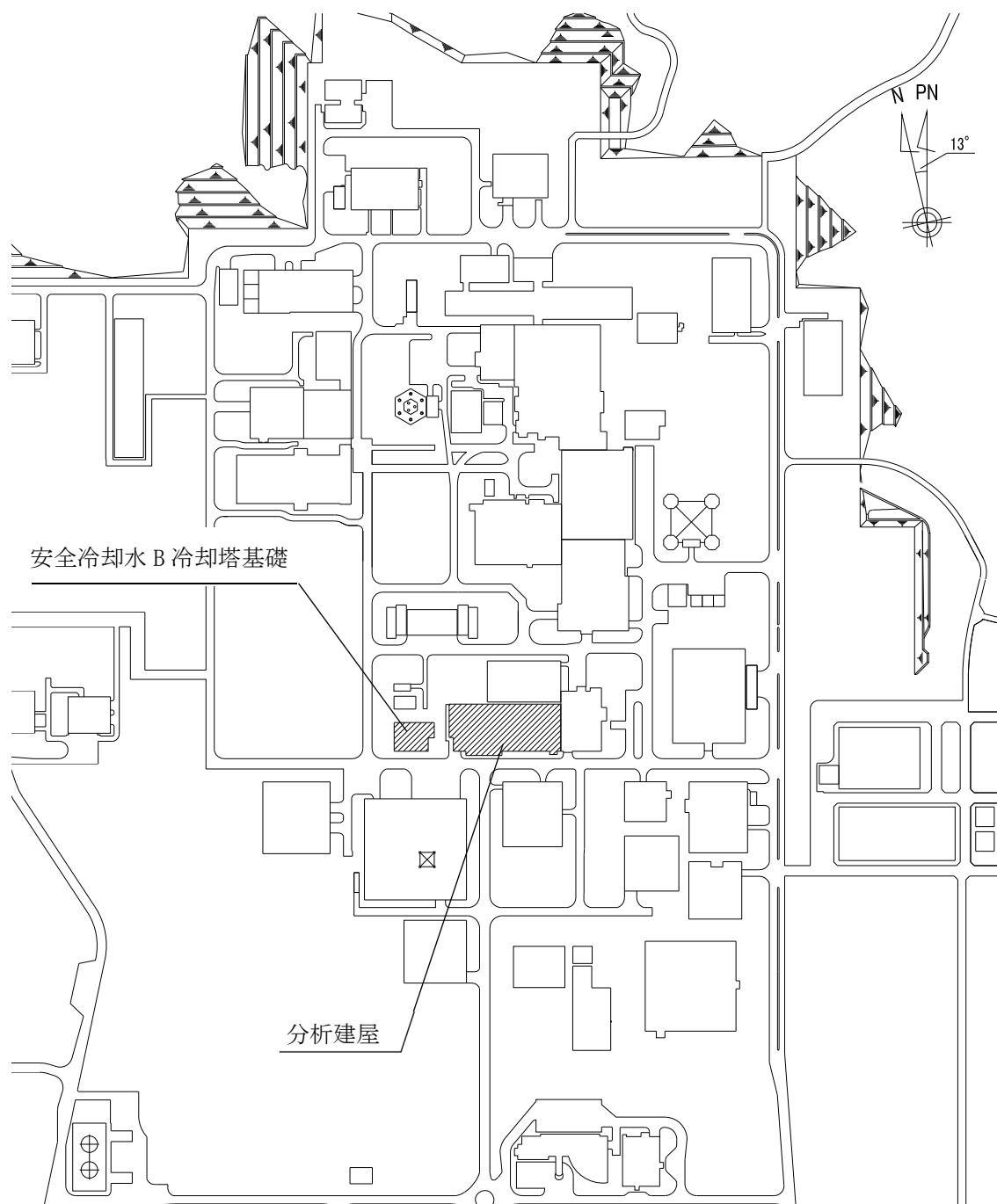

第1.1-1図 安全冷却水B冷却塔基礎，分析建屋の設置位置

1.3 検討方針

隣接建屋を考慮した地震応答解析は、「IV-1-1-5 地震応答解析の基本方針」に基づいて行う。

FEMを用いた検討として、実際の建屋配置状況に則して各建屋を配置する場合と、建屋を単独でモデル化する場合の地震応答解析を実施し、両者の建屋応答の比較から得られる応答比率を用いて建物・構築物の耐震評価に与える影響を確認する。

隣接建屋を考慮した評価のフローを第1.3-1図に示す。なお、機器・配管系の耐震評価に対する隣接建屋の影響については、本資料で示す隣接建屋の影響を考慮した地震応答解析より得られた床応答に基づき、「IV-2-4-2 隣接建屋に関する影響評価結果」のうち、「IV-2-4-2-2 機器・配管系」で説明する。

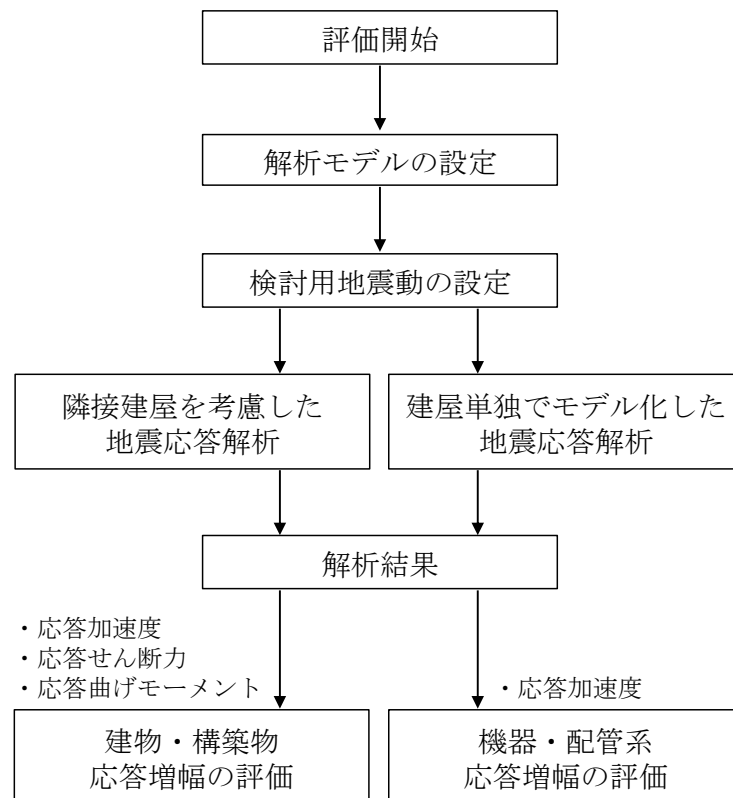

第1.3-1図 隣接建屋を考慮した評価のフロー

1.4 準拠規格・基準等

- 地震応答解析及び施設の耐震性の確認において準拠する規格・基準等は、「IV-1-1 耐震設計の基本方針」と同一とする。

2. 隣接建屋の影響を考慮した地震応答解析

本検討で用いる地震応答解析モデルは、建屋を質点系モデルとし、地盤を3次元FEMモデルとした地盤3次元FEMモデルとする。

建物・構築物は、評価対象建屋である安全冷却水B冷却塔基礎に加えて、当該評価対象建屋に隣接する分析建屋と飛来物防護ネットをモデル化に考慮する。

地震応答解析は、解析コード「NAPISOS Ver. 2.0」を用いる。なお、解析コードの検証及び妥当性確認等の概要については、「IV-3 計算機プログラム(解析コード)の概要」に示す。

2.1 検討ケース

検討にあたっては、実際の建屋配置状況に則して各建屋を配置した場合の地震応答解析モデル（以下、「隣接モデル」という。）と、各建屋（評価対象建屋）を単独でモデル化した場合の地震応答解析モデル（以下、「単独モデル」という。）を用いる。検討は、各ケースそれぞれについて水平方向のNS方向及びEW方向の2成分について行う。

解析ケースの一覧を第2.1-1表に示す。また、第2.1-1図及び第2.1-2図に各解析ケースのモデルの概要を示す。

第2.1-1表 解析ケース一覧

解析ケース	解析モデル	モデル化する建屋
隣接	隣接モデル	・安全冷却水B冷却塔基礎 (A4B) ・分析建屋 (AH)
A4B 単独	単独モデル	・安全冷却水B冷却塔基礎 (A4B)

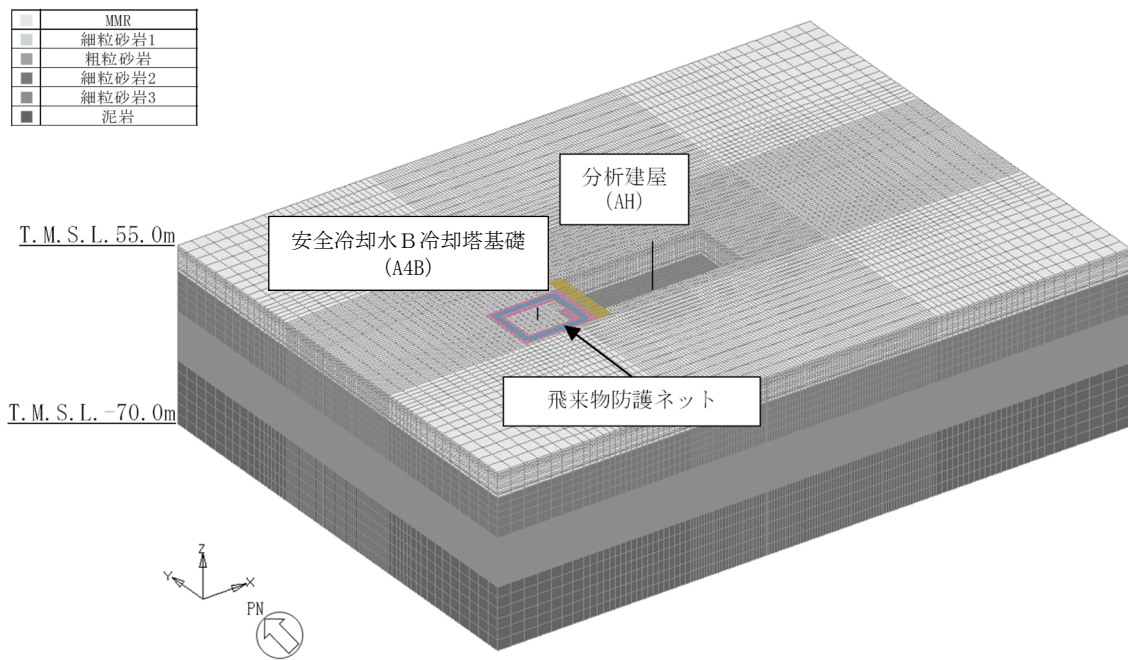

(a) 全体図

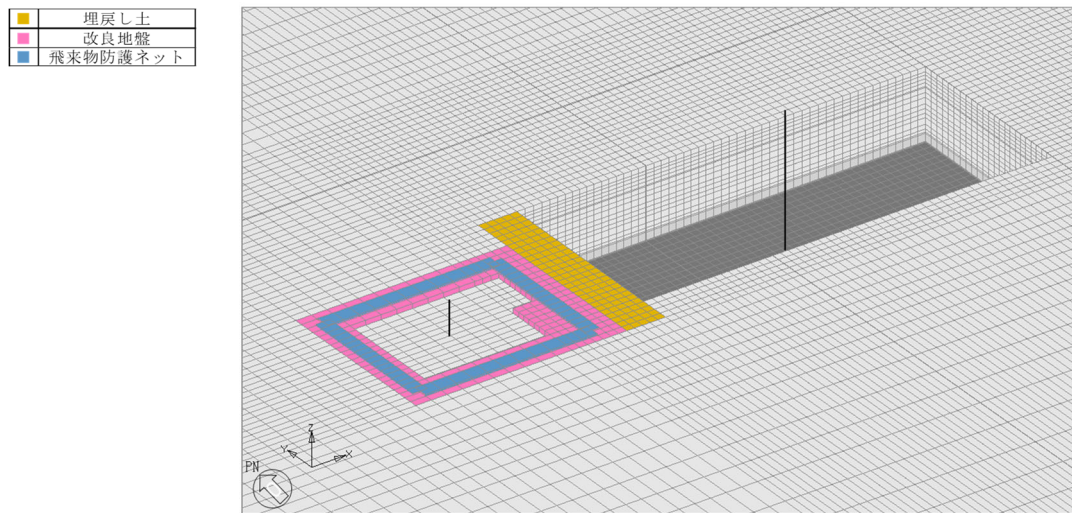

(b) 建屋周辺図

第2.1-1図 隣接モデルの概要

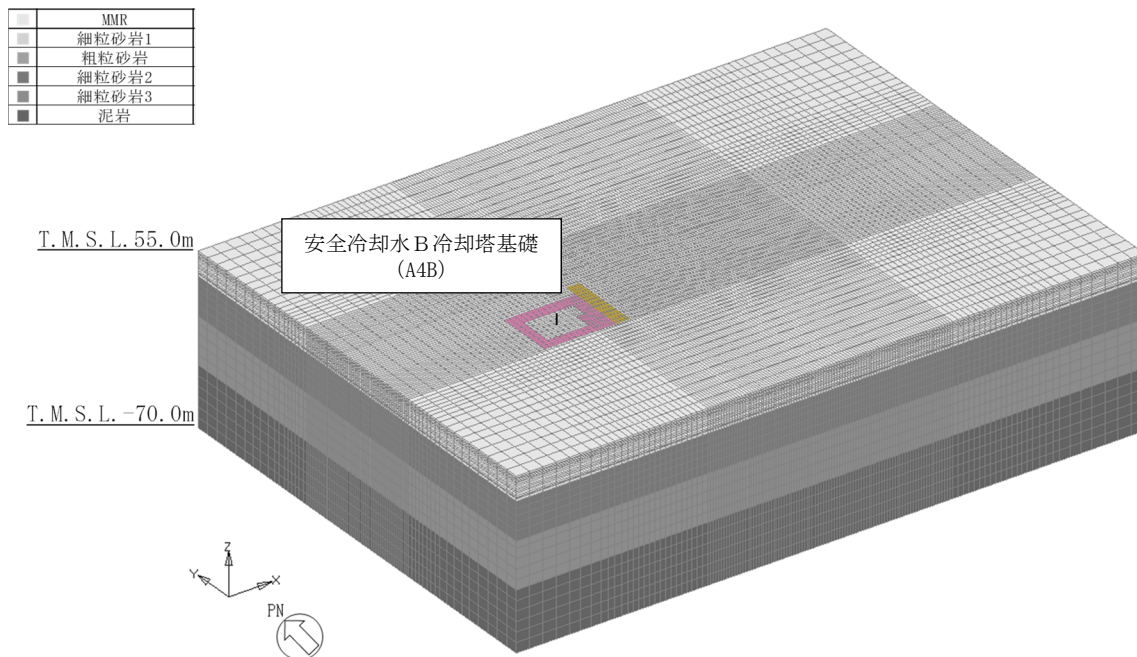

(a) 全体図

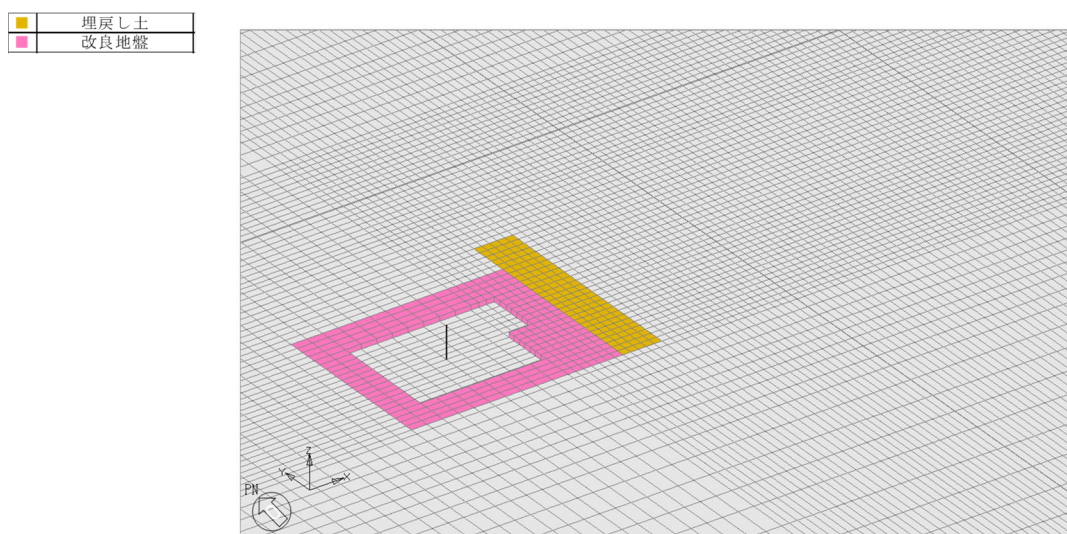

(b) 建屋周辺図

第2.1-2図 単独モデルの概要 (安全冷却水B冷却塔基礎)

2.2 建屋のモデル化

建屋モデルは、「IV-2-1 再処理設備本体等に係る耐震性に関する計算書」に示す解析モデルの諸元に倣うものとする。

飛来物防護ネットのモデルは、支持架構の固有振動数と安全冷却水B冷却塔基礎の固有振動数が大きく離れており、支持架構の振動が周辺地盤を介して安全冷却水B冷却塔基礎の応答に与える影響は小さいと考えられることから、総重量(支持架構+基礎)を集約した基礎部分を梁要素でモデル化する。また、杭基礎部分は、剛性の高い地盤改良体に設置されており、当該部分の地盤剛性に与える影響は軽微であると考えられるため考慮しない。

また、本検討の検討用地震動は、「2.5 検討用地震動及び検討用モデルへの入力方法」で後述するとおり弾性設計用地震動 S_d (S_d-A)であり、建屋はほぼ弾性状態と考えられることから、建屋モデル各部材の非線形特性は考慮しない。

各モデルは基礎の中心に各建屋モデルを配置する。

安全冷却水B冷却塔基礎の地震応答解析モデルの設定に用いた使用材料の物性値を第2.2-1表に、建屋モデル図を第2.2-1図に、解析諸元を第2.2-2表に示す。分析建屋の地震応答解析モデルの設定に用いた使用材料の物性値を第2.2-3表に、建屋モデル図を第2.2-2図に、解析諸元を第2.2-4表に示す。また、飛来物防護ネット基礎の解析諸元を第2.2-5表に示す。

第 2.2-1 表 安全冷却水 B 冷却塔基礎の使用材料の物性値

使用材料	ヤング係数 E (N/mm ²)	せん断 弾性係数 G (N/mm ²)	減衰定数 h (%)	備考
鉄筋コンクリート コンクリート : Fc=23.5 (N/mm ²) (Fc=240 (kgf/cm ²)) 鉄筋 : SD345	2.25 × 10 ⁴	9.38 × 10 ³	5	基礎
支持架構 鉄骨架構 : 基礎ボルト : 				冷却塔 (支持架構)

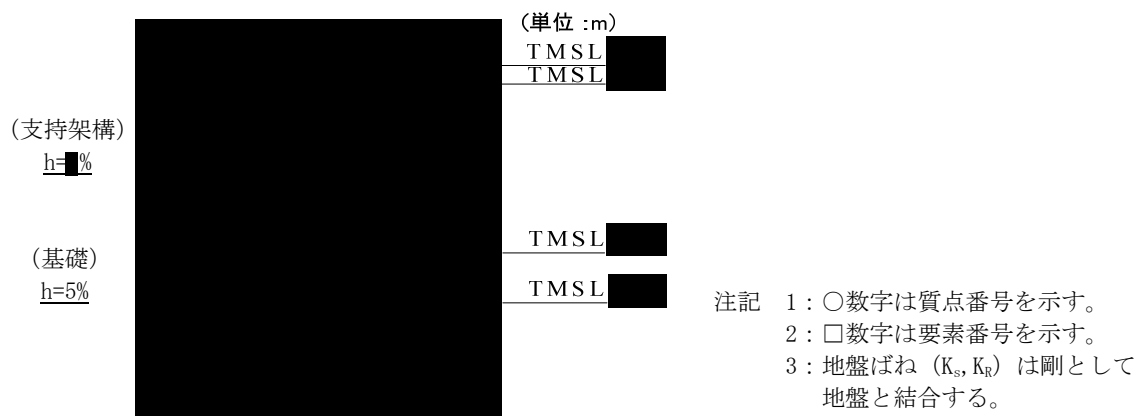

第 2.2-1 図 安全冷却水 B 冷却塔基礎の建屋モデル図

第 2.2-2 表 安全冷却水 B 冷却塔基礎の解析諸元

(a) NS 方向

質点番号	質点位置 T. M. S. L. (m)	重量 W (kN)	回転慣性 重量 I_g ($\times 10^6 \text{kN}\cdot\text{m}^2$)	要素 番号	要素位置 T. M. S. L. (m)	断面二次 モーメント I ($\times 10^4 \text{m}^4$)	せん断 断面積 A_s (m^2)
				—	—	—	—
	構築物総重量		—	—	—	—	—

(b) EW 方向

質点番号	質点位置 T. M. S. L. (m)	重量 W (kN)	回転慣性 重量 I_g ($\times 10^6 \text{kN}\cdot\text{m}^2$)	要素 番号	要素位置 T. M. S. L. (m)	断面二次 モーメント I ($\times 10^4 \text{m}^4$)	せん断 断面積 A_s (m^2)
				—	—	—	—
	構築物総重量		—	—	—	—	—

第 2. 2-3 表 分析建屋の使用材料の物性値

使用材料	ヤング係数 E (N/mm ²)	せん断 弾性係数 G (N/mm ²)	減衰定数 h (%)
コンクリート : Fc=29.4 (N/mm ²) (Fc=300kgf/cm ²) 鉄筋 : SD345	2.43 × 10 ⁴	1.01 × 10 ⁴	5

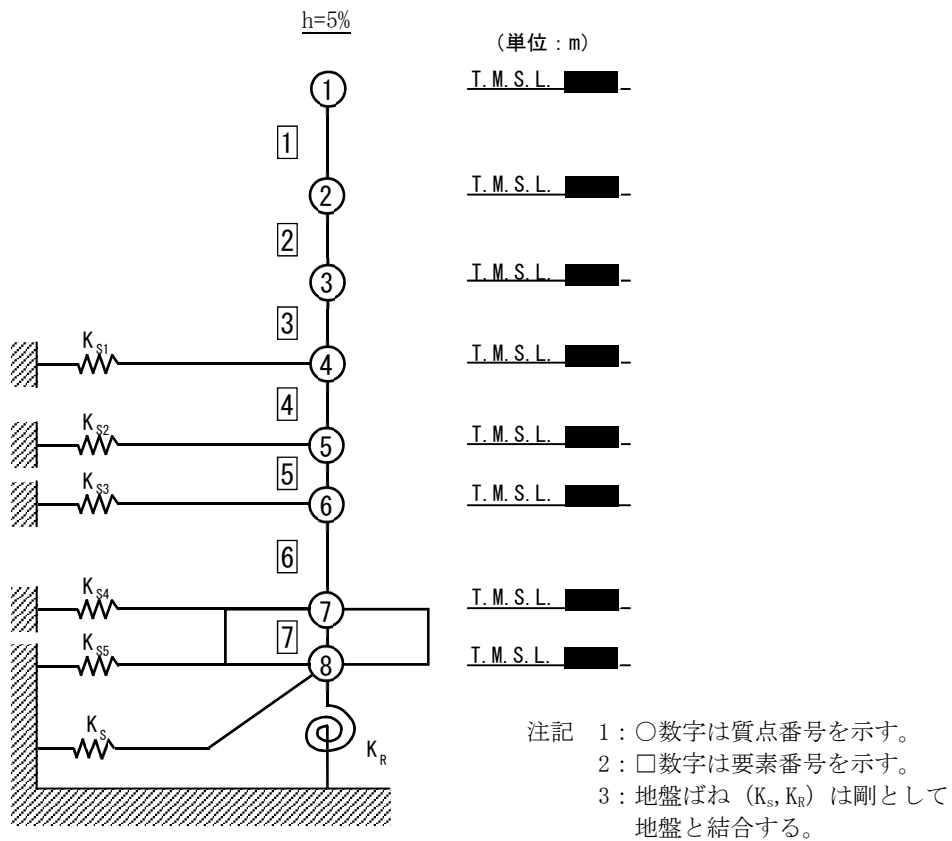

第 2. 2-2 図 分析建屋の建屋モデル図

第 2.2-4 表 分析建屋の解析諸元

(a) NS 方向

質点番号	質点位置 T. M. S. L. (m)	重量 W (kN)	回転慣性 重量 I_g ($\times 10^6 \text{kN}\cdot\text{m}^2$)	要素 番号	要素位置 T. M. S. L. (m)	断面二次 モーメント I ($\times 10^4 \text{m}^4$)	せん断 断面積 A_s (m^2)
①		31780	0.8	①		0.16	44.6
②		257330	45.2	②		4.43	204.9
③		182500	32.0	③		4.22	203.4
④		195400	34.3	④		4.42	215.5
⑤		164920	28.9	⑤		4.50	239.3
⑥		262360	46.1	⑥		4.52	243.4
⑦		240510	42.2	⑦		83.90	4791.3
⑧		162240	28.4	—	—	—	—
建屋総重量		1497040	—	—	—	—	—

(b) EW 方向

質点番号	質点位置 T. M. S. L. (m)	重量 W (kN)	回転慣性 重量 I_g ($\times 10^6 \text{kN}\cdot\text{m}^2$)	要素 番号	要素位置 T. M. S. L. (m)	断面二次 モーメント I ($\times 10^4 \text{m}^4$)	せん断 断面積 A_s (m^2)
①		31780	3.8	①		0.21	26.6
②		257330	234.3	②		44.54	404.9
③		182500	166.1	③		43.64	400.9
④		195400	177.9	④		44.01	407.1
⑤		164920	150.1	⑤		45.48	416.2
⑥		262360	238.9	⑥		47.40	428.7
⑦		240510	219.0	⑦		436.00	4791.3
⑧		162240	147.7	—	—	—	—
建屋総重量		1497040	—	—	—	—	—

第 2.2-5 表 飛来物防護ネット基礎の解析諸元

単位重量* W (kN/m)	基礎梁断面 B (mm) × D (mm)	減衰定数 h
233	3600 × 3000	0.05

注記 *：飛来物防護ネットの総重量（支持架構＋基礎：62990kN）と飛来物防護ネット基礎が位置する部分の総重量が等価となるように設定

2.3 地盤モデルの詳細

地盤モデルを第2.3-1図に示す。地盤はソリッド要素でモデル化し、平面的にはNS方向337.75m, EW方向471.95mの領域を、深さ方向はT.M.S.L. -70.0m（解放基盤表面）～T.M.S.L. 55.0m（地表面）の領域をモデル化する。深さ方向のメッシュサイズは、「原子力発電所耐震設計技術指針 JEAG 4601-1987（（社）日本電気協会）」に基づき、地盤のS波速度 V_s に対応する波長の1/5以下を目安として設定する。

地盤モデルは、「IV-2-1-1-1-1-1 安全冷却水B冷却塔基礎の地震応答計算書」と整合するよう構成される水平成層地盤とする。ただし、建屋周辺に分布する改良地盤及び埋戻し土を実態に即してモデル化することで、隣接建屋の影響をより精緻に評価する。なお、単独モデルでは、隣接モデルにおいて隣接建屋が埋め込まれていた部分を周辺の支配的な地盤であるMMR、細粒砂岩及び粗粒砂岩に置き換えた地盤モデルとする。

弾性設計用地震動Sd-Aにおける地盤物性を第2.3-1表～第2.3-3表に示す。地盤物性は、「IV-1-1-2 地盤の支持性能に係る基本方針」に基づき設定することとし、地盤のひずみ依存特性を考慮して求めた収束物性値を用いる。また、地盤の減衰はレーリー減衰とし、基準振動数は、「2.5 検討用地震動及び検討用モデルへの入力方法」で後述するように評価対象建屋の基礎底面及び地表面レベルにおける地盤の応答が1次元波動論に基づき算定した地盤の応答と等価となるように設定する。

地盤の境界条件は、底面粘性境界及び側方粘性境界とする。

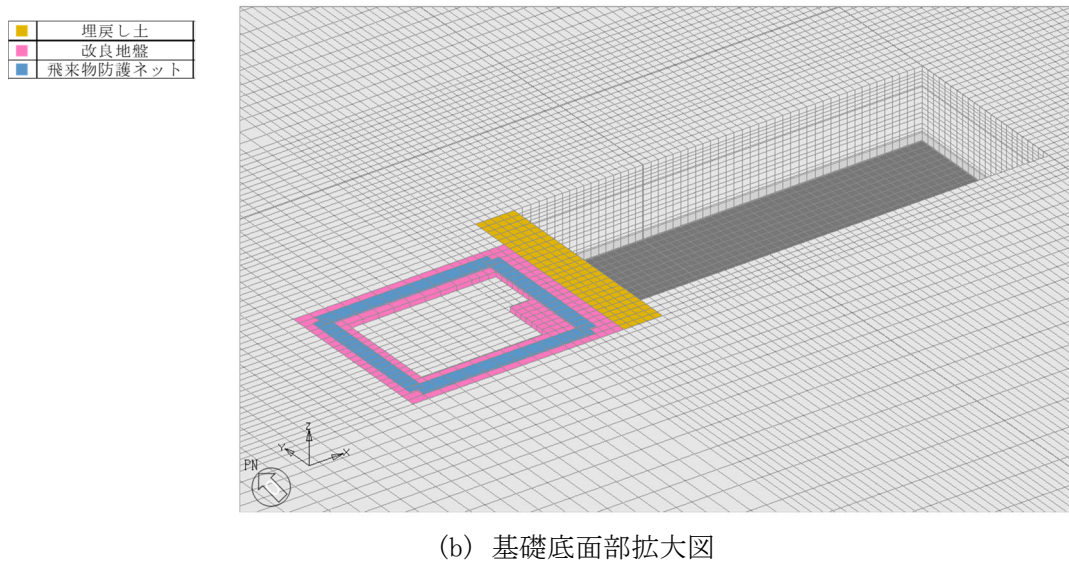
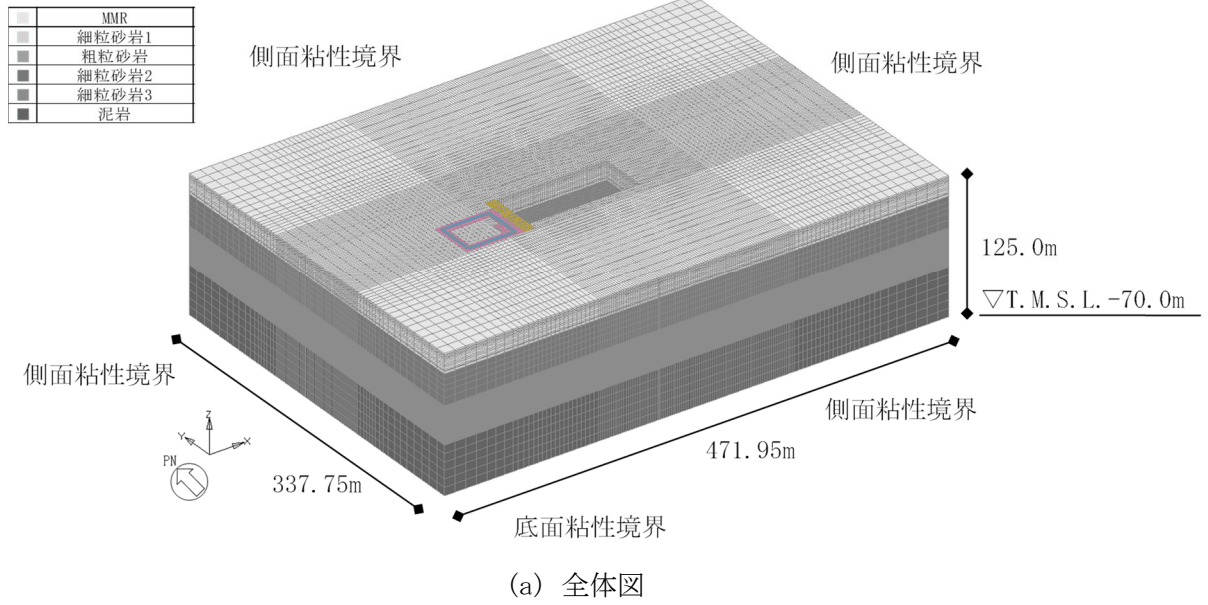

第2.3-1図 地盤モデル

第 2.3-1 表 地盤物性値 (S d - A)

標高 T. M. S. L. (m)	単位体積 重量 γ_t (kN/m ³)	S波速度 V_s (m/s)	P波速度 V_p (m/s)	減衰定数 h	レーリー減衰の 基準振動数 (Hz)	
					f1	f2
▽地表	55.00					
▽A4Bの基礎底面	53.80	18.3	674	1890	0.01	0.5 30
MMR	39.00					
細粒砂岩	37.08	18.3	671	1880	0.02	
粗粒砂岩		18.3	643	1800	0.02	
▽AHの基礎底面	36.82					
細粒砂岩	9.02	18.3	667	1870	0.02	
		18.1	925	2010	0.02	
泥岩 (下部層)	-25.57	16.9	783	1860	0.01	
▽解放基盤表面	-70.00					
		16.9	790	1880	0.01	

第 2.3-2 表 地盤物性値 (埋戻し土, S d - A)

標高 T. M. S. L. (m)	単位体積 重量 γ_t (kN/m ³)	S波速度 V_s (m/s)	P波速度 V_p (m/s)	減衰定数 h	レーリー減衰の 基準振動数 (Hz)	
					f1	f2
▽地表	55.00					
▽A4Bの基礎底面	53.80	17.8	177	418	0.03	0.5 30
	53.05	17.9	178	419	0.05	
	50.03	18.0	184	433	0.07	
	47.65	18.0	191	451	0.07	
埋戻し土	46.12	18.1	207	487	0.07	
	42.80	18.2	228	538	0.07	
	39.32	18.2	243	573	0.07	
	37.08	18.2	243	573	0.07	
▽AHの基礎底面	36.82	18.3	251	592	0.06	
細粒砂岩						

第 2.3-3 表 地盤物性値 (改良地盤, S d - A)

標高 T. M. S. L. (m)	単位体積 重量 γ_t (kN/m ³)	S波速度 V_s (m/s)	P波速度 V_p (m/s)	減衰定数 h	レーリー減衰の 基準振動数 (Hz)	
					f1	f2
▽地表	55.00					
▽A4Bの基礎底面	53.80	16.9	795	1580	0.001	0.5 30
	53.05		792	1570	0.003	
	50.03		788	1560	0.004	
	47.65		784	1560	0.005	
改良地盤	46.12		784	1560	0.006	
	42.80		781	1550	0.007	
	39.32		781	1550	0.008	
	37.08		781	1550	0.008	
▽AHの基礎底面	36.82		781	1550	0.008	
細粒砂岩						

2.4 建屋-地盤間の境界条件の詳細

第2.4-1図に建屋と地盤間の結合イメージを示す。

a. 基礎底面-底面地盤

構造物の基礎底面は剛体として考慮し、浮き上がりは考慮せず完全固着とし、基礎底面と支持地盤が同一に挙動するように結合する。

b. 建屋側面-側面地盤

建屋側面と側面地盤間については、建屋埋込み質点とそれと同じ高さの地盤節点（1FLの建屋質点は地表面）について、水平方向に対しては同一挙動するように結合し、鉛直方向は、建屋質点と地盤節点が独立して挙動する設定とする。

また、分析建屋における北側の一部分及び東側については、他の建屋が近接しており、地盤と接していないことから、当該部分については地盤節点と結合しない。

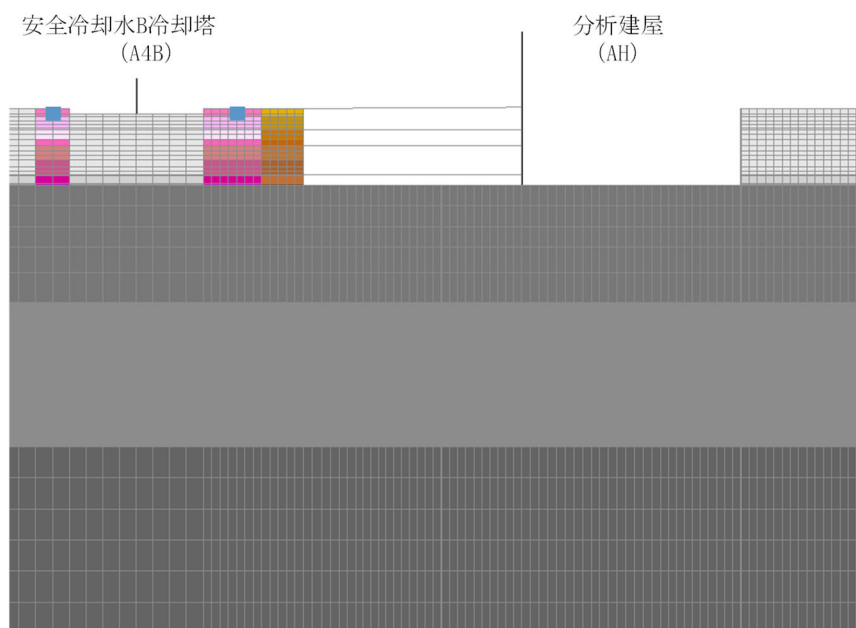

第2.4-1図 建屋と地盤間の結合イメージ

2.5 検討用地震動及び検討用モデルへの入力方法

本検討は、隣接建屋の影響程度の把握を主たる検討目的としていることから、材料の非線形特性による影響を受けないよう、地震応答解析は線形解析とする。検討用地震動は、「IV-1-1-1 基準地震動 S_s 及び弾性設計用地震動 S_d の概要」に示す解放基盤表面レベルで定義された弾性設計用地震動 S_d のうち、卓越周期に著しい偏りがなく、継続時間が長い S_d-A を用いる。 S_d-A の加速度時刻歴波形及び加速度応答スペクトルを第 2.5-1 図及び第 2.5-2 図に示す。

検討用モデルへの入力は第 2.5-3 図に示すように、評価対象建屋である安全冷却水 B 冷却塔基礎の基礎下位置における自由地盤の応答が、 S_d-A が入射した時の 1 次元波動論による応答計算と等価となるように地盤 3 次元 FEM モデルの底面に入力する*。なお、入力方向は、NS 方向及び EW 方向それぞれに対して行うこととする。

1 次元波動論による入力地震動の算定には、解析コード「REFLECT Ver. 2.0」を用いる。なお、解析コードの検証及び妥当性確認等の概要については、「IV-3 計算機プログラム（解析コード）の概要」に示す。

注記 *：評価対象建屋の基礎底面における地盤の応答が 1 次元波動論に基づき算定した地盤の応答と等価となるようにレーリー減衰の基準振動数を調整している。

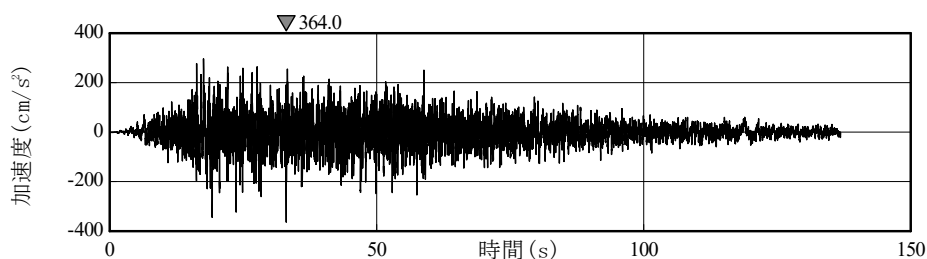

第 2.5-1 図 S_d-A の加速度波形

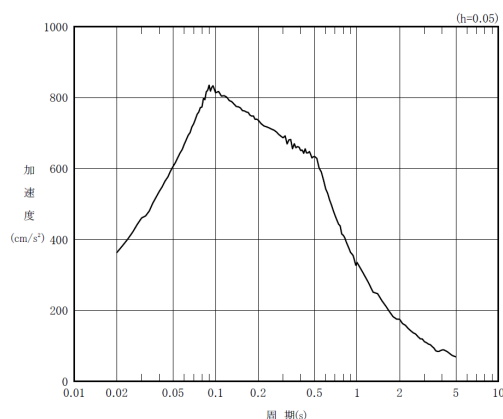

第 2.5-2 図 S_d-A の加速度応答スペクトル

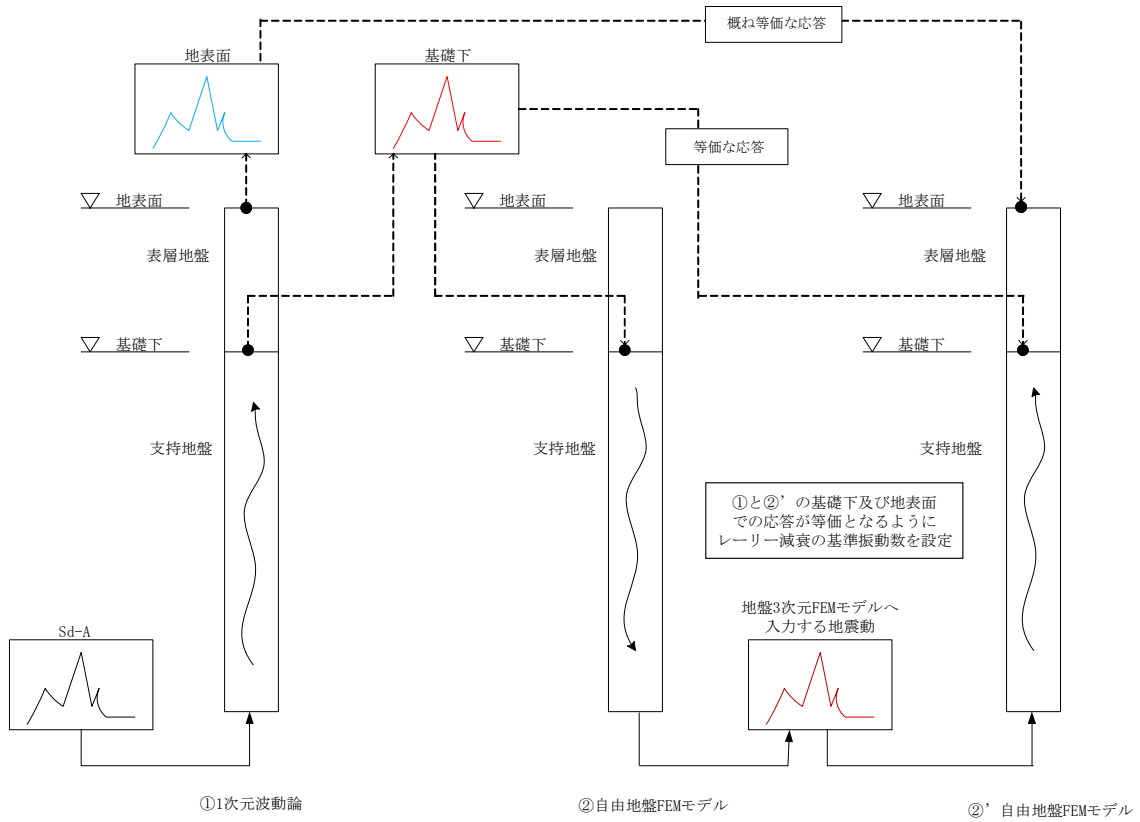

第 2.5-3 図 地盤 3DFEM モデルへ入力する地震動の概念図

2.6 地震応答解析結果

安全冷却水B冷却塔基礎の最大応答値を第 2.6-1 図～第 2.6-6 図及び第 2.6-1 表～第 2.6-6 表に示す。なお、応答比率は少数第 4 位を保守的に切上げた値を示す。

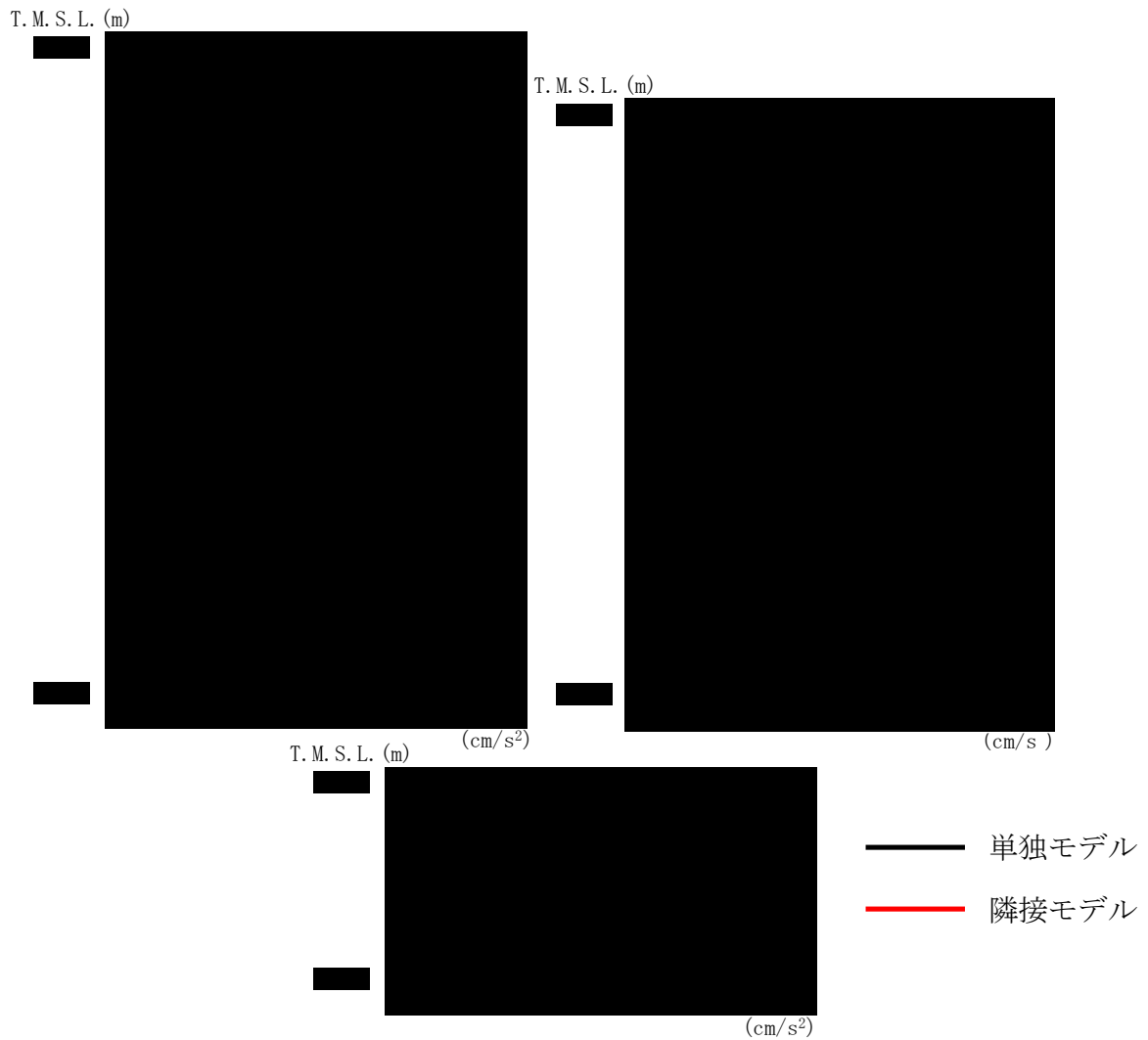

第2.6-1 図 安全冷却水B冷却塔基礎の最大応答加速度 (NS 方向)

第2.6-1 表 安全冷却水B冷却塔基礎の最大応答加速度一覧表 (NS 方向)

T. M. S. L. (m)	質点番号	最大応答加速度 (cm/s ²)		応答比率 (②/①)
		①単独モデル	②隣接モデル	
[Redacted Data]				

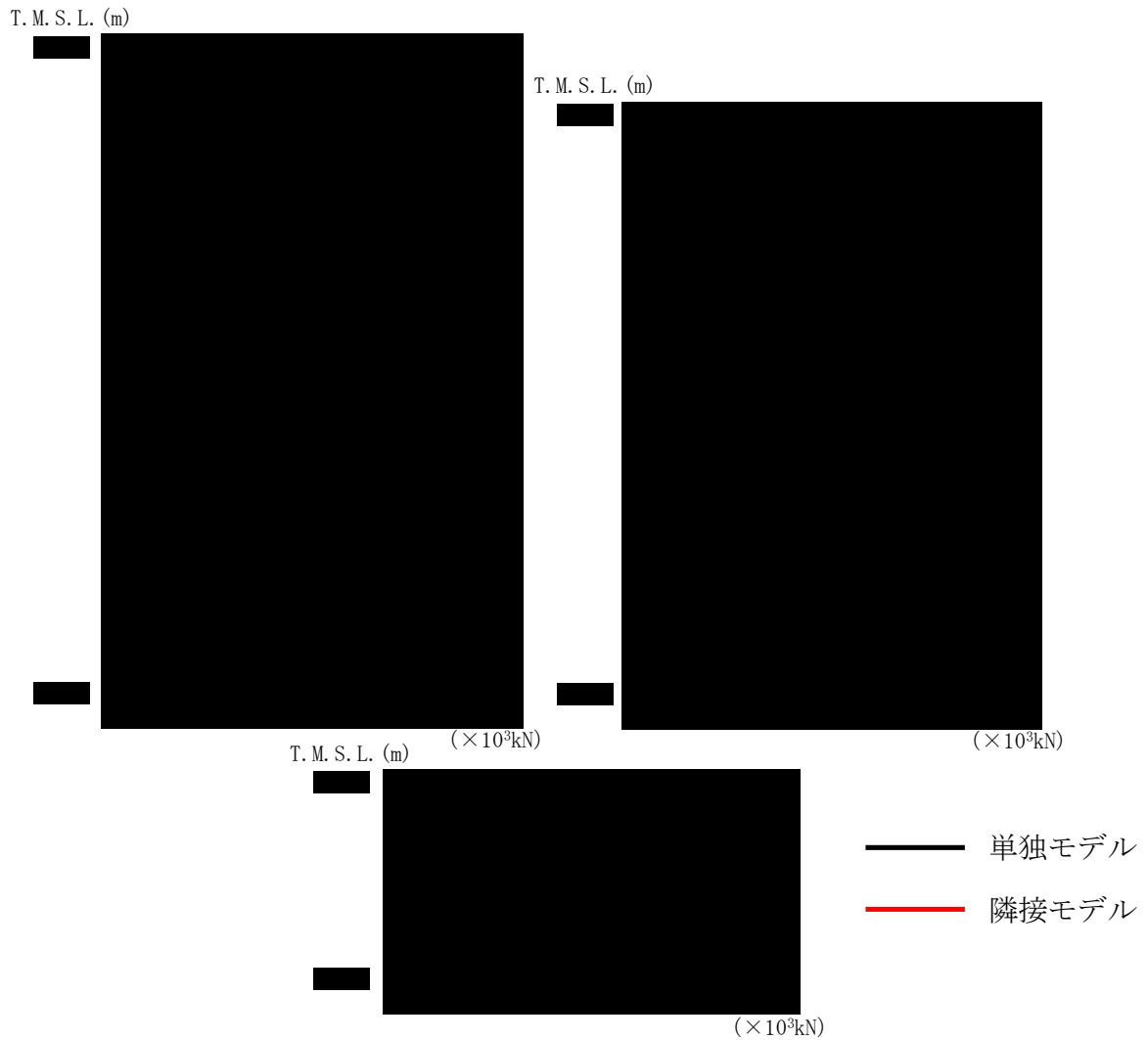

第2.6-2図 安全冷却水B冷却塔基礎の最大応答せん断力 (NS方向)

第2.6-2表 安全冷却水B冷却塔基礎の最大応答せん断力一覧表 (NS方向)

T.M.S.L. (m)	要素番号	最大応答せん断力(\times 10^3 kN)		応答比率 (②/①)
		①単独モデル	②隣接モデル	

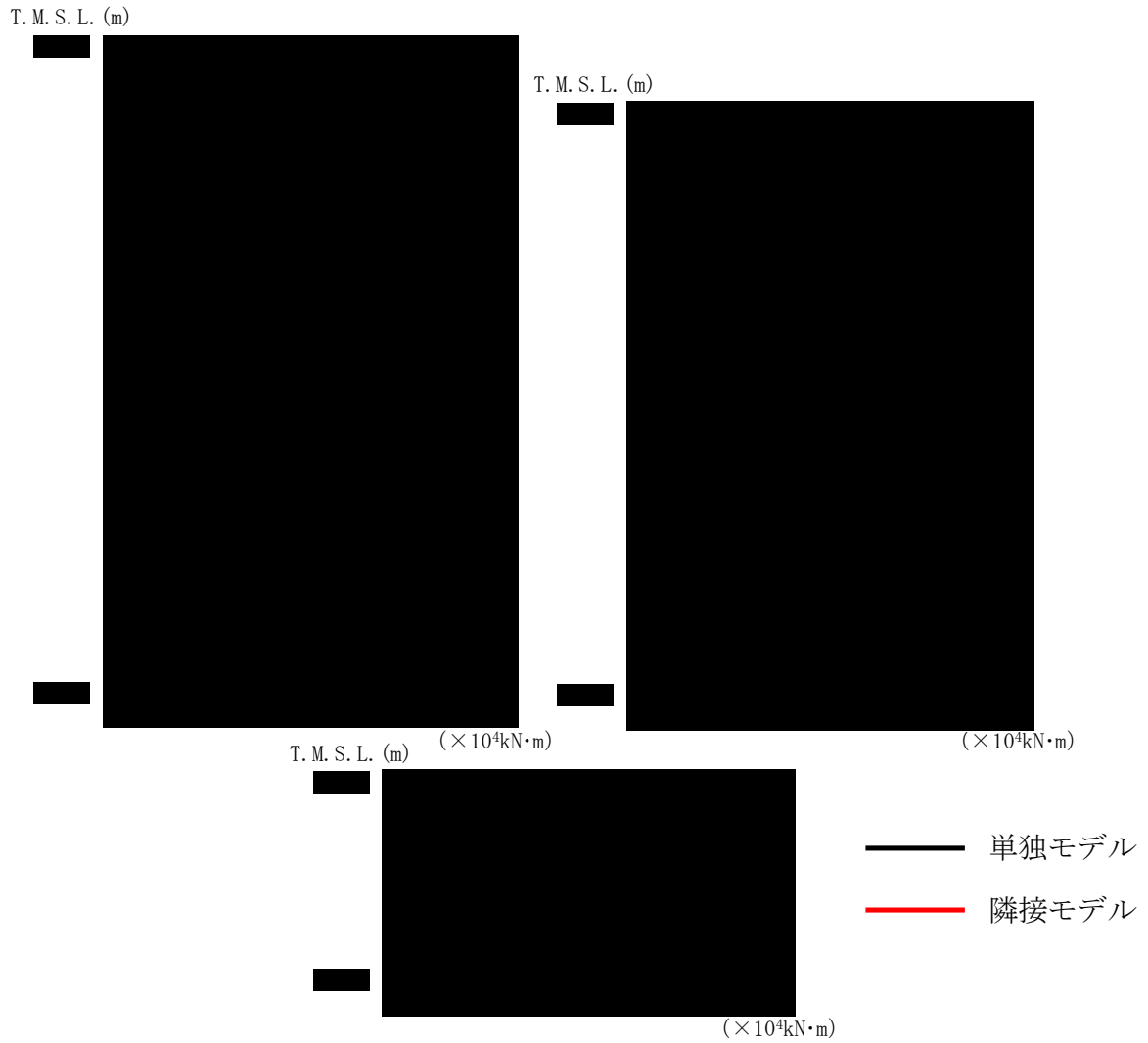

第2.6-3図 安全冷却水B冷却塔基礎の最大応答曲げモーメント (NS方向)

第2.6-3表 安全冷却水B冷却塔基礎の最大応答曲げモーメント一覧表 (NS方向)

T. M. S. L. (m)	要素番号	最大応答曲げモーメント (×10 ⁴ kN·m)		応答比率 (②/①)
		①単独モデル	②隣接モデル	

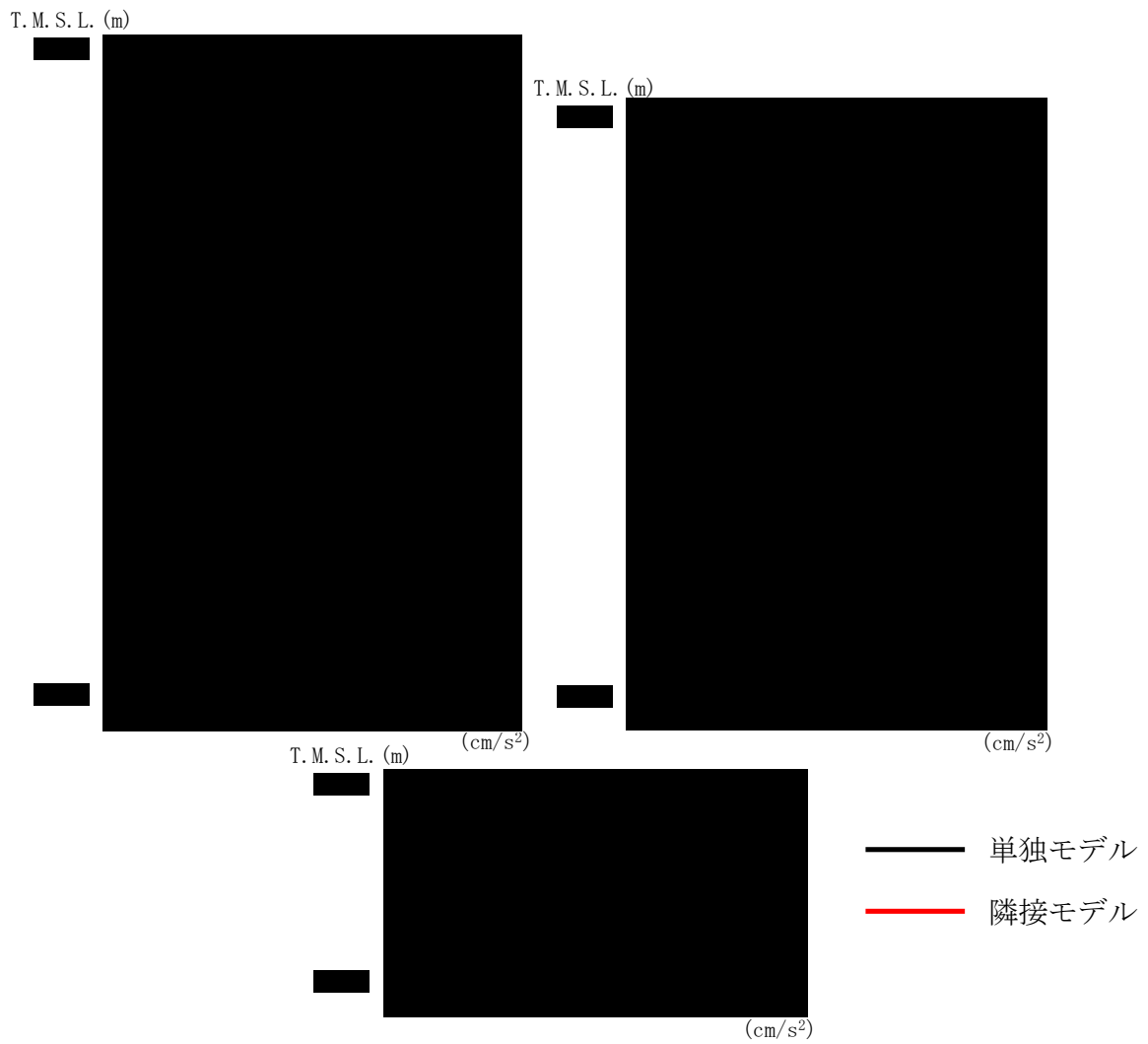

第2.6-4図 安全冷却水B冷却塔基礎の最大応答加速度 (EW方向)

第2.6-4表 安全冷却水B冷却塔基礎の最大応答加速度一覧表 (EW方向)

T. M. S. L. (m)	質点番号	最大応答加速度 (cm/s ²)		応答比率 (②/①)
		①単独モデル	②隣接モデル	

3. 建物・構築物の応答増幅の評価

「2.6 地震応答解析結果」で算定した隣接建屋を考慮した応答比率（割増係数）と、「IV-2-1-1-1-1-2 安全冷却水B冷却塔基礎の耐震計算書」の耐震評価結果より隣接建屋の影響評価を行う。

3.1 検討対象部位及び検討方法

3.1.1 検討対象部位

検討対象部位は、「IV-2-1-1-1-1-2 安全冷却水B冷却塔基礎の耐震計算書」において耐震評価を実施している部位のうち、水平方向の地震力の影響を受ける部位として、地盤（接地圧）及び基礎スラブとする。

3.1.2 地盤（接地圧）の検討方法

地盤（接地圧）の評価フローを第3.1.2-1図に示す。

地盤（接地圧）については、 S_s 地震時に対する評価として、水平地震力及び鉛直地震力の組合せにより算出していることから、基礎スラブ下端の最大応答曲げモーメントの応答比率を割増係数として設定し、割増係数が1.000を超える場合には、「IV-2-1-1-1-1-2 安全冷却水B冷却塔基礎の耐震計算書」に示す地盤物性のばらつきを考慮した最大接地圧の検定比に乗じて検定比が1.000を超えないことを確認する。

また、割増係数を乗じた検定比が1.000を超える場合には、詳細評価として、割増係数を考慮した地震荷重を用いた応力解析による評価を実施する。

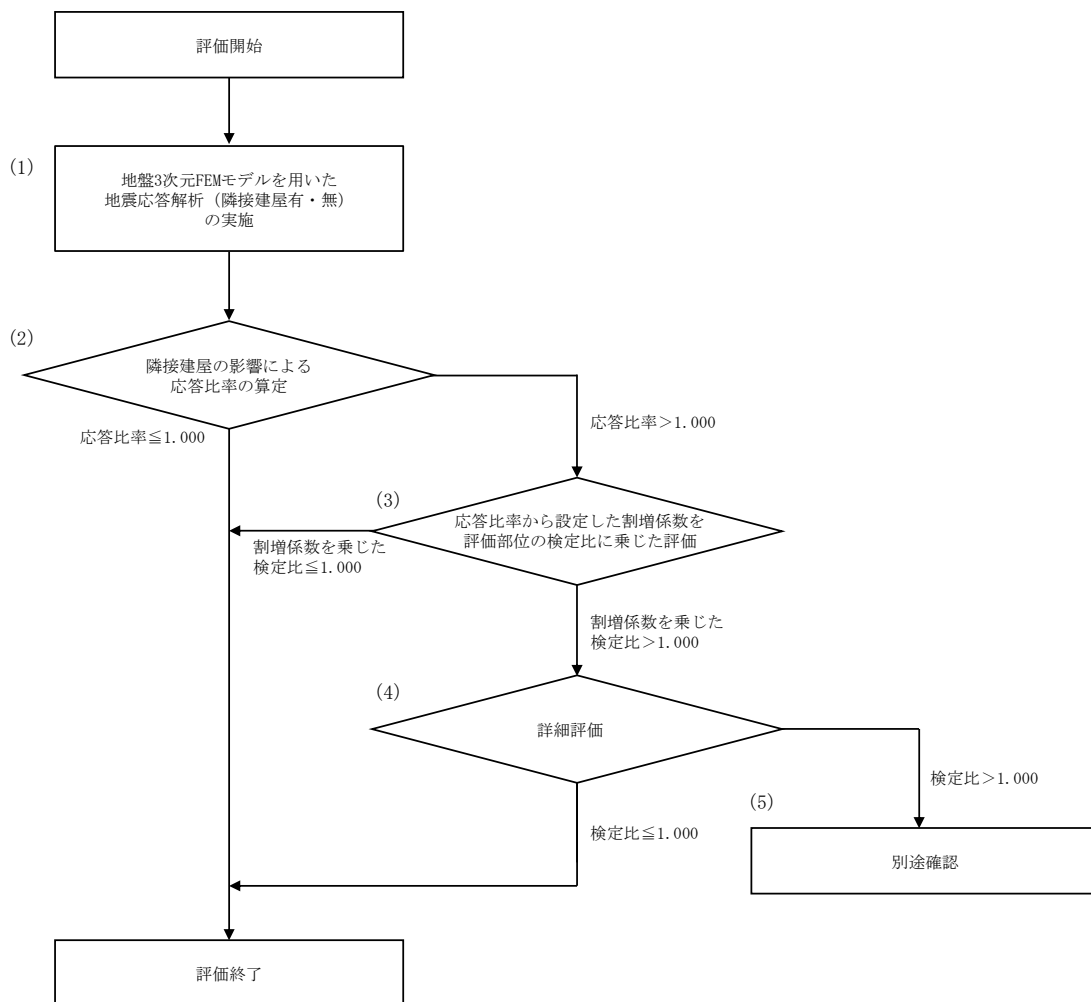

第3.1.2-1図 地盤（接地圧）の評価フロー

3.1.3 基礎スラブの検討方法

基礎スラブの評価フローは、第 3.1.2-1 図に示す地盤（接地圧）の評価フローと同様とする。

基礎スラブに対する評価には、上部構造から伝わる基礎スラブへの地震時反力を地震荷重として考慮することから、基礎スラブ直上の部材における応答比率を割増係数として設定し、割増係数が 1.000 を超える場合には、「IV-2-1-1-1-1-2 安全冷却水 B 冷却塔基礎の耐震計算書」に示す地盤物性のばらつきを考慮した評価結果の検定比に乗じて検定比が 1.000 を超えないことを確認する。この際、割増係数にはせん断力及び曲げモーメントのうち大きい方の応答比率を用いる。

3.2 検討結果

水平方向の地震力の影響を受ける評価対象部位について、以下のとおり隣接建屋の影響評価を示す。

(1) 地盤（接地圧）

地盤（接地圧）については、水平方向の地震荷重として曲げモーメントを考慮することから、基礎下端における最大応答曲げモーメントの応答比率の最大値を割増係数として設定する。第 3.2-1 表に応答比率及び割増係数を示す。

第 3.2-1 表より、EW 方向は割増係数は■■■■であることから、地盤（接地圧）の評価に及ぼす影響がないことを確認した。NS 方向は割増係数が■■■■と 1.000 を超えることから、割増係数を乗じた評価結果を第 3.2-2 表に示す。第 3.2-2 表より、NS 方向について耐震計算書に示す評価結果の検定比に割増係数を乗じた場合においても、検定比は最大で■■■■であり、検定比が 1.000 を超えないことを確認した。

(2) 基礎スラブ

基礎スラブは、水平方向の地震荷重として上部構造から基礎への曲げモーメント及びせん断力を考慮することから、基礎スラブ直上の部材における最大応答せん断力及び最大応答曲げモーメントの応答比率の最大値を割増係数として設定する。第 3.2-3 表に応答比率及び割増係数を示す。

第 3.2-3 表より、割増係数が■■■■と 1.000 を超えることから、割増係数を乗じた評価結果を第 3.2-4 表に示す。第 3.2-4 表より、耐震計算書に示す評価結果の検定比に割増係数を乗じた場合においても、検定比は最大で■■■■であり、検定比が 1.000 を超えないことを確認した。

第 3. 2-1 表 基礎下端における最大応答曲げモーメント
の応答比率及び割増係数（地盤（接地圧））

方向	T. M. S. L. (m)	要素 番号	最大応答曲げモーメント ($\times 10^4 \text{kN} \cdot \text{m}$) *1		応答比率*2 (②/①)	割増 係数*3	割増係数を 乗じた評価 の可否
			①単独 モデル	②隣接 モデル			
NS							要
EW							不要

注記 *1：網掛けは最大値を示す

*2：小数第4位を保守的に切上げ

*3：応答比率が1.000を超えない場合は1.000とする

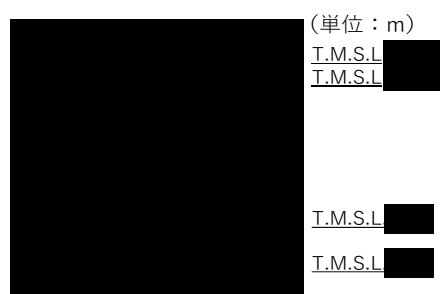

注記 1：○数字は質点番号を示す

2：□数字は要素番号を示す

3：破線囲みは該当する要素番号を示す

第 3. 2-2 表 接地圧の評価結果（基準地震動 S_s ）*1

方向	最大接地圧 (kN/m^2)	極限支持力度 (kN/m^2)	① 検定比*2*3	② 割増係数	①×② 検定比*3	判定
NS						OK

注記 *1：地盤物性のばらつきを考慮した結果

*2：①検定比 = (最大接地圧) / (極限支持力度)

*3：有効数字3桁表記（4桁目を保守的に切り上げ）

第3.2-3表 基礎スラブ直上の最大応答せん断力及び最大応答曲げモーメント
の応答比率及び割増係数（基礎スラブ）

方向	T. M. S. L. (m)	要素 番号	応力	①単独 モデル	②隣接 モデル	応答 比率* ² (②/①)	割増 係数* ³	割増係数 を乗じた 評価の 要否
NS								-
								-
								-
								-
EW								-
								-
								-
								-
割増係数（最大値）* ⁴								要

- 注記 *1：網掛けは最大値を示す
 *2：小数第4位を保守的に切上げ
 *3：応答比率が1.000を超えない場合は1.000とする
 *4：NS方向及びEW方向の包絡値を割増係数として設定する

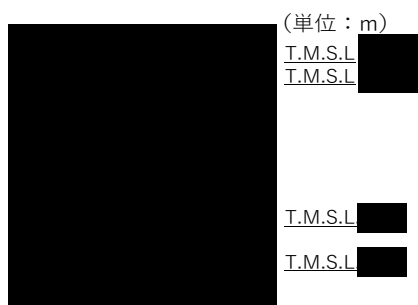

- 注記 1：○数字は質点番号を示す
 2：□数字は要素番号を示す
 3：破線囲みは該当する要素番号を示す

第 3.2-4 表 基礎スラブの評価結果（基準地震動 S s）

(1) 軸力及び曲げモーメントに対する評価*1

方向	要素 番号	荷重組合せ ケース (水平加力方向)	発生曲げ モーメント (kN・m/m)	許容値 (kN・m/m) *2	① 検定比 *3*4	② 割増係数	①×② 検定比 *4	判定
NS								OK
EW								OK

注記 *1：地盤物性のばらつきを考慮した結果

*2：許容値は曲げ終局強度を示す

*3：①検定比＝（発生曲げモーメント） / （許容値）

*4：有効数字 3 桁表記（4 桁目を保守的に切り上げ）

(2) 面外せん断力に対する評価*1

方向	要素 番号	荷重組合せ ケース (水平加力方向)	発生面外 せん断力 (kN/m)	許容値 (kN/m) *2	① 検定比 *3*4	② 割増係数	①×② 検定比 *4	判定
NS								OK
EW								OK

注記 *1：地盤物性のばらつきを考慮した結果

*2：許容値は面外せん断終局強度を示す

*3：①検定比＝（発生面外せん断力） / （許容値）

*4：有効数字 3 桁表記（4 桁目を保守的に切り上げ）

別紙4-29

隣接建屋に関する影響評価結果 建物・構築物 竜巻防護対策設備

本添付書類は、別で定める方針に沿った評価・計算を示す書類であり、結果を示すものであることから、発電炉との比較は行わない。
安全冷却水B冷却塔飛来物防護ネットの周辺建造物の影響について補足にて説明している。

別紙4-30

隣接建屋に関する影響評価結果 機器・配管系

本添付書類は、別で定める方針に沿った評価・計算を示す書類であり、結果を示すものであることから、発電炉との比較は行わない。
また、図書番号や数値は最終精査中。

注) 本資料は、「IV-2 再処理施設の耐震性に関する計算書」(以下、「耐震計算書」という。)に示している計算結果を用いて影響評価結果を示しているため、以下の関連する補足説明資料の内容を踏まえて記載内容を見直し。

- ・補足説明資料「[補足耐 20] 耐震機電 09 耐震性設計の基本方針に係る耐震 S クラス設備の耐震計算書における S d 評価結果の記載方法」において、基準地震動 S s の発生応力が弾性設計用地震動 S d の許容応力以下となる設備に対する耐震計算書の記載方法として、弾性設計用地震動 S d の発生応力の記載を省略することを示している。そのため、本資料で示す影響評価結果のうち弾性設計用地震動 S d の発生応力の記載を省略している設備については、基準地震動 S s に対する影響評価結果を示すこととする。
- ・補足説明資料「[補足耐 40] 耐震機電 16 配管系の評価手法(定ピッチスパン法)について」において、定ピッチスパン法は設工認上で示している設計方針であり、実施工配管が標準支持間隔に対して保守性を有している設計手法であることを示している。そのため、本資料で示す配管の影響評価結果については、多質点解析の評価を実施している配管に対する影響評価結果を示す。

目 次

1. 概要	1
2. 影響評価方針	1
3. 影響評価内容	1
3.1 隣接影響地震力の算定	1
3.2 隣接影響地震力による影響評価	3
4. 影響評価結果	4

別紙1 安全冷却水B冷却塔

1. 概要

本資料は、「IV-2-4-2-1 建物・構築物」にて示している隣接建屋の影響を考慮した地震応答解析の結果を踏まえ、機器・配管系の耐震安全性への影響について説明するものである。

2. 影響評価方針

隣接建屋の影響評価の方針として、「IV-2-1 再処理設備本体等に係る耐震性に関する計算書」（以下「耐震計算書」という。）に示している設備の耐震評価結果の算出に用いた地震力については、複数ある基準地震動 S_s 若しくは弾性設計用地震動 S_d の建屋応答から添付書類「IV-1-1-6 設計用床応答曲線の作成方針」に基づき作成した設計用床応答曲線 (FRS) 又は最大床応答加速度 (ZPA) による地震力 (以下「設計用地震力」という。) を用いて評価を行っている。

これに対する隣接建屋の影響評価の方法としては、耐震計算書に示している耐震安全性に影響を与えないことの確認として、設計用地震力と隣接建屋の影響を考慮した地震力 (以下「隣接影響地震力」という。) の比較により行う。

3. 影響評価内容

3.1 隣接影響地震力の算定方法

隣接影響地震力の算定については、「IV-2-4-2-1 建物・構築物」にて示している隣接モデル及び単独モデルの地震応答解析の結果から作成した床応答曲線を用いて、以下の方法により作成する。

- (1) 隣接モデル及び単独モデルの床応答曲線を作成し、周期ごとに加速度の比較を行い加速度比率の算定を行う。
- (2) 設計用地震力の水平方向の床応答曲線に対して、(1)の加速度比率を周期ごとに乗じて隣接影響地震力の床応答曲線を作成。

なお、剛な設備においては、上記同様に設計用地震力の最大床応答加速度に隣接モデル及び単独モデルの最大床応答加速度から得られた加速度比率を乗じて求められる隣接影響地震力の最大床応答加速度の算定を行う。

隣接建屋の影響を考慮した加速度比率を乗算して算定する隣接影響地震力の作成例について第 3.1-1 図に示す。

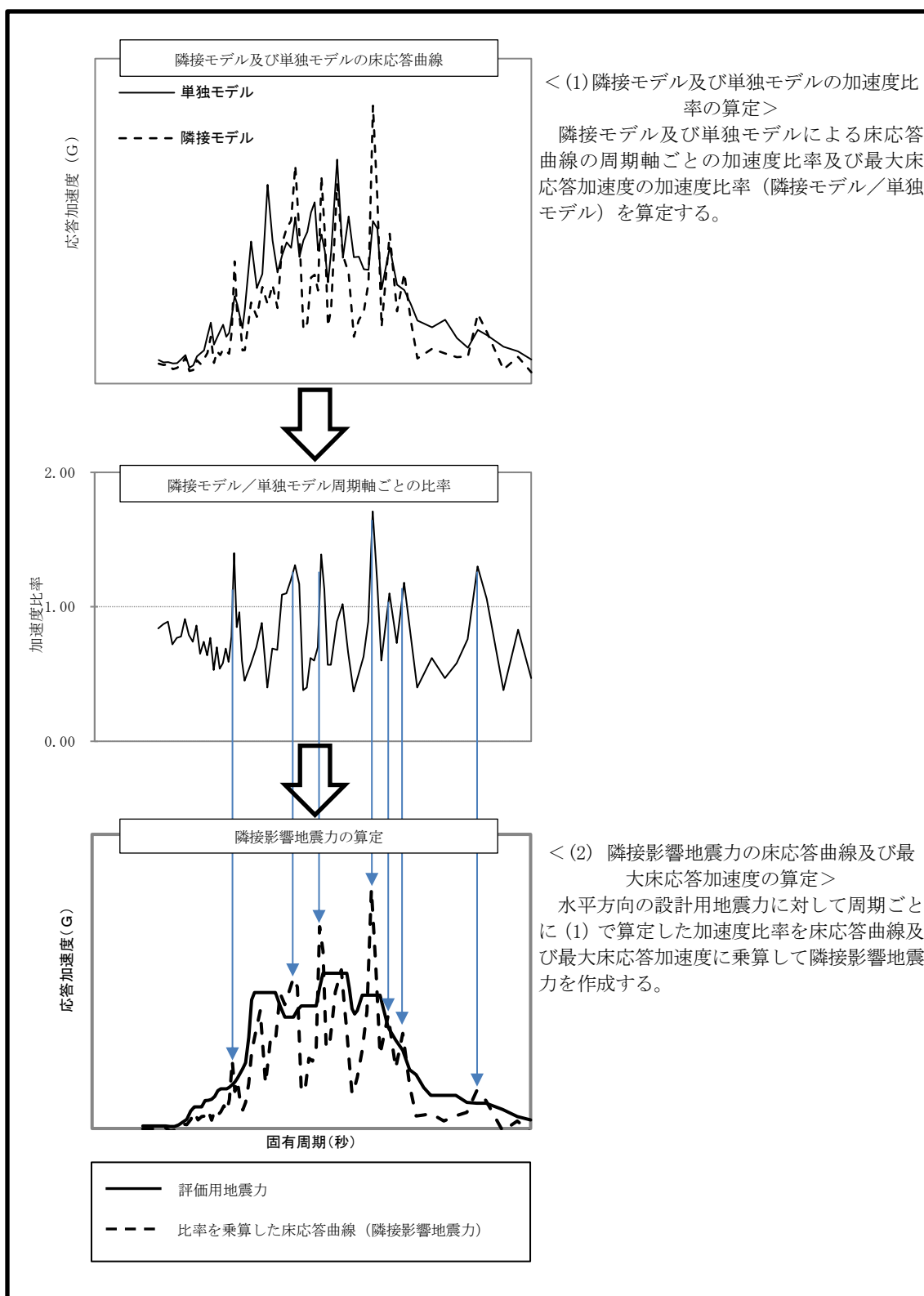

第 3.1-1 図 隣接建屋の影響を考慮した加速度比率を乗算して算定する隣接影響地震力の作成例

3.2 隣接影響地震力による影響評価

設計用地震力と隣接影響地震力の比較による影響評価の内容としては、設計用地震力と隣接影響地震力の重ね合わせを行い、設計用地震力に対して隣接影響地震力が超過する場合は、超過する周期帯（以下「超過周期帯」という。）に固有周期を有する設備を特定し、超過周期帯の最大加速度比と耐震計算書の評価結果の耐震裕度を用いて耐震安全性に影響がないことを確認する。

剛な設備においては、設計用地震力と隣接影響地震力の最大床応答加速度の加速度比較を行い、超過する場合には加速度比と耐震計算書の評価結果の耐震裕度を用いて耐震安全性に影響がないことを確認する。

なお、時刻歴応答波を用いて評価を実施している設備については次回以降に詳細を説明する。

隣接建屋の影響を考慮した影響評価対応フローを第 3.2-1 図に示す。

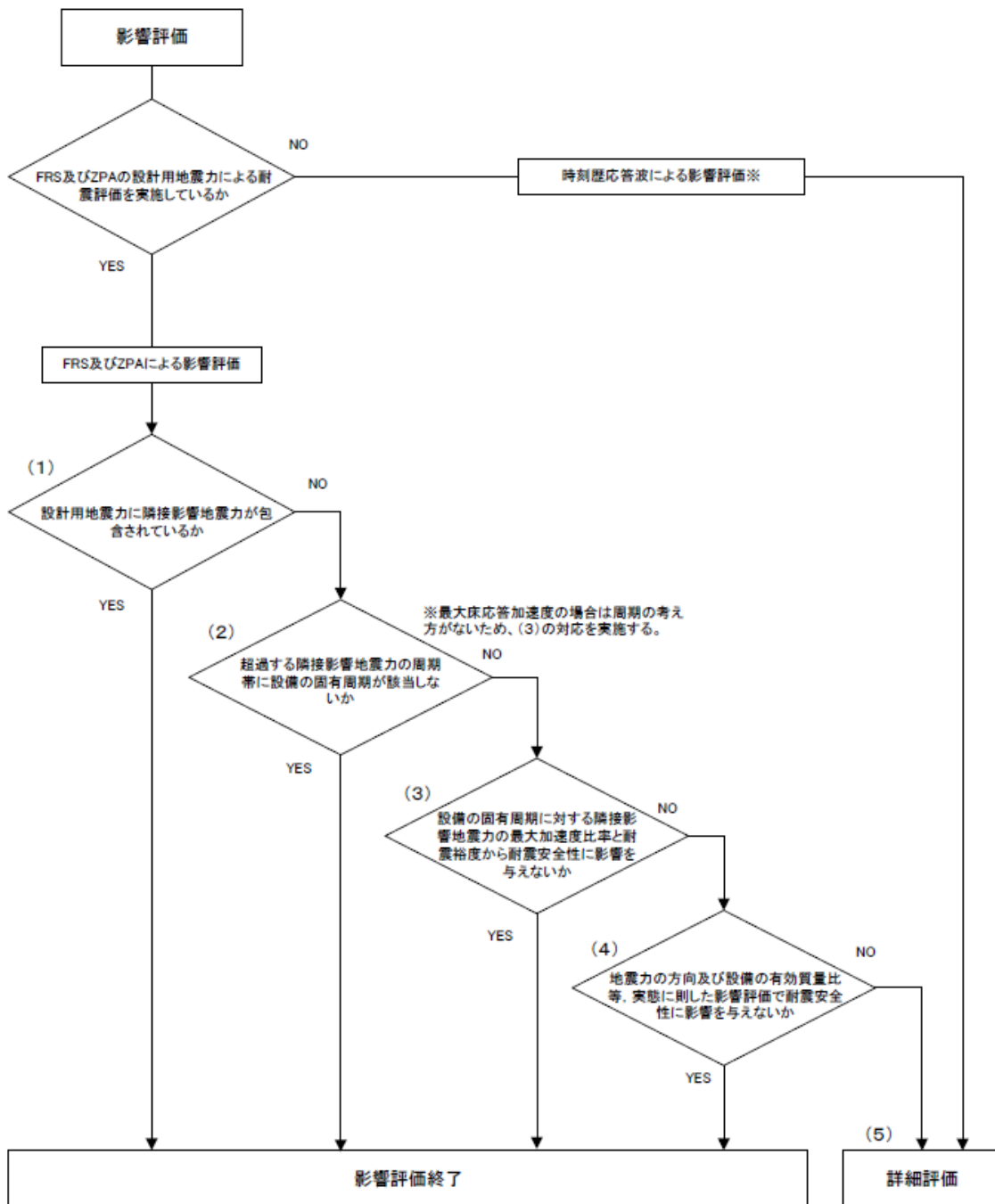

第 3.2-1 図 隣接建屋の影響を考慮した影響評価対応フロー

4. 影響評価結果

影響評価方針に基づく隣接影響地震力との比較による耐震安全性への影響確認結果を別紙に示す。

IV-2-4-2-2-1 別紙 1

安全冷却水 B 冷却塔

隣接建屋の影響を考慮した地震力に対する影響評価結果

IV-2 再処理施設の耐震性に関する計算書					確認結果*1								
添付書類番号	添付書類名称		発生応力 (MPa) *2	許容応力 (MPa)	1次固有周 期(s)	簡易評価				(5) 詳細評価			
						(1)	(2)	(3)		(4)		発生応力 (MPa)	応力比
								発生応力 (MPa)	応力比	発生応力 (MPa)	応力比		
IV-2-1-2-1-1-1 *3	安全冷却水B冷 却塔の耐震計算 書	支持架構				-	-						
		支持架構搭載 機器				-	-						
IV-1-1-11-1-1 別紙1	安全機能を有する施設の直管部標 準支持間隔*4												

- *1: 「IV-2-4-2-2-1 機器・配管系の隣接建屋に関する影響評価結果」の「3.2 隣接建屋の影響を考慮した地震力による影響評価 第3.2-1図」において、「YES」となった結果を「○」又は数値で示す。
- *2: 「IV-2 再処理施設の耐震性に関する計算書」に示す機器・配管系の各計算書において最大応力比となった評価部位に対する計算結果を示す。
- *3: IV-2-1-2-1-1-1 安全冷却水B冷却塔の耐震計算書に示す評価結果のうち、固有周期の異なる支持架構（基礎ボルト含む）及び支持架構搭載機器（伝熱管含む）について、最大応力比の評価部位に対して影響確認結果を示す。
- *4: 直管部標準支持間隔については、最大応力比の支持間隔に対して標準支持間隔の最長固有周期までの最大の加速度比率を用いた影響確認結果を示す。

別紙4－31

計算機プログラム（解析コード） の概要

本添付書類は、別で定める方針に沿った解析コードの概要を示すものであることから、発電炉との比較は行わない。

目 次

	ページ
1. はじめに	1
建物・構築物	
機器・配管系	

1. はじめに

本資料は、「IV 再処理施設の耐震性に関する説明書」において使用した解析コードについて説明するものである。

「IV 再処理施設の耐震性に関する説明書」において使用した解析コードの使用状況一覧、解析コードの概要を以降に記載する。

建物・構築物

目 次

	ページ
別紙 1 MSC NASTRAN	1-1
別紙 2 REFLECT	2-1
別紙 3 TDAPⅢ	3-1
別紙 4 VA	4-1
別紙 5 FLIP	5-1
別紙 6 midas iGen	6-1
別紙 7 NAPISOS	7-1

別紙1 MSC NASTRAN

1. 使用状況一覧

使用添付書類		バージョン
IV-2-1-1 -1-1-2	安全冷却水B冷却塔基礎の耐震計算書	Ver. 2013. 1. 0
IV-2-3-1 -1-1 別紙 1	安全冷却水B冷却塔基礎の水平 2 方向及び鉛直方向 地震力の組合せに関する影響評価結果	Ver. 2013. 1. 0

2. 解析コードの概要

項目 \ コード名	MSC NASTRAN
開発機関	The MacNeal-Schwendler Corporation (現 MSC Software Corporation)
開発時期	1971年 (一般商用リリース)
使用したバージョン	Ver. 2013.1.0
使用目的	弾性応力解析
コードの概要	<p>MSC NASTRAN (以下、「本解析コード」という。)は、航空機の機体強度解析用として開発された有限要素法による汎用解析計算機コードであり、航空宇宙、自動車、造船、機械、土木及び建築などの様々な分野における使用実績を有している。</p> <p>動的解析、静的解析、熱伝導解析等の機能を有し、固有振動数、刺激係数及び応力等の算定が可能である。</p>
検証 (Verification) 及び 妥当性確認 (Validation)	<p>【検証(Verification)】 本解析コードの検証の内容は以下のとおりである。</p> <ul style="list-style-type: none"> 弾性応力解析について、本解析コードによるはり要素、シェル要素及びソリッド要素を用いた静的解析結果と理論モデルによる理論解の比較を行い、解析解が理論解と一致することを確認している。 動作環境を満足する計算機にインストールして用いていることを確認している。 <p>【妥当性確認(Validation)】 本解析コードの妥当性確認の内容は以下のとおりである。</p> <ul style="list-style-type: none"> 関西電力株式会社高浜3号機の工事計画認可申請において、本申請と同じ使用目的での実績を有することを確認している。 本申請において使用するバージョンは、上記の先行施設にて使用しているもの (Ver. 2012.1.0) と異なるが、バージョンアップに伴う変更点は、今回の解析に使用していない解析機能の拡張として材料の追加や計算パフォーマンスの向上などに関するものであり、今回の解析結果に影響を及ぼさないことを確認している。 上述の検証の内容のとおり、本申請における使用目的と整合した検証として、弾性応力解析に対して本解析コードと理論解との比較を実施し、本解析コードが理論解と同等の解を与えることを確認していることから、本解析コードを本申請における弾性応力解析に使用することは妥当である。

別紙2 REFLECT

1. 使用状況一覧

使用添付書類		バージョン
IV-2-1-1 -1-1-1	安全冷却水B冷却塔基礎の地震応答計算書	Ver. 2.0

2. 解析コードの概要

項目 \ コード名	REFLECT
開発機関	大成建設株式会社
開発時期	1986 年
使用したバージョン	Ver. 2.0
使用目的	1次元波動論に基づく入力地震動の策定
コードの概要	<p>REFLECT (以下, 「本解析コード」という。) は, 米国カリフォルニア大学から発表された SHAKE を基本に開発されたもので, 1次元重複反射理論に基づく地盤の伝達関数や時刻歴応答波形を算出するプログラムである。</p> <p>日本国内の原子力関連施設等での多くの利用実績がある。</p>
検証 (Verification) 及び 妥当性確認 (Validation)	<p>【検証(Verification)】 本解析コードの検証の内容は以下のとおりである。</p> <ul style="list-style-type: none"> ・本解析コードによる弾性地盤の増幅特性の解析結果と理論モデルによる理論解を比較し, 解析結果と理論解が一致することを確認している。 ・動作環境を満足する計算機にインストールして用いていることを確認している。 <p>【妥当性確認(Validation)】 本解析コードの妥当性確認の内容は以下のとおりである。</p> <ul style="list-style-type: none"> ・九州電力株式会社川内 1 号機の工事計画認可申請において, 本申請と同じ使用目的での実績を有することを確認している。 ・本申請において使用するバージョンは, 上記の先行施設にて使用しているものと同じであることを確認している。 ・上述の検証の内容のとおり, 本申請における使用目的と整合した検証として, 弾性地盤の増幅特性に対して本解析コードと理論解との比較を実施し, 本解析コードが理論解と同等の解を与えることを確認していることから, 本解析コードを本申請における 1次元波動論に基づく入力地震動の策定に使用することは妥当である。

別紙3 TDAPⅢ

1. 使用状況一覧

使用添付書類		バージョン
IV-2-1-1 -1-1-1	安全冷却水B冷却塔基礎の地震応答計算書	Ver. 3.07
IV-2-2-2 -1-2-1- 2	飛来物防護ネット(再処理設備本体用 安全冷却水系冷却塔B)の耐震計算書	Ver. 3.07
IV-2-3-1 -3-1 別紙 1	飛来物防護ネット(再処理設備本体用 安全冷却水系冷却塔B)の水平2方向及び鉛直方向地震力の組合せに関する影響評価結果	Ver. 3.07

2. 解析コードの概要

項目	コード名 TDAPⅢ
開発機関	大成建設株式会社, 株式会社アーク情報システム
開発時期	1980年代後半
使用したバージョン	Ver. 3.07
使用目的	固有値解析, 地震応答解析, 弾性応力解析
コードの概要	<p>TDAPⅢ（以下、「本解析コード」という。）は、静荷重（節点力、静的震度、強制変形）及び動荷重（節点加振力、強制変位・速度・加速度、地震動入力）を扱うことができる構造解析の汎用解析コードである。線形解析及び非線形解析を時間領域における数値積分により行う。</p> <p>土木及び建築分野に特化した要素群及び材料非線形モデルを数多くサポートしていることが特徴で、日本国内では、官公庁、大学及び民間を問わず、多くの利用実績がある。</p>
検証 (Verification) 及び 妥当性確認 (Validation)	<p>【検証(Verification)】 本解析コードの検証の内容は以下のとおりである。</p> <ul style="list-style-type: none"> ・本解析コードによる解析の検証として、実績ある解析コードと同一諸元による固有値解析, 地震応答解析及び弾性応力解析を行い、算定結果が一致することを確認している。 ・動作環境を満足する計算機にインストールして用いていることを確認している。 <p>【妥当性確認(Validation)】 本解析コードの妥当性確認の内容は以下のとおりである。</p> <ul style="list-style-type: none"> ・九州電力株式会社川内1号機の工事計画認可申請において、本申請と同じ使用目的での実績を有することを確認している。 ・本申請において使用するバージョンは、上記の先行施設にて使用しているもの(Ver. 3.05)と異なるが、バージョンアップに伴う変更点は、今回の解析に使用していない材料や要素の追加及び出力関連の機能の追加に関するものであり、今回の解析結果に影響を及ぼさないことを確認している。 ・上述の検証の内容のとおり、本申請における使用目的と整合した検証として、固有値解析, 地震応答解析及び弾性応力解析に対して本解析コードと実績ある他コードとの比較を実施し、本解析コードが他コードと同等の解を与えることを確認していることから、本解析コードを本申請における固有値解析, 地震応答解析及び弾性応力解析に使用することは妥当である。

別紙4 VA

1. 使用状況一覧

使用添付書類		バージョン
IV-2-1-1 -1-1-1	安全冷却水B冷却塔基礎の地震応答計算書	Ver. 2.0

2. 解析コードの概要

項目 \ コード名	VA
開発機関	大成建設株式会社
開発時期	1990 年
使用したバージョン	Ver. 2.0
使用目的	地震応答解析モデルにおける基礎底面地盤ばね算定
コードの概要	<p>VA (以下, 「本解析コード」という。) は, 振動アドミッタンス理論により, 矩形基礎の水平動, 上下動及び回転に対する地盤の複素ばね剛性を半無限地盤に対する点加振解から, 振動数領域で計算するプログラムである。</p> <p>日本国内の原子力施設の工事計画認可申請において多くの利用実績がある。</p>
検証 (Verification) 及び 妥当性確認 (Validation)	<p>【検証(Verification)】 本解析コードの検証の内容は以下のとおりである。</p> <ul style="list-style-type: none"> ・ 既往文献^{※1※2}に記載されている理論モデルによる基礎底面の水平ばね, 回転ばね及び鉛直ばねの評価例について本解析コードを用いて評価し, 本解析コードによる結果と既往文献の結果が一致することを確認している。 ・ 動作環境を満足する計算機にインストールして用いていることを確認している。 <p>【妥当性確認(Validation)】 本解析コードの妥当性確認の内容は以下のとおりである。</p> <ul style="list-style-type: none"> ・ 九州電力株式会社川内 1 号機の工事計画認可申請において, 本申請と同じ使用目的での実績を有することを確認している。 ・ 本申請において使用するバージョンは, 上記の先行施設にて使用しているものと同じであることを確認している。 ・ 上述の検証の内容のとおり, 本申請における使用目的と整合した検証として, 基礎底面地盤ばね算定に対して本解析コードと既往文献の評価結果との比較を実施し, 本解析コードが既往文献の評価結果と同等の解を与えることを確認していることから, 本解析コードを本申請における基礎底面地盤ばね算定に使用することは妥当である。

※1：建築構造力学の最近の発展－応力解析の考え方－，日本建築学会，2008 年

※2：基礎-地盤複素剛性解析コード SANBANE の保守に関する報告書，原子力発電技術機構，1998 年

別紙5 FLIP

1. 使用状況一覧

	使用添付書類	バージョン
IV - 2 - 2 - 2 - 1 - 2 - 1 - 1	飛来物防護ネット(再処理設備本体用 安 全冷却水系冷却塔B)の地震応答計算書	Ver. 7. 4. 1

2. 解析コードの概要

コード名 項目	FLIP
開発機関	FLIP コンソーシアム
開発時期	1988 年
使用したバージョン	Ver. 7. 4. 1
使用目的	2次元有限要素法による地震応答解析 (全応力・有効応力)
コードの概要	<p>有効応力解析コード FLIP (Finite element analysis program of Liquefaction Process) は、1988 年に運輸省港湾技術研究所 (現：(独) 港湾空港技術研究所) において開発された平面ひずみ状態を対象とする有効応力解析法に基づく、2次元地震応答解析プログラムである。</p> <p>地盤の過剰間隙水圧の上昇を適切に考慮できる解析コードとして、港湾の施設の設計を中心に数多くの実績を有しており、FLIP の主な特徴として、以下の①～⑤を挙げることができる。</p> <p>①有限要素法に基づくプログラムである。</p> <p>②平面ひずみ状態を解析対象とする。</p> <p>③地盤の有効応力の変化を考慮した地震応答解析を行い、部材断面力や変形等を計算する。</p> <p>④土の応力-ひずみモデルとして、マルチスプリング・モデルを採用している。</p> <p>⑤有効応力の変化は有効応力法により考慮する。そのために必要な過剰間隙水圧算定モデルとして井合モデルを用いている。</p>

項目	コード名 FLIP
検証 (Verification) 及び 妥当性確認 (Validation)	<p>【検証(Verification)】 本解析コードの検証の内容は以下のとおりである。</p> <ul style="list-style-type: none"> ・マニュアルに記載された例題の提示解と本解析コードによる解析解との比較を実施し、解析解が提示解と一致することを確認している。 ・本解析コードの運用環境について、開発機関から提示された要件を満足していることを確認している。 <p>【妥当性確認(Validation)】 本解析コードの妥当性確認の内容は以下のとおりである。</p> <ul style="list-style-type: none"> ・本解析コードは、港湾施設の設計に用いられる「港湾の施設の技術上の基準・同解説(2007)(日本港湾協会)」において、有効応力解析に対しての適用性が確認されている解析コードとして扱われている。 ・本解析コードは、海岸構造物で多くの適用実績があるものの、その適用範囲が海岸構造物に限定されるものではないことを確認している。 ・東京電力ホールディングス株式会社柏崎刈羽発電所7号機の工事計画認可申請において、屋外重要土木構造物などの地震応答解析(全応力・有効応力)に本解析コード(Ver. 7. 4. 1)が使用された実績があることを確認している。 ・本申請における2次元有限要素法による地震応答解析(全応力・有効応力)という使用目的に対し、本解析コードの使用用途及び使用に関する適用範囲が上述の妥当性確認の範囲内であることを確認している。

別紙6 midas iGen

1. 使用状況一覧

	使用添付書類	バージョン
IV-2-2-2-1 -2-1-2	飛来物防護ネット(再処理設備本体用 安全冷却水系冷却塔B)の耐震計算書	Ver. 845
IV-2-3-1-3 -1 別紙1	飛来物防護ネット(再処理設備本体用 安全冷却水系冷却塔B)の水平2方向及び鉛直方向地震力の組合せに関する影響評価結果	Ver. 845

2. 解析コードの概要

コード名 項目	midas iGen
開発機関	MIDAS IT
開発時期	1990年代前半
使用したバージョン	Ver. 845
使用目的	静的解析
コードの概要	midas iGen(以下, 「本解析コード」という。)は, 建築分野に特化した要素群及び材料非線形モデルを数多くサポートしている構造解析用の汎用計算機プログラムである。
検証 (Verification) 及び 妥当性確認 (Validation)	<p>【検証(Verification)】 本解析コードの検証の内容は以下のとおりである。</p> <ul style="list-style-type: none"> 本解析コードによる解析の検証として, 実績ある別計算機コード「汎用計算機コード(TDAPⅢ)」による同一諸元のフレームモデルを用いた静的解析を行い, 算定結果が概ね一致することを確認している。 動作環境を満足する計算機にインストールして用いていることを確認している。 <p>【妥当性確認(Validation)】 本解析コードの妥当性確認の内容は以下のとおりである。</p> <ul style="list-style-type: none"> 日本原電株式会社東海第二発電所の工事計画認可申請において, 本申請と同じ使用目的での実績を有することを確認している。 本申請において使用するバージョンは, 上記の先行施設にて使用しているもの(Ver. 860)と異なるが, バージョンアップに伴う変更点は, 今回の解析に使用していない解析機能の拡張, 材料の追加及び計算パフォーマンスの向上等に関するものであり, 解析結果に影響を及ぼさないことを確認している。 上述の検証の内容のとおり, 本申請における使用目的と整合した検証として, 静的解析に対して本解析コードと実績ある他コードとの比較を実施し, 本解析コードが他コードと同等の解を与えることを確認していることから, 本解析コードを本申請における静的解析に使用することは妥当である。

別紙7 NAPISOS

1. 使用状況一覧

使用添付書類		バージョン
IV-2-4-2 -1-1-1- 1	安全冷却水B冷却塔基礎の隣接建屋に関する影響評価結果	Ver. 2.0

2. 解析コードの概要

コード名	NAPISOS
項目	
開発機関	電力中央研究所，株式会社竹中工務店
開発時期	1996 年
使用したバージョン	Ver. 2.0
使用目的	質点系モデルによる地震応答解析
コードの概要	<p>NAPISOS（以下、「本解析コード」という。）は、地盤をソリッド要素で、建屋を非線形積層シェル要素や非線形ビーム要素でモデル化することにより、建屋の地盤建屋連成系 3 次元非線形地震応答解析が可能である。</p> <p>建屋基礎と地盤モデル間に、ジョイント要素を設置することにより、基礎浮上り性状を評価することができる。</p> <p>日本国内の原子力関連施設等での多くの利用実績がある。</p>
検証 (Verification) 及び 妥当性確認 (Validation)	<p>【検証(Verification)】</p> <p>本解析コードの検証の内容は以下のとおりである。</p> <ul style="list-style-type: none"> ・ 1 質点系モデルについて、本解析コードで地震応答解析を行った解析解と、Nigam-Jennings の理論式による理論解を比較し、解析解と理論解が一致することを確認している。また、地震応答解析に対して、原子力産業界において使用実績のある TDAS を用いた解析解と、本解析コードによる解析解を比較したベンチマーキングを行った結果、双方の解が概一致していることを確認している。 ・ 本解析コードの運用環境について、開発機関から提示された要件を満足していることを確認している。 <p>【妥当性確認(Validation)】</p> <p>本解析コードの妥当性確認の内容は以下のとおりである。</p> <ul style="list-style-type: none"> ・ 東京電力ホールディングス株式会社柏崎刈羽 7 号機の工事計画認可申請において、本申請と同じ使用目的での実績を有することを確認している。 ・ 本申請において使用するバージョンは、上記の先行施設にて使用しているものと同じであることを確認している。 ・ 上述の検証の内容のとおり、本申請における使用目的と整合した検証として、質点系モデルによる地震応答解析に対して本解析コードと理論解及び他コードの解析解との比較を実施し、本解析コードが理論解及び他解析コードと同等の解を与えることを確認していることから、本解析コードを本申請における質点系モデルによる地震応答解析に使用することは妥当である。

機器・配管系

目 次

	ページ
別紙 1 FACT-B	1-1
別紙 2 SPAN2000	2-1
別紙 3 MSC NASTRAN	3-1

別紙1 FACT-B

1. 使用状況一覧

使用添付書類		バージョン
IV-1-1-6 別紙1-1	安全冷却水B冷却塔の設計用床応答曲線	V1.3

2. 解析コードの概要

項目 \ コード名	FACT-B
開発機関	辰星技研株式会社
開発時期	2016 年
使用したバージョン	V1.3
使用目的	設計用床応答曲線作成
コードの概要	<p>FACT-B（以下「本解析コード」という。）は、加速度時刻歴から床応答スペクトルを作成するプログラムであり、建物・構築物の床応答時刻歴から設計用床応答曲線を作成することを目的とする。</p> <p>一定の固有周期及び減衰定数を有する 1 質点系の与えられた加速度時刻歴に対する最大応答加速度を計算し、減衰定数が同一の系で計算された複数の床応答スペクトルの包絡値を求め、また床応答スペクトルの拡張を行う。</p> <p>本解析コードは、設計用床応答曲線を作成するために開発したハウスコードである。</p>
検証 (Verification) 及び 妥当性確認 (Validation)	<p>【検証(Verification)】</p> <p>本解析コードの検証の内容は、以下のとおりである。</p> <ul style="list-style-type: none"> ・ 発電炉にて使用実績がある別解析コード「FACS」により作成した設計用床応答曲線と本解析コードで作成した設計用床応答曲線を比較し、一致していることを確認している。 ・ 本解析コードの運用環境について、動作環境を満足する計算機にインストールして用いていることを確認している。 <p>【妥当性確認(Validation)】</p> <p>本解析コードの妥当性確認の内容は、以下のとおりである。</p> <ul style="list-style-type: none"> ・ 本申請で使用する床応答スペクトルの作成機能は、理論モデルをそのままコード化したものであり、拡張機能及び包絡機能を含め使用実績がある別解析コードとの比較により妥当性は確認している。 ・ 床応答スペクトルを作成する際、入力する加速度時刻歴データの時間刻み幅、データの形式については、使用実績がある別解析コードとの比較により妥当性を確認した範囲内にて使用している。 ・ ±10%拡張、時刻歴波の時間刻み及び固有周期計算間隔は JEAG4601-1987 に従っており、妥当性は確認している。

3. 解析コードの解析手法について

3.1 一般事項

本書は、建物・構築物の地震応答解析から算出される加速度時刻歴から床応答スペクトルを作成する解析コードである FACT-B の説明書である。

本解析コードは、一定の固有周期及び減衰定数を有する 1 質点系の与えられた加速度時刻歴に対する最大応答加速度を計算する。また、減衰定数が同一の系で計算された複数の床応答スペクトルの包絡値を求め、拡幅した設計用床応答曲線の作成を行う。

3.2 解析コードの特徴

本解析コードにおける 1 自由度系を用いた床応答スペクトルの作成は、線形加速度法を用いることにより行う。主な特徴を以下に示す。

- ・ 加速度時刻歴から周期及び減衰定数に応じた床応答スペクトルを作成する。
- ・ 複数の床応答スペクトルを包絡させた床応答スペクトルに対して拡幅した設計用床応答曲線を作成する。

3.3 解析手法

加速度時刻歴を入力とする 1 自由度系における応答について、減衰定数をパラメータとして以下のとおり算出する。

各質点における相対変位を x 、固有円振動数を ω 、減衰定数を h 、地動の加速度時刻歴を \ddot{y}_t としたとき、1 質点系の運動方程式は時刻 t において以下のように表される。

$$\ddot{x}_t + 2h \cdot \omega \cdot \dot{x}_t + \omega^2 \cdot x_t = -\ddot{y}_t \quad (3.1)$$

時刻刻み Δt 後の各質点における相対変位 x を x_{n+1} とすると、時刻 t_{n+1} において成立する運動方程式は以下となる。

$$\ddot{x}_{n+1} + 2h \cdot \omega \cdot \dot{x}_{n+1} + \omega^2 \cdot x_{n+1} = -\ddot{y}_{n+1} \quad (3.2)$$

ここで、時間 Δt の間で加速度が線形に変化するものとする、以下のように表される。

$$\ddot{X}_n = \frac{\ddot{x}_{n+1} - \ddot{x}_n}{\Delta t} \quad (3.3)$$

時刻 t_{n+1} における加速度 \ddot{x}_{n+1} 、速度 \dot{x}_{n+1} 及び変位 x_{n+1} は次のようになる。

$$\ddot{x}_{n+1} = \ddot{x}_n + \frac{\ddot{x}_{n+1} - \ddot{x}_n}{\Delta t} \Delta t \quad (3.4)$$

$$\begin{aligned} \dot{x}_{n+1} &= \dot{x}_n + \Delta t \cdot \ddot{x}_n + \frac{1}{2} \Delta t^2 \cdot \ddot{\ddot{x}}_n \\ &= \dot{x}_n + \frac{1}{2} \Delta t \cdot \ddot{x}_n + \frac{1}{2} \Delta t \cdot \ddot{x}_{n+1} \end{aligned} \quad (3.5)$$

$$\begin{aligned} x_{n+1} &= x_n + \Delta t \cdot \dot{x}_n + \frac{1}{2} \Delta t^2 \cdot \ddot{x}_n + \frac{1}{6} \Delta t^3 \cdot \ddot{\ddot{x}}_n \\ &= x_n + \Delta t \cdot \dot{x}_n + \frac{1}{3} \Delta t^2 \cdot \ddot{x}_n + \frac{1}{6} \Delta t^2 \cdot \ddot{x}_{n+1} \end{aligned} \quad (3.6)$$

時刻 t_{n+1} において成立する運動方程式(3.2)に(3.5), (3.6)を代入すると, (3.7)が得られる。

$$\begin{aligned} &\left(1 + \frac{2h \cdot \omega \cdot \Delta t}{2} + \frac{\omega^2 \cdot \Delta t^2}{6}\right) \ddot{x}_{n+1} \\ &= -\left\{\ddot{y}_{n+1} + 2h \cdot \omega \left(\dot{x}_n + \frac{1}{2} \Delta t \cdot \ddot{x}_n\right) + \omega^2 \left(x_n + \Delta t \cdot \dot{x}_n + \frac{1}{3} \Delta t^2 \cdot \ddot{x}_n\right)\right\} \end{aligned} \quad (3.7)$$

(3.7)において式を簡略化するため,

$$R = 1 + \frac{2h \cdot \omega \cdot \Delta t}{2} + \frac{\omega^2 \cdot \Delta t^2}{6} \quad (3.8)$$

$$E_n = \dot{x}_n + \frac{1}{2} \Delta t \cdot \ddot{x}_n \quad (3.9)$$

$$F_n = x_n + \Delta t \cdot \dot{x}_n + \frac{1}{3} \Delta t^2 \cdot \ddot{x}_n \quad (3.10)$$

とおくと, (3.7)から(3.11)が得られる。

$$\ddot{x}_{n+1} = -\frac{1}{R} (\ddot{y}_{n+1} + 2h \cdot \omega \cdot E_n + \omega^2 \cdot F_n) \quad (3.11)$$

(3.11)を(3.5), (3.6)に代入すると, 時刻 t_n での加速度 \ddot{x}_n , 速度 \dot{x}_n 及び変位 x_n から1つ先の時刻 t_{n+1} での加速度 \ddot{x}_{n+1} , 速度 \dot{x}_{n+1} 及び変位 x_{n+1} を求めることができる。

ここで, 1つの減衰定数 h , 1つの計算固有周期点に対して, (3.5), (3.6), (3.11)により入力地震動 \ddot{y}_n の全継続時間にわたって応答加速度 \ddot{x}_n を算出し, $\ddot{x}_n + \ddot{y}_n$ の絶対値の最大値を求め, これを1つの減衰定数 h , 1つの計算固有周期点での加速度応答スペクトル算出値とする。

計算固有周期の範囲で同様に最大値を求め, これら最大値で床応答スペクトルを作成する。

なお, 初期値 ($t=0$) での応答加速度 \ddot{x}_0 , 応答速度 \dot{x}_0 , 応答変位 x_0 は以下のように表される。

$$x_{t=0}=0 \quad (3.12)$$

$$\dot{x}_{t=0}=-\ddot{y}_{t=0} \cdot \Delta t \quad (3.13)$$

$$(\ddot{x}+\ddot{y})_{t=0}=2h \cdot \omega \cdot \ddot{y}_{t=0} \Delta t \quad (3.14)$$

3.4 解析フローチャート

本解析コードを用いた解析フローチャートを図 3-1 に示す。



図 3-1 解析フローチャート

3.5 検証 (Verification) 及び妥当性確認 (Validation)

3.5.1 検証 (Verification)

(1) 検証の概要

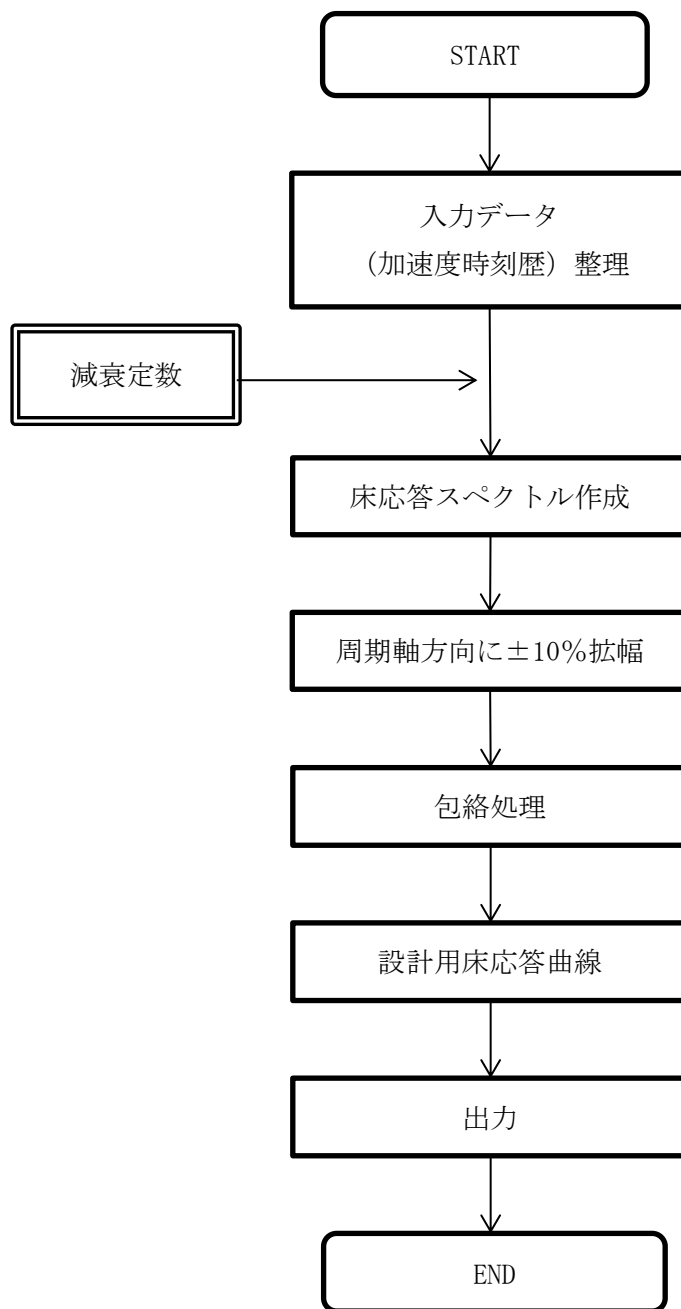
別解析コード「FACS」にて作成した設計用床応答曲線（検証用データ）と本解析コードで作成した設計用床応答曲線の加速度（震度）を比較することで、本プログラムの検証を行った。

表 3-1 検証における比較項目

検証対象	比較項目
設計用床応答曲線	応答加速度（震度）

(2) 検証条件

第1非常用ディーゼル発電設備用重油タンク室の地震応答解析から得られた基準地震動 S_s に対する加速度時刻歴として、EW 方向モデルの床レベル 55.30m の質点番号①及びNS 方向の床レベル 47.70m の質点番号②の S_s-A の応答を用いた。また、設計用床応答曲線を作成するための減衰定数は、機器・配管系の耐震計算に適用するもののうち、1.0%とした。図 3-2 に第1非常用ディーゼル発電設備用重油タンク室の地震応答解析モデルを示す。



図 3-2 第1非常用ディーゼル発電設備用重油タンク室地震応答解析モデル
(水平方向)

(3) 解析結果の比較

各検証条件で作成した設計用床応答曲線について、検証用データと本解析コードで作成したデータの比較結果を図 3-3～図 3-6 に示す。

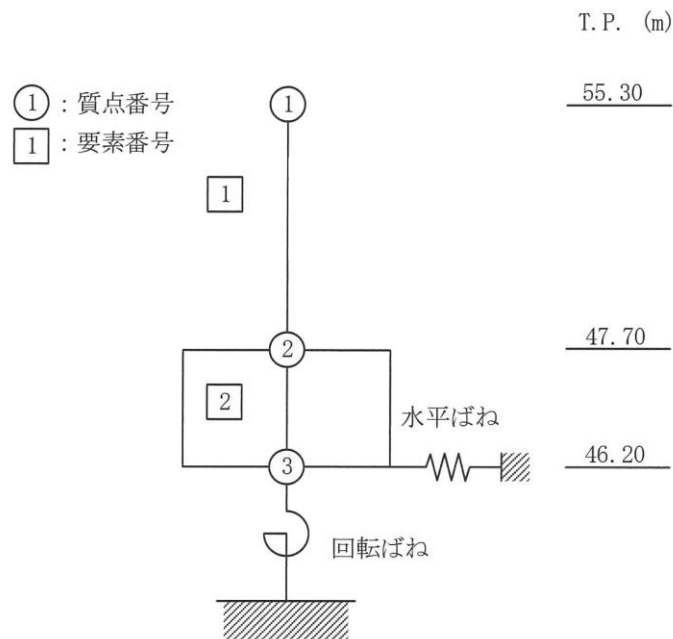

図 3-3 検証用データと本解析コードの比較結果
(EW 方向床レベル 55.30m 減衰 1.0%)



図 3-4 検証用データと本解析コードの比較結果
(NS 方向床レベル 47.70m 減衰 1.0%)

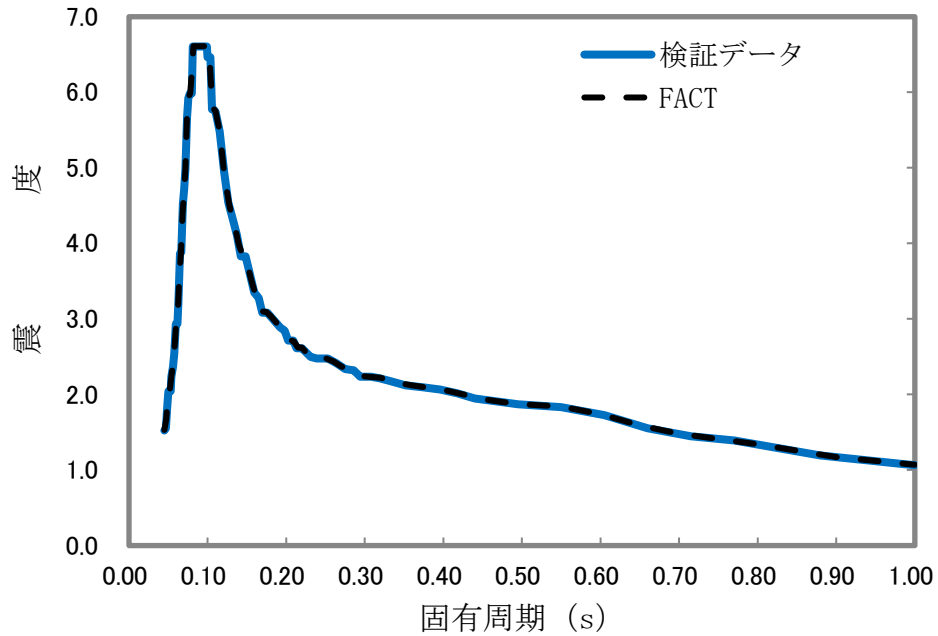

図 3-5 検証用データと本解析コードの比較結果
(水平方向包絡 床レベル 55.30m 減衰 1.0%)

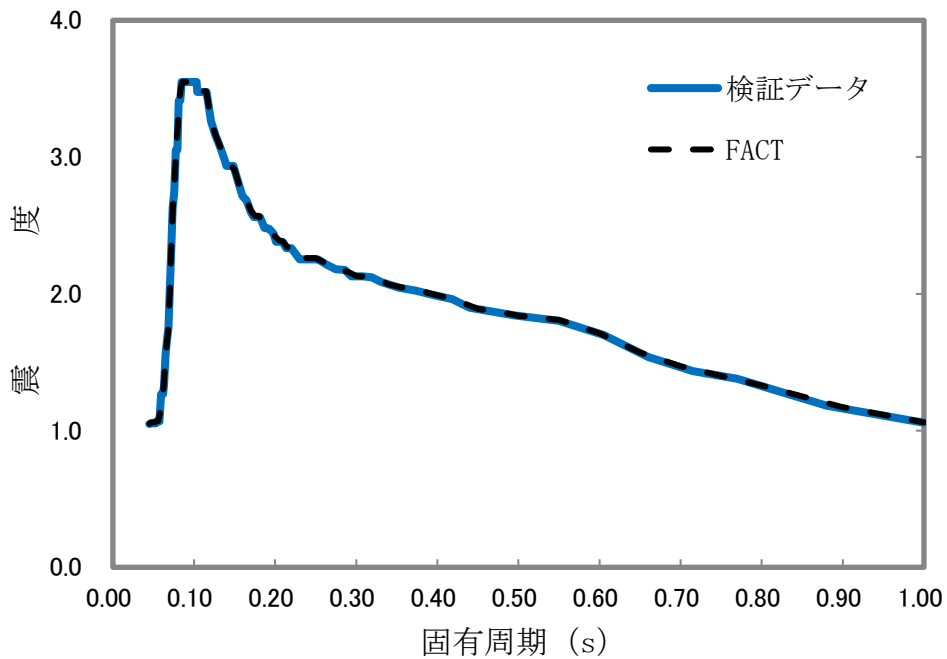

図 3-6 検証用データと本解析コードの比較結果
(水平方向包絡 床レベル 47.70m 減衰 1.0%)

(4) 検証結果

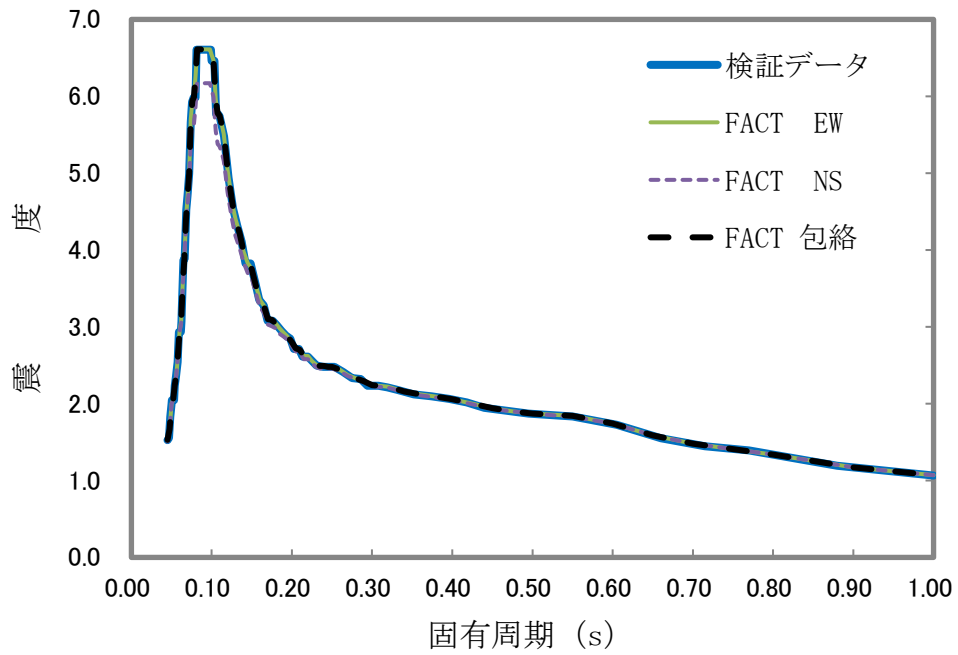
前項に示す設計用床応答曲線（固有周期と応答加速度（震度））の比較結果のとおり、両者は一致しており、本解析コードを用いて得られた計算結果の妥当性を確認した。

3.5.2 妥当性確認 (Validation)

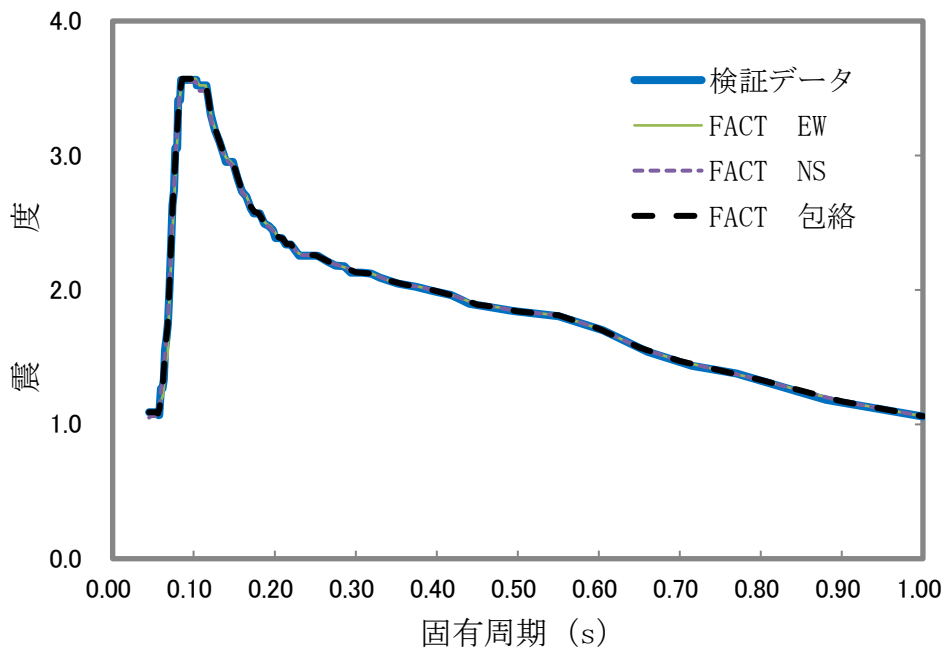
本解析コードの妥当性確認の内容は、以下のとおりである。

- ・ 本申請で使用する機能は床応答スペクトルの作成機能、拡幅機能及び包絡機能であり、同一の入力条件に対する1自由度系の最大応答加速度を固有周期ごとに算定し、別解析コード「FACS」と本解析コードの結果を比較することで妥当性を確認している。
- ・ 床応答スペクトルを作成する際、入力する加速度時刻歴データの時間刻み幅、データの形式については、使用実績がある別解析コードとの比較により妥当性を確認した範囲内にて使用している。
- ・ ±10%拡幅、時刻歴波の時間刻み及び固有周期計算間隔は JEAG4601-1987 に従っており、妥当性は確認している。

3.5.3 評価結果

3.5.1 及び 3.5.2 より、本解析コードを、使用目的に示す設計用床応答曲線の作成に用いることは妥当である。

別紙2 SPAN2000

1. 使用状況一覧

	使用添付書類	バージョン
IV-1-1-11-1 別紙1-1	安全冷却水B 冷却塔の配管標準支持間隔	■■■■■

2. 解析コードの概要

コード名 項目	SPAN2000
開発機関	三菱重工業株式会社
開発時期	■■■■
使用したバージョン	■■■■
使用目的	等分布質量連続はり要素による耐震最大支持間隔算出
コードの概要	<ul style="list-style-type: none"> • SPAN2000(以下、「本解析コード」という。)は、配管等の耐震設計に活用することを目的として三菱重工業株式会社が開発したものである。 • 配管直管部(一般部)について、発生応力、固有振動数等が許容値や制限値を超えない範囲における最大長さを標準支持間隔として求めることが可能であり、加圧水型原子力発電設備において、多くの使用実績を有している。

項目	コード名 SPAN2000
検証 (Verification) 及び 妥当性確認 (Validation)	<p>本解析コードは、配管を等分布質量連続はりモデル化し、許容値や制限値を超えない範囲における最大の支持間隔を求めるために使用している。</p> <p>【検証(Verification)】</p> <ul style="list-style-type: none"> 等分布質量連続はりモデルによる配管直管部(一般部)の耐震最大支持間隔算出、及びそれに発生する一次応力の算出について、入力データ()に対する応力算出結果において、解析解と理論モデルによる理論解との比較を行い、解析解が理論解と一致することを確認している。また、固有振動数に関しても、上記検証において、解析解と理論解との比較を行い、解析解が理論解と一致することを確認している。 地震動の組合せ処理に関しては、本解析コード内で処理しており、アウトプットファイルと理論計算結果が一致していることを確認している。 本解析コードの運用環境について、開発機関から提示された要件を満足していることを確認している。 <p>【妥当性確認(Validation)】</p> <ul style="list-style-type: none"> 日本原子力発電株式会社「東海第2発電所」において、本解析コードが使用された実績がある。 耐震最大支持間隔算出は、JEAG4601-1987の定ピッチスパン法に従い等分布質量連続はりにモデル化している。 本解析コードは、配管系で使用される要素形状のうち直管部の支持間隔の算出、発生応力の算出に用いられる。 今回の申請で行う支持間隔算出、発生応力算出の用途及び適用範囲が、上述の妥当性確認範囲内になることを確認している。 今回の申請において使用するバージョンは、他プラントの既工事計画において使用されているものと同じであることを確認している。

別紙3 MSC NASTRAN

1. 使用状況一覧

	使用添付書類	バージョン
IV-2-1-2-1 -1-1	安全冷却水冷却塔の耐震計算書	Ver. 2008.0.4

2. 解析コードの概要

コード名 項目	MSC NASTRAN
開発機関	MSC Software Corporation
開発時期	1971年(一般商用リリース)
使用したバージョン	Ver. 2008. 0. 4
使用目的	3次元有限要素法による応力解析
コードの概要	<ul style="list-style-type: none"> • MSC NASTRAN(以下, 「本解析コード」という。)は, 航空機の機体強度解析を目的として開発された有限要素法による構造解析用の汎用計算機プログラムである。 • 適用モデル(主にはり要素, シェル要素, ソリッド要素)に対して, 静的解析(線形, 非線形), 動的解析(過渡応答解析, 周波数応答解析), 固有値解析, 伝熱解析(温度分布解析), 熱応力解析, 線形座屈解析等の機能を有している。 • 数多くの研究機関や企業において, 航空宇宙, 自動車, 造船, 機械, 建築, 土木など様々な分野の構造解析に使用されている。

項目	コード名 MSC NASTRAN
検証 (Verification) 及び 妥当性確認 (Validation)	<p>本解析コードは、安全冷却水B冷却塔の3次元有限要素法による応力解析に使用している。</p> <p>【検証(Verification)】</p> <ul style="list-style-type: none"> ・構造力学分野における一般的知見により解を求めることが出来る体系について、本解析コードを用いた3次元有限要素法による応力解析結果と理論モデルによる理論解の比較を行い、解析解が理論解と一致することを確認している。 ・本解析コードの運用環境について、開発機関から提示された要件を満足していることを確認している。 <p>【妥当性確認(Validation)】</p> <ul style="list-style-type: none"> ・日本原子力発電株式会社「東海第2発電所」において、使用済燃料乾式貯蔵建屋の静的応力解析及び動的応力解析に本解析コードが使用された実績がある。 ・検証の体系と今回申請で使用する体系が同等であることから、検証結果をもって解析機能の妥当性も確認できる。 ・今回の申請において使用するバージョンは、他プラントの既工事計画において使用されているものと同じであることを確認している。 ・本解析コードの適用制限として使用要素数があるが、使用した要素数は適用制限以下であり、本申請における使用用途及び使用方法に関する適用範囲が上述の妥当性確認の範囲内であることを確認している。

別紙5

補足説明すべき項目の抽出

※本別紙は地盤 00-01、地震 00-01 統合した形式とする。

基本設計方針		添付書類(1)		添付書類(2)		補足すべき事項
1-1	第1章 共通項目 2.地盤 安全機能を有する施設及び重大事故等対処施設は、地震力が作用した場合においても当該施設を十分に支持することができる地盤（当該地盤に設置する建物・構築物を含む。「2.地盤」では以下同様。）に設置する。	IV-1-1-1 耐震設計の基本方針 2.耐震設計の基本方針 2.1基本方針 (1) 安全機能を有する施設	【2.1 基本方針 (1)安全機能を有する施設 g.】 ・耐震重要施設及びそれらを支える建物・構築物については、自重及び運転時の荷重等に加え、基準地震動Ssによる地震力が作用した場合においても、接地圧に対する十分な支持性能を有する地盤に設置する。 ・耐震重要施設以外の施設については、自重及び運転時の荷重等に加え、耐震重要度分類の各クラスに応じて算定する地震力が作用した場合においても、接地圧に対する十分な支持性能を有する地盤に設置する。 ・これらの地盤の評価については、添付書類「IV-1-1-2 地盤の支持性能に係る基本方針」に示す。	-	-	※補足すべき事項の対象なし
		IV-1-1-1 耐震設計の基本方針 2.耐震設計の基本方針 2.1基本方針 (2) 重大事故等対処施設	【2.1 基本方針 (2)重大事故等対処施設 g.】 ・常設耐震重要重大事故等対処設備を支える建物・構築物については、自重及び運転時の荷重等に加え、基準地震動による地震力が作用した場合においても、接地圧に対する十分な支持性能を有する地盤に設置する。 ・常設耐震重要重大事故等対処設備以外の常設重大事故等対処設備を支える建物・構築物については、自重及び運転時の荷重等に加え、代替する機能を有する安全機能を有する施設が属する耐震重要度分類のクラスに適用される地震力が作用した場合においても、接地圧に対する十分な支持性能を有する地盤に設置する。 ・これらの地盤の評価については、添付書類「IV-1-1-2 地盤の支持性能に係る基本方針」に示す。	-	-	
		-	-	IV-1-1-2 地盤の支持性能に係る基本方針 2.基本方針	【2. 基本方針】 ・対象施設を設置する地盤の地震時における支持性能の評価については、安全機能を有する施設及び重大事故等対処施設の耐震重要度分類に応じた地震力により地盤に作用する接地圧が、地盤の支持力度に対して、妥当な余裕を有することを確認する。	
1-2	なお、以下の項目における建物・構築物とは、建物、構築物及び土木構造物（屋外重要土木構造物及びその他の土木構造物）の総称とする。また、屋外重要土木構造物とは、耐震安全上重要な機器・配管系の間接支持機能を求められる土木構造物をいう。	IV-1-1-1 耐震設計の基本方針 2.耐震設計の基本方針 2.1基本方針	【2.耐震設計の基本方針】 【2.1 基本方針】 ・「IV 再処理施設の耐震性に関する説明書」における建物・構築物とは、建物、構築物及び土木構造物（屋外重要土木構造物及びその他の土木構造物）の総称とする。再処理施設の構築物は、屋外機械基礎、電巻防護対策設備及び排気筒であり、土木構造物は洞道である。また、屋外重要土木構造物とは、耐震安全上重要な機器・配管系の間接支持機能を求められる土木構造物をいう。	-	-	<洞道の取扱い> ⇒洞道の申請上の取り扱いについて明確化するために補足説明する。 ・[補足耐2]洞道の設工認申請上の取り扱いについて
2-1	2.1 安全機能を有する施設の地盤 地震の発生によって生じるおそれがあるその安全機能の喪失に起因する放射線による公衆への影響の程度が特に大きい施設（以下「耐震重要施設」という。）及びそれらを支える建物・構築物については、自重及び運転時の荷重等に加え、その供用中に大きな影響を及ぼすおそれがある地震動（以下「基準地震動Ss」という）による地震力が作用した場合においても、接地圧に対する十分な支持性能を有する地盤に設置する。	IV-1-1-1 耐震設計の基本方針 2.耐震設計の基本方針 2.1基本方針 (1) 安全機能を有する施設	【2.1 基本方針 (1)安全機能を有する施設 g.】 ・耐震重要施設及びそれらを支える建物・構築物については、自重及び運転時の荷重等に加え、基準地震動Ssによる地震力が作用した場合においても、接地圧に対する十分な支持性能を有する地盤に設置する。 ・これらの地盤の評価については、添付書類「IV-1-1-2 地盤の支持性能に係る基本方針」に示す。	-	-	※補足すべき事項の対象なし
		-	-	IV-1-1-2 地盤の支持性能に係る基本方針 2.基本方針	【2. 基本方針】 ・対象施設を設置する地盤の地震時における支持性能の評価については、安全機能を有する施設及び重大事故等対処施設の耐震重要度分類に応じた地震力により地盤に作用する接地圧が、地盤の支持力度に対して、妥当な余裕を有することを確認する。	
2-2	また、上記に加え、基準地震動Ssによる地震力が作用することによって弱面上のずれが発生しない地盤として、事業指定(変更許可)を受けた地盤に設置する。	IV-1-1-1 耐震設計の基本方針 2.耐震設計の基本方針 2.1基本方針 (1) 安全機能を有する施設	【2.1 基本方針 (1)安全機能を有する施設 g.】 ・また、上記に加え、基準地震動Ssによる地震力が作用することによって弱面上のずれが発生しない地盤として、事業指定(変更許可)を受けた地盤に設置する。	-	-	※補足すべき事項の対象なし
2-3	耐震重要施設以外の施設については、自重及び運転時の荷重等に加え、耐震重要度分類の各クラスに応じて算定する地震力が作用した場合においても、接地圧に対する十分な支持性能を有する地盤に設置する。	IV-1-1-1 耐震設計の基本方針 2.耐震設計の基本方針 2.1基本方針 (1) 安全機能を有する施設	【2.1 基本方針 (1)安全機能を有する施設 g.】 ・耐震重要施設以外の施設については、自重及び運転時の荷重等に加え、耐震重要度分類の各クラスに応じて算定する地震力が作用した場合においても、接地圧に対する十分な支持性能を有する地盤に設置する。	-	-	※補足すべき事項の対象なし
3	耐震重要施設は、地震発生に伴う地殻変動によって生じる支持地盤の傾斜及び撓み並びに地震発生に伴う建物・構築物間の不等沈下、液状化及び揺すり込み沈下といった周辺地盤の変状により、その安全機能が損なわれるおそれがない地盤として、事業指定(変更許可)を受けた地盤に設置する。	IV-1-1-1 耐震設計の基本方針 2.耐震設計の基本方針 2.1基本方針 (1) 安全機能を有する施設	【2.1 基本方針 (1)安全機能を有する施設 g.】 ・耐震重要施設は、地震発生に伴う地殻変動によって生じる支持地盤の傾斜及び撓み並びに地震発生に伴う建物・構築物間の不等沈下、液状化及び揺すり込み沈下といった周辺地盤の変状により、その安全機能が損なわれるおそれがない地盤として、事業指定(変更許可)を受けた地盤に設置する。	-	-	※補足すべき事項の対象なし
4	耐震重要施設は、将来活動する可能性のある断層等の露頭がない地盤として、事業指定(変更許可)を受けた地盤に設置する。	IV-1-1-1 耐震設計の基本方針 2.耐震設計の基本方針 2.1基本方針 (1) 安全機能を有する施設	【2.1 基本方針 (1)安全機能を有する施設 g.】 ・耐震重要施設は、将来活動する可能性のある断層等の露頭がない地盤として、事業指定(変更許可)を受けた地盤に設置する。	-	-	※補足すべき事項の対象なし
5-1	Sクラスの施設及びそれらを支える建物・構築物の地盤の接地圧に対する支持力の許容限界については、自重及び運転時の荷重等と基準地震動Ssによる地震力との組み合わせにより算定される接地圧が、安全上適切と認められる規格及び基準に基づく地盤の極限支持力度に対して、妥当な余裕を有するよう設計する。	IV-1-1-1 耐震設計の基本方針 5.機能維持の基本方針 5.1構造強度 5.1.5許容限界 (3)基礎地盤の支持性能	【5.1.5 許容限界 (3)基礎地盤の支持性能】 a. Sクラスの建物・構築物、Sクラスの機器・配管系、常設耐震重要重大事故等対処設備が設置される重大事故等対処施設の建物・構築物、機器・配管系の基礎地盤 (a) 基準地震動Ssによる地震力との組合せに対する許容限界 ・接地圧が、安全上適切と認められる規格及び基準による地盤の極限支持力度に対して妥当な余裕を有することを確認する。	-	-	※補足すべき事項の対象なし
		-	-	IV-1-1-2 地盤の支持性能に係る基本方針 4.地盤の支持力度 4.1 直接基礎の支持力度	【4. 地盤の支持力度】 地盤の極限支持力度は、地盤工学会基準（JGS 1521-2003）地盤の平板載荷試験方法、又は基礎指針2001の支持力算定式に基づき、対象施設の支持地盤の室内試験結果から算定する方法により設定する。短期許容支持力度は、算定された極限支持力度の2/3 倍として設定する。 【4.1 直接基礎の支持力度】 ・直接基礎の支持力度については、当該施設直下の地盤を対象とした試験結果を適用することを基本とする。安全冷却水B冷却塔の直接基礎の極限支持力度の算定については、平成5年4月14日付け5安（核規）第24号にて認可を受けた設工認申請書の使用前検査成績書における岩石試験結果を用いて、以下に示す基礎指針2001による算定式に基づき設定する。	<地盤の支持力度> ⇒直接基礎及び杭基礎の支持力算定式または平板載荷試験の結果から設定した算定方法、パラメータ等の詳細について補足説明する。 ・[補足盤1]地盤の支持性能について
5-2	また、上記のうち、Sクラスの施設の建物・構築物の地盤にあつては、自重及び運転時の荷重等と弾性設計用地震動Sdによる地震力又は静的地震力との組み合わせにより算定される接地圧について、安全上適切と認められる規格及び基準に基づく地盤の短期許容支持力度を許容限界とする。	IV-1-1-1 耐震設計の基本方針 5.機能維持の基本方針 5.1構造強度 5.1.5許容限界 (3)基礎地盤の支持性能	【5.1.5 許容限界 (3)基礎地盤の支持性能】 a. Sクラスの建物・構築物、Sクラスの機器・配管系、常設耐震重要重大事故等対処設備が設置される重大事故等対処施設の建物・構築物、機器・配管系の基礎地盤 (b) 弾性設計用地震動Sdによる地震力又は静的地震力との組合せに対する許容限界 ・接地圧に対して、安全上適切と認められる規格及び基準による地盤の短期許容支持力度を許容限界とする。	-	-	※補足すべき事項の対象なし
		-	-	IV-1-1-2 地盤の支持性能に係る基本方針 4.地盤の支持力度 4.1 直接基礎の支持力度	【4. 地盤の支持力度】 地盤の極限支持力度は、地盤工学会基準（JGS 1521-2003）地盤の平板載荷試験方法、又は基礎指針2001の支持力算定式に基づき、対象施設の支持地盤の室内試験結果から算定する方法により設定する。短期許容支持力度は、算定された極限支持力度の2/3 倍として設定する。 【4.1 直接基礎の支持力度】 ・直接基礎の支持力度については、当該施設直下の地盤を対象とした試験結果を適用することを基本とする。	<地盤の支持力度> ⇒直接基礎及び杭基礎の支持力算定式または平板載荷試験の結果から設定した算定方法、パラメータ等の詳細について補足説明する。 ・[補足盤1]地盤の支持性能について

補足説明すべき項目の抽出
(第五条 (安全機能を有する施設の地盤)、第三十二条 (重大事故等対処施設の地盤)、第六条、第三十三条 (地震による損傷の防止))

基本設計方針	添付書類(1)	添付書類(2)	補足すべき事項
<p>Bクラス及びCクラスの施設の建物・構築物の地盤においては、自重及び運転時の荷重等と、静的地震力及び動的地震力(Bクラスの共振影響検討に係るもの)との組合せにより算定される接地圧に対して、安全上適切と認められる規格及び基準に基づく地盤の短期許容支持力度を許容限界とする。</p>	<p>IV-1-1 耐震設計の基本方針 5.機能維持の基本方針 5.1構造強度 5.1.5許容限界 (3)基礎地盤の支持性能</p>	<p>5.1.5 許容限界 (3)基礎地盤の支持性能】 b. Bクラス及びCクラスの建物・構築物、機器・配管系、常設耐震重要重大事故等対処設備以外の常設重大事故等対処設備が設置される重大事故等対処施設の建物・構築物、機器・配管系の基礎地盤 ・上記(3)a. (b)を適用する。</p>	<p>※補足すべき事項の対象なし</p>
<p>2.2 重大事故等対処施設の地盤 常設耐震重要重大事故等対処設備を支持する建物・構築物については、自重及び運転時の荷重等に加え、標準地震動 S s による地震力が作用した場合においても、接地圧に対する十分な支持性能を有する地盤に設置する。</p>	<p>IV-1-1 耐震設計の基本方針 2.耐震設計の基本方針 2.1基本方針 (2) 重大事故等対処施設</p>	<p>【2.1 基本方針 (2) 重大事故等対処施設 g.】 ・常設耐震重要重大事故等対処設備を支持する建物・構築物については、自重及び運転時の荷重等に加え、標準地震動による地震力が作用した場合においても、接地圧に対する十分な支持力を有する地盤に設置する。 ・これらの地盤の評価については、添付書類「IV-1-1-2 地盤の支持性能に係る基本方針」に示す。</p>	<p><地盤の支持力度> ⇒直接基礎及び杭基礎の支持力算定式または平板載荷試験の結果から設定した算定方法、パラメータ等の詳細について補足説明する。 ・【補足盤1】地盤の支持性能について</p>
<p>また、上記に加え、標準地震動 S s による地震力が作用することによって弱面上のずれが発生しない地盤として、事業指定(変更許可)を受けた地盤に設置する。</p>	<p>IV-1-1 耐震設計の基本方針 2.耐震設計の基本方針 2.1基本方針 (2) 重大事故等対処施設</p>	<p>【2.1 基本方針 (2) 重大事故等対処施設 g.】 ・また、常設耐震重要重大事故等対処設備が設置される重大事故等対処施設及びそれらを支持する建物・構築物については、上記に加え、標準地震動 S s による地震力が作用することによって弱面上のずれが発生しない地盤として、事業指定(変更許可)を受けた地盤に設置する。</p>	<p>※補足すべき事項の対象なし</p>
<p>常設耐震重要重大事故等対処設備以外の常設重大事故等対処設備を支持する建物・構築物については、自重及び運転時の荷重等に加え、代替する機能を有する安全機能を有する施設が属する耐震重要度分類のクラスに適用される地震力が作用した場合においても、接地圧に対する十分な支持性能を有する地盤に設置する。</p>	<p>IV-1-1 耐震設計の基本方針 2.耐震設計の基本方針 2.1基本方針 (2) 重大事故等対処施設</p>	<p>【2.1 基本方針 (2) 重大事故等対処施設 g.】 ・常設耐震重要重大事故等対処設備以外の常設重大事故等対処設備を支持する建物・構築物については、自重及び運転時の荷重等に加え、代替する機能を有する安全機能を有する施設が属する耐震重要度分類のクラスに適用される地震力が作用した場合においても、接地圧に対する十分な支持性能を有する地盤に設置する。</p>	<p>※補足すべき事項の対象なし</p>
<p>常設耐震重要重大事故等対処設備を支持する建物・構築物は、地震発生に伴う地盤変動によって生じる支持地盤の傾斜及び撓み並びに地震発生に伴う建物・構築物間の不等沈下、液状化及び揺すり込み沈下といった周辺地盤の変状により、重大事故に至るおそれがある事故(運転時の異常な過渡変化及び設計基準事故を除く。)又は重大事故に対処するために必要な機能が損なわれるおそれがない地盤として、事業指定(変更許可)を受けた地盤に設置する。</p>	<p>IV-1-1 耐震設計の基本方針 2.耐震設計の基本方針 2.1基本方針 (2) 重大事故等対処施設</p>	<p>【2.1 基本方針 (2) 重大事故等対処施設 g.】 ・常設耐震重要重大事故等対処設備を支持する建物・構築物は、地震発生に伴う地盤変動によって生じる支持地盤の傾斜及び撓み並びに地震発生に伴う建物・構築物間の不等沈下、液状化及び揺すり込み沈下といった周辺地盤の変状により、重大事故等に対処するために必要な機能が損なわれるおそれがない地盤として、事業指定(変更許可)を受けた地盤に設置する。</p>	<p>※補足すべき事項の対象なし</p>
<p>常設耐震重要重大事故等対処設備を支持する建物・構築物は、将来活動する可能性のある断層等の露頭がない地盤として、事業指定(変更許可)を受けた地盤に設置する。</p>	<p>IV-1-1 耐震設計の基本方針 2.耐震設計の基本方針 2.1基本方針 (2) 重大事故等対処施設</p>	<p>【2.1 基本方針 (2) 重大事故等対処施設 g.】 ・常設耐震重要重大事故等対処設備を支持する建物・構築物は、将来活動する可能性のある断層等の露頭がない地盤として、事業指定(変更許可)を受けた地盤に設置する。</p>	<p>※補足すべき事項の対象なし</p>
<p>常設耐震重要重大事故等対処設備を支持する建物・構築物の地盤の接地圧に対する支持力の許容限界については、自重及び運転時の荷重等と標準地震動 S s による地震力との組み合わせにより算定される接地圧が、安全上適切と認められる規格及び基準に基づく地盤の極限支持力度に対して、妥当な余裕を有するよう設計する。</p>	<p>IV-1-1 耐震設計の基本方針 5.機能維持の基本方針 5.1構造強度 5.1.5許容限界 (3)基礎地盤の支持性能</p>	<p>【5.1.5 許容限界 (3)基礎地盤の支持性能】 a. Sクラスの建物・構築物、Sクラスの機器・配管系、常設耐震重要重大事故等対処設備が設置される重大事故等対処施設の建物・構築物、機器・配管系の基礎地盤 (a) 標準地震動 S s による地震力との組合せに対する許容限界 ・接地圧が、安全上適切と認められる規格及び基準による地盤の極限支持力度に対して妥当な余裕を有することを確認する。</p>	<p>※補足すべき事項の対象なし</p>
<p>常設耐震重要重大事故等対処設備以外の常設重大事故等対処設備を支持する建物・構築物及び機器・配管系の地盤においては、自重及び運転時の荷重等と、静的地震力及び動的地震力(Bクラスの施設の機能を代替する常設重大事故等対処設備の共振影響検討に係るもの)との組合せにより算定される接地圧に対して、安全上適切と認められる規格及び基準に基づく地盤の短期許容支持力度を許容限界とする。</p>	<p>IV-1-1 耐震設計の基本方針 5.機能維持の基本方針 5.1構造強度 5.1.5許容限界 (3)基礎地盤の支持性能</p>	<p>IV-1-1-2 地盤の支持性能に係る基本方針 4.地盤の支持力度 4.1 直接基礎の支持力度 4.2 杭基礎の支持力度</p>	<p><地盤の支持力度> ⇒直接基礎及び杭基礎の支持力算定式または平板載荷試験の結果から設定した算定方法、パラメータ等の詳細について補足説明する。 ・【補足盤1】地盤の支持性能について</p>
<p>常設耐震重要重大事故等対処設備以外の常設重大事故等対処設備を支持する建物・構築物及び機器・配管系の地盤においては、自重及び運転時の荷重等と、静的地震力及び動的地震力(Bクラスの施設の機能を代替する常設重大事故等対処設備の共振影響検討に係るもの)との組合せにより算定される接地圧に対して、安全上適切と認められる規格及び基準に基づく地盤の短期許容支持力度を許容限界とする。</p>	<p>IV-1-1 耐震設計の基本方針 5.機能維持の基本方針 5.1構造強度 5.1.5許容限界 (3)基礎地盤の支持性能</p>	<p>IV-1-1-2 地盤の支持性能に係る基本方針 4.地盤の支持力度 4.1 直接基礎の支持力度 4.2 杭基礎の支持力度</p>	<p><地盤の支持力度> ⇒直接基礎及び杭基礎の支持力算定式または平板載荷試験の結果から設定した算定方法、パラメータ等の詳細について補足説明する。 ・【補足盤1】地盤の支持性能について</p>

補足説明すべき項目の抽出
(第五条(安全機能を有する施設の地盤)、第三十二条(重大事故等対処施設の地盤)、第六条、第三十三条(地震による損傷の防止))

基本設計方針		添付書類(1)	添付書類(2)		補足すべき事項	
10	第1章 共通項目 3. 自然現象等 3.1 地震による損傷の防止 3.1.1 耐震設計 (1) 耐震設計の基本方針 再処理施設は、次の方針に基づき耐震設計を行う。	IV-1-1 耐震設計の基本方針 1. 概要	【1.概要】 ・再処理施設の耐震設計が「再処理施設の技術基準に関する規則」(以下「技術基準規則」という。)第五条及び第三十二条(地盤)、第六条及び第三十三条(地震による損傷の防止)に適合することを説明するものである。 ・上記条文以外への適合性を説明する各資料にて基準地震動に対して機能を保持するとしているものとして、第十一条及び第三十五条(火災等による損傷の防止)に係る火災防護設備の耐震性については「IV-4 火災防護設備の耐震性に関する説明書」、第十二条(再処理施設内における溢水による損傷の防止)及び第十三条(再処理施設内における化学薬品の漏えいによる損傷の防止)に係る溢水防護設備、化学薬品防護設備の耐震性については「IV-5 溢水及び化学薬品防護設備の耐震性に関する説明書」にて説明する。また、第三十六条(重大事故等対処設備)に係る地震を要因とする重大事故等に対する施設の耐震性については「IV-6 地震を要因とする重大事故等に対する施設の耐震性に関する説明書」にて説明する。	-	-	<耐震評価対象の網羅性、既設工認との評価手法の相違点の整理> ⇒申請施設における評価対象施設、評価項目・部位の網羅性及び代表性を示すため、再処理施設における既設工認との評価手法の相違点の整理について補足説明する。 ・[補足耐1]耐震評価対象の網羅性、既設工認との手法の相違点の整理について(建物・構築物、機器・配管系)
		IV-1-1 耐震設計の基本方針 2. 耐震設計の基本方針 2.1 基本方針	【2.1基本方針】 ・再処理施設の耐震設計は、安全機能を有する施設については、地震により安全機能が損なわれるおそれがないこと、重大事故等対処施設については地震により重大事故に至るおそれがある事故又は重大事故に対処するために必要な機能が損なわれるおそれがないことを目的とし、「技術基準規則」に適合する設計とする。	-	-	※補足すべき事項の対象なし
11	なお、以下の項目における建物・構築物とは、建物、構築物及び土木構造物(屋外重要土木構造物及びその他の土木構造物)の総称とする。 また、屋外重要土木構造物とは、耐震安全上重要な機器・配管系の間接支持機能を求められる土木構造物をいう。	IV-1-1 耐震設計の基本方針 2. 耐震設計の基本方針 2.1 基本方針 (1)安全機能を有する施設	【2.1基本方針】 ・「IV 再処理施設の耐震性に関する説明書」における建物・構築物とは、建物、構築物及び土木構造物(屋外重要土木構造物及びその他の土木構造物)の総称とする。再処理施設の構築物は、屋外機械基礎、竜巻防護対策設備及び排気筒であり、土木構造物は洞道である。また、屋外重要土木構造物とは、耐震安全上重要な機器・配管系の間接支持機能を求められる土木構造物をいう。	-	-	<洞道の取扱い> ⇒洞道の申請上の取り扱いについて明確化するために補足説明する。 ・[補足耐2]洞道の設工認申請上の取り扱いについて
12	a.安全機能を有する施設 (a)安全機能を有する施設は、地震の発生によって生ずるおそれがある安全機能の喪失及びそれに続く放射線による公衆への影響を防止する観点から、施設の安全機能が喪失した場合の影響の相対的な程度(以下「耐震重要度」という。)に応じて、Sクラス、Bクラス又はCクラスに分類し、それぞれの耐震重要度に応じた地震力に十分耐えられる設計とする。	IV-1-1 耐震設計の基本方針 2. 耐震設計の基本方針 2.1 基本方針 (1)安全機能を有する施設	【2.1基本方針(1) a.】 ・安全機能を有する施設は、地震の発生によって生ずるおそれがある安全機能の喪失及びそれに続く放射線による公衆への影響を防止する観点から、各施設の安全機能が喪失した場合の影響の相対的な程度(以下「耐震重要度」という。)に応じて、Sクラス、Bクラス及びCクラスに分類(以下「耐震重要度分類」という。)し、それぞれの耐震重要度に応じた地震力に十分耐えられる設計とする。	-	-	※補足すべき事項の対象なし
13	(b)耐震重要施設((a)においてSクラスに分類する施設をいう。)は、その供用中に大きな影響を及ぼすおそれがある地震動(事業指定(変更許可)を受けた基準地震動(以下「基準地震動S s」という。))による地震力に対してその安全機能が損なわれるおそれがない設計とする。	IV-1-1 耐震設計の基本方針 2. 耐震設計の基本方針 2.1 基本方針 (1)安全機能を有する施設	【2.1基本方針】 ・施設的设计にあたり考慮する、基準地震動及び弾性設計用地震動の概要を添付書類「IV-1-1-1 基準地震動S s及び弾性設計用地震動S dの概要」に示す。	-	-	※補足すべき事項の対象なし
		IV-1-1 耐震設計の基本方針 2. 耐震設計の基本方針 2.1 基本方針 (1)安全機能を有する施設	【2.1基本方針(1) b.】 ・耐震重要施設(a.においてSクラスに分類する施設をいう。)は、その供用中に大きな影響を及ぼすおそれがある地震動(事業指定(変更許可)を受けた基準地震動(以下「基準地震動S s」という。))による地震力に対してその安全機能が損なわれるおそれがない設計とする。	-	-	※補足すべき事項の対象なし
		IV-1-1 耐震設計の基本方針 2. 耐震設計の基本方針 2.1 基本方針 (1)安全機能を有する施設	【2.1基本方針(1) h.】 ・安全機能を有する施設の構造計画及び配置計画に際しては、地震の影響が低減されるように考慮する。	-	-	※補足すべき事項の対象なし
		IV-1-1 耐震設計の基本方針 10. 耐震計算の基本方針	【10.耐震計算の基本方針】 ・耐震設計方針に基づいて設計した施設について、耐震計算を行うに当たり、既設工認で実績があり、かつ、最新の知見に照らしても妥当な手法及び条件を用いることを基本とする。 ・最新の知見を適用する場合は、その妥当性及び適用可能性を確認した上で適用する。 ・耐震計算における動的地震力の水平方向及び鉛直方向の組合せについては、水平1方向及び鉛直方向地震力の組合せで実施した上で、その計算結果に基づき水平2方向及び鉛直方向地震力の組合せが耐震性に及ぼす影響を評価する。	-	-	※補足すべき事項の対象なし
14	(c)Sクラスの施設は、基準地震動S sによる地震力に対してその安全機能が損なわれるおそれがない設計とする。	IV-1-1 耐震設計の基本方針 2. 耐震設計の基本方針 2.1 基本方針 (1)安全機能を有する施設	【2.1基本方針(1) c.】 ・Sクラスの施設は、基準地震動S sによる地震力に対してその安全機能が損なわれるおそれがない設計とする。	-	-	※補足すべき事項の対象なし
		IV-1-1 耐震設計の基本方針 10. 耐震計算の基本方針	【10.耐震計算の基本方針】 ・耐震設計方針に基づいて設計した施設について、耐震計算を行うに当たり、既設工認で実績があり、かつ、最新の知見に照らしても妥当な手法及び条件を用いることを基本とする。 ・最新の知見を適用する場合は、その妥当性及び適用可能性を確認した上で適用する。 ・耐震計算における動的地震力の水平方向及び鉛直方向の組合せについては、水平1方向及び鉛直方向地震力の組合せで実施した上で、その計算結果に基づき水平2方向及び鉛直方向地震力の組合せが耐震性に及ぼす影響を評価する。 ・評価対象設備である配管系、機器(容器及びポンプ類)及び電気計装品(盤、装置及び器具)のうち、複数設備に共通して適用する計算方法については「IV-1-1-11-1 配管の耐震支持方針」、 「IV-1-1-11-2 ダクトの耐震支持方針」及び「IV-1-2 耐震計算書作成の基本方針」に示す。	-	-	※補足すべき事項の対象なし
15	建物・構築物については、基準地震動S sによる地震力に対して、建物・構築物全体としての変形能力(耐震壁のせん断ひずみ等)が終局耐力時の変形に対して十分な余裕を有し、部材・部位ごとのせん断ひずみ・応力等が終局耐力時のせん断ひずみ・応力等に対して、妥当な安全余裕を有する設計とする。	IV-1-1 耐震設計の基本方針 2. 耐震設計の基本方針 2.1 基本方針 (1)安全機能を有する施設	【2.1基本方針(1) c.】 ・建物・構築物については、基準地震動S sによる地震力に対して、建物・構築物全体としての変形能力(耐震壁のせん断ひずみ等)が終局耐力時の変形に対して十分な余裕を有し、部材・部位ごとのせん断ひずみ・応力等が終局耐力時のせん断ひずみ・応力等に対して、妥当な安全余裕を有する設計とする。	-	-	※補足すべき事項の対象なし

	基本設計方針	添付書類(1)	添付書類(2)	補足すべき事項
16	機器・配管系については、基準地震動S _s による地震力に対して、その施設に要求される機能を保持する設計とし、塑性域に達するひずみが生じる場合であっても、その量が小さなレベルに留まって破断延性限界に十分な余裕を有し、その施設に要求される機能に影響を及ぼさない、また、動的機器等については、基準地震動S _s による応答に対してその設備に要求される機能を保持する設計とする。なお、動的機能が要求される機器については、当該機器の構造、動作原理等を考慮した評価を行い、既往の研究等で機能維持の確認がなされた機能確認済加速度等を超えていないことを確認する。	IV-1-1 耐震設計の基本方針 2.耐震設計の基本方針 2.1 基本方針 (1)安全機能を有する施設	【2.1 基本方針(1) e.】 ・機器・配管系については、基準地震動S _s による地震力に対して、塑性域に達するひずみが生じる場合であっても、その量が小さなレベルに留まって破断延性限界に十分な余裕を有し、その施設の機能を保持できるように設計する。 ・動的機器等については、基準地震動S _s による地震力に対して、当該機器に要求される機能を維持する設計とする。このうち、動的機能が要求される機器については、当該機器の構造、動作原理等を考慮した評価を行い、既往の研究等で機能維持の確認がなされた機能確認済加速度等を超えないことを確認する。	※補足すべき事項の対象なし
17	また、Sクラスの施設は、事業指定(変更許可)を受けた弾性設計用地震動(以下「弾性設計用地震動S _d 」という。)による地震力又は静的地震力のいずれか大きい方の地震力に対しておおむね弾性状態に留まる範囲で耐えられる設計とする。	IV-1-1 耐震設計の基本方針 2.耐震設計の基本方針 2.1 基本方針	【2.1 基本方針】 ・施設的设计にあたり考慮する、基準地震動及び弾性設計用地震動の概要を「IV-1-1-1 基準地震動S _s 及び弾性設計用地震動S _d の概要」に示す。	※補足すべき事項の対象なし
18	建物・構築物については、弾性設計用地震動S _d による地震力又は静的地震力のいずれか大きい方の地震力により発生する応力に対して、建築基準法等の安全上適切と認められる規格及び基準による許容応力度を許容限界とする。	IV-1-1 耐震設計の基本方針 2.耐震設計の基本方針 2.1 基本方針 (1)安全機能を有する施設	【2.1 基本方針(1) e.】 ・建物・構築物については、弾性設計用地震動S _d による地震力又は静的地震力のいずれか大きい方の地震力により発生する応力に対して、建築基準法等の安全上適切と認められる規格及び基準による許容応力度を許容限界とする。	※補足すべき事項の対象なし
19	機器・配管系については、弾性設計用地震動S _d による地震力又は静的地震力のいずれか大きい方の地震力による応答が全体的におおむね弾性状態に留まる設計とする。	IV-1-1 耐震設計の基本方針 2.耐震設計の基本方針 2.1 基本方針 (1)安全機能を有する施設	【2.1 基本方針(1) e.】 ・機器・配管系については、弾性設計用地震動S _d による地震力又は静的地震力のいずれか大きい方の地震力による応答が全体的におおむね弾性状態に留まる設計とする。	※補足すべき事項の対象なし
20	(d) Sクラスの施設について、静的地震力は、水平地震力と鉛直地震力が同時に不利な方向の組合せで作用するものとする。また、基準地震動S _s 及び弾性設計用地震動S _d による地震力は、水平2方向及び鉛直方向について適切に組み合わせで算定するものとする。	IV-1-1 耐震設計の基本方針 2.耐震設計の基本方針 2.1 基本方針 (1)安全機能を有する施設	【2.1 基本方針(1) d.】 ・Sクラスの施設について、静的地震力は、水平方向地震力と鉛直方向地震力が同時に不利な方向の組合せで作用するものとする。 ・基準地震動S _s 及び弾性設計用地震動S _d による地震力は、水平2方向及び鉛直方向について適切に組み合わせで算定するものとする。	※補足すべき事項の対象なし
21	(e) Bクラス及びCクラスの施設は、静的地震力に対しておおむね弾性状態に留まる範囲で耐えられる設計とする。また、Bクラスの施設のうち、共振のおそれのある施設については、その影響についての検討を行う。検討に用いる地震動は、弾性設計用地震動S _d に2分の1を乗じたものとする。当該地震動による地震力は、水平2方向及び鉛直方向について適切に組み合わせで算定するものとする。	IV-1-1 耐震設計の基本方針 2.耐震設計の基本方針 2.1 基本方針 (1)安全機能を有する施設	【2.1 基本方針(1) e.】 ・Bクラス及びCクラスの施設は、静的地震力に対しておおむね弾性状態に留まる範囲で耐えられる設計とする。 ・Bクラスの施設のうち、共振のおそれのある施設については、その影響についての検討を行う。検討に用いる地震動は、弾性設計用地震動S _d に2分の1を乗じたものとする。当該地震動による地震力は、水平2方向及び鉛直方向について適切に組み合わせで算定するものとする。	※補足すべき事項の対象なし
21		IV-1-1 耐震設計の基本方針 5.機能維持の基本方針 5.1 構造強度 5.1.5 許容限界 (1) 安全機能を有する施設 b. 機器・配管系	【5.1.5 許容限界(1) b.】 (b) Bクラス及びCクラスの機器・配管系 ・b. (a)ロ.による応力を許容限界とする。	※補足すべき事項の対象なし
21		IV-1-1 耐震設計の基本方針 10.耐震計算の基本方針	【10.耐震計算の基本方針】 ・耐震設計方針に基づいて設計した施設について、耐震計算を行うに当たり、既設工認で実績があり、かつ、最新の知見に照らしても妥当な手法及び条件を用いることを基本とする。 ・最新の知見を適用する場合は、その妥当性及び適用可能性を確認した上で適用する。 ・耐震計算における動的地震力の水平方向及び鉛直方向の組合せについては、水平1方向及び鉛直方向地震力の組合せで実施した上で、その計算結果に基づき水平2方向及び鉛直方向地震力の組合せが耐震性に及ぼす影響を評価する。	※補足すべき事項の対象なし

基本設計方針	添付書類(1)	添付書類(2)	補足すべき事項
(f) 耐震重要施設は、耐震重要度の下位のクラスに属する施設の波及的影響によって、その安全機能を損なわない設計とする。	IV-1-1 耐震設計の基本方針 2. 耐震設計の基本方針 2.1 基本方針 (1) 安全機能を有する施設	[2.1 基本方針(1) f.] ・耐震重要施設は、耐震重要度の下位のクラスに属する施設(安全機能を有する施設以外の施設及び資機材等含む)の波及的影響によって、その安全機能を損なわない設計とする。	※補足すべき事項の対象なし
	IV-1-1 耐震設計の基本方針 6. 構造計画と配置計画	[6. 構造計画と配置計画] ・安全機能を有する施設及び重大事故等対処施設の構造計画及び配置計画に際しては、地震の影響が低減されるように考慮する。 ・建物・構築物は、原則として剛構造とし、重要な建物・構築物は、地震力に対し十分な支持性能を有する地盤に支持させる。剛構造としない建物・構築物は、剛構造と同等又はそれを上回る耐震安全性を確保する。 ・耐震設計において地下水位の低下を期待する建物・構築物は、周囲の地下水を排出し、基礎スラブ底面レベル以下に地下水位を維持できるよう地下水排水設備(サブドレンポンプ、水位検出器等)を設置する。地下水排水設備は、安全機能を有する施設及び重大事故等対処施設に適用される要求事項を満たすよう設計する。また、上記より対象となる建物・構築物の評価に影響するため、建物・構築物の機能要求を満たすように、基準地震動Ssによる地震力に対して機能を維持するとともに、非常用電源設備又は基準地震動Ssによる地震力に対し機能維持が可能な発電機からの給電が可能な設計とすることとし、その評価を「IV-2-1 再処理設備本体等に係る耐震性に関する計算書」のうち地下水排水設備の耐震性についての計算書に示す。 ・機器・配管系は、応答性状を適切に評価し、適用する地震力に対して構造強度を有する設計とする。配置に自由度のあるものは、耐震上の観点からできる限り重心位置を低くし、かつ、安定性のよい据え付け状態になるよう、「9. 機器・配管系の支持方針について」に示す方針に従い配置する。 ・下位クラス施設は、耐震重要施設及び常設耐震重要重大事故等対処設備が設置される重大事故等対処施設に対して隔離を取り配置する、又は耐震重要施設の有する安全機能及び重大事故等に対処するために必要な機能を保持する設計とする。	<地下水排水設備> ⇒地下水排水設備に関する設計の考え方を示すため、地下水排水設備に関する設計内容について補足説明する。 ・[補足耐36]建物・構築物周辺の設計用地下水位の設定について
22	IV-1-1 耐震設計の基本方針 10. 耐震計算の基本方針	[10. 耐震計算の基本方針] ・耐震設計方針に基づいて設計した施設について、耐震計算を行うに当たり、既設工認で実績があり、かつ、最新の知見に照らしても妥当な手法及び条件を用いることを基本とする。 ・最新の知見を適用する場合は、その妥当性及び適用可能性を確認した上で適用する。 ・耐震計算における動的地震力の水平方向及び鉛直方向の組合せについては、水平1方向及び鉛直方向地震力の組合せで実施した上で、その計算結果に基づき水平2方向及び鉛直方向地震力の組合せが耐震性に及ぼす影響を評価する。 ・評価対象設備である配管系、機器(容器及びポンプ類)及び電気計装品(盤、装置及び器具)のうち、複数設備に共通して適用する計算方法については「IV-1-1-11-1 配管の耐震支持方針」、「IV-1-1-11-2 ダクトの耐震支持方針」及び「IV-1-2 耐震計算書作成の基本方針」に示す。	※補足すべき事項の対象なし
23	IV-1-1 耐震設計の基本方針 2. 耐震設計の基本方針 2.1 基本方針 (1) 安全機能を有する施設	[2.1 基本方針(1) g.] ・耐震重要施設については、周辺地盤の変状により、その安全機能が損なわれるおそれがない設計とする。 ・耐震重要施設のうち周辺地盤の液状化のおそれがある施設は、その周辺地盤の液状化を考慮した場合においても、支持機能及び構造健全性が確保される設計とする。 ・建物・構築物の基礎地盤として置き換えるマンメイドロック(以下「MMR」という。)については、基礎面及び周辺地盤の掘削に対する不陸整正及び建物・構築物がMMRを介して鷹架層に支持されることを目的とする。そのため、直下の鷹架層と同等以上の支持性能を有する設計とし、接地圧に対する支持性能評価においては鷹架層の支持力を適用する。 ・これらの地盤の評価については、「IV-1-1-2 地盤の支持性能に係る基本方針」に示す。	※補足すべき事項の対象なし
24	IV-1-1 耐震設計の基本方針 2. 耐震設計の基本方針 2.1 基本方針 (2) 重大事故等対処施設	[2.1 基本方針(2) a.] ・重大事故等対処施設について、安全機能を有する施設の耐震設計における動的地震力又は静的地震力に対する設計方針を踏襲し、重大事故等対処施設の構造上の特徴、重大事故等時における運転状態及び重大事故等の状態で施設に作用する荷重等を考慮し、適用する地震力に対して重大事故等に対処するために必要な機能が損なわれるおそれがない設計とする。	※補足すべき事項の対象なし
25	IV-1-1 耐震設計の基本方針 2. 耐震設計の基本方針 2.1 基本方針 (2) 重大事故等対処施設	[2.1 基本方針(2) a.] ・重大事故等対処施設について、施設の各設備が有する重大事故等に対処するために必要な機能及び設置状態を踏まえて、重大事故等が発生した場合において対処するために必要な機能を有する設備であって常設のもの(以下「常設重大事故等対処設備」という。)を、常設耐震重要重大事故等対処設備及び常設耐震重要重大事故等対処設備以外の常設重大事故等対処設備に分類し、それぞれの設備分類に応じて設計する。	※補足すべき事項の対象なし
26	IV-1-1 耐震設計の基本方針 2. 耐震設計の基本方針 2.1 基本方針 (2) 重大事故等対処施設	[2.1 基本方針(2) b.] ・常設耐震重要重大事故等対処設備が設置される重大事故等対処施設は、基準地震動Ssによる地震力に対して、重大事故等に対処するために必要な機能が損なわれるおそれがない設計とする。	※補足すべき事項の対象なし
26	IV-1-1 耐震設計の基本方針 2. 耐震設計の基本方針 2.1 基本方針 (2) 重大事故等対処施設	[2.1 基本方針(2) h.] ・重大事故等対処施設の構造計画及び配置計画に際しては、地震の影響が低減されるように考慮する。	※補足すべき事項の対象なし
26	IV-1-1 耐震設計の基本方針 10. 耐震計算の基本方針	[10. 耐震計算の基本方針] ・耐震設計方針に基づいて設計した施設について、耐震計算を行うに当たり、既設工認で実績があり、かつ、最新の知見に照らしても妥当な手法及び条件を用いることを基本とする。 ・最新の知見を適用する場合は、その妥当性及び適用可能性を確認した上で適用する。 ・耐震計算における動的地震力の水平方向及び鉛直方向の組合せについては、水平1方向及び鉛直方向地震力の組合せで実施した上で、その計算結果に基づき水平2方向及び鉛直方向地震力の組合せが耐震性に及ぼす影響を評価する。 ・評価対象設備である配管系、機器(容器及びポンプ類)及び電気計装品(盤、装置及び器具)のうち、複数設備に共通して適用する計算方法については「IV-1-1-11-1 配管の耐震支持方針」、「IV-1-1-11-2 ダクトの耐震支持方針」及び「IV-1-2 耐震計算書作成の基本方針」に示す。	※補足すべき事項の対象なし

補足説明すべき項目の抽出
(第五条（安全機能を有する施設の地盤）、第三十二条（重大事故等対処施設の地盤）、第六条、第三十三条（地震による損傷の防止））

	基本設計方針	添付書類(1)	添付書類(2)	補足すべき事項
27	建物・構築物については、基準地震動Ssによる地震力に対して、建物・構築物全体としての変形能力(耐震壁のせん断ひずみ等)が終局耐力時の変形に対して十分な余裕を有し、部材・部位ごとのせん断ひずみ・応力等が終局耐力時のせん断ひずみ・応力等に対して、妥当な安全余裕を有する設計とする。	IV-1-1 耐震設計の基本方針 2.耐震設計の基本方針 2.1 基本方針 (2)重大事故等対処施設	【2.1 基本方針(2) b.】 ・建物・構築物については、基準地震動Ssによる地震力に対して、建物・構築物全体としての変形能力(耐震壁のせん断ひずみ等)が終局耐力時の変形に対して十分な余裕を有し、部材・部位ごとのせん断ひずみ・応力等が終局耐力時のせん断ひずみ・応力等に対して、妥当な安全余裕を有する設計とする。	※補足すべき事項の対象なし
28	機器・配管系については、基準地震動Ssによる地震力に対して、その施設に要求される機能を保持する設計とし、塑性域に達するひずみが生じる場合であっても、その量が小さなレベルに留まって破断延性限界に十分な余裕を有し、その施設に要求される機能に影響を及ぼさない設計とする。また、動的機器等については、基準地震動Ssによる応答に対して、その設備に要求される機能を保持する設計とする。なお、動的機能が要求される機器については、当該機器の構造、動作原理等を考慮した評価を行い、既往の研究等で機能維持の確認がなされた機能確認済加速度等を超えていないことを確認する。	IV-1-1 耐震設計の基本方針 2.耐震設計の基本方針 2.1 基本方針 (2)重大事故等対処施設	【2.1 基本方針(2) b.】 ・機器・配管系については、その施設に要求される機能を保持するように設計し、塑性域に達するひずみが生じる場合であっても、その量が小さなレベルに留まって破断延性限界に十分な余裕を有し、その施設に要求される機能を保持できる設計とする。 ・動的機器等については、基準地震動Ssによる地震力に対して、当該機器に要求される機能を維持する設計とする。このうち、動的機能が要求される機器については、当該機器の構造、動作原理等を考慮した評価を行い、既往の研究等で機能維持の確認がなされた機能確認済加速度等を超えないことを確認する。	※補足すべき事項の対象なし
29	(c)常設耐震重要重大事故等対処設備が設置される重大事故等対処施設に適用する基準地震動Ssによる地震力は、水平2方向及び鉛直方向について適切に組み合わせるものとする。	IV-1-1 耐震設計の基本方針 2.耐震設計の基本方針 2.1 基本方針 (2)重大事故等対処施設	【2.1 基本方針(2) c.】 ・常設耐震重要重大事故等対処設備が設置される重大事故等対処施設に適用する基準地震動Ssによる地震力は、水平2方向及び鉛直方向について適切に組み合わせるものとする。	※補足すべき事項の対象なし
30	(d)常設耐震重要重大事故等対処設備以外の常設重大事故等対処設備が設置される重大事故等対処施設は、代替する機能を有する安全機能を有する施設が属する耐震重要度に適用される地震力に十分耐えることができる設計とする。また、代替する安全機能を有する施設がない常設重大事故等対処設備は、安全機能を有する施設の耐震設計における耐震重要度の分類の方針に基づき、重大事故等対処時の使用条件を踏まえて、当該設備の機能喪失により放射線による公衆への影響の程度に応じて分類し、その地震力に対し十分に耐えることができる設計とする。	IV-1-1 耐震設計の基本方針 2.耐震設計の基本方針 2.1 基本方針 (2)重大事故等対処施設	【2.1 基本方針(2) d.】 ・常設耐震重要重大事故等対処設備以外の常設重大事故等対処設備が設置される重大事故等対処施設については、設計基準事故に対処するための設備が有する機能を代替する施設の属する耐震重要度に応じた地震力に対し十分に耐えられる設計とする。 ・代替する安全機能を有する施設がない常設重大事故等対処設備は、安全機能を有する施設の耐震設計における耐震重要度の分類の方針に基づき、重大事故等対処時の使用条件を踏まえて、当該設備の機能喪失により放射線による公衆への影響の程度に応じて分類した地震力に対し十分に耐えられる設計とする。	※補足すべき事項の対象なし
30		IV-1-1 耐震設計の基本方針 10.耐震計算の基本方針	【10.耐震計算の基本方針】 ・耐震設計方針に基づいて設計した施設について、耐震計算を行うに当たり、既設工認で実績があり、かつ、最新の知見に照らしても妥当な手法及び条件を用いることを基本とする。 ・最新の知見を適用する場合は、その妥当性及び適用可能性を確認した上で適用する。 ・耐震計算における動的地震力の水平方向及び鉛直方向の組合せについては、水平1方向及び鉛直方向地震力の組合せで実施した上で、その計算結果に基づき水平2方向及び鉛直方向地震力の組合せが耐震性に及ぼす影響を評価する。 ・評価対象設備である配管系、機器(容器及びポンプ類)及び電気計装品(盤、装置及び器具)のうち、複数設備に共通して適用する計算方法については「IV-1-1-11-1 配管の耐震支持方針」、「IV-1-1-11-2 ダクトの耐震支持方針」及び「IV-1-2 耐震計算書作成の基本方針」に示す。	※補足すべき事項の対象なし
31	(e)常設耐震重要重大事故等対処設備が設置される重大事故等対処施設は、Bクラス及びCクラスの施設、常設耐震重要重大事故等対処設備以外の常設重大事故等対処設備が設置される重大事故等対処施設、可搬型重大事故等対処設備の波及的影響によって、その重大事故等に対処するために必要な機能を損なわない設計とする。	IV-1-1 耐震設計の基本方針 2.耐震設計の基本方針 2.1 基本方針 (2)重大事故等対処施設	【2.1 基本方針(2) e.】 ・常設耐震重要重大事故等対処設備が設置される重大事故等対処施設は、Bクラス及びCクラスの施設、常設耐震重要重大事故等対処設備以外の常設重大事故等対処設備が設置される重大事故等対処施設、可搬型重大事故等対処設備の波及的影響によって、重大事故等に対処するために必要な機能を損なわない設計とする。	※補足すべき事項の対象なし
31		IV-1-1 耐震設計の基本方針 6.構造計画と配置計画	【6.構造計画と配置計画】 ・安全機能を有する施設及び重大事故等対処施設の構造計画及び配置計画に際しては、地震の影響が低減されるように考慮する。 ・建物・構築物は、原則として剛構造とし、重要な建物・構築物は、地震力に対し十分な支持性能を有する地盤に支持させる。剛構造としない建物・構築物は、剛構造と同等又はそれを上回る耐震安全性を確保する。 ・耐震設計において地下水位の低下を期待する建物・構築物は、周囲の地下水を排出し、基礎スラブ底面レベル以下に地下水位を維持できるよう地下水排水設備(サブドレンポンプ、水位検出器等)を設置する。地下水排水設備は、安全機能を有する施設及び重大事故等対処施設に適用される要求事項を満足するよう設計する。また、上記より対象となる建物・構築物の評価に影響するため、建物・構築物の機能要求を満たすように、基準地震動Ssによる地震力に対して機能を維持するとともに、非常用電源設備又は基準地震動Ssによる地震力に対し機能維持が可能な発電機からの給電が可能な設計とすることとし、その評価を「IV-2-1 再処理設備本体等に係る耐震性に関する計算書」のうち地下水排水設備の耐震性についての計算書に示す。 ・機器・配管系は、応答性状を適切に評価し、適用する地震力に対して構造強度を有する設計とする。配置に自由度のあるものは、耐震上の観点からできる限り重心位置を低くし、かつ、安定性のよい据え付け状態になるよう、「9.機器・配管系の支持方針について」に示す方針に従い配置する。 ・下位クラス施設は、耐震重要施設及び常設耐震重要重大事故等対処施設に対して離隔を取り配置する、又は耐震重要施設の有する安全機能及び重大事故等に対処するために必要な機能を保持する設計とする。	<地下水排水設備> ⇒地下水排水設備に関する設計の考え方を示すため、地下水排水設備に関する設計内容について補足説明する。 ・[補足耐36]建物・構築物周辺の設計用地下水位の設定について
31		IV-1-1 耐震設計の基本方針 10.耐震計算の基本方針	【10.耐震計算の基本方針】 ・耐震設計方針に基づいて設計した施設について、耐震計算を行うに当たり、既設工認で実績があり、かつ、最新の知見に照らしても妥当な手法及び条件を用いることを基本とする。 ・最新の知見を適用する場合は、その妥当性及び適用可能性を確認した上で適用する。 ・耐震計算における動的地震力の水平方向及び鉛直方向の組合せについては、水平1方向及び鉛直方向地震力の組合せで実施した上で、その計算結果に基づき水平2方向及び鉛直方向地震力の組合せが耐震性に及ぼす影響を評価する。 ・評価対象設備である配管系、機器(容器及びポンプ類)及び電気計装品(盤、装置及び器具)のうち、複数設備に共通して適用する計算方法については「IV-1-1-11-1 配管の耐震支持方針」、「IV-1-1-11-2 ダクトの耐震支持方針」及び「IV-1-2 耐震計算書作成の基本方針」に示す。	※補足すべき事項の対象なし
32	(f)緊急時対策所の耐震設計の基本方針については、「(6)緊急時対策所」に示す。	IV-1-1 耐震設計の基本方針 2.耐震設計の基本方針 2.1 基本方針 (2)重大事故等対処施設	【2.1 基本方針(2) f.】 ・緊急時対策所の耐震設計における機能維持の基本方針については、「5.2 機能維持」に示す。	※補足すべき事項の対象なし
33	(g)常設耐震重要重大事故等対処設備が設置される重大事故等対処施設については、周辺地盤の変状により、重大事故等に対処するために必要な機能が損なわれるおそれがない設計とする。	IV-1-1 耐震設計の基本方針 2.耐震設計の基本方針 2.1 基本方針 (2)重大事故等対処施設	【2.1 基本方針(2) g.】 ・常設耐震重要重大事故等対処設備が設置される重大事故等対処施設については、周辺地盤の変状により、重大事故等に対処するために必要な機能が損なわれるおそれがない設計とする。 ・常設耐震重要重大事故等対処設備が設置される重大事故等対処のうちその周辺地盤の液状化のおそれがある施設は、その周辺地盤の液状化を考慮した場合においても、支持機能及び構造健全性が確保される設計とする。 ・これらの地盤の評価については、「IV-1-1-2 地盤の支持性能に係る基本方針」に示す。	※補足すべき事項の対象なし

補足説明すべき項目の抽出
(第五条（安全機能を有する施設の地盤）、第三十二条（重大事故等対処施設の地盤）、第六条、第三十三条（地震による損傷の防止））

基本設計方針	添付書類(1)	添付書類(2)	補足すべき事項
<p>(2) 耐震設計上の重要度分類及び重大事故等対処施設の設備分類 a. 安全機能を有する施設の耐震設計上の重要度分類 安全機能を有する施設の耐震重要度を以下のとおり分類する。</p>	<p>IV-1-1 耐震設計の基本方針 3. 耐震設計上の重要度分類及び重大事故等対処施設の設備分類 3.1 安全機能を有する施設の耐震設計上の重要度分類</p>	<p>【3.1 安全機能を有する施設の耐震設計上の重要度分類】 ・安全機能を有する施設の耐震設計上の重要度を以下のとおり分類する。</p>	<p>※補足すべき事項の対象なし</p>
<p>(a) Sクラスの施設 自ら放射性物質を内蔵している施設、当該施設に直接関係しておりその機能喪失により放射性物質を外部に拡散する可能性のある施設、放射性物質を外部に放出する可能性のある事態を防止するために必要な施設及び事故発生の際に、外部に放出される放射性物質による影響を低減させるために必要な施設であって、環境への影響が大きいもの。 イ. その破損又は機能喪失により臨界事故を起こすおそれのある施設 ロ. 使用済燃料を貯蔵するための施設 ハ. 高レベル放射性液体廃棄物を内蔵する系統及び機器並びにその冷却系統 ニ. プルトニウムを含む溶液を内蔵する系統及び機器 ホ. 上記ハ.及びニ.の系統及び機器から放射性物質が漏えいした場合に、その影響の拡大を防止するための施設 ヘ. 上記ハ., ニ.及びホ.に関連する施設で放射性物質の外部への放出を抑制するための施設 ト. 上記イ.からヘ.の施設の機能を確保するために必要な施設</p>	<p>IV-1-1 耐震設計の基本方針 3. 耐震設計上の重要度分類及び重大事故等対処施設の設備分類 3.1 安全機能を有する施設の耐震設計上の重要度分類 (1) Sクラスの施設</p>	<p>【3.1 安全機能を有する施設の耐震設計上の重要度分類(1)】 ・自ら放射性物質を内蔵している施設、当該施設に直接関係しておりその機能喪失により放射性物質を外部に拡散する可能性のある施設、放射性物質を外部に放出する可能性のある事態を防止するために必要な施設及び事故発生の際に、外部に放出される放射性物質による影響を低減させるために必要な施設であって、環境への影響が大きいもの。 a. その破損又は機能喪失により臨界事故を起こすおそれのある施設 b. 使用済燃料を貯蔵するための施設 c. 高レベル放射性液体廃棄物を内蔵する系統及び機器並びにその冷却系統 d. プルトニウムを含む溶液を内蔵する系統及び機器 e. 上記c.及びd.の系統及び機器から放射性物質が漏えいした場合に、その影響の拡大を防止するための施設 f. 上記c., d.及びe.に関連する施設で放射性物質の外部への放出を抑制するための施設 g. 上記a.からf.の施設の機能を確保するために必要な施設</p>	<p>※補足すべき事項の対象なし</p>
<p>(b) Bクラスの施設 安全機能を有する施設のうち、機能喪失した場合の影響がSクラスに属する施設と比べ小さい施設。 イ. 放射性物質を内蔵している施設であって、Sクラスに属さない施設(ただし内蔵量が少ないか又は貯蔵方式により、その破損により公衆に与える放射線の影響が十分小さいものは除く。) ロ. 放射性物質の放出を伴うような場合に、その外部放散を抑制するための施設で、Sクラスに属さない施設</p>	<p>IV-1-1 耐震設計の基本方針 3. 耐震設計上の重要度分類及び重大事故等対処施設の設備分類 3.1 安全機能を有する施設の耐震設計上の重要度分類 (2) Bクラスの施設</p>	<p>【3.1 安全機能を有する施設の耐震設計上の重要度分類(2)】 ・安全機能を有する施設のうち、機能喪失した場合の影響がSクラスに属する施設と比べ小さい施設。 a. 放射性物質を内蔵している施設であって、Sクラスに属さない施設(ただし内蔵量が少ないか又は貯蔵方式により、その破損により公衆に与える放射線の影響が十分小さいものは除く。) b. 放射性物質の放出を伴うような場合に、その外部放散を抑制するための施設で、Sクラスに属さない施設</p>	<p>※補足すべき事項の対象なし</p>
<p>(c) Cクラスの施設 Sクラスに属する施設及びBクラスに属する施設以外の一般産業施設又は公共施設と同等の安全性が要求される施設。</p>	<p>IV-1-1 耐震設計の基本方針 3. 耐震設計上の重要度分類及び重大事故等対処施設の設備分類 3.1 安全機能を有する施設の耐震設計上の重要度分類 (3) Cクラスの施設</p>	<p>【3.1 安全機能を有する施設の耐震設計上の重要度分類(3)】 ・Sクラスに属する施設及びBクラスに属する施設以外の一般産業施設又は公共施設と同等の安全性が要求される施設。</p>	<p>※補足すべき事項の対象なし</p>
<p>上記に基づく耐震設計上の重要度分類を第3.1.1-1表に示す。 なお、同表には当該施設を支持する建物・構築物の支持機能が維持されることを確認する地震動及び波及的影響を考慮すべき施設に適用する地震動についても併記する。</p>	<p>IV-1-1 耐震設計の基本方針 3. 耐震設計上の重要度分類及び重大事故等対処施設の設備分類 3.1 安全機能を有する施設の耐震設計上の重要度分類</p>	<p>【3.1 安全機能を有する施設の耐震設計上の重要度分類】 ・耐震設計上の重要度分類に基づく各施設の具体的な耐震設計上の重要度分類及び当該施設を支持する建造物の支持機能が維持されることを確認する地震動を「IV-1-1-3 重要度分類及び重大事故等対処施設の設備分類の基本方針」の第2.4-1表に、申請設備の耐震重要度分類について同添付書類の第2.4-2表に示す。</p>	<p>※補足すべき事項の対象なし</p>
<p>38</p>	<p>—</p>	<p>IV-1-1-3 重要度分類及び重大事故等対処施設の設備分類の基本方針 2. 安全機能を有する施設の耐震設計上の重要度分類</p>	<p>【2.1 耐震設計上の重要度分類】 ・安全機能を有する施設の耐震設計上の重要度を次のように分類する。</p>
<p>38</p>	<p>—</p>	<p>IV-1-1-3 重要度分類及び重大事故等対処施設の設備分類の基本方針 2. 安全機能を有する施設の耐震設計上の重要度分類 2.4 再処理施設の区分</p>	<p>【2.4 再処理施設の区分】 ・安全機能を有する施設の耐震重要度分類に対するクラス別施設を第2.4-1表に、安全機能を有する施設の申請設備の耐震重要度分類表を第2.4-2表に示す。 ・同表には、当該施設を支持する建物・構築物の支持機能が維持されることを確認する地震動及び波及的影響を考慮すべき設備に適用する地震動(以下「検討用地震動」という。)を併記する。</p>
<p>39</p>	<p>IV-1-1 耐震設計の基本方針 3. 耐震設計上の重要度分類及び重大事故等対処施設の設備分類 3.2 重大事故等対処施設の設備分類</p>	<p>【3.2 重大事故等対処施設の設備分類】 ・重大事故等対処設備について、施設の各設備が有する重大事故等に対処するために必要な機能及び設置状態を踏まえて、以下のとおり分類する。</p>	<p>※補足すべき事項の対象なし</p>
<p>40</p>	<p>IV-1-1 耐震設計の基本方針 3. 耐震設計上の重要度分類及び重大事故等対処施設の設備分類 3.2 重大事故等対処施設の設備分類 (1) 常設重大事故等対処設備</p>	<p>【3.2 重大事故等対処施設の設備分類(1)】 a. 常設耐震重要重大事故等対処設備 ・常設重大事故等対処設備であって、耐震重要施設に属する設計基準事故に対処するための設備が有する機能を代替するもの。 b. 常設耐震重要重大事故等対処設備以外の常設重大事故等対処設備 ・常設重大事故等対処設備であって、上記a.以外のもの。</p>	<p>※補足すべき事項の対象なし</p>

基本設計方針	添付書類(1)	添付書類(2)	添付書類(2)	補足すべき事項
上記に基づく重大事故等対処施設の設備分類について第3.1.1-2表に示す。 なお、同表には、重大事故等対処設備を支持する建物・構築物の支持機能が損なわれないことを確認する地震力についても併記する。	IV-1-1 耐震設計の基本方針 3. 耐震設計上の重要度分類及び重大事故等対処施設の設備分類 3.2 重大事故等対処施設の設備分類	【3.2 重大事故等対処施設の設備分類】 ・耐震設計上の分類に基づき耐震評価を行う申請設備の設備分類について「IV-1-1-3 重要度分類及び重大事故等対処施設の設備分類の基本方針」の第4.3-1表に示す。	-	※補足すべき事項の対象なし
(3) 地震力の算定方法 耐震設計に用いる設計用地震力は、以下の方法で算定される静的地震力及び動的地震力とする。	IV-1-1 耐震設計の基本方針 4. 設計用地震力 4.1 地震力の算定方法	【4.1 地震力の算定方法】 ・耐震設計に用いる地震力の算定は以下の方法による。	IV-1-1-3 重要度分類及び重大事故等対処施設の設備分類の基本方針 4. 重大事故等対処施設の設備分類 4.3 重大事故等対処施設の区分	※補足すべき事項の対象なし
	IV-1-1 耐震設計の基本方針 4. 設計用地震力 4.2 設計用地震力	【4.2 設計用地震力】 ・「4.1 地震力の算定方法」に基づく設計用地震力は「IV-1-1-8 機能維持の基本方針」に示す地震力に従い算定するものとする。	-	※補足すべき事項の対象なし
	IV-1-1 耐震設計の基本方針 4. 設計用地震力 4.1 地震力の算定方法 4.1.1 静的地震力	【4.1.1 静的地震力】 ・安全機能を有する施設に適用する静的地震力は、Sクラス、Bクラス及びCクラスの施設に適用することとし、それぞれの耐震重要度に応じて、以下の地震層せん断力係数C _i 及び震度に基づき算定するものとする。	IV-1-1-8 機能維持の基本方針 2. 機能維持の確認に用いる設計用地震力	※補足すべき事項の対象なし
a. 静的地震力 安全機能を有する施設に適用する静的地震力は、Sクラス、Bクラス及びCクラスの施設に適用することとし、それぞれの耐震重要度に応じて以下の地震層せん断力係数及び震度に基づき算定する。	IV-1-1 耐震設計の基本方針 4. 設計用地震力 4.1 地震力の算定方法 4.1.1 静的地震力	【4.1.1 静的地震力】 ・安全機能を有する施設に適用する静的地震力は、Sクラス、Bクラス及びCクラスの施設に適用することとし、それぞれの耐震重要度に応じて、以下の地震層せん断力係数C _i 及び震度に基づき算定するものとする。	-	※補足すべき事項の対象なし
重大事故等対処施設については、常設耐震重要重大事故等対処設備以外の常設重大事故等対処設備が設置される重大事故等対処施設に、代替する機能を有する安全機能を有する施設が属する耐震重要度に適用される地震力を適用する。	IV-1-1 耐震設計の基本方針 4. 設計用地震力 4.1 地震力の算定方法 4.1.1 静的地震力	【4.1.1 静的地震力】 ・重大事故等対処施設については、常設耐震重要重大事故等対処設備以外の常設重大事故等対処設備が設置される重大事故等対処施設に、代替する機能を有する安全機能を有する施設が属する耐震重要度分類のクラスに適用される地震力を適用する。	-	※補足すべき事項の対象なし
(a) 建物・構築物 水平地震力は、地震層せん断力係数C _i に、次に示す施設の耐震重要度に応じた係数を乗じ、さらに当該層以上の重量を乗じて算定するものとする。 Sクラス 3.0 Bクラス 1.5 Cクラス 1.0 ここで、地震層せん断力係数C _i は、標準せん断力係数C ₀ を0.2以上とし、建物・構築物の振動特性、地盤の種類等を考慮して求められる値とする。 また、必要保有水平耐力の算定においては、地震層せん断力係数C _i に乘じる施設の耐震重要度に応じた係数は、耐震重要度の各クラスともに1.0とし、その際に用いる標準せん断力係数C ₀ は1.0以上とする。 Sクラスの施設については、水平地震力と鉛直地震力が同時に不利な方向の組合せで作用するものとする。ただし、鉛直地震力は、震度0.3以上を基準とし、建物・構築物の振動特性及び地盤の種類等を考慮し、高さ方向に一定として求めた鉛直震度より算定する。	IV-1-1 耐震設計の基本方針 4. 設計用地震力 4.1 地震力の算定方法 4.1.1 静的地震力 (1) 建物・構築物	【4.1.1 静的地震力(1)】 ・水平地震力は、地震層せん断力係数C _i に、次に示す施設の耐震重要度に応じた係数を乗じ、さらに当該層以上の重量を乗じて算定するものとする。 Sクラス 3.0 Bクラス 1.5 Cクラス 1.0 ・地震層せん断力係数C _i は、標準せん断力係数C ₀ を0.2以上とし、建物・構築物の振動特性、地盤の種類等を考慮して求められる値とする。 ・必要保有水平耐力の算定においては、地震層せん断力係数C _i に乘じる施設の耐震重要度分類に応じた係数は、Sクラス、Bクラス及びCクラスともに1.0とし、その際に用いる標準せん断力係数C ₀ は1.0以上とする。 ・Sクラスの施設については、水平地震力と鉛直地震力が同時に不利な方向の組合せで作用するものとする。ただし、鉛直地震力は、震度0.3以上を基準とし、建物・構築物の振動特性及び地盤の種類等を考慮し、高さ方向に一定として求めた鉛直震度より算定する。	-	※補足すべき事項の対象なし
(b) 機器・配管系 耐震重要度の各クラスの地震力は、上記(a)に示す地震層せん断力係数C _i に施設の耐震重要度に応じた係数を乗じたものを水平震度とし、当該水平震度及び上記(a)の鉛直震度をそれぞれ20%増しとした震度より求めるものとする。 Sクラスの施設については、水平地震力と鉛直地震力は同時に不利な方向の組合せで作用するものとする。ただし、鉛直震度は高さ方向に一定とする。 上記(a)及び(b)の標準せん断力係数C ₀ 等の割増し係数については、耐震性向上の観点から、一般産業施設及び公共施設の耐震基準との関係を考慮して設定する。	IV-1-1 耐震設計の基本方針 4. 設計用地震力 4.1 地震力の算定方法 4.1.1 静的地震力 (2) 機器・配管系	【4.1.1 静的地震力(2)】 ・静的地震力は、上記(1)に示す地震層せん断力係数C _i に施設の耐震重要度に応じた係数を乗じたものを水平震度として、当該水平震度及び上記(1)の鉛直震度をそれぞれ20%増しとした震度より求めるものとする。 ・Sクラスの施設については、水平地震力と鉛直地震力は同時に不利な方向の組合せで作用するものとする。ただし、鉛直震度は高さ方向に一定とする。 ・上記(1)及び(2)の標準せん断力係数C ₀ 等の割増し係数については、耐震性向上の観点から、一般産業施設及び公共施設の耐震基準との関係を考慮して設定する。	-	※補足すべき事項の対象なし

補足説明すべき項目の抽出
(第五条（安全機能を有する施設の地盤）、第三十二条（重大事故等対処施設の地盤）、第六条、第三十三条（地震による損傷の防止））

基本設計方針	添付書類(1)	添付書類(2)	補足すべき事項
<p>47</p> <p>b. 動的地震力 安全機能を有する施設について、Sクラスの施設の設計に適用する動的地震力は、基準地震動S_s及び弾性設計用地震動S_dから定める入力地震動を適用する。 Bクラスの施設の設計のうち共振のおそれのある施設については、上記Sクラスの施設に適用する弾性設計用地震動S_dに2分の1を乗じたものから定める入力地震動を適用する。</p>	<p>IV-1-1 耐震設計の基本方針 4. 設計用地震力 4.1 地震力の算定方法 4.1.2 動的地震力</p>	<p>4.1.2 動的地震力 ・安全機能を有する施設については、動的地震力は、Sクラスの施設及びBクラスの施設のうち共振のおそれのあるものに適用する。 ・Sクラスの施設については、基準地震動S_s及び弾性設計用地震動S_dから定める入力地震動を適用する。 ・Bクラスの施設のうち共振のおそれのあるものについては、弾性設計用地震動S_dから定める入力地震動の振幅を2分の1にしたものによる地震力を適用する。</p>	<p>※補足すべき事項の対象なし</p>
<p>48</p> <p>重大事故等対処施設については、常設耐震重要重大事故等対処設備が設置される重大事故等対処施設に基準地震動S_sによる地震力を適用する。 常設耐震重要重大事故等対処設備以外の常設重大事故等対処設備が設置される重大事故等対処施設のうち、Bクラスに属する施設の機能を代替する施設であって共振のおそれのある施設については、「b. 動的地震力」に示す共振のおそれのあるBクラス施設に適用する地震力を適用する。 また、常設耐震重要重大事故等対処設備以外の常設重大事故等対処設備で、代替する安全機能を有する施設がない常設重大事故等対処設備のうち、Sクラスの施設は常設耐震重要重大事故等対処設備に適用する地震力を適用する。 なお、重大事故等対処施設のうち、安全機能を有する施設の基本構造と異なる施設については、適用する地震力に対して、要求される機能及び構造健全性が維持されることを確認するため、当該施設の構造を適切にモデル化した上での地震応答解析、加振試験等を実施する。</p>	<p>IV-1-1 耐震設計の基本方針 4. 設計用地震力 4.1 地震力の算定方法 4.1.2 動的地震力</p>	<p>4.1.2 動的地震力 ・重大事故等対処施設については、常設耐震重要重大事故等対処設備が設置される重大事故等対処施設に基準地震動S_sによる地震力を適用する。 ・常設耐震重要重大事故等対処設備以外の常設重大事故等対処設備が設置される重大事故等対処施設のうち、Bクラスの施設の機能を代替する共振のおそれのある施設については、共振のおそれのあるBクラス施設に適用する地震力を適用する。 ・常設耐震重要重大事故等対処設備以外の常設重大事故等対処設備で、代替する安全機能を有する施設がない常設重大事故等対処設備のうち、Sクラスの施設は常設耐震重要重大事故等対処設備に適用する地震力を適用する。 ・重大事故等対処施設のうち、安全機能を有する施設の基本構造と異なる施設については、適用する地震力に対して、要求される機能及び構造健全性が維持されることを確認するため、当該施設の構造を適切にモデル化した上での地震応答解析、加振試験等を実施する。</p>	<p>※補足すべき事項の対象なし</p>
<p>49</p> <p>安全機能を有する施設及び重大事故等対処施設の動的解析においては、地盤の諸定数も含めて材料のばらつきによる変動幅を適切に考慮する。</p>	<p>IV-1-1 耐震設計の基本方針 4. 設計用地震力 4.1 地震力の算定方法 4.1.2 動的地震力</p>	<p>4.1.2 動的地震力 ・安全機能を有する施設及び重大事故等対処施設の動的解析においては、地盤の諸定数も含めて材料のばらつきによる材料定数の変動幅を適切に考慮する。</p>	<p><地盤物性値の設定> ⇒地震応答解析に用いる地盤モデル及び地盤物性値に関する根拠を示すため、地盤モデル及び地盤物性値の設定内容について補足説明する。 ・[補足耐7]地震応答解析に用いる地盤モデル及び地盤物性値の設定について ・[補足耐8]竜巻防護対策設備の耐震性評価に関する補足説明 ⇒土木構造物の地震応答解析に用いる地盤物性値について補足説明する。 ・[補足耐47]土木構造物の耐震安全性評価における共通事項について</p> <p><材料物性のばらつき> ⇒動的解析における材料物性のばらつきの考慮に関する根拠を示すため、ばらつきの考慮に係る検討内容について補足説明する。 ・[補足耐9]地震応答解析における材料物性のばらつきに関する検討 ・[補足耐11]竜巻防護対策設備の地震応答解析における材料物性のばらつきに伴う影響評価について ・[補足耐49]土木構造物の地震応答解析における材料物性のばらつきに関する検討について ⇒建物、構築物の材料物性のばらつきの影響を考慮した応答に対する影響の確認方法及び影響確認結果について示す。 ・[補足耐10]地震応答解析における材料物性のばらつきに伴う影響確認について（機器・配管系）</p> <p><SRSS法の適用性> ⇒鉛直方向地震力の導入に伴うSRSS法の適用性について補足説明する。 ・[補足耐16]水平方向と鉛直方向の動的地震力の二乗和平方根(SRSS)法による組合せについて</p> <p><鉛直方向の動的地震力考慮における影響> ⇒鉛直方向地震力の導入により浮き上がり等の影響を受ける設備を抽出し、影響検討を行った結果について補足説明する。 ・[補足耐15]鉛直方向の動的地震力考慮による設備の浮き上がり等の影響について</p> <p><減衰定数の設定> ⇒地震応答解析に用いる減衰定数に関する根拠を示すため、減衰定数の設定内容について補足説明する。 ・[補足耐5]地震応答解析モデルに用いる鉄筋コンクリート造部の減衰定数に関する検討 ・[補足耐47]土木構造物の耐震安全性評価における共通事項について</p> <p><減衰定数の適用> ⇒施設の評価において適用する減衰定数のうち、最新知見として得られた減衰定数を用いることの妥当性、設備への適用性について補足説明する。 ・[補足耐6]新たに適用した減衰定数について</p>
<p>50</p> <p>動的地震力は、水平2方向及び鉛直方向について適切に組み合わせて算定する。水平2方向及び鉛直方向地震力の組合せによる影響確認に当たっては、水平1方向及び鉛直方向地震力を組み合わせた既往の耐震計算への影響が考えられる施設、設備の部位を抽出し、建物・構築物の3次元応答性状及びそれによる機器・配管系への影響を考慮した上で、既往の方法を用いた耐震性に及ぼす影響を評価する。</p>	<p>IV-1-1 耐震設計の基本方針 4. 設計用地震力 4.1 地震力の算定方法 4.1.2 動的地震力</p>	<p>4.1.2 動的地震力 ・動的地震力は、水平2方向及び鉛直方向について適切に組み合わせて算定する。水平2方向及び鉛直方向地震力の組合せによる影響確認に当たっては、水平1方向及び鉛直方向地震力を組み合わせた既往の耐震計算への影響が考えられる施設、設備の部位を抽出し、建物・構築物の3次元応答性状及びそれによる機器・配管系への影響を考慮した上で、既往の方法を用いた耐震性に及ぼす影響を評価する。その方針を「IV-1-1-7 水平2方向及び鉛直方向地震力の組合せに関する影響評価方針」に示す。</p>	<p><水平2方向及び鉛直方向地震力の組合せ> ⇒水平2方向及び鉛直方向地震力の組合せに関する影響評価にあたり、設備形状に応じた影響評価の内容について補足説明する。 ・[補足耐12]水平2方向及び鉛直方向地震力の組合せに関する設備の抽出及び考え方について</p> <p>⇒水平2方向及び鉛直方向地震力の組合せに関する影響評価に係る根拠を示すため、評価部位の抽出内容について補足説明する。 ・[補足耐13]水平2方向及び鉛直方向地震力の組合せに関する評価部位の抽出 ・[補足耐51]土木構造物の水平2方向及び鉛直方向地震力の組合せに関する影響評価について</p>

基本設計方針	添付書類(1)	添付書類(2)	補足すべき事項	
(a) 入力地震動 地質調査の結果によれば、重要な再処理施設の設置位置周辺は、新第三紀の鷹架層が十分な広がりをもって存在することが確認されている。 4.設計用地震力 4.1 地震力の算定方法 4.1.2 動的地震力 解放基盤表面は、この新第三紀の鷹架層のS波速度が0.7km/s以上を有する標高約-70mの位置に想定することとする。 基準地震動S _s 及び弾性設計用地震動S _d は、解放基盤表面で定義する。 建物・構築物の地震応答解析モデルに対する入力地震動は、解放基盤表面からの地震波の伝播特性を適切に考慮した上で、必要に応じて2次元FEM解析又は1次元波動論により、地震応答解析モデルの入力位置で評価した入力地震動を設定する。また、必要に応じて地盤の非線形応答に関する動的変形特性を考慮することとし、地盤のひずみに応じた地盤物性値を用いて作成する。非線形性の考慮に当たっては、地下水排水設備による地下水位の低下状態を踏まえ評価する。 地盤条件を考慮する場合には、地震動評価で考慮した敷地全体の地下構造との関係や対象建物・構築物の直下又は周辺の地質・速度構造の違いにも留意する。 また、必要に応じて敷地における観測記録による検証や最新の科学的・技術的知見を踏まえ、地質・速度構造等の地盤条件を設定する。	IV-1-1-1 耐震設計の基本方針 4.設計用地震力 4.1 地震力の算定方法 4.1.2 動的地震力	[4.1.2 動的地震力] (1) 入力地震動 ・地質調査の結果によれば、重要な再処理施設の設置位置周辺は、新第三紀の鷹架層が十分な広がりをもって存在することが確認されている。 解放基盤表面は、この新第三紀の鷹架層のS波速度が0.7km/s以上を有する標高約-70mの位置に想定することとする。 ・基準地震動S _s 及び弾性設計用地震動S _d は、解放基盤表面で定義する。 ・建物・構築物の地震応答解析モデルに対する入力地震動は、解放基盤表面からの地震波の伝播特性を適切に考慮した上で、必要に応じて2次元FEM解析又は1次元波動論により、地震応答解析モデルの入力位置で評価した入力地震動を設定する。また、必要に応じて地盤の非線形応答に関する動的変形特性を考慮することとし、地盤のひずみに応じた地盤物性値を用いて作成する。 ・非線形性の考慮に当たっては、地下水排水設備による地下水位の低下状態を踏まえ評価する。 ・入力地震動の設定に用いる地下構造モデルについては、地震動評価で考慮した敷地全体の地下構造及び対象建物・構築物の直下又は周辺の地質・速度構造の特徴を踏まえて適切に設定する。また、必要に応じて敷地における観測記録による検証や最新の科学的・技術的知見を踏まえ、地質・速度構造等の地盤条件を設定する。	※補足すべき事項の対象なし	
	-	IV-1-1-1 基準地震動S _s 及び弾性設計用地震動S _d の概要 5.敷地地盤の振動特性 5.1 解放基盤表面の設定	[5.1 解放基盤表面の設定] ・各種地質調査結果より、敷地の地盤は速度構造的に特異性を有する地盤ではないと考えられる。 解放基盤表面については、敷地地下で著しい高低差がなく、ほぼ水平で相当な拡がりを持ち、著しい風化を受けていない岩盤である鷹架層において、S波速度が概ね0.7km/s以上となる標高-70mの位置に設定した。	※補足すべき事項の対象なし
	-	IV-1-1-5 地震応答解析の基本方針 2.地震応答解析の方針 2.1建物・構築物 2.1.1 建物・構築物 (2.1.2に記載のものを除く。)	[2.1.1 建物・構築物(2.1.2に記載のものを除く。)](1) ・解放基盤表面は、S波速度が0.7km/s以上であるT.M.S.L.-70mとしている。 ・建物・構築物の地震応答解析における入力地震動は、解放基盤表面で定義される基準地震動S _s 及び弾性設計用地震動S _d を基に、対象建物・構築物の地盤条件を適切に考慮した上で、必要に応じて2次元FEM解析又は1次元波動論により、地震応答解析モデルの入力位置で評価した入力地震動を設定する。 ・建物・構築物の地震応答解析における入力地震動は、地震動評価で考慮した敷地全体の地下構造及び対象建物・構築物の直下又は周辺の地質・速度構造の特徴を踏まえて適切に設定した地下構造モデルを用いて設定するとともに、地盤の非線形応答に関する動的変形特性を考慮する。地盤の非線形特性の考慮に当たっては、地下水排水設備による地下水位の低下状態を踏まえ評価する。地盤の動的変形特性を考慮した入力地震動の算定に当たっては、地盤のひずみの大きさに応じて解析手法の適用性に留意する。更に必要に応じて敷地における観測記録による検証や最新の科学的・技術的知見を踏まえ、地質・速度構造等の地盤条件を設定する。 ・安全機能を有する施設における耐震Bクラスの建物・構築物及び重大事故等対処施設における耐震Bクラスの施設の機能を代替する常設重大事故等対処設備が設置される重大事故等対処施設の建物・構築物のうち共振のおそれがあり、動的解析が必要なものに対しては、弾性設計用地震動S _d を1/2倍したものを用いる。	<地盤物性値の設定> ⇒地震応答解析に用いる地盤モデル及び地盤物性値に関する根拠を示すため、地盤モデル及び地盤物性値の設定内容について補足説明する。 ・[補足耐7]地震応答解析に用いる地盤モデル及び地盤物性値の設定について ・[補足耐8]竜巻防護対策設備の耐震性評価に関する補足説明 ⇒土木構築物の地震応答解析に用いる地盤物性値について補足説明する。 ・[補足耐47]土木構築物の耐震安全性評価における共通事項について <材料物性のばらつき> ⇒動的解析における材料物性のばらつきの考慮に関する根拠を示すため、ばらつきの考慮に係る検討内容について補足説明する。 ・[補足耐9]地震応答解析における材料物性のばらつきに関する検討 ・[補足耐11]竜巻防護対策設備の地震応答解析における材料物性のばらつきに伴う影響評価について ・[補足耐49]土木構築物の地震応答解析における材料物性のばらつきに関する検討について ⇒建物・構築物の材料物性のばらつきの影響を考慮した応答に対する影響の確認方法及び影響確認結果について示す。 ・[補足耐10]地震応答解析における材料物性のばらつきに伴う影響確認について(機器、配管系)
	-	IV-1-1-5 地震応答解析の基本方針 2.地震応答解析の方針 2.1建物・構築物 2.1.2 屋外重要土木構築物 (1)入力地震動	[2.1.2 屋外重要土木構築物(1)] ・屋外重要土木構築物の地震応答解析における入力地震動は、解放基盤表面で定義される基準地震動S _s 及び弾性設計用地震動S _d を基に、対象構築物の地盤条件を適切に考慮した上で、必要に応じて2次元FEM解析又は1次元波動論により、地震応答解析モデルの入力位置で評価した入力地震動を設定する。地盤条件を考慮する場合には、地震動評価で考慮した敷地全体の地下構造との関係にも留意し、地盤の非線形応答に関する動的変形特性を考慮する。	<SRSS法の適用性> ⇒鉛直方向地震力の導入に伴うSRSS法の適用性について補足説明する。 ・[補足耐16]水平方向と鉛直方向の動的地震力の二乗和平方根(SRSS)法による組合せについて
	-	IV-1-1-5 地震応答解析の基本方針 2.地震応答解析の方針 2.2 機器・配管系 (1)入力地震動又は入力地震力	[2.2 機器・配管系(1)] ・機器・配管系の地震応答解析における入力地震動又は入力地震力は、基準地震動S _s 及び弾性設計用地震動S _d 又は当該機器・配管系の設置床における設計用床応答曲線若しくは時刻歴応答波とする。 ・建屋応答解析における各入力地震動が接地率に与える影響を踏まえ、誘発上下動を考慮するモデルを用いている場合については、鉛直方向の加速度応答時刻歴に誘発上下動を考慮することとする。 ・安全機能を有する施設における耐震Bクラスの機器・配管系及び重大事故等対処施設における耐震Bクラスの施設の機能を代替する常設耐震重要重大事故等対処設備以外の常設重大事故等対処設備が設置される重大事故等対処施設の機器・配管系のうち共振のおそれがあり、動的解析が必要なものに対しては、弾性設計用地震動S _d を基に線形解析により作成した設計用床応答曲線の応答加速度を2分の1倍したものを用いる。	※補足すべき事項の対象なし
Bクラスの施設及びBクラス施設の機能を代替する常設重大事故等対処設備が設置される重大事故等対処施設のうち共振のおそれがあり、動的解析が必要なものに対しては、弾性設計用地震動S _d に2分の1を乗じたものを用いる。	IV-1-1-1 耐震設計の基本方針 4.設計用地震力 4.1 地震力の算定方法 4.1.2 動的地震力	[4.1.2 動的地震力] ・Bクラスの施設のうち共振のおそれがあり、動的解析が必要なものに対しては、弾性設計用地震動S _d に2分の1を乗じたものを用いる。	※補足すべき事項の対象なし	
	-	IV-1-1-1 基準地震動S _s 及び弾性設計用地震動S _d の概要 5.敷地地盤の振動特性 5.1 解放基盤表面の設定	[5.1 解放基盤表面の設定] ・各種地質調査結果より、敷地の地盤は速度構造的に特異性を有する地盤ではないと考えられる。 解放基盤表面については、敷地地下で著しい高低差がなく、ほぼ水平で相当な拡がりを持ち、著しい風化を受けていない岩盤である鷹架層において、S波速度が概ね0.7km/s以上となる標高-70mの位置に設定した。	※補足すべき事項の対象なし
	-	IV-1-1-5 地震応答解析の基本方針 2.地震応答解析の方針 2.1建物・構築物 2.1.1 建物・構築物 (2.1.2に記載のものを除く。) (1)入力地震動	[2.1.1 建物・構築物(2.1.2に記載のものを除く。)](1) ・解放基盤表面は、S波速度が0.7km/s以上であるT.M.S.L.-70mとしている。 ・建物・構築物の地震応答解析における入力地震動は、解放基盤表面で定義される基準地震動S _s 及び弾性設計用地震動S _d を基に、対象建物・構築物の地盤条件を適切に考慮した上で、必要に応じて2次元FEM解析又は1次元波動論により、地震応答解析モデルの入力位置で評価した入力地震動を設定する。 ・建物・構築物の地震応答解析における入力地震動は、地震動評価で考慮した敷地全体の地下構造及び対象建物・構築物の直下又は周辺の地質・速度構造の特徴を踏まえて適切に設定した地下構造モデルを用いて設定するとともに、地盤の非線形応答に関する動的変形特性を考慮する。地盤の非線形特性の考慮に当たっては、地下水排水設備による地下水位の低下状態を踏まえ評価する。地盤の動的変形特性を考慮した入力地震動の算定に当たっては、地盤のひずみの大きさに応じて解析手法の適用性に留意する。更に必要に応じて敷地における観測記録による検証や最新の科学的・技術的知見を踏まえ、地質・速度構造等の地盤条件を設定する。 ・安全機能を有する施設における耐震Bクラスの建物・構築物及び重大事故等対処施設における耐震Bクラスの施設の機能を代替する常設耐震重要重大事故等対処設備以外の常設重大事故等対処設備が設置される重大事故等対処施設の機器・配管系のうち共振のおそれがあり、動的解析が必要なものに対しては、弾性設計用地震動S _d を1/2倍したものを用いる。	<地盤物性値の設定> ⇒地震応答解析に用いる地盤モデル及び地盤物性値に関する根拠を示すため、地盤モデル及び地盤物性値の設定内容について補足説明する。 ・[補足耐7]地震応答解析に用いる地盤モデル及び地盤物性値の設定について
	-	IV-1-1-5 地震応答解析の基本方針 2.地震応答解析の方針 2.1建物・構築物 2.1.2 屋外重要土木構築物 (1)入力地震動	[2.1.2 屋外重要土木構築物(1)] ・屋外重要土木構築物の地震応答解析における入力地震動は、解放基盤表面で定義される基準地震動S _s 及び弾性設計用地震動S _d を基に、対象構築物の地盤条件を適切に考慮した上で、必要に応じて2次元FEM解析又は1次元波動論により、地震応答解析モデルの入力位置で評価した入力地震動を設定する。地盤条件を考慮する場合には、地震動評価で考慮した敷地全体の地下構造との関係にも留意し、地盤の非線形応答に関する動的変形特性を考慮する。	<地盤物性値の設定> ⇒土木構築物の地震応答解析に用いる地盤物性値について補足説明する。 ・[補足耐47]土木構築物の耐震安全性評価における共通事項について
	-	IV-1-1-5 地震応答解析の基本方針 2.地震応答解析の方針 2.2 機器・配管系 (1)入力地震動又は入力地震力	[2.2 機器・配管系(1)] ・機器・配管系の地震応答解析における入力地震動又は入力地震力は、基準地震動S _s 及び弾性設計用地震動S _d 、又は当該機器・配管系の設置床における設計用床応答曲線若しくは時刻歴応答波とする。 ・建屋応答解析における各入力地震動が接地率に与える影響を踏まえ、誘発上下動を考慮するモデルを用いている場合については、鉛直方向の加速度応答時刻歴に誘発上下動を考慮することとする。 ・安全機能を有する施設における耐震Bクラスの機器・配管系及び重大事故等対処施設における耐震Bクラスの施設の機能を代替する常設耐震重要重大事故等対処設備以外の常設重大事故等対処設備が設置される重大事故等対処施設の機器・配管系のうち共振のおそれがあり、動的解析が必要なものに対しては、弾性設計用地震動S _d を基に線形解析により作成した設計用床応答曲線の応答加速度を2分の1倍したものを用いる。	※補足すべき事項の対象なし

基本設計方針	添付書類(1)	添付書類(2)	補足すべき事項
<p>(h) 動的解析法 イ、建物・構築物 動的解析に当たっては、対象施設の形状、構造特性、振動特性等を踏まえ、地震応答解析手法の適用性及び適用限界等を考慮のうえ、適切な解析法を選定するとともに、建物・構築物に応じて十分な調査に基づく適切な解析条件を設定する。動的解析は、原則として、時刻歴応答解析法を用いて求めるものとする。</p> <p>また、3次元応答性状等の評価は、線形解析に適用可能な周波数応答解析法による。建物・構築物の動的解析に当たっては、建物・構築物の剛性はそれらの形状、構造特性、振動特性、減衰特性を十分考慮して評価し、集中質点系に置換した解析モデルを設定する。動的解析には、建物・構築物と地盤の相互作用及び埋込み効果を考慮するものとし、解析モデルの地盤のばね定数は、基礎版の平面形状、地盤の剛性等を考慮して定める。地盤の剛性等については、必要に応じて地盤の非線形応答を考慮することとし、地盤のひずみに応じた地盤物性値に基づくものとする。設計用地盤定数の設定に当たっては、地盤の構造特性の考慮として、地震動評価で考慮した敷地全体の地下構造との関係や対象建物・構築物の直下又は周辺の地質・速度構造の違いにも留意し、原則として、弾性波試験によるものを用いる。</p> <p>地盤－建物・構築物連成系の減衰定数は、振動エネルギーの地下逸散及び地震応答における各部のひずみレベルを考慮して定める。基準地震動S_s及び弾性設計用地震動S_dに対する応答解析において、主要構造要素がある程度以上弾性範囲を超える場合には、実験等の結果に基づき、該当する建物部分の構造特性に応じて、その弾塑性挙動を適切に模擬した復元力特性を考慮した応答解析を行う。</p> <p>また、Sクラスの施設を支持する建物・構築物及び常設耐震重要重大事故等対処設備が設置される重大事故等対処施設を支持する建物・構築物の支持機能を検討するための動的解析において、当該施設を支持する建物・構築物の主要構造要素がある程度以上弾性範囲を超える場合には、その弾塑性挙動を適切に模擬した復元力特性を考慮した応答解析を行う。</p> <p>地震応答解析に用いる材料定数については、地盤の諸定数も含めて材料のばらつきによる変動幅を適切に考慮する。また、材料のばらつきによる変動が建物・構築物の振動性状や応答性状に及ぼす影響として考慮すべき要因を選定した上で、選定された要因を考慮した動的解析により設計用地震力を設定する。</p>	<p>IV-1-1-1 耐震設計の基本方針 4. 設計用地震力 4.1 地震力の算定方法 4.1.2 動的地震力</p> <p>IV-1-1-1 耐震設計の基本方針 10. 耐震計算の基本方針 10.1 建物・構築物</p> <p>IV-1-1-5 地震応答解析の基本方針 2. 地震応答解析の方針 2.1 建物・構築物 2.1.1 建物・構築物 (2.1.2に記載のものを除く。)</p> <p>IV-1-1-5 地震応答解析の基本方針 2. 地震応答解析の方針 2.1 建物・構築物 2.1.2 屋外重要土木構築物 (2) 解析方法及び解析モデル</p> <p>IV-1-1-1 耐震設計の基本方針 10. 耐震計算の基本方針 10.1 建物・構築物</p> <p>IV-1-1-5 地震応答解析の基本方針 2. 地震応答解析の方針 2.1 建物・構築物 2.1.1 建物・構築物 (2.1.2に記載のものを除く。)</p> <p>IV-1-1-5 地震応答解析の基本方針 2. 地震応答解析の方針 2.1 建物・構築物 2.1.2 屋外重要土木構築物 (2) 解析方法及び解析モデル</p>	<p>—</p> <p>—</p> <p>IV-1-1-5 地震応答解析の基本方針 2. 地震応答解析の方針 2.1 建物・構築物 2.1.1 建物・構築物 (2.1.2に記載のものを除く。)</p> <p>IV-1-1-5 地震応答解析の基本方針 2. 地震応答解析の方針 2.1 建物・構築物 2.1.2 屋外重要土木構築物 (2) 解析方法及び解析モデル</p> <p>—</p> <p>—</p> <p>IV-1-1-5 地震応答解析の基本方針 2. 地震応答解析の方針 2.1 建物・構築物 2.1.1 建物・構築物 (2.1.2に記載のものを除く。)</p> <p>IV-1-1-5 地震応答解析の基本方針 2. 地震応答解析の方針 2.1 建物・構築物 2.1.2 屋外重要土木構築物 (2) 解析方法及び解析モデル</p>	<p><既設工認と今回設工認の解析モデル及び手法の比較> ⇒地震応答解析及び応力解析における解析モデルの設定根拠を示すため、既設工認と今回設工認の解析モデル及び手法の比較について補足説明する。</p> <p>・【補足耐31】地震応答解析及び応力解析における既設工認と今回設工認の解析モデル及び手法の比較 ・【補足耐46】土木構築物の地震応答解析における既設工認と今回設工認の解析モデル及び手法の比較について</p> <p><地盤ばね、スケルトンカーブの設定> ⇒地震応答解析に用いる地盤ばね、スケルトンカーブに関する根拠を示すため、地盤ばね、スケルトンカーブの設定内容について補足説明する。</p> <p>・【補足耐32】「建屋側面地盤ばね」及び「地盤のひずみ依存特性」の評価手法について ・【補足耐33】地震応答解析における耐震壁のせん断スケルトンカーブの設定</p> <p><隣接建屋の影響> ⇒隣接建屋の影響検討に関する根拠を示すため、隣接建屋の検討方法等の内容について補足説明する。</p> <p>・【補足耐34】隣接建屋の影響に関する検討(建物、屋外機械基礎) ⇒隣接建屋の影響を考慮した応答に対する検討内容及び影響検討結果について補足説明する。</p> <p>・【補足耐35】隣接建屋の影響に対する影響確認について(機器・配管系)</p> <p><液状化による影響> ⇒液状化による影響評価に関する根拠を示すため、設計用地下水位の設定内容、液状化による影響評価内容及び液状化の評価条件となるパラメータについて補足説明する。</p> <p>・【補足耐50】土木構築物の液状化の影響評価について ・【補足耐36】建物・構築物周辺の設計用地下水位の設定について ・【補足耐51】地盤の支持性能について ⇒液状化による影響について設計用床応答曲線と液状化影響を考慮した床応答曲線との比較等、影響確認結果について補足説明する。</p> <p>・【補足耐3】土木構築物の液状化に伴う機電設備の影響評価について</p>
<p>建物・構築物の動的解析においては、地下水排水設備による地下水位の低下を考慮して適切な解析手法を選定する。ここで、地震時の地盤の有効応力の変化に応じた影響を考慮する場合は、有効応力解析を実施する。有効応力解析に用いる液状化強度特性は、敷地の原地盤における代表性及び網羅性を踏まえた上で保守性を考慮して設定することを基本とする。</p>	<p>IV-1-1-1 耐震設計の基本方針 10. 耐震計算の基本方針 10.1 建物・構築物</p> <p>IV-1-1-5 地震応答解析の基本方針 2. 地震応答解析の方針 2.1 建物・構築物 2.1.1 建物・構築物 (2.1.2に記載のものを除く。)</p>	<p>—</p> <p>—</p>	<p><既設工認と今回設工認の解析モデル及び手法の比較> ⇒地震応答解析及び応力解析における解析モデルの設定根拠を示すため、既設工認と今回設工認の解析モデル及び手法の比較について補足説明する。</p> <p>・【補足耐31】地震応答解析及び応力解析における既設工認と今回設工認の解析モデル及び手法の比較 ・【補足耐46】土木構築物の地震応答解析における既設工認と今回設工認の解析モデル及び手法の比較について</p> <p><地盤ばね、スケルトンカーブの設定> ⇒地震応答解析に用いる地盤ばね、スケルトンカーブに関する根拠を示すため、地盤ばね、スケルトンカーブの設定内容について補足説明する。</p> <p>・【補足耐32】「建屋側面地盤ばね」及び「地盤のひずみ依存特性」の評価手法について ・【補足耐33】地震応答解析における耐震壁のせん断スケルトンカーブの設定</p> <p><隣接建屋の影響> ⇒隣接建屋の影響検討に関する根拠を示すため、隣接建屋の検討方法等の内容について補足説明する。</p> <p>・【補足耐34】隣接建屋の影響に関する検討(建物、屋外機械基礎) ⇒隣接建屋の影響を考慮した応答に対する検討内容及び影響検討結果について補足説明する。</p> <p>・【補足耐35】隣接建屋の影響に対する影響確認について(機器・配管系)</p> <p><液状化による影響評価> ⇒液状化による影響評価に関する根拠を示すため、設計用地下水位の設定内容、液状化による影響評価内容及び液状化の評価条件となるパラメータについて補足説明する。</p> <p>・【補足耐50】土木構築物の液状化の影響評価について ・【補足耐36】建物・構築物周辺の設計用地下水位の設定について ・【補足耐51】地盤の支持性能について ⇒液状化による影響について設計用床応答曲線と液状化影響を考慮した床応答曲線との比較等、影響確認結果について補足説明する。</p> <p>・【補足耐3】土木構築物の液状化に伴う機電設備の影響確認について</p>
<p>動的解析に用いる解析モデルは、地震観測網により得られた観測記録により振動性状の把握を行い、解析モデルの妥当性の確認を行う。</p>	<p>IV-1-1-1 耐震設計の基本方針 4. 設計用地震力 4.1 地震力の算定方法 4.1.2 動的地震力</p> <p>IV-1-1-5 地震応答解析の基本方針 2. 地震応答解析の方針 2.1 建物・構築物 2.1.1 建物・構築物 (2.1.2に記載のものを除く。)</p>	<p>—</p> <p>—</p>	<p>※補足すべき事項の対象なし</p> <p>※補足すべき事項の対象なし</p>
<p>動的解析に用いる解析モデルは、地震観測網により得られた観測記録により振動性状の把握を行い、解析モデルの妥当性の確認を行う。</p>	<p>IV-1-1-1 耐震設計の基本方針 4. 設計用地震力 4.1 地震力の算定方法 4.1.2 動的地震力</p> <p>IV-1-1-5 地震応答解析の基本方針 2. 地震応答解析の方針 2.1 建物・構築物 2.1.1 建物・構築物 (2.1.2に記載のものを除く。)</p>	<p>—</p> <p>—</p>	<p>※補足すべき事項の対象なし</p> <p>※補足すべき事項の対象なし</p>

補足説明すべき項目の抽出
(第五条 (安全機能を有する施設の地盤)、第三十二条 (重大事故等対処施設の地盤)、第六条、第三十三条 (地震による損傷の防止))

基本設計方針	添付書類(1)		添付書類(2)	補足すべき事項
<p>建物・構築物のうち土木構造物の動的解析に当たっては、構造物と地盤の相互作用を考慮できる連成系の地震応答解析手法を用いる。地震応答解析手法は、地盤及び構築物の地震時における非線形挙動の有無や程度に応じて、線形、等価線形又は非線形解析のいずれかによる。地盤の地震応答解析モデルは、構造物と地盤の動的相互作用を考慮できる有限要素法を用いる。構造物の地震応答解析に用いる減衰定数については、地盤と構築物の非線形性を考慮して適切に設定する。</p>	<p>IV-1-1 耐震設計の基本方針 10. 耐震計算の基本方針 10.1 建物・構築物</p>	-	-	<p><既設工認と今回設工認の解析モデル及び手法の比較> ⇒地震応答解析及び応力解析における解析モデルの設定根拠を示すため、既設工認と今回設工認の解析モデル及び手法の比較について補足説明する。 ・[補足耐31]地震応答解析及び応力解析における既設工認と今回設工認の解析モデル及び手法の比較 ・[補足耐46]土木構造物の地震応答解析における既設工認と今回設工認の解析モデル及び手法の比較について</p> <p><地盤ばね、スケルトンカーブの設定> ⇒地震応答解析に用いる地盤ばね、スケルトンカーブに関する根拠を示すため、地盤ばね、スケルトンカーブの設定内容について補足説明する。 ・[補足耐32]「建屋側面地盤ばね」及び「地盤のひずみ依存特性」の評価手法について ・[補足耐33]地震応答解析における耐震壁のせん断スケルトンカーブの設定</p> <p><液状化による影響評価> ⇒液状化による影響評価に関する根拠を示すため、設計用地下水位の設定内容、液状化による影響評価内容及び液状化の評価条件となるパラメータについて補足説明する。 ・[補足耐50]土木構造物の液状化の影響評価について ・[補足耐36]建物・構築物周辺の設計用地下水位の設定について ・[補足耐51]地盤の支持性能について</p>
<p>地震力については、水平2方向及び鉛直方向について適切に組み合わせる算定する。</p>	<p>IV-1-1 耐震設計の基本方針 4. 設計用地震力 4.1 地震力の算定方法 4.1.2 動的地震力</p>	-	-	<p><水平2方向及び鉛直方向地震力の組合せ> ⇒水平2方向及び鉛直方向地震力の組合せに関する影響評価にあたり、設備形状に応じた影響評価の内容について補足説明する。 ・[補足耐12]水平2方向及び鉛直方向地震力の組合せに関する設備の抽出及び考え方について ⇒水平2方向及び鉛直方向地震力の組合せに関する影響評価に係る根拠を示すため、評価部位の抽出内容について補足説明する。 ・[補足耐13]水平2方向及び鉛直方向地震力の組合せに関する評価部位の抽出 ・[補足耐51]土木構造物の水平2方向及び鉛直方向地震力の組合せに関する影響評価について</p>
<p>ロ、機器・配管系 動的解析による地震力の算定に当たっては、地震応答解析手法の適用性、適用限界等を考慮のうえ、適切な解析法を選定するとともに、解析条件として考慮すべき減衰定数、剛性等の各種物性値は、適切な規格及び基準又は試験等の結果に基づき設定する。</p>	<p>IV-1-1 耐震設計の基本方針 10. 耐震計算の基本方針 10.2 機器・配管系</p>	-	-	<p><S d 評価結果の記載方法> ⇒S クラス施設の耐震計算書における S d 評価結果の記載方法について補足説明する。 ・[補足耐20]耐震 S クラス設備の耐震計算書における S d 評価結果の記載方法</p> <p><固有周期の算出> ⇒固有周期を算出せず剛とみなしている設備の固有周期について補足説明する。 ・[補足耐37]剛な設備の固有周期の算出について</p> <p><機器・配管系の類型化> 既設工認時の評価内容及び説明内容を踏まえ機器、配管系に対する類型化の分類の考え方について補足説明する。 ・[補足耐38]機器・配管系の類型化に対する分類の考え方について</p> <p><耐震計算書の作成方針> ⇒機電設備の耐震計算書の作成方針について構成、記載方法、記載の留意点等について補足説明する。 ・[補足耐39]機電設備の耐震計算書の作成について</p> <p><既設工認からの変更点> ⇒機器の耐震計算書作成の基本方針の変更点として、定型式への最新知見の反映等の考え方について補足説明する。 ・[補足耐41]機器の耐震計算における既設工認からの計算式の変更点について ⇒耐震設計における既設工認から評価内容の評価条件等の変更内容について補足 ・[補足耐42]既設工認からの変更点について</p>
-	-	-	<p>IV-1-1-5 地震応答解析の基本方針 2. 地震応答解析の方針 2.2 機器・配管系(2)解析方法及び解析モデル</p>	<p>※補足すべき事項の対象なし</p>
-	-	-	<p>IV-1-1-6 設計用床応答曲線の作成方針 1. 概要</p> <p>IV-1-1-6 別紙 各施設の設計用床応答曲線 【1.概要】 ・各施設の機器・配管系の耐震設計に用いる各床面の静的震度、最大床応答加速度及び設計用床応答曲線について示す。</p>	<p>※補足すべき事項の対象なし</p>

基本設計方針	添付書類(1)	添付書類(2)	補足すべき事項
<p>機器については、形状、構造特性等を考慮して、代表的な振動モードを適切に表現できるよう質点系モデル、有限要素モデル等に置換し、設計用床応答曲線を用いたスペクトルモーダル解析法又は時刻歴応答解析法により応答を求める。</p> <p>また、時刻歴応答解析法及びスペクトルモーダル解析法を用いる場合は地盤物性等のばらつきを適切に考慮する。スペクトルモーダル解析法には地盤物性等のばらつきを考慮した床応答曲線を用いる。配管系については、適切なモデルを作成し、設計用床応答曲線を用いたスペクトルモーダル解析法により応答を求める。</p> <p>スペクトルモーダル解析法及び時刻歴応答解析法の選択に当たっては、衝突・すべり等の非線形現象を模擬する観点又は既往研究の知見を取り入れ実機の挙動を模擬する観点で、建物・構築物の剛性及び地盤物性のばらつきへの配慮をしつつ時刻歴応答解析法を用いる等、解析対象とする現象、対象設備の振動特性・構造特性等を考慮し適切に選定する。</p> <p>また、設備の3次元的な広がりや踏まえ、適切に応答を評価できるモデルを用い、水平2方向及び鉛直方向の応答成分について適切に組み合わせるものとする。</p> <p>なお、剛性の高い機器・配管系は、その設置床面の最大床応答加速度の1.2倍の加速度を静的に作用させて地震力を算定する。</p>	<p>IV-1-1 耐震設計の基本方針</p> <p>10. 耐震計算の基本方針</p> <p>10.2 機器・配管系</p> <p>【10.2 機器・配管系】</p> <ul style="list-style-type: none"> ・機器・配管系の評価は、「4.設計用地震力」で示す設計用地震力による適切な応力解析に基づいた地震応力と、組み合わせるべき他の荷重による応力との組合せ応力が「5.機能維持の基本方針」で示す許容限界内にあることを確認すること(解析による設計)により行う。 ・評価手法は、以下に示す解析法によりJEAG4601に基づき実施することを基本とし、その他の手法を適用する場合は適用性を確認の上適用することとする。なお、時刻歴応答解析法及びスペクトルモーダル解析法を用いる場合は、材料物性のばらつき等を適切に考慮する。 <ul style="list-style-type: none"> ・スペクトルモーダル解析法 ・時刻歴応答解析法 ・定式化された計算式を用いた解析法 ・FEM等を用いた応力解析法 ・機器・配管系については、解析方法及び解析モデルを機器、配管系ごとに設定するとともに、安全機能に応じた評価を行う。 ・これら機器、配管系ごとに適用する解析方法及び解析モデルを「IV-1-1-5 地震応答解析の基本方針」に示す。 ・具体的な評価手法は、「IV-1-1-10 機器の耐震支持方針」、「IV-1-1-11-1 配管の耐震支持方針」、「IV-1-1-11-2 ダクトの耐震支持方針」、「IV-1-2 耐震計算書作成の基本方針」及び「IV-2 再処理施設の耐震性に関する計算書」に示す。 ・地震時及び地震後に機能維持が要求される設備については、地震応答解析により機器・配管系に作用する加速度が振動試験又は解析等により機能が維持できることを確認した加速度(動的機能維持確認済加速度又は電氣的機能維持確認済加速度)以下、若しくは、静的又は動的解析により求まる地震荷重が許容荷重以下となることを確認する。 ・水平2方向及び鉛直方向地震力の組合せに関する影響評価については、「IV-2-3 水平2方向及び鉛直方向地震力の組合せに関する影響評価結果」に示す。 	<p>-</p>	<p>< S d 評価結果の記載方法 > ⇒ S クラス施設の耐震計算書における S d 評価結果の記載方法について補足説明する。 ・ [補足耐20] 耐震 S クラス設備の耐震計算書における S d 評価結果の記載方法</p> <p>< 固有周期の算出 > ⇒ 固有周期を算出せず剛とみなしている設備の固有周期について補足説明する。 ・ [補足耐37] 剛な設備の固有周期の算出について</p> <p>< 機器・配管系の類型化 > 機器・配管系の類型化の分類について補足説明する。 ・ [補足耐38] 機器・配管系の類型化に対する分類の考え方について</p> <p>< 耐震計算書の作成方針 > ⇒ 機電設備の耐震計算書の作成方針について補足説明する。 ・ [補足耐39] 機電設備の耐震計算書の作成について</p> <p>< 配管系の評価手法 > ⇒ 配管系の耐震評価における配管の評価手法として既設工認にて設定した標準支持間隔に対する対応等について補足説明する。 ・ [補足耐40] 配管系の評価手法(定ピッチスパン法)について</p>
<p>-</p>	<p>-</p>	<p>IV-1-1-5 地震応答解析の基本方針</p> <p>2. 地震応答解析の方針</p> <p>2.2 機器・配管系(2) 解析方法及び解析モデル</p> <p>【2.2 機器・配管系(2)】</p> <ul style="list-style-type: none"> ・動的解析による地震力の算定に当たっては、地震応答解析手法の適用性及び適用限界等を考慮の上、適切な解析法を選定するとともに、解析条件として考慮すべき減衰定数、剛性等の各種物性値は、適切な規格・基準、あるいは実験等の結果に基づき設定する。 ・機器の解析に当たっては、形状、構造特性等を考慮して、代表的な振動モードを適切に表現できるような質点系モデル、はりやシェル等の要素を使用した有限要素モデル等に置換し、設計用床応答曲線を用いたスペクトルモーダル解析法又は時刻歴応答解析法により応答を求める。 ・配管系については、適切なモデルを作成し、設計用床応答曲線を用いたスペクトルモーダル解析法又は時刻歴応答解析法により応答を求める。 ・スペクトルモーダル解析法又は時刻歴応答解析法を用いる場合は材料物性のばらつき等を適切に考慮する。 ・スペクトルモーダル解析法及び時刻歴応答解析法の選択に当たっては、衝突・すべり等の非線形現象を模擬する観点又は既往研究の知見を取り入れ実機の挙動を模擬する観点で、材料物性のばらつき等への配慮を考慮しつつ時刻歴応答解析法を用いる等、解析対象とする現象、対象設備の振動特性・構造特性等を考慮し適切に選定する。 ・3次元的な広がりを持つ設備については、3次元的な配置を踏まえ、適切にモデル化し、水平2方向及び鉛直方向の応答成分について適切に組み合わせるものとする。具体的な方針については「IV-1-1-7 水平2方向及び鉛直方向地震力の組合せに関する影響評価方針」に示す。 ・剛性の高い機器・配管系は、その機器・配管系の設置床面の最大床応答加速度の1.2倍の加速度を震度として作用させて構造強度評価に用いる地震力を算定する。 ・機器、配管系の評価については、これら解析方法及び解析モデルに応じた評価を行う。機器、配管系の評価手法について、「IV-1-1-11-1 配管の耐震支持方針」、「IV-1-1-11-2 ダクトの耐震支持方針」及び「IV-1-2 耐震計算書作成の基本方針」に示す。 	<p>< 既設工認からの変更点 > ⇒ 既設工認からの変更点について補足説明する。 ・ [補足耐41] 機器の耐震計算における既設工認からの計算式の変更点について ・ [補足耐42] 既設工認からの変更点について</p>
<p>-</p>	<p>-</p>	<p>IV-1-1-6 設計用床応答曲線の作成方針</p> <p>2. 床応答スペクトルに係る基本方針及び作成方法</p> <p>2.1 基本方針</p> <p>【2.1 基本方針】</p> <ul style="list-style-type: none"> ・床応答スペクトルに対し、各再処理施設の固有周期のシフトを考慮し、周期方向に±10%の拡幅を行い、設計用床応答曲線とする。 	<p>-</p>
<p>-</p>	<p>IV-1-1-10 機器の耐震支持方針</p> <p>2. 機器の支持構造物</p> <p>2.1 基本原則</p> <p>【2.1 基本原則】</p> <ul style="list-style-type: none"> ・機器の耐震支持方針は下記によるものとする。 (1) 重要な機器は岩盤上に設けた強固な基礎又は岩盤により支持され十分耐震性を有する建物・構築物内の基礎上に設置する。 (2) 支持構造物を含め十分剛構造とすることで建物・構築物との共振を防止する。 (3) 剛性を十分に確保できない場合は、機器系の振動特性に応じた地震応答解析により、応力評価に必要な荷重等を算定し、その荷重等に耐える設計とする。 (4) 重心位置を低くおさえる。 (5) 配管反力をできる限り機器にもたせない構造とする。 (6) 偏心荷重を避ける。 (7) 高温機器は熱膨張を拘束しない構造とする。 (8) 動的機能が要求されるものについては地震時に機能を喪失しない構造とする。 (9) 内部構造物については容器との相互作用を考慮した構造とする。 (10) 支持架構上に設置される機器については、原則として架構を十分剛に設計する。剛ではない場合は、架構の剛性を考慮した地震荷重等に耐える設計とするとともに、剛ではない架構に設置される機器については、架構の剛性を考慮した地震応答解析を行う。解析に当たっては、設計用床応答曲線又は時刻歴応答波を用いて耐震性の確認を行うものとし、そのうち時刻歴応答波については、実機の挙動をより模擬する場合に用いる。 	<p>-</p>	<p>-</p>
<p>-</p>	<p>IV-1-1-11-1 配管の耐震支持方針</p> <p>1. 配管の耐震支持方針</p> <p>1.1 概要</p> <p>1.3 配管の設計</p> <p>1.3.2 多質点系はりモデルを用いた評価方法</p> <p>【1.3.2 多質点系はりモデルを用いた評価方法】</p> <ul style="list-style-type: none"> ・多質点系はりモデルを用いた評価方法では、原則として固定点から固定点までを独立した1つのブロックとして、地震荷重、自重、熱荷重等により配管に生じる応力が許容応力以下となるように配管経路及び支持方法を定める。 	<p>-</p>	<p>-</p>
<p>-</p>	<p>IV-1-1-11-1 配管の耐震支持方針</p> <p>1. 配管の耐震支持方針</p> <p>1.1 概要</p> <p>1.3 配管の設計</p> <p>1.3.3 標準支持間隔を用いた評価方法</p> <p>【1.3.3 標準支持間隔を用いた評価方法】</p> <ul style="list-style-type: none"> ・標準支持間隔法による配管の耐震計算は、配管を直管部、曲がり部、集中質量部、分岐部、Z形部、門形部及び分岐+曲がり部の各要素に分類し、要素ごとに許容値を満足する最大の支持間隔を算出する。 	<p>-</p>	<p>-</p>
<p>-</p>	<p>IV-1-1-11-2 ダクトの耐震支持方針</p> <p>4. ダクト設計の基本方針</p> <p>4.4 ダクト支持点の設計方法</p> <p>4.4.1 標準支持間隔を用いた評価方法</p> <p>【4.4.1 標準支持間隔を用いた評価方法】</p> <ul style="list-style-type: none"> ・静的震度、1.2ZPA及び設計用床応答曲線から地震力を算定し、ダクトに生じる曲げモーメントが許容座屈曲げモーメント以下となるように支持間隔を算定する。 	<p>-</p>	<p>-</p>
<p>-</p>	<p>IV-1-1-12 電気計測制御装置等の耐震支持方針</p> <p>3. 電気計測制御装置等の耐震設計方針</p> <p>3.3 耐震設計の手順</p> <p>3.3.4 電路類の耐震設計手順</p> <p>【3.3.4 電路類の耐震設計手順】</p> <ul style="list-style-type: none"> ・構造的に健全ならば機能が維持されるので構造的検討のみを行う。この際には多質点系はりモデルによる解析又は標準支持間隔法を用いる。多質点系はりモデルによる解析の場合は、固有振動数に応じて応答解析による方法、又は静的解析による方法を用いて構造的健全性を確認する方針とする。 ・標準支持間隔法を用いる場合は、静的又は動的な地震力による応力が許容応力以下となる標準支持間隔を設定し、標準支持間隔以内で支持することにより耐震性を確保する。 	<p>-</p>	<p>-</p>

基本設計方針	添付書類(1)		添付書類(2)		補足すべき事項
<p>60</p> <p>c. 設計用減衰定数 地震応答解析に用いる減衰定数は、安全上適切と認められる規格及び基準に基づき、設備の種類、構造等により適切に選定するとともに、試験等で妥当性を確認した値も用いる。 なお、建物・構築物の地震応答解析に用いる鉄筋コンクリートの減衰定数の設定については、既往の知見に加え、既設施設の地震観測記録等により、その妥当性を検討する。 また、地盤と土木構築物の連成系地震応答解析モデルの減衰定数については、地中構造物としての特徴、同モデルの振動特性を考慮して適切に設定する。</p>	<p>IV-1-1 耐震設計の基本方針 4. 設計用地震力 4.1 地震力の算定方法 4.1.2 動的地震力</p>	<p>【4. 設計用地震力】 【4.1 地震力の算定方法】 【4.1.2 動的地震力】 ・動的解析においては、地盤の諸定数も含めて材料のばらつきによる材料定数の変動幅を適切に考慮する。動的解析の方法、設計用減衰定数等については、「IV-1-1-5 地震応答解析の基本方針」に、設計用床応答曲線の作成方法については、「IV-1-1-6 設計用床応答曲線の作成方針」に示す。</p>	-	-	<p><減衰定数の設定> ⇒地震応答解析に用いる減衰定数に関する根拠を示すため、減衰定数の設定内容について補足説明する。 ・[補足耐5]地震応答解析モデルに用いる鉄筋コンクリート造部の減衰定数に関する検討 ・[補足耐47]土木構築物の耐震安全性評価における共通事項について</p> <p><減衰定数の適用> ⇒施設の評価において適用する減衰定数のうち、最新知見として得られた減衰定数を用いることの妥当性、設備への適用性について補足説明する。 ・[補足耐6]新たに適用した減衰定数について</p>
	-	-	IV-1-1-5 地震応答解析の基本方針 3. 設計用減衰定数	【3. 設計用減衰定数】 ・地震応答解析に用いる減衰定数は、JEA4601-1987、1991に記載されている減衰定数を設備の種類、構造等により適切に選定するとともに、試験等で妥当性が確認された値も用いる。 ・建物・構築物の地震応答解析に用いる鉄筋コンクリートの材料減衰定数の設定については、既往の知見に加え、既設施設の地震観測記録等により、その妥当性を検討する。 ・地盤及び屋外重要土木構築物の連成系地震応答解析モデルの減衰定数については、地中構造物としての特徴及び同モデルの振動特性を考慮して適切に設定する。	
<p>61</p> <p>(4) 荷重の組合せと許容限界 耐震設計における荷重の組合せと許容限界は、以下によるものとする。 また、耐震設計においては、安全機能及び重大事故等に対処するために必要な機能である閉じ込め機能、プロセス量等の維持機能、掃気機能、崩壊熱等の除去機能、臨界防止機能、遮蔽機能、落下・転倒防止機能、支援機能、ソースターム制限機能、放出量の監視機能、換気機能、気密性、支持機能、操作場所及びアクセスルートの保持機能等を維持する設計とする。 上記の機能のうち、遮蔽機能、落下・転倒防止機能、気密性、支持機能、操作場所及びアクセスルートの保持機能等については、安全機能を有する施設の耐震重要度及び重大事故等対処施設の設備分類に応じた地震力に対して、当該機能が要求される施設の構造強度を確保することで、機能が維持できる設計とする。 閉じ込め機能、プロセス量等の維持機能、掃気機能、崩壊熱等の除去機能、臨界防止機能、支援機能、ソースターム制限機能、放出量の監視機能、換気機能等については、構造強度を確保するとともに、当該機能が要求される各施設の特性に応じて許容限界を適切に設定する。</p> <p>a. 耐震設計上考慮する状態 地震以外に設計上考慮する状態を以下に示す。 (a) 安全機能を有する施設 イ. 建物・構築物 (イ) 運転時の状態 再処理施設が運転している状態。 (ロ) 設計用自然条件 設計上基本的に考慮しなければならない自然条件(積雪、風)。</p>	<p>IV-1-1 耐震設計の基本方針 5. 機能維持の基本方針</p>	<p>【5. 機能維持の基本方針】 ・耐震設計においては、安全機能及び重大事故等に対処するために必要な機能である閉じ込め機能、プロセス量等の維持機能、掃気機能、崩壊熱等の除去機能、臨界防止機能、遮蔽機能、落下・転倒防止機能、支援機能、ソースターム制限機能、放出量の監視機能、換気機能、気密性、支持機能、操作場所及びアクセスルートの保持機能、地下水排水機能、飛来物防護機能、漏えい検知機能、火災防護機能、止水機能、ユーティリティ機能、貯水機能、分析機能、廃棄機能の構造強度を確保する設計とする。 ・上記の機能のうち、遮蔽機能、落下・転倒防止機能、気密性、支持機能、操作場所及びアクセスルートの保持機能、飛来物防護機能、止水機能、貯水機能、分析機能、廃棄機能については、安全機能を有する施設の耐震重要度及び重大事故等対処施設の設備分類に応じた地震力に対して、当該機能が要求される施設の構造強度を確保することで、機能が維持できる設計とする。 ・閉じ込め機能、プロセス量等の維持機能、掃気機能、崩壊熱等の除去機能、臨界防止機能、支援機能、ソースターム制限機能、放出量の監視機能、換気機能、地下水排水機能、漏えい検知機能、火災防護機能、ユーティリティ機能については、構造強度を確保するとともに、当該機能が要求される各施設の特性に応じて評価項目を追加することで、機能維持設計を行う。</p>	-	-	<p><土木構築物の要求機能> ⇒土木構築物の要求機能について補足説明する。 ・[補足耐2] 洞道の設工認申請上の取り扱いについて</p> <p><再処理施設の要求機能> ⇒再処理施設の要求機能について補足説明する。 ・[補足耐53]耐震設計における安全機能の整理について</p> <p><間接支持構造物の評価> ⇒間接支持構造物の評価に用いる解析モデル等に関する根拠を示すため、解析モデル等の設定内容について補足説明する。 ・[補足耐26] 応力解析におけるモデル化、境界条件及び拘束条件の考え方 ・[補足耐27] 地震荷重の入力方法 ・[補足耐28] 建物・構築物の耐震評価における組合せ係数法の適用性について ・[補足耐29] 応力解析における断面の評価部位の選定 ・[補足耐30] 応力解析における応力平均化の考え方</p>
	<p>IV-1-1 耐震設計の基本方針 5. 機能維持の基本方針 5.1 構造強度</p>	<p>【5.1 構造強度】 ・再処理施設は、安全機能を有する施設の耐震重要度に応じた地震力による荷重と地震力以外の荷重の組合せを適切に考慮した上で、構造強度を確保する設計とする。また、変位及び変形に対し、設計上の配慮を行う。 ・自然現象に関する組合せは、「VI-1-1-1 再処理施設の自然現象等による損傷の防止に関する説明書」に従う。 ・具体的な荷重の組合せ及び許容限界は「IV-1-1-8 機能維持の基本方針」の第3.1-1表に示す。</p>	-	-	<p><動的機能維持評価> ⇒動的機能維持の評価部位の妥当性及び評価方法について補足説明する。 ・[補足耐24]動的機能維持評価手法の適用について</p>
	<p>IV-1-1 耐震設計の基本方針 5. 機能維持の基本方針 5.1.1 耐震設計上考慮する状態</p>	<p>【5.1.1 耐震設計上考慮する状態】 ・地震以外に設計上考慮する状態を以下に示す。 (1) 安全機能を有する施設 a. 建物・構築物 (a) 運転時の状態 再処理施設が運転している状態。 (b) 設計用自然条件 設計上基本的に考慮しなければならない自然条件(積雪、風)。</p>	-	-	<p><電気盤等の機能維持評価> ⇒電気盤等の機能維持評価に用いる水平方向加速度の保守性に対する確認結果について補足説明する。 ・[補足耐25]電気盤等の機能維持評価に適用する水平方向の評価用地震力について</p>

	基本設計方針	添付書類(1)	添付書類(2)	補足すべき事項
61	<p>(4) 荷重の組合せと許容限界 耐震設計における荷重の組合せと許容限界は、以下によるものとする。 また、耐震設計においては、安全機能及び重大事故等に対処するために必要な機能である閉じ込め機能、プロセス量等の維持機能、掃気機能、崩壊熱等の除去機能、臨界防止機能、遮蔽機能、落下・転倒防止機能、支援機能、ソースターム制限機能、放出量の監視機能、換気機能、気密性、支持機能、操作場所及びアクセスルートの保持機能等を維持する設計とする。</p> <p>上記の機能のうち、遮蔽機能、落下・転倒防止機能、気密性、支持機能、操作場所及びアクセスルートの保持機能等については、安全機能を有する施設の耐震重要度及び重大事故等対処施設の設備分類に応じた地震力に対して、当該機能が要求される施設の構造強度を確保することで、機能が維持できる設計とする。</p> <p>閉じ込め機能、プロセス量等の維持機能、掃気機能、崩壊熱等の除去機能、臨界防止機能、支援機能、ソースターム制限機能、放出量の監視機能、換気機能等については、構造強度を確保するとともに、当該機能が要求される各施設の特性に応じて許容限界を適切に設定する。</p> <p>a. 耐震設計上考慮する状態 地震以外に設計上考慮する状態を以下に示す。 (a) 安全機能を有する施設 イ、建物・構築物 (イ)運転時の状態 再処理施設が運転している状態。 (ロ)設計用自然条件 設計上基本的に考慮しなければならない自然条件(積雪、風)。</p>	<p>IV-1-1 耐震設計の基本方針 5.機能維持の基本方針 5.2 機能維持 (1)建物・構築物 a.安全機能を有する施設</p> <p>【5.2 機能維持】 (1)建物・構築物 ・再処理施設の安全機能のうち、建物・構築物に要求される閉じ込め機能、火災防護機能、遮蔽機能、気密性、支持機能、操作場所及びアクセスルートの保持機能、地下水排水機能、廃棄機能及び貯水機能の機能維持の方針を以下に示す。 ・これらの機能維持の考え方を、「IV-1-1-8 機能維持の基本方針」に示す。 ・重大事故等対処施設の設計においては、設計基準事故時の状態と重大事故等時の状態での評価条件の比較を行い、重大事故等時の状態の方が厳しい場合は別途、重大事故等時の状態にて設計を行う。</p> <p>a.安全機能を有する施設 (a)閉じ込め機能の維持 ・閉じ込め機能の維持が要求される施設は、地震時及び地震後において、放射性物質を限定された区域に閉じ込めるため、安全機能を有する施設の耐震重要度に応じた地震動に対して、「5.1 構造強度」に基づく構造強度を確保することで、閉じ込め機能が維持できる設計とする。 ・閉じ込め機能の維持が要求される施設のうち、鉄筋コンクリート造の施設は、地震時及び地震後において、放射性物質が漏えいした場合にその影響の拡大を防止するため、閉じ込め機能の維持が要求される壁及び床が安全機能を有する施設の耐震重要度に応じた地震動に対して構造強度を確保することで閉じ込め機能が維持できる設計とする。 ・また、閉じ込め機能が要求される壁に設置する扉は、規格に基づく扉を用いることとするため、壁がせん断ひずみの許容限界を満足していることで、閉じ込め機能を確保できる。</p> <p>(b)火災防護機能の維持 ・火災防護機能の維持が要求される施設は、地震時及び地震後において、火災の影響を軽減するため、安全機能を有する施設の耐震重要度に応じた地震動に対して、「5.1 構造強度」に基づく構造強度を確保することで、火災防護機能が維持できる設計とする。</p> <p>(c)遮蔽機能の維持 ・遮蔽機能の維持が要求される施設は、地震時及び地震後において、放射線業務従事者の放射線障害防止、再処理施設周辺の空間線量率の低減、居住性の確保及び放射線障害から公衆等を守るため、安全機能を有する施設の耐震重要度に応じた地震動に対して、「5.1 構造強度」に基づく構造強度を確保し、遮蔽体の形状及び厚さを確保することで、遮蔽機能が維持できる設計とする。</p> <p>(d)支持機能の維持 ・機器・配管系等の設備を間接的に支持する機能の維持が要求される施設は、地震時及び地震後において、被支持設備の機能を維持するため、被支持設備の安全機能を有する施設の耐震重要度に応じた地震動に対して、「5.1 構造強度」に基づく構造強度を確保することで、支持機能が維持できる設計とする。 ・支持機能の維持が要求される施設のうち、建物・構築物の鉄筋コンクリート造の施設は、耐震壁のせん断ひずみの許容限界を満足すること又は基礎を構成する部材に生じる応力が終局強度に対し妥当な安全余裕を有していることで、Sクラス設備等に対する支持機能が維持できる設計とする。 ・建物・構築物のうち屋外重要土木構築物については、構造部材の曲げについては界層間変形角(層間変形角1/100)又は終局曲率、せん断についてはせん断耐力を許容限界とする。なお、限界層間変形角、終局曲率及びせん断耐力の許容限界に対しては妥当な安全余裕をもたせることとし、機器・配管系の支持機能が維持できる設計とする。その他の土木構築物については、安全上適切と認められる規格及び基準による許容応力度を許容限界とし、機器・配管系の支持機能が維持できる設計とする。</p> <p>(e)地下水排水機能の維持 ・地下水排水機能の維持が要求される施設は、地震時及び地震後において、建物・構築物の周囲の地下水を排水するため、安全機能を有する施設の耐震重要度に応じた地震動に対して、「5.1 構造強度」に基づく構造強度を確保することで、地下水排水機能が維持できる設計とする。 ・地下水排水機能の維持が要求される施設である地下水排水設備(サブドレン管、集水管、サブドレンピット及びサブドレンシャフト)については、耐震設計において地下水位の低下を期待する建物・構築物の周囲の地下水を排水するため、基準地震動Ssによる地震力に対して機能が維持できる設計とする。</p> <p>(f)廃棄機能の維持 ・廃棄機能の維持が要求される施設は、地震時及び地震後において、放射性廃棄物を廃棄するため、安全機能を有する施設の耐震重要度に応じた地震動に対して、「5.1 構造強度」に基づく構造強度を確保することで、廃棄機能が維持できる設計とする。</p>	-	<p><土木構築物の要求機能> ⇒土木構築物の要求機能について補足説明する。 ・[補足耐2]河道の設工認申請上の取り扱いについて</p> <p><再処理施設の要求機能> ⇒再処理施設の要求機能について補足説明する。 ・[補足耐53]耐震設計における安全機能の整理について</p> <p><間接支持構造物の評価> ⇒間接支持構造物の評価に用いる解析モデル等に関する根拠を示すため、解析モデル等の設定内容について補足説明する。 ・[補足耐26]応力解析におけるモデル化、境界条件及び拘束条件の考え方 ・[補足耐27]地震荷重の入力方法 ・[補足耐28]建物・構築物の耐震評価における組合せ係数法の適用性について ・[補足耐29]応力解析における断面の評価部位の選定 ・[補足耐30]応力解析における応力平均化の考え方</p> <p><動的機能維持評価> ⇒動的機能維持の評価部位の妥当性及び評価方法について補足説明する。 ・[補足耐24]動的機能維持評価手法の適用について</p> <p><電気盤等の機能維持評価> ⇒電気盤等の機能維持評価に用いる水平方向加速度の保守性に対する確認結果について補足説明する。 ・[補足耐25]電気盤等の機能維持評価に適用する水平方向の評価用地震力について</p>

基本設計方針	添付書類(1)	添付書類(2)	補足すべき事項
<p>(4) 荷重の組合せと許容限界 耐震設計における荷重の組合せと許容限界は、以下によるものとする。 また、耐震設計においては、安全機能及び重大事故等に対処するために必要な機能である閉じ込め機能、プロセス量等の維持機能、掃気機能、崩壊熱等の除去機能、臨界防止機能、遮蔽機能、落下・転倒防止機能、支援機能、ソースターム制限機能、放出量の監視機能、換気機能、気密性、支持機能、操作場所及びアクセスルートの保持機能等を維持する設計とする。 上記の機能のうち、遮蔽機能、落下・転倒防止機能、気密性、支持機能、操作場所及びアクセスルートの保持機能等については、安全機能を有する施設の耐震重要度及び重大事故等対処施設の設備分類に応じた地震力に対して、当該機能が要求される施設の構造強度を確保することで、機能が維持できる設計とする。 閉じ込め機能、プロセス量等の維持機能、掃気機能、崩壊熱等の除去機能、臨界防止機能、支援機能、ソースターム制限機能、放出量の監視機能、換気機能等については、構造強度を確保するとともに、当該機能が要求される各施設の特性に応じて許容限界を適切に設定する。</p> <p>a. 耐震設計上考慮する状態 地震以外に設計上考慮する状態を以下に示す。 (a) 安全機能を有する施設 イ、建物・構築物 (イ) 運転時の状態 再処理施設が運転している状態。 (ロ) 設計用自然条件 設計上基本的に考慮しなければならない自然条件(積雪、風)。</p>	<p>IV-1-1 耐震設計の基本方針 5. 機能維持の基本方針 5.2 機能維持 (1) 建物・構築物 b. 重大事故等対処施設</p> <p>[5.2 機能維持] (1) 建物・構築物 b. 重大事故等対処施設</p> <p>(2) 機器・配管系 a. 安全機能を有する施設</p>		<p><土木建造物の要求機能> ⇒土木建造物の要求機能について補足説明する。 ・[補足耐2] 洞道の設工認申請上の取り扱いについて</p> <p><再処理施設の要求機能> ⇒再処理施設の要求機能について補足説明する。 ・[補足耐53] 耐震設計における安全機能の整理について</p> <p><間接支持構造物の評価> ⇒間接支持構造物の評価に用いる解析モデル等に関する根拠を示すため、解析モデル等の設定内容について補足説明する。 ・[補足耐26] 応力解析におけるモデル化、境界条件及び拘束条件の考え方 ・[補足耐27] 地震荷重の入力方法 ・[補足耐28] 建物・構築物の耐震評価における組合せ係数法の適用性について ・[補足耐29] 応力解析における断面の評価部位の選定 ・[補足耐30] 応力解析における応力平均化の考え方</p> <p><動的機能維持評価> ⇒動的機能維持の評価部位の妥当性及び評価方法について補足説明する。 ・[補足耐24] 動的機能維持評価手法の適用について</p> <p><電気盤等の機能維持評価> ⇒電気盤等の機能維持評価に用いる水平方向加速度の保守性に対する確認結果について補足説明する。 ・[補足耐25] 電気盤等の機能維持評価に適用する水平方向の評価用地震力について</p>

基本設計方針	添付書類(1)	添付書類(2)	補足すべき事項
<p>(4) 荷重の組合せと許容限界 耐震設計における荷重の組合せと許容限界は、以下によるものとする。 また、耐震設計においては、安全機能及び重大事故等に対処するために必要な機能である閉じ込め機能、プロセス量等の維持機能、掃気機能、崩壊熱等の除去機能、臨界防止機能、遮蔽機能、落下・転倒防止機能、支援機能、ソースターム制限機能、放出量の監視機能、換気機能、気密性、支持機能、操作場所及びアクセスルートの保持機能等を維持する設計とする。 上記の機能のうち、遮蔽機能、落下・転倒防止機能、気密性、支持機能、操作場所及びアクセスルート下の保持機能等については、安全機能を有する施設の耐震重要度及び重大事故等対処施設の設備分類に応じた地震力に対して、当該機能が要求される施設の構造強度を確保することで、機能が維持できる設計とする。 閉じ込め機能、プロセス量等の維持機能、掃気機能、崩壊熱等の除去機能、臨界防止機能、支援機能、ソースターム制限機能、放出量の監視機能、換気機能等については、構造強度を確保するとともに、当該機能が要求される各施設の特性に応じて許容限界を適切に設定する。</p> <p>a. 耐震設計上考慮する状態 地震以外に設計上考慮する状態を以下に示す。 (a) 安全機能を有する施設 イ、建物・構築物 イ) 運転時の状態 再処理施設が運転している状態。 (ロ) 設計用自然条件 設計上基本的に考慮しなければならない自然条件(積雪、風)。</p>	<p>IV-1-1 耐震設計の基本方針 5. 機能維持の基本方針 5.2 機能維持 (2) 機器・配管系 b. 重大事故等対処施設</p> <p>【5.2 機能維持】 b. 重大事故等対処施設 (a) 動的機能維持 ・動的機能が要求される設備は、重大事故等対処施設の設備分類に応じた地震動に対して、「5.2(2)a.(a) 動的機能維持」と同様の設計を行うことで、動的機能を維持する設計とする。 (b) 電気的機能維持 ・電気的機能が要求される設備は、重大事故等対処施設の設備分類に応じた地震動に対して、「5.2(2)a.(b) 電気的機能維持」と同様の設計を行うことで、電気的機能を維持する設計とする。 (c) 閉じ込め機能の維持 ・閉じ込め機能の維持が要求される設備のうち、グローブボックスは、重大事故等対処施設の設備分類に応じた地震動に対して、「5.2(2)a.(c) 閉じ込め機能の維持」と同様の設計を行うことで、閉じ込め機能が維持できる設計とする。 (d) 臨界防止機能の維持 ・臨界防止機能の維持が要求される設備は、重大事故等対処施設の設備分類に応じた地震動に対して、「5.2(2)a.(d) 臨界防止機能の維持」と同様の設計を行うことで、臨界防止機能が維持できる設計とする。</p>	<p>-</p>	<p><土木建造物の要求機能> ⇒土木建造物の要求機能について補足説明する。 ・[補足耐2] 河道の設工認申請上の取り扱いについて</p> <p><再処理施設の要求機能> ⇒再処理施設の要求機能について補足説明する。 ・[補足耐53] 耐震設計における安全機能の整理について</p> <p><間接支持構造物の評価> ⇒間接支持構造物の評価に用いる解析モデル等に関する根拠を示すため、解析モデル等の設定内容について補足説明する。 ・[補足耐26] 応力解析におけるモデル化、境界条件及び拘束条件の考え方 ・[補足耐27] 地震荷重の入力方法 ・[補足耐28] 建物・構築物の耐震評価における組合せ係数法の適用性について ・[補足耐29] 応力解析における断面の評価部位の選定 ・[補足耐30] 応力解析における応力平均化の考え方</p> <p><動的機能維持評価> ⇒動的機能維持の評価部位の妥当性及び評価方法について補足説明する。 ・[補足耐24] 動的機能維持評価手法の適用について</p> <p><電気盤等の機能維持評価> ⇒電気盤等の機能維持評価に用いる水平方向加速度の保守性に対する確認結果について補足説明する。 ・[補足耐25] 電気盤等の機能維持評価に適用する水平方向の評価用地震力について</p>
<p>ロ、機器・配管系 (イ) 運転時の状態 再処理施設が運転している状態。 (ロ) 運転時の異常な過渡変化時の状態 運転時に予想される機械又は器具の単一の故障若しくはその誤作動又は運転員の単一の誤操作及びこれらと類似の頻度で発生すると予想される外乱によって発生する異常な状態であって、当該状態が継続した場合には温度、圧力、流量その他の再処理施設の状態を示す事項が安全設計上許容される範囲を超えるおそれがあるものとして安全設計上想定すべき事象が発生した状態。 (ハ) 設計基準事故時の状態 発生頻度が運転時の異常な過渡変化より低い異常な状態であって、当該状態が発生した場合には再処理施設から多量の放射性物質が放出するおそれがあるものとして安全設計上想定すべき事象が発生した状態。</p>	<p>IV-1-1 耐震設計の基本方針 5. 機能維持の基本方針 5.1 構造強度 5.1.1 耐震設計上考慮する状態</p> <p>【5.1.1 耐震設計上考慮する状態】 (1) 安全機能を有する施設 b. 機器・配管系 (a) 運転時の状態 再処理施設が運転している状態。 (b) 運転時の異常な過渡変化時の状態 運転時に予想される機械又は器具の単一の故障若しくはその誤作動又は運転員の単一の誤操作及びこれらと類似の頻度で発生すると予想される外乱によって発生する異常な状態であって、当該状態が継続した場合には温度、圧力、流量その他の再処理施設の状態を示す事項が安全設計上許容される範囲を超えるおそれがあるものとして安全設計上想定すべき事象が発生した状態。 (c) 設計基準事故時の状態 発生頻度が運転時の異常な過渡変化より低い異常な状態であって、当該状態が発生した場合には再処理施設から多量の放射性物質が放出するおそれがあるものとして安全設計上想定すべき事象が発生した状態。</p>	<p>-</p>	<p>※補足すべき事項の対象なし</p>
<p>(b) 重大事故等対処施設 イ、建物・構築物 (イ) 運転時の状態 再処理施設が運転している状態。 (ロ) 重大事故等時の状態 再処理施設が、重大事故に至るおそれがある事故又は重大事故の状態、重大事故等対処施設の機能を必要とする状態。 (ハ) 設計用自然条件 設計上基本的に考慮しなければならない自然条件(積雪、風)。</p>	<p>IV-1-1 耐震設計の基本方針 5. 機能維持の基本方針 5.1 構造強度</p> <p>【5.1 構造強度】 ・再処理施設は、重大事故等対処施設の設備分類に応じた地震力による荷重と地震力以外の荷重の組合せを適切に考慮した上で、構造強度を確保する設計とする。また、変位及び変形に対し、設計上の配慮を行う。 ・具体的な荷重の組合せと許容限界は「IV-1-1-8 機能維持の基本方針」に示す。</p>	<p>-</p>	<p>※補足すべき事項の対象なし</p>
<p>ロ、機器・配管系 (イ) 運転時の状態 再処理施設が運転している状態。 (ロ) 運転時の異常な過渡変化時の状態 運転時に予想される機械又は器具の単一の故障若しくはその誤作動又は運転員の単一の誤操作及びこれらと類似の頻度で発生すると予想される外乱によって発生する異常な状態であって、当該状態が継続した場合には温度、圧力、流量その他の再処理施設の状態を示す事項が安全設計上許容される範囲を超えるおそれがあるものとして安全設計上想定すべき事象が発生した状態。 (ハ) 設計基準事故時の状態 発生頻度が運転時の異常な過渡変化より低い異常な状態であって、当該状態が発生した場合には再処理施設から多量の放射性物質が放出するおそれがあるものとして安全設計上想定すべき事象が発生した状態。 (ニ) 重大事故等時の状態 再処理施設が、重大事故に至るおそれがある事故又は重大事故の状態、重大事故等対処施設の機能を必要とする状態。</p>	<p>IV-1-1 耐震設計の基本方針 5. 機能維持の基本方針 5.1 構造強度 5.1.1 耐震設計上考慮する状態</p> <p>【5.1.1 耐震設計上考慮する状態】 (2) 重大事故等対処施設 a. 建物・構築物 (a) 運転時の状態 再処理施設が運転している状態。 (b) 重大事故等時の状態 再処理施設が、重大事故に至るおそれがある事故又は重大事故の状態、重大事故等対処施設の機能を必要とする状態。 (c) 設計用自然条件 設計上基本的に考慮しなければならない自然条件(積雪、風)。</p>	<p>-</p>	<p>※補足すべき事項の対象なし</p>
<p>ロ、機器・配管系 (イ) 運転時の状態 再処理施設が運転している状態。 (ロ) 運転時の異常な過渡変化時の状態 運転時に予想される機械又は器具の単一の故障若しくはその誤作動又は運転員の単一の誤操作及びこれらと類似の頻度で発生すると予想される外乱によって発生する異常な状態であって、当該状態が継続した場合には温度、圧力、流量その他の再処理施設の状態を示す事項が安全設計上許容される範囲を超えるおそれがあるものとして安全設計上想定すべき事象が発生した状態。 (ハ) 設計基準事故時の状態 発生頻度が運転時の異常な過渡変化より低い異常な状態であって、当該状態が発生した場合には再処理施設から多量の放射性物質が放出するおそれがあるものとして安全設計上想定すべき事象が発生した状態。 (ニ) 重大事故等時の状態 再処理施設が、重大事故に至るおそれがある事故又は重大事故の状態、重大事故等対処施設の機能を必要とする状態。</p>	<p>IV-1-1 耐震設計の基本方針 5. 機能維持の基本方針 5.1 構造強度 5.1.1 耐震設計上考慮する状態</p> <p>【5.1.1 耐震設計上考慮する状態】 (2) 重大事故等対処施設 b. 機器・配管系 (a) 運転時の状態 再処理施設が運転している状態。 (b) 運転時の異常な過渡変化時の状態 運転時に予想される機械又は器具の単一の故障若しくはその誤作動又は運転員の単一の誤操作及びこれらと類似の頻度で発生すると予想される外乱によって発生する異常な状態であって、当該状態が継続した場合には温度、圧力、流量その他の再処理施設の状態を示す事項が安全設計上許容される範囲を超えるおそれがあるものとして安全設計上想定すべき事象が発生した状態。 (c) 設計基準事故時の状態 発生頻度が運転時の異常な過渡変化より低い異常な状態であって、当該状態が発生した場合には再処理施設から多量の放射性物質が放出するおそれがあるものとして安全設計上想定すべき事象が発生した状態。 (d) 重大事故等時の状態 再処理施設が、重大事故に至るおそれがある事故又は重大事故の状態、重大事故等対処施設の機能を必要とする状態。</p>	<p>-</p>	<p>※補足すべき事項の対象なし</p>
<p>b. 荷重の種類 (a) 安全機能を有する施設 イ、建物・構築物 (イ) 再処理施設のおかれている状態にかかわらず常時作用している荷重、すなわち固定荷重、積載荷重、土圧及び水圧 (ロ) 運転時の状態で施設に作用する荷重 (ハ) 地震力、積雪荷重及び風荷重 ただし、運転時の状態で施設に作用する荷重には、機器・配管系から作用する荷重が含まれるものとし、地震力には、地震時土圧、地震時水圧及び機器・配管系からの反力が含まれるものとする。</p>	<p>IV-1-1 耐震設計の基本方針 5. 機能維持の基本方針 5.1 構造強度 5.1.2 荷重の種類 (1) 安全機能を有する施設</p> <p>【5.1.2 荷重の種類(1)】 a. 建物・構築物 (a) 再処理施設のおかれている状態にかかわらず常時作用している荷重、すなわち固定荷重、積載荷重、土圧及び水圧 (b) 運転時の状態で施設に作用する荷重 (c) 地震力、積雪荷重及び風荷重 ・運転時の状態で施設に作用する荷重には、機器・配管系から作用する荷重が含まれるものとし、地震力には、地震時の土圧、機器・配管系からの反力、スロッシング等による荷重が含まれるものとする。</p>	<p>-</p>	<p>※補足すべき事項の対象なし</p>

補足説明すべき項目の抽出
(第五条(安全機能を有する施設の地盤)、第三十二条(重大事故等対処施設の地盤)、第六条、第三十三条(地震による損傷の防止))

基本設計方針	添付書類(1)	添付書類(2)	添付書類(2)	補足すべき事項
<p>ロ. 機器・配管系 (イ)運転時の状態で施設に作用する荷重 (ロ)運転時の異常な過渡変化時の状態で施設に作用する荷重 (ハ)設計基準事故時の状態で施設に作用する荷重 (ニ)地震力 ただし、各状態において施設に作用する荷重には、常時作用している荷重、すなわち自重等の固定荷重が含まれるものとする。また、屋外に設置される施設については、建物・構築物に準じる。</p>	<p>IV-1-1 耐震設計の基本方針 5.機能維持の基本方針 5.1 構造強度 5.1.2 荷重の種類 (1) 安全機能を有する施設</p>	<p>【5.1.2 荷重の種類(1)】 b. 機器・配管系 (a)運転時の状態で施設に作用する荷重 (b)運転時の異常な過渡変化時の状態で施設に作用する荷重 (c)設計基準事故時の状態で施設に作用する荷重 (d)地震力 ・各状態において施設に作用する荷重には、常時作用している荷重、すなわち自重等の固定荷重が含まれるものとする。また、屋外に設置される施設の積雪荷重及び風荷重については、建物・構築物に準じる。</p>	<p>-</p>	<p>※補足すべき事項の対象なし</p>
<p>(b) 重大事故等対処施設 イ. 建物・構築物 (イ)再処理施設のおかれている状態にかかわらず常時作用している荷重、すなわち固定荷重、積載荷重、土圧及び水圧 (ロ)運転時の状態で施設に作用する荷重 (ハ)重大事故等時の状態で施設に作用する荷重 (ニ)地震力、積雪荷重及び風荷重 ただし、運転時及び重大事故等時の状態で施設に作用する荷重には、機器・配管系から作用する荷重が含まれるものとし、地震時には、地震時土圧、地震時水圧及び機器・配管系からの反力が含まれるものとする。</p>	<p>IV-1-1 耐震設計の基本方針 5.機能維持の基本方針 5.1 構造強度 5.1.2 荷重の種類 (2) 重大事故等対処施設</p>	<p>【5.1.2 荷重の種類(2)】 a. 建物・構築物 (a)再処理施設のおかれている状態にかかわらず常時作用している荷重、すなわち固定荷重、積載荷重、土圧及び水圧 (b)運転時の状態で施設に作用する荷重 (c)重大事故等時の状態で施設に作用する荷重 (d)地震力、積雪荷重及び風荷重 ・運転時及び重大事故等時の状態で施設に作用する荷重には、機器・配管系から作用する荷重が含まれるものとし、地震時には、地震時の土圧、機器・配管系からの反力、スロッシング等による荷重が含まれるものとする。</p>	<p>-</p>	<p>※補足すべき事項の対象なし</p>
<p>ロ. 機器・配管系 (イ)運転時の状態で施設に作用する荷重 (ロ)運転時の異常な過渡変化時の状態で施設に作用する荷重 (ハ)設計基準事故時の状態で施設に作用する荷重 (ニ)重大事故等時の状態で施設に作用する荷重 (ホ)地震力 ただし、各状態において施設に作用する荷重には、常時作用している荷重、すなわち自重等の固定荷重が含まれるものとする。また、屋外に設置される施設については、建物・構築物に準じる。</p>	<p>IV-1-1 耐震設計の基本方針 5.機能維持の基本方針 5.1 構造強度 5.1.2 荷重の種類 (2) 重大事故等対処施設</p>	<p>【5.1.2 荷重の種類(2)】 b. 機器・配管系 (a)運転時の状態で施設に作用する荷重 (b)運転時の異常な過渡変化時の状態で施設に作用する荷重 (c)設計基準事故時の状態で施設に作用する荷重 (d)重大事故等時の状態で施設に作用する荷重 (e)地震力 ・各状態において施設に作用する荷重には、常時作用している荷重、すなわち自重等の固定荷重が含まれるものとする。また、屋外に設置される施設の積雪荷重及び風荷重については、建物・構築物に準じる。</p>	<p>-</p>	<p>※補足すべき事項の対象なし</p>
<p>c. 荷重の組合せ 地震力と他の荷重との組合せについては、「3.3 外部からの衝撃による損傷の防止」で設定している風及び積雪による荷重を考慮し、以下のとおり設定する。 (a) 安全機能を有する施設 イ. 建物・構築物 (イ)Sクラスの建物・構築物については、常時作用している荷重(固定荷重、積載荷重、土圧及び水圧)、運転時の状態で施設に作用する荷重、積雪荷重及び風荷重と基準地震動S sによる地震力とを組み合わせる。 (ロ)Sクラス、Bクラス及びCクラスの建物・構築物については、常時作用している荷重(固定荷重、積載荷重、土圧及び水圧)、運転時の状態で施設に作用する荷重、積雪荷重及び風荷重と基準地震動S s以外の地震動による地震力又は静的地震力とを組み合わせる。 この際、常時作用している荷重のうち、土圧及び水圧について、基準地震動S sによる地震力又は弾性設計用地震動S dによる地震力と組み合わせる場合は、当該地震時の土圧及び水圧とする。</p>	<p>IV-1-1 耐震設計の基本方針 5.機能維持の基本方針 5.1 構造強度 5.1.3 荷重の組合せ</p>	<p>【5.1.3 荷重の組合せ】 ・地震力と他の荷重との組合せは以下による。 (1) 安全機能を有する施設 a. 建物・構築物 (a)Sクラスの建物・構築物については、常時作用している荷重(固定荷重、積載荷重、土圧及び水圧)、運転時の状態で施設に作用する荷重、積雪荷重及び風荷重と基準地震動S sによる地震力とを組み合わせる。 (b)Sクラスの建物・構築物については、常時作用している荷重(固定荷重、積載荷重、土圧及び水圧)、運転時の状態で施設に作用する荷重、積雪荷重及び風荷重と弾性設計用地震動S dによる地震力又は静的地震力とを組み合わせる。 (c)Bクラス及びCクラスの建物・構築物については、常時作用している荷重(固定荷重、積載荷重、土圧及び水圧)、運転時の状態で施設に作用する荷重、積雪荷重及び風荷重と、動的な地震力又は静的地震力とを組み合わせる。 ・常時作用している荷重のうち、土圧及び水圧について、基準地震動S sによる地震力又は弾性設計用地震動S dによる地震力と組み合わせる場合は、当該地震時の土圧及び水圧とする。</p>	<p>-</p>	<p>※補足すべき事項の対象なし</p>
<p>ロ. 機器・配管系 (イ)Sクラスの機器・配管系については、常時作用している荷重、運転時の状態で施設に作用する荷重、運転時の異常な過渡変化時に生じる荷重、設計基準事故時に生じる荷重と基準地震動S sによる地震力、弾性設計用地震動S dによる地震力又は静的地震力とを組み合わせる。 (ロ)Bクラスの機器・配管系については、常時作用している荷重、運転時の状態で施設に作用する荷重、運転時の異常な過渡変化時に生じる荷重と共振影響検用の地震動による地震力又は静的地震力とを組み合わせる。 (ハ)Cクラスの機器・配管系については、常時作用している荷重、運転時の状態で施設に作用する荷重、運転時の異常な過渡変化時に生じる荷重と静的地震力とを組み合わせる。 なお、屋外に設置される施設については、建物・構築物と同様に積雪荷重及び風荷重を組み合わせる。</p>	<p>IV-1-1 耐震設計の基本方針 5.機能維持の基本方針 5.1 構造強度 5.1.3 荷重の組合せ (1) 安全機能を有する施設</p>	<p>【5.1.3 荷重の組合せ(1)】 b. 機器・配管系 (a)Sクラスの機器・配管系については、常時作用している荷重、運転時の状態で施設に作用する荷重と地震力とを組み合わせる。 (b)Sクラスの機器・配管系については、運転時の異常な過渡変化時の状態及び設計基準事故時の状態のうち地震によって引き起こされるおそれのある事故等によって施設に作用する荷重は、その事故事象の継続時間等との関係を踏まえ、適切な地震力とを組み合わせる。 (c)Bクラスの機器・配管系については、常時作用している荷重、運転時の状態で施設に作用する荷重、運転時の異常な過渡変化時に生じる荷重と共振影響検用の地震動による地震力又は静的地震力とを組み合わせる。 (d)Cクラスの機器・配管系については、常時作用している荷重、運転時の状態で施設に作用する荷重、運転時の異常な過渡変化時に生じる荷重と静的地震力とを組み合わせる。 ・屋外に設置される施設については、建物・構築物と同様に積雪荷重及び風荷重を組み合わせる。</p>	<p>-</p>	<p><地震荷重と事故時荷重との組合せについて> ⇒運転時の異常な過渡変化時及び設計基準事故時の荷重と地震力との組合せ要否の検討内容について補足説明する。 ・[補足耐14]地震荷重と事故時荷重との組合せについて</p>
<p>(b) 重大事故等対処施設 イ. 建物・構築物 (イ)常設耐震重要重大事故等対処設備が設置される重大事故等対処施設の建物・構築物については、常時作用している荷重(固定荷重、積載荷重、土圧及び水圧)、積雪荷重、風荷重及び運転時の状態で施設に作用する荷重と基準地震動S sによる地震力とを組み合わせる。 (ロ)常設耐震重要重大事故等対処設備が設置される重大事故等対処施設の建物・構築物については、常時作用している荷重(固定荷重、積載荷重、土圧及び水圧)、積雪荷重、風荷重及び重大事故等時の状態で施設に作用する荷重のうち、地震によって引き起こされるおそれがある事象によって作用する荷重と基準地震動S sによる地震力とを組み合わせる。 (ハ)常設耐震重要重大事故等対処設備が設置される重大事故等対処施設の建物・構築物については、常時作用している荷重(固定荷重、積載荷重、土圧及び水圧)、積雪荷重、風荷重及び重大事故等時の状態で施設に作用する荷重のうち、地震によって引き起こされるおそれがない事象による荷重は、その事故事象の発生確率、継続時間及び地震動の年超過確率の関係を踏まえ、適切な地震力(基準地震動S s又は弾性設計用地震動S d)による地震力と組み合わせる。この組合せについては、事故事象の発生確率、継続時間及び地震動の年超過確率の積等を考慮し、工学的、総合的に勘案の上設定する。なお、継続時間については対策の成立性も考慮した上で設定する。 (ニ)常設耐震重要重大事故等対処設備以外の常設重大事故等対処設備が設置される重大事故等対処施設の建物・構築物については、常時作用している荷重(固定荷重、積載荷重、土圧及び水圧)、運転時の状態で施設に作用する荷重、積雪荷重及び風荷重と、弾性設計用地震動S dによる地震力又は静的地震力とを組み合わせる。 この際、常時作用している荷重のうち、土圧及び水圧について、基準地震動S sによる地震力又は弾性設計用地震動S dによる地震力と組み合わせる場合は、当該地震時の土圧及び水圧とする。</p>	<p>IV-1-1 耐震設計の基本方針 5.機能維持の基本方針 5.1 構造強度 5.1.3 荷重の組合せ (2) 重大事故等対処施設</p>	<p>【5.1.3 荷重の組合せ(2)】 a. 建物・構築物 (a)常設耐震重要重大事故等対処設備が設置される重大事故等対処施設の建物・構築物については、常時作用している荷重(固定荷重、積載荷重、土圧及び水圧)、積雪荷重、風荷重及び運転時の状態で施設に作用する荷重と基準地震動S sによる地震力とを組み合わせる。 (b)常設耐震重要重大事故等対処設備が設置される重大事故等対処施設の建物・構築物については、常時作用している荷重(固定荷重、積載荷重、土圧及び水圧)、積雪荷重、風荷重及び重大事故等時の状態で施設に作用する荷重のうち、地震によって引き起こされるおそれがある事象によって作用する荷重と基準地震動S sによる地震力とを組み合わせる。 (c)常設耐震重要重大事故等対処設備が設置される重大事故等対処施設の建物・構築物については、常時作用している荷重(固定荷重、積載荷重、土圧及び水圧)、積雪荷重、風荷重及び重大事故等時の状態で施設に作用する荷重のうち、地震によって引き起こされるおそれがない事象による荷重は、その事故事象の発生確率、継続時間及び地震動の年超過確率の関係を踏まえ、適切な地震力(基準地震動S s又は弾性設計用地震動S d)による地震力と組み合わせる。この組合せについては、事故事象の発生確率、継続時間及び地震動の年超過確率の積等を考慮し、工学的、総合的に勘案の上設定する。なお、継続時間については対策の成立性も考慮した上で設定する。 ・以上を踏まえ、重大事故等時の状態で施設に作用する荷重と地震力との組合せについては、いったん事故が発生した場合、長時間継続する事象による荷重と弾性設計用地震動S dによる地震力とを組み合わせ、その状態からさらに長期的に継続する事象による荷重と基準地震動S sによる地震力とを組み合わせることとなるが、弾性設計用地震動S dとの組合せの目安となる継続時間がごく僅かであることから、重大事故等時の荷重と組み合わせる地震力は、基準地震動S sによる地震力とする。 (d)常設耐震重要重大事故等対処設備以外の常設重大事故等対処設備が設置される重大事故等対処施設の建物・構築物については、常時作用している荷重(固定荷重、積載荷重、土圧及び水圧)、運転時の状態で施設に作用する荷重、積雪荷重及び風荷重と、弾性設計用地震動S dに2分の1を乗じたものによる地震力又は静的地震力とを組み合わせる。 ・常時作用している荷重のうち、土圧及び水圧について、基準地震動S sによる地震力、弾性設計用地震動S dに2分の1を乗じたものによる地震力と組み合わせる場合は、当該地震時の土圧及び水圧とする。</p>	<p>-</p>	<p>※補足すべき事項の対象なし</p>

補足説明すべき項目の抽出
(第五条（安全機能を有する施設の地盤）、第三十二条（重大事故等対処施設の地盤）、第六条、第三十三条（地震による損傷の防止））

基本設計方針	添付書類(1)	添付書類(2)	補足すべき事項	
<p>ロ. 機器・配管系 (イ) 常設耐震重要重大事故等対処設備が設置される重大事故等対処施設の機器・配管系については、常時作用している荷重及び運転時の状態で施設に作用する荷重と基準地震動 S s による地震力とを組み合わせる。 (ロ) 常設耐震重要重大事故等対処設備が設置される重大事故等対処施設の機器・配管系については、常時作用している荷重、運転時の異常な過渡変化時の状態、設計基準事故時の状態及び重大事故等時の状態で施設に作用する荷重のうち、地震によって引き起こされるおそれがある事象によって作用する荷重と基準地震動 S s による地震力とを組み合わせる。 (ハ) 常設耐震重要重大事故等対処設備が設置される重大事故等対処施設の機器・配管系については、常時作用している荷重、運転時の異常な過渡変化時の状態、設計基準事故時の状態及び重大事故等時の状態で施設に作用する荷重のうち、地震によって引き起こされるおそれがない事象による荷重は、基準地震動 S s 又は弾性設計用地震動 S d による地震力と組み合わせる。 (ニ) 常設耐震重要重大事故等対処設備以外の常設重大事故等対処設備が設置される重大事故等対処施設の機器・配管系については、常時作用している荷重、運転時の状態で施設に作用する荷重及び運転時の異常な過渡変化時の状態と弾性設計用地震動 S d による地震力又は静的地震力とを組み合わせる。 なお、屋外に設置される施設については、建物・構築物と同様に積雪荷重及び風荷重を組み合わせる。</p>	<p>IV-1-1 耐震設計の基本方針 5.機能維持の基本方針 5.1 構造強度 5.1.3 荷重の組合せ (2) 重大事故等対処施設</p>	<p>【5.1.3 荷重の組合せ(2)】 b. 機器・配管系 (a) 常設耐震重要重大事故等対処設備が設置される重大事故等対処施設の機器・配管系については、常時作用している荷重及び運転時の状態で施設に作用する荷重と基準地震動 S s による地震力とを組み合わせる。 (b) 常設耐震重要重大事故等対処設備が設置される重大事故等対処施設の機器・配管系については、常時作用している荷重、運転時の異常な過渡変化時の状態、設計基準事故時の状態及び重大事故等時の状態で施設に作用する荷重のうち、地震によって引き起こされるおそれがある事象によって作用する荷重と基準地震動 S s による地震力とを組み合わせる。 (c) 常設耐震重要重大事故等対処設備が設置される重大事故等対処施設の機器・配管系の、常時作用している荷重、運転時の異常な過渡変化時の状態、設計基準事故時の状態及び重大事故等時の状態で施設に作用する荷重のうち、地震によって引き起こされるおそれがない事象による荷重と、基準地震動 S s 又は弾性設計用地震動 S d による地震力との組合せについては、事故事象の発生確率、継続時間及び地震動の年超過確率の積等を考慮し、工学的、総合的に勘案の上設定する。なお、継続時間については対策の成立性も考慮した上で設定する。 ・以上を踏まえ、重大事故等時の状態で施設に作用する荷重と地震力との組合せについては、いったん事故が発生した場合、長時間継続する事象による荷重と弾性設計用地震動 S d による地震力とを組み合わせ、その状態からさらに長期的に継続する事象による荷重と基準地震動 S s による地震力とを組み合わせることとなるが、弾性設計用地震動 S d との組合せの目安となる継続時間がごく僅かであることから、重大事故等時の荷重と組み合わせる地震力は、基準地震動 S s による地震力とする。 (d) 常設耐震重要重大事故等対処設備以外の常設重大事故等対処設備が設置される重大事故等対処施設の機器・配管系については、常時作用している荷重、運転時の状態で施設に作用する荷重及び運転時の異常な過渡変化時の状態と弾性設計用地震動 S d に2分の1を乗じたものによる地震力又は静的地震力とを組み合わせる。 ・屋外に設置される施設については、建物・構築物と同様に積雪荷重及び風荷重を組み合わせる。</p>	<p><地震荷重と事故時荷重との組合せについて> ⇒運転時の異常な過渡変化時及び設計基準事故時の荷重と地震力との組合せ要否の検討内容について補足説明する。 ・[補足耐14]地震荷重と事故時荷重との組合せについて</p>	
<p>(c) 荷重の組合せ上の留意事項 イ. 安全機能を有する施設のうち耐震重要度の異なる施設を支持する建物・構築物の当該部分の支持機能を確認する場合には、支持される施設の耐震重要度に応じた地震力と常時作用している荷重、運転時に施設に作用する荷重とを組み合わせる。 ロ. 安全機能を有する施設のうちの機器・配管系の運転時の異常な過渡変化時及び設計基準事故(以下「事故等」という。)時に生じるそれぞれの荷重については、地震によって引き起こされるおそれのある事故等によって作用する荷重及び地震によって引き起こされるおそれのない事故等であっても、いったん事故等が発生した場合、長時間継続する事故等による荷重は、その事故等の発生確率、継続時間及び地震動の超過確率の関係を踏まえ、適切な地震力と組み合わせ考慮する。 ハ. 安全機能を有する施設及び重大事故等対処施設に適用する動的地震力は、水平2方向及び鉛直方向について適切に組み合わせるものとする。 ニ. 積雪荷重については、屋外に設置されている安全機能を有する施設及び重大事故等対処施設のうち、積雪による受圧面積が小さい施設や、常時作用している荷重に対して積雪荷重の割合が無視できる施設を除き、地震力との組合せを考慮する。 ホ. 風荷重については、屋外の直接風を受ける場所に設置されている安全機能を有する施設及び重大事故等対処施設のうち、風荷重の影響が地震荷重と比べて相対的に無視できないような構造、形状及び仕様の施設においては、地震力との組合せを考慮する。 ヘ. 荷重として考慮する水圧のうち地下水圧については、地下水排水設備による地下水位の低下を踏まえた設計用地下水位に基づき設定する。 ト. 設備分類の異なる重大事故等対処施設を支持する建物・構築物の当該部分の支持機能を確認する場合には、支持される施設の設備分類に応じた地震力と常時作用している荷重(固定荷重、積載荷重、土圧及び水圧)、運転時の状態で施設に作用する荷重及び重大事故等時の状態で施設に作用する荷重並びに積雪荷重及び風荷重を組み合わせる。 チ. 常設耐震重要重大事故等対処設備が設置される重大事故等対処施設の機器・配管系の、常時作用している荷重、運転時の異常な過渡変化時の状態、設計基準事故時の状態及び重大事故等時の状態で施設に作用する荷重のうち、地震によって引き起こされるおそれがない事象による荷重と、基準地震動 S s 又は弾性設計用地震動 S d による地震力との組合せについては、事故事象の発生確率、継続時間及び地震動の年超過確率の積等を考慮し、工学的、総合的に勘案の上設定する。なお、継続時間については対策の成立性も考慮した上で設定する。 リ. 常設耐震重要重大事故等対処設備以外の常設重大事故等対処設備で、代替する安全機能を有する施設がない常設重大事故等対処設備のうち、Sクラスの施設は常設耐震重要重大事故等対処設備に係る機器・配管系の荷重の組合せを適用する。</p>	<p>IV-1-1 耐震設計の基本方針 5.機能維持の基本方針 5.1 構造強度 5.1.3 荷重の組合せ (1) 安全機能を有する施設</p>	<p>【5.1.3 荷重の組合せ(1)】 b. 機器・配管系 (c) 機器・配管系の運転時の異常な過渡変化時及び設計基準事故(以下「事故等」という。)時に生じるそれぞれの荷重については、地震によって引き起こされるおそれのある事故等によって作用する荷重及び地震によって引き起こされるおそれのない事故等であっても、いったん事故等が発生した場合、長時間継続する事故等による荷重は、その事故等の発生確率、継続時間及び地震動の超過確率の関係を踏まえ、適切な地震力と組み合わせ考慮する。 ・運転時の異常な過渡変化時の状態及び設計基準事故の状態では施設に作用する荷重は、運転時の状態で施設に作用する荷重を超えるもの及び長時間施設に作用するものがないため、地震荷重と組み合わせるものはない。</p>	<p><地震荷重と事故時荷重との組合せについて> ⇒運転時の異常な過渡変化時及び設計基準事故時の荷重と地震力との組合せ要否の検討内容について補足説明する。 ・[補足耐14]地震荷重と事故時荷重との組合せについて</p>	
<p>d. 許容限界 各施設の地震力と他の荷重とを組み合わせた状態に対する許容限界は、以下のとおりとし、安全上適切と認められる規格及び基準又は試験等で妥当性が確認されている値を用いる。</p>	<p>IV-1-1 耐震設計の基本方針 5.機能維持の基本方針 5.1 構造強度 5.1.4 荷重の組合せ上の留意事項</p>	<p>【5.1.3 荷重の組合せ(2)】 b. 機器・配管系 (c) 常設耐震重要重大事故等対処設備が設置される重大事故等対処施設の機器・配管系の、常時作用している荷重、運転時の異常な過渡変化時の状態、設計基準事故時の状態及び重大事故等時の状態で施設に作用する荷重のうち、地震によって引き起こされるおそれがない事象による荷重と、基準地震動 S s 又は弾性設計用地震動 S d による地震力との組合せについては、事故事象の発生確率、継続時間及び地震動の年超過確率の積等を考慮し、工学的、総合的に勘案の上設定する。なお、継続時間については対策の成立性も考慮した上で設定する。 ・以上を踏まえ、重大事故等時の状態で施設に作用する荷重と地震力との組合せについては、いったん事故が発生した場合、長時間継続する事象による荷重と弾性設計用地震動 S d による地震力とを組み合わせ、その状態からさらに長期的に継続する事象による荷重と基準地震動 S s による地震力とを組み合わせることとなるが、弾性設計用地震動 S d との組合せの目安となる継続時間がごく僅かであることから、重大事故等時の荷重と組み合わせる地震力は、基準地震動 S s による地震力とする。</p>	<p>※補足すべき事項の対象なし</p>	
<p>d. 許容限界 各施設の地震力と他の荷重とを組み合わせた状態に対する許容限界は、以下のとおりとし、安全上適切と認められる規格及び基準又は試験等で妥当性が確認されている値を用いる。</p>	<p>IV-1-1 耐震設計の基本方針 5.機能維持の基本方針 5.1 構造強度 5.1.5 許容限界</p>	<p>【5.1.4 荷重の組合せ上の留意事項】 (1) 安全機能を有する施設のうちの耐震重要度の異なる施設を支持する建物・構築物の当該部分の支持機能を確認する場合には、支持される施設の耐震重要度に応じた地震力と常時作用している荷重、運転時に施設に作用する荷重とを組み合わせる。 (2) 安全機能を有する施設及び重大事故等対処施設に適用する動的地震力は、水平2方向及び鉛直方向について適切に組み合わせるものとする。 (3) ある荷重の組合せ状態での評価が明らかに厳しいことが判明している場合には、その妥当性を示した上で、その他の荷重の組合せ状態での評価は行わないものとする。 (4) 複数の荷重が同時に作用し、それらの荷重による応力の各ピークの生起時刻に明らかなずれがある場合は、その妥当性を示した上で、必ずしもそれぞれの応力のピーク値を重ねなくてもよいものとする。 (5) 積雪荷重については、屋外に設置されている安全機能を有する施設及び重大事故等対処施設のうち、積雪による受圧面積が小さい施設や、常時作用している荷重に対して積雪荷重の割合が無視できる施設を除き、地震力との組合せを考慮する。 (6) 風荷重については、屋外の直接風を受ける場所に設置されている安全機能を有する施設及び重大事故等対処施設のうち、風荷重の影響が地震荷重と比べて相対的に無視できないような構造、形状及び仕様の施設においては、地震力との組合せを考慮する。 (7) 荷重として考慮する水圧のうち地下水圧については、地下水排水設備による地下水位の低下を踏まえた設計用地下水位に基づき設定する。 (8) 設備分類の異なる重大事故等対処施設を支持する建物・構築物の当該部分の支持機能を確認する場合には、支持される施設の設備分類に応じた地震力と常時作用している荷重(固定荷重、積載荷重、土圧及び水圧)、運転時の状態で施設に作用する荷重及び重大事故等時の状態で施設に作用する荷重並びに積雪荷重及び風荷重を組み合わせる。 (9) 常設耐震重要重大事故等対処設備以外の常設重大事故等対処設備で、代替する安全機能を有する施設がない常設重大事故等対処設備のうち、Sクラスの施設は常設耐震重要重大事故等対処設備に係る機器・配管系の荷重の組合せを適用する。</p>	<p>【5.1.5 許容限界】 ・各施設の地震力と他の荷重とを組み合わせた状態に対する許容限界は次のとおりとし、JEA6461等の安全上適切と認められる規格及び基準又は試験等で妥当性が確認されている値を用いる。</p>	<p>※補足すべき事項の対象なし</p>

基本設計方針		添付書類(1)		添付書類(2)		補足すべき事項
75	(a) 安全機能を有する施設 イ. 建物・構築物 (イ) Sクラスの建物・構築物(土木構造物を除く。) i. 基準地震動S _s による地震力との組合せに対する許容限界 建物・構築物全体としての変形能力(耐震壁のせん断ひずみ等)が終局耐力時の変形に対して十分な余裕を有し、部材・部位ごとのせん断ひずみ・応力等が終局耐力時のせん断ひずみ・応力等に対して、 適切な安全余裕を有することとする。 なお、終局耐力とは、建物・構築物に対する荷重又は応力を漸次増大していくとき、その変形又はひずみが著しく増加するに至る限界の最大耐力とし、既往の実験式等に基づき適切に定めるものとする。 ii. 弾性設計用地震動S _d による地震力又は静的地震力との組合せに対する許容限界 Sクラスの建物・構築物については、地震力に対しておおむね弾性状態に留まるように、発生する応力に対して、建築基準法等の安全上適切と認められる規格及び基準による許容応力度を許容限界とする。	IV-1-1 耐震設計の基本方針 5.機能維持の基本方針 5.1 構造強度 5.1.5 許容限界 (1) 安全機能を有する施設	【5.1.5 許容限界(1)】 a. 建物・構築物 (a) Sクラスの建物・構築物(土木構造物を除く。) イ. 基準地震動S _s による地震力との組合せに対する許容限界 ・建物・構築物全体としての変形能力(耐震壁のせん断ひずみ等)が終局耐力時の変形に対して十分な余裕を有し、部材・部位ごとのせん断ひずみ・応力等が終局耐力時のせん断ひずみ・応力等に対して、適切な安全余裕を持たせることとする。 ・終局耐力とは、建物・構築物に対する荷重又は応力を漸次増大していくとき、その変形又はひずみが著しく増加するに至る限界の最大耐力とし、既往の実験式等に基づき適切に定めるものとする。 ロ. 弾性設計用地震動S _d による地震力又は静的地震力との組合せに対する許容限界 ・地震力に対しておおむね弾性状態に留まるように、発生する応力に対して、建築基準法等の安全上適切と認められる規格及び基準による許容応力度を許容限界とする。	-	-	※補足すべき事項の対象なし
		IV-1-1 耐震設計の基本方針 8.ダクティリティに関する考慮	【8.ダクティリティに関する考慮】 再処理施設は、構造安全性を一層高めるために、材料の選定等に留意し、その構造体のダクティリティを高めるよう設計する。具体的には、「IV-1-1-9 構造計画、材料選択上の留意点」に示す。	-	-	※補足すべき事項の対象なし
76	(ロ) Bクラス及びCクラスの建物・構築物(土木構造物を除く。) 上記(イ)ii.による許容応力度を許容限界とする。	IV-1-1 耐震設計の基本方針 5.機能維持の基本方針 5.1 構造強度 5.1.5 許容限界 (1) 安全機能を有する施設	【5.1.5 許容限界(1)】 a. 建物・構築物 (b) Bクラス及びCクラスの建物・構築物(土木構造物を除く。) 上記(a)ロ.による許容応力度を許容限界とする。	-	-	※補足すべき事項の対象なし
77	(ハ) 建物・構築物の保有水平耐力 建物・構築物(土木構造物を除く。)については、当該建物・構築物の保有水平耐力が必要保有水平耐力に対して、耐震重要度に応じた適切な安全余裕を有していることを確認する。	IV-1-1 耐震設計の基本方針 5.機能維持の基本方針 5.1 構造強度 5.1.5 許容限界 (1) 安全機能を有する施設	【5.1.5 許容限界(1)】 a. 建物・構築物 (d) 建物・構築物の保有水平耐力 ・建物・構築物(構築物(屋外機械基礎)及び土木構造物を除く。)については、当該建物・構築物の保有水平耐力が必要保有水平耐力に対して、耐震重要度に応じた適切な安全余裕を有していることを確認する。	-	-	※補足すべき事項の対象なし
78	(ニ) 屋外重要土木構造物 i. 基準地震動S _s による地震力との組合せに対する許容限界 構造部材の曲げについては限界層間変形角(層間変形角1/100)又は終局曲率、せん断についてはせん断耐力を許容限界とする。終局曲率及びせん断耐力の許容限界に対しては適切な安全余裕を持たせることとする。 なお、限界層間変形角、終局曲率及びせん断耐力の許容限界に対しては適切な安全余裕を持たせることとする。 ii. 弾性設計用地震動S _d による地震力又は静的地震力との組合せに対する許容限界 地震力に対しておおむね弾性状態に留まるように、発生する応力に対して、安全上適切と認められる規格及び基準による許容応力度を許容限界とする。	IV-1-1 耐震設計の基本方針 5.機能維持の基本方針 5.1 構造強度 5.1.5 許容限界 (1) 安全機能を有する施設	【5.1.5 許容限界(1)】 a. 建物・構築物 (e) 屋外重要土木構造物 イ. 基準地震動S _s による地震力との組合せに対する許容限界 構造部材の曲げについては限界層間変形角(層間変形角1/100)又は終局曲率、せん断についてはせん断耐力を許容限界とする。 なお、限界層間変形角、終局曲率及びせん断耐力の許容限界に対しては適切な安全余裕を持たせることとする。 ロ. 弾性設計用地震動S _d による地震力又は静的地震力との組合せに対する許容限界 地震力に対しておおむね弾性状態に留まるように、発生する応力に対して、安全上適切と認められる規格及び基準による許容応力度を許容限界とする。	-	-	※補足すべき事項の対象なし
		IV-1-1 耐震設計の基本方針 8.ダクティリティに関する考慮	【8.ダクティリティに関する考慮】 再処理施設は、構造安全性を一層高めるために、材料の選定等に留意し、その構造体のダクティリティを高めるよう設計する。具体的には、「IV-1-1-9 構造計画、材料選択上の留意点」に示す。	-	-	※補足すべき事項の対象なし
79	(ホ) その他の土木構造物 安全上適切と認められる規格及び基準による許容応力度を許容限界とする。	IV-1-1 耐震設計の基本方針 5.機能維持の基本方針 5.1 構造強度 5.1.5 許容限界 (1) 安全機能を有する施設	【5.1.5 許容限界(1)】 a. 建物・構築物 (f) その他の土木構造物 安全上適切と認められる規格及び基準による許容応力度を許容限界とする。	-	-	※補足すべき事項の対象なし
		IV-1-1 耐震設計の基本方針 8.ダクティリティに関する考慮	【8.ダクティリティに関する考慮】 再処理施設は、構造安全性を一層高めるために、材料の選定等に留意し、その構造体のダクティリティを高めるよう設計する。具体的には、「IV-1-1-9 構造計画、材料選択上の留意点」に示す。	-	-	※補足すべき事項の対象なし

基本設計方針	添付書類(1)		添付書類(2)	補足すべき事項
<p>ロ. 機器・配管系 (イ) Sクラスの機器・配管系 i. 基準地震動S_sによる地震力との組合せに対する許容限界 塑性域に達するひずみが生じる場合であっても、その量が小さなレベルに留まって破断延性限界に十分な余裕を有し、その施設の機能に影響を及ぼすことがない限度に応力、荷重を制限する値を許容限界とする。 ii. 弾性設計用地震動S_dによる地震力又は静的地震力との組合せに対する許容限界 発生する応力に対して、応答が全体的におおむね弾性状態に留まるように、降伏応力又はこれと同等の安全性を有する応力を許容限界とする。</p>	<p>IV-1-1 耐震設計の基本方針 5. 機能維持の基本方針 5.1 構造強度 5.1.5 許容限界 (1) 安全機能を有する施設</p> <p>IV-1-1 耐震設計の基本方針 8. ダクティリティに関する考慮</p> <p>IV-1-1 耐震設計の基本方針 10. 耐震計算の基本方針 10.2 機器・配管系</p>	<p>【5.1.5 許容限界(1)】 b. 機器・配管系 (a) Sクラスの機器・配管系 イ. 基準地震動S_sによる地震力との組合せに対する許容限界 ・塑性域に達するひずみが生じる場合であっても、その量が小さなレベルに留まって破断延性限界に十分な余裕を有し、その施設の機能に影響を及ぼすことがない限度に応力、荷重を制限する値を許容限界とする。 ロ. 弾性設計用地震動S_dによる地震力又は静的地震力との組合せに対する許容限界 ・発生する応力に対して、応答が全体的におおむね弾性状態に留まるように、降伏応力又はこれと同等の安全性を有する応力を許容限界とする。</p> <p>【8.ダクティリティに関する考慮】 再処理施設は、構造安全性を一層高めるために、材料の選定等に留意し、その構造体のダクティリティを高めるよう設計する。具体的には、「IV-1-1-9 構造計画、材料選択上の留意点」に示す。</p> <p>【10.2 機器・配管系】 ・地震時及び地震後に機能維持が要求される設備については、地震応答解析により機器・配管系に作用する加速度が振動試験又は解析等により機能が維持できることを確認した加速度(動的機能維持確認済加速度又は電氣的機能維持確認済加速度)以下、若しくは、静的又は動的解析により求まる地震荷重が許容荷重以下となることを確認する。</p>	<p>-</p> <p>-</p> <p>-</p>	<p><疲労評価における等価繰返し回数の設定> ⇒疲労評価を実施している設備について、適用する等価繰返し回数の設定方法、サイクル数のカウント方法等の妥当性について補足説明する。 ・[補足耐21]耐震評価における等価繰返し回数の妥当性確認について</p> <p>※補足すべき事項の対象なし</p> <p><S_d評価結果の記載方法> ⇒Sクラス施設の耐震計算書におけるS_d評価結果の記載方法について補足説明する。 ・[補足耐20]耐震Sクラス設備の耐震計算書におけるS_d評価結果の記載方法</p> <p><固有周期の算出> ⇒固有周期を算出せず剛とみなしている設備の固有周期について補足説明する。 ・[補足耐37]剛な設備の固有周期の算出について</p> <p><機器・配管系の類型化> ⇒既設工認時の評価内容及び説明内容を踏まえ機器、配管系に対する類型化の分類の考え方について補足説明する。 ・[補足耐38]機器・配管系の類型化に対する分類の考え方について</p> <p><耐震計算書の作成方針> ⇒機器設備の耐震計算書の作成方針について構成、記載方法、記載の留意点等について補足説明する。 ・[補足耐39]機器設備の耐震計算書の作成について</p> <p><既設工認からの変更点> ⇒機器の耐震計算書作成の基本方針の変更点として、定型式への最新知見の反映等の考え方について補足説明する。 ・[補足耐41]機器の耐震計算における既設工認からの計算式の変更点について ⇒耐震設計における既設工認から評価内容の評価条件等の変更内容について補足説明する。 ・[補足耐42]既設工認からの変更点について</p>
<p>(ロ) Bクラス及びCクラスの機器・配管系 上記(イ)ii.による応力を許容限界とする。</p>	<p>IV-1-1 耐震設計の基本方針 5. 機能維持の基本方針 5.1 構造強度 5.1.5 許容限界 (1) 安全機能を有する施設</p>	<p>【5.1.5 許容限界(1)】 b. 機器・配管系 (b) Bクラス及びCクラスの機器・配管系 ・上記b.(a)ロ.による応力を許容限界とする。</p>	<p>-</p>	<p><疲労評価における等価繰返し回数設定> ⇒疲労評価を実施している設備について、適用する等価繰返し回数の設定方法、サイクル数のカウント方法等の妥当性について補足説明する。 ・[補足耐21]耐震評価における等価繰返し回数の妥当性確認について</p>
<p>(b) 重大事故等対処施設 イ. 建物・構築物 (イ) 常設耐震重要重大事故等対処設備が設置される重大事故等対処施設の建物・構築物 上記(a)イ.(イ)i.を適用する。</p>	<p>IV-1-1 耐震設計の基本方針 5. 機能維持の基本方針 5.1 構造強度 5.1.5 許容限界 (2) 重大事故等対処施設</p>	<p>【5.1.5 許容限界(2)】 a. 建物・構築物 (a) 常設耐震重要重大事故等対処設備が設置される重大事故等対処施設の建物・構築物 ・上記(1)a.(a)イ.を適用する。</p>	<p>-</p>	<p>※補足すべき事項の対象なし</p>
	<p>IV-1-1 耐震設計の基本方針 8. ダクティリティに関する考慮</p>	<p>【8.ダクティリティに関する考慮】 再処理施設は、構造安全性を一層高めるために、材料の選定等に留意し、その構造体のダクティリティを高めるよう設計する。具体的には、「IV-1-1-9 構造計画、材料選択上の留意点」に示す。</p>	<p>-</p>	<p>※補足すべき事項の対象なし</p>

基本設計方針		添付書類(1)		添付書類(2)		補足すべき事項
83	(ロ) 常設耐震重要重大事故等対処設備以外の常設重大事故等対処設備が設置される重大事故等対処施設の建物・構築物 上記(a)イ、(ロ)を適用する。	IV-1-1 耐震設計の基本方針 5.機能維持の基本方針 5.1 構造強度 5.1.5 許容限界 (2) 重大事故等対処施設	【5.1.5 許容限界(2)】 a. 建物・構築物 (b) 常設耐震重要重大事故等対処設備以外の常設重大事故等対処設備が設置される重大事故等対処施設の建物・構築物 ・上記(1)a、(b)による許容応力度を許容限界とする。	-	-	※補足すべき事項の対象なし
84	(ハ) 設備分類の異なる重大事故等対処施設を支持する建物・構築物(土木構造物を除く。)上記(イ)を適用するほか、建物・構築物は、変形等に対してその支持機能が損なわれない設計とする。なお、当該施設を支持する建物・構築物の支持機能が損なわれないことを確認する際の地震力は、支持される施設に適用される地震力とする。	IV-1-1 耐震設計の基本方針 5.機能維持の基本方針 5.1 構造強度 5.1.5 許容限界 (2) 重大事故等対処施設	【5.1.5 許容限界(2)】 a. 建物・構築物 (c)設備分類の異なる重大事故等対処施設を支持する建物・構築物(土木構造物を除く。)・上記(a)を適用するほか、設備分類の異なる重大事故等対処施設を支持する建物・構築物は、変形等に対してその支持機能が損なわれない設計とする。なお、当該施設を支持する建物・構築物の支持機能が損なわれないことを確認する際の地震力は、支持される施設に適用される地震力とする。	-	-	※補足すべき事項の対象なし
85	(ニ) 建物・構築物の保有水平耐力 建物・構築物(土木構造物を除く。)については、当該建物・構築物の保有水平耐力が必要保有水平耐力に対して、重大事故等対処施設が代替する機能を有する安全機能を有する施設が属する耐震重要度に応じた適切な安全余裕を有していることを確認する。	IV-1-1 耐震設計の基本方針 5.機能維持の基本方針 5.1 構造強度 5.1.5 許容限界 (2) 重大事故等対処施設	【5.1.5 許容限界(2)】 a. 建物・構築物 (d) 建物・構築物の保有水平耐力 ・建物・構築物(構築物(屋外機械基礎)及び土木構造物を除く。)については、当該建物・構築物の保有水平耐力が必要保有水平耐力に対して、重大事故等対処設備が代替する機能を有する安全機能を有する施設が属する耐震重要度に応じた適切な安全余裕を有していることを確認する。	-	-	※補足すべき事項の対象なし
86		IV-1-1 耐震設計の基本方針 5.機能維持の基本方針 5.1 構造強度 5.1.5 許容限界 (2) 重大事故等対処施設	【5.1.5 許容限界(2)】 a. 建物・構築物 (e) 設備分類の異なる重大事故等対処施設を支持する土木構造物 ・上記(1)a、(e)イ、又は(1)a、(e)ロを適用するほか、設備分類の異なる重大事故等対処施設を支持する土木構造物は、変形に対してその支持機能が損なわれない設計とする。なお、当該施設を支持する土木構造物の支持機能が損なわれないことを確認する際の地震力は、支持される施設に適用される地震力とする。	-	-	※補足すべき事項の対象なし
		IV-1-1 耐震設計の基本方針 8.ダクティリティに関する考慮	【8.ダクティリティに関する考慮】 再処理施設は、構造安全性を一層高めるために、材料の選定等に留意し、その構造体のダクティリティを高めるよう設計する。具体的には、「IV-1-1-9 構造計画、材料選択上の留意点」に示す。	-	-	※補足すべき事項の対象なし

基本設計方針	添付書類(1)		添付書類(2)	補足すべき事項
<p>ロ. 機器・配管系 (イ) 常設耐震重要重大事故等対処設備が設置される重大事故等対処施設の機器・配管系 上記(a)ロ.(イ) i. を適用する。</p>	<p>IV-1-1 耐震設計の基本方針 5. 機能維持の基本方針 5.1 構造強度 5.1.5 許容限界 (2) 重大事故等対処施設</p>	-	-	<p><疲労評価における等価繰返し回数の設定> ⇒疲労評価を実施している設備について、適用する等価繰返し回数の設定方法、サイクル数のカウント方法等の妥当性について補足説明する。 ・[補足耐21]耐震評価における等価繰返し回数の妥当性確認について</p>
87	<p>IV-1-1 耐震設計の基本方針 8. ダクティリティに関する考慮</p>	-	-	<p>※補足すべき事項の対象なし</p>
88	<p>IV-1-1 耐震設計の基本方針 10. 耐震計算の基本方針 10.2 機器・配管系</p>	-	-	<p><S d 評価結果の記載方法> ⇒S クラス施設の耐震計算書における S d 評価結果の記載方法について補足説明する。 ・[補足耐20]耐震 S クラス設備の耐震計算書における S d 評価結果の記載方法</p> <p><固有周期の算出> ⇒固有周期を算出せず剛とみなしている設備の固有周期について補足説明する。 ・[補足耐37]剛な設備の固有周期の算出について</p> <p><機器・配管系の類型化> ⇒既設工認時の評価内容及び説明内容を踏まえ機器、配管系に対する類型化の分類の考え方について補足説明する。 ・[補足耐38]機器・配管系の類型化に対する分類の考え方について</p> <p><耐震計算書の作成方針> ⇒機電設備の耐震計算書の作成方針について構成、記載方法、記載の留意点等について補足説明する。 ・[補足耐39]機電設備の耐震計算書の作成について</p> <p><既設工認からの変更点> ⇒機器の耐震計算書作成の基本方針の変更点として、定型式への最新知見の反映等の考え方について補足説明する。 ・[補足耐41]機器の耐震計算における既設工認からの計算式の変更点について ⇒耐震設計における既設工認から評価内容の評価条件等の変更内容について補足説明する。 ・[補足耐42]既設工認からの変更点について</p>
	<p>IV-1-1 耐震設計の基本方針 5. 機能維持の基本方針 5.1 構造強度 5.1.5 許容限界 (2) 重大事故等対処施設</p>	-	-	<p><疲労評価における等価繰返し回数設定> ⇒疲労評価を実施している設備について、適用する等価繰返し回数の設定方法、サイクル数のカウント方法等の妥当性について補足説明する。 ・[補足耐21]耐震評価における等価繰返し回数の妥当性確認について</p>

基本設計方針	添付書類(1)		添付書類(2)	補足すべき事項
<p>(5) 設計における留意事項 a. 主要設備等、補助設備、直接支持構造物及び間接支持構造物 主要設備等、補助設備及び直接支持構造物については、耐震重要度に応じた地震力に十分耐えられる設計とするとともに、安全機能を有する施設のうち、耐震重要施設に該当する設備は、基準地震動Ssによる地震力に対してその安全機能が損なわれるおそれがない設計とする。</p>	<p>IV-1-1 耐震設計の基本方針 9. 機器・配管系の支持方針について</p>		-	<p><コンクリート定着部について> ⇒屋内設備のコンクリート定着部が基礎ボルトより耐震性を有しており、基礎ボルトの耐震評価を実施することによる健全性について補足説明する。 ・[補足耐22]屋内設備に対するアンカー定着部の評価について</p> <p><配管系の評価手法> ⇒配管系の耐震評価における配管の評価手法として既設工認にて設定した標準支持間隔に対する対応等について補足説明する。 ・[補足耐40]配管系の評価手法(定ピッチスパン法)について</p> <p><機器・配管の相対変位に対する考慮> ⇒機器と配管の取り合い部に対し、相対変位を考慮した設計内容について補足説明する。 ・[補足耐43]機器と配管の相対変位に対する設計上の扱いについて</p> <p><ダクトの耐震設計について> ⇒ダクト評価で用いる補正係数、安全係数の設定根拠について補足説明する。 ・[補足耐44]ダクト評価で用いる補正係数、安全係数の設定根拠について</p>
<p>また、間接支持構造物については、支持する主要設備等又は補助設備の耐震重要度に適用する地震動による地震力に対して支持機能が損なわれない設計とする。</p>	<p>IV-1-1 耐震設計の基本方針 5. 機能維持の基本方針 a. 建物・構築物 5.1 構造強度 5.1.5 許容限界 (1) 安全機能を有する施設 a. 建物・構築物 (c) 耐震重要度の異なる施設を支持する建物・構築物(土木構造物を除く。)</p>	<p>【5.1.5 許容限界】 (1) 安全機能を有する施設 a. 建物・構築物 (c) 耐震重要度の異なる施設を支持する建物・構築物(土木構造物を除く。) 上記(a)イ.を適用するほか、耐震重要度の異なる施設を支持する建物・構築物は、変形等に対してその支持機能が損なわれない設計とする。なお、当該施設を支持する建物・構築物の支持機能が損なわれないことを確認する際の地震力は、支持される施設に適用される地震力とする。</p>	-	※補足すべき事項の対象なし
	<p>IV-1-1 耐震設計の基本方針 5. 機能維持の基本方針 5.1 構造強度 5.1.5 許容限界 (1) 安全機能を有する施設 a. 建物・構築物 (g) 耐震重要度の異なる施設を支持する土木構造物</p>	<p>【5.1.5 許容限界】 (1) 安全機能を有する施設 a. 建物・構築物 (g) 耐震重要度の異なる施設を支持する土木構造物 上記(e)イ.またはロ.を適用するほか、耐震重要度の異なる施設を支持する土木構造物は、変形等に対してその支持機能が損なわれない設計とする。なお、当該施設を支持する土木構造物が支持機能を損なわれないことを確認する際の地震力は、支持される施設に適用される地震力とする。</p>	-	※補足すべき事項の対象なし
<p>b. 波及的影響に対する考慮 耐震重要施設は、耐震重要度の下位のクラスに属する施設の波及的影響によって、その安全機能が損なわれないものとする。</p>	<p>IV-1-1 耐震設計の基本方針 3. 耐震設計上の重要度分類及び重大事故等対処施設の設備分類 3.3 波及的影響に対する考慮</p>	<p>【3.3 波及的影響に対する考慮】 ・「3.1 安全機能を有する施設の耐震設計上の重要度分類」においてSクラスの施設に分類する施設である耐震重要施設は、耐震重要度の下位のクラスに属する施設の波及的影響によって、その安全機能を損なわれない設計とする。</p>	-	<p><波及的影響に対する考慮> ⇒波及的影響の設計対象施設の抽出の考え方、抽出過程、抽出結果について補足説明する。 ・[補足耐4]下位クラス施設の波及的影響の検討について(建物・構築物、機器・配管系)</p>
	<p>IV-1-1 耐震設計の基本方針 6. 構造計画と配置計画</p>	<p>【6. 構造計画と配置計画】 ・建物・構築物の建屋間相対変位を考慮しても、建物・構築物及び機器・配管系の耐震安全性を確保する設計とする。 ・下位クラス施設は、耐震重要施設及び常設耐震重要重大事故等対処設備が設置される重大事故等対処施設に対して隔離を取り配置する、又は耐震重要施設の有する安全機能及び重大事故等に対処するために必要な機能を保持する設計とする。</p>	-	

基本設計方針	添付書類(1)		添付書類(2)		補足すべき事項
<p>評価に当たっては、以下の4つの観点をもとに、敷地全体を俯瞰した調査・検討を行い、各観点より選定した事象に対する波及的影響の評価により波及的影響を考慮すべき施設を抽出し、耐震重要施設の安全機能への影響がないことを確認する。</p> <p>波及的影響の評価に当たっては、耐震重要施設の設計に用いる地震動又は地震力を適用する。なお、地震動又は地震力の選定に当たっては、施設の配置状況、使用時間を踏まえて適切に設定する。また、波及的影響の確認においては水平2方向及び鉛直方向の地震力が同時に作用する場合に影響を及ぼす可能性のある施設、設備を選定し評価する。</p> <p>ここで、下位クラス施設とは、耐震重要施設以外の再処理施設内にある施設(資機材等含む。)をいう。</p> <p>波及的影響を防止するよう現場を維持するため、機器設置時の配慮事項等を保安規定に定めて、管理する。</p> <p>なお、原子力施設及び化学プラント等の地震被害情報をもとに、4つの観点以外に検討すべき事項がないか確認し、新たな検討事項が抽出された場合には、その観点を追加する。</p>	<p>IV-1-1 耐震設計の基本方針</p> <p>3.耐震設計上の重要度分類及び重大事故等対処施設の設備分類</p> <p>3.3 波及的影響に対する考慮</p>	<p>【3.3 波及的影響に対する考慮】</p> <ul style="list-style-type: none"> この設計における評価に当たっては、以下の4つの観点をもとに、敷地全体及びその周辺を俯瞰した調査・検討を行い、各観点より選定した事象に対する波及的影響の評価により波及的影響を考慮すべき施設を抽出し、耐震重要施設の安全機能への影響がないことを確認する。 波及的影響の評価に当たっては、耐震重要施設の設計に用いる地震動又は地震力を適用し、地震動又は地震力の選定は、施設の配置状況、使用時間を踏まえて適切に設定する。 設定した地震動又は地震力について、動的地震力を用いる場合は、水平2方向及び鉛直方向の地震力が同時に作用する場合に影響を及ぼす可能性のある施設、設備を選定し評価する。 下位クラス施設とは、耐震重要施設の周辺にある耐震重要施設以外の再処理施設内にある施設(安全機能を有する施設以外の施設及び資機材等含む)をいう。 原子力施設及び化学プラント等の地震被害情報から新たに検討すべき事項が抽出された場合は、これを追加する。 	-	-	<p><波及的影響に対する考慮></p> <p>⇒波及的影響の設計対象施設の抽出の考え方、抽出過程、抽出結果について補足説明する。</p> <ul style="list-style-type: none"> [補足耐4]下位クラス施設の波及的影響の検討について(建物・構築物、機器・配管系)
	-	-	IV-1-1-4 波及的影響に係る基本方針	<p>【3.1 波及的影響を考慮した施設の設計の観点】</p> <ul style="list-style-type: none"> 波及的影響を考慮した施設の設計においては、「再処理施設の位置、構造及び設備の基準に関する規則の解釈別記2」(以下「別記2」という。)に記載の4つの観点で実施する。 原子力施設情報公開ライブラリ(NUCIA:ニューシア)から、原子力施設の地震被害情報、官公庁等の公開情報から化学プラント等の地震被害情報を抽出し、その要因を整理する。地震被害の発生要因が別記2(1)～(4)の検討事項に分類されない要因については、その要因も設計の観点到追加する。 	
	-	-	IV-1-1-4 波及的影響に係る基本方針	<p>【4.波及的影響の設計対象とする下位クラス施設】</p> <ul style="list-style-type: none"> 「3. 波及的影響を考慮した施設の設計方針」に基づき、構造強度等を確保するように設計するものとして選定した下位クラス施設を示す。 	
	-	-	IV-1-1-4 波及的影響に係る基本方針	<p>【5.波及的影響の設計対象とする下位クラス施設の耐震設計方針】</p> <ul style="list-style-type: none"> 「4. 波及的影響の設計対象とする下位クラス施設」において選定した施設の耐震設計方針を示す。 	
	-	-	IV-1-1-4 波及的影響に係る基本方針	<p>【5.3 設計用地震動又は地震力】</p> <ul style="list-style-type: none"> 波及的影響の設計対象とする下位クラス施設においては、上位クラス施設の設計に用いる地震動又は地震力を適用する。 	
	-	-	IV-1-1-4 波及的影響に係る基本方針	<p>【6.工事段階における下位クラス施設の調査・検討】</p> <ul style="list-style-type: none"> 工事段階においても、上位クラス施設の設計段階の際に検討した配置・補強等が設計どおりに施されていることを、敷地全体を俯瞰した調査・検討を行うことで確認する。また、仮置資材等、現場の配置状況等の確認を必要とする下位クラス施設についても合わせて確認する。 工事段階における検討は、別記2の4つの観点のうち、(3)及び(4)の観点、すなわち下位クラス施設の損傷、転倒及び落下による影響について、現場調査により実施する。 工事段階における確認の後も、波及的影響を防止するよう現場を保持するため、保安規定に機器設置時の配慮事項等を定めて管理する。 	

基本設計方針	添付書類(1)	添付書類(2)	補足すべき事項
<p>(a) 設置地盤及び地震応答性状の相違に起因する相対変位又は不等沈下による影響イ、不等沈下耐震重要施設の設計に用いる地震動又は地震力に対して不等沈下により、耐震重要施設の安全機能への影響がないことを確認する。 相対変位耐震重要施設の設計に用いる地震動又は地震力による下位クラス施設と耐震重要施設の相対変位により、耐震重要施設の安全機能への影響がないことを確認する。</p> <p>(b) 耐震重要施設と下位クラス施設との接続部における相互影響耐震重要施設の設計に用いる地震動又は地震力に対して、耐震重要施設に接続する下位クラス施設の損傷により、耐震重要施設の安全機能への影響がないことを確認する。</p> <p>(c) 建屋内における下位クラス施設の損傷、転倒及び落下による耐震重要施設への影響耐震重要施設の設計に用いる地震動又は地震力に対して、建屋内の下位クラス施設の損傷、転倒及び落下により、耐震重要施設の安全機能への影響がないことを確認する。</p> <p>(d) 建屋外における下位クラス施設の損傷、転倒及び落下による耐震重要施設への影響耐震重要施設の設計に用いる地震動又は地震力に対して、建屋外の下位クラス施設の損傷、転倒及び落下により、耐震重要施設の安全機能への影響がないことを確認する。</p>	<p>IV-1-1 耐震設計の基本方針 3. 耐震設計上の重要度分類及び重大事故等対処施設の設備分類 3.3 波及的影響に対する考慮</p> <p>【3.3 波及的影響に対する考慮】 (1) 設置地盤及び地震応答性状の相違に起因する相対変位又は不等沈下による影響 a. 不等沈下 ・耐震重要施設の設計に用いる地震動又は地震力に伴う不等沈下による、耐震重要施設の安全機能への影響 b. 相対変位 ・耐震重要施設の設計に用いる地震動又は地震力に伴う下位クラス施設と耐震重要施設の相対変位による、耐震重要施設の安全機能への影響 (2) 耐震重要施設と下位クラス施設との接続部における相互影響 ・耐震重要施設の設計に用いる地震動又は地震力に伴う、耐震重要施設に接続する下位クラス施設の損傷による、耐震重要施設の安全機能への影響 (3) 建屋内における下位クラス施設の損傷、転倒及び落下による耐震重要施設への影響 ・耐震重要施設の設計に用いる地震動又は地震力に伴う、建屋内の下位クラス施設の損傷、転倒及び落下による、耐震重要施設の安全機能への影響 (4) 建屋外における下位クラス施設の損傷、転倒及び落下による耐震重要施設への影響 ・耐震重要施設の設計に用いる地震動又は地震力に伴う、建屋外の下位クラス施設の損傷、転倒及び落下による、耐震重要施設の安全機能への影響 ・波及的影響を考慮すべきこれらの下位クラス施設及びそれに適用する地震動を「IV-1-1-3 重要度分類及び重大事故等対処施設の設備分類の基本方針」の第2.4-1表及び第2.4-2表に示す。これらの波及的影響を考慮すべき下位クラス施設は、耐震重要施設の有する安全機能を保持するよう設計する。 ・工事段階においても、耐震重要施設の設計段階の際に検討した配置・補強等が設計どおりに施されていることを、敷地全体及びその周辺を俯瞰した調査・検討を行うことで確認する。また、仮置容材等、現場の配置状況等の確認を必要とする下位クラス施設についても併せて確認する。 ・以上の詳細な方針は、「IV-1-1-4 波及的影響に係る基本方針」に示す。</p>	<p>—</p> <p>IV-1-1-4 波及的影響に係る基本方針 3. 波及的影響を考慮した施設の設計方針 3.2 不等沈下又は相対変位の観点による設計</p> <p>IV-1-1-4 波及的影響に係る基本方針 3. 波及的影響を考慮した施設の設計方針 3.3 接続部の観点による設計</p> <p>IV-1-1-4 波及的影響に係る基本方針 3. 波及的影響を考慮した施設の設計方針 3.4 損傷、転倒及び落下の観点による建屋内施設の設計</p> <p>IV-1-1-4 波及的影響に係る基本方針 3. 波及的影響を考慮した施設の設計方針 3.5 損傷、転倒及び落下の観点による建屋外施設の設計</p> <p>IV-1-1-4 波及的影響に係る基本方針 4. 波及的影響の設計対象とする下位クラス施設</p> <p>IV-1-1-4 波及的影響に係る基本方針 5. 波及的影響の設計対象とする下位クラス施設の耐震設計方針</p>	<p>補足すべき事項</p> <p><波及的影響に対する考慮> ⇒波及的影響の設計対象施設の抽出の考え方、抽出過程、抽出結果について補足説明する。 ・[補足耐4]下位クラス施設の波及的影響の検討について(建物・構築物、機器・配管系)</p> <p>※補足すべき事項の対象なし</p>
<p>93</p> <p>なお、常設耐震重要重大事故等対処設備が設置される重大事故等対処施設に対する波及的影響については、「耐震重要施設」を「常設耐震重要重大事故等対処設備が設置される重大事故等対処施設」に、「耐震重要度の下位のクラスに属する施設」を「常設耐震重要重大事故等対処設備が設置される重大事故等対処施設以外の施設」に、「安全機能」を「重大事故等に対処するために必要な機能」に読み替えて適用する。</p>	<p>IV-1-1 耐震設計の基本方針 3. 耐震設計上の重要度分類及び重大事故等対処施設の設備分類 3.3 波及的影響に対する考慮</p> <p>【3.3 波及的影響に対する考慮】 ・常設耐震重要重大事故等対処設備が設置される重大事故等対処施設に対する波及的影響については、「耐震重要施設」を「常設耐震重要重大事故等対処設備が設置される重大事故等対処施設」に、「耐震重要度の下位のクラスに属する施設」を「常設耐震重要重大事故等対処設備が設置される重大事故等対処施設以外の施設」に、「安全機能」を「重大事故等に対処するために必要な機能」に読み替えて適用する。</p>	<p>—</p>	<p>—</p>

基本設計方針	添付書類(1)	添付書類(2)	補足すべき事項
<p>c. 建物・構築物への地下水の影響 耐震設計において地下水位の低下を期待する建物・構築物は、周囲の地下水を排水し、基礎スラブ底面レベル以下に地下水を維持できるような地下水排水設備(サブドレンポンプ、水位検出器等)を設置する。また、基準地震動 S s による地震力に対して、必要な機能が保持できる設計とする。また、非常用電源設備又は基準地震動 S s による地震力に対し機能維持が可能な発電機からの給電が可能な設計とする。</p>	<p>IV-1-1 耐震設計の基本方針 6. 構造計画と配置計画</p> <p>IV-1-1 耐震設計の基本方針 10. 耐震計算の基本方針 10.1 建物・構築物</p>	<p>IV-1-1-9 構造計画、材料選択上の留意点 2. 構造計画 2.1 建物・構築物</p>	<p><地下水排水設備> ⇒地下水排水設備に関する設計の考え方を示すため、地下水排水設備に関する設計内容について補足説明する。 ・[補足耐36]建物・構築物周辺の設計用地下水位の設定について</p>
<p>d. 一関東評価用地震動(鉛直) 基準地震動 S s-C 4 は、水平方向の地震動のみであることから、水平方向と鉛直方向の地震力を組み合わせた影響評価を行う場合には、工学的に水平方向の地震動から設定した鉛直方向の評価用地震動(以下「一関東評価用地震動(鉛直)」という。)による地震力を用いて、水平方向と鉛直方向の地震力を組み合わせた影響が考えられる施設に対して、許容限界の範囲内に留まることを確認する。</p>	<p>IV-1-1 耐震設計の基本方針 10. 耐震計算の基本方針 10.1 建物・構築物</p> <p>IV-1-1 耐震設計の基本方針 10. 耐震計算の基本方針 10.2 機器・配管系</p>	<p>IV-2-4-1 一関東評価用地震動(鉛直)に関する影響評価結果</p>	<p><一関東評価用地震動(鉛直)> ⇒一関東評価用地震動(鉛直)を用いた影響評価に関する検討内容及び影響評価結果について補足説明する。 ・[補足耐17]一関東評価用地震動(鉛直)に対する影響評価について(建物、屋外機械基礎) ・[補足耐18]竜巻防護対策設備の一関東評価用地震動(鉛直)に対する影響評価について ・[補足耐48]土木構造物の一関東評価用地震動(鉛直)に対する影響評価について</p>
<p>(6) 緊急時対策所 緊急時対策所については、基準地震動 S s による地震力に対して、重大事故等に対処するために必要な機能が損なわれるおそれがない設計とする。緊急時対策建屋については、耐震構造とし、基準地震動 S s による地震力に対して、遮蔽機能を確保する設計とする。 また、緊急時対策所の居住性を確保するため、鉄筋コンクリート構造とし、基準地震動 S s による地震力に対して、緊急時対策建屋の換気設備の性能とあいまって十分な気密性を確保する設計とする。なお、地震力の算定方法及び荷重の組合せと許容限界については、「(3)地震力の算定方法」及び「(4)荷重の組合せと許容限界」に示す建物・構築物及び機器・配管系を適用する。</p>	<p>IV-1-1 耐震設計の基本方針 5. 機能維持の基本方針 5.2 機能維持 (1) 建物・構築物 b. 重大事故等対処施設</p>	<p>【5.2 機能維持(1)】 b. 重大事故等対処施設 (a) 遮蔽機能の維持 ・遮蔽機能の維持が要求される施設は、重大事故等対処施設の設備分類に応じた地震動に対して、「5.2(1)a.(c) 遮蔽機能の維持」と同様の設計を行うことで、遮蔽機能が維持できる設計とする。 (b) 気密性の維持 ・気密性の維持が要求される施設は、地震時及び地震後において、居住性確保のため、事故時に放射性気体の流入を防ぐことを目的として、重大事故等対処施設の設備分類に応じた地震動に対して、「5.1 構造強度」に基づく構造強度を確保すること及び換気設備の換気機能とあいまって施設の気圧差を確保することで、必要な気密性が維持できる設計とする。</p>	<p><再処理施設の要求機能> ⇒再処理施設の要求機能について補足説明する。 ・[補足耐53]耐震設計における安全機能の整理について</p> <p><土木構造物の要求機能> ⇒土木構造物の要求機能について補足説明する。 ・[補足耐2]洞道の設工認申請上の取り扱いについて</p>
<p>(7) 地震による周辺斜面の崩壊に対する設計方針 耐震重要施設及び常設耐震重要重大事故等対処設備が設置される重大事故等対処施設については、基準地震動 S s による地震力により周辺斜面の崩壊の影響がないことが確認された場所に設置する。なお、耐震重要施設及び常設耐震重要重大事故等対処設備が設置される重大事故等対処施設周辺においては平坦な造成地であることから、地震力に対して、施設の安全機能及び重大事故等に対処するために必要な機能が重大な影響を与えるような崩壊を起こすおそれのある斜面はない。</p>	<p>IV-1-1 耐震設計の基本方針 7. 地震による周辺斜面の崩壊に対する設計方針</p>	<p>【7. 地震による周辺斜面の崩壊に対する設計方針】 ・耐震重要施設及び常設耐震重要重大事故等対処設備が設置される重大事故等対処施設については、基準地震動 S s による地震力により周辺斜面の崩壊の影響がないことが確認された場所に設置する。具体的には、JEG4601の安定性評価の対象とすべき斜面や、土砂災害防止法での土砂災害警戒区域の設定離間距離を参考に、個々の斜面高を踏まえて対象斜面を抽出する。 ・上記に基づく対象斜面の抽出については、事業指定(変更許可)申請書にて記載、確認されており、その結果、耐震重要施設及び常設耐震重要重大事故等対処設備が設置される重大事故等対処施設周辺においては、地震力に対して、施設の安全機能及び重大事故等に対処するために必要な機能が重大な影響を与えるような崩壊を起こすおそれのある斜面はないことを確認している。</p>	<p>※補足すべき事項の対象なし</p>

補足説明すべき項目の抽出
 (第五条 (安全機能を有する施設の地盤)、第三十二条 (重大事故等対処施設の地盤)、
 第六条、第三十三条 (地震による損傷の防止))

基本設計方針からの展開で抽出された補足説明が必要な項目				
IV-1-1-1 耐震設計の基本方針	【5.1.5】許容限界 【10.1】建物・構築物	<地盤の支持力度> <液状化による影響評価>	[補足耐1]	地盤の支持性能について
IV-1-1-2 地盤の支持性能に係る基本方針	【3. 地盤の解析用物性値】 【4. 地盤の支持力度】			
IV-1-1-5 地震応答解析の基本方針	【2.1.1 建物・構築物(2.1.2に記載のものを除く。)] 【2.1.2 屋外重要土木構築物】			
IV-1-1-1 耐震設計の基本方針	【1. 概要】	<耐震評価対象の網羅性、既設工認との評価手法の相違点の整理>	[補足耐1]	耐震評価対象の網羅性、既設工認との手法の相違点の整理について(建物・構築物、機器・配管系)
IV-1-1-1 耐震設計の基本方針	【2.1 基本方針】 【5. 機能維持の基本方針】 【5.2 機能維持】	<洞道の取扱い>	[補足耐2]	洞道の設工認申請上の取り扱いについて
IV-1-1-8 機能維持の基本方針	【4. 機能維持】	<土木構築物の要求機能>		
IV-1-1-1 耐震設計の基本方針	【10.1 建物・構築物】	<液状化による影響>	[補足耐3]	土木構築物の液状化に伴う機電設備の影響確認について
IV-1-1-5 地震応答解析の基本方針	【2.1.2 屋外重要土木構築物】			
IV-1-1-1 耐震設計の基本方針	【3.3 波及的影響に対する考慮】 【6. 構造計画と配置計画】	<波及的影響に対する考慮>	[補足耐4]	下位クラス施設の波及的影響の検討について(建物・構築物、機器・配管系)
IV-1-1-4 波及的影響に係る基本方針	【3. 波及的影響を考慮した施設の設計方針】 【4. 波及的影響の設計対象とする下位クラス施設】 【5. 波及的影響の設計対象とする下位クラス施設の耐震設計方針】 【6. 工事段階における下位クラス施設の調査・検討】			
IV-1-1-1 耐震設計の基本方針	【4.1.2 動的地震力】	<減衰定数の設定>	[補足耐5]	地震応答解析モデルに用いる鉄筋コンクリート造部の減衰定数に関する検討
IV-1-1-5 地震応答解析の基本方針	【3. 設計用減衰定数】			
IV-1-1-1 耐震設計の基本方針	【4.1.2 動的地震力】	<減衰定数の適用>	[補足耐6]	新たに適用した減衰定数について
IV-1-1-5 地震応答解析の基本方針	【3. 設計用減衰定数】			
IV-1-1-1 耐震設計の基本方針	【4.1.2 動的地震力】	<地盤物性値の設定>	[補足耐7]	地震応答解析に用いる地盤モデル及び地盤物性値の設定について
IV-1-1-2 地盤の支持性能に係る基本方針	【5. 地質断面図】 【6. 地盤の速度構造】			
IV-1-1-5 地震応答解析の基本方針	【2.1.1 建物・構築物(2.1.2に記載のものを除く。)]			
IV-1-1-1 耐震設計の基本方針	【4.1.2 動的地震力】		[補足耐8]	竜巻防護対策設備の耐震性評価に関する補足説明
IV-1-1-5 地震応答解析の基本方針	【2.1.1 建物・構築物(2.1.2に記載のものを除く。)]			

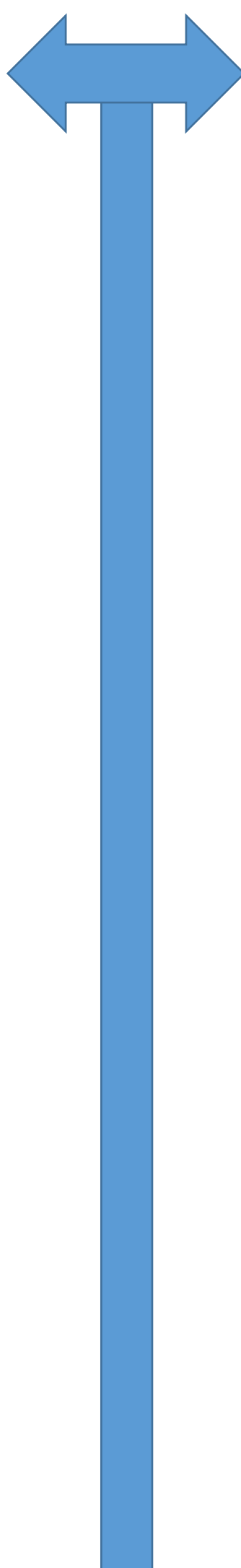

発電炉の補足説明資料の説明項目		展開要否	理由
	【補足-340-1】地盤の支持性能について	○	
【補足-340】耐震性に関する説明書の補足説明資料	【補足-340-2】耐震評価対象の網羅性、既工認との手法の相違点の整理について	○	
	【補足-340-8】屋外重要土木構築物の耐震安全性評価について 1.1 対象設備 1.2 屋外重要土木構築物の要求性能と要求性能に対する耐震評価内容	○	
/			
【補足-340】耐震性に関する説明書の補足説明資料	【補足-340-4】下位クラス施設の波及的影響の検討について	○	
【補足-400】建物・構築物の地震応答解析についての補足説明資料	【補足-400-2】地震応答解析モデルに用いる鉄筋コンクリート部の減衰定数に関する検討	○	
【補足-340】耐震性に関する説明書の補足説明資料	【補足-340-2】耐震評価対象の網羅性、既工認との手法の相違点の整理について	○	
【補足-340】耐震性に関する説明書の補足説明資料	【補足-340-1】地盤の支持性能について	○	
/			

補足説明すべき項目の抽出
 (第五条(安全機能を有する施設の地盤)、第三十二条(重大事故等対処施設の地盤)、
 第六条、第三十三条(地震による損傷の防止))

基本設計方針からの展開で抽出された補足説明が必要な項目			
IV-1-1-1 耐震設計の基本方針	【4.1.2 動的地震力】	<材料物性のばらつき>	[補足耐9] 地震応答解析における材料物性のばらつきに関する検討
IV-1-1-5 地震応答解析の基本方針	【2.1.1 建物・構築物(2.1.2に記載のものを除く。)]		
IV-1-1-1 耐震設計の基本方針	【4.1.2 動的地震力】		[補足耐10] 地震応答解析における材料物性のばらつきに伴う影響確認について(機器・配管系)
IV-1-1-5 地震応答解析の基本方針	【2.1.1 建物・構築物(2.1.2に記載のものを除く。)] 【2.1.2 屋外重要土木構築物】		
IV-1-1-1 耐震設計の基本方針	【4.1.2 動的地震力】		[補足耐11] 竜巻防護対策設備の地震応答解析における材料物性のばらつきに伴う影響評価について
IV-1-1-5 地震応答解析の基本方針	【2.1.1 建物・構築物(2.1.2に記載のものを除く。)]		
IV-1-1-1 耐震設計の基本方針	【4.1.2 動的地震力】	<水平2方向及び鉛直方向地震力の組合せ>	[補足耐12] 水平2方向及び鉛直方向地震力の組合せに関する設備の抽出及び考え方について
IV-1-1-7 水平2方向及び鉛直方向地震力の組合せに関する影響評価方針	【4.2 機器・配管系】		
IV-1-1-1 耐震設計の基本方針	【4.1.2 動的地震力】		[補足耐13] 水平2方向及び鉛直方向地震力の組合せに関する評価部位の抽出
IV-1-1-7 水平2方向及び鉛直方向地震力の組合せに関する影響評価方針	【4.1.1 建物・構築物(4.1.2に記載のものを除く。)]		
IV-1-1-1 耐震設計の基本方針	【5.1.3 荷重の組合せ】	<地震荷重と事故時荷重との組合せについて>	[補足耐14] 地震荷重と事故時荷重との組合せについて
IV-1-1-8 機能維持の基本方針	【3.1 構造強度上の制限】		
IV-1-1-1 耐震設計の基本方針	【4.1.2 動的地震力】	<鉛直方向の動的地震力考慮における影響>	[補足耐15] 鉛直方向の動的地震力考慮による設備の浮き上がり等の影響について
IV-1-1-5 地震応答解析の基本方針	【2.2 機器・配管系】		
IV-1-1-10 機器の耐震支持方針	【5. その他特に考慮すべき事項】		
IV-1-1-1 耐震設計の基本方針	【4.1.2 動的地震力】	<SRSS法の適用性>	[補足耐16] 水平方向と鉛直方向の動的地震力の二乗和平方根(SRSS)法による組合せについて
IV-1-1-5 地震応答解析の基本方針	【2.2 機器・配管系】		
IV-1-1-1 耐震設計の基本方針	【10.1 建物・構築物】	<一関東評価用地震動(鉛直)>	[補足耐17] 一関東評価用地震動(鉛直)に対する影響評価について(建物、屋外機械基礎)
			[補足耐18] 竜巻防護対策設備の一関東評価用地震動(鉛直)に対する影響評価について
IV-1-1-1 耐震設計の基本方針	【10.2 機器・配管系】		[補足耐19] 一関東評価用地震動(鉛直)に対する影響確認について(機器・配管系)
IV-1-1-1 耐震設計の基本方針	【10.2 機器・配管系】	<S d 評価結果の記載方法>	[補足耐20] 耐震Sクラス設備の耐震計算書におけるS d 評価結果の記載方法
IV-1-2-1 機器の耐震性に関する計算書作成の基本方針	【1. 概要】		
IV-1-2-2 配管系の耐震性に関する計算書作成の基本方針	【1. 概要】		

発電炉の補足説明資料の説明項目		展開要否	理由
【補足-400】 建物・構築物の地震応答解析についての補足説明資料	【補足-400-3】 地震応答解析における材料物性のばらつきに関する検討	○	
【補足-340】 耐震性に関する説明書の補足説明資料	【補足-340-13】 3. 建屋-機器連成解析モデルの時刻歴応答解析における材料物性のばらつきの考慮について	○	
/			
【補足-340】 耐震性に関する説明書の補足説明資料	【補足-340-7】 水平2方向及び鉛直方向の適切な組合せに関する検討について	○	
	【補足-340-5】 地震時荷重と事故時荷重との組合せについて	○	
【補足-340】 耐震性に関する説明書の補足説明資料	【補足-340-2】 耐震評価対象の網羅性、既工認との手法の相違点の整理について	○	
【補足-340】 耐震性に関する説明書の補足説明資料	【補足-340-2】 耐震評価対象の網羅性、既工認との手法の相違点の整理について	○	
/			
/			
/			
【補足-340】 耐震性に関する説明書の補足説明資料	【補足-340-2】 耐震評価対象の網羅性、既工認との手法の相違点の整理について	○	

補足説明すべき項目の抽出
 (第五条(安全機能を有する施設の地盤)、第三十二条(重大事故等対処施設の地盤)、
 第六条、第三十三条(地震による損傷の防止))

基本設計方針からの展開で抽出された補足説明が必要な項目			
IV-1-1 耐震設計の基本方針	【5.1.5 許容限界】	<疲労評価における等価繰返し回数 の設定>	[補足耐21] 耐震評価における等価繰返し回数の妥当性確認について
IV-1-1-8 機能維持の基本方針	【3.1 構造強度上の制限】		
IV-1-1 耐震設計の基本方針	【9. 機器・配管系の支持方針について】	<コンクリート定着部について>	[補足耐22] 屋内設備に対するアンカー定着部の評価について
IV-1-1-10 機器の耐震支持方針	【4.2 埋込金物の設計】		
		-	[補足耐23] (欠番)
IV-1-1 耐震設計の基本方針	【5.2 機能維持】	<動的機能維持評価>	[補足耐24] 動的機能維持評価手法の適用について
IV-1-1-8 機能維持の基本方針	【4. 機能維持】		
IV-1-1 耐震設計の基本方針	【5.2 機能維持】	<電気盤等の機能維持評価>	[補足耐25] 電気盤等の機能維持評価に適用する水平方向の評価用地震力について
IV-1-1-8 機能維持の基本方針	【4. 機能維持】		
IV-1-1 耐震設計の基本方針	【5.2 機能維持】	<間接支持構造物の評価>	[補足耐26] 応力解析におけるモデル化、境界条件及び拘束条件の考え方
IV-1-1-8 機能維持の基本方針	【4. 機能維持】		[補足耐27] 地震荷重の入力方法
			[補足耐28] 建物・構築物の耐震評価における組合せ係数法の適用性について
			[補足耐29] 応力解析における断面の評価部位の選定
			[補足耐30] 応力解析における応力平均化の考え方
IV-1-1 耐震設計の基本方針	【10.1 建物・構築物】	<既設工認と今回設工認の解析モデル及び手法の比較>	[補足耐31] 地震応答解析及び応力解析における既設工認と今回設工認の解析モデル及び手法の比較
IV-1-1 耐震設計の基本方針	【10.1 建物・構築物】	<地盤ばね、スケルトンカーブの設定>	[補足耐32] 「建屋側面地盤ばね」及び「地盤のひずみ依存特性」の評価手法について
IV-1-1-5 地震応答解析の基本方針	【2.1.1 建物・構築物(2.1.2に記載のものを除く。)]		[補足耐33] 地震応答解析における耐震壁のせん断スケルトンカーブの設定
IV-1-1 耐震設計の基本方針	【10.1 建物・構築物】	<隣接建屋の影響>	[補足耐34] 隣接建屋の影響に関する検討(建物、屋外機械基礎)
IV-1-1-5 地震応答解析の基本方針	【2.1.1 建物・構築物(2.1.2に記載のものを除く。)]		[補足耐35] 隣接建屋の影響に対する影響確認について(機器・配管系)
IV-1-1 耐震設計の基本方針	【10.1 建物・構築物】	<液状化による影響評価> <地下水排水設備>	[補足耐36] 建物・構築物周辺の設計用地下水位の設定について
IV-1-1-2 地盤の支持性能に係る基本方針	【3.3 耐震評価における地下水位設定方針】		
IV-1-1 耐震設計の基本方針	【10.2 機器・配管系】	<固有周期の算出>	[補足耐37] 剛な設備の固有周期の算出について

発電炉の補足説明資料の説明項目		展開要否	理由
【補足-340】耐震性に関する説明書の補足説明資料	【補足-340-13】18. 耐震評価における等価繰返し回数の妥当性確認について	○	
	【補足-340-13】20. 補機類のアンカー定着部の評価について	○	
	【補足-340-9】加振試験についての補足説明資料	○	
	【補足-340-13】5. 弁の動的機能維持評価について	○	
	【補足-340-13】6. 動的機能維持の詳細評価について(新たな検討又は詳細検討が必要な設備の機能維持評価について)	○	
	【補足-340-17】常設高圧代替注水系ポンプの耐震性についての計算書に関する補足説明資料	○	
【補足-370】建物・構築物の耐震計算についての補足説明資料	【補足-340-13】9. 電気盤等の機能維持評価に適用する水平方向の評価用地震力について	○	
	【補足-370-2】応力解析におけるモデル化、境界条件及び拘束条件の考え方	○	
	【補足-370-4】地震荷重の入力方法	○	
	【補足-370-7】建物・構築物の耐震評価における組合せ係数法の適用	○	
	【補足-370-3】応力解析における断面の評価部位の選定	○	
	【補足-370-6】応力解析における応力平均化の考え方	○	
【補足-370】建物・構築物の耐震計算についての補足説明資料	【補足-370-1】応力解析における既工認と今回工認の解析モデル及び手法の比較	○	
【補足-400】建物・構築物の地震応答解析についての補足説明資料	【補足-400-1】地震応答解析における既工認と今回工認の解析モデル及び手法の比較	○	
【補足-400】建物・構築物の地震応答解析についての補足説明資料	【補足-400-5】地震応答解析における耐震壁のせん断スケルトンカーブの設定	○	
	【補足-400-4】隣接建屋の影響に関する検討	○	
	【補足-400-4】隣接建屋の影響に関する検討	○	
【補足-340】耐震性に関する説明書の補足説明資料	【補足-340-1】地盤の支持性能について	○	
	【補足-340-13】17. 剛な設備の固有周期の算出について	○	
	【補足-340-26】盤及び計装ラックの固有周期について	○	

補足説明すべき項目の抽出
 (第五条(安全機能を有する施設の地盤)、第三十二条(重大事故等対処施設の地盤)、
 第六条、第三十三条(地震による損傷の防止))

基本設計方針からの展開で抽出された補足説明が必要な項目			
IV-1-1-1 耐震設計の基本方針 IV-1-1-11-1 配管の耐震支持方針 IV-1-1-11-2 ダクトの耐震支持方針 IV-1-2-1 機器の耐震性に関する計算書作成の基本方針 IV-1-2-2 配管系の耐震性に関する計算書作成の基本方針	【10.2 機器・配管系】 【1.3.3 標準支持間隔を用いた評価方法】 【4.4.1 標準支持間隔を用いた評価方法】 【3. 耐震計算方法】 【3. 評価部位】	<機器・配管系の類型化>	[補足耐38] 機器・配管系の類型化に対する分類の考え方について
IV-1-1-1 耐震設計の基本方針 IV-1-1-11-1 別紙1 各施設の直管部標準支持間隔 IV-1-1-11-1 別紙1-〇 各建屋の直管部標準支持間隔 IV-1-1-11-1 別紙2 重大事故等対処施設の直管部標準支持間隔 IV-1-1-11-1 別紙2-〇 各建屋の直管部標準支持間隔 IV-1-1-11-2 別紙1 各施設の直管部標準支持間隔 IV-1-1-11-2 別紙1-〇 各建屋の直管部標準支持間隔 IV-1-1-11-2 別紙2 重大事故等対処施設の直管部標準支持間隔 IV-1-1-11-2 別紙2-〇 各建屋の直管部標準支持間隔 IV-1-2-1 機器の耐震性に関する計算書作成の基本方針 IV-1-2-2 配管系の耐震性に関する計算書作成の基本方針	【10.2 機器・配管系】 【1. 概要】 【2. 準拠規格】 【3. 計算精度と数値の丸め方】 【1. 解析条件】 【2. 解析結果】 【1. 概要】 【2. 準拠規格】 【3. 計算精度と数値の丸め方】 【1. 解析条件】 【2. 解析結果】 【1. 概要】 【2. 準拠規格】 【3. 計算精度と数値の丸め方】 【1. 解析条件】 【2. 解析結果】 【1. 概要】 【2. 準拠規格】 【3. 計算精度と数値の丸め方】 【1. 概要】 【1. 概要】	<耐震計算書の作成方針>	[補足耐39] 機電設備の耐震計算書の作成について
IV-1-1-1 耐震設計の基本方針 IV-1-1-11-1 配管の耐震支持方針 IV-1-1-11-2 ダクトの耐震支持方針 IV-1-1-12 電気計測制御装置等の耐震支持方針	【9. 機器・配管系の支持方針について】 【1.3.1.1 重要度による設計方針】 【1.3.3 標準支持間隔を用いた評価方法】 【1. 概要】 【4.5 標準支持間隔】 【4.6 支持方法】 【3.3.4 電路類の耐震設計手順】	<配管系の評価手法>	[補足耐40] 配管系の評価手法(定ピッチスパン法)について

発電炉の補足説明資料の説明項目		展開要否	理由
【補足-340】耐震性に関する説明書の補足説明資料			
【補足-340-13】 4. 機電設備の耐震計算書の作成について		○	
【補足-340-28】 耐震性についての計算書における評価温度の考え方について		○	
【補足-340-13】 12. 応力を基準とした標準支持間隔法の適用について		○	

補足説明すべき項目の抽出
 (第五条 (安全機能を有する施設の地盤)、第三十二条 (重大事故等対処施設の地盤)、
 第六条、第三十三条 (地震による損傷の防止))

基本設計方針からの展開で抽出された補足説明が必要な項目			
IV-1-1 耐震設計の基本方針 IV-1-2-1 別紙1 各設備の定式化された計算式を用いた解析法の計算式	【10.2 機器・配管系】 【1. 概要】	<既設工認からの変更点>	[補足耐41] 機器の耐震計算における既設工認からの計算式の変更点について
IV-1-1 耐震設計の基本方針 IV-1-1-11-1 別紙1 各施設の直管部標準支持間隔 IV-1-1-11-1 別紙1-〇 各建屋の直管部標準支持間隔 IV-1-1-11-1 別紙2 重大事故等対処施設の直管部標準支持間隔 IV-1-1-11-1 別紙2-〇 各建屋の直管部標準支持間隔 IV-1-1-11-2 別紙1 各施設の直管部標準支持間隔 IV-1-1-11-2 別紙1-〇 各建屋の直管部標準支持間隔 IV-1-1-11-2 別紙2 重大事故等対処施設の直管部標準支持間隔 IV-1-1-11-2 別紙2-〇 各建屋の直管部標準支持間隔 IV-1-2-1 別紙1 各設備の定式化された計算式を用いた解析法の計算式 IV-1-2-1 別紙2 各設備のFEMモデルを用いた解析法の計算式 IV-1-2-2 配管系の耐震性に関する計算書作成の基本方針	【10.2 機器・配管系】 【1. 概要】 【2. 準拠規格】 【3. 計算精度と数値の丸め方】 【1. 解析条件】 【2. 解析結果】 【1. 概要】 【2. 準拠規格】 【3. 計算精度と数値の丸め方】 【1. 解析条件】 【2. 解析結果】 【1. 概要】 【2. 準拠規格】 【3. 計算精度と数値の丸め方】 【1. 解析条件】 【2. 解析結果】 【1. 概要】 【2. 準拠規格】 【3. 計算精度と数値の丸め方】 【1. 概要】 【1. 概要】 【1. 概要】	<既設工認からの変更点について>	[補足耐42] 既設工認からの変更点について
IV-1-1 耐震設計の基本方針 IV-1-1-10 機器の耐震支持方針 IV-1-1-11-1 配管の耐震支持方針	【9. 機器・配管系の支持方針について】 【5. その他特に考慮すべき事項】 【4. その他の考慮事項】	<機器・配管の相対変位に対する考慮>	[補足耐43] 機器と配管の相対変位に対する設計上の扱いについて
IV-1-1 耐震設計の基本方針 IV-1-1-11-2 ダクトの耐震支持方針	【9. 機器・配管系の支持方針について】 【4.5.1 角ダクトの固有周期】 【4.5.2 丸ダクトの固有周期】 【4.5.3 角ダクトの座屈評価】 【4.5.4 丸ダクトの座屈評価】	<ダクトの耐震設計について>	[補足耐44] ダクト評価で用いる補正係数、安全係数の設定根拠について
-	-	<計算機プログラム (解析コード) について>	[補足耐45] 計算機プログラム (解析コード) の概要について

発電炉の補足説明資料の説明項目		展開要否	理由
【補足-370】 建物・構築物の耐震計算についての補足説明資料	【補足-370-16】 主排気筒及び非常用ガス処理系配管支持架構の耐震性評価に関する補足説明	○	
【補足-500】 計算機プログラム (解析コード) の概要に係る補足説明資料	【補足-500-1】 計算機プログラム (解析コード) の概要に係る補足説明資料	○	

補足説明すべき項目の抽出
 (第五条 (安全機能を有する施設の地盤)、第三十二条 (重大事故等対処施設の地盤)、
 第六条、第三十三条 (地震による損傷の防止))

基本設計方針からの展開で抽出された補足説明が必要な項目				
IV-1-1-1 耐震設計の基本方針	【10.1 建物・構築物】	<既設工認と今回工認の解析モデル及び手法の比較>	[補足耐46]	土木建造物の地震応答解析における既設工認と今回工認の解析モデル及び手法の比較について
IV-1-1-1 耐震設計の基本方針	【4.1.2 動的地震力】	<地盤物性値の設定>	[補足耐47]	土木建造物の耐震安全性評価における共通事項について
IV-1-1-2 地盤の支持性能に係る基本方針	【5. 地質断面図】 【6. 地盤の速度構造】	<地盤物性値の設定>		
IV-1-1-5 地震応答解析の基本方針	【2.1.2 屋外重要土木構築物】 【3. 設計用減衰定数】	<地盤物性値の設定> <減衰定数の設定> <共通事項>		
IV-1-1-1 耐震設計の基本方針	【10.1 建物・構築物】	<一関東評価用地震動(鉛直)>	[補足耐48]	土木建造物の一関東評価用地震動(鉛直)に対する影響評価について
IV-1-1-1 耐震設計の基本方針	【4.1.2 動的地震力】	<材料物性のばらつき>	[補足耐49]	土木建造物の地震応答解析における材料物性のばらつきに関する検討について
IV-1-1-5 地震応答解析の基本方針	【2.1.2 屋外重要土木構築物】			
IV-1-1-1 耐震設計の基本方針	【10.1 建物・構築物】	<液状化による影響>	[補足耐50]	土木建造物の液状化の影響評価について
IV-1-1-5 地震応答解析の基本方針	【2.1.2 屋外重要土木構築物】			
IV-1-1-1 耐震設計の基本方針	【4.1.2 動的地震力】	<水平2方向及び鉛直方向地震力の組合せ>	[補足耐51]	土木建造物の水平2方向及び鉛直方向地震力の組合せに関する影響評価について
IV-1-1-7 水平2方向及び鉛直方向地震力の組合せに関する影響評価方針	【4.1.2 屋外重要土木構築物】			
-	-	<土木建造物の耐震評価における断面選定の考え方について>	[補足耐52]	土木建造物の耐震評価における断面選定の考え方について
IV-1-1-1 耐震設計の基本方針	【5. 機能維持の基本方針】 【5.2 機能維持】	<再処理施設の要求機能>	[補足耐53]	耐震設計における安全機能の整理について
IV-1-1-8 機能維持の基本方針	【4. 機能維持】			

発電炉の補足説明資料の説明項目		展開要否	理由
【補足-400】 建物・構築物の地震応答解析についての補足説明資料	【補足-400-1】 地震応答解析における既工認と今回工認の解析モデル及び手法の比較	○	
【補足-340】 耐震性に関する説明書の補足説明資料	【補足-340-8】 屋外重要土木建造物の耐震安全性評価について 1. 共通事項	○	
/			
【補足-340】 耐震性に関する説明書の補足説明資料	【補足-340-8】 屋外重要土木建造物の耐震安全性評価について 1.5 地盤物性のばらつきの考慮方法	○	
【補足-340】 耐震性に関する説明書の補足説明資料	【補足-340-8】 屋外重要土木建造物の耐震安全性評価について 2.以降 各建造物の耐震安全性評価	○	
【補足-340】 耐震性に関する説明書の補足説明資料	【補足-340-7】 水平2方向及び鉛直方向の適切な組合せに関する検討について	○	
【補足-340】 耐震性に関する説明書の補足説明資料	【補足-340-8】 屋外重要土木建造物の耐震安全性評価について 1.4 屋外重要土木建造物の耐震評価における断面選定の考え方	○	
/			

補足説明すべき項目の抽出
 (第五条 (安全機能を有する施設の地盤)、第三十二条 (重大事故等対処施設の地盤)、
 第六条、第三十三条 (地震による損傷の防止))

基本設計方針からの展開で抽出された補足説明が必要な項目

発電炉の補足説明資料の説明項目	展開要否	理由
【補足-340-3】可搬型重大事故等対処設備の耐震性に関する説明書に関する補足説明資料	-	本資料は、可搬型重大事故等対処設備の要求される機能を損なわないことを確認するための耐震計算方法について示している。再処理施設については基本設計方針の構成が発電炉と異なり、可搬型重大事故等対処設備は36条側での整理となることから、36条 (重大事故等対処設備) にて示す。
【補足-340-10】ケミカルアンカの高温環境下での使用について	-	本資料は、重大事故等時に高温環境下で使用する機器の基礎ボルトとして、ケミカルアンカを使用するものについて、高温環境下において使用可能であることを示している。再処理施設については高温環境下においてケミカルアンカを使用していない。
【補足-340-11】海水ポンプエリア防護対策施設の耐震性についての計算書に関する補足説明資料	-	本資料は、海水ポンプエリア防護対策施設が上位クラスである設備に対して波及的影響を与えないことについて示されている。再処理施設においては、波及的影響の耐震評価方針を基本方針に示し、抽出を含めた評価結果については、補足説明資料「下位クラス施設の波及的影響の検討について」にて纏めて示している。
【補足-340-13】1. 炉内構造物への極限解析による評価の適用について	-	本資料は、炉内構造物への極限解析の適用の妥当性について示されている。再処理施設においては極限解析は適用していないが、適用する場合は補足説明資料にて示す。
【補足-340-13】2. 設計用床応答曲線の作成方法及び適用方法	-	本資料は、FRS作成の詳細方針及び高振動数影響について示されている。再処理施設におけるFRSの内容については基本方針に示しており、高振動領域については補足説明資料「動的機能維持に対する評価内容について」にて示す。
【補足-340-13】7. 原子炉格納容器の耐震安全性評価について	-	本資料は、今回工認で適用する手法が、既工認で適用した手法と異なる場合に他プラントでの適用実績の確認内容について示している。再処理施設においては、既認可からの変更内容及び根拠について、後次回以降で申請する設備に対する補足説明資料「既認可からの変更理由」にて示す。
【補足-340-13】8. 制御棒の挿入性評価について	-	本資料は、発電炉固有の格納容器周辺設備の影響評価について示されており、再処理施設においては機能要求上該当する設備を有していない。
【補足-340-13】10. 大型機器、構造物の地震応答計算書の補足について	-	本資料は、大型機器、構造物の解析モデルの作成の設定の考え方が示されている。再処理施設においては、建屋に対して相互影響を与える大型設備を有していない。
【補足-340-13】11. 配管解析における重心位置スペクトル法の適用について	-	本資料は、配管解析における床応答曲線の入力方法として、重心位置スペクトル法に適用している床応答曲線の入力位置の妥当性について示されている。再処理施設においては、重心位置スペクトル法を適用していないが、適用する場合は補足説明資料にて示す。
【補足-340-13】13. ダクトの耐震計算方法について	-	本資料は、ダクト支持方針における直管部、曲がり部及び集中質量部の考慮について考え方を示している。再処理施設においては、後次回で申請する添付書類の「ダクトの耐震支持方針」にて示す。
【補足-340-13】14. Bijlaard の方法の適用文献について	-	本資料はBijlaard適用文献の各発行年版における応力係数の違いの影響について示されている。再処理施設においては、文献の記載値に対して適切な応力係数を用いた計算結果を耐震計算書にて示す。

【補足-340】耐震性に関する説明書の補足説明資料

補足説明すべき項目の抽出
 (第五条 (安全機能を有する施設の地盤)、第三十二条 (重大事故等対処施設の地盤)、
 第六条、第三十三条 (地震による損傷の防止))

基本設計方針からの展開で抽出された補足説明が必要な項目

発電炉の補足説明資料の説明項目	展開要否	理由
【補足-340-13】 15. 主蒸気管の弾性設計用地震動 S d での耐震評価について	-	本資料は、発電炉固有の格納容器周辺設備についての耐震評価について示されている。再処理施設においては、機能要求上該当する設備を有していない。
【補足-340-13】 16. コンクリートのポアソン比に対する検討について	-	本資料は、コンクリートのポアソン比が設計時から評価に用いている値と最新の規格の値に差があることに対する影響について示されている。再処理施設においては、旧規格によるポアソン比から変更せず影響検討する設備は存在しない。
【補足-340-13】 19. 再循環系ポンプの軸固着に対する評価について	-	本資料は、クラス1ポンプの規格基準要求である軸固着に対する評価について示されている。再処理施設においては、同様な規格基準の要求が該当する設備を有していない。
【補足-340-15】 常設代替高圧電源装置の耐震性についての計算書に関する補足説明資料	-	本資料は、常設代替高圧電源装置における機能維持要求に対する耐震性が示されており、再処理施設においては、類似する設備として共通電源車があるが設工認申請対象外の自主対策設備であることから該当しない。
【補足-340-16】 原子炉圧力容器の基礎ボルトにおける特別点検での評価について	-	本資料は、実用発電用電子炉の運転期間延長認可申請に係る特別点検での評価について示されている。再処理施設においては、運転期間延長認可申請について定められていないため該当しない。
【補足-340-18】 配管耐震・応力計算書における計算モデルについて	-	本資料は、耐震計算書に示している代表以外の配管のモデル形状を示している。再処理施設におけるモデル形状については耐震計算書に全て示す。
【補足-340-19】 制御棒駆動機構の耐震評価方針について	-	本資料は、発電炉固有の格納容器周辺設備の評価方針について示されている。再処理施設においては機能要求上該当する設備は有していない。
【補足-340-20】 ブローアウトパネル閉止装置の耐震性について	-	本資料は、発電炉固有の格納容器周辺設備の評価手法について示されている。再処理施設においては、機能要求上該当する設備は有していない。
【補足-340-21】 原子炉建屋外側ブローアウトパネル防護対策施設の耐震性についての計算書に関する補足説明資料	-	本資料は、複数の設備に対して代表で評価を行う場合の代表性について示している。再処理施設においては、複数設備を代表して評価を実施する場合の代表性は、耐震計算書にて示す。
【補足-340-22】 使用済燃料乾式貯蔵容器の耐震性についての計算書の概要	-	本資料は、使用済み燃料乾式貯蔵容器に使用しているアルミニウム合金の事例規格の廃止に伴う強度・破壊靱性・耐衝撃特性に係る性能評価について示している。再処理施設においては、同様な事例規格の廃止に伴う性能評価が必要な設備は有していない。
【補足-340-23】 ペDESTAL排水系の付属設備のうち導入管カバーへの水の付加質量及び落下物への評価について	-	本資料で示している導入管カバーは、運用上水没する設備となっており、耐震計算書上では水没した評価結果を示していないため、本資料で水没した際の水の付加質量及び落下物を考慮した結果が示されている。再処理施設においては、各設備毎の条件に応じた耐震計算書を示している。
【補足-340-24】 ECCSストレナ評価条件等の整理について	-	本資料は、発電炉固有の格納容器周辺設備の評価条件について示されており、再処理施設においては評価耐震計算書機能要求上該当する設備を有していない。

補足説明すべき項目の抽出
 (第五条 (安全機能を有する施設の地盤)、第三十二条 (重大事故等対処施設の地盤)、
 第六条、第三十三条 (地震による損傷の防止))

基本設計方針からの展開で抽出された補足説明が必要な項目

発電炉の補足説明資料の説明項目	展開要否	理由	
【補足-340-25】原子炉格納容器の耐震計算書に係る補足説明資料	-	本資料は、発電炉固有の格納容器周辺設備の評価内容について示している。再処理施設における評価内容については耐震計算書に全て示す。	
【補足-340-27】緊急時対策所用発電機制御盤の耐震性についての計算書の概要	-	本資料は、工認添付書類の計算結果を示している緊急時対策所用発電機制御盤の振動モード図について示されている。再処理施設における振動モードの扱いとしては、補足説明資料「機電設備の耐震計算書の作成について」の中で記載しており、計算書で特定が必要な場合は耐震計算書にて示すこととしている。	
【補足-340-29】原子炉圧力容器の耐震性についての計算書における斜角ノズルの評価方針について	-	本資料は、クラス1容器の原子炉圧力容器における規格基準要求に対する評価方針について示している。再処理施設においては同様な規格基準要求に該当する設備を有していない。	
補足-370 建物・構築物の耐震計算についての補足説明資料	【補足-370-5】中央制御室遮蔽の床スラブの耐震性評価に関する補足説明	-	Sクラスの制御室遮蔽はない。なお、各建屋に共通する事項は地震応答計算書又は耐震計算書の各事項の補足説明資料へ展開する。
	【補足-370-9】原子炉格納容器底部コンクリートマットの耐震性評価についての補足説明	-	格納容器底部コンクリートマットに類する設備がない。
	【補足-370-10】原子炉建屋地下排水設備に関する補足説明	-	上屋及びビューム管の検討に該当する設備はない。また、地下水位を地表とした場合の検討についても、地下水位を維持する設計とすることから該当しない。
	【補足-370-11】原子炉建屋の耐震性評価に関する補足説明	-	各建屋に共通する事項を地震応答計算書又は耐震計算書の各事項の補足説明資料へ展開する。(各建屋固有の事項は各補足説明資料の別紙等を用いて展開)
	【補足-370-12】原子炉建屋基礎盤の耐震性評価に関する補足説明	-	
	【補足-370-13】使用済燃料乾式貯蔵建屋の耐震性評価に関する補足説明	-	
	【補足-370-14】タービン建屋の耐震性評価に関する補足説明	-	
	【補足-370-15】サービス建屋の耐震性評価に関する補足説明	-	
	【補足-370-8】使用済燃料プールの耐震性評価に関する補足説明	-	
	【補足-370-18】緊急時対策所建屋の耐震性評価に関する補足説明	-	
	【補足-370-17】格納容器圧力逃がし装置格納槽の耐震性評価に関する補足説明	-	格納容器圧力逃がし装置格納槽に類する設備はない。
【補足-370-19】原子炉格納施設の基礎に関する説明書の補足説明	-	原子炉格納容器の建設工認時からの設計上の条件及び評価に関する差分を整理した資料であり、該当しない。	
【補足-370-20】原子炉建屋改造工事に伴う評価結果の影響について	-	各建屋に共通する事項を地震応答計算書又は耐震計算書の各事項の補足説明資料へ展開する。(各建屋固有の事項は各補足説明資料の別紙等を用いて展開)	
補足-400 建物・構築物の地震応答解析についての補足説明資料	【補足-400-6】地震応答解析における原子炉建屋の重大事故等時の高温による影響	-	原子炉格納容器壁面の高温(165℃)に対する検討であり、同様の影響を伴う設備はない。
	【補足-400-7】地震応答解析における保有水平耐力に関する補足説明	-	添付書類の各計算書にて説明を展開するため該当しない。
	【補足-400-8】原子炉建屋の既工認時の設計用地震力と今回工認における静的地震力及び弾性設計用地震動Sdによる地震力の比較	-	設計用地震力と比較して建設時の評価に包絡して説明する施設はない。
	【補足-400-9】平成23年(2011年)東北地方太平洋沖地震の原子炉建屋に対する影響	-	建屋に影響を与える地震が発生していないため該当しない。

基本設計方針からの展開で抽出された補足すべき事項と発電炉の補足説明資料の説明項目を比較した結果、追加で補足すべき事項はない。

補足説明すべき項目の抽出
 (第五条(安全機能を有する施設の地盤)、第三十二条(重大事故等対処施設の地盤)、
 第六条、第三十三条(地震による損傷の防止))

東海第二発電所 補足説明資料	再処理施設 補足説明資料	記載概要	補足説明すべき事項	申請回数			
				1回	第1回 記載概要	2回	第2回 記載概要
【補足-340-1】地盤の支持性能について	地盤の支持性能について	・液状化強度特性に係るパラメータ、直接基礎及び杭基礎の支持力算定式または平板載荷試験の結果から設定した算定方法、パラメータ等の詳細について示す。	【補足盤1】	【耐震地盤01】地盤の支持性能について	液状化強度特性に係るパラメータ、直接基礎及び杭基礎の支持力算定式より設定した極限支持力度の算定方法、パラメータ等の詳細について説明	○	当該回次の申請施設における地盤の液状化強度特性及び極限支持力度の説明を追加
【補足-340-2】耐震評価対象の網羅性、既工認との手法の相違点の整理について	耐震評価対象の網羅性、既設工認との手法の相違点の整理について(建物・構築物、機器・配管系)	・申請施設における評価対象施設、評価項目・部位の網羅性及び代表性を示すため、当社施設における既設工認との評価手法の相違点の整理について示す。	【補足耐1】	【耐震建物01】耐震評価対象の網羅性、既設工認との手法の相違点の整理について(建物・構築物、機器・配管系)	当社施設の評価対象設備を対象に先行発電プラントとの評価部位、応力分類の相違点を整理し、既設工認との手法の相違点を説明	○	当該回次の申請対象について既設工認との手法の相違点の説明を追加
【補足-340-8】屋外重要土木構造物の耐震安全性評価について 1.1 対象設備 1.2 屋外重要土木構造物の要求性能と要求性能に対する耐震評価内容	洞道の設工認申請上の取り扱いについて	・今回設工認における洞道の取り扱いについて、洞道の要求機能、要求機能に応じた評価方針等について示す。	【補足耐2】	【耐震建物20】洞道の設工認申請上の取り扱いについて	今回設工認における洞道の取り扱いについて、洞道の要求機能および要求機能に応じた評価方針について説明	△	第1回での説明から追加事項なし
—	土木構造物の液状化に伴う機電設備の影響確認について	・液状化による影響について設計用床応答曲線と液状化影響を考慮した床応答曲線との比較等、影響確認結果について示す。	【補足耐3】	— (次回以降)	—	○	液状化による影響について設計用床応答曲線と液状化影響を考慮した床応答曲線との比較等、影響確認結果について説明
【補足-340-4】下位クラス施設の波及的影響の検討について	下位クラス施設の波及的影響の検討について(建物・構築物、機器・配管系)	・波及的影響の設計対象施設の抽出の考え方、抽出過程、抽出結果について示す。	【補足耐4】	【耐震機電03】下位クラス施設の波及的影響の検討について(建物・構築物、機器・配管系)	基本方針で示している波及的影響対象設備について、抽出過程である設計図書や現場調査等による確認方法、確認内容を説明	○	当該回次の申請範囲について、抽出過程である設計図書や現場調査等による確認方法、確認内容の説明を追加
【補足-400-2】地震応答解析モデルに用いる鉄筋コンクリート部の減衰定数に関する検討	地震応答解析モデルに用いる鉄筋コンクリート造部の減衰定数に関する検討	・鉄筋コンクリート造部の減衰定数について、既往の知見を踏まえた設定の考え方について示す。	【補足耐5】	【耐震建物10】地震応答解析モデルに用いる鉄筋コンクリート造部の減衰定数に関する検討	鉄筋コンクリート造部の減衰定数について、既往の知見を踏まえた設定の考え方及び図面等の根拠について説明	○	当該回次の申請施設の図面等の根拠の説明を追加
【補足-340-2】耐震評価対象の網羅性、既工認との手法の相違点の整理について	新たに適用した減衰定数について	・施設の評価において適用する減衰定数のうち、最新知見として得られた減衰定数を用いることの妥当性、設備への適用性について示す。	【補足耐6】	【耐震機電18】新たに適用した減衰定数について	地震応答解析の基本方針に示す機器、配管系に適用する減衰定数について、設定方法、適用性について説明	○	当該回次の申請範囲における最新知見の減衰定数に対する根拠及びその適用性について説明を追加
【補足-340-1】地盤の支持性能について	地震応答解析に用いる地盤モデル及び地盤物性値の設定について	・建物・構築物の地震応答解析に用いる地盤モデル及び地盤物性値に関する根拠を示すため、地盤モデル及び地盤物性値の設定内容について示す。	【補足耐7】	【耐震建物08】地震応答解析に用いる地盤モデル及び地盤物性値の設定について	建物・構築物の地震応答解析に用いる地盤モデル及び地盤物性値に関する根拠を示すため、地盤モデル及び地盤物性値の設定内容について説明	○	当該回次の申請施設の地盤モデル設定に関する検討結果の説明を追加
—	竜巻防護対策設備の耐震性評価に関する補足説明	・竜巻防護対策設備の地震応答解析に用いる地盤モデル及び地盤物性値に関する根拠を示すため、地盤モデル及び地盤物性値の設定内容について示す。	【補足耐8】	【耐震建物23】竜巻防護対策設備の耐震性評価に関する補足説明	竜巻防護対策設備の地震応答解析に用いる地盤モデル及び地盤物性値に関する根拠を示すため、地盤モデル及び地盤物性値の設定内容について説明	○	当該回次の申請施設の地盤モデル設定に関する検討結果の説明を追加

補足説明すべき項目の抽出
 (第五条(安全機能を有する施設の地盤)、第三十二条(重大事故等対処施設の地盤)、
 第六条、第三十三条(地震による損傷の防止))

東海第二発電所 補足説明資料	再処理施設 補足説明資料	記載概要	補足説明すべき事項	申請回数			
				1回	第1回 記載概要	2回	第2回 記載概要
【補足-400-3】地震応答解析における材料物性のばらつきに関する検討	地震応答解析における材料物性のばらつきに関する検討	・動的解析における材料物性のばらつきの考慮に関する根拠を示すため、ばらつきの考慮に係る検討内容について示す。	[補足耐9]	【耐震建物11】地震応答解析における材料物性のばらつきに関する検討	動的解析における材料物性のばらつきの考慮に関する根拠を示すため、ばらつきの考慮に係る検討内容について説明	○	当該回次の申請施設の建物・構築物の材料物性のばらつきを考慮した地震応答解析結果の説明を追加
【補足-340-13】3. 建屋-機器連成解析モデルの時刻歴応答解析における材料物性のばらつきの考慮について	地震応答解析における材料物性のばらつきに伴う影響確認について(機器・配管系)	・建物、構築物の材料物性のばらつきの影響を考慮した応答に対する影響の確認方法及び影響確認結果について示す。	[補足耐10]	【耐震機電11】地震応答解析における材料物性のばらつきに伴う影響確認について(機器・配管系)	建屋、構築物の材料物性のばらつきの影響を考慮した応答に対する影響の確認方法及び影響確認結果について説明	○	当該回次の申請施設の機器・配管系について材料物性のばらつきの地震応答解析の結果による影響確認結果の説明を追加
—	竜巻防護対策設備の地震応答解析における材料物性のばらつきに伴う影響評価について	・動的解析における材料物性のばらつきの考慮に関する根拠を示すため、ばらつきの考慮に係る検討内容について示す。	[補足耐11]	【耐震建物26】竜巻防護対策設備の地震応答解析における材料物性のばらつきに伴う影響評価について	動的解析における材料物性のばらつきの考慮に関する根拠を示すため、ばらつきの考慮に係る検討内容について説明	○	当該回次の申請施設の建物・構築物の材料物性のばらつきを考慮した地震応答解析結果の説明を追加
【補足-340-7】水平2方向及び鉛直方向の適切な組合せに関する検討について	水平2方向及び鉛直方向地震力の組合せに関する設備の抽出及び考え方について	・水平2方向及び鉛直方向地震力の組合せに関する影響評価にあたり、各設備における設備形状の観点から水平2方向影響有無の整理内容及び考え方について示す。	[補足耐12]	【耐震機電10】水平2方向及び鉛直方向地震力の組合せに関する設備の抽出及び考え方について	水平2方向及び鉛直方向地震力の組合せに関する影響評価にあたり、各設備における設備形状の観点から水平2方向影響有無の整理内容及び考え方について説明	○	当該回次の申請施設の水平2方向及び鉛直方向地震力の組合せに関する影響評価にあたり、各設備における設備形状の観点から水平2方向影響有無の整理内容及び考え方について説明を追加
【補足-340-7】水平2方向及び鉛直方向の適切な組合せに関する検討について	水平2方向及び鉛直方向地震力の組合せに関する評価部位の抽出	・水平2方向及び鉛直方向地震力の組合せに関する影響評価に係る根拠を示すため、評価部位の抽出内容について示す。	[補足耐13]	【耐震建物07】水平2方向及び鉛直方向地震力の組合せに関する評価部位の抽出	水平2方向及び鉛直方向地震力の組合せに関する建物・構築物の評価部位の抽出の考え方及び評価部位の抽出結果について説明	○	当該回次の申請施設における評価部位の抽出結果の説明を追加
【補足-340-5】地震時荷重と事故時荷重との組合せについて	地震荷重と事故時荷重との組合せについて	・運転時の以上な過渡変化時及び設計基準事故時の荷重と地震力との組合せの検討内容について示す。	[補足耐14]	【耐震機電22】地震荷重と事故時荷重との組合せについて	運転時の異常な過渡変化時及び設計基準事故時の荷重と地震力との組合せの検討内容について説明	△	第1回での説明から追加事項なし
【補足-340-2】耐震評価対象の網羅性、既工認との手法の相違点の整理について	鉛直方向の動的地震力考慮による設備の浮き上がり等の影響について	・鉛直方向地震力の導入により浮き上がり等の影響を受ける設備の抽出及び影響検討内容について示す。	[補足耐15]	【耐震機電01】鉛直方向の動的地震力考慮による設備の浮き上がり等の影響について	鉛直方向地震力の導入により浮き上がり等の影響を受ける設備を抽出及び影響検討内容の結果について説明	○	当該申請対象となる鉛直方向が拘束されていない移動式設備の影響確認結果の説明を追加
【補足-340-2】耐震評価対象の網羅性、既工認との手法の相違点の整理について	水平方向と鉛直方向の動的地震力の二乗和平方根(SRSS)法による組合せについて	・鉛直方向地震力の導入に伴うSRSS法の適用性について示す。	[補足耐16]	【耐震機電02】水平方向と鉛直方向の動的地震力の二乗和平方根(SRSS)法による組合せについて	鉛直方向地震力の導入に伴うSRSS法の適用性について説明	△	第1回での説明から追加事項なし

補足説明すべき項目の抽出
 (第五条(安全機能を有する施設の地盤)、第三十二条(重大事故等対処施設の地盤)、
 第六条、第三十三条(地震による損傷の防止))

東海第二発電所 補足説明資料	再処理施設 補足説明資料	記載概要	補足説明すべき事項	申請回数			
				1回	第1回 記載概要	2回	第2回 記載概要
—	一関東評価用地震動(鉛直)に対する影響評価について(建物、屋外機械基礎)	・一関東評価用地震動(鉛直)を用いた影響評価に関する検討内容及び影響評価結果について示す。	[補足耐17]	【耐震建物12】一関東評価用地震動(鉛直)に対する影響評価について(建物、屋外機械基礎)	一関東評価用地震動(鉛直)を用いた影響評価に関する検討内容及び影響評価結果について説明	○	当該回次の申請施設における一関東評価用地震動(鉛直)に対する各建物・構築物の影響評価結果の説明を追加
—	竜巻防護対策設備の一関東評価用地震動(鉛直)に対する影響評価について	・一関東評価用地震動(鉛直)を用いた影響評価に関する検討内容及び影響評価結果について示す。	[補足耐18]	【耐震建物25】竜巻防護対策設備の一関東評価用地震動(鉛直)に対する影響評価について	一関東評価用地震動(鉛直)を用いた影響評価に関する検討内容及び影響評価結果について説明	○	当該回次の申請施設における一関東評価用地震動(鉛直)を用いた影響評価結果について説明を追加
—	一関東評価用地震動(鉛直)に対する影響確認について(機器・配管系)	・一関東評価用地震動(鉛直)を用いた影響評価に関する検討内容及び影響評価結果について示す。	[補足耐19]	【耐震機電12】一関東評価用地震動(鉛直)に対する影響評価について(機器・配管系)	一関東評価用地震動(鉛直)を用いた影響評価に関する検討内容及び影響評価結果について説明	○	当該回次の申請施設における一関東評価用地震動(鉛直)に対する機器・配管系の影響評価結果の説明を追加
【補足-340-2】耐震評価対象の網羅性、既工認との手法の相違点の整理について	耐震Sクラス設備の耐震計算書におけるS d評価結果の記載方法	・Sクラス施設の耐震計算書におけるSd評価結果の記載方法について示す。	[補足耐20]	【耐震機電09】耐震Sクラス設備の耐震計算書におけるS d評価結果の記載方法	Sクラス施設の耐震計算書におけるSd評価結果の記載方法について説明	△	第1回での説明から追加事項なし
【補足-340-13】18. 耐震評価における等価繰返し回数の妥当性確認について	耐震評価における等価繰返し回数の妥当性確認について	・疲労評価を実施している設備について、適用する等価繰返し回数の設定方法等について示す。	[補足耐21]	— (次回以降)	—	○	疲労評価を実施している設備について、適用している等価繰返し回数の設定方法及び妥当性について説明
【補足-340-13】20. 補機類のアンカー定着部の評価について	屋内設備に対するアンカー定着部の評価について	・屋内設備のコンクリート定着部に対する健全性について示す。	[補足耐22]	— (次回以降)	—	○	屋内設備のコンクリート定着部における評価内容等について説明
【補足-340-9】加振試験についての補足説明資料 【補足-340-13】5. 弁の動的機能維持評価について 【補足-340-13】6. 動的機能維持の詳細評価について(新たな検討又は詳細検討が必要な設備の機能維持評価について) 【補足-340-17】常設高圧代替注水系ポンプの耐震性についての計算書に関する補足説明資料	動的機能維持評価手法の適用について	・動的機能維持の評価部位の妥当性及び評価方法について示す。	[補足耐24]	【耐震機電14】動的機能維持評価手法の適用について	当該回次の申請範囲を対象に動的機能を維持するために必要となる評価部位の妥当性、評価方法について説明	○	当該回次の申請範囲を対象に動的機能を維持するために必要となる評価部位の妥当性、評価方法について説明を追加
【補足-340-13】9. 電気盤等の機能維持評価に適用する水平方向の評価用地震力について	電気盤等の機能維持評価に適用する水平方向の評価用地震力について	・電気盤等の機能維持評価における評価内容等について示す。	[補足耐25]	— (次回以降)	—	○	電気盤等の機能維持評価に用いる水平方向加速度の保守性に対する確認結果について説明

補足説明すべき項目の抽出
 (第五条(安全機能を有する施設の地盤)、第三十二条(重大事故等対処施設の地盤)、
 第六条、第三十三条(地震による損傷の防止))

東海第二発電所 補足説明資料	再処理施設 補足説明資料	記載概要	補足説明すべき事項	申請回数			
				1回	第1回 記載概要	2回	第2回 記載概要
【補足-370-2】応力解析におけるモデル化、境界条件及び拘束条件の考え方	応力解析におけるモデル化、境界条件及び拘束条件の考え方	・各建物・構築物の応力解析に用いるFEMモデルのモデル化、境界条件及び拘束条件の考え方について示す。	[補足耐26]	【耐震建物15】応力解析におけるモデル化、境界条件及び拘束条件の考え方	各建物・構築物の応力解析に用いるFEMモデルのモデル化、境界条件及び拘束条件の考え方を説明	○	当該回次の申請施設におけるFEMモデルの設定内容の説明を追加
【補足-370-4】地震荷重の入力方法	地震荷重の入力方法	・各建物・構築物に共通する地震荷重の入力方法の考え方について示す。	[補足耐27]	【耐震建物16】地震荷重の入力方法	各建物・構築物に共通する地震荷重の入力方法の考え方を説明	○	当該回次の申請施設におけるFEMモデルへの入力方法の説明を追加
【補足-370-7】建物・構築物の耐震評価における組合せ係数法の適用	建物・構築物の耐震評価における組合せ係数法の適用性について	・組合せ係数法を適用している評価対象部位の組合せ係数法の適用性に関する検討方針について示す。	[補足耐28]	【耐震建物17】建物・構築物の耐震評価における組合せ係数法の適用性について	組合せ係数法を適用している評価対象部位について、組合せ係数法の適用性に関する検討方針を示すとともに、当該回次の申請施設における組合せ係数法の検討結果を説明	○	当該回次の申請施設における組合せ係数法の検討結果の説明を追加
【補足-370-3】応力解析における断面の評価部位の選定	応力解析における断面の評価部位の選定	・各建物・構築物の耐震計算書に記載した代表となる要素の選定の考え方を示すとともに、当該回次の申請施設における選定要素周辺の応力状態について示す。	[補足耐29]	【耐震建物18】応力解析における断面の評価部位の選定	各建物・構築物の耐震計算書に記載した代表となる要素の選定の考え方を示すとともに、当該回次の申請施設における選定要素周辺の応力状態を説明	○	当該回次の申請施設における選定要素周辺の応力状態の説明を追加
【補足-370-6】応力解析における応力平均化の考え方	応力解析における応力平均化の考え方	・基礎スラブ等の応力解析において応力平均化を用いる場合の考え方について、当該回次の申請施設における検討結果について示す。	[補足耐30]	— (次回以降)	—	○	当該回次の申請施設における応力平均化の検討結果を説明
【補足-370-1】応力解析における既工認と今回工認の解析モデル及び手法の比較 【補足-400-1】地震応答解析における既工認と今回工認の解析モデル及び手法の比較	地震応答解析及び応力解析における既設工認と今回設工認の解析モデル及び手法の比較	・建物・構築物の地震応答解析及び応力解析における既設工認と今回設工認の解析モデル及び手法の比較について示す。	[補足耐31]	— (次回以降)	—	○	当該回次の申請対象における解析モデル及び手法の比較について説明
—	「建屋側面地盤ばね」及び「地盤のひずみ依存特性」の評価手法について	・建屋側面地盤ばねの評価手法の考え方を示すとともに、当該回次の申請施設の建屋側面地盤ばねの設定に係る根拠について示す。	[補足耐32]	【耐震建物05】「建屋側面地盤ばね」及び「地盤のひずみ依存特性」の評価手法について	建屋側面地盤ばねの評価手法の考え方を示すなお、当該回次の申請施設においては側面地盤ばねの設定対象なし	○	当該回次の申請施設の建屋側面地盤ばねの設定に係る根拠を追加
【補足-400-5】地震応答解析における耐震壁のせん断スケルトンカーブの設定	地震応答解析における耐震壁のせん断スケルトンカーブの設定	・鉄筋コンクリート造耐震壁のせん断スケルトンカーブの設定方針を示すとともに、当該回次の申請施設のせん断スケルトンカーブの設定根拠について示す。	[補足耐33]	【耐震建物09】地震応答解析における耐震壁のせん断スケルトンカーブの設定	鉄筋コンクリート造耐震壁のせん断スケルトンカーブの設定方針を示すなお、当該回次の申請施設においては設定対象なし	○	当該回次の申請施設のせん断スケルトンカーブの設定根拠を追加

補足説明すべき項目の抽出
 (第五条(安全機能を有する施設の地盤)、第三十二条(重大事故等対処施設の地盤)、
 第六条、第三十三条(地震による損傷の防止))

東海第二発電所 補足説明資料	再処理施設 補足説明資料	記載概要	補足説明すべき事項	申請回数			
				1回	第1回 記載概要	2回	第2回 記載概要
【補足-400-4】隣接建屋の影響に関する検討	隣接建屋の影響に関する検討(建物, 屋外機械基礎)	・隣接建屋の影響に関して, 隣接建屋の検討内容等について示す。	[補足耐34]	【耐震建物06】隣接建屋の影響に関する検討(建物, 屋外機械基礎)	隣接建屋の影響に関して, 隣接建屋の検討内容及び影響検討結果について説明	○	当該回次の申請施設における隣接建屋の影響検討結果の説明を追加
【補足-400-4】隣接建屋の影響に関する検討	隣接建屋の影響に対する影響確認について(機器・配管系)	・建屋・構築物の隣接建屋の影響を考慮した応答に対する検討内容及び影響検討結果について示す。	[補足耐35]	【耐震機電21】隣接建屋の影響に対する影響評価について(機器・配管系)	建屋・構築物の隣接建屋の影響を考慮した応答に対する検討内容及び影響検討結果について説明	○	当該回次の申請施設における隣接建屋の影響検討結果の説明を追加
【補足-340-1】地盤の支持性能について	建物・構築物周辺の設計用地下水位の設定について	・建物・構築物の耐震評価に用いる設計用地下水位の設定の考え方, 地下水排水設備の設計方針, 液状化による影響評価の方針について示すとともに, 当該回次の申請施設における地下水排水設備の配置等について示す。	[補足耐36]	【耐震建物13】建物・構築物周辺の設計用地下水位の設定について	建物・構築物の耐震評価に用いる設計用地下水位の設定の考え方, 地下水排水設備の設計方針, 液状化による影響評価の方針について説明	○	当該回次の申請施設における地下水排水設備の配置等の説明を追加
【補足-340-13】17. 剛な設備の固有周期の算出について 【補足-340-26】盤及び計装ラックの固有周期について	剛な設備の固有周期の算出について	・固有周期を算出せず剛とみなしている設備の固有周期の考え方及び固有値算出結果について示す。	[補足耐37]	【耐震機電17】剛な設備の固有周期の算出について	固有周期を算出せず剛とみなしている設備の固有周期の考え方及び固有値算出結果について説明	○	当該回次の申請範囲の固有周期を算出せず剛とみなしている設備の固有周期の考え方及び固有値算出結果について説明を追加
—	機器・配管系の類型化に対する分類の考え方について	・既設工認時の評価内容及び説明内容を踏まえ機器, 配管系に対する類型化の分類の考え方について示す。	[補足耐38]	【耐震機電07】機器・配管系の類型化に対する分類の考え方について	既設工認時の評価内容及び説明内容を踏まえ機器, 配管系に対する類型化の分類の考え方を説明	○	当該回次の申請範囲の類型化の分類の考え方の説明を追加
【補足-340-13】4. 機電設備の耐震計算書の作成について 【補足-340-28】耐震性についての計算書における評価温度の考え方について	機電設備の耐震計算書の作成について	・機電設備の耐震計算書の作成方針について構成, 記載方法, 記載の留意点等について示す。	[補足耐39]	【耐震機電19】機電設備の耐震計算書の作成について	機電設備の耐震計算書の作成方針について構成, 記載方法, 記載の留意点等を説明	○	当該回次の申請範囲の耐震計算書の作成方針について構成, 記載方法, 記載の留意点等の説明を追加
【補足-340-13】12. 応力を基準とした標準支持間隔法の適用について	配管系の評価手法(定ピッチスパン法)について	・配管系の耐震評価における配管の評価手法として既設工認にて設定した標準支持間隔に対する対応等について示す。	[補足耐40]	【耐震機電16】配管系の評価手法(定ピッチスパン法)について	配管系の耐震評価における配管の評価手法として既設工認にて設定した標準支持間隔に対する対応内容等について説明	○	当該回次の申請対象における既設工認にて設定した標準支持間隔に対する対応内容等について説明を追加
—	機器の耐震計算における既設工認からの計算式の変更点について	・機器の耐震計算書作成の基本方針の変更点として, 定型式への最新知見の反映等の考え方について示す。	[補足耐41]	— (次回以降)	—	○	機器の耐震計算書作成の基本方針の変更点として, 定型式への最新知見の反映等の考え方を説明
【補足-370-16】主排気筒及び非常用ガス処理系配管支持架構の耐震性評価に関する補足説明	既設工認からの変更点について	・耐震設計における既設工認から評価内容の評価条件等の変更内容について示す。	[補足耐42]	【耐震機電13】既設工認からの変更点について	当該回次の申請対象における既設工認からの変更内容について説明	○	当該回次の申請対象における既設工認からの変更内容について説明を追加

補足説明すべき項目の抽出
 (第五条(安全機能を有する施設の地盤)、第三十二条(重大事故等対処施設の地盤)、
 第六条、第三十三条(地震による損傷の防止))

東海第二発電所 補足説明資料	再処理施設 補足説明資料	記載概要	補足説明すべき事項	申請回数			
				1回	第1回 記載概要	2回	第2回 記載概要
—	機器と配管の相対変位に対する設計上の扱いについて	・機器と配管の取り付け部に対し、相対変位を考慮した設計内容について示す。	[補足耐43]	【耐震機電23】機器と配管の相対変位に対する設計上の扱いについて	機器と配管の取り付け部に対し、相対変位を考慮した設計内容について説明	○	当該回次の申請対象における機器と配管の取り付け部に対し、相対変位を考慮した設計内容について説明を追加
—	ダクト評価で用いる補正係数、安全係数の設定根拠について	・ダクト評価で用いる補正係数、安全係数の設定根拠について示す。	[補足耐44]	— (次回以降)	—	○	ダクト評価で用いる補正係数、安全係数の設定根拠について説明
【補足-500-1】計算機プログラム(解析コード)の概要に係る補足説明資料	計算機プログラム(解析コード)の概要について	・添付書類で使用する計算機プログラム(解析コード)の過去の使用実績やバージョン違いによる区分毎の整理内容について示す。	[補足耐45]	【耐震建物29】計算機プログラム(解析コード)の概要について	添付書類で使用する計算機プログラム(解析コード)の過去の使用実績やバージョン違いによる区分毎の整理について説明	○	当該回次の申請施設における計算機プログラム(解析コード)の過去の使用実績やバージョン違いによる区分毎の整理結果の説明を追加
【補足-400-1】地震応答解析における既設工認と今回工認の解析モデル及び手法の比較	土木構造物の地震応答解析における既設工認と今回工認の解析モデル及び手法の比較について	・土木構造物の地震応答解析における既設工認と今回工認の解析モデル及び手法の比較について示す。	[補足耐46]	— (次回以降)	—	○	土木構造物の地震応答解析における既設工認と今回工認の解析モデル及び手法の比較について説明
【補足-340-8】屋外重要土木構造物の耐震安全性評価について 1. 共通事項	土木構造物の耐震安全性評価における共通事項について	・土木構造物の耐震安全性評価における共通事項について示す。	[補足耐47]	— (次回以降)	—	○	土木構造物の耐震安全性評価における共通事項について説明
—	土木構造物の一関東評価用地震動(鉛直)に対する影響評価について	・土木構造物の一関東評価用地震動(鉛直)を用いた影響評価に関する検討内容について示す。	[補足耐48]	— (次回以降)	—	○	土木構造物の一関東評価用地震動(鉛直)を用いた影響評価に関する検討内容について説明
【補足-340-8】屋外重要土木構造物の耐震安全性評価について 1.5 地盤物性のばらつき考慮方法	土木構造物の地震応答解析における材料物性のばらつきに関する検討について	・土木構造物の動的解析における材料物性のばらつき考慮に関する根拠を示すため、ばらつき考慮に係る検討内容について示す。	[補足耐49]	— (次回以降)	—	○	土木構造物の動的解析における材料物性のばらつき考慮に関する根拠を示すため、ばらつき考慮に係る検討内容について説明
【補足-340-8】屋外重要土木構造物の耐震安全性評価について 2.以降 各構造物の耐震安全性評価	土木構造物の液状化の影響評価について	・土木構造物の液状化による影響評価について示す。	[補足耐50]	— (次回以降)	—	○	土木構造物の液状化による影響評価について説明
【補足-340-7】水平2方向及び鉛直方向の適切な組合せに関する検討について	土木構造物の水平2方向及び鉛直方向地震力の組合せに関する影響評価について	・土木構造物の水平2方向及び鉛直方向地震力の組合せに関する影響評価について、評価対象断面の選定と評価方法について示す。	[補足耐51]	— (次回以降)	—	○	土木構造物の水平2方向及び鉛直方向地震力の組合せに関する影響評価について、評価対象断面の選定と評価方法を説明

補足説明すべき項目の抽出
 (第五条(安全機能を有する施設の地盤)、第三十二条(重大事故等対処施設の地盤)、
 第六条、第三十三条(地震による損傷の防止))

東海第二発電所 補足説明資料	再処理施設 補足説明資料	記載概要	補足説明すべき事項	申請回次			
				1回	第1回 記載概要	2回	第2回 記載概要
【補足-340-8】1.4 屋外重要土木構造部の耐震評価における断面選定の考え方	土木建造物の耐震評価における断面選定の考え方について	・土木建造物の断面選定の考え方を示すとともに、評価対象断面の抽出結果について示す。	[補足耐52]	— (次回以降)	—	○	土木建造物の断面選定の考え方を示すとともに、評価対象断面の抽出結果について説明
—	耐震設計における安全機能の整理について	・再処理施設の要求機能の整理内容について説明する。	[補足耐53]	【耐震建物30】耐震設計における安全機能の整理について	再処理施設の要求機能の整理内容について説明	△	第1回での説明から追加事項なし

別紙 6

変更前記載事項の 既設工認等との紐づけ

基本設計方針の第1回申請範囲(1/26)

全体	第1回申請範囲
<p>第1章 共通項目</p> <p>3. 自然現象等</p> <p>3.1 地震による損傷の防止</p> <p>3.1.1 耐震設計</p> <p>(1) 耐震設計の基本方針 再処理施設は、次の方針に基づき耐震設計を行う。 なお、以下の項目における建物・構築物とは、建物、構築物及び土木構造物（屋外重要土木構造物及びその他の土木構造物）の総称とする。 また、屋外重要土木構造物とは、耐震安全上重要な機器・配管系の間接支持機能を求められる土木構造物をいう。</p> <p>a. 安全機能を有する施設</p> <p>(a) 安全機能を有する施設は、地震の発生によって生ずるおそれがある安全機能の喪失及びそれに続く放射線による公衆への影響を防止する観点から、施設の安全機能が喪失した場合の影響の相対的な程度（以下「耐震重要度」という。）に応じて、Sクラス、Bクラス又はCクラスに分類し、それぞれの耐震重要度に応じた地震力に十分耐えられる設計とする。</p> <p>(b) 耐震重要施設（(a)においてSクラスに分類する施設をいう。）は、その供用中に大きな影響を及ぼすおそれがある地震動（事業指定(変更許可)を受けた基準地震動（以下「基準地震動S_s」という。））による地震力に対してその安全機能が損なわれるおそれがない設計とする。</p> <p>(c) Sクラスの施設は、基準地震動S_sによる地震力に対してその安全機能が損なわれるおそれがない設計とする。</p> <p>建物・構築物については、基準地震動S_sによる地震力に対して、建物・構築物全体としての変形能力（耐震壁のせん断ひずみ等）が終局耐力時の変形に対して十分な余裕を有し、部材・部位ごとのせん断ひずみ・応力等が終局耐力時のせん断ひずみ・応力等に対して、妥当な安全余裕を有する設計とする。</p> <p>機器・配管系については、基準地震動S_sによる地震力に対して、その施設に要求される機能を保持する設計とし、塑性域に達するひずみが生じる場合であっても、その量が小さなレベルに留まって破断延性限界に十分な余裕を有し、その施設に要求される機能に影響を及ぼさない、また、動的機器等については、基準地震動S_sによる応答に対してその設備に要求される機能を保持する設計とする。なお、動的機能が要求される機器については、当該機器の構造、動作原理等を考慮した評価を行い、既往の研究等で機能維持の確認がなされた機能確認済加速度等を超えていないことを確認する。</p>	<p>第1章 共通項目</p> <p>3. 自然現象等</p> <p>3.1 地震による損傷の防止</p> <p>3.1.1 耐震設計</p> <p>(1) 耐震設計の基本方針 再処理施設は、次の方針に基づき耐震設計を行う。 なお、以下の項目における建物・構築物とは、建物、構築物及び土木構造物（屋外重要土木構造物及びその他の土木構造物）の総称とする。 また、屋外重要土木構造物とは、耐震安全上重要な機器・配管系の間接支持機能を求められる土木構造物をいう。</p> <p>a. 安全機能を有する施設</p> <p>(a) 安全機能を有する施設は、地震の発生によって生ずるおそれがある安全機能の喪失及びそれに続く放射線による公衆への影響を防止する観点から、施設の安全機能が喪失した場合の影響の相対的な程度（以下「耐震重要度」という。）に応じて、Sクラス、Bクラス又はCクラスに分類し、それぞれの耐震重要度に応じた地震力に十分耐えられる設計とする。</p> <p>(b) 耐震重要施設（(a)においてSクラスに分類する施設をいう。）は、その供用中に大きな影響を及ぼすおそれがある地震動（事業指定(変更許可)を受けた基準地震動（以下「基準地震動S_s」という。））による地震力に対してその安全機能が損なわれるおそれがない設計とする。</p> <p>(c) Sクラスの施設は、基準地震動S_sによる地震力に対してその安全機能が損なわれるおそれがない設計とする。</p> <p>建物・構築物については、基準地震動S_sによる地震力に対して、建物・構築物全体としての変形能力（耐震壁のせん断ひずみ等）が終局耐力時の変形に対して十分な余裕を有し、部材・部位ごとのせん断ひずみ・応力等が終局耐力時のせん断ひずみ・応力等に対して、妥当な安全余裕を有する設計とする。</p> <p>機器・配管系については、基準地震動S_sによる地震力に対して、その施設に要求される機能を保持する設計とし、塑性域に達するひずみが生じる場合であっても、その量が小さなレベルに留まって破断延性限界に十分な余裕を有し、その施設に要求される機能に影響を及ぼさない、また、動的機器等については、基準地震動S_sによる応答に対してその設備に要求される機能を保持する設計とする。なお、動的機能が要求される機器については、当該機器の構造、動作原理等を考慮した評価を行い、既往の研究等で機能維持の確認がなされた機能確認済加速度等を超えていないことを確認する。</p>

基本設計方針の第 1 回申請範囲 (2/26)

全体	第 1 回申請範囲
<p>また、Sクラスの施設は、事業指定(変更許可)を受けた弾性設計用地震動(以下「弾性設計用地震動S d」という。)による地震力又は静的地震力のいずれか大きい方の地震力に対しておおむね弾性状態に留まる範囲で耐えられる設計とする。</p> <p>建物・構築物については、弾性設計用地震動S dによる地震力又は静的地震力のいずれか大きい方の地震力により発生する応力に対して、建築基準法等の安全上適切と認められる規格及び基準による許容応力度を許容限界とする。</p> <p>機器・配管系については、弾性設計用地震動S dによる地震力又は静的地震力のいずれか大きい方の地震力による応答が全体的におおむね弾性状態に留まる設計とする。</p> <p>(d) Sクラスの施設について、静的地震力は、水平地震力と鉛直地震力が同時に不利な方向の組合せで作用するものとする。</p> <p>また、基準地震動S s及び弾性設計用地震動S dによる地震力は、水平2方向及び鉛直方向について適切に組み合わせて算定するものとする。</p> <p>(e) Bクラス及びCクラスの施設は、静的地震力に対しておおむね弾性状態に留まる範囲で耐えられる設計とする。また、Bクラスの施設のうち、共振のおそれのある施設については、その影響についての検討を行う。検討に用いる地震動は、弾性設計用地震動S dに2分の1を乗じたものとする。当該地震動による地震力は、水平2方向及び鉛直方向について適切に組み合わせて算定するものとする。</p> <p>(f) 耐震重要施設は、耐震重要度の下位のクラスに属する施設の波及的影響によって、その安全機能を損なわない設計とする。</p> <p>(g) 耐震重要施設については、周辺地盤の変状により、その安全機能が損なわれるおそれがない設計とする。</p> <p>b. 重大事故等対処施設</p> <p>(a) 重大事故等対処施設について、安全機能を有する施設の耐震設計における動的地震力又は静的地震力に対する設計方針を踏襲し、重大事故等対処施設の構造上の特徴、重大事故等時における運転状態及び重大事故等の状態で施設に作用する荷重等を考慮し、適用する地震力に対して重大事故等に対処するために必要な機能が損なわれるおそれがない設計とする。</p>	<p>また、Sクラスの施設は、事業指定(変更許可)を受けた弾性設計用地震動(以下「弾性設計用地震動S d」という。)による地震力又は静的地震力のいずれか大きい方の地震力に対しておおむね弾性状態に留まる範囲で耐えられる設計とする。</p> <p>建物・構築物については、弾性設計用地震動S dによる地震力又は静的地震力のいずれか大きい方の地震力により発生する応力に対して、建築基準法等の安全上適切と認められる規格及び基準による許容応力度を許容限界とする。</p> <p>機器・配管系については、弾性設計用地震動S dによる地震力又は静的地震力のいずれか大きい方の地震力による応答が全体的におおむね弾性状態に留まる設計とする。</p> <p>(d) Sクラスの施設について、静的地震力は、水平地震力と鉛直地震力が同時に不利な方向の組合せで作用するものとする。</p> <p>また、基準地震動S s及び弾性設計用地震動S dによる地震力は、水平2方向及び鉛直方向について適切に組み合わせて算定するものとする。</p> <p>(e) Bクラス及びCクラスの施設は、静的地震力に対しておおむね弾性状態に留まる範囲で耐えられる設計とする。また、Bクラスの施設のうち、共振のおそれのある施設については、その影響についての検討を行う。検討に用いる地震動は、弾性設計用地震動S dに2分の1を乗じたものとする。当該地震動による地震力は、水平2方向及び鉛直方向について適切に組み合わせて算定するものとする。</p> <p>(f) 耐震重要施設は、耐震重要度の下位のクラスに属する施設の波及的影響によって、その安全機能を損なわない設計とする。</p> <p>(g) 耐震重要施設については、周辺地盤の変状により、その安全機能が損なわれるおそれがない設計とする。</p> <p>b. 重大事故等対処施設</p> <p>(重大事故等対処施設に係る基本設計方針については、重大事故等対処施設の詳細設計の対象となる申請書で示す。)</p>

基本設計方針の第1回申請範囲(3/26)

全体	第1回申請範囲
<p>重大事故等対処施設について、施設の各設備が有する重大事故等に対処するために必要な機能及び設置状態を踏まえて、常設耐震重要重大事故等対処設備、常設耐震重要重大事故等対処設備以外の常設重大事故等対処設備に分類し、それぞれの設備分類に応じて設計する。</p> <p>(b) 常設耐震重要重大事故等対処設備が設置される重大事故等対処施設は、基準地震動S_sによる地震力に対して、重大事故等に対処するために必要な機能が損なわれるおそれがない設計とする。</p> <p>建物・構築物については、基準地震動S_sによる地震力に対して、建物・構築物全体としての変形能力（耐震壁のせん断ひずみ等）が終局耐力時の変形に対して十分な余裕を有し、部材・部位ごとのせん断ひずみ・応力等が終局耐力時のせん断ひずみ・応力等に対して、妥当な安全余裕を有する設計とする。</p> <p>機器・配管系については、基準地震動S_sによる地震力に対して、その施設に要求される機能を保持する設計とし、塑性域に達するひずみが生じる場合であっても、その量が小さなレベルに留まって破断延性限界に十分な余裕を有し、その施設に要求される機能に影響を及ぼさない設計とする。また、動的機器等については、基準地震動S_sによる応答に対して、その設備に要求される機能を保持する設計とする。なお、動的機能が要求される機器については、当該機器の構造、動作原理等を考慮した評価を行い、既往の研究等で機能維持の確認がなされた機能確認済加速度等を超えていないことを確認する。</p> <p>(c) 常設耐震重要重大事故等対処設備が設置される重大事故等対処施設に適用する基準地震動S_sによる地震力は、水平2方向及び鉛直方向について適切に組み合わせて算定するものとする。</p> <p>(d) 常設耐震重要重大事故等対処設備以外の常設重大事故等対処設備が設置される重大事故等対処施設は、代替する機能を有する安全機能を有する施設が属する耐震重要度に適用される地震力に十分耐えることができる設計とする。</p> <p>また、代替する安全機能を有する施設がない常設重大事故等対処設備は、安全機能を有する施設の耐震設計における耐震重要度の分類の方針に基づき、重大事故等対処時の使用条件を踏まえて、当該設備の機能喪失により放射線による公衆への影響の程度に応じて分類し、その地震力に対し十分に耐えることができる設計とする。</p> <p>(e) 常設耐震重要重大事故等対処設備が設置される重大事故等対処施設は、Bクラス及びCクラスの施設、常設耐震重要重大事故等対処設備以外の常設重大事故等対処設備が設置される重大事故等対処施設、可搬型重大事故等対処設備の波及的影響によって、その重大事故等に対処するために必要な機能を損なわない設計とする。</p>	

基本設計方針の第 1 回申請範囲 (4/26)

全体	第 1 回申請範囲
<p>(f) 緊急時対策所の耐震設計の基本方針については、「(6) 緊急時対策所」に示す。</p> <p>(g) 常設耐震重要重大事故等対処設備が設置される重大事故等対処施設については、周辺地盤の変状により、重大事故等に対処するために必要な機能が損なわれるおそれがない設計とする。</p> <p>(2) 耐震設計上の重要度分類及び重大事故等対処施設の設備分類</p> <p>a. 安全機能を有する施設の耐震設計上の重要度分類</p> <p>安全機能を有する施設の耐震重要度を以下のとおり分類する。</p> <p>(a) Sクラスの施設 自ら放射性物質を内蔵している施設、当該施設に直接関係しておりその機能喪失により放射性物質を外部に拡散する可能性のある施設、放射性物質を外部に放出する可能性のある事態を防止するために必要な施設及び事故発生の際に、外部に放出される放射性物質による影響を低減させるために必要な施設であって、環境への影響が大きいもの。</p> <p>イ. その破損又は機能喪失により臨界事故を起こすおそれのある施設</p> <p>ロ. 使用済燃料を貯蔵するための施設</p> <p>ハ. 高レベル放射性液体廃棄物を内蔵する系統及び機器並びにその冷却系統</p> <p>ニ. プルトニウムを含む溶液を内蔵する系統及び機器</p> <p>ホ. 上記ハ. 及びニ. の系統及び機器から放射性物質が漏えいした場合に、その影響の拡大を防止するための施設</p> <p>ヘ. 上記ハ., ニ. 及びホ. に関連する施設で放射性物質の外部への放出を抑制するための施設</p> <p>ト. 上記イ. からヘ. の施設の機能を確保するために必要な施設</p> <p>(b) Bクラスの施設 安全機能を有する施設のうち、機能喪失した場合の影響がSクラスに属する施設と比べ小さい施設。</p> <p>イ. 放射性物質を内蔵している施設であって、Sクラスに属さない施設（ただし、内蔵量が少ないか又は貯蔵方式により、その破損により公衆に与える放射線の影響が十分小さいものは除く。）</p> <p>ロ. 放射性物質の放出を伴うような場合に、その外部放散を抑制するための施設で、Sクラスに属さない施設</p> <p>(c) Cクラスの施設 Sクラスに属する施設及びBクラスに属する施設以外の一般産業施設又は公共施設と同等の安全性が要求される施設。</p>	<p>(2) 耐震設計上の重要度分類</p> <p>a. 安全機能を有する施設の耐震設計上の重要度分類</p> <p>安全機能を有する施設の耐震重要度を以下のとおり分類する。</p> <p>(a) Sクラスの施設 自ら放射性物質を内蔵している施設、当該施設に直接関係しておりその機能喪失により放射性物質を外部に拡散する可能性のある施設、放射性物質を外部に放出する可能性のある事態を防止するために必要な施設及び事故発生の際に、外部に放出される放射性物質による影響を低減させるために必要な施設であって、環境への影響が大きいもの。</p> <p>イ. その破損又は機能喪失により臨界事故を起こすおそれのある施設</p> <p>ロ. 使用済燃料を貯蔵するための施設</p> <p>ハ. 高レベル放射性液体廃棄物を内蔵する系統及び機器並びにその冷却系統</p> <p>ニ. プルトニウムを含む溶液を内蔵する系統及び機器</p> <p>ホ. 上記ハ. 及びニ. の系統及び機器から放射性物質が漏えいした場合に、その影響の拡大を防止するための施設</p> <p>ヘ. 上記ハ., ニ. 及びホ. に関連する施設で放射性物質の外部への放出を抑制するための施設</p> <p>ト. 上記イ. からヘ. の施設の機能を確保するために必要な施設</p> <p>(b) Bクラスの施設 安全機能を有する施設のうち、機能喪失した場合の影響がSクラスに属する施設と比べ小さい施設。</p> <p>イ. 放射性物質を内蔵している施設であって、Sクラスに属さない施設（ただし、内蔵量が少ないか又は貯蔵方式により、その破損により公衆に与える放射線の影響が十分小さいものは除く。）</p> <p>ロ. 放射性物質の放出を伴うような場合に、その外部放散を抑制するための施設で、Sクラスに属さない施設</p> <p>(c) Cクラスの施設 Sクラスに属する施設及びBクラスに属する施設以外の一般産業施設又は公共施設と同等の安全性が要求される施設。</p>

基本設計方針の第 1 回申請範囲 (5/26)

全体	第 1 回申請範囲
<p>上記に基づく耐震設計上の重要度分類を第 3.1.1-1 表に示す。 なお、同表には当該施設を支持する建物・構築物の支持機能が維持されることを確認する地震動及び波及的影響を考慮すべき施設に適用する地震動についても併記する。</p> <p>b. 重大事故等対処施設の設備分類 重大事故等対処施設について、施設の各設備が有する重大事故等に対処するために必要な機能及び設置状態を踏まえて、以下の設備分類に応じた設計とする。</p> <p>(a) 常設重大事故等対処設備 重大事故に至るおそれがある事故及び重大事故が発生した場合において、対処するために必要な機能を有する設備であって常設のもの。</p> <p>イ. 常設耐震重要重大事故等対処設備 常設重大事故等対処設備であって、耐震重要施設に属する設計基準事故に対処するための設備が有する機能を代替するもの。</p> <p>ロ. 常設耐震重要重大事故等対処設備以外の常設重大事故等対処設備 常設重大事故等対処設備であって、上記イ. 以外のもの。</p> <p>上記に基づく重大事故等対処施設の設備分類について第 3.1.1-2 表に示す。 なお、同表には、重大事故等対処設備を支持する建物・構築物の支持機能が損なわれないことを確認する地震力についても併記する。</p> <p>(3) 地震力の算定方法 耐震設計に用いる設計用地震力は、以下の方法で算定される静的地震力及び動的地震力とする。</p> <p>a. 静的地震力 安全機能を有する施設に適用する静的地震力は、Sクラス、Bクラス及びCクラスの施設に適用することとし、それぞれの耐震重要度に応じて以下の地震層せん断力係数及び震度に基づき算定する。</p> <p>重大事故等対処施設については、常設耐震重要重大事故等対処設備以外の常設重大事故等対処設備が設置される重大事故等対処施設に、代替する機能を有する安全機能を有する施設が属する耐震重要度に適用される地震力を適用する。</p>	<p>上記に基づく耐震設計上の重要度分類を第 3.1.1-1 表に示す。 なお、同表には当該施設を支持する建物・構築物の支持機能が維持されることを確認する地震動及び波及的影響を考慮すべき施設に適用する地震動についても併記する。</p> <p>b. 重大事故等対処施設の設備分類 (重大事故等対処施設に係る基本設計方針については、重大事故等対処施設の詳細設計の対象となる申請書で示す。)</p> <p>(3) 地震力の算定方法 耐震設計に用いる設計用地震力は、以下の方法で算定される静的地震力及び動的地震力とする。</p> <p>a. 静的地震力 安全機能を有する施設に適用する静的地震力は、Sクラス、Bクラス及びCクラスの施設に適用することとし、それぞれの耐震重要度に応じて以下の地震層せん断力係数及び震度に基づき算定する。</p> <p>(重大事故等対処施設に係る基本設計方針については、重大事故等対処施設の詳細設計の対象となる申請書で示す。)</p>

基本設計方針の第 1 回申請範囲 (6/26)

全体	第 1 回申請範囲
<p>(a) 建物・構築物</p> <p>水平地震力は、地震層せん断力係数 C_i に、次に示す施設の耐震重要度に応じた係数を乗じ、さらに当該層以上の重量を乗じて算定するものとする。</p> <p>Sクラス 3.0 Bクラス 1.5 Cクラス 1.0</p> <p>ここで、地震層せん断力係数 C_i は、標準せん断力係数 C_0 を 0.2 以上とし、建物・構築物の振動特性、地盤の種類等を考慮して求められる値とする。</p> <p>また、必要保有水平耐力の算定においては、地震層せん断力係数 C_i に乗じる施設の耐震重要度に応じた係数は、耐震重要度の各クラスともに 1.0 とし、その際に用いる標準せん断力係数 C_0 は 1.0 以上とする。</p> <p>Sクラスの施設については、水平地震力と鉛直地震力が同時に不利な方向の組合せで作用するものとする。鉛直地震力は、震度 0.3 以上を基準とし、建物・構築物の振動特性及び地盤の種類等を考慮し、高さ方向に一定として求めた鉛直震度より算定する。</p> <p>(b) 機器・配管系</p> <p>耐震重要度の各クラスの地震力は、上記(a)に示す地震層せん断力係数 C_i に施設の耐震重要度に応じた係数を乗じたものを水平震度とし、当該水平震度及び上記(a)の鉛直震度をそれぞれ 20% 増しとした震度より求めるものとする。</p> <p>Sクラスの施設については、水平地震力と鉛直地震力は同時に不利な方向の組合せで作用するものとする。ただし、鉛直震度は高さ方向に一定とする。</p> <p>上記(a)及び(b)の標準せん断力係数 C_0 等の割増し係数については、耐震性向上の観点から、一般産業施設及び公共施設の耐震基準との関係を考慮して設定する。</p> <p>b. 動的地震力</p> <p>安全機能を有する施設について、Sクラスの施設の設計に適用する動的地震力は、基準地震動 S_s 及び弾性設計用地震動 S_d から定める入力地震動を適用する。</p> <p>Bクラスの施設のうち共振のおそれのある施設については、上記Sクラスの施設に適用する弾性設計用地震動 S_d に 2 分の 1 を乗じたものから定める入力地震動を適用する。</p>	<p>(a) 建物・構築物</p> <p>水平地震力は、地震層せん断力係数 C_i に、次に示す施設の耐震重要度に応じた係数を乗じ、さらに当該層以上の重量を乗じて算定するものとする。</p> <p>Sクラス 3.0 Bクラス 1.5 Cクラス 1.0</p> <p>ここで、地震層せん断力係数 C_i は、標準せん断力係数 C_0 を 0.2 以上とし、建物・構築物の振動特性、地盤の種類等を考慮して求められる値とする。</p> <p>また、必要保有水平耐力の算定においては、地震層せん断力係数 C_i に乗じる施設の耐震重要度に応じた係数は、耐震重要度の各クラスともに 1.0 とし、その際に用いる標準せん断力係数 C_0 は 1.0 以上とする。</p> <p>Sクラスの施設については、水平地震力と鉛直地震力が同時に不利な方向の組合せで作用するものとする。鉛直地震力は、震度 0.3 以上を基準とし、建物・構築物の振動特性及び地盤の種類等を考慮し、高さ方向に一定として求めた鉛直震度より算定する。</p> <p>(b) 機器・配管系</p> <p>耐震重要度の各クラスの地震力は、上記(a)に示す地震層せん断力係数 C_i に施設の耐震重要度に応じた係数を乗じたものを水平震度とし、当該水平震度及び上記(a)の鉛直震度をそれぞれ 20% 増しとした震度より求めるものとする。</p> <p>Sクラスの施設については、水平地震力と鉛直地震力は同時に不利な方向の組合せで作用するものとする。ただし、鉛直震度は高さ方向に一定とする。</p> <p>上記(a)及び(b)の標準せん断力係数 C_0 等の割増し係数については、耐震性向上の観点から、一般産業施設及び公共施設の耐震基準との関係を考慮して設定する。</p> <p>b. 動的地震力</p> <p>安全機能を有する施設について、Sクラスの施設の設計に適用する動的地震力は、基準地震動 S_s 及び弾性設計用地震動 S_d から定める入力地震動を適用する。</p> <p>Bクラスの施設のうち共振のおそれのある施設については、上記Sクラスの施設に適用する弾性設計用地震動 S_d に 2 分の 1 を乗じたものから定める入力地震動を適用する。</p>

基本設計方針の第 1 回申請範囲 (7/26)

全体	第 1 回申請範囲
<p>重大事故等対処施設については、常設耐震重要重大事故等対処設備が設置される重大事故等対処施設に基準地震動 S_s による地震力を適用する。</p> <p>常設耐震重要重大事故等対処設備以外の常設重大事故等対処設備が設置される重大事故等対処施設のうち、Bクラスに属する施設の機能を代替する施設であって共振のおそれのある施設については、「b. 動的地震力」に示す共振のおそれのある Bクラス施設に適用する地震力を適用する。</p> <p>また、常設耐震重要重大事故等対処設備以外の常設重大事故等対処設備で、代替する安全機能を有する施設がない常設重大事故等対処設備のうち、Sクラスの施設は常設耐震重要重大事故等対処設備に適用する地震力を適用する。</p> <p>なお、重大事故等対処施設のうち、安全機能を有する施設の基本構造と異なる施設については、適用する地震力に対して、要求される機能及び構造健全性が維持されることを確認するため、当該施設の構造を適切にモデル化した上での地震応答解析、加振試験等を実施する。</p> <p>安全機能を有する施設及び重大事故等対処施設の動的解析においては、地盤の諸定数も含めて材料のばらつきによる変動幅を適切に考慮する。</p> <p>動的地震力は、水平 2 方向及び鉛直方向について適切に組み合わせて算定する。水平 2 方向及び鉛直方向地震力の組合せによる影響確認に当たっては、水平 1 方向及び鉛直方向地震力を組み合わせた既往の耐震計算への影響が考えられる施設、設備の部位を抽出し、建物・構築物の 3 次元応答性状及びそれによる機器・配管系への影響を考慮した上で、既往の方法を用いた耐震性に及ぼす影響を評価する。</p>	<p>安全機能を有する施設の動的解析においては、地盤の諸定数も含めて材料のばらつきによる変動幅を適切に考慮する。</p> <p>動的地震力は、水平 2 方向及び鉛直方向について適切に組み合わせて算定する。水平 2 方向及び鉛直方向地震力の組合せによる影響確認に当たっては、水平 1 方向及び鉛直方向地震力を組み合わせた既往の耐震計算への影響が考えられる施設、設備の部位を抽出し、建物・構築物の 3 次元応答性状及びそれによる機器・配管系への影響を考慮した上で、既往の方法を用いた耐震性に及ぼす影響を評価する。</p> <p>(重大事故等対処施設に係る基本設計方針については、重大事故等対処施設の詳細設計の対象となる申請書で示す。)</p>

基本設計方針の第 1 回申請範囲 (8/26)

全体	第 1 回申請範囲
<p>(a) 入力地震動</p> <p>地質調査の結果によれば、重要な再処理施設の設置位置周辺は、新第三紀の鷹架層が十分な広がりをもって存在することが確認されている。</p> <p>解放基盤表面は、この新第三紀の鷹架層の S 波速度が 0.7 km/s 以上を有する標高約 -70m の位置に想定することとする。</p> <p>基準地震動 S_s 及び弾性設計用地震動 S_d は、解放基盤表面で定義する。</p> <p>建物・構築物の地震応答解析モデルに対する入力地震動は、解放基盤表面からの地震波の伝播特性を適切に考慮した上で、必要に応じ 2 次元 FEM 解析又は 1 次元波動論により、地震応答解析モデルの入力位置で評価した入力地震動を設定する。また、必要に応じて地盤の非線形応答に関する動的変形特性を考慮することとし、地盤のひずみに応じた地盤物性値を用いて作成する。非線形性の考慮に当たっては、地下水排水設備による地下水位の低下状態を踏まえ評価する。</p> <p>地盤条件を考慮する場合には、地震動評価で考慮した敷地全体の地下構造との関係や対象建物・構築物の直下又は周辺の地質・速度構造の違いにも留意する。</p> <p>また、必要に応じ敷地における観測記録による検証や最新の科学的・技術的知見を踏まえ、地質・速度構造等の地盤条件を設定する。</p> <p>B クラスの施設及び B クラス施設の機能を代替する常設重大事故等対処設備が設置される重大事故等対処施設のうち共振のおそれがあり、動的解析が必要なものに対しては、弾性設計用地震動 S_d に 2 分の 1 を乗じたものを用いる。</p>	<p>(a) 入力地震動</p> <p>地質調査の結果によれば、重要な再処理施設の設置位置周辺は、新第三紀の鷹架層が十分な広がりをもって存在することが確認されている。</p> <p>解放基盤表面は、この新第三紀の鷹架層の S 波速度が 0.7 km/s 以上を有する標高約 -70m の位置に想定することとする。</p> <p>基準地震動 S_s 及び弾性設計用地震動 S_d は、解放基盤表面で定義する。</p> <p>建物・構築物の地震応答解析モデルに対する入力地震動は、解放基盤表面からの地震波の伝播特性を適切に考慮した上で、必要に応じ 2 次元 FEM 解析又は 1 次元波動論により、地震応答解析モデルの入力位置で評価した入力地震動を設定する。また、必要に応じて地盤の非線形応答に関する動的変形特性を考慮することとし、地盤のひずみに応じた地盤物性値を用いて作成する。非線形性の考慮に当たっては、地下水排水設備による地下水位の低下状態を踏まえ評価する。</p> <p>地盤条件を考慮する場合には、地震動評価で考慮した敷地全体の地下構造との関係や対象建物・構築物の直下又は周辺の地質・速度構造の違いにも留意する。</p> <p>また、必要に応じ敷地における観測記録による検証や最新の科学的・技術的知見を踏まえ、地質・速度構造等の地盤条件を設定する。</p> <p>B クラスの施設のうち共振のおそれがあり、動的解析が必要なものに対しては、弾性設計用地震動 S_d に 2 分の 1 を乗じたものを用いる。</p> <p>(重大事故等対処施設に係る基本設計方針については、重大事故等対処施設の詳細設計の対象となる申請書で示す。)</p>

基本設計方針の第 1 回申請範囲 (9/26)

全体	第 1 回申請範囲
<p>(b) 動的解析法</p> <p>イ. 建物・構築物</p> <p>動的解析に当たっては、対象施設の形状、構造特性、振動特性等を踏まえ、地震応答解析手法の適用性及び適用限界等を考慮のうえ、適切な解析法を選定するとともに、建物・構築物に応じて十分な調査に基づく適切な解析条件を設定する。動的解析は、原則として、時刻歴応答解析法を用いて求めるものとする。</p> <p>また、3次元応答性状等の評価は、線形解析に適用可能な周波数応答解析法による。</p> <p>建物・構築物の動的解析に当たっては、建物・構築物の剛性はそれらの形状、構造特性、振動特性、減衰特性を十分考慮して評価し、集中質点系に置換した解析モデルを設定する。</p> <p>動的解析には、建物・構築物と地盤の相互作用及び埋込み効果を考慮するものとし、解析モデルの地盤のばね定数は、基礎版の平面形状、地盤の剛性等を考慮して定める。地盤の剛性等については、必要に応じて地盤の非線形応答を考慮することとし、地盤のひずみに応じた地盤物性値に基づくものとする。設計用地盤定数の設定に当たっては、地盤の構造特性の考慮として、地震動評価で考慮した敷地全体の地下構造との関係や対象建物・構築物の直下又は周辺の地質・速度構造の違いにも留意し、原則として、弾性波試験によるものを用いる。</p> <p>地盤－建物・構築物連成系の減衰定数は、振動エネルギーの地下逸散及び地震応答における各部のひずみレベルを考慮して定める。</p> <p>基準地震動 S_s 及び弾性設計用地震動 S_d に対する応答解析において、主要構造要素がある程度以上弾性範囲を超える場合には、実験等の結果に基づき、該当する建物部分の構造特性に応じて、その弾塑性挙動を適切に模擬した復元力特性を考慮した応答解析を行う。</p> <p>また、Sクラスの施設を支持する建物・構築物及び常設耐震重要重大事故等対処設備が設置される重大事故等対処施設を支持する建物・構築物の支持機能を検討するための動的解析において、当該施設を支持する建物・構築物の主要構造要素がある程度以上弾性範囲を超える場合には、その弾塑性挙動を適切に模擬した復元力特性を考慮した応答解析を行う。</p> <p>地震応答解析に用いる材料定数については、地盤の諸定数も含めて材料のばらつきによる変動幅を適切に考慮する。また、材料のばらつきによる変動が建物・構築物の振動性状や応答性状に及ぼす影響として考慮すべき要因を選定した上で、選定された要因を考慮した動的解析により設計用地震力を設定する。</p>	<p>(b) 動的解析法</p> <p>イ. 建物・構築物</p> <p>動的解析に当たっては、対象施設の形状、構造特性、振動特性等を踏まえ、地震応答解析手法の適用性及び適用限界等を考慮のうえ、適切な解析法を選定するとともに、建物・構築物に応じて十分な調査に基づく適切な解析条件を設定する。動的解析は、原則として、時刻歴応答解析法を用いて求めるものとする。</p> <p>また、3次元応答性状等の評価は、線形解析に適用可能な周波数応答解析法による。</p> <p>建物・構築物の動的解析に当たっては、建物・構築物の剛性はそれらの形状、構造特性、振動特性、減衰特性を十分考慮して評価し、集中質点系に置換した解析モデルを設定する。</p> <p>動的解析には、建物・構築物と地盤の相互作用及び埋込み効果を考慮するものとし、解析モデルの地盤のばね定数は、基礎版の平面形状、地盤の剛性等を考慮して定める。地盤の剛性等については、必要に応じて地盤の非線形応答を考慮することとし、地盤のひずみに応じた地盤物性値に基づくものとする。設計用地盤定数の設定に当たっては、地盤の構造特性の考慮として、地震動評価で考慮した敷地全体の地下構造との関係や対象建物・構築物の直下又は周辺の地質・速度構造の違いにも留意し、原則として、弾性波試験によるものを用いる。</p> <p>地盤－建物・構築物連成系の減衰定数は、振動エネルギーの地下逸散及び地震応答における各部のひずみレベルを考慮して定める。</p> <p>基準地震動 S_s 及び弾性設計用地震動 S_d に対する応答解析において、主要構造要素がある程度以上弾性範囲を超える場合には、実験等の結果に基づき、該当する建物部分の構造特性に応じて、その弾塑性挙動を適切に模擬した復元力特性を考慮した応答解析を行う。</p> <p>また、Sクラスの施設を支持する建物・構築物の支持機能を検討するための動的解析において、当該施設を支持する建物・構築物の主要構造要素がある程度以上弾性範囲を超える場合には、その弾塑性挙動を適切に模擬した復元力特性を考慮した応答解析を行う。</p> <p>地震応答解析に用いる材料定数については、地盤の諸定数も含めて材料のばらつきによる変動幅を適切に考慮する。また、材料のばらつきによる変動が建物・構築物の振動性状や応答性状に及ぼす影響として考慮すべき要因を選定した上で、選定された要因を考慮した動的解析により設計用地震力を設定する。</p>

基本設計方針の第 1 回申請範囲 (10/26)

全体	第 1 回申請範囲
<p>建物・構築物の動的解析においては、地下水排水設備による地下水位の低下を考慮して適切な解析手法を選定する。ここで、地震時の地盤の有効応力の変化に応じた影響を考慮する場合は、有効応力解析を実施する。有効応力解析に用いる液状化強度特性は、敷地の原地盤における代表性及び網羅性を踏まえた上で保守性を考慮して設定することを基本とする。</p> <p>動的解析に用いる解析モデルは、地震観測網により得られた観測記録により振動性状の把握を行い、解析モデルの妥当性の確認を行う。</p> <p>建物・構築物のうち土木建造物の動的解析に当たっては、構造物と地盤の相互作用を考慮できる連成系の地震応答解析手法を用いる。地震応答解析手法は、地盤及び構造物の地震時における非線形挙動の有無や程度に応じて、線形、等価線形又は非線形解析のいずれかによる。地盤の地震応答解析モデルは、構造物と地盤の動的相互作用を考慮できる有限要素法を用いる。構造物の地震応答解析に用いる減衰定数については、地盤と構造物の非線形性を考慮して適切に設定する。</p> <p>地震力については、水平 2 方向及び鉛直方向について適切に組み合わせて算定する。</p>	<p>建物・構築物の動的解析においては、地下水排水設備による地下水位の低下を考慮して適切な解析手法を選定する。ここで、地震時の地盤の有効応力の変化に応じた影響を考慮する場合は、有効応力解析を実施する。有効応力解析に用いる液状化強度特性は、敷地の原地盤における代表性及び網羅性を踏まえた上で保守性を考慮して設定することを基本とする。</p> <p>動的解析に用いる解析モデルは、地震観測網により得られた観測記録により振動性状の把握を行い、解析モデルの妥当性の確認を行う。</p> <p>建物・構築物のうち土木建造物の動的解析に当たっては、構造物と地盤の相互作用を考慮できる連成系の地震応答解析手法を用いる。地震応答解析手法は、地盤及び構造物の地震時における非線形挙動の有無や程度に応じて、線形、等価線形又は非線形解析のいずれかによる。地盤の地震応答解析モデルは、構造物と地盤の動的相互作用を考慮できる有限要素法を用いる。構造物の地震応答解析に用いる減衰定数については、地盤と構造物の非線形性を考慮して適切に設定する。</p> <p>地震力については、水平 2 方向及び鉛直方向について適切に組み合わせて算定する。</p> <p>(重大事故等対処施設に係る基本設計方針については、重大事故等対処施設の詳細設計の対象となる申請書で示す。)</p>

基本設計方針の第 1 回申請範囲 (11/26)

全体	第 1 回申請範囲
<p>ロ. 機器・配管系</p> <p>動的解析による地震力の算定に当たっては、地震応答解析手法の適用性、適用限界等を考慮のうえ、適切な解析法を選定するとともに、解析条件として考慮すべき減衰定数、剛性等の各種物性値は、適切な規格及び基準又は試験等の結果に基づき設定する。</p> <p>機器については、形状、構造特性等を考慮して、代表的な振動モードを適切に表現できるよう質点系モデル、有限要素モデル等に置換し、設計用床応答曲線を用いたスペクトルモーダル解析法又は時刻歴応答解析法により応答を求める。</p> <p>また、時刻歴応答解析法及びスペクトルモーダル解析法を用いる場合は地盤物性等のばらつきを適切に考慮する。スペクトルモーダル解析法には地盤物性等のばらつきを考慮した床応答曲線を用いる。</p> <p>配管系については、適切なモデルを作成し、設計用床応答曲線を用いたスペクトルモーダル解析法により応答を求める。</p> <p>スペクトルモーダル解析法及び時刻歴応答解析法の選択に当たっては、衝突・すべり等の非線形現象を模擬する観点又は既往研究の知見を取り入れ実機の挙動を模擬する観点で、建物・構築物の剛性及び地盤物性のばらつきへの配慮をしつつ時刻歴応答解析法を用いる等、解析対象とする現象、対象設備の振動特性・構造特性等を考慮し適切に選定する。</p> <p>また、設備の 3 次元的な広がりを踏まえ、適切に応答を評価できるモデルを用い、水平 2 方向及び鉛直方向の応答成分について適切に組み合わせるものとする。</p> <p>なお、剛性の高い機器・配管系は、その設置床面の最大床応答加速度の 1.2 倍の加速度を静的に作用させて地震力を算定する。</p> <p>c. 設計用減衰定数</p> <p>地震応答解析に用いる減衰定数は、安全上適切と認められる規格及び基準に基づき、設備の種類、構造等により適切に選定するとともに、試験等で妥当性を確認した値も用いる。</p> <p>なお、建物・構築物の地震応答解析に用いる鉄筋コンクリートの減衰定数の設定については、既往の知見に加え、既設施設の地震観測記録等により、その妥当性を検討する。</p> <p>また、地盤と土木建造物の連成系地震応答解析モデルの減衰定数については、地中建造物としての特徴、同モデルの振動特性を考慮して適切に設定する。</p>	<p>ロ. 機器・配管系</p> <p>動的解析による地震力の算定に当たっては、地震応答解析手法の適用性、適用限界等を考慮のうえ、適切な解析法を選定するとともに、解析条件として考慮すべき減衰定数、剛性等の各種物性値は、適切な規格及び基準又は試験等の結果に基づき設定する。</p> <p>機器については、形状、構造特性等を考慮して、代表的な振動モードを適切に表現できるよう質点系モデル、有限要素モデル等に置換し、設計用床応答曲線を用いたスペクトルモーダル解析法又は時刻歴応答解析法により応答を求める。</p> <p>また、時刻歴応答解析法及びスペクトルモーダル解析法を用いる場合は地盤物性等のばらつきを適切に考慮する。スペクトルモーダル解析法には地盤物性等のばらつきを考慮した床応答曲線を用いる。</p> <p>配管系については、適切なモデルを作成し、設計用床応答曲線を用いたスペクトルモーダル解析法により応答を求める。</p> <p>スペクトルモーダル解析法及び時刻歴応答解析法の選択に当たっては、衝突・すべり等の非線形現象を模擬する観点又は既往研究の知見を取り入れ実機の挙動を模擬する観点で、建物・構築物の剛性及び地盤物性のばらつきへの配慮をしつつ時刻歴応答解析法を用いる等、解析対象とする現象、対象設備の振動特性・構造特性等を考慮し適切に選定する。</p> <p>また、設備の 3 次元的な広がりを踏まえ、適切に応答を評価できるモデルを用い、水平 2 方向及び鉛直方向の応答成分について適切に組み合わせるものとする。</p> <p>なお、剛性の高い機器・配管系は、その設置床面の最大床応答加速度の 1.2 倍の加速度を静的に作用させて地震力を算定する。</p> <p>c. 設計用減衰定数</p> <p>地震応答解析に用いる減衰定数は、安全上適切と認められる規格及び基準に基づき、設備の種類、構造等により適切に選定するとともに、試験等で妥当性を確認した値も用いる。</p> <p>なお、建物・構築物の地震応答解析に用いる鉄筋コンクリートの減衰定数の設定については、既往の知見に加え、既設施設の地震観測記録等により、その妥当性を検討する。</p> <p>また、地盤と土木建造物の連成系地震応答解析モデルの減衰定数については、地中建造物としての特徴、同モデルの振動特性を考慮して適切に設定する。</p>

基本設計方針の第1回申請範囲(12/26)

全体	第1回申請範囲
<p>(4) 荷重の組合せと許容限界 耐震設計における荷重の組合せと許容限界は、以下によるものとする。 また、耐震設計においては、安全機能及び重大事故等に対処するために必要な機能である閉じ込め機能、プロセス量等の維持機能、掃気機能、崩壊熱等の除去機能、臨界防止機能、遮蔽機能、落下・転倒防止機能、支援機能、ソースターム制限機能、放出量の監視機能、換気機能、気密性、支持機能、操作場所及びアクセスルートの保持機能等を維持する設計とする。 上記の機能のうち、遮蔽機能、落下・転倒防止機能、気密性、支持機能、操作場所及びアクセスルートの保持機能等については、安全機能を有する施設の耐震重要度及び重大事故等対処施設の設備分類に応じた地震力に対して、当該機能が要求される施設の構造強度を確保することで、機能が維持できる設計とする。 閉じ込め機能、プロセス量等の維持機能、掃気機能、崩壊熱等の除去機能、臨界防止機能、支援機能、ソースターム制限機能、放出量の監視機能、換気機能等については、構造強度を確保するとともに、当該機能が要求される各施設の特性に応じて許容限界を適切に設定する。</p> <p>a. 耐震設計上考慮する状態 地震以外に設計上考慮する状態を以下に示す。</p> <p>(a) 安全機能を有する施設</p> <p>イ. 建物・構築物</p> <p>(イ) 運転時の状態 再処理施設が運転している状態。</p> <p>(ロ) 設計用自然条件 設計上基本的に考慮しなければならない自然条件(積雪、風)。</p> <p>ロ. 機器・配管系</p> <p>(イ) 運転時の状態 再処理施設が運転している状態。</p> <p>(ロ) 運転時の異常な過渡変化時の状態 運転時に予想される機械又は器具の単一の故障若しくはその誤作動又は運転員の単一の誤操作及びこれらと類似の頻度で発生すると予想される外乱によって発生する異常な状態であって、当該状態が継続した場合には温度、圧力、流量その他の再処理施設の状態を示す事項が安全設計上許容される範囲を超えるおそれがあるものとして安全設計上想定すべき事象が発生した状態。</p>	<p>(4) 荷重の組合せと許容限界 耐震設計における荷重の組合せと許容限界は、以下によるものとする。 また、耐震設計においては、安全機能である閉じ込め機能、プロセス量等の維持機能、掃気機能、崩壊熱等の除去機能、臨界防止機能、遮蔽機能、落下・転倒防止機能、支援機能、ソースターム制限機能、放出量の監視機能、換気機能、支持機能等を維持する設計とする。 上記の機能のうち、遮蔽機能、落下・転倒防止機能、支持機能等については、安全機能を有する施設の耐震重要度に応じた地震力に対して、当該機能が要求される施設の構造強度を確保することで、機能が維持できる設計とする。 閉じ込め機能、プロセス量等の維持機能、掃気機能、崩壊熱等の除去機能、臨界防止機能、支援機能、ソースターム制限機能、放出量の監視機能、換気機能等については、構造強度を確保するとともに、当該機能が要求される各施設の特性に応じて許容限界を適切に設定する。 (重大事故等対処施設に係る基本設計方針については、重大事故等対処施設の詳細設計の対象となる申請書で示す。)</p> <p>a. 耐震設計上考慮する状態 地震以外に設計上考慮する状態を以下に示す。</p> <p>(a) 安全機能を有する施設</p> <p>イ. 建物・構築物</p> <p>(イ) 運転時の状態 再処理施設が運転している状態。</p> <p>(ロ) 設計用自然条件 設計上基本的に考慮しなければならない自然条件(積雪、風)。</p> <p>ロ. 機器・配管系</p> <p>(イ) 運転時の状態 再処理施設が運転している状態。</p> <p>(ロ) 運転時の異常な過渡変化時の状態 運転時に予想される機械又は器具の単一の故障若しくはその誤作動又は運転員の単一の誤操作及びこれらと類似の頻度で発生すると予想される外乱によって発生する異常な状態であって、当該状態が継続した場合には温度、圧力、流量その他の再処理施設の状態を示す事項が安全設計上許容される範囲を超えるおそれがあるものとして安全設計上想定すべき事象が発生した状態。</p>

基本設計方針の第 1 回申請範囲 (13/26)

全体	第 1 回申請範囲
<p>(ハ) 設計基準事故時の状態 発生頻度が運転時の異常な過渡変化より低い異常な状態であって、当該状態が発生した場合には再処理施設から多量の放射性物質が放出するおそれがあるものとして安全設計上想定すべき事象が発生した状態。</p> <p>(b) 重大事故等対処施設 イ. 建物・構築物 (イ) 運転時の状態 再処理施設が運転している状態。</p> <p>(ロ) 重大事故等時の状態 再処理施設が、重大事故に至るおそれがある事故又は重大事故の状態、重大事故等対処施設の機能を必要とする状態。</p> <p>(ハ) 設計用自然条件 設計上基本的に考慮しなければならない自然条件 (積雪, 風)。</p> <p>ロ. 機器・配管系 (イ) 運転時の状態 再処理施設が運転している状態。</p> <p>(ロ) 運転時の異常な過渡変化時の状態 運転時に予想される機械又は器具の単一の故障若しくはその誤作動又は運転員の単一の誤操作及びこれらと類似の頻度で発生すると予想される外乱によって発生する異常な状態であって、当該状態が継続した場合には温度, 圧力, 流量その他の再処理施設の状態を示す事項が安全設計上許容される範囲を超えるおそれがあるものとして安全設計上想定すべき事象が発生した状態。</p> <p>(ハ) 設計基準事故時の状態 発生頻度が運転時の異常な過渡変化より低い異常な状態であって、当該状態が発生した場合には再処理施設から多量の放射性物質が放出するおそれがあるものとして安全設計上想定すべき事象が発生した状態。</p> <p>(ニ) 重大事故等時の状態 再処理施設が、重大事故に至るおそれがある事故又は重大事故の状態、重大事故等対処施設の機能を必要とする状態。</p>	<p>(ハ) 設計基準事故時の状態 発生頻度が運転時の異常な過渡変化より低い異常な状態であって、当該状態が発生した場合には再処理施設から多量の放射性物質が放出するおそれがあるものとして安全設計上想定すべき事象が発生した状態。</p> <p>(b) 重大事故等対処施設 (重大事故等対処施設に係る基本設計方針については、重大事故等対処施設の詳細設計の対象となる申請書で示す。)</p>

基本設計方針の第1回申請範囲(14/26)

全体	第1回申請範囲
<p>b. 荷重の種類</p> <p>(a) 安全機能を有する施設</p> <p>イ. 建物・構築物</p> <p>(イ) 再処理施設のおかれている状態にかかわらず常時作用している荷重, すなわち固定荷重, 積載荷重, 土圧及び水圧</p> <p>(ロ) 運転時の状態で施設に作用する荷重</p> <p>(ハ) 地震力, 積雪荷重及び風荷重</p> <p>ただし, 運転時の状態で施設に作用する荷重には, 機器・配管系から作用する荷重が含まれるものとし, 地震力には, 地震時土圧, 地震時水圧及び機器・配管系からの反力が含まれるものとする。</p> <p>ロ. 機器・配管系</p> <p>(イ) 運転時の状態で施設に作用する荷重</p> <p>(ロ) 運転時の異常な過渡変化時の状態で施設に作用する荷重</p> <p>(ハ) 設計基準事故時の状態で施設に作用する荷重</p> <p>(ニ) 地震力</p> <p>ただし, 各状態において施設に作用する荷重には, 常時作用している荷重, すなわち自重等の固定荷重が含まれるものとする。また, 屋外に設置される施設については, 建物・構築物に準じる。</p>	<p>b. 荷重の種類</p> <p>(a) 安全機能を有する施設</p> <p>イ. 建物・構築物</p> <p>(イ) 再処理施設のおかれている状態にかかわらず常時作用している荷重, すなわち固定荷重, 積載荷重, 土圧及び水圧</p> <p>(ロ) 運転時の状態で施設に作用する荷重</p> <p>(ハ) 地震力, 積雪荷重及び風荷重</p> <p>ただし, 運転時の状態で施設に作用する荷重には, 機器・配管系から作用する荷重が含まれるものとし, 地震力には, 地震時土圧, 地震時水圧及び機器・配管系からの反力が含まれるものとする。</p> <p>ロ. 機器・配管系</p> <p>(イ) 運転時の状態で施設に作用する荷重</p> <p>(ロ) 運転時の異常な過渡変化時の状態で施設に作用する荷重</p> <p>(ハ) 設計基準事故時の状態で施設に作用する荷重</p> <p>(ニ) 地震力</p> <p>ただし, 各状態において施設に作用する荷重には, 常時作用している荷重, すなわち自重等の固定荷重が含まれるものとする。また, 屋外に設置される施設については, 建物・構築物に準じる。</p>

基本設計方針の第1回申請範囲 (15/26)

全体	第1回申請範囲
<p>(b) 重大事故等対処施設</p> <p>イ. 建物・構築物</p> <p>(イ) 再処理施設のおかれている状態にかかわらず常時作用している荷重, すなわち固定荷重, 積載荷重, 土圧及び水圧</p> <p>(ロ) 運転時の状態で施設に作用する荷重</p> <p>(ハ) 重大事故等時の状態で施設に作用する荷重</p> <p>(ニ) 地震力, 積雪荷重及び風荷重</p> <p>ただし, 運転時及び重大事故等時の状態で施設に作用する荷重には, 機器・配管系から作用する荷重が含まれるものとし, 地震力には, 地震時土圧, 地震時水圧及び機器・配管系からの反力が含まれるものとする。</p> <p>ロ. 機器・配管系</p> <p>(イ) 運転時の状態で施設に作用する荷重</p> <p>(ロ) 運転時の異常な過渡変化時の状態で施設に作用する荷重</p> <p>(ハ) 設計基準事故時の状態で施設に作用する荷重</p> <p>(ニ) 重大事故等時の状態で施設に作用する荷重</p> <p>(ホ) 地震力</p> <p>ただし, 各状態において施設に作用する荷重には, 常時作用している荷重, すなわち自重等の固定荷重が含まれるものとする。また, 屋外に設置される施設については, 建物・構築物に準じる。</p>	<p>(b) 重大事故等対処施設</p> <p>(重大事故等対処施設に係る基本設計方針については, 重大事故等対処施設の詳細設計の対象となる申請書で示す。)</p>

基本設計方針の第1回申請範囲(16/26)

全体	第1回申請範囲
<p>c. 荷重の組合せ</p> <p>地震力と他の荷重との組合せについては、「3.3 外部からの衝撃による損傷の防止」で設定している風及び積雪による荷重を考慮し、以下のとおり設定する。</p> <p>(a) 安全機能を有する施設</p> <p>イ. 建物・構築物</p> <p>(イ) Sクラスの建物・構築物については、常時作用している荷重(固定荷重、積載荷重、土圧及び水圧)、運転時の状態で施設に作用する荷重、積雪荷重及び風荷重と基準地震動S_sによる地震力とを組み合わせる。</p> <p>(ロ) Sクラス、Bクラス及びCクラスの建物・構築物については、常時作用している荷重(固定荷重、積載荷重、土圧及び水圧)、運転時の状態で施設に作用する荷重、積雪荷重及び風荷重と基準地震動S_s以外の地震動による地震力又は静的地震力とを組み合わせる。</p> <p>この際、常時作用している荷重のうち、土圧及び水圧について、基準地震動S_sによる地震力又は弾性設計用地震動S_dによる地震力と組み合わせる場合は、当該地震時の土圧及び水圧とする。</p> <p>ロ. 機器・配管系</p> <p>(イ) Sクラスの機器・配管系については、常時作用している荷重、運転時の状態で施設に作用する荷重、運転時の異常な過渡変化時に生じる荷重、設計基準事故時に生じる荷重と基準地震動S_sによる地震力、弾性設計用地震動S_dによる地震力又は静的地震力とを組み合わせる。</p> <p>(ロ) Bクラスの機器・配管系については、常時作用している荷重、運転時の状態で施設に作用する荷重、運転時の異常な過渡変化時に生じる荷重と共振影響検討用の地震動による地震力又は静的地震力とを組み合わせる。</p> <p>(ハ) Cクラスの機器・配管系については、常時作用している荷重、運転時の状態で施設に作用する荷重、運転時の異常な過渡変化時に生じる荷重と静的地震力とを組み合わせる。</p> <p>なお、屋外に設置される施設については、建物・構築物と同様に積雪荷重及び風荷重を組み合わせる。</p>	<p>c. 荷重の組合せ</p> <p>地震力と他の荷重との組合せについては、「3.3 外部からの衝撃による損傷の防止」で設定している風及び積雪による荷重を考慮し、以下のとおり設定する。</p> <p>(a) 安全機能を有する施設</p> <p>イ. 建物・構築物</p> <p>(イ) Sクラスの建物・構築物については、常時作用している荷重(固定荷重、積載荷重、土圧及び水圧)、運転時の状態で施設に作用する荷重、積雪荷重及び風荷重と基準地震動S_sによる地震力とを組み合わせる。</p> <p>(ロ) Sクラス、Bクラス及びCクラスの建物・構築物については、常時作用している荷重(固定荷重、積載荷重、土圧及び水圧)、運転時の状態で施設に作用する荷重、積雪荷重及び風荷重と基準地震動S_s以外の地震動による地震力又は静的地震力とを組み合わせる。</p> <p>この際、常時作用している荷重のうち、土圧及び水圧について、基準地震動S_sによる地震力又は弾性設計用地震動S_dによる地震力と組み合わせる場合は、当該地震時の土圧及び水圧とする。</p> <p>ロ. 機器・配管系</p> <p>(イ) Sクラスの機器・配管系については、常時作用している荷重、運転時の状態で施設に作用する荷重、運転時の異常な過渡変化時に生じる荷重、設計基準事故時に生じる荷重と基準地震動S_sによる地震力、弾性設計用地震動S_dによる地震力又は静的地震力とを組み合わせる。</p> <p>(ロ) Bクラスの機器・配管系については、常時作用している荷重、運転時の状態で施設に作用する荷重、運転時の異常な過渡変化時に生じる荷重と共振影響検討用の地震動による地震力又は静的地震力とを組み合わせる。</p> <p>(ハ) Cクラスの機器・配管系については、常時作用している荷重、運転時の状態で施設に作用する荷重、運転時の異常な過渡変化時に生じる荷重と静的地震力とを組み合わせる。</p> <p>なお、屋外に設置される施設については、建物・構築物と同様に積雪荷重及び風荷重を組み合わせる。</p>

基本設計方針の第1回申請範囲 (17/26)

全体	第1回申請範囲
<p>(b) 重大事故等対処施設</p> <p>イ. 建物・構築物</p> <p>(イ) 常設耐震重要重大事故等対処設備が設置される重大事故等対処施設の建物・構築物については、常時作用している荷重（固定荷重，積載荷重，土圧及び水圧），積雪荷重，風荷重及び運転時の状態で施設に作用する荷重と基準地震動S_sによる地震力とを組み合わせる。</p> <p>(ロ) 常設耐震重要重大事故等対処設備が設置される重大事故等対処施設の建物・構築物については、常時作用している荷重（固定荷重，積載荷重，土圧及び水圧），積雪荷重，風荷重及び重大事故等時の状態で施設に作用する荷重のうち，地震によって引き起こされるおそれがある事象によって作用する荷重と基準地震動S_sによる地震力とを組み合わせる。</p> <p>(ハ) 常設耐震重要重大事故等対処設備が設置される重大事故等対処施設の建物・構築物については、常時作用している荷重（固定荷重，積載荷重，土圧及び水圧），積雪荷重，風荷重及び重大事故等時の状態で施設に作用する荷重のうち，地震によって引き起こされるおそれがない事象による荷重は，その事故事象の発生確率，継続時間及び地震動の年超過確率の関係を踏まえ，適切な地震力（基準地震動S_s又は弾性設計用地震動S_dによる地震力）と組み合わせる。この組合せについては，事故事象の発生確率，継続時間及び地震動の年超過確率の積等を考慮し，工学的，総合的に勘案の上設定する。なお，継続時間については対策の成立性も考慮した上で設定する。</p> <p>(ニ) 常設耐震重要重大事故等対処設備以外の常設重大事故等対処設備が設置される重大事故等対処施設の建物・構築物については，常時作用している荷重（固定荷重，積載荷重，土圧及び水圧），運転時の状態で施設に作用する荷重，積雪荷重及び風荷重と，弾性設計用地震動S_dによる地震力又は静的地震力とを組み合わせる。</p> <p>この際，常時作用している荷重のうち，土圧及び水圧について，基準地震動S_sによる地震力又は弾性設計用地震動S_dによる地震力と組み合わせる場合は，当該地震時の土圧及び水圧とする。</p>	<p>(b) 重大事故等対処施設</p> <p>（重大事故等対処施設に係る基本設計方針については，重大事故等対処施設の詳細設計の対象となる申請書で示す。）</p>

基本設計方針の第 1 回申請範囲 (18/26)

全体	第 1 回申請範囲
<p>ロ. 機器・配管系</p> <p>(イ) 常設耐震重要重大事故等対処設備が設置される重大事故等対処施設の機器・配管系については、常時作用している荷重及び運転時の状態で施設に作用する荷重と基準地震動 S_s による地震力とを組み合わせる。</p> <p>(ロ) 常設耐震重要重大事故等対処設備が設置される重大事故等対処施設の機器・配管系については、常時作用している荷重、運転時の異常な過渡変化時の状態、設計基準事故時の状態及び重大事故等時の状態で施設に作用する荷重のうち、地震によって引き起こされるおそれがある事象によって作用する荷重と基準地震動 S_s による地震力とを組み合わせる。</p> <p>(ハ) 常設耐震重要重大事故等対処設備が設置される重大事故等対処施設の機器・配管系については、常時作用している荷重、運転時の異常な過渡変化時の状態、設計基準事故時の状態及び重大事故等時の状態で施設に作用する荷重のうち、地震によって引き起こされるおそれがない事象による荷重は、基準地震動 S_s 又は弾性設計用地震動 S_d による地震力と組み合わせる。</p> <p>(ニ) 常設耐震重要重大事故等対処設備以外の常設重大事故等対処設備が設置される重大事故等対処施設の機器・配管系については、常時作用している荷重、運転時の状態で施設に作用する荷重及び運転時の異常な過渡変化時の状態と弾性設計用地震動 S_d による地震力又は静的地震力とを組み合わせる。</p> <p>なお、屋外に設置される施設については、建物・構築物と同様に積雪荷重及び風荷重を組み合わせる。</p>	

基本設計方針の第 1 回申請範囲 (19/26)

全体	第 1 回申請範囲
<p>(c) 荷重の組合せ上の留意事項</p> <p>イ. 安全機能を有する施設のうち耐震重要度の異なる施設を支持する建物・構築物の当該部分の支持機能を確認する場合においては、支持される施設の耐震重要度に応じた地震力と常時作用している荷重、運転時に施設に作用する荷重とを組み合わせる。</p> <p>ロ. 安全機能を有する施設のうち機器・配管系の運転時の異常な過渡変化時及び設計基準事故(以下「事故等」という。)時に生じるそれぞれの荷重については、地震によって引き起こされるおそれのある事故等によって作用する荷重及び地震によって引き起こされるおそれのない事故等であっても、いったん事故等が発生した場合、長時間継続する事故等による荷重は、その事故等の発生確率、継続時間及び地震動の超過確率の関係を踏まえ、適切な地震力と組み合わせで考慮する。</p> <p>ハ. 安全機能を有する施設及び重大事故等対処施設に適用する動的地震力は、水平 2 方向及び鉛直方向について適切に組み合わせで算定するものとする。</p> <p>ニ. 積雪荷重については、屋外に設置されている安全機能を有する施設及び重大事故等対処施設のうち、積雪による受圧面積が小さい施設や、常時作用している荷重に対して積雪荷重の割合が無視できる施設を除き、地震力との組合せを考慮する。</p> <p>ホ. 風荷重については、屋外の直接風を受ける場所に設置されている安全機能を有する施設及び重大事故等対処施設のうち、風荷重の影響が地震荷重と比べて相対的に無視できないような構造、形状及び仕様の施設においては、地震力との組合せを考慮する。</p> <p>ヘ. 荷重として考慮する水圧のうち地下水圧については、地下水排水設備による地下水位の低下を踏まえた設計用地下水位に基づき設定する。</p> <p>ト. 設備分類の異なる重大事故等対処施設を支持する建物・構築物の当該部分の支持機能を確認する場合においては、支持される施設の設備分類に応じた地震力と常時作用している荷重(固定荷重、積載荷重、土圧及び水圧)、運転時の状態で施設に作用する荷重及び重大事故等時の状態で施設に作用する荷重並びに積雪荷重及び風荷重を組み合わせる。</p> <p>チ. 常設耐震重要重大事故等対処設備が設置される重大事故等対処施設の機器・配管系の、常時作用している荷重、運転時の異常な過渡変化時の状態、設計基準事故時の状態及び重大事故等時の状態で施設に作用する荷重のうち、地震によって引き起こされるおそれがない事象による荷重と、基準地震動 S_s 又は弾性設計用地震動 S_d による地震力との組合せについては、事故事象の発生確率、継続時間及び地震動の年超過確率の積等を考慮し、工学的、総合的に勘案の上設定する。なお、継続時間については対策の成立性も考慮した上で設定する。</p> <p>リ. 常設耐震重要重大事故等対処設備以外の常設重大事故等対処設備で、代替する安全機能を有する施設がない常設重大事故等対処設備のうち、Sクラスの施設は常設耐震重要重大事故等対処設備に係る機器・配管系の荷重の組合せを適用する。</p>	<p>(c) 荷重の組合せ上の留意事項</p> <p>イ. 安全機能を有する施設のうち耐震重要度の異なる施設を支持する建物・構築物の当該部分の支持機能を確認する場合においては、支持される施設の耐震重要度に応じた地震力と常時作用している荷重、運転時に施設に作用する荷重とを組み合わせる。</p> <p>ロ. 安全機能を有する施設のうち機器・配管系の運転時の異常な過渡変化時及び設計基準事故(以下「事故等」という。)時に生じるそれぞれの荷重については、地震によって引き起こされるおそれのある事故等によって作用する荷重及び地震によって引き起こされるおそれのない事故等であっても、いったん事故等が発生した場合、長時間継続する事故等による荷重は、その事故等の発生確率、継続時間及び地震動の超過確率の関係を踏まえ、適切な地震力と組み合わせで考慮する。</p> <p>ハ. 安全機能を有する施設に適用する動的地震力は、水平 2 方向及び鉛直方向について適切に組み合わせで算定するものとする。</p> <p>ニ. 積雪荷重については、屋外に設置されている安全機能を有する施設のうち、積雪による受圧面積が小さい施設や、常時作用している荷重に対して積雪荷重の割合が無視できる施設を除き、地震力との組合せを考慮する。</p> <p>ホ. 風荷重については、屋外の直接風を受ける場所に設置されている安全機能を有する施設のうち、風荷重の影響が地震荷重と比べて相対的に無視できないような構造、形状及び仕様の施設においては、地震力との組合せを考慮する。</p> <p>ヘ. 荷重として考慮する水圧のうち地下水圧については、地下水排水設備による地下水位の低下を踏まえた設計用地下水位に基づき設定する。</p> <p>(重大事故等対処施設に係る基本設計方針については、重大事故等対処施設の詳細設計の対象となる申請書で示す。)</p>

基本設計方針の第1回申請範囲 (20/26)

全体	第1回申請範囲
<p>d. 許容限界 各施設の地震力と他の荷重とを組み合わせた状態に対する許容限界は、以下のとおりとし、安全上適切と認められる規格及び基準又は試験等で妥当性が確認されている値を用いる。</p> <p>(a) 安全機能を有する施設 イ. 建物・構築物 (イ) Sクラスの建物・構築物（土木構造物を除く。） i. 基準地震動S_sによる地震力との組合せに対する許容限界 建物・構築物全体としての変形能力（耐震壁のせん断ひずみ等）が終局耐力時の変形に対して十分な余裕を有し、部材・部位ごとのせん断ひずみ・応力等が終局耐力時のせん断ひずみ・応力等に対して、妥当な安全余裕を有することとする。</p> <p>なお、終局耐力とは、建物・構築物に対する荷重又は応力を漸次増大していくとき、その変形又はひずみが著しく増加するに至る限界の最大耐力とし、既往の実験式等に基づき適切に定めるものとする。</p> <p>ii. 弾性設計用地震動S_dによる地震力又は静的地震力との組合せに対する許容限界 Sクラスの建物・構築物については、地震力に対しておおむね弾性状態に留まるように、発生する応力に対して、建築基準法等の安全上適切と認められる規格及び基準による許容応力度を許容限界とする。</p> <p>(ロ) Bクラス及びCクラスの建物・構築物（土木構造物を除く。） 上記(イ) ii.による許容応力度を許容限界とする。</p> <p>(ハ) 建物・構築物の保有水平耐力 建物・構築物（土木構造物を除く。）については、当該建物・構築物の保有水平耐力が必要保有水平耐力に対して、耐震重要度に応じた適切な安全余裕を有していることを確認する。</p>	<p>d. 許容限界 各施設の地震力と他の荷重とを組み合わせた状態に対する許容限界は、以下のとおりとし、安全上適切と認められる規格及び基準又は試験等で妥当性が確認されている値を用いる。</p> <p>(a) 安全機能を有する施設 イ. 建物・構築物 (イ) Sクラスの建物・構築物（土木構造物を除く。） i. 基準地震動S_sによる地震力との組合せに対する許容限界 建物・構築物全体としての変形能力（耐震壁のせん断ひずみ等）が終局耐力時の変形に対して十分な余裕を有し、部材・部位ごとのせん断ひずみ・応力等が終局耐力時のせん断ひずみ・応力等に対して、妥当な安全余裕を有することとする。</p> <p>なお、終局耐力とは、建物・構築物に対する荷重又は応力を漸次増大していくとき、その変形又はひずみが著しく増加するに至る限界の最大耐力とし、既往の実験式等に基づき適切に定めるものとする。</p> <p>ii. 弾性設計用地震動S_dによる地震力又は静的地震力との組合せに対する許容限界 Sクラスの建物・構築物については、地震力に対しておおむね弾性状態に留まるように、発生する応力に対して、建築基準法等の安全上適切と認められる規格及び基準による許容応力度を許容限界とする。</p> <p>(ロ) Bクラス及びCクラスの建物・構築物（土木構造物を除く。） 上記(イ) ii.による許容応力度を許容限界とする。</p> <p>(ハ) 建物・構築物の保有水平耐力 建物・構築物（土木構造物を除く。）については、当該建物・構築物の保有水平耐力が必要保有水平耐力に対して、耐震重要度に応じた適切な安全余裕を有していることを確認する。</p>

基本設計方針の第 1 回申請範囲 (21/26)

全体	第 1 回申請範囲
<p>(二) 屋外重要土木構造物</p> <p>i. 基準地震動 S_s による地震力との組合せに対する許容限界 構造部材の曲げについては限界層間変形角(層間変形角 1/100)又は終局曲率, せん断についてはせん断耐力を許容限界とする。 なお, 限界層間変形角, 終局曲率及びせん断耐力の許容限界に対しては妥当な安全余裕を持たせることとする。</p> <p>ii. 弾性設計用地震動 S_d による地震力又は静的地震力との組合せに対する許容限界 地震力に対しておおむね弾性状態に留まるように, 発生する応力に対して, 安全上適切と認められる規格及び基準による許容応力度を許容限界とする。</p> <p>(ホ) その他の土木構造物 安全上適切と認められる規格及び基準による許容応力度を許容限界とする。</p> <p>ロ. 機器・配管系</p> <p>(イ) Sクラスの機器・配管系</p> <p>i. 基準地震動 S_s による地震力との組合せに対する許容限界 塑性域に達するひずみが生じる場合であっても, その量が小さなレベルに留まって破断延性限界に十分な余裕を有し, その施設の機能に影響を及ぼすことがない限度に応力, 荷重を制限する値を許容限界とする。</p> <p>ii. 弾性設計用地震動 S_d による地震力又は静的地震力との組合せに対する許容限界 発生する応力に対して, 応答が全体的におおむね弾性状態に留まるように, 降伏応力又はこれと同等の安全性を有する応力を許容限界とする。</p> <p>(ロ) Bクラス及びCクラスの機器・配管系 上記(イ) ii. による応力を許容限界とする。</p>	<p>(二) 屋外重要土木構造物</p> <p>i. 基準地震動 S_s による地震力との組合せに対する許容限界 構造部材の曲げについては限界層間変形角(層間変形角 1/100)又は終局曲率, せん断についてはせん断耐力を許容限界とする。 なお, 限界層間変形角, 終局曲率及びせん断耐力の許容限界に対しては妥当な安全余裕を持たせることとする。</p> <p>ii. 弾性設計用地震動 S_d による地震力又は静的地震力との組合せに対する許容限界 地震力に対しておおむね弾性状態に留まるように, 発生する応力に対して, 安全上適切と認められる規格及び基準による許容応力度を許容限界とする。</p> <p>(ホ) その他の土木構造物 安全上適切と認められる規格及び基準による許容応力度を許容限界とする。</p> <p>ロ. 機器・配管系</p> <p>(イ) Sクラスの機器・配管系</p> <p>i. 基準地震動 S_s による地震力との組合せに対する許容限界 塑性域に達するひずみが生じる場合であっても, その量が小さなレベルに留まって破断延性限界に十分な余裕を有し, その施設の機能に影響を及ぼすことがない限度に応力, 荷重を制限する値を許容限界とする。</p> <p>ii. 弾性設計用地震動 S_d による地震力又は静的地震力との組合せに対する許容限界 発生する応力に対して, 応答が全体的におおむね弾性状態に留まるように, 降伏応力又はこれと同等の安全性を有する応力を許容限界とする。</p> <p>(ロ) Bクラス及びCクラスの機器・配管系 上記(イ) ii. による応力を許容限界とする。</p>

基本設計方針の第1回申請範囲(22/26)

全体	第1回申請範囲
<p>(b) 重大事故等対処施設</p> <p>イ. 建物・構築物</p> <p>(イ) 常設耐震重要重大事故等対処設備が設置される重大事故等対処施設の建物・構築物 上記(a)イ.(イ) i.を適用する。</p> <p>(ロ) 常設耐震重要重大事故等対処設備以外の常設重大事故等対処設備が設置される重大事故等対処施設の建物・構築物 上記(a)イ.(ロ)を適用する。</p> <p>(ハ) 設備分類の異なる重大事故等対処施設を支持する建物・構築物(土木構造物を除く。) 上記(イ)を適用するほか、建物・構築物は、変形等に対してその支持機能が損なわれない設計とする。なお、当該施設を支持する建物・構築物の支持機能が損なわれないことを確認する際の地震力は、支持される施設に適用される地震力とする。</p> <p>(ニ) 建物・構築物の保有水平耐力 建物・構築物(土木構造物を除く。)については、当該建物・構築物の保有水平耐力が必要保有水平耐力に対して、重大事故等対処施設が代替する機能を有する安全機能を有する施設が属する耐震重要度に応じた適切な安全余裕を有していることを確認する。</p> <p>(ホ) 設備分類の異なる重大事故等対処施設を支持する土木構造物 上記(a)イ.(ニ) i.又は(a)イ.(ニ) ii.を適用するほか、土木構造物は、変形に対してその支持機能が損なわれない設計とする。なお、当該施設を支持する土木構造物の支持機能が損なわれないことを確認する際の地震力は、支持される施設に適用される地震力とする。</p>	<p>(b) 重大事故等対処施設 (重大事故等対処施設に係る基本設計方針については、重大事故等対処施設の詳細設計の対象となる申請書で示す。)</p>

基本設計方針の第 1 回申請範囲 (23/26)

全体	第 1 回申請範囲
<p>ロ. 機器・配管系</p> <p>(イ) 常設耐震重要重大事故等対処設備が設置される重大事故等対処施設の機器・配管系 上記(a)ロ.(イ) i. を適用する。</p> <p>(ロ) 常設耐震重要重大事故等対処設備以外の常設重大事故等対処設備が設置される重大事故等 対処施設の機器・配管系</p> <p>i. 上記(a)ロ.(ロ)を適用する。</p> <p>ii. 代替する安全機能を有する施設がない常設重大事故等対処設備のうち S クラスの施設は、 上記(イ)を適用する。</p> <p>(5) 設計における留意事項</p> <p>a. 主要設備等, 補助設備, 直接支持構造物及び間接支持構造物</p> <p>主要設備等, 補助設備及び直接支持構造物については, 耐震重要度に応じた地震力に十分耐えら れる設計とするとともに, 安全機能を有する施設のうち, 耐震重要施設に該当する設備は, 基準地 震動 S_s による地震力に対してその安全機能が損なわれるおそれがない設計とする。</p> <p>また, 間接支持構造物については, 支持する主要設備等又は補助設備の耐震重要度に適用する地 震動による地震力に対して支持機能が損なわれない設計とする。</p>	<p>(5) 設計における留意事項</p> <p>a. 主要設備等, 補助設備, 直接支持構造物及び間接支持構造物</p> <p>主要設備等, 補助設備及び直接支持構造物については, 耐震重要度に応じた地震力に十分耐えら れる設計とするとともに, 安全機能を有する施設のうち, 耐震重要施設に該当する設備は, 基準地 震動 S_s による地震力に対してその安全機能が損なわれるおそれがない設計とする。</p> <p>また, 間接支持構造物については, 支持する主要設備等又は補助設備の耐震重要度に適用する地 震動による地震力に対して支持機能が損なわれない設計とする。</p>

基本設計方針の第1回申請範囲(24/26)

全体	第1回申請範囲
<p>b. 波及的影響に対する考慮</p> <p>耐震重要施設は、耐震重要度の下位のクラスに属する施設の波及的影響によって、その安全機能が損なわれないものとする。</p> <p>評価に当たっては、以下の4つの観点をもとに、敷地全体を俯瞰した調査・検討を行い、各観点より選定した事象に対する波及的影響の評価により波及的影響を考慮すべき施設を抽出し、耐震重要施設の安全機能への影響がないことを確認する。</p> <p>波及的影響の評価に当たっては、耐震重要施設の設計に用いる地震動又は地震力を適用する。なお、地震動又は地震力の選定に当たっては、施設の配置状況、使用時間を踏まえて適切に設定する。また、波及的影響の確認においては水平2方向及び鉛直方向の地震力が同時に作用する場合に影響を及ぼす可能性のある施設、設備を選定し評価する。</p> <p>ここで、下位クラス施設とは、耐震重要施設以外の再処理施設内にある施設(資機材等含む。)をいう。</p> <p>波及的影響を防止するよう現場を維持するため、機器設置時の配慮事項等を保安規定に定めて、管理する。</p> <p>なお、原子力施設及び化学プラント等の地震被害情報をもとに、4つの観点以外に検討すべき事項がないか確認し、新たな検討事項が抽出された場合には、その観点を追加する。</p>	<p>b. 波及的影響に対する考慮</p> <p>耐震重要施設は、耐震重要度の下位のクラスに属する施設の波及的影響によって、その安全機能が損なわれないものとする。</p> <p>評価に当たっては、以下の4つの観点をもとに、敷地全体を俯瞰した調査・検討を行い、各観点より選定した事象に対する波及的影響の評価により波及的影響を考慮すべき施設を抽出し、耐震重要施設の安全機能への影響がないことを確認する。</p> <p>波及的影響の評価に当たっては、耐震重要施設の設計に用いる地震動又は地震力を適用する。なお、地震動又は地震力の選定に当たっては、施設の配置状況、使用時間を踏まえて適切に設定する。また、波及的影響の確認においては水平2方向及び鉛直方向の地震力が同時に作用する場合に影響を及ぼす可能性のある施設、設備を選定し評価する。</p> <p>ここで、下位クラス施設とは、耐震重要施設以外の再処理施設内にある施設(資機材等含む。)をいう。</p> <p>波及的影響を防止するよう現場を維持するため、機器設置時の配慮事項等を保安規定に定めて、管理する。</p> <p>なお、原子力施設及び化学プラント等の地震被害情報をもとに、4つの観点以外に検討すべき事項がないか確認し、新たな検討事項が抽出された場合には、その観点を追加する。</p>

基本設計方針の第 1 回申請範囲 (25/26)

全体	第 1 回申請範囲
<p>(a) 設置地盤及び地震応答性状の相違に起因する相対変位又は不等沈下による影響</p> <p>イ. 不等沈下 耐震重要施設の設計に用いる地震動又は地震力に対して不等沈下により，耐震重要施設の安全機能への影響がないことを確認する。</p> <p>ロ. 相対変位 耐震重要施設の設計に用いる地震動又は地震力による下位クラス施設と耐震重要施設の相対変位により，耐震重要施設の安全機能への影響がないことを確認する。</p> <p>(b) 耐震重要施設と下位クラス施設との接続部における相互影響 耐震重要施設の設計に用いる地震動又は地震力に対して，耐震重要施設に接続する下位クラス施設の損傷により，耐震重要施設の安全機能への影響がないことを確認する。</p> <p>(c) 建屋内における下位クラス施設の損傷，転倒及び落下による耐震重要施設への影響 耐震重要施設の設計に用いる地震動又は地震力に対して，建屋内の下位クラス施設の損傷，転倒及び落下により，耐震重要施設の安全機能への影響がないことを確認する。</p> <p>(d) 建屋外における下位クラス施設の損傷，転倒及び落下による耐震重要施設への影響 耐震重要施設の設計に用いる地震動又は地震力に対して，建屋外の下位クラス施設の損傷，転倒及び落下により，耐震重要施設の安全機能への影響がないことを確認する。</p> <p>なお，常設耐震重要重大事故等対処設備が設置される重大事故等対処施設に対する波及的影響については，「耐震重要施設」を「常設耐震重要重大事故等対処設備が設置される重大事故等対処施設」に，「耐震重要度の下位のクラスに属する施設」を「常設耐震重要重大事故等対処設備が設置される重大事故等対処施設以外の施設」に，「安全機能」を「重大事故等に対処するために必要な機能」に読み替えて適用する。</p> <p>c. 建物・構築物への地下水の影響 耐震設計において地下水位の低下を期待する建物・構築物は，周囲の地下水を排水し，基礎スラブ底面レベル以深に地下水位を維持できるよう地下水排水設備（サブドレンポンプ，水位検出器等）を設置する。また，基準地震動 S_s による地震力に対して，必要な機能が保持できる設計とするとともに，非常用電源設備又は基準地震動 S_s による地震力に対し機能維持が可能な発電機からの給電が可能な設計とする。</p>	<p>(a) 設置地盤及び地震応答性状の相違に起因する相対変位又は不等沈下による影響</p> <p>イ. 不等沈下 耐震重要施設の設計に用いる地震動又は地震力に対して不等沈下により，耐震重要施設の安全機能への影響がないことを確認する。</p> <p>ロ. 相対変位 耐震重要施設の設計に用いる地震動又は地震力による下位クラス施設と耐震重要施設の相対変位により，耐震重要施設の安全機能への影響がないことを確認する。</p> <p>(b) 耐震重要施設と下位クラス施設との接続部における相互影響 耐震重要施設の設計に用いる地震動又は地震力に対して，耐震重要施設に接続する下位クラス施設の損傷により，耐震重要施設の安全機能への影響がないことを確認する。</p> <p>(c) 建屋内における下位クラス施設の損傷，転倒及び落下による耐震重要施設への影響 耐震重要施設の設計に用いる地震動又は地震力に対して，建屋内の下位クラス施設の損傷，転倒及び落下により，耐震重要施設の安全機能への影響がないことを確認する。</p> <p>(d) 建屋外における下位クラス施設の損傷，転倒及び落下による耐震重要施設への影響 耐震重要施設の設計に用いる地震動又は地震力に対して，建屋外の下位クラス施設の損傷，転倒及び落下により，耐震重要施設の安全機能への影響がないことを確認する。</p> <p>（重大事故等対処施設に係る基本設計方針については，重大事故等対処施設の詳細設計の対象となる申請書で示す。）</p> <p>c. 建物・構築物への地下水の影響 耐震設計において地下水位の低下を期待する建物・構築物は，周囲の地下水を排水し，基礎スラブ底面レベル以深に地下水位を維持できるよう地下水排水設備（サブドレンポンプ，水位検出器等）を設置する。また，基準地震動 S_s による地震力に対して，必要な機能が保持できる設計とするとともに，非常用電源設備又は基準地震動 S_s による地震力に対し機能維持が可能な発電機からの給電が可能な設計とする。</p>

基本設計方針の第 1 回申請範囲 (26/26)

全体	第 1 回申請範囲
<p>d. 一関東評価用地震動（鉛直）</p> <p>基準地震動 $S_s - C4$ は、水平方向の地震動のみであることから、水平方向と鉛直方向の地震力を組み合わせた影響評価を行う場合には、工学的に水平方向の地震動から設定した鉛直方向の評価用地震動（以下「一関東評価用地震動（鉛直）」という。）による地震力を用いて、水平方向と鉛直方向の地震力を組み合わせた影響が考えられる施設に対して、許容限界の範囲内に留まることを確認する。</p> <p>(6) 緊急時対策所</p> <p>緊急時対策所については、基準地震動 S_s による地震力に対して、重大事故等に対処するために必要な機能が損なわれるおそれがない設計とする。緊急時対策建屋については、耐震構造とし、基準地震動 S_s による地震力に対して、遮蔽機能を確保する設計とする。</p> <p>また、緊急時対策所の居住性を確保するため、鉄筋コンクリート構造とし、基準地震動 S_s による地震力に対して、緊急時対策建屋の換気設備の性能とあいまって十分な気密性を確保する設計とする。</p> <p>なお、地震力の算定方法及び荷重の組合せと許容限界については、「(3)地震力の算定方法」及び「(4)荷重の組合せと許容限界」に示す建物・構築物及び機器・配管系を適用する。</p> <p>(7) 地震による周辺斜面の崩壊に対する設計方針</p> <p>耐震重要施設及び常設耐震重要重大事故等対処設備が設置される重大事故等対処施設については、基準地震動 S_s による地震力により周辺斜面の崩壊の影響がないことが確認された場所に設置する。</p> <p>なお、耐震重要施設及び常設耐震重要重大事故等対処設備が設置される重大事故等対処施設周辺においては平坦な造成地であることから、地震力に対して、施設の安全機能及び重大事故等に対処するために必要な機能に重大な影響を与えるような崩壊を起こすおそれのある斜面はない。</p>	<p>d. 一関東評価用地震動（鉛直）</p> <p>基準地震動 $S_s - C4$ は、水平方向の地震動のみであることから、水平方向と鉛直方向の地震力を組み合わせた影響評価を行う場合には、工学的に水平方向の地震動から設定した鉛直方向の評価用地震動（以下「一関東評価用地震動（鉛直）」という。）による地震力を用いて、水平方向と鉛直方向の地震力を組み合わせた影響が考えられる施設に対して、許容限界の範囲内に留まることを確認する。</p> <p>(6) 緊急時対策所</p> <p>（緊急時対策所に係る基本設計方針については、緊急時対策所の詳細設計の対象となる申請書で示す。）</p> <p>(7) 地震による周辺斜面の崩壊に対する設計方針</p> <p>耐震重要施設については、基準地震動 S_s による地震力により周辺斜面の崩壊の影響がないことが確認された場所に設置する。</p> <p>なお、耐震重要施設周辺においては平坦な造成地であることから、地震力に対して、施設の安全機能に重大な影響を与えるような崩壊を起こすおそれのある斜面はない。</p> <p>（重大事故等対処施設に係る基本設計方針については、重大事故等対処施設の詳細設計の対象となる申請書で示す。）</p>

変更前記載事項の既設工認等との紐づけ (1/19)

	変 更 前	変 更 後
	<p><凡例></p> <p> : 既設工認に記載されている内容と同様</p> <p> : 既設工認に記載されている内容と全く同じではないが、既設工認の記載を詳細展開した内容であり、設計上実施していたもの</p> <p> : その他既設工認に記載されていないが、従前より設計上考慮して実施していたもの</p> <p> : 既認可等のエビデンス</p> <p>第 1 章 共通項目</p> <p>3. 自然現象等</p> <p>3.1 地震による損傷の防止</p> <p>3.1.1 耐震設計</p> <p>(1) 耐震設計の基本方針</p> <p>再処理施設は、次の方針に基づき耐震設計を行う。</p> <p>地震⑧ - 1 なお、以下の項目における建物・構築物とは、建物、構築物及び土木構造物（屋外重要土木構造物及びその他の土木構造物）の総称とする。 既許可 本文</p> <p>地震⑨ - 2 また、屋外重要土木構造物とは、耐震安全上重要な機器・配管系の間接支持機能を求められる土木構造物をいう。 既設工認 添付書類IV-2-2-1-6（第7回申請）</p> <p>a. 安全機能を有する施設</p> <p>地震⑩ - 4 (a) 安全機能を有する施設は、地震の発生によって生ずるおそれがある安全機能の喪失及びそれに続く放射線による公衆への影響を防止する観点から、施設の安全機能が喪失した場合の影響の相対的な程度（以下「耐震重要度」という。）に応じて、Sクラス、Bクラス又はCクラスに分類し、それぞれの耐震重要度に応じた地震力に十分耐えられる設計とする。 既設工認 添付書類IV-1-1（第1回申請）</p> <p>既設工認 添付書類IV-1-1（第1回申請）</p> <p>地震⑪ - 1 (b) 耐震重要施設（(a)においてSクラスに分類する施設をいう。）は、その供用中に大きな影響を及ぼすおそれがある地震動（事業指定(変更許可)を受けた基準地震動（以下「基準地震動」という。））による地震力に対してその安全機能が損なわれるおそれがない設計とする。</p> <p>地震⑫ - 6 (c) Sクラスの施設は、基準地震動による地震力に対してその安全機能が損なわれるおそれがない設計とする。 既設工認 添付書類IV-1-1（第1回申請）</p>	<p>第 1 章 共通項目</p> <p>3. 自然現象等</p> <p>3.1 地震による損傷の防止</p> <p>3.1.1 耐震設計</p> <p>(1) 耐震設計の基本方針</p> <p>再処理施設は、次の方針に基づき耐震設計を行う。</p> <p>なお、以下の項目における建物・構築物とは、建物、構築物及び土木構造物（屋外重要土木構造物及びその他の土木構造物）の総称とする。</p> <p>また、屋外重要土木構造物とは、耐震安全上重要な機器・配管系の間接支持機能を求められる土木構造物をいう。</p> <p>a. 安全機能を有する施設</p> <p>(a) 安全機能を有する施設は、地震の発生によって生ずるおそれがある安全機能の喪失及びそれに続く放射線による公衆への影響を防止する観点から、施設の安全機能が喪失した場合の影響の相対的な程度（以下「耐震重要度」という。）に応じて、Sクラス、Bクラス又はCクラスに分類し、それぞれの耐震重要度に応じた地震力に十分耐えられる設計とする。</p> <p>(b) 耐震重要施設（(a)においてSクラスに分類する施設をいう。）は、その供用中に大きな影響を及ぼすおそれがある地震動（事業指定(変更許可)を受けた基準地震動（以下「基準地震動S_s」という。））による地震力に対してその安全機能が損なわれるおそれがない設計とする。</p> <p>(c) Sクラスの施設は、基準地震動S_sによる地震力に対してその安全機能が損なわれるおそれがない設計とする。</p>

変更前記載事項の既設工認等との紐づけ (2/19)

	変 更 前	変 更 後
地震① - 2 地震① - 5	<p>建物・構築物については、基準地震動による地震力に対して、建物・構築物全体としての変形能力（耐震壁のせん断ひずみ等）が終局耐力時の変形に対して十分な余裕を有し、部材・部位ごとのせん断ひずみ・応力等が終局耐力時のせん断ひずみ・応力等に対して、妥当な安全余裕を有する設計とする。</p> <p>既設工認 添付書類IV-1-1 (第1回申請)</p>	<p>建物・構築物については、基準地震動S_sによる地震力に対して、建物・構築物全体としての変形能力（耐震壁のせん断ひずみ等）が終局耐力時の変形に対して十分な余裕を有し、部材・部位ごとのせん断ひずみ・応力等が終局耐力時のせん断ひずみ・応力等に対して、妥当な安全余裕を有する設計とする。</p>
地震① - 6 地震① - 39 地震① - 41	<p>機器・配管系については、基準地震動による地震力に対して、その施設に要求される機能を保持する設計とし、塑性域に達するひずみが生じる場合であっても、その量が小さなレベルに留まって破断延性限界に十分な余裕を有し、その施設に要求される機能に影響を及ぼさない、また、動的機器等については、基準地震動による応答に対してその設備に要求される機能を保持する設計とする。なお、動的機能が要求される機器については、当該機器の構造、動作原理等を考慮した評価を行い、既往の研究等で機能維持の確認がなされた機能確認済加速度等を超えていないことを確認する。</p> <p>既設工認 添付書類IV-1-1 (第1回申請)</p>	<p>機器・配管系については、基準地震動S_sによる地震力に対して、その施設に要求される機能を保持する設計とし、塑性域に達するひずみが生じる場合であっても、その量が小さなレベルに留まって破断延性限界に十分な余裕を有し、その施設に要求される機能に影響を及ぼさない、また、動的機器等については、基準地震動S_sによる応答に対してその設備に要求される機能を保持する設計とする。なお、動的機能が要求される機器については、当該機器の構造、動作原理等を考慮した評価を行い、既往の研究等で機能維持の確認がなされた機能確認済加速度等を超えていないことを確認する。</p>
地震① - 5 地震① - 6	<p>また、Sクラスの施設は、事業指定(変更許可)を受けた弾性設計用地震動（以下「弾性設計用地震動」という。）による地震力又は静的地震力のいずれか大きい方の地震力に対しておおむね弾性状態に留まる範囲で耐えられる設計とする。</p> <p>既設工認 添付書類IV-1-1 (第1回申請)</p>	<p>また、Sクラスの施設は、事業指定(変更許可)を受けた弾性設計用地震動（以下「弾性設計用地震動S_d」という。）による地震力又は静的地震力のいずれか大きい方の地震力に対しておおむね弾性状態に留まる範囲で耐えられる設計とする。</p>
地震① - 2	<p>建物・構築物については、弾性設計用地震動による地震力又は静的地震力のいずれか大きい方の地震力により発生する応力に対して、建築基準法等の安全上適切と認められる規格及び基準による許容応力度を許容限界とする。</p> <p>既設工認 添付書類IV-1-1 (第1回申請)</p>	<p>建物・構築物については、弾性設計用地震動S_dによる地震力又は静的地震力のいずれか大きい方の地震力により発生する応力に対して、建築基準法等の安全上適切と認められる規格及び基準による許容応力度を許容限界とする。</p>
地震① - 38	<p>機器・配管系については、弾性設計用地震動による地震力又は静的地震力のいずれか大きい方の地震力による応答が全体的におおむね弾性状態に留まる設計とする。</p> <p>既設工認 添付書類IV-1-1 (第1回申請)</p>	<p>機器・配管系については、弾性設計用地震動S_dによる地震力又は静的地震力のいずれか大きい方の地震力による応答が全体的におおむね弾性状態に留まる設計とする。</p>
地震① - 7	<p>(d) Sクラスの施設について、静的地震力は、水平地震力と鉛直地震力が同時に不利な方向の組合せで作用するものとする。</p> <p>既設工認 添付書類IV-1-1 (第1回申請)</p>	<p>(d) Sクラスの施設について、静的地震力は、水平地震力と鉛直地震力が同時に不利な方向の組合せで作用するものとする。</p> <p>また、基準地震動S_s及び弾性設計用地震動S_dによる地震力は、水平2方向及び鉛直方向について適切に組み合わせて算定するものとする。</p>

変更前記載事項の既設工認等との紐づけ (3/19)

	変 更 前	変 更 後
地震① - 5 地震① - 6 地震① - 17	<p>(e) Bクラス及びCクラスの施設は、静的地震力に対しておおむね弾性状態に留まる範囲で耐えられる設計とする。また、Bクラスの施設のうち、共振のおそれのある施設については、その影響についての検討を行う。検討に用いる地震動は、弾性設計用地震動に2分の1を乗じたものとする。</p> <p style="text-align: right;">既設工認 添付書類IV-1-1 (第1回申請)</p>	<p>(e) Bクラス及びCクラスの施設は、静的地震力に対しておおむね弾性状態に留まる範囲で耐えられる設計とする。また、Bクラスの施設のうち、共振のおそれのある施設については、その影響についての検討を行う。検討に用いる地震動は、弾性設計用地震動S_dに2分の1を乗じたものとする。当該地震動による地震力は、水平2方向及び鉛直方向について適切に組み合わせて算定するものとする。</p>
地震② - 6	<p>(f) 耐震重要施設は、耐震重要度の下位のクラスに属する施設の波及的影響によって、その安全機能を損なわない設計とする。</p> <p style="text-align: right;">既設工認 添付書類IV-1-2-1 (第1回申請)</p>	<p>(f) 耐震重要施設は、耐震重要度の下位のクラスに属する施設の波及的影響によって、その安全機能を損なわない設計とする。</p>
地震① - 3	<p>(g) 耐震重要施設については、周辺地盤の変状により、その安全機能が損なわれるおそれがない設計とする。</p> <p style="text-align: right;">既設工認 添付書類IV-1-1 (第1回申請)</p>	<p>(g) 耐震重要施設については、周辺地盤の変状により、その安全機能が損なわれるおそれがない設計とする。</p>
	<p>(重大事故等対処施設に係る基本設計方針については、重大事故等対処施設の詳細設計の対象となる申請書で示す。)</p>	<p>b. 重大事故等対処施設 (重大事故等対処施設に係る基本設計方針については、重大事故等対処施設の詳細設計の対象となる申請書で示す。)</p>
地震① - 8	<p>(2) 耐震設計上の重要度分類</p> <p>a. 安全機能を有する施設の耐震設計上の重要度分類</p> <p>安全機能を有する施設の耐震重要度を以下のとおり分類する。</p> <p style="text-align: right;">既設工認 添付書類IV-1-1 (第1回申請)</p>	<p>(2) 耐震設計上の重要度分類</p> <p style="text-align: right;">変更なし</p>
地震① - 9 地震② - 1	<p>(a) Sクラスの施設</p> <p>自ら放射性物質を内蔵している施設、当該施設に直接関係しておりその機能喪失により放射性物質を外部に拡散する可能性のある施設、放射性物質を外部に放出する可能性のある事態を防止するために必要な施設及び事故発生の際に、外部に放出される放射性物質による影響を低減させるために必要な施設であって、環境への影響が大きいもの。</p> <p style="text-align: right;">既設工認 添付書類IV-1-1 (第1回申請) 添付書類IV-1-2-1 (第1回申請)</p>	

変更前記載事項の既設工認等との紐づけ (4/19)

変 更 前		変 更 後
地震① - 9 地震② - 3	<p>イ. その破損又は機能喪失により臨界事故を起こすおそれのある施設</p> <p>ロ. 使用済燃料を貯蔵するための施設</p> <p>ハ. 高レベル放射性液体廃棄物を内蔵する系統及び機器並びにその冷却系統</p> <p>ニ. プルトニウムを含む溶液を内蔵する系統及び機器</p> <p>ホ. 上記ハ.及びニ.の系統及び機器から放射性物質が漏えいした場合に、その影響の拡大を防止するための施設</p> <p>ヘ. 上記ハ., ニ.及びホ.に関連する施設で放射性物質の外部への放出を抑制するための施設</p> <p>ト. 上記イ.からヘ.の施設の機能を確保する</p>	<p>既設工認 添付書類IV-1-1 (第1回申請)</p> <p>添付書類IV-1-2-1 (第1回申請)</p>
地震① - 10 地震② - 2	<p>(b) Bクラスの施設</p> <p>安全機能を有する施設のうち、機能喪失した場合の影響がSクラスに属する施設と比べ小さい施設。</p>	<p>既設工認 添付書類IV-1-1 (第1回申請)</p> <p>添付書類IV-1-2-1 (第1回申請)</p>
地震① - 10 地震② - 4	<p>イ. 放射性物質を内蔵している施設であって、Sクラスに属さない施設(ただし、内蔵量が少ないか又は貯蔵方式により、その破損により公衆に与える放射線の影響が十分小さいものは除く。)</p> <p>ロ. 放射性物質の放出を伴うような場合に、その外部放散を抑制するための施設で、Sクラスに属さない施設</p>	<p>既設工認 添付書類IV-1-1 (第1回申請)</p> <p>添付書類IV-1-2-1 (第1回申請)</p>
地震① - 11 地震② - 5	<p>(c) Cクラスの施設</p> <p>Sクラスに属する施設及びBクラスに属する施設以外の一般産業施設又は公共施設と同等の安全性が要求される施設。</p>	<p>既設工認 添付書類IV-1-1 (第1回申請)</p> <p>添付書類IV-1-2-1 (第1回申請)</p>
地震① - 12	<p>上記に基づく耐震設計上の重要度分類を第3.1.1-1表に示す。</p> <p>なお、同表には当該施設を支持する建物・構築物の支持機能が維持されることを確認する地震動及び波及的影響を考慮すべき施設に適用する地震動についても併記する。</p>	<p>既設工認 添付書類IV-1-1 (第1回申請)</p>

変更前記載事項の既設工認等との紐づけ (5/19)

	変 更 後
<p>(重大事故等対処施設に係る基本設計方針については、重大事故等対処施設の詳細設計の対象となる申請書で示す。)</p> <p>(3) 地震力の算定方法</p> <p>耐震設計に用いる設計用地震力は、以下の方法で算定される静的地震力及び動的な地震力とする。</p> <p style="text-align: right;">既設工認 添付書類IV-1-1(第1回申請)</p>	<p>b. 重大事故等対処施設の設備分類</p> <p>(重大事故等対処施設に係る基本設計方針については、重大事故等対処施設の詳細設計の対象となる申請書で示す。)</p> <p>(3) 地震力の算定方法</p> <p>耐震設計に用いる設計用地震力は、以下の方法で算定される静的地震力及び動的な地震力とする。</p>
<p>a. 静的地震力</p> <p>安全機能を有する施設に適用する静的地震力は、Sクラス、Bクラス及びCクラスの施設に適用することとし、それぞれの耐震重要度に応じて以下の地震層せん断力係数及び震度に基づき算定する。</p> <p>(重大事故等対処施設に係る基本設計方針については、重大事故等対処施設の詳細設計の対象となる申請書で示す。)</p> <p style="text-align: right;">既設工認 添付書類IV-1-1(第1回申請)</p>	<p>a. 静的地震力</p> <p>安全機能を有する施設に適用する静的地震力は、Sクラス、Bクラス及びCクラスの施設に適用することとし、それぞれの耐震重要度に応じて以下の地震層せん断力係数及び震度に基づき算定する。</p> <p>(重大事故等対処施設に係る基本設計方針については、重大事故等対処施設の詳細設計の対象となる申請書で示す。)</p>
<p>(a) 建物・構築物</p> <p>水平地震力は、地震層せん断力係数C_iに、次に示す施設の耐震重要度に応じた係数を乗じ、さらに当該層以上の重量を乗じて算定するものとする。</p> <p>Sクラス 3.0 Bクラス 1.5 Cクラス 1.0</p> <p>ここで、地震層せん断力係数C_iは、標準せん断力係数C_0を0.2以上とし、建物・構築物の振動特性、地盤の種類等を考慮して求められる値とする。</p> <p style="text-align: right;">既設工認 添付書類IV-1-1(第1回申請)</p>	<p>(a) 建物・構築物</p> <p>水平地震力は、地震層せん断力係数C_iに、次に示す施設の耐震重要度に応じた係数を乗じ、さらに当該層以上の重量を乗じて算定するものとする。</p> <p>Sクラス 3.0 Bクラス 1.5 Cクラス 1.0</p> <p>ここで、地震層せん断力係数C_iは、標準せん断力係数C_0を0.2以上とし、建物・構築物の振動特性、地盤の種類等を考慮して求められる値とする。</p>
<p>また、必要保有水平耐力の算定においては、地震層せん断力係数C_iに乘じる施設の耐震重要度に応じた係数は、耐震重要度の各クラスともに1.0とし、その際に用いる標準せん断力係数C_0は1.0以上とする。</p> <p style="text-align: right;">既設工認 添付書類IV-1-1(第1回申請)</p>	<p>また、必要保有水平耐力の算定においては、地震層せん断力係数C_iに乘じる施設の耐震重要度に応じた係数は、耐震重要度の各クラスともに1.0とし、その際に用いる標準せん断力係数C_0は1.0以上とする。</p>
<p>Sクラスの施設については、水平地震力と鉛直地震力が同時に不利な方向の組合せで作用するものとする。鉛直地震力は、震度0.3以上を基準とし、建物・構築物の振動特性及び地盤の種類等を考慮し、高さ方向に一定として求めた鉛直震度より算定する。</p> <p style="text-align: right;">既設工認 添付書類IV-1-1(第1回申請)</p>	<p>Sクラスの施設については、水平地震力と鉛直地震力が同時に不利な方向の組合せで作用するものとする。鉛直地震力は、震度0.3以上を基準とし、建物・構築物の振動特性及び地盤の種類等を考慮し、高さ方向に一定として求めた鉛直震度より算定する。</p>

地震① - 13

地震① - 14

地震① - 15

地震① - 37

地震① - 15

変更前記載事項の既設工認等との紐づけ (6/19)

変 更 前	変 更 後
<p>(b) 機器・配管系</p> <p>耐震重要度の各クラスの地震力は、上記(a)に示す地震層せん断力係数C_iに施設の耐震重要度に応じた係数を乗じたものを水平震度とし、当該水平震度及び上記(a)の鉛直震度をそれぞれ20%増しとした震度より求めるものとする。</p> <p>Sクラスの施設については、水平地震力と鉛直地震力は同時に不利な方向の組合せで作用するものとする。ただし、鉛直震度は高さ方向に一定とする。</p> <p style="text-align: right;">既設工認 添付書類IV-1-1(第1回申請)</p>	<p>(b) 機器・配管系</p> <p>耐震重要度の各クラスの地震力は、上記(a)に示す地震層せん断力係数C_iに施設の耐震重要度に応じた係数を乗じたものを水平震度とし、当該水平震度及び上記(a)の鉛直震度をそれぞれ20%増しとした震度より求めるものとする。</p> <p>Sクラスの施設については、水平地震力と鉛直地震力は同時に不利な方向の組合せで作用するものとする。ただし、鉛直震度は高さ方向に一定とする。</p>
<p>b. 動的地震力</p> <p>安全機能を有する施設について、Sクラスの施設の設計に適用する動的地震力は、基準地震動及び弾性設計用地震動から定める入力地震動を適用する。</p> <p>Bクラスの施設のうち共振のおそれのある施設については、上記Sクラスの施設に適用する弾性設計用地震動に2分の1を乗じたものから定める入力地震動を適用する。</p> <p style="text-align: right;">既設工認 添付書類IV-1-1 (第1回申請) 添付書類IV-1-2-2 (第1回申請)</p>	<p>上記(a)及び(b)の標準せん断力係数C_0等の割増し係数については、耐震性向上の観点から、一般産業施設及び公共施設の耐震基準との関係を考慮して設定する。</p> <p>b. 動的地震力</p> <p>安全機能を有する施設について、Sクラスの施設の設計に適用する動的地震力は、基準地震動S_s及び弾性設計用地震動S_dから定める入力地震動を適用する。</p> <p>Bクラスの施設のうち共振のおそれのある施設については、上記Sクラスの施設に適用する弾性設計用地震動S_dに2分の1を乗じたものから定める入力地震動を適用する。</p>
<p>安全機能を有する施設の動的解析においては、地盤の諸定数も含めて材料のばらつきによる変動幅を適切に考慮する。</p> <p style="text-align: right;">既設工認 添付書類IV-1-2-5 (第2回申請)</p>	<p>安全機能を有する施設の動的解析においては、地盤の諸定数も含めて材料のばらつきによる変動幅を適切に考慮する。</p>
<p>(重大事故等対処施設に係る基本設計方針については、重大事故等対処施設の詳細設計の対象となる申請書で示す。)</p>	<p>動的地震力は、水平2方向及び鉛直方向について適切に組み合わせて算定する。水平2方向及び鉛直方向地震力の組合せによる影響確認に当たっては、水平1方向及び鉛直方向地震力を組み合わせた既往の耐震計算への影響が考えられる施設、設備の部位を抽出し、建物・構築物の3次元応答性状及びそれによる機器・配管系への影響を考慮した上で、既往の方法を用いた耐震性に及ぼす影響を評価する。</p> <p>(重大事故等対処施設に係る基本設計方針については、重大事故等対処施設の詳細設計の対象となる申請書で示す。)</p>

地震① - 16
地震① - 30

地震① - 17
地震③ - 7

地震⑥ - 2

変更前記載事項の既設工認等との紐づけ (7/19)

	変 更 前	変 更 後
地震③ - 1 地震③ - 4	<p>(a) 入力地震動</p> <p>地質調査の結果によれば、重要な再処理施設の設置位置周辺は、新第三紀の鷹架層が十分な広がりをもって存在することが確認されている。</p> <p>解放基盤表面は、この新第三紀の鷹架層のS波速度が 0.7 km/s 以上を有する標高約-70m の位置に想定することとする。</p> <p>基準地震動及び弾性設計用地震動は、解放基盤表面で定義する。</p> <p style="text-align: right;">既設工認 添付書類IV-1-2-2 (第1回申請)</p>	<p>(a) 入力地震動</p> <p>地質調査の結果によれば、重要な再処理施設の設置位置周辺は、新第三紀の鷹架層が十分な広がりをもって存在することが確認されている。</p> <p>解放基盤表面は、この新第三紀の鷹架層のS波速度が 0.7 km/s 以上を有する標高約-70m の位置に想定することとする。</p> <p>基準地震動 S s 及び弾性設計用地震動 S d は、解放基盤表面で定義する。</p>
地震③ - 2 地震③ - 5	<p>建物・構築物の地震応答解析モデルに対する入力地震動は、解放基盤表面からの地震波の伝播特性を適切に考慮した上で、必要に応じ2次元FEM解析又は1次元波動論により、地震応答解析モデルの入力位置で評価した入力地震動を設定する。また、必要に応じて地盤の非線形応答に関する動的変形特性を考慮することとし、地盤のひずみに応じた地盤物性値を用いて作成する。非線形性の考慮に当たっては、地下水排水設備による地下水位の低下状態を踏まえ評価する。</p> <p style="text-align: right;">既設工認 添付書類IV-1-2-2 (第1回申請)</p>	<p>建物・構築物の地震応答解析モデルに対する入力地震動は、解放基盤表面からの地震波の伝播特性を適切に考慮した上で、必要に応じ2次元FEM解析又は1次元波動論により、地震応答解析モデルの入力位置で評価した入力地震動を設定する。また、必要に応じて地盤の非線形応答に関する動的変形特性を考慮することとし、地盤のひずみに応じた地盤物性値を用いて作成する。非線形性の考慮に当たっては、地下水排水設備による地下水位の低下状態を踏まえ評価する。</p>
地震③ - 3 地震③ - 6	<p>地盤条件を考慮する場合には、地震動評価で考慮した敷地全体の地下構造との関係や対象建物・構築物の直下又は周辺の地質・速度構造の違いにも留意する。</p> <p>また、必要に応じ敷地における観測記録による検証や最新の科学的・技術的知見を踏まえ、地質・速度構造等の地盤条件を設定する。</p> <p style="text-align: right;">既設工認 添付書類IV-1-2-2 (第1回申請)</p>	<p>地盤条件を考慮する場合には、地震動評価で考慮した敷地全体の地下構造との関係や対象建物・構築物の直下又は周辺の地質・速度構造の違いにも留意する。</p> <p>また、必要に応じ敷地における観測記録による検証や最新の科学的・技術的知見を踏まえ、地質・速度構造等の地盤条件を設定する。</p>
地震① - 17 地震③ - 3 地震③ - 6	<p style="text-align: right;">既設工認 添付書類IV-1-1 (第1回申請) 添付書類IV-1-2-2 (第1回申請)</p> <p>Bクラスの施設のうち共振のおそれがあり、動的解析が必要なものに対しては、弾性設計用地震動に2分の1を乗じたものを用いる。</p> <p>(重大事故等対処施設に係る基本設計方針については、重大事故等対処施設の詳細設計の対象となる申請書で示す。)</p>	<p>Bクラスの施設のうち共振のおそれがあり、動的解析が必要なものに対しては、弾性設計用地震動 S d に2分の1を乗じたものを用いる。</p> <p>(重大事故等対処施設に係る基本設計方針については、重大事故等対処施設の詳細設計の対象となる申請書で示す。)</p>

変更前記載事項の既設工認等との紐づけ (8/19)

変 更 前	変 更 後
<p>(b) 動的解析法</p> <p>イ. 建物・構築物</p> <p>動的解析に当たっては、対象施設の形状、構造特性、振動特性等を踏まえ、地震応答解析手法の適用性及び適用限界等を考慮のうえ、適切な解析法を選定するとともに、建物・構築物に応じて十分な調査に基づく適切な解析条件を設定する。動的解析は、原則として、時刻歴応答解析法を用いて求めるものとする。</p> <p>また、3次元応答性状等の評価は、線形解析に適用可能な周波数応答解析法による。</p> <p>建物・構築物の動的解析に当たっては、建物・構築物の剛性はそれらの形状、構造特性、振動特性、減衰特性を十分考慮して評価し、集中質点系に置換した解析モデルを設定する。</p> <p style="text-align: right;">既設工認 添付書類IV-1-2-2 (第1回申請) 添付書類IV-1-2-5 (第2回申請)</p>	<p>(b) 動的解析法</p> <p>イ. 建物・構築物</p> <p>動的解析に当たっては、対象施設の形状、構造特性、振動特性等を踏まえ、地震応答解析手法の適用性及び適用限界等を考慮のうえ、適切な解析法を選定するとともに、建物・構築物に応じて十分な調査に基づく適切な解析条件を設定する。動的解析は、原則として、時刻歴応答解析法を用いて求めるものとする。</p> <p>また、3次元応答性状等の評価は、線形解析に適用可能な周波数応答解析法による。</p> <p>建物・構築物の動的解析に当たっては、建物・構築物の剛性はそれらの形状、構造特性、振動特性、減衰特性を十分考慮して評価し、集中質点系に置換した解析モデルを設定する。</p>
<p>動的解析には、建物・構築物と地盤の相互作用及び埋込み効果を考慮するものとし、解析モデルの地盤のばね定数は、基礎版の平面形状、地盤の剛性等を考慮して定める。地盤の剛性等については、必要に応じて地盤の非線形応答を考慮することとし、地盤のひずみに応じた地盤物性値に基づくものとする。設計用地盤定数の設定に当たっては、地盤の構造特性の考慮として、地震動評価で考慮した敷地全体の地下構造との関係や対象建物・構築物の直下又は周辺の地質・速度構造の違いにも留意し、原則として、弾性波試験によるものを用いる。</p> <p style="text-align: right;">既設工認 添付書類IV-1-2-2 (第1回申請)</p>	<p>動的解析には、建物・構築物と地盤の相互作用及び埋込み効果を考慮するものとし、解析モデルの地盤のばね定数は、基礎版の平面形状、地盤の剛性等を考慮して定める。地盤の剛性等については、必要に応じて地盤の非線形応答を考慮することとし、地盤のひずみに応じた地盤物性値に基づくものとする。設計用地盤定数の設定に当たっては、地盤の構造特性の考慮として、地震動評価で考慮した敷地全体の地下構造との関係や対象建物・構築物の直下又は周辺の地質・速度構造の違いにも留意し、原則として、弾性波試験によるものを用いる。</p> <p>地盤－建物・構築物連成系の減衰定数は、振動エネルギーの地下逸散及び地震応答における各部のひずみレベルを考慮して定める。</p> <p>基準地震動 S_s 及び弾性設計用地震動 S_d に対する応答解析において、主要構造要素がある程度以上弾性範囲を超える場合には、実験等の結果に基づき、該当する建物部分の構造特性に応じて、その弾塑性挙動を適切に模擬した復元力特性を考慮した応答解析を行う。</p> <p>また、Sクラスの施設を支持する建物・構築物の支持機能を検討するための動的解析において、当該施設を支持する建物・構築物の主要構造要素がある程度以上弾性範囲を超える場合には、その弾塑性挙動を適切に模擬した復元力特性を考慮した応答解析を行う。</p> <p>地震応答解析に用いる材料定数については、地盤の諸定数も含めて材料のばらつきによる変動幅を適切に考慮する。また、材料のばらつきによる変動が建物・構築物の振動性状や応答性状に及ぼす影響として考慮すべき要因を選定した上で、選定された要因を考慮した動的解析により設計用地震力を設定する。</p>

地震③ - 2
地震③ - 5
地震⑥ - 1

地震③ - 3
地震③ - 6

変更前記載事項の既設工認等との紐づけ (9/19)

変 更 前	変 更 後
<p>地震③ - 6 地震⑨ - 1</p> <p style="text-align: center;">既設工認 添付書類IV-1-2-2 (第1回申請) 添付書類IV-2-2-1-6 (第7回申請)</p> <p>建物・構築物のうち土木構造物の動的解析に当たっては、構造物と地盤の相互作用を考慮できる連成系の地震応答解析手法を用いる。地震応答解析手法は、地盤及び構造物の地震時における非線形挙動の有無や程度に応じて、線形、等価線形又は非線形解析のいずれかによる。地盤の地震応答解析モデルは、構造物と地盤の動的相互作用を考慮できる有限要素法を用いる。構造物の地震応答解析に用いる減衰定数については、地盤と構造物の非線形性を考慮して適切に設定する。</p>	<p>建物・構築物の動的解析においては、地下水排水設備による地下水位の低下を考慮して適切な解析手法を選定する。ここで、地震時の地盤の有効応力の変化に応じた影響を考慮する場合は、有効応力解析を実施する。有効応力解析に用いる液状化強度特性は、敷地の原地盤における代表性及び網羅性を踏まえた上で保守性を考慮して設定することを基本とする。</p> <p>動的解析に用いる解析モデルは、地震観測網により得られた観測記録により振動性状の把握を行い、解析モデルの妥当性の確認を行う。</p> <p>建物・構築物のうち土木構造物の動的解析に当たっては、構造物と地盤の相互作用を考慮できる連成系の地震応答解析手法を用いる。地震応答解析手法は、地盤及び構造物の地震時における非線形挙動の有無や程度に応じて、線形、等価線形又は非線形解析のいずれかによる。地盤の地震応答解析モデルは、構造物と地盤の動的相互作用を考慮できる有限要素法を用いる。構造物の地震応答解析に用いる減衰定数については、地盤と構造物の非線形性を考慮して適切に設定する。</p>
<p>(重大事故等対処施設に係る基本設計方針については、重大事故等対処施設の詳細設計の対象となる申請書で示す。)</p>	<p>(重大事故等対処施設に係る基本設計方針については、重大事故等対処施設の詳細設計の対象となる申請書で示す。)</p>
<p>地震③ - 8 地震③ - 9 地震③ - 10</p> <p>ロ. 機器・配管系</p> <p>動的解析による地震力の算定に当たっては、地震応答解析手法の適用性、適用限界等を考慮のうち、適切な解析法を選定するとともに、解析条件として考慮すべき減衰定数、剛性等の各種物性値は、適切な規格及び基準又は試験等の結果に基づき設定する。</p> <p style="text-align: center;">既設工認 添付書類IV-1-2-2 (第1回申請)</p>	<p>ロ. 機器・配管系</p> <p>動的解析による地震力の算定に当たっては、地震応答解析手法の適用性、適用限界等を考慮のうち、適切な解析法を選定するとともに、解析条件として考慮すべき減衰定数、剛性等の各種物性値は、適切な規格及び基準又は試験等の結果に基づき設定する。</p>
<p>地震③ - 8 地震③ - 9</p> <p>機器については、形状、構造特性等を考慮して、代表的な振動モードを適切に表現できるよう質点系モデル、有限要素モデル等に置換し、設計用床応答曲線を用いたスペクトルモーダル解析法又は時刻歴応答解析法により応答を求めるとともに、</p> <p style="text-align: center;">既設工認 添付書類IV-1-2-2 (第1回申請)</p>	<p>機器については、形状、構造特性等を考慮して、代表的な振動モードを適切に表現できるよう質点系モデル、有限要素モデル等に置換し、設計用床応答曲線を用いたスペクトルモーダル解析法又は時刻歴応答解析法により応答を求めるとともに、</p>
<p>地震⑥ - 2</p> <p>また、時刻歴応答解析法及びスペクトルモーダル解析法を用いる場合は地盤物性等のばらつきを適切に考慮する。スペクトルモーダル解析法には地盤物性等のばらつきを考慮した床応答曲線を用いる。</p> <p style="text-align: center;">既設工認 添付書類IV-1-2-5 (第2回申請)</p>	<p>また、時刻歴応答解析法及びスペクトルモーダル解析法を用いる場合は地盤物性等のばらつきを適切に考慮する。スペクトルモーダル解析法には地盤物性等のばらつきを考慮した床応答曲線を用いる。</p>
<p>地震③ - 8 地震③ - 9</p> <p>配管系については、適切なモデルを作成し、設計用床応答曲線を用いたスペクトルモーダル解析法により応答を求めるとともに、</p> <p style="text-align: center;">既設工認 添付書類IV-1-2-2 (第1回申請)</p>	<p>配管系については、適切なモデルを作成し、設計用床応答曲線を用いたスペクトルモーダル解析法により応答を求めるとともに、</p>

変更前記載事項の既設工認等との紐づけ (10/19)

	変 更 前	変 更 後
地震③ - 8 地震⑥ - 2	<p>スペクトルモーダル解析法及び時刻歴応答解析法の選択に当たっては、衝突・すべり等の非線形現象を模擬する観点又は既往研究の知見を取り入れ実機の挙動を模擬する観点で、建物・構築物の剛性及び地盤物性のばらつきへの配慮をしつつ時刻歴応答解析法を用いる等、解析対象とする現象、対象設備の振動特性・構造特性等を考慮し適切に選定する。</p> <p>既設工認 添付書類IV-1-2-2 (第1回申請), 添付書類IV-1-2-5 (第2回申請)</p>	<p>スペクトルモーダル解析法及び時刻歴応答解析法の選択に当たっては、衝突・すべり等の非線形現象を模擬する観点又は既往研究の知見を取り入れ実機の挙動を模擬する観点で、建物・構築物の剛性及び地盤物性のばらつきへの配慮をしつつ時刻歴応答解析法を用いる等、解析対象とする現象、対象設備の振動特性・構造特性等を考慮し適切に選定する。</p>
地震⑩ - 1 地震⑩ - 2	<p>また、設備の3次元的な広がりを踏まえ、適切に応答を評価できるモデルを用い、水平2方向及び鉛直方向の応答成分について適切に組み合わせるものとする。</p> <p>既設工認 添付書類IV-1-2-8 (第2回申請)</p>	<p>また、設備の3次元的な広がりを踏まえ、適切に応答を評価できるモデルを用い、水平2方向及び鉛直方向の応答成分について適切に組み合わせるものとする。</p>
地震① - 17	<p>なお、剛性の高い機器・配管系は、その設置床面の最大床応答加速度の1.2倍の加速度を静的に作用させて地震力を算定する。</p> <p>既設工認 添付書類IV-1-1 (第1回申請)</p>	<p>なお、剛性の高い機器・配管系は、その設置床面の最大床応答加速度の1.2倍の加速度を静的に作用させて地震力を算定する。</p>
地震③ - 10	<p>c. 設計用減衰定数</p> <p>地震応答解析に用いる減衰定数は、安全上適切と認められる規格及び基準に基づき、設備の種類、構造等により適切に選定するとともに、試験等で妥当性を確認した値も用いる。</p> <p>既設工認 添付書類IV-1-2-2 (第1回申請)</p>	<p>c. 設計用減衰定数</p> <p>地震応答解析に用いる減衰定数は、安全上適切と認められる規格及び基準に基づき、設備の種類、構造等により適切に選定するとともに、試験等で妥当性を確認した値も用いる。</p>
地震③ - 3 地震③ - 6	<p>なお、建物・構築物の地震応答解析に用いる鉄筋コンクリートの減衰定数の設定については、既往の知見に加え、既設施設の地震観測記録等により、その妥当性を検討する。</p> <p>既設工認 添付書類IV-1-2-2 (第1回申請)</p>	<p>なお、建物・構築物の地震応答解析に用いる鉄筋コンクリートの減衰定数の設定については、既往の知見に加え、既設施設の地震観測記録等により、その妥当性を検討する。</p>
地震③ - 6	<p>また、地盤と土木建造物の連成系地震応答解析モデルの減衰定数については、地中建造物としての特徴、同モデルの振動特性を考慮して適切に設定する。</p> <p>既設工認 添付書類IV-1-2-2 (第1回申請)</p>	<p>また、地盤と土木建造物の連成系地震応答解析モデルの減衰定数については、地中建造物としての特徴、同モデルの振動特性を考慮して適切に設定する。</p>
	<p>(4) 荷重の組合せと許容限界</p> <p>耐震設計における荷重の組合せと許容限界は、以下によるものとする。</p> <p>既設工認 添付書類IV-1-1 (第1回申請) 添付書類IV-1-2-3 (第1回申請)</p>	<p>(4) 荷重の組合せと許容限界</p> <p>耐震設計における荷重の組合せと許容限界は、以下によるものとする。</p>
地震① - 41 地震④ - 3 地震④ - 4 地震④ - 5	<p>また、耐震設計においては、安全機能である閉じ込め機能、プロセス量等の維持機能、掃気機能、崩壊熱等の除去機能、臨界防止機能、遮蔽機能、落下・転倒防止機能、支援機能、ソースターム制限機能、放出量の監視機能、換気機能、支持機能等を維持する設計とする。</p> <p>上記の機能のうち、遮蔽機能、落下・転倒防止機能、支持機能等については、安全機能を有する施設の耐震重要度に応じた地震力に対して、当該機能が要求される施設の構造強度を確保すること</p>	<p>また、耐震設計においては、安全機能である閉じ込め機能、プロセス量等の維持機能、掃気機能、崩壊熱等の除去機能、臨界防止機能、遮蔽機能、落下・転倒防止機能、支援機能、ソースターム制限機能、放出量の監視機能、換気機能、支持機能等を維持する設計とする。</p> <p>上記の機能のうち、遮蔽機能、落下・転倒防止機能、支持機能等については、安全機能を有する施設の耐震重要度に応じた地震力に対して、当該機能が要求される施設の構造強度を確保すること</p>

変更前記載事項の既設工認等との紐づけ (11/19)

	変 更 前	変 更 後
	<p>で、機能が維持できる設計とする。</p> <p>閉じ込め機能、プロセス量等の維持機能、掃気機能、崩壊熱等の除去機能、臨界防止機能、支援機能、ソースターム制限機能、放出量の監視機能、換気機能等については、構造強度を確保するとともに、当該機能が要求される各施設の特性に応じて許容限界を適切に設定する。</p> <p>(重大事故等対処施設に係る基本設計方針については、重大事故等対処施設の詳細設計の対象となる申請書で示す。)</p>	<p>で、機能が維持できる設計とする。</p> <p>閉じ込め機能、プロセス量等の維持機能、掃気機能、崩壊熱等の除去機能、臨界防止機能、支援機能、ソースターム制限機能、放出量の監視機能、換気機能等については、構造強度を確保するとともに、当該機能が要求される各施設の特性に応じて許容限界を適切に設定する。</p> <p>(重大事故等対処施設に係る基本設計方針については、重大事故等対処施設の詳細設計の対象となる申請書で示す。)</p>
地震① - 18	<p>a. 耐震設計上考慮する状態</p> <p>既設工認 添付書類IV-1-1(第1回申請)</p> <p>地震以外に設計上考慮する状態を以下に示す。</p>	<p>a. 耐震設計上考慮する状態</p> <p>地震以外に設計上考慮する状態を以下に示す。</p>
	<p>(a) 安全機能を有する施設</p> <p>イ. 建物・構築物</p> <p>(イ) 運転時の状態</p>	<p>(a) 安全機能を有する施設</p> <p>イ. 建物・構築物</p> <p>(イ) 運転時の状態</p>
地震① - 19	<p>再処理施設が運転している状態。</p> <p>既設工認 添付書類IV-1-1(第1回申請)</p>	<p>再処理施設が運転している状態。</p>
	<p>(ロ) 設計用自然条件</p> <p>設計上基本的に考慮しなければならない自然条件 (積雪, 風)。</p>	<p>(ロ) 設計用自然条件</p> <p>設計上基本的に考慮しなければならない自然条件 (積雪, 風)。</p>
地震① - 20	<p>ロ. 機器・配管系</p> <p>既設工認 添付書類IV-1-1(第1回申請)</p> <p>(イ) 運転時の状態</p>	<p>ロ. 機器・配管系</p> <p>(イ) 運転時の状態</p>
地震① - 21	<p>再処理施設が運転している状態。</p> <p>既設工認 添付書類IV-1-1(第1回申請)</p>	<p>再処理施設が運転している状態。</p>
	<p>(ロ) 運転時の異常な過渡変化時の状態</p> <p>運転時に予想される機械又は器具の単一の故障若しくはその誤作動又は運転員の単一の誤操作及びこれらと類似の頻度で発生すると予想される外乱によって発生する異常な状態であって、当該状態が継続した場合には温度, 圧力, 流量その他の再処理施設の状態を示す事項が安全設計上許容される範囲を超えるおそれがあるものとして安全設計上想定すべき事象が発生した状態。</p> <p>既設工認 添付書類IV-1-1(第1回申請)</p>	<p>(ロ) 運転時の異常な過渡変化時の状態</p> <p>運転時に予想される機械又は器具の単一の故障若しくはその誤作動又は運転員の単一の誤操作及びこれらと類似の頻度で発生すると予想される外乱によって発生する異常な状態であって、当該状態が継続した場合には温度, 圧力, 流量その他の再処理施設の状態を示す事項が安全設計上許容される範囲を超えるおそれがあるものとして安全設計上想定すべき事象が発生した状態。</p>
地震① - 31	<p>(ハ) 設計基準事故時の状態</p> <p>発生頻度が運転時の異常な過渡変化より低い異常な状態であって、当該状態が発生した場合には再処理施設から多量の放射性物質が放出するおそれがあるものとして安全設計上想定すべき事象が発生した状態。</p> <p>既設工認 添付書類IV-1-1(第1回申請)</p>	<p>(ハ) 設計基準事故時の状態</p> <p>発生頻度が運転時の異常な過渡変化より低い異常な状態であって、当該状態が発生した場合には再処理施設から多量の放射性物質が放出するおそれがあるものとして安全設計上想定すべき事象が発生した状態。</p>
地震① - 31	<p>(重大事故等対処施設に係る基本設計方針については、重大事故等対処施設の詳細設計の対象となる申請書で示す。)</p>	<p>(b) 重大事故等対処施設</p> <p>(重大事故等対処施設に係る基本設計方針については、重大事故等対処施設の詳細設計の対象となる申請書で示す。)</p>

変更前記載事項の既設工認等との紐づけ (12/19)

	変 更 前	変 更 後
地震① - 22	b. 荷重の種類 (a) 安全機能を有する施設 イ. 建物・構築物 (イ) 再処理施設のおかれている状態にかかわらず常時作用している荷重, すなわち固定荷重, 積載荷重, 土圧及び水圧	b. 荷重の種類 (a) 安全機能を有する施設 イ. 建物・構築物 (イ) 再処理施設のおかれている状態にかかわらず常時作用している荷重, すなわち固定荷重, 積載荷重, 土圧及び水圧
地震① - 23	(ロ) 運転時の状態で施設に作用する荷重	(ロ) 運転時の状態で施設に作用する荷重
地震① - 24	(ハ) 地震力, 積雪荷重及び風荷重 ただし, 運転時の状態で施設に作用する荷重には, 機器・配管系から作用する荷重が含まれるものとし, 地震力には, 地震時土圧, 地震時水圧及び機器・配管系からの反力が含まれるものとする。	(ハ) 地震力, 積雪荷重及び風荷重 ただし, 運転時の状態で施設に作用する荷重には, 機器・配管系から作用する荷重が含まれるものとし, 地震力には, 地震時土圧, 地震時水圧及び機器・配管系からの反力が含まれるものとする。
地震① - 25	ロ. 機器・配管系 (イ) 運転時の状態で施設に作用する荷重	ロ. 機器・配管系 (イ) 運転時の状態で施設に作用する荷重
地震① - 31	(ロ) 運転時の異常な過渡変化時の状態で施設に作用する荷重	(ロ) 運転時の異常な過渡変化時の状態で施設に作用する荷重
地震① - 31	(ハ) 設計基準事故時の状態で施設に作用する荷重	(ハ) 設計基準事故時の状態で施設に作用する荷重
地震① - 26	(ニ) 地震力 (重大事故等対処施設に係る基本設計方針については, 重大事故等対処施設の詳細設計の対象となる申請書で示す。)	(ニ) 地震力 ただし, 各状態において施設に作用する荷重には, 常時作用している荷重, すなわち自重等の固定荷重が含まれるものとする。また, 屋外に設置される施設については, 建物・構築物に準じる。 (b) 重大事故等対処施設 (重大事故等対処施設に係る基本設計方針については, 重大事故等対処施設の詳細設計の対象となる申請書で示す。)

変更前記載事項の既設工認等との紐づけ (13/19)

変 更 前	変 更 後
<p>c. 荷重の組合せ</p> <p>地震力と他の荷重との組合せについては、「3.3 外部からの衝撃による損傷の防止」で設定している風及び積雪による荷重を考慮し、以下のとおり設定する。</p> <p style="text-align: right;">既設工認 添付書類IV-1-1 (第1回申請)</p>	<p>c. 荷重の組合せ</p> <p>地震力と他の荷重との組合せについては、「3.3 外部からの衝撃による損傷の防止」で設定している風及び積雪による荷重を考慮し、以下のとおり設定する。</p>
<p>(a) 安全機能を有する施設</p> <p>イ. 建物・構築物</p> <p>(イ) Sクラスの建物・構築物については、常時作用している荷重(固定荷重, 積載荷重, 土圧及び水圧), 運転時の状態で施設に作用する荷重, 積雪荷重及び風荷重と基準地震動による地震力とを組み合わせる。</p> <p>(ロ) Sクラス, Bクラス及びCクラスの建物・構築物については、常時作用している荷重(固定荷重, 積載荷重, 土圧及び水圧), 運転時の状態で施設に作用する荷重, 積雪荷重及び風荷重と基準地震動以外の地震動による地震力又は静的地震力とを組み合わせる。</p> <p style="text-align: right;">既設工認 添付書類IV-1-1 (第1回申請)</p>	<p>(a) 安全機能を有する施設</p> <p>イ. 建物・構築物</p> <p>(イ) Sクラスの建物・構築物については、常時作用している荷重(固定荷重, 積載荷重, 土圧及び水圧), 運転時の状態で施設に作用する荷重, 積雪荷重及び風荷重と基準地震動 S_s による地震力とを組み合わせる。</p> <p>(ロ) Sクラス, Bクラス及びCクラスの建物・構築物については、常時作用している荷重(固定荷重, 積載荷重, 土圧及び水圧), 運転時の状態で施設に作用する荷重, 積雪荷重及び風荷重と基準地震動 S_s 以外の地震動による地震力又は静的地震力とを組み合わせる。</p>
<p>ロ. 機器・配管系</p> <p>(イ) Sクラスの機器・配管系については、常時作用している荷重, 運転時の状態で施設に作用する荷重, 運転時の異常な過渡変化時に生じる荷重, 設計基準事故時に生じる荷重と基準地震動による地震力, 弾性設計用地震動による地震力又は静的地震力とを組み合わせる。</p> <p style="text-align: right;">既設工認 添付書類IV-1-1 (第1回申請)</p>	<p>この際、常時作用している荷重のうち、土圧及び水圧について、基準地震動 S_s による地震力又は弾性設計用地震動 S_d による地震力と組み合わせる場合は、当該地震時の土圧及び水圧とする。</p> <p>ロ. 機器・配管系</p> <p>(イ) Sクラスの機器・配管系については、常時作用している荷重, 運転時の状態で施設に作用する荷重, 運転時の異常な過渡変化時に生じる荷重, 設計基準事故時に生じる荷重と基準地震動 S_s による地震力, 弾性設計用地震動 S_d による地震力又は静的地震力とを組み合わせる。</p>
<p>(ロ) Bクラスの機器・配管系については、常時作用している荷重, 運転時の状態で施設に作用する荷重, 運転時の異常な過渡変化時に生じる荷重と共振影響検討用の地震動による地震力又は静的地震力とを組み合わせる。</p> <p>(ハ) Cクラスの機器・配管系については、常時作用している荷重, 運転時の状態で施設に作用する荷重, 運転時の異常な過渡変化時に生じる荷重と静的地震力とを組み合わせる。</p>	<p>(ロ) Bクラスの機器・配管系については、常時作用している荷重, 運転時の状態で施設に作用する荷重, 運転時の異常な過渡変化時に生じる荷重と共振影響検討用の地震動による地震力又は静的地震力とを組み合わせる。</p> <p>(ハ) Cクラスの機器・配管系については、常時作用している荷重, 運転時の状態で施設に作用する荷重, 運転時の異常な過渡変化時に生じる荷重と静的地震力とを組み合わせる。</p>

地震① - 27

地震① - 28

地震① - 20

地震① - 29

地震① - 31

地震① - 29

地震① - 31

変更前記載事項の既設工認等との紐づけ (14/19)

変 更 前	変 更 後
<p>(重大事故等対処施設に係る基本設計方針については、重大事故等対処施設の詳細設計の対象となる申請書で示す。)</p> <p>(c) 荷重の組合せ上の留意事項</p> <p style="text-align: right;">既設工認 添付書類IV-1-1(第1回申請)</p> <p>イ. 安全機能を有する施設のうち耐震重要度の異なる施設を支持する建物・構築物の当該部分の支持機能を確認する場合においては、支持される施設の耐震重要度に応じた地震力と常時作用している荷重、運転時に施設に作用する荷重とを組み合わせる。</p> <p>ロ. 安全機能を有する施設のうち機器・配管系の運転時の異常な過渡変化時及び設計基準事故(以下「事故等」という。)時に生じるそれぞれの荷重については、地震によって引き起こされるおそれのある事故等によって作用する荷重及び地震によって引き起こされるおそれのない事故等であっても、いったん事故等が発生した場合、長時間継続する事故等による荷重は、その事故等の発生確率、継続時間及び地震動の超過確率の関係を踏まえ、適切な地震力と組み合わせて考慮する。</p> <p style="text-align: right;">既設工認 添付書類IV-1-1(第1回申請)</p> <p>ニ. 積雪荷重については、屋外に設置されている安全機能を有する施設のうち、積雪による受圧面積が小さい施設や、常時作用している荷重に対して積雪荷重の割合が無視できる施設を除き、地震力との組合せを考慮する。</p> <p>ホ. 風荷重については、屋外の直接風を受ける場所に設置されている安全機能を有する施設のうち、風荷重の影響が地震荷重と比べて相対的に無視できないような構造、形状及び仕様の施設においては、地震力との組合せを考慮する。</p> <p style="text-align: right;">既設工認 添付書類IV-1-1 (第1回申請)</p> <p>(重大事故等対処施設に係る基本設計方針については、重大事故等対処施設の詳細設計の対象となる申請書で示す。)</p>	<p>なお、屋外に設置される施設については、建物・構築物と同様に積雪荷重及び風荷重を組み合わせる。</p> <p>(b) 重大事故等対処施設 (重大事故等対処施設に係る基本設計方針については、重大事故等対処施設の詳細設計の対象となる申請書で示す。)</p> <p>(c) 荷重の組合せ上の留意事項</p> <p>イ. 安全機能を有する施設のうち耐震重要度の異なる施設を支持する建物・構築物の当該部分の支持機能を確認する場合においては、支持される施設の耐震重要度に応じた地震力と常時作用している荷重、運転時に施設に作用する荷重とを組み合わせる。</p> <p>ロ. 安全機能を有する施設のうち機器・配管系の運転時の異常な過渡変化時及び設計基準事故(以下「事故等」という。)時に生じるそれぞれの荷重については、地震によって引き起こされるおそれのある事故等によって作用する荷重及び地震によって引き起こされるおそれのない事故等であっても、いったん事故等が発生した場合、長時間継続する事故等による荷重は、その事故等の発生確率、継続時間及び地震動の超過確率の関係を踏まえ、適切な地震力と組み合わせて考慮する。</p> <p>ハ. 安全機能を有する施設に適用する動的地震力は、水平 2 方向及び鉛直方向について適切に組み合わせるものとする。</p> <p>ニ. 積雪荷重については、屋外に設置されている安全機能を有する施設のうち、積雪による受圧面積が小さい施設や、常時作用している荷重に対して積雪荷重の割合が無視できる施設を除き、地震力との組合せを考慮する。</p> <p>ホ. 風荷重については、屋外の直接風を受ける場所に設置されている安全機能を有する施設のうち、風荷重の影響が地震荷重と比べて相対的に無視できないような構造、形状及び仕様の施設においては、地震力との組合せを考慮する。</p> <p>ヘ. 荷重として考慮する水圧のうち地下水圧については、地下水排水設備による地下水位の低下を踏まえた設計用地下水位に基づき設定する。</p> <p>(重大事故等対処施設に係る基本設計方針については、重大事故等対処施設の詳細設計の対象となる申請書で示す。)</p>

地震① - 31

地震① - 31

地震① - 28

地震① - 20

変更前記載事項の既設工認等との紐づけ (15/19)

	変 更 前	変 更 後
地震① - 32	<p>d. 許容限界</p> <p>各施設の地震力と他の荷重とを組み合わせた状態に対する許容限界は、以下のとおりとし、安全上適切と認められる規格及び基準又は試験等で妥当性が確認されている値を用いる。</p> <p>既設工認 添付書類IV-1-1 (第1回申請)</p>	<p>d. 許容限界</p> <p>各施設の地震力と他の荷重とを組み合わせた状態に対する許容限界は、以下のとおりとし、安全上適切と認められる規格及び基準又は試験等で妥当性が確認されている値を用いる。</p>
地震① - 34	<p>(a) 安全機能を有する施設</p> <p>イ. 建物・構築物</p> <p>(イ) Sクラスの建物・構築物 (土木構造物を除く。)</p> <p>i. 基準地震動による地震力との組合せに対する許容限界</p> <p>建物・構築物全体としての変形能力 (耐震壁のせん断ひずみ等) が終局耐力時の変形に対して十分な余裕を有し、部材・部位ごとのせん断ひずみ・応力等が終局耐力時のせん断ひずみ・応力等に対して、妥当な安全余裕を有することとする。</p> <p>なお、終局耐力とは、建物・構築物に対する荷重又は応力を漸次増大していくとき、その変形又はひずみが著しく増加するに至る限界の最大耐力とし、既往の実験式等に基づき適切に定めるものとする。</p> <p>既設工認 添付書類IV-1-1 (第1回申請)</p>	<p>(a) 安全機能を有する施設</p> <p>イ. 建物・構築物</p> <p>(イ) Sクラスの建物・構築物 (土木構造物を除く。)</p> <p>i. 基準地震動 S_s による地震力との組合せに対する許容限界</p> <p>建物・構築物全体としての変形能力 (耐震壁のせん断ひずみ等) が終局耐力時の変形に対して十分な余裕を有し、部材・部位ごとのせん断ひずみ・応力等が終局耐力時のせん断ひずみ・応力等に対して、妥当な安全余裕を有することとする。</p> <p>なお、終局耐力とは、建物・構築物に対する荷重又は応力を漸次増大していくとき、その変形又はひずみが著しく増加するに至る限界の最大耐力とし、既往の実験式等に基づき適切に定めるものとする。</p>
地震① - 33	<p>ii. 弾性設計用地震動による地震力又は静的地震力との組合せに対する許容限界</p> <p>Sクラスの建物・構築物については、地震力に対しておおむね弾性状態に留まるように、発生する応力に対して、建築基準法等の安全上適切と認められる規格及び基準による許容応力度を許容限界とする。</p> <p>既設工認 添付書類IV-1-1 (第1回申請)</p>	<p>ii. 弾性設計用地震動 S_d による地震力又は静的地震力との組合せに対する許容限界</p> <p>Sクラスの建物・構築物については、地震力に対しておおむね弾性状態に留まるように、発生する応力に対して、建築基準法等の安全上適切と認められる規格及び基準による許容応力度を許容限界とする。</p>
地震① - 35	<p>(ロ) Bクラス及びCクラスの建物・構築物 (土木構造物を除く。)</p> <p>上記(イ) ii. による許容応力度を許容限界とする。</p> <p>既設工認 添付書類IV-1-1 (第1回申請)</p>	<p>(ロ) Bクラス及びCクラスの建物・構築物 (土木構造物を除く。)</p> <p>上記(イ) ii. による許容応力度を許容限界とする。</p>
地震① - 37	<p>(ハ) 建物・構築物の保有水平耐力</p> <p>建物・構築物 (土木構造物を除く。) については、当該建物・構築物の保有水平耐力が必要保有水平耐力に対して、耐震重要度に応じた適切な安全余裕を有していることを確認する。</p> <p>既設工認 添付書類IV-1-1 (第1回申請)</p>	<p>(ハ) 建物・構築物の保有水平耐力</p> <p>建物・構築物 (土木構造物を除く。) については、当該建物・構築物の保有水平耐力が必要保有水平耐力に対して、耐震重要度に応じた適切な安全余裕を有していることを確認する。</p>

変更前記載事項の既設工認等との紐づけ (16/19)

	変 更 前	変 更 後
地震① - 34	<p>(ニ) 屋外重要土木構造物</p> <p>i. 基準地震動による地震力との組合せに対する許容限界 構造部材の曲げについては限界層間変形角(層間変形角 1/100)又は終局曲率, せん断についてはせん断耐力を許容限界とする。 なお, 限界層間変形角, 終局曲率及びせん断耐力の許容限界に対しては妥当な安全余裕を持たせることとする。</p> <p>既設工認 添付書類IV-1-1 (第 1 回申請)</p>	<p>(ニ) 屋外重要土木構造物</p> <p>i. 基準地震動 S_s による地震力との組合せに対する許容限界 構造部材の曲げについては限界層間変形角(層間変形角 1/100)又は終局曲率, せん断についてはせん断耐力を許容限界とする。 なお, 限界層間変形角, 終局曲率及びせん断耐力の許容限界に対しては妥当な安全余裕を持たせることとする。</p>
地震① - 33	<p>ii. 弾性設計用地震動による地震力又は静的地震力との組合せに対する許容限界 地震力に対しておおむね弾性状態に留まるように, 発生する応力に対して, 安全上適切と認められる規格及び基準による許容応力度を許容限界とする。</p> <p>既設工認 添付書類IV-1-1 (第 1 回申請)</p>	<p>ii. 弾性設計用地震動 S_d による地震力又は静的地震力との組合せに対する許容限界 地震力に対しておおむね弾性状態に留まるように, 発生する応力に対して, 安全上適切と認められる規格及び基準による許容応力度を許容限界とする。</p>
地震① - 35	<p>(ホ) その他の土木構造物 安全上適切と認められる規格及び基準による許容応力度を許容限界とする。</p> <p>既設工認 添付書類IV-1-1 (第 1 回申請)</p>	<p>(ホ) その他の土木構造物 安全上適切と認められる規格及び基準による許容応力度を許容限界とする。</p>
	<p>ロ. 機器・配管系</p> <p>(イ) Sクラスの機器・配管系</p>	<p>ロ. 機器・配管系</p> <p>(イ) Sクラスの機器・配管系</p>
地震① - 39	<p>i. 基準地震動による地震力との組合せに対する許容限界 塑性域に達するひずみが生じる場合であっても, その量が小さなレベルに留まって破断延性限界に十分な余裕を有し, その施設の機能に影響を及ぼすことがない限度に応力, 荷重を制限する値を許容限界とする。</p> <p>既設工認 添付書類IV-1-1 (第 1 回申請)</p>	<p>i. 基準地震動 S_s による地震力との組合せに対する許容限界 塑性域に達するひずみが生じる場合であっても, その量が小さなレベルに留まって破断延性限界に十分な余裕を有し, その施設の機能に影響を及ぼすことがない限度に応力, 荷重を制限する値を許容限界とする。</p>
地震① - 38	<p>ii. 弾性設計用地震動による地震力又は静的地震力との組合せに対する許容限界 発生する応力に対して, 応答が全体的におおむね弾性状態に留まるように, 降伏応力又はこれと同等の安全性を有する応力を許容限界とする。</p> <p>既設工認 添付書類IV-1-1 (第 1 回申請)</p>	<p>ii. 弾性設計用地震動 S_d による地震力又は静的地震力との組合せに対する許容限界 発生する応力に対して, 応答が全体的におおむね弾性状態に留まるように, 降伏応力又はこれと同等の安全性を有する応力を許容限界とする。</p>

変更前記載事項の既設工認等との紐づけ (17/19)

	変更前	変更後
地震① - 40	<p>(ロ) Bクラス及びCクラスの機器・配管系 上記(イ) ii. による応力を許容限界とする。</p> <p>既設工認 添付書類IV-1-1(第1回申請)</p>	<p>(ロ) Bクラス及びCクラスの機器・配管系 上記(イ) ii. による応力を許容限界とする。</p>
	<p>(重大事故等対処施設に係る基本設計方針については、重大事故等対処施設の詳細設計の対象となる申請書で示す。)</p> <p>既設工認 添付書類IV-1-1(第1回申請) 添付書類IV-1-2-3(第1回申請)</p>	<p>(b) 重大事故等対処施設 (重大事故等対処施設に係る基本設計方針については、重大事故等対処施設の詳細設計の対象となる申請書で示す。)</p>
地震① - 36 地震④ - 1	<p>(5) 設計における留意事項</p> <p>a. 主要設備等，補助設備，直接支持構造物及び間接支持構造物 主要設備等，補助設備及び直接支持構造物については，耐震重要度に応じた地震力に十分耐えられる設計とするとともに，安全機能を有する施設のうち，耐震重要施設に該当する設備は，基準地震動による地震力に対してその安全機能が損なわれるおそれがない設計とする。</p>	<p>(5) 設計における留意事項</p> <p>a. 主要設備等，補助設備，直接支持構造物及び間接支持構造物 主要設備等，補助設備及び直接支持構造物については，耐震重要度に応じた地震力に十分耐えられる設計とするとともに，安全機能を有する施設のうち，耐震重要施設に該当する設備は，基準地震動 S s による地震力に対してその安全機能が損なわれるおそれがない設計とする。</p>
地震① - 36 地震④ - 1	<p>また，間接支持構造物については，支持する主要設備等又は補助設備の耐震重要度に適用する地震動による地震力に対して支持機能が損なわれない設計とする。</p> <p>既設工認 添付書類IV-1-1(第1回申請) 添付書類IV-1-2-3(第1回申請)</p>	<p>また，間接支持構造物については，支持する主要設備等又は補助設備の耐震重要度に適用する地震動による地震力に対して支持機能が損なわれない設計とする。</p>
地震② - 5	<p>b. 波及的影響に対する考慮 耐震重要施設は，耐震重要度の下位のクラスに属する施設の波及的影響によって，その安全機能が損なわれないものとする。</p> <p>既設工認 添付書類IV-1-2-1(第1回申請)</p>	<p>b. 波及的影響に対する考慮 耐震重要施設は，耐震重要度の下位のクラスに属する施設の波及的影響によって，その安全機能が損なわれないものとする。</p> <p>評価に当たっては，以下の4つの観点をもとに，敷地全体を俯瞰した調査・検討を行い，各観点より選定した事象に対する波及的影響の評価により波及的影響を考慮すべき施設を抽出し，耐震重要施設の安全機能への影響がないことを確認する。</p> <p>波及的影響の評価に当たっては，耐震重要施設の設計に用いる地震動又は地震力を適用する。なお，地震動又は地震力の選定に当たっては，施設の配置状況，使用時間を踏まえて適切に設定する。また，波及的影響の確認においては水平2方向及び鉛直方向の地震力が同時に作用する場合に影響を及ぼす可能性のある施設，設備を選定し評価する。</p> <p>ここで，下位クラス施設とは，耐震重要施設以外の再処理施設内にある施設（資機材等含む。）をいう。</p>

変更前記載事項の既設工認等との紐づけ (18/19)

変 更 前	変 更 後
<p>(b) 耐震重要施設と下位クラス施設との接続部における相互影響</p> <div style="border: 2px solid blue; padding: 5px; margin: 10px 0;"> <p>耐震重要施設の設計に用いる地震動又は地震力に対して、耐震重要施設に接続する下位クラス施設の損傷により、耐震重要施設の安全機能への影響がないことを確認する。</p> <p style="text-align: right;">既設工認 添付書類IV-1-2-3 (第1回申請)</p> </div> <p>(重大事故等対処施設に係る基本設計方針については、重大事故等対処施設の詳細設計の対象となる申請書で示す。)</p>	<p>波及的影響を防止するよう現場を維持するため、機器設置時の配慮事項等を保安規定に定めて、管理する。</p> <p>なお、原子力施設及び化学プラント等の地震被害情報をもとに、4つの観点以外に検討すべき事項がないか確認し、新たな検討事項が抽出された場合には、その観点を追加する。</p> <p>(a) 設置地盤及び地震応答性状の相違に起因する相対変位又は不等沈下による影響</p> <p>イ. 不等沈下 耐震重要施設の設計に用いる地震動又は地震力に対して不等沈下により、耐震重要施設の安全機能への影響がないことを確認する。</p> <p>ロ. 相対変位 耐震重要施設の設計に用いる地震動又は地震力による下位クラス施設と耐震重要施設の相対変位により、耐震重要施設の安全機能への影響がないことを確認する。</p> <p>(b) 耐震重要施設と下位クラス施設との接続部における相互影響</p> <p>耐震重要施設の設計に用いる地震動又は地震力に対して、耐震重要施設に接続する下位クラス施設の損傷により、耐震重要施設の安全機能への影響がないことを確認する。</p> <p>(c) 建屋内における下位クラス施設の損傷、転倒及び落下による耐震重要施設への影響</p> <p>耐震重要施設の設計に用いる地震動又は地震力に対して、建屋内の下位クラス施設の損傷、転倒及び落下により、耐震重要施設の安全機能への影響がないことを確認する。</p> <p>(d) 建屋外における下位クラス施設の損傷、転倒及び落下による耐震重要施設への影響</p> <p>耐震重要施設の設計に用いる地震動又は地震力に対して、建屋外の下位クラス施設の損傷、転倒及び落下により、耐震重要施設の安全機能への影響がないことを確認する。</p> <p>(重大事故等対処施設に係る基本設計方針については、重大事故等対処施設の詳細設計の対象となる申請書で示す。)</p>

地震④ - 2

変更前記載事項の既設工認等との紐づけ (19/19)

地震⑤ - 1

変 更 前	変 更 後
<p>c. 建物・構築物への地下水の影響</p> <p>耐震設計において地下水位の低下を期待する建物・構築物は、周囲の地下水を排水し、基礎スラブ底面レベル以深に地下水位を維持できるよう地下水排水設備（サブドレンポンプ、水位検出器等）を設置する。また、基準地震動 S_s による地震力に対して、必要な機能が保持できる設計とするとともに、非常用電源設備又は基準地震動 S_s による地震力に対し機能維持が可能な発電機からの給電が可能な設計とする。</p> <p style="text-align: right;">既設工認 本文（第2回申請）</p> <p>（重大事故等対処施設に係る基本設計方針については、重大事故等対処施設の詳細設計の対象となる申請書で示す。）</p> <p>(6) 緊急時対策所</p> <p>（緊急時対策所に係る基本設計方針については、緊急時対策所の詳細設計の対象となる申請書で示す。）</p> <p>（重大事故等対処施設に係る基本設計方針については、重大事故等対処施設の詳細設計の対象となる申請書で示す。）</p>	<p>c. 建物・構築物への地下水の影響</p> <p>耐震設計において地下水位の低下を期待する建物・構築物は、周囲の地下水を排水し、基礎スラブ底面レベル以深に地下水位を維持できるよう地下水排水設備（サブドレンポンプ、水位検出器等）を設置する。また、基準地震動 S_s による地震力に対して、必要な機能が保持できる設計とするとともに、非常用電源設備又は基準地震動 S_s による地震力に対し機能維持が可能な発電機からの給電が可能な設計とする。</p> <p>（重大事故等対処施設に係る基本設計方針については、重大事故等対処施設の詳細設計の対象となる申請書で示す。）</p> <p>d. 一関東評価用地震動（鉛直）</p> <p>基準地震動 $S_s - C4$ は、水平方向の地震動のみであることから、水平方向と鉛直方向の地震力を組み合わせた影響評価を行う場合には、工学的に水平方向の地震動から設定した鉛直方向の評価用地震動（以下「一関東評価用地震動（鉛直）」という。）による地震力を用いて、水平方向と鉛直方向の地震力を組み合わせた影響が考えられる施設に対して、許容限界の範囲内に留まることを確認する。</p> <p>(6) 緊急時対策所</p> <p>（緊急時対策所に係る基本設計方針については、緊急時対策所の詳細設計の対象となる申請書で示す。）</p> <p>(7) 地震による周辺斜面の崩壊に対する設計方針</p> <p>耐震重要施設については、基準地震動 S_s による地震力により周辺斜面の崩壊の影響がないことが確認された場所に設置する。</p> <p>なお、耐震重要施設周辺においては平坦な造成地であることから、地震力に対して、施設の安全機能に重大な影響を与えるような崩壊を起こすおそれのある斜面はない。</p> <p>（重大事故等対処施設に係る基本設計方針については、重大事故等対処施設の詳細設計の対象となる申請書で示す。）</p>

IV - 1 - 1 耐震設計の基本方針

0327

1. 耐震設計の原則

地震① - 1

再処理施設の耐震設計は、「再処理施設安全審査指針」に適合するように、下記の項目に従って行い、想定されるいかなる地震力に対してもこれが大きな事故の誘因とならないよう再処理施設に十分な耐震性をもたせる。

地震① - 2

(1) 建物・構築物は、十分な強度・剛性及び耐力を有する構造とする。

地震① - 3

(2) 重要な建物・構築物は、安定な地盤に支持させる。

地震① - 4

(3) 再処理施設の耐震設計上の重要度を、地震により発生する可能性のある放射線による環境への影響の観点からAクラス、Bクラス及びCクラスに分類し、それぞれ重要度に応じた耐震設計を行う。

地震① - 5

(4) 前項のA、B及びCクラスの施設は、各々の重要度に応じた層せん断力係数に基づく地震力に対して耐えるように設計する。

地震① - 6

(5) Aクラスの施設は、基準地震動 S_1 に基づいた動的解析から求められる地震力に対して耐えるように設計する。

Aクラスの施設のうち特に重要な施設を A_s クラスの施設と呼称し、それらの施設については、基準地震動 S_2 に基づいた動的解析から求められる地震力に対して、その安全機能が保持できるように設計する。

また、Bクラスの機器・配管等についても共振するおそれのあるものについては、動的解析を行う。

地震① - 7

(6) Aクラスの施設については、水平地震力と同時に、かつ、不利な方向に鉛直地震力が作用するものとする。

(7) その破損により臨界を引き起こす可能性のあるものは、基準地震動 S_2 による地震力に対し、臨界を引き起こさないことの確認を行う。

(8) 再処理施設の構造計画及び配置計画に際しては、地震の影響が低減されるように考慮する。

2. 耐震設計上の重要度分類

地震① - 8

再処理施設の耐震設計上の重要度を、次のように分類する。

(1) Aクラスの施設

以下に示す機能を有する施設であって、環境への影響、効果の大きいもの。

地震① - 9

a. 自ら放射性物質を内蔵しているか又は内蔵している施設に直接関係しており、その機能喪失により、放射性物質を外部に放散する可能性のあるもの又は放射線による環境への影響、効果のあるもの。

b. 放射性物質を外部に放散する可能性のある事態を防止するために必要なもの。

c. 上記のような事故発生の際に、外部に放散される放射性物質による影響を低減させるために必要なもの。

なお、Aクラスの施設のうち、特に重要と判断される施設を限定してA_sクラスの施設と呼称する。

(2) Bクラスの施設

地震① - 10

上記において、影響、効果が比較的小さいもの。

(3) Cクラスの施設

地震① - 11

Aクラス、Bクラス以外であって、一般産業施設と同等の安全性を保持すればよいもの。

地震① - 12

上記に基づく耐震設計上の重要度分類については、添付書類「重要度分類の基本方針」に示す。

なお、同添付書類には、当該施設を支持する建物・構築物の支持機能が維持されることを確認する地震動及び相互影響を考慮すべき設備に適用する地震動についても併記している。

3. 地震力の算定法

地震① - 13

設計用地震力は、以下の方法で算定される静的地震力及び動的地震力のうちいずれか大きい方とする。

3.1 静的地震力

地震① - 14

静的地震力は、Aクラス、Bクラス及びCクラスの施設に適用することとし、それぞれクラスに応じて以下の層せん断力係数及び震度に基づき算定する。

(1) 建物・構築物

地震① - 15

水平地震力は、再処理施設の重要度分類に応じて以下に述べる層せん断力係数に当該層以上の重量を乗じて算定するものとする。

Aクラス	層せん断力係数	3.0 C_1
Bクラス	層せん断力係数	1.5 C_1
Cクラス	層せん断力係数	1.0 C_1

ここに、層せん断力係数を算定する際の C_1 は、標準せん断力係数を0.2とし、建物・構築物の振動特性、地盤の種類等を考慮して求められる値とする。

Aクラスの施設については、鉛直地震力をも考慮することとし、水平地震力と鉛直地震力は、同時に不利な方向の組合せで作用するものとする。鉛直地震力は、震度0.3を基準とし、建物・構築物の振動特性、地盤の種類等を考慮して求めた鉛直震度より算定するものとする。ただし、鉛直震度は高さ方向に一定とする。

(2) 機器・配管等

地震① - 16

各クラスの地震力は、上記(1)の層せん断力係数の値から求める水平震度及び上記(1)の鉛直震度をそれぞれ20%増しとした震度より求めるものとする。なお、水平地震力と鉛直地震力とは同時に不利な方向の組合せで作用するものとする。ただし、鉛直震度は高さ方向に一定とする。

3.2 動的地震力

地震① - 17

動的地震力は、Aクラスの施設に適用することとし、基準地震動 S_1 から定める入力地震動を入力として、動的解析により算定する。

さらに、 A_s クラスの施設については、基準地震動 S_2 から定める入力地震動を入力として、動的解析により算定される水平地震力も適用する。

なお、Bクラスの機器・配管等のうち支持構造物の振動と共振のおそれのあるものについては、上記Aクラスの施設に適用する基準地震動 S_1 から定める入力地震動の振幅を1/2にしたものを入力として動的解析により算定される水平地震力を適用する。

Aクラスの施設に対する鉛直地震力は、基準地震動の最大加速度振幅の1/2の値を重力加速度で除した鉛直震度として求め、水平地震力と同時に不利な方向に組み合わせる。ただし、鉛直震度は高さ方向に一定とする。

なお、剛性の高い機器・配管等は、その設置床面の最大床応答加速度の1.2倍の加速度を静的に作用させて地震力を算定する。

動的解析の方法等については、添付書類「地震応答解析の基本方針」に示す。

4. 荷重の組合せと許容限界

4.1 耐震設計上考慮する状態

地震① - 18 地震以外に設計上考慮する状態を以下に示す。

(1) 建物・構築物

a. 通常運転時の状態

地震① - 19 再処理施設が、通常運転状態にあり、通常の自然条件下におかれている状態。

b. 設計用自然条件

地震① - 20 設計上基本的に考慮しなければならない自然条件。

(2) 機器・配管等

a. 通常運転時の状態

地震① - 21 再処理施設が、通常運転状態にある状態、ただし、インターロック又は警報が設置されている場合は、圧力及び温度がインターロック又は警報の設定値以内にある状態。

4.2 荷重の種類

(1) 建物・構築物

地震① - 22 a. 再処理施設のおかれている状態にかかわらず常時作用している荷重、すなわち固定荷重、積載荷重、土圧、水圧並びに通常の気象条件による荷重

地震① - 23 b. 通常運転時の状態で施設に作用する荷重

c. 地震力、風荷重

地震① - 24 ただし、通常運転時の状態で施設に作用する荷重には機器・配管等から作用する荷重が含まれるものとし、地震力には、地震時土圧、機器・配管等からの反力、スロッシング等による荷重が含まれるものとする。

(2) 機器・配管等

地震① - 25 a. 通常運転時の状態で施設に作用する荷重

地震① - 26 b. 地震力

4.3 荷重の組合せ

地震① - 27 地震力と他の荷重との組合せは以下による。

(1) 建物・構築物

地震① - 28 a. 地震力と常時作用している荷重及び通常運転時の状態で施設に作用する荷重とを組み合わせる。

(2) 機器・配管等

地震① - 29 a. 地震力と通常運転時の状態で施設に作用する荷重とを組み合わせる。

(3) 荷重の組合せ上の留意事項

地震① - 30 a. Aクラスの施設においては、水平地震力と鉛直地震力とは同時に不利な方向に作用するものとする。

地震① - 31 b. 耐震クラスの異なる施設を支持する建物・構築物の当該部分の支持機能を確認する場合においては、支持される施設の耐震クラスに応じた地震力と常時作用している荷重及び通常運転時の状態で施設に作用する荷重とを組み合わせる。

なお、運転時の異常な過渡変化時の状態及び運転時の異常な過渡変化を超える

0332

地震① - 31

事象時の状態で施設に作用する荷重は、通常運転時の状態で施設に作用する荷重を超えるもの及び長時間施設に作用するものがないため、地震荷重と組み合わせるものはない。

4.4 許容限界

地震① - 32

各施設の地震力と他の荷重とを組み合わせた状態に対する許容限界は、以下のとおりとする。

(1) 建物・構築物

a. A_s クラスの建物・構築物

地震① - 33

(a) 基準地震動 S_1 による地震力又は静的地震力との組合せに対する許容限界安全上適切と認められる規格及び基準による許容応力度を許容限界とする。

(b) 基準地震動 S_2 による地震力との組合せに対する許容限界

地震① - 34

建物・構築物が、構造物全体として十分変形能力（ねばり）の余裕を有し、終局耐力に対して安全余裕を持たせることとする。

なお、終局耐力は、建物・構築物に対する荷重又は応力を漸次増大していくとき、その変形又は歪が著しく増加するに至る限界の最大耐力とし、既往の実験式等に基づき適切に定めるものとする。

b. Aクラス（ A_s クラスを除く。）の建物・構築物

上記 a.(a) による許容応力度を許容限界とする。

c. B及びCクラスの建物・構築物

地震① - 35

上記 a.(a) による許容応力度を許容限界とする。

d. 耐震クラスの異なる施設を支持する建物・構築物

地震① - 36

上記 a.(b) の項を適用するほか、耐震クラスの異なる施設が、それを支持する建物・構築物の変形等に対して、その機能が損なわれないものとする。

e. 建物・構築物の保有水平耐力

地震① - 37

建物・構築物については、当該建物・構築物の保有水平耐力が必要保有水平耐力に対して重要度に応じた適切な安全余裕を有していることを確認するものとする。

(2) 機器・配管等

a. A_s クラスの機器・配管等

地震① - 38

(a) 基準地震動 S_1 による地震力又は静的地震力との組合せに対する許容限界降伏応力又はこれと同等の安全性を有する応力を許容限界とする。

(b) 基準地震動 S_2 による地震力との組合せに対する許容限界

地震① - 39

構造物の相当部分が降伏し、塑性変形する場合でも過大な変形、亀裂、破損等が生じ、その施設の機能に影響を及ぼすことがない限界に応力等を制限する。

b. Aクラス（ A_s クラスを除く。）の機器・配管等

降伏応力又はこれと同等の安全性を有する応力を許容限界とする。

地震① - 40

c. B及びCクラスの機器・配管等

降伏応力又はこれと同等の安全性を有する応力を許容限界とする。

地震① - 41

d. 動的機器

地震時に動作を要求される機器については、解析又は実験等により、動的機能

地震① - 41

が阻害されないことを確認する。

0334

IV - 1 - 2 - 1 重要度分類の基本方針

2. 耐震設計上の重要度分類

再処理施設の耐震設計上の重要度を、次のように分類する。

2.1 機能上の分類

(1) Aクラスの施設

以下に示す機能を有する施設であって、環境への影響、効果の大きいもの。

- a. 自ら放射性物質を内蔵しているか又は内蔵している施設に直接関係しており、その機能喪失により、放射性物質を外部に放散する可能性のあるもの又は放射線による環境への影響、効果のあるもの。
- b. 放射性物質を外部に放散する可能性のある事態を防止するために必要なもの。
- c. 上記のような事故発生の際に、外部に放散される放射性物質による影響を低減させるために必要なもの。

なお、Aクラスの施設のうち、特に重要と判断される施設を限定してA_sクラスの施設と呼称する。

(2) Bクラスの施設

上記において、影響、効果が比較的小さいもの。

(3) Cクラスの施設

Aクラス、Bクラス以外であって、一般産業施設と同等の安全性を保持すればよいもの。

2.2 クラス別施設

上記耐震設計上の重要度分類によるクラス別施設を以下に示す。

(1) Aクラスの施設

- a. その破損又は機能喪失により臨界事故を起こすおそれのある施設
 - (a) 形状寸法管理を行う設備のうち、平常運転時その破損又は機能喪失により臨界を起こすおそれのある設備
 - b. 使用済燃料を貯蔵するための施設
 - (a) 使用済燃料受入れ設備の燃料取出し設備並びに使用済燃料貯蔵設備の燃料貯蔵設備、燃料移送設備及び燃料送出し設備のプール、ピット、移送水路、ラック、架台
- なお、上記 a., b. の施設はA_sクラスとする。
- c. 高レベル放射性液体廃棄物を内蔵する系統及び機器
 - (a) 高レベル廃液を内蔵する機器・配管のうち安全上重要な施設
- なお、崩壊熱除去の観点から安全冷却水の供給が必要な設備はA_sクラスとする。
- (b) ガラス溶融炉はA_sクラスとする。
 - d. プルトニウムを含む溶液を内蔵する系統及び機器
 - (a) プルトニウムを含む溶液を内蔵する機器・配管のうち安全上重要な施設
- なお、崩壊熱除去の観点から安全冷却水の供給が必要な設備はA_sクラスとする。
- e. 上記 c. 及び d. の系統及び機器から放射性物質が漏えいした場合に、その影響

地震② - 1

地震② - 2

地震② - 3

0339

の拡大を防止するための施設

(a) A_sクラス及びAクラスの設備を収納するセル等及びせん断セル

f. 上記c., d.及びe.に関連する施設で放射性物質の外部に対する放散を抑制するための施設

(a) A_sクラス及びAクラスの機器の廃ガス処理設備のうち安全上重要な施設

なお、高レベル廃液ガラス固化廃ガス処理設備のうちガラス熔融炉から廃ガス洗浄器までの範囲はA_sクラスとする。

(b) Aクラスのセル等の換気設備のうち安全上重要な施設

(c) 主排気筒及びその排気筒モニタ

なお、AクラスとBクラス以下の配管又はダクトの取合いは、Bクラス以下の廃ガス処理設備又は換気設備の機能が喪失したとしても、Aクラスの廃ガス処理設備又は換気設備に影響を与えないように行う。

g. 上記a.～f.の施設の機能を確保するために必要な施設

(a) 非常用所内電源系統、安全圧縮空気系及び安全蒸気系

(b) 安全冷却水系及び使用済燃料貯蔵設備のプール水冷却系

(c) 安全保護系及び保護動作を行う機器・配管

(d) 安全上重要な施設の漏えい液を受ける漏えい液受皿の集液溝等の液位警報及び漏えい液受皿から漏えい液を回収するための系統のうち安全上重要な施設

(e) 計測制御系統施設等に係る安全上重要な施設のうち、地震後においても、その機能が継続して必要な施設

なお、上記施設のうちA_sクラスの設備の機能を維持するために必要な設備はA_sクラスとする。

h. その他の施設

(a) 固化セル移送台車はA_sクラスとする。

(b) ガラス固化体貯蔵設備の収納管、通風管

(c) ウラン・プルトニウム混合酸化物貯蔵建屋換気設備のうち貯蔵室から排風機までの範囲はA_sクラスとする。

(d) 使用済燃料貯蔵設備の補給水設備

(e) その機能喪失により臨界に至る可能性のある計測制御系統施設に係る安全上重要な施設は、A_sクラスとするか、又は、検出器の故障を検知し警報を発する故障警報及び工程停止のための系統をA_sクラスとする。

(f) 制御建屋中央制御室換気設備

(g) 水素掃気用の安全圧縮空気系はA_sクラスとする。

なお、A_sクラスの水素掃気用の安全圧縮空気系が接続されている機器は、溶液の放射線分解により発生する水素の爆発を適切に防止するため、構造強度上A_sクラスとする。

(h) しゃへい設備のうち安全上重要な施設

(2) Bクラスの施設

a. 放射性物質を内蔵している施設であって、Aクラス以外の施設（ただし内蔵量が少ないか又は貯蔵方式により、その破損により一般公衆に与える放射線の影響が十分小さいものは除く。）

地震② - 4

- (a) 使用済燃料貯蔵設備のプール水浄化系
 - (b) 高レベル廃液を内蔵する設備のうち、溶解施設、分離施設、高レベル廃液処理設備、高レベル廃液ガラス固化設備の機器・配管
 - (c) プルトニウムを含む溶液を内蔵する設備のうち、溶解施設、分離施設、精製施設、ウラン・プルトニウム混合脱硝設備の機器・配管
 - (d) ウランを内蔵する機器・配管
 - (e) プルトニウムを含む粉体を内蔵する機器・配管
 - (f) 酸回収設備及び溶媒回収設備
 - (g) 低レベル廃液処理設備、ただし、洗濯廃液、床ドレンの一部、試薬ドレン、手洗いドレン、空調ドレンに係る設備、及び海洋放出管の一部を除く。
 - (h) 低レベル固体廃棄物処理設備
 - (i) 分析設備
- b. 放射性物質の外部に対する放散を抑制するための施設でAクラス以外の施設
- (a) Bクラスの設備を収納するセル等
 - (b) Bクラスの機器の廃ガス処理設備のうち、塔槽類から排風機を経て弁までの範囲
 - (c) Bクラスのセル等の換気設備のうち、セル等から排風機を経てダンパまでの範囲
- c. その他の施設
- (a) 放射性物質を取り扱うクレーン、台車等の移送機器並びに検査装置、切断装置等の装置類、ただし、以下の設備を除く。
 - i. 放射性物質の環境への放出のおそれがない移送機器及び装置類
 - ii. 放射能濃度が非常に低いか、又は内蔵量が非常に小さいものを取り扱う移送機器及び装置類
 - (b) 主要なしゃへい設備
- (3) Cクラスの施設
- 上記A、Bクラスに属さない施設

①JN 震 341-A

地震② - 5

2. 3 耐震設計上の留意事項

- (1) ウラン・プルトニウム混合酸化物貯蔵設備の貯蔵ホールは、基準地震動 S_2 にて臨界安全が確保されていることの確認を行う。
- (2) 上位の分類に属する設備と下位の分類に属する設備を渡る液体状の放射性物質を移送するための配管及びサンプリング配管等の明らかに取扱い量が少ない配管は、設備のバウンダリを構成している範囲を除き、下位の分類とする。
- (3) 上位の分類に属するものは、下位の分類に属するものの破損によって波及的影響が生じないようにする。

地震② - 6

上記2. 2に基づくクラス別施設を第2. 2-1表に示す。

第2. 2-1表には、当該施設を支持する建物・構築物の支持機能が維持されることを確認する地震動及び相互影響を考慮すべき設備に適用する地震動についても併記する。

IV - 1 - 2 - 2 地震応答解析の基本方針

2. 建物・構築物の応答解析

2.1 建物

(1) 入力地震動

地震③ - 1

建物の地震応答解析モデルに対する入力地震動は、解放基盤表面位置(T. M. S. L. -70m)で定義された基準地震動に基づき、基盤上層の影響を考慮して作成したものをを用いるものとする。

基準地震動は、基準地震動 S_1 として作成された模擬地震波 S_1-D と基準地震動 S_2 として作成された模擬地震波 S_2-D 及び S_2-N とする。

(2) 解析方法及び解析モデル

地震③ - 2

a. 解析方法

建物の地震応答解析は時刻歴応答解析法で行う。

b. 解析モデル

建物の応答解析を行うための振動解析モデルは、建物を曲げ変形とせん断変形を考慮した質点系で、また、地盤を三次元波動論により水平及び回転ばねで表した地盤-建物連成モデルを採用する。

(3) 地盤定数及び減衰定数

地震③ - 3

a. 地盤定数

地盤定数は、地盤に関する調査を行った結果に基づいて算定するものとする。

b. 減衰定数

地震応答解析に用いる減衰定数は、下記のとおりとする。

(a) 建物

使用材料及び構造種別に応じて設定するものとする。

(b) 地盤

地盤-建物相互作用を適切に評価して算出するものとする。

2.2 構築物（洞道）

(1) 入力地震動

地震③ - 4

洞道の地震応答解析モデルに対する入力地震動は、解放基盤表面位置(T. M. S. L. -70m) で定義された基準地震動を用いるものとする。

基準地震動は、基準地震動 S_1 として作成された模擬地震波 S_1-D と基準地震動 S_2 として作成された模擬地震波 S_2-D 及び S_2-N とする。

(2) 解析方法及び解析モデル

地震③ - 5

a. 解析方法

応答震度分布の算定のための地盤の地震応答解析は、一次元波動論による周波数応答解析法で行う。

b. 解析モデル

地盤の応答解析を行うための振動解析モデルは、地盤を水平成層としてモデル化した一次元モデルを採用する。

(3) 地盤定数及び減衰定数

地震③ - 6

a. 地盤定数

地盤定数は、地盤に関する調査を行った結果に基づいて算定するものとする。

b. 減衰定数

地震応答解析に用いる減衰定数は、下記のとおりとする。

(a) 洞 道

使用材料及び構造種別に応じて設定するものとする。

(b) 地 盤

地盤の応答性状を適切に評価して設定するものとする。

2.3 構築物（洞道以外）

構築物（洞道以外）の応答解析は、原則として2.1に示される条件に基づいて実施する。

3352

3. 機器・配管等の応答解析

3.1 入力地震動

地震③ - 7

機器・配管等の地震応答解析の入力地震動は、基準地震動 S_1 及び S_2 に基づいた当該機器・配管等の設置床における設計用床応答曲線又は時刻歴応答波とする。

また、Bクラスの機器・配管等で動的解析が必要なものに対しては、基準地震動 S_1 に基づく設計用床応答曲線の応答加速度を1/2倍したものをを用いるか、又は、基準地震動 S_1 から定まる入力地震動の加速度振幅を1/2倍したものを入力として建物・構築物の動的解析を行い、これより算定される設計用床応答曲線を用いる。

3.2 解析方法・解析モデル

(1) 解析方法

地震③ - 8

機器・配管等の地震応答解析は、原則として設計用床応答曲線を用いる応答スペクトル・モーダル解析法による。応答スペクトル・モーダル解析法を採用する機器・配管等の応答の最大値は、自乗和平方根法により求める。また、当該機器・配管等の設置床における時刻歴応答波を用いる場合は、時刻歴応答解析法による。

(2) 解析モデル

地震③ - 9

機器・配管等の解析には、その形状及び支持方法を考慮して1質点系はり、多質点系はり、等分布荷重連続はり又は有限要素法のモデルを用いる。

3.3 減衰定数

地震③ - 10

機器・配管等の地震応答解析には、次の値を用いる。ただし、実験又は特別な研究によって信頼できる数値があればこれを用いることができるものとする。

第3.3-1表 減衰定数

設 備	減衰定数 (%)
溶 接 構 造 物	1.0
ボルト及びリベット構造物	2.0
配 管 ¹⁾	0.5~2.5
ダ ク ト	2.5
ポンプ等の機械装置	1.0
電 気 盤 ²⁾	4.0

注記 1) : 配管設計用減衰定数は、第3.3-2表の下に示す適用条件を満たすならば、各振動モードについて一律に第3.3-2表に示す値を用いるものとする。ただし、適用条件を満たさないものについては、一律に0.5%とする。

2) : 電気盤設計用減衰定数は、自立閉鎖型の電気盤は4.0%、その他の電気盤は1.0%とする。

IV - 1 - 2 - 3 機能維持の検討方針

1. 概要

再処理施設は、耐震設計上の重要度に応じた設計用地震力に対してその機能を維持するように設計される。本資料は、機能が維持されることを確認するに際しての基本的な考え方を示したものである。

2. 構造強度上の制限

地震④ - 5

再処理施設の機能が構造強度的に維持されるかどうかの確認は、再処理施設の耐震設計に際し、各耐震設計上の重要度に応じた設計用地震力が建物・構築物、機器・配管等に加わった場合、これらに生じる応力とその他の荷重によって生じる応力の合計値が許容限界を超えないことを確認することによって行うものとする。

許容限界は、建物・構築物、機器・配管等の種類、用途等を考慮し、その機能が維持出来るように十分余裕を見込んだ値とする。

地震力による応力とその他の荷重による応力の組合せに対する許容限界は、添付書類「耐震設計の基本方針」に示す考え方に基づいて以下に示すとおりとする。

記号の説明

D : 建物・構築物における固定荷重又は機器・配管等における死荷重

L : 積載荷重

S_s : 雪荷重（短期事象との組合せ用で、S_s=0の場合も考慮する。）

S₁ : 基準地震動S₁による地震力又は静的地震力

S₂ : 基準地震動S₂による地震力

S_B : Bクラスの施設に適用される地震力

S_C : Cクラスの施設に適用される地震力

P_d : 当該設備に設計上定められた最高使用圧力による荷重

M_d : 当該設備に設計上定められた機械的荷重

S_y : 設計降伏点 「発電用原子力設備に関する構造等の技術基準」（昭和55年通商産業省告示第501号、以下「告示第501号」という。）別表第9に規定される値

S_u : 設計引張強さ 「告示第501号」別表第10に規定される値

S_m : 設計応力強さ 「告示第501号」別表第2に規定される値

S : 許容引張応力 「告示第501号」別表第6又は別表第7に規定される値

f_t : 許容引張応力 支持構造物（ボルト等を除く。）に対して「告示第501号」第88条第3項第一号イにより規定される値
ボルト等に対しては、「告示第501号」第88条第3項第二号イにより規定される値

f_s : 許容せん断応力 同 上

f_c : 許容圧縮応力 支持構造物（ボルト等を除く。）に対して「告示第501号」第88条第3項第一号イにより規定される値

f_b : 許容曲げ応力 同 上

f_p : 許容支圧応力 同 上

3. 変形，歪の制限

再処理施設として設置される建物・構築物，機器・配管等の設計に当たって，地震時にこれらに生じる変形及び歪に対し特に考慮する事項を以下に示す。

3.1 建物・構築物間相対変位に対する配慮

異なった建物・構築物間の取合部については，十分安全側に算定された建物・構築物間相対変位に対し適切な間隔を設けることとし，異なった建物・構築物間をわたる配管等の設計においては，十分安全側に算定された建物・構築物間相対変位に対し配管ルート，支持方法又は伸縮継手の採用等でこれを吸収できるように考慮する。

3.2 形状寸法管理に対する配慮

形状寸法管理を行う設備のうち，平常運転時その破損又は機能喪失により臨界を起こすおそれのあるものであって，地震時において発生する変形量を制限する必要があるものは，これらを配慮した設計とする。

4. 間接支持機能の維持

地震④ - 1

耐震クラスの異なる施設を支持する建物・構築物は，当該部分の支持機能の確認を行うものとする。この場合，常時作用している荷重及び通常運転時の状態で施設に作用する荷重と，支持される施設の耐震クラスに応じた動的地震力との組合せに対して，当該建物・構築物が構造物全体として十分変形能力（ねばり）の余裕を有し，終局耐力に対して安全余裕を有していることのほか，耐震クラスの異なる施設がそれを支持する建物・構築物の変形等に対して機能を損われないものとする。

5. 相互影響に対する検討

地震④ - 2

下位の耐震クラスに属する施設の破損によって，上位の耐震クラスに属する施設に波及的影響を及ぼし，当該施設の持つ安全上の機能を阻害するおそれのある施設については，上位の耐震クラスに属する施設に適用される地震動に対して安全上支障のないことを確認するものとする。

6. 動的機能の維持

0374
0360

地震④ - 3

地震時及び地震後に動作機能の維持が要求される動的機器については，解析又は振動試験により動的機能が阻害されないことを確認するものとする。

7. 電気計測制御装置の機能維持

地震④ - 4

電気計測制御装置の機能維持の確認は，原則として各々の盤・器具等について解析又は振動試験で行うものとする。

設計及び工事の方法

○
→
△
○

0001

イ. 建 物

○ 7

○

0002

2. 再処理設備本体等に係る「建物」

2.1 前処理建屋（その1）

a. 設置の概要

本建屋は、せん断処理施設の燃料供給設備及びせん断処理設備、溶解施設の溶解設備及び清澄・計量設備、気体廃棄物の廃棄施設のせん断処理・溶解廃ガス処理設備及び前処理建屋塔槽類廃ガス処理設備、その他再処理設備の附属施設等を収容するための建物である。本建屋に係るセルを第2.1-1表に示す。なお、第2回申請範囲は、しゃへい窓、しゃへい扉、防護扉、しゃへいハッチ、しゃへいスラブ、壁のブロック閉止部及び安全上重要な機器等の健全性を確認するためのセル壁の貫通口のプラグを除く建物である。

b. 準拠すべき主な法令、規格及び基準

- (a) 核原料物質、核燃料物質及び原子炉の規制に関する法律
(昭和32年6月10日 法律第166号)
- (b) 核原料物質、核燃料物質及び原子炉の規制に関する法律施行令
(昭和32年11月21日 政令第324号)
- (c) 使用済燃料の再処理の事業に関する規則
(昭和46年3月27日 総理府令第10号)
- (d) 再処理施設の設計及び工事の方法の技術基準に関する総理府令
(昭和62年3月25日 総理府令第12号)
- (e) 建築基準法
(昭和25年5月24日 法律第201号)
- (f) 建築基準法施行令
(昭和25年11月16日 政令第338号)
- (g) 日本建築学会による各種規準等
- (h) 原子力発電所耐震設計技術指針
(重要度分類・許容応力編 JEAG4601・補-1984, JEAG4601-1987,
JEAG4601-1991 追補版)
- (i) 日本工業規格(JIS)

c. 設計の基本方針

- (a) 本建屋は、十分な強度・剛性及び耐力を有する構造とするとともに、安定な地盤に支持させ、耐震設計上の重要度に応じた耐震設計を行う。

地震⑤ - 1

また、本建屋の基礎スラブ底面下にはサブドレンを敷設し、建物まわりの地下水位を低下させる。

- (b) 本建屋は、内部で取り扱う液体状の使用済燃料等が施設外へ漏えいしない構造とする。
- (c) 本建屋は、周辺監視区域外の線量当量及び放射線業務従事者の線量当量が、昭和63年科学技術庁告示第20号に定められた線量当量限度を十分に下回るようにしゃへい設計を行う。

さらに、本建屋内のしゃへい設計に当たっては、下表に示すように放射線業務

IV - 1 - 2 - 5 設計用床応答曲線の
策定方針

1. 概要

耐震設計の対象となる機器・配管等の地震力を求めるために、その据付位置について床応答曲線を作成する。

ここでは、応答スペクトル・モーダル解析法に基づいて設計する機器・配管等の設計用床応答曲線の策定方針について述べる。

2. 建物・構築物の応答解析

床応答曲線を作成するための各床の加速度時刻歴応答波形の算定には、次の各項を考慮する。

2.1 入力地震動

基準地震動 S_1 及び S_2 に基づく入力地震動を用いて地震応答解析を行う。

2.2 地盤定数

地震応答解析に用いる地盤定数については、地盤に関する調査結果に基づき設定する。

2.3 建物・構築物の特性

建物・構築物の応答に方向性等による影響がある場合は、その影響を地震応答解析モデルに考慮する。

地震⑥ - 1

3. 床応答曲線の作成

3.1 作成手順

床応答曲線は第3.1 - 1図に示す手順によって策定する。

前記の方法に従って当該各床の1質点系加速度応答曲線を床に設置される機器・配管等の設計用減衰定数について作成する。

計算の時間刻みは下記とする。

固有周期 T (秒)	計算の時間刻み
$0.050 \leq T \leq 0.100$	0.002 秒
$0.100 < T \leq 0.200$	0.005 秒
$0.200 < T \leq 0.300$	0.01 秒
$0.300 < T \leq 0.400$	0.02 秒
$0.400 < T \leq 0.700$	0.05 秒
$0.700 < T \leq 1.000$	0.1 秒

4. 設計用床応答曲線

機器・配管等の設計に用いる設計用床応答曲線は、前記3.によって作成した床応答曲線を周期方向に±10%拡幅した床応答曲線を用いることを原則とする。

なお、基準地震動 S_2 に基づく設計用床応答曲線は、設計用模擬地震波 S_2 -D及び S_2 -Nによる床応答曲線を包絡し、周期方向に±10%拡幅するものとする。

5. その他

Bクラスの機器・配管等で動的解析を行うものについては、基準地震動 S_1 に基づく設計用床応答曲線の応答加速度を1/2倍したものをを用いるか、又は、基準地震動 S_1 から定まる入力地震動の加速度振幅を1/2倍したものを入力として建物・構築物の動的解析を行い、これより算定される設計用床応答曲線を用いる。

第6回申請に係る安全上重要な施設
に関する説明書

第1表 第6回申請に係る安全上重要な施設 (9/19)

分類	安全上重要な施設
<p>(3) 上記1及び2の系統及び機器の換気系統及びオフガス処理系統</p> <p>PS/放射性物質の閉じ込め機能(放射性物質の捕集・浄化機能)及びMS/放射性物質の過度の放出防止機能(放射性物質の捕集・浄化機能)</p> <p>PS/放射性物質の閉じ込め機能(排気機能)及びMS/放射性物質の過度の放出防止機能(排気機能)</p>	<p>気体廃棄物の廃棄施設 塔槽類廃ガス処理設備 分離建屋塔槽類廃ガス処理設備 塔槽類廃ガス処理系 ・第1高性能粒子フィルタA, B, C, D, E ・第2高性能粒子フィルタA, B, C, D, E</p> <p>パルセータ廃ガス処理系 ・第1高性能粒子フィルタA, B, C, D, E ・第2高性能粒子フィルタA, B, C, D, E</p> <p>気体廃棄物の廃棄施設 塔槽類廃ガス処理設備 分離建屋塔槽類廃ガス処理設備 塔槽類廃ガス処理系 ・排風機A, B</p> <p>パルセータ廃ガス処理系 ・排風機A, B</p>
<p>(4) 上記1及び2の系統及び機器並びにせん断工程を収納するセル等</p> <p>PS/放射性物質の閉じ込め機能(放出経路の維持機能)体系の維持機能(しゃへい機能)及びMS/放射性物質の過度の放出防止機能(放出経路の維持機能)体系の維持機能(しゃへい機能)</p> <p>*上記1及び2のうち核分裂生成物の閉じ込めの観点から不可欠な機能を有する系統及び機器を収納するセルのみ</p>	<p>下記のセル</p> <p>高レベル廃液ガラス固化建屋 高レベル濃縮廃液貯槽第1セル 高レベル濃縮廃液貯槽第2セル 不溶残渣廃液貯槽第1セル 不溶残渣廃液貯槽第2セル 高レベル廃液共用貯槽セル 高レベル濃縮廃液一時貯槽セル 不溶残渣廃液一時貯槽セル</p> <p>高レベル廃液混合槽第1セル 高レベル廃液混合槽第2セル 放射性配管分岐セル 供給槽第1セル 供給槽第2セル 固化セル 分配器セル</p> <p>下記のセルのしゃへいハッチ</p> <p>分離建屋 高レベル廃液濃縮缶第1セル 高レベル廃液濃縮缶第2セル</p> <p>精製建屋 プルトニウム精製塔セル 放射性配管分岐第1セル</p> <p>プルトニウム濃縮缶セル 放射性配管分岐第2セル</p> <p>下記のセルのしゃへいスラブ</p> <p>分離建屋 プルトニウム溶夜中間貯槽セル 放射性配管分岐第1セル 溶液夜中間貯槽セル 高レベル廃液ガラス固化建屋連絡用放射性配管セル</p> <p>放射性配管分岐第2セル</p> <p>放射線配管分岐第2セル プルトニウム洗浄器セル</p>

⑥ VI D

地震⑦ - 1

再 処 理 事 業 所
再 処 理 事 業 指 定 申 請 書
本 文 及 び 添 付 書 類

日 本 原 燃 株 式 会 社

B. 再処理能力

再処理施設の再処理能力は、前記A. に示す仕様を満たすBWR使用済燃料及びPWR使用済燃料について以下のとおりである。

年間の最大再処理能力 : 800 t・U_{PR}

1日当たりの最大再処理能力 : 4.8 t・U_{PR}

四、再処理施設の位置、構造及び設備並びに再処理の方法

A. 再処理施設の位置、構造及び設備

イ. 再処理施設の位置

(1) 敷地の面積及び形状

敷地は、青森県上北郡六ヶ所村に位置し、標高60m前後の^{いやさかたい}弥栄平と呼ばれる台地にあり、北東部が^{おぶち}尾駁沼に面している。

敷地内の地質は、新第三紀層及びこれを覆う第四紀層からなっている。

敷地に近い主な都市は、三沢市（南約30 km）、むつ市（北北西約40 km）、十和田市（南南西約40 km）、八戸市（南南東約50 km）及び青森市（西南西約50 km）である。

敷地は、北東部を一部欠き、西側が緩い円弧状の長方形に近い部分と、その南東端から東に向かう帯状の部分からなり、帯状の部分は途中で二またに分かれている。総面積は、帯状の部分約30万m²を含めて約380万m²である。

(2) 敷地内における主要な再処理施設の位置

主要な再処理施設を収容する建物及び構築物は、敷地の西側部分を標高約55mに整地造成して、設置する。

敷地のほぼ中央に主排気筒を設置し、その西側に前処理建屋、分離建屋、高レベル廃液ガラス固化建屋、非常用電源建屋及び第1ガラス

固化体貯蔵建屋を，主排気筒の北西側には使用済燃料輸送容器管理建屋，使用済燃料受入れ・貯蔵建屋，使用済燃料受入れ・貯蔵管理建屋及びハル・エンドピース貯蔵建屋を，主排気筒の北側には第1低レベル廃棄物貯蔵建屋を，主排気筒の北東側には第4低レベル廃棄物貯蔵建屋を設置する。主排気筒の南西側には制御建屋，分析建屋，低レベル廃液処理建屋，低レベル廃棄物処理建屋，チャンネルボックス・バーナブルポイズン処理建屋及び第2低レベル廃棄物貯蔵建屋を，主排気筒の南側には精製建屋，ウラン脱硝建屋，ウラン・プルトニウム混合脱硝建屋，ウラン酸化物貯蔵建屋及びウラン・プルトニウム混合酸化物貯蔵建屋を設置する。建物間には，放射性物質の移送等のため洞道を設置する。

海洋放出管は，低レベル廃液処理建屋及び使用済燃料受入れ・貯蔵管理建屋から導かれ，敷地南側にて合流後おおむね運搬専用道路に沿い，汀線部から沖合約3kmまで敷設する。

なお，主排気筒から敷地境界までの最短距離は，北東方向で約600mである。

IV-2-2-1-6

洞道の耐震計算書

⑦ JN-A

18/
47

6794

IV-2-2-1-6-1

分離建屋/高レベル廃液ガラス固化
建屋間洞道, 分離建屋/精製建屋/ウ
ラン脱硝建屋/ウラン・プルトニウ
ム混合脱硝建屋/低レベル廃液処理
建屋/低レベル廃棄物処理建屋/分
析建屋間洞道, 精製建屋/ウラン脱
硝建屋間洞道, 精製建屋/ウラン・
プルトニウム混合脱硝建屋間洞道
の耐震計算書

① JN-A

2.4 構築物の動的設計

2.4.1 解析概要

動的設計用断面力は、地盤応答震度法による動的解析の結果と常時荷重及び鉛直地震力による解析結果を重ね合わせて算定する。

(1) 地盤応答震度法による動的解析

地盤応答震度法は、一次元波動解析（使用計算機コード：SHAKE）による応答震度を物体力として、洞道-地盤連成モデルによる二次元有限要素法の解析モデルに作用させることにより、洞道の断面力を算定（使用計算機コード：NASTRAN）するものである。

a. 解析モデル

解析モデルは、洞道と地盤を連続体として扱い、有限要素でモデル化する。モデル化において、洞道は梁要素に置換し、地盤は二次元平面ひずみ要素で置換する。

解析モデルを第2.4.1-1図に示す。

b. 入力地震動

一次元波動論による地震応答解析における入力地震動は、解放基盤表面（T.M.S.L. -70.0m）で定義された基準地震動を用いる。

c. 応答震度

応答震度は、一次元波動論による地震応答解析を行い、解析モデルの各標高において得られる応答加速度を震度に換算することにより求める。

なお、底面下に打設するMMRについては、一次元波動論による地震応答解析にあたり、この部分を支持地盤と等価な地盤として扱い、MMRの物性を用いて求めた応答より大きく評価するものとする。

地震 1

B
⑦-111

5245

地震 2

3.2 検討条件

3.2.1 検討概要

各洞道のうち、As クラスまたはAクラスの設備の間接支持構造物である洞道については、基準地震動 S_2 、基準地震動 S_1 または基準地震動 S_1 及び S_2 に基づく動的地震力に対してその機能が維持されることを確認する。

地震力として、基準地震動 S_1 及び S_2 に基づいて求められる水平地震力と鉛直地震力を同時に考慮する。

適用する基準地震動に基づく洞道の区分を第3.2.1-1図に示す。

機能維持の検討は、終局強度設計により実施するところであるが、各洞道では、安全側の評価となる許容応力度設計により実施する。

IV - 1 - 2 - 8 配管の耐震支持方針

2326
044

2. 基本方針

2.1 配管の分類と解析方法

配管は、耐震設計上の重要度分類、配管口径及び最高使用温度により、第2.1-1表のとおり分類して各々に適した耐震設計を行う。

第2.1-1表 配管の分類と解析方法

耐震重要度分類	配管分類		多質点系はりモデルによる方法	標準支持間隔による方法 ^{2), 3), 4)}
	口径	最高使用温度		
As A	100A以上	151℃以上	○	—
		151℃未満	—	○
	80A以下	151℃以上	—	○
		151℃未満	—	○
B ¹⁾	100A以上	151℃以上	—	○
		151℃未満	—	○
	80A以下	151℃以上	—	○
		151℃未満	—	○
C	100A以上	151℃以上	—	○
		151℃未満	—	○
	80A以下	151℃以上	—	○
		151℃未満	—	○

記号 ○印：原則として適用する解析手法

注記 1)：共振のおそれのある場合には、動的地震力を考慮する。

2)：耐震設計上の重要度分類As, A及びBクラスの配管は、配管の一次固有振動数を建物・構築物の一次固有振動数より剛側に設定する剛領域設計を採用する。

地震

1

3)：配管形状が複雑な部分や配置上の制限から標準支持間隔による方法を適用することが適切でない場合等については、多質点系はりモデルによる方法を適用する。

4)：配管形状や支持点の位置が定まり、多質点系はりモデルによる方法の適用が可能な場合は、多質点系はりモデルによる方法を適用できる。

3. 配管の支持方針

配管の各支持方法の考え方及び設計方針を以下に示す。また配管の支持点位置の設定基準を第3. - 1 図に示す。

地震

2 3.1 多質点系はりモデルによる方法

多質点系はりモデルにより解析を行う配管については、原則として適切な固定点から固定点までを一つのブロックとして多質点解析（動的解析又は静的解析）を行い、支持点、支持方法等を定める。

多質点解析は、配管を多質点系はりにモデル化し、設計用地震力により配管に生ずる応力、支持点の反力等を求める。

ここでAs、Aクラス又はBクラスの配管に対する設計用地震力は、添付書類「耐震設計の基本方針」に示す方法で算定される静的地震力及び動的地震力のうち、いずれか大きい方とする。

3.2 標準支持間隔による方法

標準支持間隔による方法は、直管部、曲がり部及び集中質量部(等)の標準的な要素に適用する標準支持間隔法と、形状が複雑な部位に適用する個別解析法の2種類の手法がある。

(1) 標準支持間隔法

標準支持間隔法は、配管を等分布荷重連続はりにモデル化し、直管部、曲がり部、分布部及び集中質量を有する直管部の標準的な要素に分け、各要素の固有周期及び設計用地震力による地震応力等が第3.2-1表に示す条件を満足するように支持間隔を定める。また、配管全体としては各要素の組合せを考え、配管の支持点等を定めるものとする。

ここで各耐震クラスの配管に対する設計用地震力は、添付書類「耐震設計の基本方針」に示す方法で算定する。

なお、標準支持間隔法において、耐震設計上の重要度分類As、A及びBクラスの配管は、配管の一次固有周期を建物・構築物の一次固有周期より剛側に設定する剛領域設計を採用する。

また、グローブボックス内配管のように、支持構造物である設備の応答の増幅が考えられる配管については、配管が剛となるように支持間隔を設定し、地震による過度の振動がないよう考慮する。

(2) 個別解析法

個別解析を行う配管については、形状が複雑な部位を含む適切な支持点から支持点までを一つのブロックとして解析（動的解析又は静的解析）を行い、固有周期及び設計用地震力による地震応力が標準支持間隔法による直管部最大支持間隔法に対して安全側となるように、支持点、支持方法等を定める。

ここで各耐震クラスの配管に対する設計用地震力は、添付書類「耐震設計の基本方針」に示す方法で算定する。