

柏崎刈羽原子力発電所 6/7号炉 (2017.12.20版)	東海第二発電所 (2018.9.18版)	島根原子力発電所 2号炉	備考
<p>2.2 所内蒸気系の隔離運用について</p> <p>所内蒸気系は所内温水系のバックアップ熱源、原子炉隔離時冷却系、及び高圧代替注水系のテスト運転時の駆動源として原子炉建屋附属区域に配管が敷設されている。このため所内蒸気系は原子炉建屋附属区域における蒸気源となりうるが、漏えい時の影響を緩和しプラントの安全性を確保できるような対策が完了するまでは、当該区域に至る配管の上流側にて常時隔離運用を実施することで、蒸気漏えいの発生防止を図る。</p> <p>具体的な隔離箇所を系統図と共に6号炉：添付第2.2-1図、7号炉：添付第2.2-2図に示す。</p> <p>また具体的な隔離運用方法としては、現状の「常時開」運用を変更し、「常時閉、及びチェーンによるロック」運用を社内的な規定類に則り実施することで、弁の開操作を防止する。</p> <p>なお本事項は後段規制での対応が必要となる事項である。(別添2参照)</p>	<p>2.2 原子炉建屋内における所内蒸気系の破損評価について</p> <p>原子炉建屋内における所内蒸気系は、廃棄物処理設備濃縮廃液処理系等の加温用熱源、主蒸気隔離弁漏えい率試験装置の温水供給用熱源及び制御棒駆動機構補修室内分解洗浄槽の加温用熱源として原子炉建屋に配管が敷設されている。</p> <p>このうち、防護対象設備の存在する原子炉棟内については、実質的に所内蒸気を使用しておらず、隔離運用としているが、今後は、区画外での隔離措置及び撤去を行い、蒸気漏えいの発生防止を図ることとする。</p> <p>具体的な配置を第1図に示す。</p> <p>その他の原子炉建屋区画については、所内蒸気系の配管が敷設されている範囲について、アクセス性の観点より評価を行い、以下の対策を実施する。</p> <p>耐震補強工事による漏えい防止及び詳細な応力評価を行い、「<u>「溢水評価ガイド附属書A」の記載による「破損想定不要」の考えを適用する。</u>また、蒸気影響を緩和するための対策として、<u>蒸気の漏えいを自動検知し、遠隔隔離を行うために自動検知・遠隔隔離システムを設置する。</u>システムを構成するものとして、<u>温度検出器、蒸気遮断弁、検知制御盤及び検知監視盤を設置する。</u>さらに、<u>自動検知・遠隔隔離対策だけでは雰囲気環境及びアクセス性が確保されない破損想定箇所については、防護カバーを設置し、配管と防護カバーのすき間を設定することで漏えい蒸気量を抑制して、建屋内環境への温度影響を軽減する設計とする。</u></p> <p>また、信頼性向上の観点から、防護カバー近傍には小規模漏えい検知を目的とした特定配置温度検出器を設置し、蒸気の漏えいを早期に自動検知する設計とする。</p> <p>所内蒸気系以外の蒸気影響範囲については、補足説明資料-11に示す。</p>	<p>2. 所内蒸気系の隔離運用について</p> <p>原子炉建物内及び廃棄物処理建物内のうち溢水防護区画に敷設されている所内蒸気系配管については、上流のタービン建物内で常時隔離運用し、かつ一部配管のルート変更を行う。所内蒸気系の隔離箇所と配管ルート変更箇所の概要図を図2-1に、蒸気源有無の全体概略図を図2-2に示す。</p>	<p>・設備の配置状況等の相違</p> <p>【東海第二】</p> <p>島根2号炉は原子炉建物に廃棄物処理棟はない。また、所内蒸気系は隔離運用としており、アクセス性に影響しない</p>

柏崎刈羽原子力発電所 6 / 7号炉 (2017. 12. 20 版)	東海第二発電所 (2018. 9. 18 版)	島根原子力発電所 2号炉	備考
<div data-bbox="172 382 819 1381" style="border: 1px solid black; width: 100%; height: 100%;"></div> <div data-bbox="172 472 201 856" style="border: 1px solid black; padding: 2px; width: fit-content; margin-left: 5px;"> <p>柏崎刈羽原子力発電所 6 / 7号炉 (2017. 12. 20 版)</p> </div> <div data-bbox="863 577 902 1165" style="text-align: center;"> <p>添付第 2. 2-1 図 6 号炉所内蒸気系の隔離運用箇所</p> </div>	<div data-bbox="943 289 1709 1444" style="border: 1px solid black; width: 100%; height: 100%;"></div> <div data-bbox="1062 1465 1590 1501" style="text-align: center;"> <p>第 1 図 原子炉建屋内所内蒸気系配管配置図</p> </div>	<div data-bbox="1745 340 2427 1579" style="border: 1px solid black; width: 100%; height: 100%;"></div> <div data-bbox="2436 604 2475 1333" style="text-align: center;"> <p>図 2-1 所内蒸気系配管の隔離箇所と配管ルート箇所の概要図</p> </div>	

柏崎刈羽原子力発電所 6 / 7号炉 (2017. 12. 20 版)	東海第二発電所 (2018. 9. 18 版)	島根原子力発電所 2号炉	備考
<div data-bbox="178 472 816 1480" style="border: 1px solid black; width: 215px; height: 480px; margin: 10px auto;"></div> <div data-bbox="172 478 201 955" style="border: 1px solid black; width: 100px; height: 227px; position: absolute; top: 228px; left: 58px; font-size: 8px;"> <p>特記事項の内容は機密事項に属しますので公開できません。</p> </div> <div data-bbox="854 688 905 1281" style="text-align: center; margin-top: 10px;"> <p>添付第 2. 2-2 図 7 号炉所内蒸気系の隔離運用箇所</p> </div>			

柏崎刈羽原子力発電所 6 / 7号炉 (2017.12.20版)	東海第二発電所 (2018.9.18版)	島根原子力発電所 2号炉	備考
	<div data-bbox="943 275 1712 1430" style="border: 2px solid black; height: 550px; width: 100%;"></div> <p data-bbox="943 1465 1712 1495">第2図 原子炉建屋廃棄物処理棟における運転時環境最高温度(1</p> <p data-bbox="1299 1514 1359 1543" style="text-align: center;"><u>3)</u></p>		<p data-bbox="2525 1465 2813 1539">・設備の配置状況等の相違</p> <p data-bbox="2525 1556 2674 1585">【東海第二】</p> <p data-bbox="2525 1602 2813 1850">島根2号炉は原子炉建屋に廃棄物処理棟はない。また、所内蒸気系は隔離運用としており、アクセス性に影響しない</p>

柏崎刈羽原子力発電所 6 / 7号炉 (2017.12.20版)	東海第二発電所 (2018.9.18版)	島根原子力発電所 2号炉	備考
	<div data-bbox="943 262 1712 1417" style="border: 2px solid black; height: 550px; width: 100%;"></div> <p data-bbox="943 1465 1712 1495">第2図 原子炉建屋廃棄物処理棟における運転時環境最高温度 (2</p> <p data-bbox="1299 1514 1359 1543"><u>3)</u></p>		

柏崎刈羽原子力発電所 6 / 7号炉 (2017.12.20版)	東海第二発電所 (2018.9.18版)	島根原子力発電所 2号炉	備考
	<div data-bbox="952 262 1715 1417" style="border: 2px solid black; height: 550px; width: 100%;"></div> <p data-bbox="943 1465 1715 1495">第2図 原子炉建屋廃棄物処理棟における運転時環境最高温度 (3)</p> <p data-bbox="1299 1514 1359 1543"><u>3)</u></p>		

柏崎刈羽原子力発電所 6 / 7号炉 (2017.12.20版)	東海第二発電所 (2018.9.18版)	島根原子力発電所 2号炉	備考
	<div data-bbox="946 258 1706 1413" style="border: 2px solid black; height: 550px; width: 100%;"></div> <p data-bbox="946 1423 1706 1453">第3図 原子炉建屋廃棄物処理棟における蒸気影響評価検討範囲</p> <p data-bbox="1279 1465 1374 1495" style="text-align: center;"><u>(1/3)</u></p>		<p data-bbox="2528 1423 2810 1495">・設備の配置状況等の相違</p> <p data-bbox="2528 1514 2674 1543">【東海第二】</p> <p data-bbox="2528 1556 2810 1717">島根2号炉は原子炉建屋に廃棄物処理棟はなく、所内蒸気系は隔離運用としている</p>

柏崎刈羽原子力発電所 6 / 7号炉 (2017.12.20版)	東海第二発電所 (2018.9.18版)	島根原子力発電所 2号炉	備考
	<div data-bbox="952 262 1712 1417" style="border: 2px solid black; height: 550px; width: 100%;"></div> <p data-bbox="943 1423 1712 1453">第3図 原子炉建屋廃棄物処理棟における蒸気影響評価検討範囲</p> <p data-bbox="1279 1465 1377 1495"><u>(2/3)</u></p>		

柏崎刈羽原子力発電所 6 / 7号炉 (2017.12.20版)	東海第二発電所 (2018.9.18版)	島根原子力発電所 2号炉	備考
	<div data-bbox="943 262 1706 1417" style="border: 2px solid black; height: 550px; width: 257px; margin: 0 auto;"></div> <p data-bbox="943 1423 1706 1453">第3図 原子炉建屋廃棄物処理棟における蒸気影響評価検討範囲</p> <p data-bbox="1279 1465 1371 1495" style="text-align: center;"><u>(3/3)</u></p>		

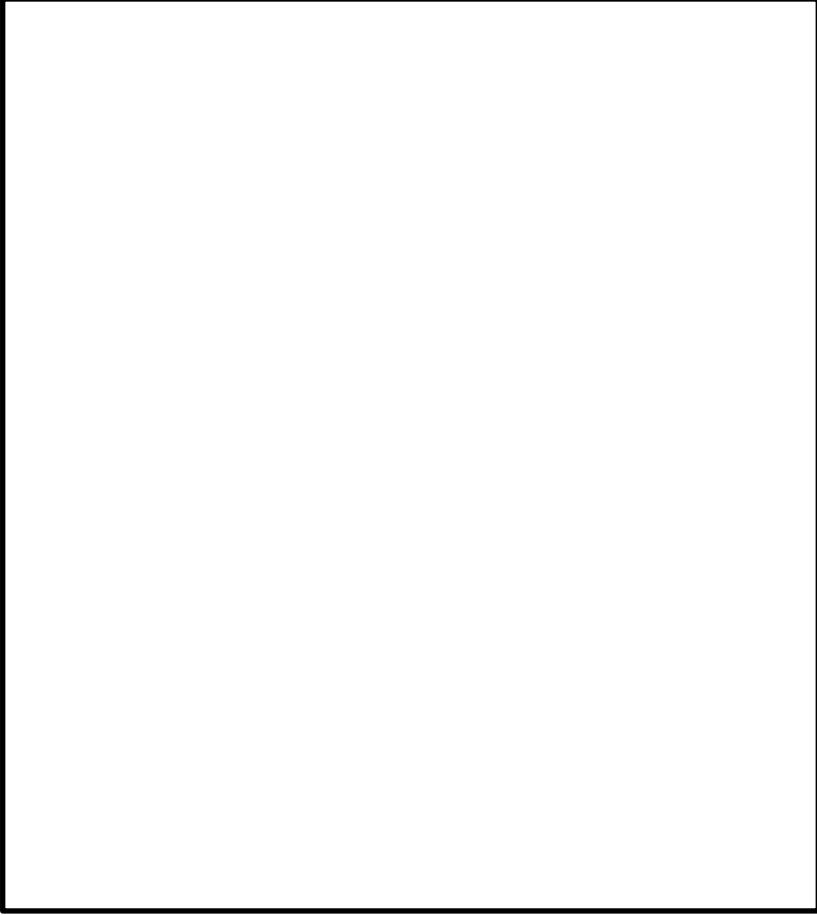
柏崎刈羽原子力発電所 6 / 7号炉 (2017.12.20版)	東海第二発電所 (2018.9.18版)	島根原子力発電所 2号炉	備考
		 <p data-bbox="1923 1192 2318 1228">図 2-2 蒸気源有無の全体概略図</p>	

柏崎刈羽原子力発電所 6 / 7号炉 (2017.12.20版)	東海第二発電所 (2018.9.18版)	島根原子力発電所 2号炉	備考
<p style="text-align: right;">添付資料3</p> <p style="text-align: center;"><u>地震時に溢水源とする機器としない機器について</u></p> <p>3.1 溢水源とする機器としない機器のリスト</p> <p><u>溢水源とする機器としない機器について、ポンプ、容器等の機器については、添付第3.1-1表および添付第3.1-2表に、配管系については添付第3.1-3表～添付第3.1-7に示す。</u></p>	<p style="text-align: right;">添付資料-3</p> <p style="text-align: center;"><u>溢水源となる機器のリスト</u></p> <p><u>溢水源となりうる機器として、原子炉建屋、タービン建屋に設置される流体を内包する容器(タンク、熱交換器、ろ過脱塩器等)及び配管類を抽出した。溢水源となる機器のリストを第1表に示す。なお、静的機器の機能喪失高さの確認について補足説明資料-35に示す。</u></p>	<p style="text-align: right;">添付資料3</p> <p style="text-align: center;"><u>溢水源とする機器としない機器について</u></p> <p>1. 溢水源とする機器としない機器のリスト</p> <p>1.1 <u>溢水源となり得る機器について</u></p> <p><u>溢水源となり得る機器として、原子炉建物、制御室建物、廃棄物処理建物、タービン建物及び取水槽等に設置される流体を内包する容器(タンク、熱交換器、ろ過脱塩器等)並びに配管を抽出した。溢水源となり得る主な機器のリストを表1-1に、溢水源となり得る系統の設置区画及び溢水量を表1-2に、溢水源となり得る機器の配置を図1-1～19に示す。</u></p>	<p>・島根2号炉では想定破損における溢水源も含めて記載</p> <p>【柏崎6/7】</p>

添付第3.1-1表 地震時に溢水源とする機器としない機器 (ポンプ, 容器等)

6号炉 (1/8)

設置エリア			機器情報			Sクラス Sクラス以外:×	溢水源としない (耐震性を確認):○ 溢水源とする:×
建屋	フロア	区画 No.	溢水源の系統	機器名称			
原子炉建屋	地下3階	R-B3-3 R-B3-10	CRD	水圧制御ユニット	○	-	
原子炉建屋	地下3階	R-B3-4	HNCW	CRD HCU(A), (B)室冷却コイル	×	×	
原子炉建屋	地下3階	R-B3-4	CRD	制御棒駆動水加熱器	×	○	
原子炉建屋	地下3階	R-B3-4	CRD	サクシオンフィルタ(A), (B)	×	○	
原子炉建屋	地下3階	R-B3-4	CRD	制御棒駆動水ポンプ(A), (B)	×	○	
原子炉建屋	地下3階	R-B3-4	CUW RCW	原子炉冷却材浄化系非再生熱交換器(A), (B)	×	×	
原子炉建屋	地下3階	R-B3-4	RCW	CRD ポンプ油冷却器(A), (B)	×	×	
原子炉建屋	地下3階	R-B3-5 R-B3-8 R-B3-11	RCW	RHR ポンプ(A)~(C)室空調機	○	-	
原子炉建屋	地下3階	R-B3-5 R-B3-8 R-B3-11	RHR	残留熱除去系ポンプ(A)~(C)	○	-	
原子炉建屋	地下3階	R-B3-5 R-B3-8 R-B3-11	RHR RCW	残留熱除去系ポンプ(A)~(C)	○	-	
原子炉建屋	地下3階	R-B3-5 R-B3-8 R-B3-11	RHR RCW	残留熱除去系熱交換器(A)~(C)	○	-	
原子炉建屋	地下3階	R-B3-6	RCIC	原子炉隔離時冷却系ポンプ	○	-	
原子炉建屋	地下3階	R-B3-6	RCIC	真空タンク	○	-	

※: -は耐震Sクラスのため、溢水源としない機器

第1表 溢水源となる機器のリスト (1/14)

設置場所 建屋	階層	管理 区域 区分	機器名称	Sクラス:○ Sクラス以外:×	溢水源としない (耐震性を確認):○ 溢水源とする:×
原子炉 建屋 (原子炉棟)	B2F	内	残留熱除去系ポンプ(A) シールクーラ	○	-
		内	残留熱除去系ポンプ(B) シールクーラ	○	-
		内	残留熱除去系ポンプ(C) シールクーラ	○	-
		内	高圧炉心スプレイ系ポンプシールクーラ	○	-
		内	低圧炉心スプレイ系ポンプシールクーラ	○	-
		内	原子炉隔離時冷却系パロメトリックコンデンサ	○	-
		内	原子炉隔離時冷却系真空タンク	○	-
		内	原子炉隔離時冷却系油冷却器	○	-
		内	R/B機器ドレンサンプリング熱交換器(A)	×	○
		内	R/B機器ドレンサンプリング熱交換器(B)	×	○
		内	高圧炉心スプレイ系ポンプ室空調機 (HVAC-AH2-1)	○	-
		内	高圧炉心スプレイ系ポンプ室空調機 (HVAC-AH2-2)	○	-
		内	低圧炉心スプレイ系ポンプ室空調機 (HVAC-AH2-3)	○	-
		内	原子炉隔離時冷却系ポンプ・タービン室空調機 (HVAC-AH2-4)	○	-
		内	残留熱除去系Bポンプ室空調機 (HVAC-AH2-5)	○	-
		内	残留熱除去系Cポンプ室空調機 (HVAC-AH2-6)	○	-
		内	残留熱除去系Aポンプ室空調機 (HVAC-AH2-7)	○	-
		内	配管	○	-
		内	配管	×	※
		原子炉 建屋 (原子炉棟)	B1F	内	制御棒駆動水加熱器
内	制御棒駆動水系ポンプ(A) サクシオンフィルタ			×	○
内	制御棒駆動水系ポンプ(B) サクシオンフィルタ			×	○
内	制御棒駆動水ポンプ潤滑油冷却器(A)			×	○
内	制御棒駆動水ポンプ潤滑油冷却器(B)			×	○
内	残留熱除去系熱交換器(A)			○	-
内	残留熱除去系熱交換器(B)			○	-
内	配管			○	-
原子炉 建屋 (原子炉棟)	1F	内	サンプルクーラ(3A)	×	○
		内	サンプルクーラ(3B)	×	○
		内	サンプルクーラ(4A)	×	○
		内	サンプルクーラ(4B)	×	○

表1-1 溢水源となり得る機器リスト (1/6)

建 物	設 置 階 [※]	設 備	耐震 クラス
原子炉建物	地上4階 (EL42.8m)	原子炉補機冷却系タンク	S
		燃料プール	S
		配管	-
	地上3階 (EL34.8m)	ドライエール冷凍機	C
		燃料プール冷却系熱交換器	B
		燃料プール冷却系ろ過脱塩器逆洗水タンク	C
		燃料プール冷却系ろ過脱塩器リコートタンク	C
		スキマタンク	B
		ほう酸水貯蔵タンク	S
		配管	-
	地上中2階 (EL30.5m)	原子炉浄化系ろ過脱塩装置ろ過脱塩器	B
		燃料プール冷却系ろ過脱塩装置ろ過脱塩器	B
		原子炉浄化系タンク	C
		原子炉浄化系非再生熱交換器	B
	地上2階 (EL23.8m)	原子炉浄化系脱塩装置脱塩器	B
		配管	-
		残留熱除去系熱交換器	S
		スクラム排水容器	C
		空調換気設備冷却水冷凍機	C
		原子炉浄化系再生熱交換器	B
原子炉浄化系補助熱交換器		C	
地上1階 (EL15.3m)	配管	-	
	原子炉補機冷却系熱交換器	S	

※ () 内は、設置階の基準床高さを示す。

・設備の相違
【柏崎6/7, 東海第二】

柏崎刈羽原子力発電所 6/7号炉 (2017.12.20版)

添付第3.1-1表 地震時に溢水源とする機器としない機器 (ポンプ, 容器等)

6号炉 (2/8)

設置エリア			機器情報			
建屋	フロア	区画 No.	溢水源の系統	機器名称	Sクラス : ○ Sクラス以外 : ×	溢水源としない (耐震性を確認) : ○ 溢水源とする : × ※
原子炉建屋	地下3階	R-B3-6	RCIC	ハロマトリックコンデンサ	○	-
原子炉建屋	地下3階	R-B3-6	RCIC	復水ポンプ	○	-
原子炉建屋	地下3階	R-B3-6	RCIC	RCICポンプ室空調機	○	-
原子炉建屋	地下3階	R-B3-7 R-B3-12	HPCF RCW	HPCFポンプ(B), (C)	○	-
原子炉建屋	地下3階	R-B3-7 R-B3-12	RCW	HPCFポンプ(B), (C)室空調機	○	-
原子炉建屋	地下3階	R-B3-9	CRD	制御棒駆動水フィルタ(A), (B)	×	○
原子炉建屋	地下3階	R-B3-3 R-B3-10	CRD	アキュムレータ(充填水ライン)	×	○
原子炉建屋	地下3階	R-B3-13	RCW	SPCUポンプ室空調機	×	○
原子炉建屋	地下3階	R-B3-13	SPCU RCW	サブレーションプール浄化系ポンプ	×	○
原子炉建屋	地下2階	R-B2-2	CUW	原子炉冷却材浄化系再生熱交換器	×	×
原子炉建屋	地下2階	R-B2-2	CUW	保持ポンプ(A), (B)	×	×
原子炉建屋	地下2階	R-B2-2	FPC	保持ポンプ(A), (B)	×	×
原子炉建屋	地下2階	R-B2-2	HNCW	RIP/FMCRD取扱装置制御室空調機	×	×
原子炉建屋	地下1階	R-B1-2	CUW	ろ過脱塩器(A), (B)	×	×
原子炉建屋	地下1階	R-B1-2	FPC	ろ過脱塩器(A), (B)	×	×
原子炉建屋	1階	R-1F-3 R-1F-5 R-1F-6	RCW	D/G(A)~(C)発電機軸受潤滑油冷却器	○	-

※ : -は耐震Sクラスのため、溢水源としない機器

東海第二発電所 (2018.9.18版)

第1表 溢水源となる機器のリスト (2/14)

設置場所		管理区域区分	機器名称	Sクラス : ○ Sクラス以外 : ×	溢水源としない (耐震性を確認) : ○ 溢水源とする : ×
原子炉建屋 (原子炉種)	1F	内	PASSクーラ	×	○
		内	配管	○	-
		内	配管	×	※
原子炉建屋 (原子炉種)	2F	内	CUW循環ポンプ(A) シールクーラ	×	○
		内	CUW循環ポンプ(B) シールクーラ	×	○
		内	R/B 2F用冷房装置	×	○
		内	MSトンネル室空調機(AH2-8A)	×	×
		内	MSトンネル室空調機(AH2-8B)	×	×
		内	配管	○	-
原子炉建屋 (原子炉種)	3F	内	配管	×	※
		内	水圧制御ユニット(東側)	○	-
		内	水圧制御ユニット(西側)	○	-
		内	スクラム排出水容器(I)	×	○
		内	スクラム排出水容器(II)	×	○
		内	HPUオイルタンク(A)	×	×
		内	HPUオイルタンク(B)	×	×
		内	原子炉再循環ポンプシールバージフィルタ	×	×
		内	MSIV-LCS低圧マニホールド(A)	○	-
		内	MSIV-LCS低圧マニホールド(B)	○	-
		内	サンプルクーラ(G33-Z020-1)	×	○
		内	可燃性ガス濃度制御系冷却器(A)	○	-
		内	可燃性ガス濃度制御系冷却器(B)	○	-
		内	格納容器雰囲気監視系モニタラック(A)	○	-
		内	配管	○	-
原子炉建屋 (原子炉種)	4F	内	配管	×	※
		内	原子炉冷却材浄化系逆流水受タンク	×	○
		内	原子炉冷却材浄化系逆流水移送ポンプ	×	○
		内	再生熱交換器(A)	×	○
		内	再生熱交換器(B)	×	○
		内	再生熱交換器(C)	×	○
		内	非再生熱交換器(A)	×	○
		内	非再生熱交換器(B)	×	○
		内	燃料プール冷却浄化系熱交換器(A)	×	○
内	燃料プール冷却浄化系熱交換器(B)	×	○		
内	燃料プール冷却浄化系フィルタ脱塩器(A)	×	○		

島根原子力発電所 2号炉

表1-1 溢水源となり得る機器リスト (2/6)

建物	設置階*	設備	耐震クラス
原子炉建物	地下1階 (EL8.8m)	ディーゼル燃料タンク	S
		高圧炉心スプレッド冷却系タンク	S
		配管	-
	地下2階 (EL1.3m)	ディーゼル発電設備 シリンダ油タンク	S
		ディーゼル発電設備 潤滑油フィルタ	S
		ディーゼル発電設備 シリンダ油フィルタ	S
		ディーゼル発電設備 燃料フィルタ	S
		ディーゼル発電設備 潤滑油冷却器	S
		ディーゼル発電設備 1次水冷却器	S
		ディーゼル発電設備 1次水リヒータ	S
		ディーゼル発電設備 1次水空気抜タンク	S
		ディーゼル発電設備 1次水膨張タンク	S
		ディーゼル発電設備 潤滑油リヒータ	S
		ディーゼル発電設備 燃料ドレン受缶	S
		ディーゼル発電設備 潤滑油ポンプタンク	S
		高圧炉心スプレッド冷却系熱交換器	S
		R/B北西コナ室床ドレンポンプ	C
		R/B北東コナ室床ドレンポンプ	C
		DEG室床ドレンポンプ	C
		HPCSPポンプ室床ドレンポンプタンク	C
RHRポンプ室床ドレンポンプタンク	C		
LPCSPポンプ室床ドレンポンプタンク	C		
原子炉建物機器ドレンポンプタンク	C		
原子炉建物床ドレンポンプタンク	C		
サブレーション・チェンバ	S		
配管	-		
制御室建物	地上4階 (EL16.9m)	配管	-
	地上3階 (EL12.8m)	配管	-
	地上2階 (EL8.8m)	電気温水ボイラ	C
	配管	-	
	地上中2階 (EL5.3m)	配管	-
地上1階 (EL1.6m)	配管	-	

※ ()内は、設置階の基準床高さを示す。

備考

柏崎刈羽原子力発電所 6/7号炉 (2017.12.20版)

添付第3.1-1表 地震時に溢水源とする機器としない機器 (ポンプ, 容器等)

6号炉 (3/8)

設置エリア			機器情報			
建屋	フロア	区画 No.	溢水源の系統	機器名称	Sクラス Sクラス以外:×	溢水源としない (耐震性を確認):○ 溢水源とする:×
原子炉建屋	1階	R-1F-3 R-1F-5 R-1F-6	RCW	D/G(A)~(C)潤滑油冷却器	○	-
原子炉建屋	1階	R-1F-3 R-1F-5 R-1F-6	RCW	D/G(A)~(C)機関付空気冷却器	○	-
原子炉建屋	1階	R-1F-3 R-1F-5 R-1F-6	RCW	D/G(A)~(C)清水冷却器	○	-
原子炉建屋	1階	R-1F-12	RCW	FCS 室空調機(A), (B)	○	-
原子炉建屋	2階	R-2F-1	FPC RCW	燃料プール冷却浄化系熱交換器(A), (B)	×	○
原子炉建屋	2階	R-2F-2 共2	RCW	FPC ポンプ室空調機(A), (B)	×	×
原子炉建屋	2階	R-2F-4	FPC RCW	燃料プール冷却浄化系ポンプ(A), (B)	×	○
原子炉建屋	3階	R-3F-1 共	HNCW	ISI 室空調機	×	×
原子炉建屋	3階	R-3F-1 共	SLO	ほう酸水注入ポンプ(A), (B)	○	-
原子炉建屋	3階	R-3F-1 共	SLO	ほう酸水注入系貯蔵タンク	○	-
原子炉建屋	3階	R-3F-1 共	SLO	ほう酸水注入系テストタンク	×	×
原子炉建屋	3階	R-3F-4	RCW	SGTS 室空調機(A), (B)	○	-
原子炉建屋	3階	R-3F-5	HWH RCW	所内温水系温水熱交換器(A), (B)	×	○
原子炉建屋	3階	R-3F-5	HWH	所内温水系バックアップ熱交換器	×	○
原子炉建屋	3階	R-3F-5	HWH	所内温水系温水ループポンプ(A), (B)	×	○

※: -は耐震Sクラスのため、溢水源としない機器

東海第二発電所 (2018.9.18版)

第1表 溢水源となる機器のリスト (3/14)

設置場所		管理 区域 区分	機器名称	Sクラス:○ Sクラス以外:×	溢水源としない (耐震性を確認):○ 溢水源とする:×		
原子炉 建屋 (原研棟)	4F	内	燃料プール冷却浄化系フィルタ脱塩器(B)	×	○		
		内	燃料プール冷却浄化系逆洗水受タンク	×	○		
		内	PLR-LFMG室空調機(SCU2-1)	×	○		
		内	PLR-LFMG室空調機(SCU2-2)	×	○		
		内	燃料プール冷却浄化系再循環ポンプA	×	○		
		内	燃料プール冷却浄化系再循環ポンプB	×	○		
		内	燃料プール冷却浄化系逆洗水移送ポンプ	×	○		
		内	燃料プール冷却浄化系保持ポンプA	×	○		
		内	燃料プール冷却浄化系保持ポンプB	×	○		
		内	サンプルクーラ(5A)	×	○		
		内	サンプルクーラ(5B)	×	○		
		内	R/B 4F用冷房装置	×	○		
		内	格納容器雰囲気監視系モニタラック(B)	○	-		
		内	配管	○	-		
		内	配管	×	※		
		原子炉 建屋 (原研棟)	5F	内	燃料プール冷却浄化系スキマサージタンク(A)	×	○
				内	燃料プール冷却浄化系スキマサージタンク(B)	×	○
				内	ほう酸水注入系貯蔵タンク	○	-
				内	ほう酸水注入系テストタンク	×	×
				内	原子炉冷却材浄化系フィルタ脱塩器(A)	×	○
内	原子炉冷却材浄化系フィルタ脱塩器(B)			×	○		
内	原子炉冷却材浄化系プリコートタンク			×	○		
内	原子炉冷却材浄化系プリコートポンプ			×	○		
内	原子炉冷却材浄化系保持ポンプA			×	○		
内	原子炉冷却材浄化系保持ポンプB			×	○		
内	燃料プール冷却浄化系プリコートタンク			×	○		
内	燃料プール冷却浄化系プリコートポンプ			×	○		
内	R/B 5F用冷房装置			×	○		
内	ドライウェル除湿機(WC2-5)			×	○		
内	DHC冷水ポンプ(P2-7)	×	○				
内	配管	○	-				
内	配管	×	※				
原子炉 建屋 (原研棟)	6F	内	原子炉補機冷却系サージタンク	×	○		
		内	R/B 6Fローカルクーラ	×	○		
		内	配管	○	-		
		内	配管	×	※		

島根原子力発電所 2号炉

表1-1 溢水源となり得る機器リスト (3/6)

建 物	設 置 階*	設 備	耐震 クラス	
廃 棄 物 処 理 建 物	地上5階 (EL37.5m)	テトリ・トリ濃縮器復水器	C	
		テトリ・トリ脱塩器	C	
		テトリ・トリインビクタ添加タンク	C	
		テトリ・トリ乾燥機復水器	C	
		テトリ・トリ濃縮器	C	
		配管	-	
		地上4階 (EL32.0m)	配管	-
			化学廃液濃縮器復水器	C
		床トリ濃縮器復水器	C	
		真空発生装置循環水タンク	C	
		テトリ・トリすすぎ水受タンク	C	
		テトリ・トリ収集タンク	C	
		テトリ・トリシンクタンク	C	
		濃縮廃液タンク用温水タンク	C	
		テトリ・トリ濃縮廃液タンク	C	
		配管	-	
		地上2階 (EL22.1m)	中央制御室冷凍機	S
			床トリ濃縮器	C
			テトリ・トリシンクタンク	C
			機器トリ過脱塩器	C
			機器トリ脱塩器	C
			機器トリ過脱塩装置プリコートタンク	C
			凝縮水ろ過脱塩器	C
			凝縮水脱塩器	C
			化学廃液濃縮器	C
			配管	-
		地上1階 (EL15.3m)	インビクタ添加タンク	C
			硫酸添加タンク	C
	配管	-		
	地下中1階 (EL12.3m)	濃縮廃液ポンプ封水冷却器	C	
		配管	-	

※ () 内は、設置階の基準床高さを示す。

備考

柏崎刈羽原子力発電所 6/7号炉 (2017.12.20版)

添付第3.1-1表 地震時に溢水源とする機器としない機器 (ポンプ, 容器等)
6号炉 (4/8)

設置エリア			機器情報			
建屋	フロア	区画 No.	溢水源の系統	機器名称	Sクラス : ○ Sクラス以外 : ×	溢水源としない (耐震性を確認) : ○ 溢水源とする : × ※
原子炉建屋	3階 中4階	R-3F-6 R-M4F-1	RCW	格納容器内雰囲気モニタ冷却器(A), (B)	○	-
原子炉建屋	3階 中4階	R-3F-6 R-M4F-1	RCW	CAMS(A), (B)室空調機	○	-
原子炉建屋	中4階	R-M4F-3	HNGW	R/A MSトンネル空調機	×	×
原子炉建屋	中4階	R-M4F-4A R-M4F-5B	HECW	D/G(A), (B)/Z冷却コイル	○	-
原子炉建屋	中4階	R-M4F-4C	HNGW	D/G(C)/Z冷却コイル	×	○
原子炉建屋	4階	R-4F-2	HNGW	ASD(A), (B)/Z冷却コイル	×	○
原子炉建屋	4階	R-4F-2	HWH	ASD(A), (B)送風機室加熱コイル	×	○
原子炉建屋	4階	R-4F-3C	RCW	原子炉補機冷却水系サージタンク(A)~(C)	○	-
原子炉建屋	4階	R-4F-3共	FPC	スキマサージタンク(A), (B)	○	-
原子炉建屋	4階	R-4F-3共	HNGW	燃料取扱機制御室空調機	×	×
タービン建屋	地下2階	T-B2-1	FEI	電解槽	×	×
タービン建屋	地下2階	T-B2-1	FEI	海水供給ポンプ	×	×
タービン建屋	地下2階	T-B2-1	FEI	海水ストレナ(A), (B)	×	×
タービン建屋	地下2階	T-B2-3	C.FDW	復水器(A)~(C)	×	×
タービン建屋	地下2階	T-B2-3	C.FDW TCW	低圧復水器ポンプ(A)~(C)	×	×
タービン建屋	地下2階	T-B2-3	C.FDW	復水回収タンク	×	×
タービン建屋	地下2階	T-B2-3	C.FDW HD TCW	高圧ドレンポンプ(A)~(C)	×	×

※ : -は耐震Sクラスのため、溢水源としない機器

東海第二発電所 (2018.9.18版)

第1表 溢水源となる機器のリスト (4/14)

設置場所		管理 区域 区分	機器名称	Sクラス : ○ Sクラス以外 : ×	溢水源としない (耐震性を確認) : ○ 溢水源とする : ×		
建屋	階層						
原子炉 建屋 (付属棟)	B2F	外	DG 2C潤滑油サンプタンク	○	-		
		外	DG 2C清水冷却器	○	-		
		外	DG 2C潤滑油冷却器	○	-		
		外	DG 2C潤滑油加熱器	○	-		
		外	DG 2D潤滑油サンプタンク	○	-		
		外	DG 2D清水冷却器	○	-		
		外	DG 2D潤滑油冷却器	○	-		
		外	DG 2D潤滑油加熱器	○	-		
		外	HPCS DG潤滑油サンプタンク	○	-		
		外	HPCS DG清水冷却器	○	-		
		外	HPCS DG潤滑油冷却器	○	-		
		外	HPCS DG潤滑油加熱器	○	-		
		外	配管	○	-		
		外	配管	×	×		
		原子炉 建屋 (付属棟)	B1F	外	DG 2C清水膨張タンク	○	-
				外	DG 2Cシリンダー注油タンク	○	-
				外	DG 2C燃料油タンク (燃料デイトンク)	○	-
				外	DG 2C空気冷却器 (A)	○	-
外	DG 2C空気冷却器 (B)			○	-		
外	DG 2C清水加熱器			○	-		
外	DG 2D清水膨張タンク			○	-		
外	DG 2Dシリンダー注油タンク			○	-		
外	DG 2D燃料油タンク (燃料デイトンク)			○	-		
外	DG 2D空気冷却器 (A)			○	-		
外	DG 2D空気冷却器 (B)			○	-		
外	DG 2D清水加熱器			○	-		
外	HPCS DG清水膨張タンク			○	-		
外	HPCS DGシリンダー注油タンク			○	-		
外	HPCS DG燃料油タンク (燃料デイトンク)			○	-		
外	HPCS DG空気冷却器 (A)			○	-		
外	HPCS DG空気冷却器 (B)			○	-		
外	HPCS DG清水加熱器			○	-		
外	配管	○	-				
外	配管	×	×				

島根原子力発電所 2号炉

表1-1 溢水源となり得る機器リスト (4/6)

建 物	設 置 階*	設 備	耐震 クラス
廃 棄 物 処 理 建 物	地下1階 (EL8.8m)	RW/B陰イオンろ過タンク	C
		RW/B陽イオンろ過タンク	C
		復水系スラッジ貯蔵タンク	C
		復水系樹脂貯蔵タンク	C
		原子炉浄化系樹脂貯蔵タンク	B
		配管	-
	地下2階 (EL3.0m)	RW/B所内蒸気ドレン回収タンク	C
		機器ドレンタンク	C
		機器ドレン処理水タンク	C
		凝縮水受タンク	C
		処理水タンク	C
		床ドレンタンク	C
		化学廃液タンク	C
		ラトリ・ドレンタンク	C
		濃縮廃液タンク	C
		復水スラッジ分離タンク	C
		機器ドレンろ過脱塩装置逆洗水受タンク	C
		機器ドレンスラッジ分離タンク	C
原子炉浄化系スラッジ貯蔵タンク	B		
廃棄物処理建物機器ドレンポンプタンク	C		
廃棄物処理建物床ドレンポンプタンク	C		
廃棄物処理建物化学廃液ポンプタンク	C		
配管	-		
タービン 建 物	地上4階 (EL32.0m)	配管	-
	地上3階 (EL20.6m)	タービン補機冷却水サージタンク	C
		排ガス除湿冷凍設備	C
		温水ボイラ用膨張タンク兼用給水タンク	C
配管	-		

※ () 内は、設置階の基準床高さを示す。

備考

柏崎刈羽原子力発電所 6/7号炉 (2017.12.20版)

添付第3.1-1表 地震時に溢水源とする機器としない機器 (ポンプ, 容器等)
6号炉 (5/8)

設置エリア			機器情報			
建屋	フロア	区画 No.	溢水源の系統	機器名称	Sクラス : ○ Sクラス以外 : ×	溢水源としない (耐震性を確認) : ○ 溢水源とする : × ※
タービン建屋	地下2階	T-B2-3	HD TCW	低圧ドレンポンプ(A)~(C)	×	×
タービン建屋	地下2階	T-B2-3	TCW	高圧ドレンポンプ油冷却器(A)~(C)	×	×
タービン建屋	地下2階	T-B2-4	TCW	タービン補機冷却水ポンプ(A)~(C)	×	×
タービン建屋	地下2階	T-B2-4	TCW TSW	タービン補機冷却水熱交換器(A)~(C)	×	×
タービン建屋	地下2階	T-B2-4	TSW	タービン補機冷却海水ストレーナ(A)~(C)	×	×
タービン建屋	地下中2階	T-MB2-2	HNGW	IA, SA 圧縮機室空調機	×	×
タービン建屋	地下中2階	T-MB2-2	RCW	IA 空気圧縮機(A), (B)	×	×
タービン建屋	地下2階	T-B2-3	RCW	VGL T/B 弁漏えい蒸気復水器	×	×
タービン建屋	地下1階	T-B1-3	RCW	OG 冷凍凝縮器(A), (B)	×	×
タービン建屋	地下1階	T-B1-3	RCW	OG 排ガス復水器	×	×
タービン建屋	地下1階	T-1F-3	RCW	OG 排ガスブロワ後置冷却器	×	×
タービン建屋	地下中2階	T-MB2-2	RCW	SA 空気圧縮機(A), (B)	×	×
タービン建屋	地下中2階	T-MB2-2	TCW	復水器真空ポンプ針水冷却器	×	×
タービン建屋	地下中2階	T-MB2-2	TCW	EHC 油冷却器(A), (B)	×	×
タービン建屋	地下中2階	T-MB2-2	TCW	EHC 冷却水回収タンク	×	×
タービン建屋	地下中2階	T-MB2-2	TCW	EHC 冷却水回収ポンプ	×	×
タービン建屋	地下中2階	T-MB2-2	TCW	原子炉給水ポンプ駆動用タービン油冷却器	×	×
タービン建屋	地下中2階	T-MB2-2	C,FDW	CD 再循環ポンプ	×	×

※ : -は耐震Sクラスのため、溢水源としない機器

東海第二発電所 (2018.9.18版)

第1表 溢水源となる機器のリスト (5/14)

設置場所		管理 区域 区分	機器名称	Sクラス : ○ Sクラス以外 : ×	溢水源としない (耐震性を確認) : ○ 溢水源とする : ×		
建屋	階層						
原子炉 建屋 (付属棟)	3F	外	中央制御室エアハンドリングユニットファン (A)	○	-		
		外	中央制御室エアハンドリングユニットファン (B)	○	-		
		外	RXP, TK (MCR空調膨張タンク-1)	○	-		
		外	RXP, TK (MCR空調膨張タンク-2)	○	-		
		外	スイッチギヤ室エアハンドリング ユニットファン (A)	○	-		
		外	スイッチギヤ室エアハンドリング ユニットファン (B)	○	-		
		外	RXP, TK (SWGR空調膨張タンク-1)	○	-		
		外	RXP, TK (SWGR空調膨張タンク-2)	○	-		
		外	ユニットヒータ (UH2-24)	×	×		
		外	ユニットヒータ (UH2-25)	×	×		
		外	ユニットヒータ (UH2-26)	×	×		
		外	ユニットヒータ (UH2-27)	×	×		
		外	ユニットヒータ (UH2-28)	×	×		
		外	配管	○	-		
		外	配管	×	×		
		原子炉 建屋 (付属棟)	屋上	外	バッテリー室エアハンドリング ユニットファン (A)	○	-
				外	バッテリー室エアハンドリング ユニットファン (B)	○	-
				外	中央制御室チラーユニット (WC2-1)	×	×
				外	中央制御室チラーユニット (WC2-2)	×	×
				外	SWGRチラーユニット (WC2-3A)	×	×
外	SWGRチラーユニット (WC2-3B)			×	×		
外	SWGRチラーユニット (WC2-4A)			×	×		
外	SWGRチラーユニット (WC2-4B)			×	×		
外	配管			○	-		
外	配管			×	×		
原子炉 建屋 (廃棄物 処理棟)	B1F	内	廃液収集タンク	×	×		
		内	サージタンク (A)	×	×		
		内	サージタンク (B)	×	×		
		内	床ドレン収集タンク	×	×		
		内	濃縮廃液貯蔵タンク (A)	×	×		
		内	濃縮廃液貯蔵タンク (B)	×	×		
		内	濃縮廃液貯蔵タンク (C)	×	×		
		内	蒸気復水冷却器	×	×		
		内	所内蒸気復水タンク	×	×		

島根原子力発電所 2号炉

表1-1 溢水源となり得る機器リスト (5/6)

建 物	設 置 階*	設 備	耐震 クラス	
タービン 建 物	地上2階 (EL12.5m)	第1給水加熱器	C	
		第2給水加熱器	C	
		主油タンク油冷却器	C	
		RFPタービン油冷却器	C	
		空気抽出器復水器	C	
		グランド蒸気復水器	C	
		第6給水加熱器	B	
		固定子冷却装置	C	
		湿分離器ドレンタンク	C	
		グランド蒸気発生器	C	
		排ガス復水器	C	
		排ガス除湿冷却器	C	
		配管	-	
		地上1階 (EL5.5m)	第3給水加熱器	C
			第4給水加熱器	C
	第5給水加熱器		B	
	油計量タンク		C	
	制御油タンク		C	
	配管	-		
	地下1階 (EL2.0m)	タービン補機冷却水熱交換器	C	
		復水脱塩装置脱塩器	B	
		復水ろ過脱塩装置アライメントタンク	C	
		復水脱塩装置カチオン樹脂再生塔	C	
		復水脱塩装置アニオン樹脂再生塔	C	
		T/B所内蒸気ドレン回収タンク	C	
		復水器	C	
		復水ろ過脱塩装置ろ過脱塩器	B	
		封水回収タンク	C	
		タービン建物配管室床ドレンタンク	C	
	タービン建物復水器室機器ドレンタンク	C		
タービン建物発電機架台北機器ドレンタンク	C			
復水器室床ドレンタンク	C			
復水ろ過脱塩装置逆洗水受タンク	C			
タービン建物逆洗水ポンプ室床ドレンタンク	C			
配管	-			

※ () 内は、設置階の基準床高さを示す。

備考

柏崎刈羽原子力発電所 6/7号炉 (2017.12.20版)

添付第3.1-1表 地震時に溢水源とする機器としない機器 (ポンプ, 容器等)
6号炉 (6/8)

設置エリア			機器情報			
建屋	フロア	区画 No.	溢水源の系統	機器名称	Sクラス : ○ Sクラス以外 : ×	溢水源としない (耐震性を確認) : ○ 溢水源とする : × ※
タービン建屋	地下2階 地下1階	T-B2-2 T-B1-2A T-B1-4b1	RCW	原子炉補機冷却水ポンプ(A)~(F)	○	-
タービン建屋	地下2階 地下1階	T-B2-2 T-B1-2A T-B1-4b1	RCW RSW	原子炉補機冷却水熱交換器(A)~(F)	○	-
タービン建屋	地下2階 地下1階	T-B2-2 T-B1-2A T-B1-4b1	RSW	海水ストレーナ(A)~(F)	○	-
タービン建屋	地下1階	T-B1-2A T-B1-2C T-B1-4b1	RSW	原子炉補機冷却海水ポンプ(A)~(F)	○	-
タービン建屋	地下1階	T-B1-3	C,FDW	グラント蒸気復水器	×	×
タービン建屋	地下1階	T-B1-3	C,FDW	復水器過装置(A)~(C)	×	×
タービン建屋	地下1階	T-B1-3	C,FDW	復水器塩装置(A)~(F)	×	×
タービン建屋	地下1階	T-B1-3	C,FDW TCW	高圧復水ポンプ(A)~(C)	×	×
タービン建屋	地下1階	T-B1-3	C,FDW	タービン駆動原子炉給水ポンプ(A), (B)	×	×
タービン建屋	地下1階	T-B1-3	C,FDW TCW	電動機駆動原子炉給水ポンプ(A), (B)	×	×
タービン建屋	地下1階	T-B1-3	C,FDW	樹脂ストレーナ(A)~(F)	×	×
タービン建屋	地下1階	T-B1-3	HD	高圧ドレンタンク	×	×
タービン建屋	地下1階	T-B1-3	HD	低圧ドレンタンク	×	×
タービン建屋	地下1階	T-B1-3	HNCW	T/D RFP 室空調機	×	×
タービン建屋	地下1階	T-B1-3	TCW	高圧復水ポンプ油冷却器(A)~(C)	×	×

※ : -は耐震Sクラスのため、溢水源としない機器

東海第二発電所 (2018.9.18版)

第1表 溢水源となる機器のリスト (6/14)

設置場所		管理区域区分	機器名称	Sクラス : ○ Sクラス以外 : ×	溢水源としない (耐震性を確認) : ○ 溢水源とする : ×		
原子炉建屋 (廃棄物処理棟)	B1F	内	廃液中和タンク (A)	×	×		
		内	廃液中和タンク (B)	×	×		
		内	洗濯廃液ドレンタンク (A)	×	×		
		内	洗濯廃液ドレンタンク (B)	×	×		
		内	廃液スラッジ貯蔵タンク (A)	×	×		
		内	廃液スラッジ貯蔵タンク (B)	×	×		
		内	床ドレンスラッジ貯蔵タンク	×	×		
		内	使用済樹脂貯蔵タンク	×	×		
		内	使用済粉末樹脂貯蔵タンク (A)	×	×		
		内	使用済粉末樹脂貯蔵タンク (B)	×	×		
		内	配管	×	×		
		原子炉建屋 (廃棄物処理棟)	MB1F	内	タンクベント冷却器	×	×
				内	タンクベント加熱器	×	×
				内	所内蒸気系蒸気加熱器	×	×
内	配管			×	×		
原子炉建屋 (廃棄物処理棟)	1F	内	排ガスのブロワ後置冷却器 (A)	×	×		
		内	排ガスのブロワ後置冷却器 (B)	×	×		
		内	グリコール冷凍機 (A)	×	×		
		内	グリコール冷凍機 (B)	×	×		
		内	排ガス系グリコールタンク	×	×		
		内	排ガス前置除湿器 (A)	×	×		
		内	排ガス前置除湿器 (B)	×	×		
		内	中和硫酸タンク	×	×		
		内	中和苛性タンク	×	×		
		内	りん酸ソーダタンク	×	×		
		内	廃液脱塩器	×	×		
		内	凝縮水脱塩器	×	×		
		内	凝縮水サンプルタンク	×	×		
		内	床ドレンサンプルタンク (A)	×	×		
		内	床ドレンサンプルタンク (B)	×	×		
		内	廃液サンプルタンク (A)	×	×		
		内	廃液サンプルタンク (B)	×	×		
		内	配管	○	-		
内	配管	×	×				

島根原子力発電所 2号炉

表1-1 溢水源となり得る機器リスト (6/6)

建物	設置階 [※]	設備	耐震クラス
取水槽	- (EL1.1m)	配管	-
排気筒エリア	- (EL3.5m)	A-デーンセル燃料貯蔵タンク	S
		HPCS-デーンセル燃料貯蔵タンク	S
B-デーンセル燃料貯蔵タンク格納槽	- (EL9.35m)	B-デーンセル燃料貯蔵タンク	S
		配管	-

※ ()内は、設置階の基準床高さを示す。

備考

添付第3.1-1表 地震時に溢水源とする機器としない機器 (ポンプ, 容器等)
6号炉 (7/8)

設置エリア			機器情報		Sクラス Sクラス以外:×	溢水源としない (耐震性を確認):○ 溢水源とする:×
建屋	フロア	区画No.	溢水源の系統	機器名称		
タービン建屋	地下1階	T-B1-3	TCW	電動機駆動原子炉給水ポンプ油冷却器(A),(B)	×	×
タービン建屋	地下1階	T-B1-4b3	TSW	タービン補機冷却海水ポンプ(A)~(C)	×	○
タービン建屋	中2階	T-1F-3	C.FDW HD	第5給水加熱器(A)~(C)	×	×
タービン建屋	中2階	T-1F-3	C.FDW HD	第6給水加熱器(A)~(C)	×	×
タービン建屋	中2階	T-1F-3	HD	湿分分離器ドレンタンク(A1)(A2)(B1)(B2)	×	×
タービン建屋	中2階	T-1F-3	HD	第1段加熱器ドレンタンク(A1)(A2)(B1)(B2)	×	×
タービン建屋	中2階	T-1F-3	HD	第2段加熱器ドレンタンク(A1)(A2)(B1)(B2)	×	×
タービン建屋	1階	T-1F-3	C.FDW	蒸気式空気抽出器	×	×
タービン建屋	1階	T-1F-3	C.FDW HD	第3給水加熱器(A)~(C)	×	×
タービン建屋	1階	T-1F-3	C.FDW HD	第4給水加熱器(A)~(C)	×	×
タービン建屋	1階	T-1F-3	C.FDW HD	第1給水加熱器(A)~(C)	×	×
タービン建屋	1階	T-1F-3	C.FDW HD	第2給水加熱器(A)~(C)	×	×
タービン建屋	1階	T-1F-3	HNCW HWH	Hx/A冷却加熱コイル	×	×
タービン建屋	1階	T-1F-3	TCW	固定子冷却水冷却器(A),(B)	×	×
タービン建屋	1階	T-1F-3	TCW	相分母線用冷却装置	×	×
タービン建屋	1階	T-2F-1共	TCW	発電機水素ガス冷却器(A)~(D)	×	×
タービン建屋	1階	T-1F-3	HNCW	IPB/Z(A),(B)空調機	×	×

※: -は耐震Sクラスのため、溢水源としない機器

第1表 溢水源となる機器のリスト (7/14)

設置場所		管理 区域 区分	機器名称	Sクラス:○ Sクラス以外:×	溢水源としない (耐震性を確認):○ 溢水源とする:×
建屋	階層				
原子炉 建屋 (廃棄物 処理棟)	2F	内	廃液濃縮器加熱器(A)	×	×
		内	廃液濃縮器加熱器(B)	×	×
		内	廃液濃縮器蒸発缶(A)	×	×
		内	廃液濃縮器蒸発缶(B)	×	×
		内	凝縮水収集タンク	×	×
		内	凝集沈殿装置供給タンク	×	×
		内	凝集沈殿装置	×	×
		内	配管	○	—
		内	配管	×	×
原子炉 建屋 (廃棄物 処理棟)	3F	内	オフガス再生室エアハンドリングユニット (AH2-21)	×	×
		内	オフガス再生室チラーユニット(WC2-21)	×	×
		内	SURGE TANK	×	×
		内	再生ガス冷却器	×	×
		内	再生ガスブロワ(A)	×	×
		内	再生ガスブロワ(B)	×	×
		内	配管	×	×
原子炉 建屋 (廃棄物 処理棟)	4F	内	廃液濃縮器復水器(A)	×	×
		内	廃液濃縮器復水器(B)	×	×
		内	封水冷却器(A)	×	×
		内	封水冷却器(B)	×	×
		内	スパージングブロワ入口冷却器	×	×
		内	スパージングブロワ出口冷却器	×	×
		内	スパージングブロワ	×	×
タービン 建屋	B1F	内	復水器(A)	×	×
		内	復水器(B)	×	×
		内	復水器(C)	×	×
		内	給水加熱器(3A)	×	×
		内	給水加熱器(3B)	×	×
		内	給水加熱器(3C)	×	×
		内	給水加熱器(4A)	×	×
		内	給水加熱器(4B)	×	×
内	給水加熱器(4C)	×	×		

添付第3.1-1表 地震時に溢水源とする機器としない機器 (ポンプ, 容器等)
6号炉 (8/8)

設置エリア			機器情報		Sクラス Sクラス以外:×	溢水源としない (耐震性を確認):○ 溢水源とする:×
建屋	フロア	区画 No.	溢水源の系統	機器名称		
タービン建屋	1階	T-1F-4②	TCW	主タービン油冷却器(A),(B)	×	×
タービン建屋	2階	T-2F-1共	HD MUWC	グラント蒸気蒸化器	×	×
タービン建屋	2階	T-2F-1共	HD	蒸化器ドレンタンク	×	×
タービン建屋	2階	T-2F-1共	HD	湿分分離加熱器(A),(B)	×	×
タービン建屋	2階	T-2F-1共	HNGW	湿分分離加熱器(A),(B)室空調機	×	×
タービン建屋	3階	T-2F-1共	HNGW HWH	R/A・T/A冷却加熱コイル	×	×
タービン建屋	3階	T-2F-1共	HNGW	R/A・T/A送風機室空調機	×	×
タービン建屋	3階	T-2F-1共	HNGW	R/A・T/A排風機室空調機	×	×
タービン建屋	屋上階	T-2F-1共	TCW HNGW	タービン補器冷却水系サージタンク	×	×
コントロール建屋	地下2階	C-B2-4 C-B2-5	HECW RCW	HECW冷凍機(A)~(D)	○	-
コントロール建屋	地下2階	C-B2-4 C-B2-5	HECW	HECWポンプ(A)~(D)	○	-
コントロール建屋	地下中2階	C-MB2-2④	HNGW	C/B常用電気品区域冷却コイル	×	○
コントロール建屋	地下中2階	C-MB2-2③	HNGW	C/B計測制御電源盤区域(C)冷却コイル	×	○
コントロール建屋	地下1階 1階	C-B1-8A C-1F-10	HECW	C/B計測制御電源盤区域(A),(B)冷却コイル	○	-
コントロール建屋	2階	C-2F-1	HECW	MCR冷却コイル	○	-

※: -は耐震Sクラスのため、溢水源としない機器

第1表 溢水源となる機器のリスト (8/14)

設置場所		管理 区域 区分	機器名称	Sクラス:○ Sクラス以外:×	溢水源としない (耐震性を確認):○ 溢水源とする:×
建屋	階層				
タービン 建屋	BIF	内	給水加熱器(5A)	×	×
		内	給水加熱器(5B)	×	×
		内	給水加熱器(5C)	×	×
		内	高圧復水ポンプ(A)潤滑油タンク	×	×
		内	高圧復水ポンプ(B)潤滑油タンク	×	×
		内	高圧復水ポンプ(C)潤滑油タンク	×	×
		内	高圧復水ポンプ(A)潤滑油冷却器	×	×
		内	高圧復水ポンプ(B)潤滑油冷却器	×	×
		内	高圧復水ポンプ(C)潤滑油冷却器	×	×
		内	HPCP(A)モータクーラ	×	×
		内	HPCP(B)モータクーラ	×	×
		内	HPCP(C)モータクーラ	×	×
		内	制御油タンク	×	×
		内	貯油タンク	×	×
		内	制御油冷却器(A)	×	×
		内	制御油冷却器(B)	×	×
		内	パッチオイルタンク	×	×
		内	計装用空気圧縮機(A)	×	×
		内	計装用空気圧縮機(B)	×	×
		内	計装用空気系アフタークーラ(A)	×	×
		内	計装用空気系アフタークーラ(B)	×	×
		内	電動駆動原子炉給水ポンプシールドレン コレクタータンク	×	×
		内	所内用空気圧縮機(A)	×	×
		内	所内用空気圧縮機(B)	×	×
		内	所内用空気系アフタークーラ(A)	×	×
		内	所内用空気系アフタークーラ(B)	×	×
		内	脱塩塔No.1	×	×
		内	脱塩塔No.2	×	×
内	脱塩塔No.3	×	×		
内	脱塩塔No.4	×	×		
内	脱塩塔No.5	×	×		
内	脱塩塔No.6	×	×		
内	脱塩塔No.7	×	×		

添付第3.1-2表 地震時に溢水源とする機器としない機器 (ポンプ, 容器等)
7号炉 (1/8)

設置エリア			機器情報			
建屋	フロア	区画 No.	溢水源の系統	機器名称	Sクラス : ○ Sクラス以外 : ×	溢水源としない (耐震性を確認) : ○ 溢水源とする : ×
原子炉建屋	地下3階	R-B3-3 R-B3-10	CRD	水圧制御ユニット	○	-
原子炉建屋	地下3階	R-B3-4	HNCW	CRD HCU(A), (B)室冷却加熱コイル	×	×
原子炉建屋	地下3階	R-B3-4	CUW	原子炉冷却材浄化系非再生熱交換器(A), (B)	×	×
原子炉建屋	地下3階	R-B3-4	CUW RCW	原子炉冷却材浄化系ポンプ(A), (B)	×	×
原子炉建屋	地下3階	R-B3-4	RCW	CRD ポンプ油冷却器(A), (B)	×	×
原子炉建屋	地下3階	R-B3-4	CRD	制御棒駆動水ポンプ(A), (B)	×	○
原子炉建屋	地下3階	R-B3-4	CRD	制御棒駆動水加熱器	×	○
原子炉建屋	地下3階	R-B3-4	CRD	サクションフィルタ(A), (B)	×	○
原子炉建屋	地下3階	R-B3-5 R-B3-8 R-B3-11	RCW	RHR ポンプ(A)~(C)室空調機	○	-
原子炉建屋	地下3階	R-B3-5 R-B3-8 R-B3-11	RHR RCW	残留熱除去系熱交換器(A)~(C)	○	-
原子炉建屋	地下3階	R-B3-5 R-B3-8 R-B3-11	RHR	残留熱除去系射水ポンプ(A)~(C)	○	-
原子炉建屋	地下3階	R-B3-5 R-B3-8 R-B3-11	RHR RCW	残留熱除去系ポンプ(A)~(C)	○	-
原子炉建屋	地下3階	R-B3-6	RCW	RCIC ポンプ室空調機	○	-
原子炉建屋	地下3階	R-B3-6	RCIC	真空タンク	○	-
原子炉建屋	地下3階	R-B3-6	RCIC	パロメトリックコンデンサ	○	-

※：-は耐震Sクラスのため、溢水源としない機器

第1表 溢水源となる機器のリスト (9/14)

設置場所		管理区域区分	機器名称	Sクラス : ○ Sクラス以外 : ×	溢水源としない (耐震性を確認) : ○ 溢水源とする : ×
タービン 建屋	B1F	内	脱塩塔No. 8	×	×
		内	脱塩塔No. 9	×	×
		内	脱塩塔No. 10	×	×
		内	硫酸計量槽	×	×
		内	アニオン樹脂再生塔	×	×
		内	苛性ソーダ計量槽	×	×
		内	カチオン樹脂再生塔	×	×
		内	中間樹脂槽	×	×
		内	樹脂貯槽	×	×
		内	コンデミリサイクルポンプ (A) クーラ	×	×
		内	コンデミリサイクルポンプ (B) クーラ	×	×
		内	サンプルラック (22)	×	×
		内	サンプルラック (24)	×	×
		内	サンプルラック (H ₂ O ₂)	×	×
		内	サンプルラック (25)	×	×
		内	サンプルラック (28)	×	×
		内	L P C P (A) 油クーラ	×	×
		内	L P C P (B) 油クーラ	×	×
		内	L P C P (C) 油クーラ	×	×
		内	L P C P (A) モータクーラ	×	×
内	L P C P (B) モータクーラ	×	×		
内	L P C P (C) モータクーラ	×	×		
内	配管	×	×		
内	配管 (タービン建屋基礎マット~復水器廻り隔離弁及び復水器バイパス弁迄)	×	○		
タービン 建屋	1F	内	VACUUM TANK	×	×
		内	原子炉補機冷却系熱交換器 (A)	×	×
		内	原子炉補機冷却系熱交換器 (B)	×	×
		内	原子炉補機冷却系熱交換器 (C)	×	×
		内	サンプルクーラ (6B)	×	×
		内	排ガス復水器 (A)	×	×
		内	排ガス復水器 (B)	×	×
		内	排ガス予熱器 (A)	×	×
		内	排ガス予熱器 (B)	×	×
内	給水加熱器 (1A)	×	×		

添付第3.1-2表 地震時に溢水源とする機器としない機器 (ポンプ, 容器等)

7号炉 (2/8)

設置エリア			機器情報		Sクラス : ○ Sクラス以外 : ×	溢水源としない (耐震性を確認) : ○ 溢水源とする : × ※
建屋	フロア	区画 No.	溢水源の系統	機器名称		
原子炉建屋	地下3階	R-B3-6	RCIC	復水ポンプ	○	-
原子炉建屋	地下3階	R-B3-6	RCIC	原子炉隔離時冷却系ポンプ	○	-
原子炉建屋	地下3階	R-B3-7 R-B3-12	RCW	HPCF ポンプ(B), (C)室空調機	○	-
原子炉建屋	地下3階	R-B3-7 R-B3-12	HPCF RCW	HPCF ポンプ(B), (C)	○	-
原子炉建屋	地下3階	R-B3-3 R-B3-10	CRD	アキュムレータ(充満水ライン)	×	○
原子炉建屋	地下3階	R-B3-9	CRD	制御棒駆動水フィルタ(A), (B)	×	○
原子炉建屋	地下3階	R-B3-13	RCW	SPCU ポンプ室空調機	×	○
原子炉建屋	地下3階	R-B3-13	SPCU	サブプレッションプール浄化用ポンプ	×	○
原子炉建屋	地下2階	R-B2-2	CUW	原子炉冷却材浄化系再生熱交換器	×	×
原子炉建屋	地下2階	R-B2-2	CUW	保持ポンプ(A), (B)	×	×
原子炉建屋	地下2階	R-B2-2	FPC	保持ポンプ(A), (B)	×	×
原子炉建屋	地下2階	R-B2-2	HNCW	RIP/FMCRD 取扱装置制御室空調機	×	×
原子炉建屋	地下1階	R-B1-2	CUW	ろ過脱塩器(A), (B)	×	×
原子炉建屋	地下1階	R-B1-2	FPC	ろ過脱塩器(A), (B)	×	×
原子炉建屋	1階	R-1F-12	RCW	FCS 室空調機(A), (B)	○	-
原子炉建屋	1階	R-1F-3 R-1F-5 R-1F-6	RCW	D/G(A)~(C)機関付空気冷却器	○	-

※ : -は耐震Sクラスのため、溢水源としない機器

第1表 溢水源となる機器のリスト (10/14)

設置場所		管理 区域 区分	機器名称	Sクラス : ○ Sクラス以外 : ×	溢水源としない (耐震性を確認) : ○ 溢水源とする : ×
建屋	階層				
タービン 建屋	1F	内	給水加熱器 (1B)	×	×
		内	給水加熱器 (1C)	×	×
		内	給水加熱器 (2A)	×	×
		内	給水加熱器 (2B)	×	×
		内	給水加熱器 (2C)	×	×
		内	給水加熱器 (6A)	×	×
		内	給水加熱器 (6B)	×	×
		内	給水加熱器 (6C)	×	×
		内	グラント蒸気蒸発器 (4Sエバポレータ)	×	×
		内	グラント蒸気蒸発器 (4Sエバポレータ) ドレンタンク	×	×
		内	グラント蒸気復水器	×	×
		内	湿分分離器 (A)	×	×
		内	湿分分離器 (B)	×	×
		内	湿分分離器ドレンタンク (A)	×	×
		内	湿分分離器ドレンタンク (B)	×	×
		内	復水器真空ポンプ用ウォータセパレータ	×	×
		内	真空ポンプシール水クーラ	×	×
		内	空気抽出器	×	×
		内	電動機駆動原子炉給水ポンプ (A) 潤滑油タンク	×	×
		内	電動機駆動原子炉給水ポンプ (B) 潤滑油タンク	×	×
		内	電動機駆動原子炉給水ポンプ (A) 潤滑油冷却器	×	×
		内	電動機駆動原子炉給水ポンプ (B) 潤滑油冷却器	×	×
		内	MDRFP (A) モータークーラ	×	×
		内	MDRFP (B) モータークーラ	×	×
		内	サンプルラック (31)	×	×
		内	サンプルラック (B22-Z001)	×	×
		内	サンプルラック (33)	×	×
		内	サンプルラック (30)	×	×
内	原子炉給水ポンプ駆動用蒸気タービン (A) 油タンク	×	×		
内	原子炉給水ポンプ駆動用蒸気タービン (B) 油タンク	×	×		
内	油冷却器No. 1 (A1)	×	×		
内	油冷却器No. 1 (B1)	×	×		
内	油冷却器No. 2 (A2)	×	×		
内	油冷却器No. 2 (B2)	×	×		

添付第3.1-2表 地震時に溢水源とする機器としない機器 (ポンプ, 容器等)
7号炉 (3/8)

設置エリア			機器情報			
建屋	フロア	区画 No.	溢水源の系統	機器名称	Sクラス : ○ Sクラス以外 : ×	溢水源としない (耐震性を確認) : ○ 溢水源とする : × ※
原子炉建屋	1階	R-1F-3 R-1F-5 R-1F-6	RCW	D/G(A)~(C)潤滑油冷却器	○	-
原子炉建屋	1階	R-1F-3 R-1F-5 R-1F-6	RCW	D/G(A)~(C)発電機軸受潤滑油冷却器	○	-
原子炉建屋	1階	R-1F-3 R-1F-5 R-1F-6	RCW	D/G(A)~(C)清水冷却器	○	-
原子炉建屋	2階	R-2F-4	FPC	燃料プール冷却浄化系ポンプ(A), (B)	×	○
原子炉建屋	2階	R-2F-5	FPC RCW	燃料プール冷却浄化系熱交換器(A), (B)	×	○
原子炉建屋	2階	R-2F-2 共 2	RCW	FPCポンプ室空調機(A), (B)	×	×
原子炉建屋	3階	R-3F-4	RCW	SGTS 室空調機(A), (B)	○	-
原子炉建屋	3階	R-3F-5	HWH	所内温水系温水ループポンプ(A), (B)	×	○
原子炉建屋	3階	R-3F-5	HWH RCW	所内温水系温水熱交換器(A), (B)	×	○
原子炉建屋	3階	R-3F-5	HWH	所内温水系バックアップ熱交換器	×	○
原子炉建屋	中4階	R-M4F-1 R-M4F-2	RCW	格納容器内雰囲気モータ冷却器(A), (B)	○	-
原子炉建屋	中4階	R-M4F-3	HNCW	R/A MSトンネル室空調機	×	×
原子炉建屋	中4階	R-M4F-4A R-M4F-5B	HECW	D/G(A), (B)/Z 冷却コイル	○	-
原子炉建屋	中4階	R-M4F-4C	HNCW	D/G(C)/Z 冷却コイル	×	○
原子炉建屋	4階	R-4F-2B R-4F-2A	HNCW	ASD(A), (B)/Z 冷却コイル	×	○

※ : -は耐震Sクラスのため、溢水源としない機器

第1表 溢水源となる機器のリスト (11/14)

設置場所		管理区域区分	機器名称	Sクラス : ○ Sクラス以外 : ×	溢水源としない (耐震性を確認) : ○ 溢水源とする : ×
タービン建屋	1F	内	補助油タンク	×	×
		内	油清浄機	×	×
		内	主油タンク	×	×
		内	主油タンク冷却器 (A)	×	×
		内	主油タンク冷却器 (B)	×	×
		内	発電機水素密封油装置	×	×
		内	固定子冷却装置	×	×
		内	固定子冷却水冷却器 (A)	×	×
		内	固定子冷却水冷却器 (B)	×	×
		内	タービン補機冷却系熱交換器 (A)	×	×
		内	タービン補機冷却系熱交換器 (B)	×	×
		内	タービン補機冷却系熱交換器 (C)	×	×
		内	補助ボイラ (2A)	×	×
		内	補助ボイラ (2B)	×	×
		内	補助ボイラ 蒸気溜	×	×
		内	薬注タンク	×	×
		内	補助ボイラ連続ブロー熱交換器	×	×
		内	給水タンク	×	×
		内	重油サービスタンク	×	×
		内	ディーゼル駆動消火ポンプ用デイトンク	×	×
		内	アフタークーラ	×	×
		内	復水脱塩装置空気圧縮機	×	×
		内	相分離母線空気冷却器 (A)	×	×
		内	相分離母線空気冷却器 (B)	×	×
		内	復水器プライミングポンプクーラ (A)	×	×
		内	復水器プライミングポンプクーラ (B)	×	×
		内	配管	×	×
タービン建屋	2F	内	原子炉補機冷却系防錆剤注入タンク	×	×
		内	タービン補機冷却系サージタンク	×	×
		内	励磁機空気冷却器	×	×
		内	発電機水素冷却器 (A)	×	×
		内	発電機水素冷却器 (B)	×	×
		内	発電機水素冷却器 (C)	×	×

添付第3.1-2表 地震時に溢水源とする機器としない機器 (ポンプ, 容器等)
7号炉 (4/8)

設置エリア			機器情報			
建屋	フロア	区画 No.	溢水源の系統	機器名称	Sクラス : ○ Sクラス以外 : ×	溢水源としない (耐震性を確認) : ○ 溢水源とする : ×
原子炉建屋	4階	R-4F-2A R-4F-2B	RCW	原子炉補機冷却水系サージタンク(A)~(C)	○	-
原子炉建屋	4階	R-4F-3	FPC	スキマサージタンク(A), (B)	○	-
原子炉建屋	4階	R-4F-3	HNCW	燃料取扱機制御室空調機	×	×
原子炉建屋	3階	R-3F-1 共	HNCW	ISI 室空調機	×	×
原子炉建屋	3階	R-3F-1 共	SLC	ほう酸水注入ポンプ(A), (B)	○	-
原子炉建屋	3階	R-3F-1 共	SLC	ほう酸水注入系貯蔵タンク	○	-
原子炉建屋	3階	R-3F-1 共	SLC	ほう酸水注入系テストタンク	×	×
タービン建屋	地下2階	T-B2-1	FEI	電解槽	×	×
タービン建屋	地下2階	T-B2-1	FEI	海水供給ポンプ	×	×
タービン建屋	地下2階	T-B2-1	FEI	海水ストレーナ(A), (B)	×	×
タービン建屋	地下2階	T-B2-3	C.FDW	復水回収タンク	×	×
タービン建屋	地下2階	T-B2-3	HD TCW	高圧ドレンポンプ(A)~(C)	×	×
タービン建屋	地下2階	T-B2-3	HD TCW	低圧ドレンポンプ(A)~(C)	×	×
タービン建屋	地下2階	T-B2-3	TCW	高圧ドレンポンプ油冷却器(A)~(C)	×	×
タービン建屋	地下2階	T-B2-3	HNCW	IA.SA 室空調機	×	×
タービン建屋	地下2階	T-B2-3	C.FDW	復水器(A)~(C)	×	×
タービン建屋	地下2階	T-B2-3	C.FDW TCW	低圧復水ポンプ(A)~(C)	×	×

※ : -は耐震Sクラスのため、溢水源としない機器

第1表 溢水源となる機器のリスト (12/14)

設置場所		管理区域区分	機器名称	Sクラス : ○ Sクラス以外 : ×	溢水源としない (耐震性を確認) : ○ 溢水源とする : ×
タービン建屋	2F	内	タービン建屋送風機ヒーティングコイル (HC2-1)	×	×
		内	タービン建屋送風機ヒーティングコイル (HC2-2)	×	×
		内	原子炉建屋換気系送風機ヒーティングコイル (HC2-3)	×	×
		内	原子炉建屋換気系送風機ヒーティングコイル (HC2-4)	×	×
		内	廃棄物処理棟給気ファンヒーティングコイル (HC2-5)	×	×
		内	廃棄物処理棟給気ファンヒーティングコイル (HC2-6)	×	×
		内	ユニットヒータ (UH2-1)	×	×
		内	ユニットヒータ (UH2-2)	×	×
		内	ユニットヒータ (UH2-3)	×	×
		内	ユニットヒータ (UH2-4)	×	×
		内	ユニットヒータ (UH2-5)	×	×
		内	ユニットヒータ (UH2-6)	×	×
		内	ユニットヒータ (UH2-7)	×	×
		内	ユニットヒータ (UH2-8)	×	×
		内	ユニットヒータ (UH2-10)	×	×
		内	ユニットヒータ (UH2-11)	×	×
		内	ユニットヒータ (UH2-12)	×	×
		内	ユニットヒータ (UH2-15)	×	×
		内	ユニットヒータ (UH2-16)	×	×
		内	ユニットヒータ (UH2-17)	×	×
		内	ユニットヒータ (UH2-19)	×	×
		内	ユニットヒータ (UH2-20)	×	×
		内	ユニットヒータ (UH2-21)	×	×
		内	ユニットヒータ (UH2-22)	×	×
		内	ユニットヒータ (UH2-23)	×	×
		内	ユニットヒータ (UH2-29)	×	×
		内	ユニットヒータ (UH2-30)	×	×
		内	ユニットヒータ (UH2-31)	×	×
		内	ユニットヒータ (UH2-32)	×	×
		内	ユニットヒータ (UH2-33)	×	×
		内	ユニットヒータ (UH2-34)	×	×
		内	ユニットヒータ (UH2-35)	×	×
		内	ユニットヒータ (UH2-36)	×	×

添付第3.1-2表 地震時に溢水源とする機器としない機器 (ポンプ, 容器等)

7号炉 (5/8)

設置エリア			機器情報			
建屋	フロア	区画 No.	溢水源の系統	機器名称	Sクラス : ○ Sクラス以外 : ×	溢水源としない (耐震性を確認) : ○ 溢水源とする : ×
タービン建屋	地下2階	T-B2-3	RCW	VGL T/B 弁漏えい蒸気復水器	×	×
タービン建屋	地下2階	T-B2-4	TCW	タービン補機冷却水ポンプ(A)~(C)	×	×
タービン建屋	地下2階	T-B2-4	TCW TSW	タービン補機冷却水熱交換器(A)~(C)	×	×
タービン建屋	地下2階	T-B2-4	TSW	タービン補機冷却海水ストレーナ(A)~(C)	×	×
タービン建屋	地下中2階	T-MB2-2	RCW	IA 空気圧縮機(A), (B)	×	×
タービン建屋	地下中2階	T-MB2-2	RCW	SA 空気圧縮機(A), (B)	×	×
タービン建屋	地下中2階	T-MB2-2	TCW	原子炉給水ポンプ駆動用タービン油冷却器	×	×
タービン建屋	地下中2階	T-MB2-2	TCW	復水器真空ポンプ封水冷却器	×	×
タービン建屋	地下中2階	T-MB2-2	TCW	EHC 油冷却器(A), (B)	×	×
タービン建屋	地下中2階	T-MB2-2	TCW	EHC 冷却水回収タンク	×	×
タービン建屋	地下中2階	T-MB2-2	TCW	EHC 冷却水回収ポンプ	×	×
タービン建屋	地下1階	T-B1-2A	RCW	原子炉補機冷却水ポンプ(A)~(F)	○	-
タービン建屋	地下2階	T-B1-4b1 T-B2-2	RCW	原子炉補機冷却水熱交換器(A)~(F)	○	-
タービン建屋	地下1階	T-B1-2A	RSW	海水ストレーナ(A)~(F)	○	-
タービン建屋	地下2階	T-B1-4b1 T-B2-2	RSW	原子炉補機冷却海水ポンプ(A)~(F)	○	-

※ : -は耐震Sクラスのため、溢水源としない機器

第1表 溢水源となる機器のリスト (13/14)

設置場所		管理 区域 区分	機器名称	Sクラス : ○ Sクラス以外 : ×	溢水源としない (耐震性を確認) : ○ 溢水源とする : ×		
タービン 建屋	2F	内	ユニットヒータ (UH2-37)	×	×		
		内	ユニットヒータ (UH2-38)	×	×		
		内	ユニットヒータ (UH2-39)	×	×		
		内	ユニットヒータ (UH2-40)	×	×		
		内	配管	×	×		
タービン 建屋	屋上	外	真空脱気器	×	×		
		外	配管	×	×		
C S T エリア	屋外	内	復水貯蔵タンク (A)	×	○		
		内	復水貯蔵タンク (B)	×	○		
		内	配管	×	×		
サービス 建屋	1F	外	ランドリーボイラ No. 1	×	×		
		外	ランドリーボイラ No. 2	×	×		
		外	ランドリーボイラ No. 3	×	×		
		外	ホットウェルタンク No. 1	×	×		
		外	ホットウェルタンク No. 2	×	×		
		外	蒸気ヘッダ (SH-1)	×	×		
		外	蒸気ヘッダ (SH-2)	×	×		
		外	オイルプレヒータ 1号	×	×		
		外	オイルプレヒータ 2号	×	×		
		外	オイルプレヒータ 3号	×	×		
		外	給湯用熱交換器	×	×		
		内・外	配管	×	×		
		サービス 建屋	M2F	外	HVAC室空調機 (AC-3)	×	×
				外	HVAC室空調機 (HC-1)	×	×
内・外	配管			×	×		
サービス 建屋	2F	外	機械室 (COLD) 空調機 (AC-4)	×	×		
		外	機械室 (COLD) 空調機 (HC-7)	×	×		
		外	冷凍機 (R-3)	×	×		
		内	サービスビル電気温水ボイラ	×	×		
		内・外	配管	×	×		
サービス 建屋	3F	外	HVAC室空調機 (AC-1)	×	×		
		外	HVAC室空調機 (AC-2)	×	×		
		内・外	配管	×	×		
サービス 建屋	屋上	外	冷凍機 (R-1)	×	×		
		外	冷凍機 (R-2)	×	×		

添付第3.1-2表 地震時に溢水源とする機器としない機器 (ポンプ, 容器等)

7号炉 (6/8)

設置エリア			機器情報			
建屋	フロア	区画 No.	溢水源の系統	機器名称	Sクラス : ○ Sクラス以外 : ×	溢水源としない (耐震性を確認) : ○ 溢水源とする : × ※
タービン建屋	地下1階	T-B1-3	C.FDW	タービン駆動原子炉給水ポンプ(A), (B)	×	×
タービン建屋	地下1階	T-B1-3	C.FDW	電動機駆動原子炉給水ポンプ(A), (B)	×	×
タービン建屋	地下1階	T-B1-3	TGW	樹脂ストレーナ(A)~(F)	×	×
タービン建屋	地下1階	T-B1-3	C.FDW	樹脂ストレーナ(A)~(F)	×	×
タービン建屋	地下1階	T-B1-3	HD	高圧ドレンタンク	×	×
タービン建屋	地下1階	T-B1-3	HD	低圧ドレンタンク	×	×
タービン建屋	地下1階	T-B1-3	TGW	高圧復水ポンプ油冷却器(A)~(C)	×	×
タービン建屋	地下1階	T-B1-3	TGW	電動機駆動原子炉給水ポンプ油冷却器(A), (B)	×	×
タービン建屋	地下1階	T-B1-3	HNCW	活性炭式希ガスホールドアップ塔室空調機	×	×
タービン建屋	地下1階	T-B1-3	HWH	活性炭式希ガスホールドアップ塔室空調機	×	×
タービン建屋	地下1階	T-B1-3	C.FDW	グラウンド蒸気復水器	×	×
タービン建屋	地下1階	T-B1-3	C.FDW	復水ろ過装置(A)~(D)	×	×
タービン建屋	地下1階	T-B1-3	C.FDW	復水ろ過装置(A)~(F)	×	×
タービン建屋	地下1階	T-B1-3	C.FDW	高圧復水ポンプ(A)~(C)	×	×
タービン建屋	地下1階	T-B1-3	TGW	OG 除湿冷却器	×	×
タービン建屋	地下1階	T-B1-3	HNCW	OG 除湿冷却器	×	×
タービン建屋	地下1階	T-B1-3	RCW	OG 排ガス復水器	×	×
タービン建屋	地下中2階	T-MB2-2	RCW	OG 排ガス復水器	×	×
タービン建屋	地下1階	T-B1-4b3	TSW	タービン補機冷却海水ポンプ(A)~(C)	×	○
タービン建屋	1階	T-1F-3	HNCW	復水器室空調機(A), (B)	×	×
タービン建屋	1階	T-1F-3	HNCW	SCR 盤室空調機	×	×

※ : -は耐震Sクラスのため、溢水源としない機器

第1表 溢水源となる機器のリスト (14/14)

設置場所		管理区域区分	機器名称	Sクラス : ○ Sクラス以外 : ×	溢水源としない (耐震性を確認) : ○ 溢水源とする : ×
サービス建屋	屋上	外	冷却塔ファン (CT-1)	×	×
		外	冷却塔ファン (CT-2)	×	×
		外	冷却塔ファン (CT-3)	×	×
		外	膨張タンク	×	×
		外	S/B飲料水タンク	×	×
		外	ろ過用高築水槽	×	×
		外	配管	×	×
海水ポンプエリア	屋外	外	ASW ポンプ (A)	×	○
		外	ASW ポンプ (B)	×	○
		外	ASW ポンプ (C)	×	○
		外	RHRS ポンプ (A)	○	—
		外	RHRS ポンプ (B)	○	—
		外	RHRS ポンプ (C)	○	—
		外	RHRS ポンプ (D)	○	—
		外	DG SW ポンプ (2C)	○	—
		外	DG SW ポンプ (2D)	○	—
		外	HPCS-DG SW ポンプ	○	—
		外	配管	○	○
外	配管 (補機冷却系海水配管, 所内用水系配管)	×	○		

※原子炉補機冷却水系, 燃料プール冷却浄化系, 復水・純水移送系, 原子炉冷却材浄化系, 制御棒駆動系, 消火系については, 耐震性を確認し溢水源としない。

柏崎刈羽原子力発電所 6 / 7号炉 (2017. 12. 20 版)

東海第二発電所 (2018. 9. 18 版)

島根原子力発電所 2号炉

備考

添付第3.1-2 表 地震時に溢水源とする機器としない機器 (ポンプ, 容器等)
7号炉 (7/8)

設置エリア			機器情報		Sクラス Sクラス以外: ×	Sクラス以外: ×	Sクラス以外: ×
建屋	フロア	区画 No.	機器名称	溢水源とする機器			
タービン建屋	1階	T-1F-3	HNCW	IPB 冷却装置室空調機	×	×	×
タービン建屋	1階	T-1F-3	HNCW	IPB/Z 空調機	×	×	×
タービン建屋	1階	T-1F-3	HNCW HWH	Hx/A 冷却加熱コイル	×	×	×
タービン建屋	中2階	T-1F-3	C.FDW HD	第6給水加熱器(A)~(C)	×	×	×
タービン建屋	中2階	T-1F-3	C.FDW HD	第5給水加熱器(A)~(C)	×	×	×
タービン建屋	1階	T-1F-3	C.FDW HD	第4給水加熱器(A)~(C)	×	×	×
タービン建屋	1階	T-1F-3	C.FDW HD	第3給水加熱器(A)~(C)	×	×	×
タービン建屋	1階	T-1F-3	C.FDW HD	第2給水加熱器(A), (B)	×	×	×
タービン建屋	1階	T-1F-3	C.FDW HD	第1給水加熱器(A), (B)	×	×	×
タービン建屋	中2階	T-1F-3	HD	湿分分離器ドレンタンク(A1), (A2), (B1), (B2)	×	×	×
タービン建屋	中2階	T-1F-3	HD	第1段加熱器ドレンタンク(A1), (A2), (B1), (B2)	×	×	×
タービン建屋	中2階	T-1F-3	HD	第2段加熱器ドレンタンク(A1), (A2), (B1), (B2)	×	×	×
タービン建屋	2階	T-2F-1 共	TCW	発電機水素ガス冷却器(A)~(D)	×	×	×
タービン建屋	1階	T-1F-3	TCW	固定子冷却水冷却器(A), (B)	×	×	×
タービン建屋	1階	T-1F-3	TCW	相分離母線用冷却装置	×	×	×
タービン建屋	1階	T-1F-3	C.FDW	蒸気式空気抽出器	×	×	×
タービン建屋	1階	T-1F-4②	TCW	主タービン油冷却器(A), (B)	×	×	×

※: -は耐震Sクラスのため、溢水源としない機器

柏崎刈羽原子力発電所 6 / 7号炉 (2017. 12. 20 版)

東海第二発電所 (2018. 9. 18 版)

島根原子力発電所 2号炉

備考

添付第3.1-2 表 地震時に溢水源とする機器としない機器 (ポンプ, 容器等)
7号炉 (8/8)

設置エリア			機器情報		Sクラス : ○ Sクラス以外 : ×	溢水源としない (耐震性を確認) : ○ 溢水源とする : ×
建屋	フロア	区画 No.	溢水源の系統	機器名称		
タービン建屋	3階	T-2F-1 共	HNCW HWH	R/A・T/A 冷却加熱コイル	×	×
タービン建屋	3階	T-2F-1 共	HNCW	R/A・T/A 送風機室空調機	×	×
タービン建屋	3階	T-2F-1 共	HNCW	R/A・T/A 排風機室空調機	×	×
タービン建屋	2階	T-2F-1 共	MUWC	グラント蒸気蒸化器給水ポンプ(A), (B)	×	×
タービン建屋	2階	T-2F-1 共	MUWC HD	グラント蒸気蒸化器	×	×
タービン建屋	2階	T-2F-1 共	HNCW	湿分分離加熱器(A), (B)室空調機	×	×
タービン建屋	2階	T-2F-1 共	HD	湿分分離加熱器(A), (B)	×	×
タービン建屋	2階	T-2F-1 共	HD	蒸化器ドレンタンク	×	×
タービン建屋	屋上階	T-2F-1 共	TCW	タービン補機冷却水系サージタンク	×	×
コントロール建屋	地下2階	C-B2-2 C-B2-3	HECW	HECW ポンプ(A)~(D)	○	-
コントロール建屋	地下2階	C-B2-2 C-B2-3	RCW HECW	HECW 冷凍機(A)~(D)	○	-
コントロール建屋	地下中2階	C-MB2-2①	HNCW	C/B 常用電気品区域冷却コイル	×	○
コントロール建屋	地下1階	C-B1-6	HNCW	C/B 計測制御電源盤区域(C)冷却コイル	×	○
コントロール建屋	1階 地下中2階	C-1F-4B C-MB2-2②	HECW	C/B 計測制御電源盤区域(A), (B)冷却コイル	○	-
コントロール建屋	2階	C-2F-3	HECW	MCR 冷却コイル	○	-

※ : -は耐震Sクラスのため、溢水源としない機器

添付第3.1-3表 地震時に溢水源とする機器としない機器(配管系)

6号炉原子炉建屋(1/5)

区画No	配管系統【○:溢水源としない(耐震性を確認)、×:溢水源とする、-:当該区画に水を内包する配管が存在しない】																			
	CRD	CUW	DW	C.FDW	FP	FPC	HD	HNCW	HSCR	HWH	MSC	MUWC	MUWP	RCW	RD	SPCU	TCW	TSW	FEI	
R-4F-1	-	-	-	-	-	-	-	-	-	-	-	-	-	-	-	-	-	-	-	-
R-4F-2	-	-	-	-	○	-	-	○	-	○	-	-	○	○	-	-	-	-	-	-
R-4F-3C	-	-	-	-	○	-	-	-	-	-	-	-	○	○	-	-	-	-	-	-
R-4F-3共	-	-	-	-	○	-	-	×	-	×	-	○	○	○	-	-	-	-	-	-
R-M4F-1	-	-	-	-	-	-	-	-	-	-	-	-	-	○	-	-	-	-	-	-
R-M4F-3	-	-	-	-	○	×	-	×	-	×	-	○	○	×	-	○	-	-	-	-
R-M4F-4A	-	-	-	-	○	-	-	○	-	○	-	-	○	○	-	-	-	-	-	-
R-M4F-4C	-	-	-	-	○	-	-	○	-	-	-	-	-	-	-	-	-	-	-	-
R-M4F-4共	-	-	-	-	○	-	-	○	-	-	-	-	-	-	-	-	-	-	-	-
R-M4F-5B	-	-	-	-	○	-	-	○	-	-	-	-	-	-	-	-	-	-	-	-
R-M4F-5共1	-	-	-	-	○	-	-	○	-	○	-	-	○	○	-	-	-	-	-	-
R-M4F-5共2	-	-	-	-	-	-	-	-	-	-	-	-	-	-	-	-	-	-	-	-
R-3F-1A	-	-	-	-	○	-	-	○	-	-	-	○	○	○	-	○	-	-	-	-
R-3F-1共	-	-	-	-	○	×	-	×	-	×	-	○	○	×	-	○	-	-	-	-
R-3F-2	-	-	-	-	○	-	-	○	-	○	-	-	○	○	-	-	-	-	-	-
R-3F-3	-	-	-	-	○	-	-	○	-	-	-	-	-	-	-	-	-	-	-	-
R-3F-4	-	-	-	-	-	-	-	-	-	-	-	-	○	○	-	-	-	-	-	-

表1-2 溢水源となり得る系統の設置区画及び溢水量(1/27)

原子炉建物 4階

系統略称	系統名称	耐震クラス		溢水量		区画番号及び区画滞留面積(上段:区画番号,下段:区画滞留面積[m ²])				
		S	B, C	想定破壊[m ³]	地震起因[m ³]	二次格内				
						R-4F-01-1N	R-4F-04N	R-4F-01-2N	R-4F-02N	R-4F-03N
						1454	9	74	-	19
CW	復水給水系		○	-	-	-	-	-	-	-
FW			○	-	-	-	-	-	-	-
CRD	制御棒駆動系		○	-	-	-	-	-	-	-
CUW	原子炉浄化系		○	-	-	-	-	-	-	-
ROW(A)	原子炉補機冷却系(非常用HVC(A)系)	○		55	-	●	-	-	-	-
ROW(B)	原子炉補機冷却系(非常用HVC(B)系)	○		55	-	●	-	-	-	-
ROW(N)	原子炉補機冷却系(常用系)									
HVD	ドライエール冷却系		○	23	38	●	-	-	-	-
HVCV	空調機気設備冷却系		○							
RSW(A)	原子炉補機海水系(I)	○		-	-	-	-	-	-	-
RSW(B)	原子炉補機海水系(II)	○		-	-	-	-	-	-	-
FPC	燃料プール冷却系	○	○	91	-	□	想定破壊無し	-	-	-
HPCW	高圧炉心スプレイ補機冷却系	○		-	-	-	-	-	-	-
HPSW	高圧炉心スプレイ補機海水系	○		-	-	-	-	-	-	-
RCIC	原子炉隔離時冷却系	○		-	-	-	-	-	-	-
RHR(A)	残留熱除去系(A)	○		-	-	-	-	-	-	-
RHR(B)	残留熱除去系(B)	○		-	-	-	-	-	-	-
RHR(C)	残留熱除去系(C)	○		-	-	-	-	-	-	-
LPCS	低圧炉心スプレイ系	○		-	-	-	-	-	-	-
HPCS	高圧炉心スプレイ系	○		-	-	-	-	-	-	-
SLC	ほう酸水注入系	○		-	-	-	-	-	-	-
RWL(E)	液体廃棄物処理系(機器ドレン)	○		-	-	-	-	-	-	-
RWL(F)	液体廃棄物処理系(床ドレン・化学廃液系)	○		-	-	-	-	-	-	-
CWT	復水輸送系	○		57	1	●	-	-	-	-
MUW	補給水系	○		31	8	●	-	-	-	-
FP	消火系	○		65	57	●	-	-	-	□
HS	所内蒸気系(蒸気凝縮水戻り側)	○		-	-	-	-	-	-	-
DEGOW(A)	非常用ディーゼル発電機系(冷却水系)(A)	○		-	-	-	-	-	-	-
DEGOW(B)	非常用ディーゼル発電機系(冷却水系)(B)	○		-	-	-	-	-	-	-
DEOLO(A)	非常用ディーゼル発電機系(潤滑油系)(A)	○		-	-	-	-	-	-	-
DEOLO(B)	非常用ディーゼル発電機系(潤滑油系)(B)	○		-	-	-	-	-	-	-
DEIFO(A)	非常用ディーゼル発電機系(燃料油系)(A)	○		-	-	-	-	-	-	-
DEIFO(B)	非常用ディーゼル発電機系(燃料油系)(B)	○		-	-	-	-	-	-	-
DEGOWH	非常用ディーゼル発電機系(冷却水系)(HPCS)	○		-	-	-	-	-	-	-
DELOH	非常用ディーゼル発電機系(潤滑油系)(HPCS)	○		-	-	-	-	-	-	-
DEFOH	非常用ディーゼル発電機系(燃料油系)(HPCS)	○		-	-	-	-	-	-	-
slosh1	スロッシング(オベフロ)(SFP)			-	130	●	-	-	-	-

●:溢水源あり
 □:溢水源あり(耐震B,Cクラスであるが、基準地震動Saによる地震力に対してバウンダリ機能が保持できる)
 -:溢水源なし

・設備の相違
【柏崎6/7】
 柏崎6/7及び島根2号炉は区画ごとに溢水源となる系統を記載

柏崎刈羽原子力発電所 6 / 7号炉 (2017.12.20版)

添付第3.1-3表 地震時に溢水源とする機器としない機器(配管系)

6号炉原子炉建屋(4/5)

区画No	配管系統 【○:溢水源としない(耐震性を確認) ×:溢水源とする、-:当該区画に水を内包する配管が存在しない】																		
	CRD	CUW	DW	C.FDW	FP	FPC	HD	HNCW	HSCR	HWH	MSC	MUWC	MUWP	RCW	RD	SPCU	TCW	TSW	FEI
R-1F-12	-	-	-	-	-	-	-	-	-	-	-	-	○	○	-	-	-	-	-
R-B1-2	○	×	-	-	○	×	-	×	-	×	×	○	○	×	×	○	-	-	-
R-B1-3	-	-	-	-	-	-	-	-	-	-	-	-	-	-	-	-	-	-	-
R-B1-4	-	-	-	-	-	-	-	-	-	-	-	○	○	-	-	-	-	-	-
R-B1-5	-	-	-	-	-	-	-	-	-	-	-	-	○	-	-	-	-	-	-
R-B1-6	-	-	-	-	-	-	-	-	-	-	-	-	○	-	-	-	-	-	-
R-B1-7	-	-	-	-	-	-	-	-	-	-	-	-	-	-	-	-	-	-	-
R-B1-8	-	-	-	-	-	-	-	-	-	-	-	-	-	-	-	-	-	-	-
R-B1-10	-	-	-	-	-	-	-	-	-	-	-	-	○	-	-	-	-	-	-
R-B1-11	-	-	-	-	-	-	-	-	-	-	-	-	○	-	-	-	-	-	-
R-B1-12	-	-	-	-	-	-	-	-	-	-	-	-	-	-	-	-	-	-	-
R-B1-13	-	-	-	-	-	○	-	-	-	-	-	-	○	-	-	-	-	-	-
R-B-14	-	-	-	-	-	○	-	-	-	-	-	-	-	-	-	-	-	-	-
R-B-15a	○	○	-	-	○	○	-	○	-	○	○	○	○	○	○	○	○	-	-
R-B-15b	○	○	-	-	○	○	-	○	-	○	○	○	○	○	○	○	○	-	-
R-B1-16	-	-	-	-	-	-	-	-	-	-	-	-	○	-	-	-	-	-	-
R-B1-17	-	-	-	-	-	○	-	-	-	-	-	-	-	-	-	-	-	-	-

東海第二発電所 (2018.9.18版)

島根原子力発電所 2号炉

備考

表1-2 溢水源となり得る系統の設置区画及び溢水量(4/27)

原子炉建物 3階

系統略称	系統名称	耐震クラス		溢水量		区画番号及び区画滞留面積(上段:区画番号,下段:区画滞留面積[m ²])			
		S	B, C	想定破損 [m ²]	地震起因 [m ²]	二次格納(非管理区域)			
						R-3F-14N	R-3F-17N	R-3F-19N	R-3F-20N
						113	27	20	12
OW FW	復水給水系		○	-	-	-	-	-	-
CRD	制御棒駆動系		○	-	-	-	-	-	-
CUW	原子炉浄化系		○	158	158	-	-	-	-
ROW(A) HVC(A)	原子炉補機冷却系(非常用系I)		○	62	-	-	-	-	-
ROW(B) HVC(B)	原子炉補機冷却系(非常用系II)		○	67	-	-	-	-	-
ROW(N) HVD HVCW	原子炉補機冷却系(常用系)ドライウェル冷却系空筒換気設備冷却水系		○	43	58	-	-	-	-
RSW(A)	原子炉補機海水系(I)		○	-	-	-	-	-	-
RSW(B)	原子炉補機海水系(II)		○	-	-	-	-	-	-
FPC	燃料プール冷却系		○	102	16	-	-	-	-
HPCW	高圧炉心スプレイ補機冷却系		○	-	-	-	-	-	-
HPSW	高圧炉心スプレイ補機海水系		○	-	-	-	-	-	-
ROIC	原子炉隔離時冷却系		○	-	-	-	-	-	-
RHR(A)	残留熱除去系(A)		○	311	-	-	-	-	-
RHR(B)	残留熱除去系(B)		○	306	-	-	-	-	-
RHR(C)	残留熱除去系(C)		○	-	-	-	-	-	-
LPCS	低圧炉心スプレイ系		○	-	-	-	-	-	-
HPCS	高圧炉心スプレイ系		○	-	-	-	-	-	-
SLO	ほう酸水注入系		○	8	-	-	-	-	-
RWL(E)	液体廃棄物処理系(機器ドレン)		○	-	-	-	-	-	-
RWL(F)	液体廃棄物処理系(床ドレン・化学廃液系)		○	-	-	-	-	-	-
CWT	復水輸送系		○	58	2	-	-	-	-
MUW	補給水系		○	33	28	-	-	-	-
FP	消火系		○	66	58	□	-	-	-
HS	所内蒸気系(蒸気凝縮水戻り側)		○	-	-	-	-	-	-
DEG(W/A)	非常用ディーゼル発電機系(冷却水系)(A)		○	-	-	-	-	-	-
DEG(W/B)	非常用ディーゼル発電機系(冷却水系)(B)		○	-	-	-	-	-	-
DEG(L/A)	非常用ディーゼル発電機系(潤滑油系)(A)		○	-	-	-	-	-	-
DEG(L/B)	非常用ディーゼル発電機系(潤滑油系)(B)		○	-	-	-	-	-	-
DEG(F/A)	非常用ディーゼル発電機系(燃料油系)(A)		○	-	-	-	-	-	-
DEG(F/B)	非常用ディーゼル発電機系(燃料油系)(B)		○	-	-	-	-	-	-
DEG(W/H)	非常用ディーゼル発電機系(冷却水系)(HPCS)		○	-	-	-	-	-	-
DEG(L/H)	非常用ディーゼル発電機系(潤滑油系)(HPCS)		○	-	-	-	-	-	-
DEG(F/H)	非常用ディーゼル発電機系(燃料油系)(HPCS)		○	-	-	-	-	-	-
FMW	燃料プール補給水系		○	-	-	-	-	-	-

●:溢水源あり
 □:溢水源あり(耐震B,Cクラスであるが、基準地震動Ssによる地震力に対してバウンダリ機能が保持できる)
 -:溢水源なし

添付第3.1-3表 地震時に溢水源とする機器としない機器(配管系)

6号炉原子炉建屋(5/5)

Table with columns: 区画No, 配管系統 (CRD, CUW, DW, C_FDW, FP, FPC, HD, HNCW, HSCR, HWH, MSG, MUWC, MUWP, RCW, RD, SPCU, TCW, TSW, FEI), and rows R-B1-18 to R-B3-13.

表1-2 溢水源となり得る系統の設置区画及び溢水量(5/27)

原子炉建物 中2階

Table with columns: 系統略称, 系統名称, 耐震クラス (S, B, C), 溢水量 (想定壊損, 地震起因), and 区画番号及び区画滞留面積 (二次格内: R-M2F-03N, R-M2F-06N, R-M2F-07N, R-M2F-08N, R-M2F-09N, R-M2F-10N, R-M2F-11N, R-M2F-14N, R-M2F-15N, R-M2F-16N). Rows include CW, FW, CRD, CUW, RCWA, RWB, RCWN, HVD, HVCW, RSWA, RSWB, FPC, HPCW, HPSW, RCIC, RHRA, RHRB, RHRC, LPCS, HPCS, SLC, RWLE, RWLF, CWT, MUW, FP, HS, DEIGOWA, DEIGOWB, DEIGLOA, DEIGLOB, DEIGPOA, DEIGPOB, DEIGOWH, DEIGLOH, DEIGPOH, FMW.

●: 溢水源あり
□: 溢水源あり(耐震Bクラスであるが、基準地震動Sa1による地震力に対してバウンダリ機能が保持できる)
-: 溢水源なし

柏崎刈羽原子力発電所 6/7号炉 (2017.12.20版)

添付第3.1-4表 地震時に溢水源とする機器としない機器(配管系)

6号炉タービン建屋(2/2)

区画No	配管系統【○:溢水源としない(耐震性を確認)、×:溢水源とする、-:当該区画に水を内包する配管が存在しない】																		
	CRD	CUW	DW	C.FDW	FP	FPC	HD	HNCW	HSCR	HWH	MSC	MUWC	MUWP	RCW	RD	SPCU	TCW	TSW	FEI
T-B2-3	×	×	×	×	×	-	×	×	-	-	×	×	×	×	×	-	×	-	-
T-B2-4	-	-	×	-	×	-	-	×	-	-	×	-	-	×	-	-	×	×	×

東海第二発電所 (2018.9.18版)

島根原子力発電所 2号炉

備考

表1-2 溢水源となり得る系統の設置区画及び溢水量(7/27)

原子炉建物 中2階

系統略称	系統名称	耐震クラス		溢水量		区画番号及び区画滞留面積(上段:区画番号,下段:区画滞留面積[m ²])			
		S	B, C	想定破損 [m ³]	地震起因 [m ³]	二次格内 (管理区域)		二次格外 (非管理区域)	
						R-M2F-102N	R-M2F-23N	R-M2F-01N	R-M2F-02N
						83	16	72	102
CW	複水給水系		○	-	-	-	-	-	-
FW									
CRD	制御棒駆動系		○	-	-	-	-	-	-
CUW	原子炉浄化系		○	158	158	-	-	-	-
RCW(A)	原子炉補機冷却系(非常用HVCA系)		○	68	-	-	-	-	-
RCW(B)	原子炉補機冷却系(非常用HVCB系)		○	79	-	-	-	-	-
RCW(N)	原子炉補機冷却系(常用系)								
HVD	ドライウェル冷却系		○	71	86	-	-	-	-
HVCW	空調機気設備冷却水系								
RSW(A)	原子炉補機海水系(I)		○	-	-	-	-	-	-
RSW(B)	原子炉補機海水系(II)		○	-	-	-	-	-	-
FPC	燃料プール冷却系		○	154	63	-	-	-	-
HPCW	高圧炉心スプレイ補機冷却系		○	-	-	-	-	-	-
HPSW	高圧炉心スプレイ補機海水系		○	-	-	-	-	-	-
RCIC	原子炉隔離時冷却系		○	-	-	-	-	-	-
RHR(A)	残留熱除去系(A)		○	311	-	-	-	-	-
RHR(B)	残留熱除去系(B)		○	306	-	-	-	-	-
RHR(C)	残留熱除去系(C)		○	-	-	-	-	-	-
LPCS	低圧炉心スプレイ系		○	-	-	-	-	-	-
HPCS	高圧炉心スプレイ系		○	-	-	-	-	-	-
SLC	ほう酸水注入系		○	8	-	-	-	-	-
RWL(E)	液体廃棄物処理系(機器ドレン)		○	-	-	-	-	-	-
RWL(F)	液体廃棄物処理系(床ドレン・化学廃液系)		○	-	-	-	-	-	-
CWT	複水輸送系		○	58	2	-	-	-	-
MUW	補給水系		○	33	28	-	-	-	-
FP	消火系		○	66	58	-	-	-	□
HS	所内蒸気系(蒸気凝縮水戻り側)		○	-	-	-	-	-	-
DEGOW(A)	非常用ディーゼル発電機系(冷却水系)(A)		○	-	-	-	-	-	-
DEGOW(B)	非常用ディーゼル発電機系(冷却水系)(B)		○	-	-	-	-	-	-
DEGLO(A)	非常用ディーゼル発電機系(潤滑油系)(A)		○	-	-	-	-	-	-
DEGLO(B)	非常用ディーゼル発電機系(潤滑油系)(B)		○	-	-	-	-	-	-
DEGFO(A)	非常用ディーゼル発電機系(燃料油系)(A)		○	-	-	-	-	-	-
DEGFO(B)	非常用ディーゼル発電機系(燃料油系)(B)		○	-	-	-	-	-	-
DEGOW(H)	非常用ディーゼル発電機系(冷却水系)(HPCS)		○	-	-	-	-	-	-
DEGLO(H)	非常用ディーゼル発電機系(潤滑油系)(HPCS)		○	-	-	-	-	-	-
DEGFO(H)	非常用ディーゼル発電機系(燃料油系)(HPCS)		○	-	-	-	-	-	-
FMW	燃料プール補給水系		○	-	1	●	-	-	-

●:溢水源あり
 □:溢水源あり(耐震B.Cクラスであるが、基準地震動S₁による地震力に対してバウンダリ機能が保持できる)
 -:溢水源なし

添付第3.1-5表 地震時に溢水源とする機器としない機器(配管系)

7号炉原子炉建屋 (3/5)

区画 No	配管系統 【○:溢水源としない(耐震性を確認)、×:溢水源とする、-:当該区画に水を内包する配管が存在しない】																		
	ORD	CUW	DW	C,FDW	FP	FPC	HD	HNCW	HSCR	HWH	MSC	MUWC	MUWP	RCW	RD	SPCU	TCW	TSW	FEI
R-2F-10上	-	-	-	-	-	-	-	-	-	-	-	-	-	○	-	-	-	-	-
R-2F-10下	-	-	-	-	○	-	-	-	-	-	-	-	-	○	-	-	-	-	-
R-2F-11	-	-	-	-	○	-	-	-	-	-	-	-	-	○	-	-	-	-	-
R-2F-12	-	-	-	-	-	○	-	-	-	-	-	-	-	-	○	-	-	-	-
R-1F-1	-	-	-	-	-	○	-	-	-	-	-	○	-	○	-	-	-	-	-
R-1F-2共	-	×	-	-	○	×	-	×	-	×	-	○	○	×	-	○	-	-	-
R-1F-2p1	-	-	-	-	-	-	-	-	-	-	-	-	-	○	-	-	-	-	-
R-1F-2p2	-	-	-	-	-	-	-	-	-	-	-	-	-	-	-	-	-	-	-
R-1F-2p3	-	-	-	-	-	-	-	-	-	-	-	-	-	-	-	-	-	-	-
R-1F-2p4	-	○	-	-	-	-	-	-	-	-	-	-	○	-	-	-	-	-	-
R-1F-3	-	-	-	-	-	-	-	-	-	-	-	-	○	○	-	-	-	-	-
R-1F-4	-	-	-	-	○	-	-	-	-	-	-	-	○	○	-	-	-	-	-
R-1F-5	-	-	-	-	-	-	-	-	-	-	-	-	○	○	-	-	-	-	-
R-1F-6	-	-	-	-	○	-	-	○	-	-	-	-	○	○	-	-	-	-	-
R-1F-7	-	-	-	-	○	-	-	○	-	-	-	-	-	○	-	-	-	-	-
R-1F-8	-	-	-	-	-	○	-	-	-	-	-	○	-	-	-	-	-	-	-
R-1F-9	-	-	-	-	-	○	-	-	-	-	-	○	-	-	-	-	-	-	-

表1-2 溢水源となり得る系統の設置区画及び溢水量 (10/27)

原子炉建物 2階

系統略称	系統名称	耐震クラス		溢水量		区画番号及び区画滞留面積(上段:区画番号,下段:区画滞留面積[m ²])			
		S	B, C	想定破壊 [m ³]	地震起因 [m ³]	二次格外(非管理区域)			
						R-2F-21N	R-2F-22N	R-2F-23N	R-2F-29N
OW	復水給水系		○	-	-	-	-	-	-
FW			○	67	12	-	-	-	-
CRD	制御棒駆動系		○	158	158	-	-	-	-
CUW	原子炉浄化系		○	101	-	●	-	-	-
RCW(A)	原子炉補機冷却系(非常用HVC(A)系)		○	120	-	●	-	-	-
RCW(B)	原子炉補機冷却系(非常用HVC(B)系II)		○	143	158	●	-	-	-
RCW(N)	原子炉補機冷却系(常用品)		○	-	-	-	-	-	-
HVD	ドライウェル冷却系		○	-	-	-	-	-	-
HVCW	空腔換気設備冷却水系		○	-	-	-	-	-	-
RSW(A)	原子炉補機海水系(I)		○	-	-	-	-	-	-
RSW(B)	原子炉補機海水系(II)		○	-	-	-	-	-	-
FPC	燃料プール冷却系		○	154	63	-	-	-	-
HPCW	高圧炉心スプレイ補機冷却系		○	-	-	-	-	-	-
HPSW	高圧炉心スプレイ補機海水系		○	-	-	-	-	-	-
RCIC	原子炉隔離時冷却系		○	-	-	-	-	-	-
RHR(A)	残留熱除去系(A)		○	311	-	-	-	-	-
RHR(B)	残留熱除去系(B)		○	306	-	-	-	-	-
RHR(C)	残留熱除去系(C)		○	235	-	-	-	-	-
LPCS	低圧炉心スプレイ系		○	-	-	-	-	-	-
HPCS	高圧炉心スプレイ系		○	-	-	-	-	-	-
SLO	ほう酸水注入系		○	8	-	-	-	-	-
RWL(E)	液体廃棄物処理系(機器ドレン)		○	-	-	-	-	-	-
RWL(F)	液体廃棄物処理系(床ドレン・化学廃液系)		○	-	-	-	-	-	-
CWT	復水輸送系		○	59	28	-	-	-	-
MUW	補給水系		○	33	28	-	-	-	-
FP	消火系		○	67	59	□	-	●	-
HS	所内蒸気系(蒸気凝縮水戻り側)		○	-	-	-	-	-	-
DEG(CW/A)	非常用ディーゼル発電機系(冷却水系)(A)		○	-	-	-	-	-	-
DEG(CW/B)	非常用ディーゼル発電機系(冷却水系)(B)		○	-	-	-	-	-	-
DEG(LO/A)	非常用ディーゼル発電機系(潤滑油系)(A)		○	-	-	-	-	-	-
DEG(LO/B)	非常用ディーゼル発電機系(潤滑油系)(B)		○	-	-	-	-	-	-
DEG(FO/A)	非常用ディーゼル発電機系(燃料油系)(A)		○	-	-	-	-	-	-
DEG(FO/B)	非常用ディーゼル発電機系(燃料油系)(B)		○	-	-	-	-	-	-
DEG(CW/H)	非常用ディーゼル発電機系(冷却水系)(HPCS)		○	-	-	-	-	-	-
DEG(LO/H)	非常用ディーゼル発電機系(潤滑油系)(HPCS)		○	-	-	-	-	-	-
DEG(FO/H)	非常用ディーゼル発電機系(燃料油系)(HPCS)		○	-	-	-	-	-	-
FMW	燃料プール補給水系		○	-	1	-	-	-	-

●:溢水源あり
 □:溢水源あり(耐震B/Cクラスであるが、基準地震動S1による地震力に対してバウンダリ機能が保持できる)
 -:溢水源なし

柏崎刈羽原子力発電所 6/7号炉 (2017.12.20版)	東海第二発電所 (2018.9.18版)	島根原子力発電所 2号炉	備考																																																																																																																																																																																																																																																																																																																																																																																																																																																																																																																																																																																																																																																																																																																																																																																																																																																																																									
添付第3.1-6表 地震時に溢水源とする機器としない機器(配管系) 7号炉タービン建屋(2/2)		表1-2 溢水源となり得る系統の設置区画及び溢水量(14/27)																																																																																																																																																																																																																																																																																																																																																																																																																																																																																																																																																																																																																																																																																																																																																																																																																																																																																										
<table border="1"> <thead> <tr> <th rowspan="2">区画 No</th> <th colspan="16">配管系統 【○:溢水源としない(耐震性を確認), ×:溢水源とする, -:当該区画に水を内包する配管が存在しない】</th> </tr> <tr> <th>CRD</th><th>CUW</th><th>DW</th><th>C.FDW</th><th>FP</th><th>FPC</th><th>HD</th><th>HNCW</th><th>HSCR</th><th>HWH</th><th>MSC</th><th>MUWC</th><th>MUWP</th><th>RCW</th><th>RD</th><th>SPCU</th><th>TCW</th><th>TSW</th><th>FEI</th> </tr> </thead> <tbody> <tr> <td>T-B2-3</td> <td>×</td><td>-</td><td>×</td><td>×</td><td>×</td><td>-</td><td>×</td><td>×</td><td>-</td><td>-</td><td>×</td><td>×</td><td>×</td><td>×</td><td>×</td><td>-</td><td>×</td><td>-</td><td>-</td> </tr> <tr> <td>T-B2-4</td> <td>-</td><td>-</td><td>×</td><td>-</td><td>×</td><td>-</td><td>-</td><td>×</td><td>-</td><td>-</td><td>×</td><td>-</td><td>-</td><td>×</td><td>-</td><td>-</td><td>×</td><td>×</td><td>×</td> </tr> </tbody> </table>		区画 No	配管系統 【○:溢水源としない(耐震性を確認), ×:溢水源とする, -:当該区画に水を内包する配管が存在しない】																CRD	CUW	DW	C.FDW	FP	FPC	HD	HNCW	HSCR	HWH	MSC	MUWC	MUWP	RCW	RD	SPCU	TCW	TSW	FEI	T-B2-3	×	-	×	×	×	-	×	×	-	-	×	×	×	×	×	-	×	-	-	T-B2-4	-	-	×	-	×	-	-	×	-	-	×	-	-	×	-	-	×	×	×	<p>原子炉建物 1階</p> <table border="1"> <thead> <tr> <th rowspan="3">系統略称</th> <th rowspan="3">系統名称</th> <th colspan="2">耐震クラス</th> <th colspan="2">溢水量</th> <th colspan="11">区画番号及び区画滞留面積(上段:区画番号,下段:区画滞留面積[m²])</th> </tr> <tr> <th rowspan="2">S</th> <th rowspan="2">B, C</th> <th rowspan="2">想定破断[m³]</th> <th rowspan="2">地震起因[m³]</th> <th colspan="5">二次冷却(管理区域)</th> <th colspan="6">三次冷却(非管理区域)</th> </tr> <tr> <th>R-1F-01-2N</th><th>R-1F-102N</th><th>R-1F-02N</th><th>R-1F-14N</th><th>R-1F-15N</th><th>R-1F-24-1N</th><th>R-1F-24-2N</th><th>R-1F-27N</th><th>R-1F-31N</th> </tr> </thead> <tbody> <tr> <td>OW FW</td> <td>復水給水系</td> <td>○</td> <td></td> <td>456</td> <td>163</td> <td>-</td><td>-</td><td>-</td><td>-</td><td>-</td><td>-</td><td>-</td><td>-</td><td>-</td><td>-</td><td>-</td><td>-</td><td>-</td><td>-</td> </tr> <tr> <td>CRD</td> <td>制御棒駆動系</td> <td>○</td> <td></td> <td>67</td> <td>12</td> <td>-</td><td>-</td><td>-</td><td>-</td><td>-</td><td>-</td><td>-</td><td>-</td><td>-</td><td>-</td><td>-</td><td>-</td><td>-</td><td>-</td> </tr> <tr> <td>CUW</td> <td>原子炉浄化系</td> <td>○</td> <td></td> <td>158</td> <td>158</td> <td>-</td><td>-</td><td>-</td><td>-</td><td>-</td><td>-</td><td>-</td><td>-</td><td>-</td><td>-</td><td>-</td><td>-</td><td>-</td><td>-</td> </tr> <tr> <td>ROW(A)</td> <td>原子炉補機冷却系(非常用系)</td> <td>○</td> <td></td> <td>164</td> <td>-</td> <td>-</td><td>-</td><td>-</td><td>●</td><td>-</td><td>-</td><td>-</td><td>-</td><td>-</td><td>-</td><td>-</td><td>-</td><td>-</td><td>-</td> </tr> <tr> <td>ROW(B)</td> <td>原子炉補機冷却系(非常用系)</td> <td>○</td> <td></td> <td>188</td> <td>-</td> <td>-</td><td>-</td><td>-</td><td>-</td><td>●</td><td>-</td><td>-</td><td>-</td><td>-</td><td>-</td><td>-</td><td>-</td><td>-</td><td>-</td> </tr> <tr> <td>RCW(N)</td> <td>原子炉補機冷却系(常用系)</td> <td></td> <td></td> <td></td> <td></td> <td></td> <td></td> <td></td> <td></td> <td></td> <td></td> <td></td> <td></td> <td></td> <td></td> <td></td> <td></td> <td></td> <td></td> </tr> <tr> <td>HVD</td> <td>ドライウェル冷却系</td> <td></td> <td></td> <td></td> <td></td> <td></td> <td></td> <td></td> <td></td> <td></td> <td></td> <td></td> <td></td> <td></td> <td></td> <td></td> <td></td> <td></td> <td></td> </tr> <tr> <td>HVCW</td> <td>空温熱気設備冷却水系</td> <td></td> <td></td> <td></td> <td></td> <td></td> <td></td> <td></td> <td></td> <td></td> <td></td> <td></td> <td></td> <td></td> <td></td> <td></td> <td></td> <td></td> <td></td> </tr> <tr> <td>RSW(A)</td> <td>原子炉補機海水系(I)</td> <td>○</td> <td></td> <td>457</td> <td>-</td> <td>-</td><td>-</td><td>-</td><td>●</td><td>-</td><td>-</td><td>-</td><td>-</td><td>-</td><td>-</td><td>-</td><td>-</td><td>-</td><td>-</td> </tr> <tr> <td>RSW(B)</td> <td>原子炉補機海水系(II)</td> <td>○</td> <td></td> <td>457</td> <td>-</td> <td>-</td><td>-</td><td>-</td><td>-</td><td>●</td><td>-</td><td>-</td><td>-</td><td>-</td><td>-</td><td>-</td><td>-</td><td>-</td><td>-</td> </tr> <tr> <td>FPC</td> <td>燃料プール冷却系</td> <td>○</td> <td>○</td> <td>154</td> <td>63</td> <td>-</td><td>-</td><td>-</td><td>-</td><td>-</td><td>-</td><td>-</td><td>-</td><td>-</td><td>-</td><td>-</td><td>-</td><td>-</td><td>-</td> </tr> <tr> <td>HPCW</td> <td>高圧炉心スプレイ補機冷却系</td> <td>○</td> <td></td> <td>43</td> <td>-</td> <td>-</td><td>-</td><td>-</td><td>-</td><td>-</td><td>-</td><td>-</td><td>-</td><td>-</td><td>-</td><td>-</td><td>-</td><td>-</td><td>-</td> </tr> <tr> <td>HPSW</td> <td>高圧炉心スプレイ補機海水系</td> <td>○</td> <td></td> <td>-</td> <td>-</td> <td>-</td><td>-</td><td>-</td><td>-</td><td>-</td><td>-</td><td>-</td><td>-</td><td>-</td><td>-</td><td>-</td><td>-</td><td>-</td><td>-</td> </tr> <tr> <td>RCIC</td> <td>原子炉隔離時冷却系</td> <td>○</td> <td></td> <td>-</td> <td>-</td> <td>-</td><td>-</td><td>-</td><td>-</td><td>-</td><td>-</td><td>-</td><td>-</td><td>-</td><td>-</td><td>-</td><td>-</td><td>-</td><td>-</td> </tr> <tr> <td>RHRA</td> <td>残留熱除去系(A)</td> <td>○</td> <td></td> <td>311</td> <td>-</td> <td>-</td><td>-</td><td>-</td><td>-</td><td>-</td><td>-</td><td>-</td><td>-</td><td>-</td><td>-</td><td>-</td><td>-</td><td>-</td><td>-</td> </tr> <tr> <td>RHR(B)</td> <td>残留熱除去系(B)</td> <td>○</td> <td></td> <td>306</td> <td>-</td> <td>-</td><td>-</td><td>-</td><td>-</td><td>-</td><td>-</td><td>-</td><td>-</td><td>-</td><td>-</td><td>-</td><td>-</td><td>-</td><td>-</td> </tr> <tr> <td>RHR(C)</td> <td>残留熱除去系(C)</td> <td>○</td> <td></td> <td>235</td> <td>-</td> <td>-</td><td>-</td><td>-</td><td>-</td><td>-</td><td>-</td><td>-</td><td>-</td><td>-</td><td>-</td><td>-</td><td>-</td><td>-</td><td>-</td> </tr> <tr> <td>LPCS</td> <td>低圧炉心スプレイ系</td> <td>○</td> <td></td> <td>231</td> <td>-</td> <td>-</td><td>-</td><td>-</td><td>-</td><td>-</td><td>-</td><td>-</td><td>-</td><td>-</td><td>-</td><td>-</td><td>-</td><td>-</td><td>-</td> </tr> <tr> <td>HPCS</td> <td>高圧炉心スプレイ系</td> <td>○</td> <td></td> <td>495</td> <td>-</td> <td>-</td><td>-</td><td>-</td><td>-</td><td>-</td><td>-</td><td>-</td><td>-</td><td>-</td><td>-</td><td>-</td><td>-</td><td>-</td><td>-</td> </tr> <tr> <td>SLC</td> <td>ほう酸水注入系</td> <td>○</td> <td></td> <td>8</td> <td>-</td> <td>-</td><td>-</td><td>-</td><td>-</td><td>-</td><td>-</td><td>-</td><td>-</td><td>-</td><td>-</td><td>-</td><td>-</td><td>-</td><td>-</td> </tr> <tr> <td>RW(L)E</td> <td>液体廃棄物処理系(機器ドレン)</td> <td>○</td> <td></td> <td>-</td> <td>-</td> <td>-</td><td>-</td><td>-</td><td>-</td><td>-</td><td>-</td><td>-</td><td>-</td><td>-</td><td>-</td><td>-</td><td>-</td><td>-</td><td>-</td> </tr> <tr> <td>RW(L)F</td> <td>液体廃棄物処理系(床ドレン・化学廃液系)</td> <td>○</td> <td></td> <td>-</td> <td>-</td> <td>-</td><td>-</td><td>-</td><td>-</td><td>-</td><td>-</td><td>-</td><td>-</td><td>-</td><td>-</td><td>-</td><td>-</td><td>-</td><td>-</td> </tr> <tr> <td>CWT</td> <td>復水補送系</td> <td>○</td> <td></td> <td>61</td> <td>30</td> <td>-</td><td>-</td><td>-</td><td>-</td><td>-</td><td>-</td><td>-</td><td>-</td><td>-</td><td>-</td><td>-</td><td>-</td><td>-</td><td>-</td> </tr> <tr> <td>MUW</td> <td>補給水系</td> <td>○</td> <td></td> <td>33</td> <td>28</td> <td>-</td><td>-</td><td>-</td><td>-</td><td>-</td><td>-</td><td>-</td><td>□</td><td>-</td><td>-</td><td>-</td><td>-</td><td>-</td><td>-</td> </tr> <tr> <td>FP</td> <td>消火系</td> <td>○</td> <td></td> <td>68</td> <td>60</td> <td>-</td><td>-</td><td>-</td><td>●</td><td>□</td><td>□</td><td>-</td><td>□</td><td>-</td><td>□</td><td>-</td><td>-</td><td>-</td><td>-</td> </tr> <tr> <td>HS</td> <td>所内蒸気系(蒸気凝縮水戻り物)</td> <td>○</td> <td></td> <td>-</td> <td>-</td> <td>-</td><td>-</td><td>-</td><td>-</td><td>-</td><td>-</td><td>-</td><td>-</td><td>-</td><td>-</td><td>-</td><td>-</td><td>-</td><td>-</td> </tr> <tr> <td>DELO(A)</td> <td>非常用ディーゼル発電機系(冷却水系)(A)</td> <td>○</td> <td></td> <td>-</td> <td>-</td> <td>-</td><td>-</td><td>-</td><td>-</td><td>-</td><td>-</td><td>-</td><td>-</td><td>-</td><td>-</td><td>-</td><td>-</td><td>-</td><td>-</td> </tr> <tr> <td>DELO(B)</td> <td>非常用ディーゼル発電機系(冷却水系)(B)</td> <td>○</td> <td></td> <td>-</td> <td>-</td> <td>-</td><td>-</td><td>-</td><td>-</td><td>-</td><td>-</td><td>-</td><td>-</td><td>-</td><td>-</td><td>-</td><td>-</td><td>-</td><td>-</td> </tr> <tr> <td>DELO(A)</td> <td>非常用ディーゼル発電機系(燃料油系)(A)</td> <td>○</td> <td></td> <td>-</td> <td>-</td> <td>-</td><td>-</td><td>-</td><td>-</td><td>-</td><td>-</td><td>-</td><td>-</td><td>-</td><td>-</td><td>-</td><td>-</td><td>-</td><td>-</td> </tr> <tr> <td>DELO(B)</td> <td>非常用ディーゼル発電機系(燃料油系)(B)</td> <td>○</td> <td></td> <td>-</td> <td>-</td> <td>-</td><td>-</td><td>-</td><td>-</td><td>-</td><td>-</td><td>-</td><td>-</td><td>-</td><td>-</td><td>-</td><td>-</td><td>-</td><td>-</td> </tr> <tr> <td>DEFO(A)</td> <td>非常用ディーゼル発電機系(燃料油系)(A)</td> <td>○</td> <td></td> <td>-</td> <td>-</td> <td>-</td><td>-</td><td>-</td><td>-</td><td>-</td><td>-</td><td>-</td><td>-</td><td>-</td><td>-</td><td>-</td><td>-</td><td>-</td><td>-</td> </tr> <tr> <td>DEFO(B)</td> <td>非常用ディーゼル発電機系(燃料油系)(B)</td> <td>○</td> <td></td> <td>-</td> <td>-</td> <td>-</td><td>-</td><td>-</td><td>-</td><td>-</td><td>-</td><td>-</td><td>-</td><td>-</td><td>-</td><td>-</td><td>-</td><td>-</td><td>-</td> </tr> <tr> <td>DECO(A)</td> <td>非常用ディーゼル発電機系(冷却水系)(HPCS)</td> <td>○</td> <td></td> <td>-</td> <td>-</td> <td>-</td><td>-</td><td>-</td><td>-</td><td>-</td><td>-</td><td>-</td><td>-</td><td>-</td><td>-</td><td>-</td><td>-</td><td>-</td><td>-</td> </tr> <tr> <td>DECO(B)</td> <td>非常用ディーゼル発電機系(冷却水系)(HPCS)</td> <td>○</td> <td></td> <td>-</td> <td>-</td> <td>-</td><td>-</td><td>-</td><td>-</td><td>-</td><td>-</td><td>-</td><td>-</td><td>-</td><td>-</td><td>-</td><td>-</td><td>-</td><td>-</td> </tr> <tr> <td>DEFO(A)</td> <td>非常用ディーゼル発電機系(燃料油系)(HPCS)</td> <td>○</td> <td></td> <td>-</td> <td>-</td> <td>-</td><td>-</td><td>-</td><td>-</td><td>-</td><td>-</td><td>-</td><td>-</td><td>-</td><td>-</td><td>-</td><td>-</td><td>-</td><td>-</td> </tr> <tr> <td>DEFO(B)</td> <td>非常用ディーゼル発電機系(燃料油系)(HPCS)</td> <td>○</td> <td></td> <td>-</td> <td>-</td> <td>-</td><td>-</td><td>-</td><td>-</td><td>-</td><td>-</td><td>-</td><td>-</td><td>-</td><td>-</td><td>-</td><td>-</td><td>-</td><td>-</td> </tr> <tr> <td>FMW</td> <td>燃料プール補給水系</td> <td>○</td> <td></td> <td>-</td> <td>1</td> <td>-</td><td>-</td><td>-</td><td>-</td><td>-</td><td>-</td><td>-</td><td>-</td><td>-</td><td>-</td><td>-</td><td>-</td><td>-</td><td>-</td> </tr> </tbody> </table> <p>●: 溢水あり □: 溢水あり(耐震Bクラスであるが、基準地震動Saによる地震力に対してバウダンリ機能が保持できる) -: 溢水なし</p>		系統略称	系統名称	耐震クラス		溢水量		区画番号及び区画滞留面積(上段:区画番号,下段:区画滞留面積[m ²])											S	B, C	想定破断[m ³]	地震起因[m ³]	二次冷却(管理区域)					三次冷却(非管理区域)						R-1F-01-2N	R-1F-102N	R-1F-02N	R-1F-14N	R-1F-15N	R-1F-24-1N	R-1F-24-2N	R-1F-27N	R-1F-31N	OW FW	復水給水系	○		456	163	-	-	-	-	-	-	-	-	-	-	-	-	-	-	CRD	制御棒駆動系	○		67	12	-	-	-	-	-	-	-	-	-	-	-	-	-	-	CUW	原子炉浄化系	○		158	158	-	-	-	-	-	-	-	-	-	-	-	-	-	-	ROW(A)	原子炉補機冷却系(非常用系)	○		164	-	-	-	-	●	-	-	-	-	-	-	-	-	-	-	ROW(B)	原子炉補機冷却系(非常用系)	○		188	-	-	-	-	-	●	-	-	-	-	-	-	-	-	-	RCW(N)	原子炉補機冷却系(常用系)																			HVD	ドライウェル冷却系																			HVCW	空温熱気設備冷却水系																			RSW(A)	原子炉補機海水系(I)	○		457	-	-	-	-	●	-	-	-	-	-	-	-	-	-	-	RSW(B)	原子炉補機海水系(II)	○		457	-	-	-	-	-	●	-	-	-	-	-	-	-	-	-	FPC	燃料プール冷却系	○	○	154	63	-	-	-	-	-	-	-	-	-	-	-	-	-	-	HPCW	高圧炉心スプレイ補機冷却系	○		43	-	-	-	-	-	-	-	-	-	-	-	-	-	-	-	HPSW	高圧炉心スプレイ補機海水系	○		-	-	-	-	-	-	-	-	-	-	-	-	-	-	-	-	RCIC	原子炉隔離時冷却系	○		-	-	-	-	-	-	-	-	-	-	-	-	-	-	-	-	RHRA	残留熱除去系(A)	○		311	-	-	-	-	-	-	-	-	-	-	-	-	-	-	-	RHR(B)	残留熱除去系(B)	○		306	-	-	-	-	-	-	-	-	-	-	-	-	-	-	-	RHR(C)	残留熱除去系(C)	○		235	-	-	-	-	-	-	-	-	-	-	-	-	-	-	-	LPCS	低圧炉心スプレイ系	○		231	-	-	-	-	-	-	-	-	-	-	-	-	-	-	-	HPCS	高圧炉心スプレイ系	○		495	-	-	-	-	-	-	-	-	-	-	-	-	-	-	-	SLC	ほう酸水注入系	○		8	-	-	-	-	-	-	-	-	-	-	-	-	-	-	-	RW(L)E	液体廃棄物処理系(機器ドレン)	○		-	-	-	-	-	-	-	-	-	-	-	-	-	-	-	-	RW(L)F	液体廃棄物処理系(床ドレン・化学廃液系)	○		-	-	-	-	-	-	-	-	-	-	-	-	-	-	-	-	CWT	復水補送系	○		61	30	-	-	-	-	-	-	-	-	-	-	-	-	-	-	MUW	補給水系	○		33	28	-	-	-	-	-	-	-	□	-	-	-	-	-	-	FP	消火系	○		68	60	-	-	-	●	□	□	-	□	-	□	-	-	-	-	HS	所内蒸気系(蒸気凝縮水戻り物)	○		-	-	-	-	-	-	-	-	-	-	-	-	-	-	-	-	DELO(A)	非常用ディーゼル発電機系(冷却水系)(A)	○		-	-	-	-	-	-	-	-	-	-	-	-	-	-	-	-	DELO(B)	非常用ディーゼル発電機系(冷却水系)(B)	○		-	-	-	-	-	-	-	-	-	-	-	-	-	-	-	-	DELO(A)	非常用ディーゼル発電機系(燃料油系)(A)	○		-	-	-	-	-	-	-	-	-	-	-	-	-	-	-	-	DELO(B)	非常用ディーゼル発電機系(燃料油系)(B)	○		-	-	-	-	-	-	-	-	-	-	-	-	-	-	-	-	DEFO(A)	非常用ディーゼル発電機系(燃料油系)(A)	○		-	-	-	-	-	-	-	-	-	-	-	-	-	-	-	-	DEFO(B)	非常用ディーゼル発電機系(燃料油系)(B)	○		-	-	-	-	-	-	-	-	-	-	-	-	-	-	-	-	DECO(A)	非常用ディーゼル発電機系(冷却水系)(HPCS)	○		-	-	-	-	-	-	-	-	-	-	-	-	-	-	-	-	DECO(B)	非常用ディーゼル発電機系(冷却水系)(HPCS)	○		-	-	-	-	-	-	-	-	-	-	-	-	-	-	-	-	DEFO(A)	非常用ディーゼル発電機系(燃料油系)(HPCS)	○		-	-	-	-	-	-	-	-	-	-	-	-	-	-	-	-	DEFO(B)	非常用ディーゼル発電機系(燃料油系)(HPCS)	○		-	-	-	-	-	-	-	-	-	-	-	-	-	-	-	-	FMW	燃料プール補給水系	○		-	1	-	-	-	-	-	-	-	-	-	-	-	-	-	-
区画 No	配管系統 【○:溢水源としない(耐震性を確認), ×:溢水源とする, -:当該区画に水を内包する配管が存在しない】																																																																																																																																																																																																																																																																																																																																																																																																																																																																																																																																																																																																																																																																																																																																																																																																																																																																																											
	CRD	CUW	DW	C.FDW	FP	FPC	HD	HNCW	HSCR	HWH	MSC	MUWC	MUWP	RCW	RD	SPCU	TCW	TSW	FEI																																																																																																																																																																																																																																																																																																																																																																																																																																																																																																																																																																																																																																																																																																																																																																																																																																																																									
T-B2-3	×	-	×	×	×	-	×	×	-	-	×	×	×	×	×	-	×	-	-																																																																																																																																																																																																																																																																																																																																																																																																																																																																																																																																																																																																																																																																																																																																																																																																																																																																									
T-B2-4	-	-	×	-	×	-	-	×	-	-	×	-	-	×	-	-	×	×	×																																																																																																																																																																																																																																																																																																																																																																																																																																																																																																																																																																																																																																																																																																																																																																																																																																																																									
系統略称	系統名称	耐震クラス		溢水量		区画番号及び区画滞留面積(上段:区画番号,下段:区画滞留面積[m ²])																																																																																																																																																																																																																																																																																																																																																																																																																																																																																																																																																																																																																																																																																																																																																																																																																																																																																						
		S	B, C	想定破断[m ³]	地震起因[m ³]	二次冷却(管理区域)					三次冷却(非管理区域)																																																																																																																																																																																																																																																																																																																																																																																																																																																																																																																																																																																																																																																																																																																																																																																																																																																																																	
						R-1F-01-2N	R-1F-102N	R-1F-02N	R-1F-14N	R-1F-15N	R-1F-24-1N	R-1F-24-2N	R-1F-27N	R-1F-31N																																																																																																																																																																																																																																																																																																																																																																																																																																																																																																																																																																																																																																																																																																																																																																																																																																																																														
OW FW	復水給水系	○		456	163	-	-	-	-	-	-	-	-	-	-	-	-	-	-																																																																																																																																																																																																																																																																																																																																																																																																																																																																																																																																																																																																																																																																																																																																																																																																																																																																									
CRD	制御棒駆動系	○		67	12	-	-	-	-	-	-	-	-	-	-	-	-	-	-																																																																																																																																																																																																																																																																																																																																																																																																																																																																																																																																																																																																																																																																																																																																																																																																																																																																									
CUW	原子炉浄化系	○		158	158	-	-	-	-	-	-	-	-	-	-	-	-	-	-																																																																																																																																																																																																																																																																																																																																																																																																																																																																																																																																																																																																																																																																																																																																																																																																																																																																									
ROW(A)	原子炉補機冷却系(非常用系)	○		164	-	-	-	-	●	-	-	-	-	-	-	-	-	-	-																																																																																																																																																																																																																																																																																																																																																																																																																																																																																																																																																																																																																																																																																																																																																																																																																																																																									
ROW(B)	原子炉補機冷却系(非常用系)	○		188	-	-	-	-	-	●	-	-	-	-	-	-	-	-	-																																																																																																																																																																																																																																																																																																																																																																																																																																																																																																																																																																																																																																																																																																																																																																																																																																																																									
RCW(N)	原子炉補機冷却系(常用系)																																																																																																																																																																																																																																																																																																																																																																																																																																																																																																																																																																																																																																																																																																																																																																																																																																																																																											
HVD	ドライウェル冷却系																																																																																																																																																																																																																																																																																																																																																																																																																																																																																																																																																																																																																																																																																																																																																																																																																																																																																											
HVCW	空温熱気設備冷却水系																																																																																																																																																																																																																																																																																																																																																																																																																																																																																																																																																																																																																																																																																																																																																																																																																																																																																											
RSW(A)	原子炉補機海水系(I)	○		457	-	-	-	-	●	-	-	-	-	-	-	-	-	-	-																																																																																																																																																																																																																																																																																																																																																																																																																																																																																																																																																																																																																																																																																																																																																																																																																																																																									
RSW(B)	原子炉補機海水系(II)	○		457	-	-	-	-	-	●	-	-	-	-	-	-	-	-	-																																																																																																																																																																																																																																																																																																																																																																																																																																																																																																																																																																																																																																																																																																																																																																																																																																																																									
FPC	燃料プール冷却系	○	○	154	63	-	-	-	-	-	-	-	-	-	-	-	-	-	-																																																																																																																																																																																																																																																																																																																																																																																																																																																																																																																																																																																																																																																																																																																																																																																																																																																																									
HPCW	高圧炉心スプレイ補機冷却系	○		43	-	-	-	-	-	-	-	-	-	-	-	-	-	-	-																																																																																																																																																																																																																																																																																																																																																																																																																																																																																																																																																																																																																																																																																																																																																																																																																																																																									
HPSW	高圧炉心スプレイ補機海水系	○		-	-	-	-	-	-	-	-	-	-	-	-	-	-	-	-																																																																																																																																																																																																																																																																																																																																																																																																																																																																																																																																																																																																																																																																																																																																																																																																																																																																									
RCIC	原子炉隔離時冷却系	○		-	-	-	-	-	-	-	-	-	-	-	-	-	-	-	-																																																																																																																																																																																																																																																																																																																																																																																																																																																																																																																																																																																																																																																																																																																																																																																																																																																																									
RHRA	残留熱除去系(A)	○		311	-	-	-	-	-	-	-	-	-	-	-	-	-	-	-																																																																																																																																																																																																																																																																																																																																																																																																																																																																																																																																																																																																																																																																																																																																																																																																																																																																									
RHR(B)	残留熱除去系(B)	○		306	-	-	-	-	-	-	-	-	-	-	-	-	-	-	-																																																																																																																																																																																																																																																																																																																																																																																																																																																																																																																																																																																																																																																																																																																																																																																																																																																																									
RHR(C)	残留熱除去系(C)	○		235	-	-	-	-	-	-	-	-	-	-	-	-	-	-	-																																																																																																																																																																																																																																																																																																																																																																																																																																																																																																																																																																																																																																																																																																																																																																																																																																																																									
LPCS	低圧炉心スプレイ系	○		231	-	-	-	-	-	-	-	-	-	-	-	-	-	-	-																																																																																																																																																																																																																																																																																																																																																																																																																																																																																																																																																																																																																																																																																																																																																																																																																																																																									
HPCS	高圧炉心スプレイ系	○		495	-	-	-	-	-	-	-	-	-	-	-	-	-	-	-																																																																																																																																																																																																																																																																																																																																																																																																																																																																																																																																																																																																																																																																																																																																																																																																																																																																									
SLC	ほう酸水注入系	○		8	-	-	-	-	-	-	-	-	-	-	-	-	-	-	-																																																																																																																																																																																																																																																																																																																																																																																																																																																																																																																																																																																																																																																																																																																																																																																																																																																																									
RW(L)E	液体廃棄物処理系(機器ドレン)	○		-	-	-	-	-	-	-	-	-	-	-	-	-	-	-	-																																																																																																																																																																																																																																																																																																																																																																																																																																																																																																																																																																																																																																																																																																																																																																																																																																																																									
RW(L)F	液体廃棄物処理系(床ドレン・化学廃液系)	○		-	-	-	-	-	-	-	-	-	-	-	-	-	-	-	-																																																																																																																																																																																																																																																																																																																																																																																																																																																																																																																																																																																																																																																																																																																																																																																																																																																																									
CWT	復水補送系	○		61	30	-	-	-	-	-	-	-	-	-	-	-	-	-	-																																																																																																																																																																																																																																																																																																																																																																																																																																																																																																																																																																																																																																																																																																																																																																																																																																																																									
MUW	補給水系	○		33	28	-	-	-	-	-	-	-	□	-	-	-	-	-	-																																																																																																																																																																																																																																																																																																																																																																																																																																																																																																																																																																																																																																																																																																																																																																																																																																																																									
FP	消火系	○		68	60	-	-	-	●	□	□	-	□	-	□	-	-	-	-																																																																																																																																																																																																																																																																																																																																																																																																																																																																																																																																																																																																																																																																																																																																																																																																																																																																									
HS	所内蒸気系(蒸気凝縮水戻り物)	○		-	-	-	-	-	-	-	-	-	-	-	-	-	-	-	-																																																																																																																																																																																																																																																																																																																																																																																																																																																																																																																																																																																																																																																																																																																																																																																																																																																																									
DELO(A)	非常用ディーゼル発電機系(冷却水系)(A)	○		-	-	-	-	-	-	-	-	-	-	-	-	-	-	-	-																																																																																																																																																																																																																																																																																																																																																																																																																																																																																																																																																																																																																																																																																																																																																																																																																																																																									
DELO(B)	非常用ディーゼル発電機系(冷却水系)(B)	○		-	-	-	-	-	-	-	-	-	-	-	-	-	-	-	-																																																																																																																																																																																																																																																																																																																																																																																																																																																																																																																																																																																																																																																																																																																																																																																																																																																																									
DELO(A)	非常用ディーゼル発電機系(燃料油系)(A)	○		-	-	-	-	-	-	-	-	-	-	-	-	-	-	-	-																																																																																																																																																																																																																																																																																																																																																																																																																																																																																																																																																																																																																																																																																																																																																																																																																																																																									
DELO(B)	非常用ディーゼル発電機系(燃料油系)(B)	○		-	-	-	-	-	-	-	-	-	-	-	-	-	-	-	-																																																																																																																																																																																																																																																																																																																																																																																																																																																																																																																																																																																																																																																																																																																																																																																																																																																																									
DEFO(A)	非常用ディーゼル発電機系(燃料油系)(A)	○		-	-	-	-	-	-	-	-	-	-	-	-	-	-	-	-																																																																																																																																																																																																																																																																																																																																																																																																																																																																																																																																																																																																																																																																																																																																																																																																																																																																									
DEFO(B)	非常用ディーゼル発電機系(燃料油系)(B)	○		-	-	-	-	-	-	-	-	-	-	-	-	-	-	-	-																																																																																																																																																																																																																																																																																																																																																																																																																																																																																																																																																																																																																																																																																																																																																																																																																																																																									
DECO(A)	非常用ディーゼル発電機系(冷却水系)(HPCS)	○		-	-	-	-	-	-	-	-	-	-	-	-	-	-	-	-																																																																																																																																																																																																																																																																																																																																																																																																																																																																																																																																																																																																																																																																																																																																																																																																																																																																									
DECO(B)	非常用ディーゼル発電機系(冷却水系)(HPCS)	○		-	-	-	-	-	-	-	-	-	-	-	-	-	-	-	-																																																																																																																																																																																																																																																																																																																																																																																																																																																																																																																																																																																																																																																																																																																																																																																																																																																																									
DEFO(A)	非常用ディーゼル発電機系(燃料油系)(HPCS)	○		-	-	-	-	-	-	-	-	-	-	-	-	-	-	-	-																																																																																																																																																																																																																																																																																																																																																																																																																																																																																																																																																																																																																																																																																																																																																																																																																																																																									
DEFO(B)	非常用ディーゼル発電機系(燃料油系)(HPCS)	○		-	-	-	-	-	-	-	-	-	-	-	-	-	-	-	-																																																																																																																																																																																																																																																																																																																																																																																																																																																																																																																																																																																																																																																																																																																																																																																																																																																																									
FMW	燃料プール補給水系	○		-	1	-	-	-	-	-	-	-	-	-	-	-	-	-	-																																																																																																																																																																																																																																																																																																																																																																																																																																																																																																																																																																																																																																																																																																																																																																																																																																																																									

柏崎刈羽原子力発電所 6/7号炉 (2017.12.20版)

添付第3.1-7表 地震時に溢水源とする機器としない機器(配管系)

6号及び7号炉コントロール建屋(1/3)

区画No	配管系統【○:溢水源としない(耐震性を確認)、×溢水源とする、-:当該区画に水を内包する配管が存在しない】								
	DW	FP	HNCW	MSC	MUWP	RCW	RD	TCW	飲料水系
C-2F-1	-	○	-	-	-	-	-	-	○
C-2F-2	-	-	-	-	-	-	-	-	-
C-2F-3	-	○	-	-	-	-	-	-	○
C-1F-1	○	○	-	○	○	-	○	○	○
C-1F-2	-	○	-	-	-	-	-	-	○
C-1F-3	-	-	-	-	-	-	-	-	-
C-1F-4A	-	-	-	-	-	-	-	-	-
C-1F-4B	-	-	-	-	-	-	-	-	-
C-1F-5	-	-	-	-	-	-	-	-	-
C-1F-6	-	-	-	-	-	-	-	-	-
C-1F-7	-	○	-	-	○	-	-	-	-
C-1F-8	-	-	-	-	-	-	-	-	-
C-1F-9	-	-	-	-	-	-	-	-	-
C-1F-10	-	-	-	-	-	-	-	-	-
C-1F-11	-	-	-	-	-	-	-	-	-
C-B1-1	-	○	-	-	-	-	-	-	-
C-B1-2	-	-	-	-	-	-	-	-	-

東海第二発電所 (2018.9.18版)

島根原子力発電所 2号炉

備考

表1-2 溢水源となり得る系統の設置区画及び溢水量 (15/27)

原子炉建物 地下1階

系統略称	系統名称	耐震クラス		溢水量		区画番号及び区画滞留面積(上段:区画番号,下段:区画滞留面積[m ²])											
		S	B, C	想定 破損 [m ³]	地震 起因 [m ³]	二次格内											
						R-B1F-01N, 06N	R-B1F-02N	R-B1F-03N	R-B1F-07N	R-B1F-08N	R-B1F-10N	R-B1F-13N	R-B1F-26N	R-B1F-27N			
						328	13	10	49	22	23	12	-	-			
GW	復水給水系	○	-	-	-	-	-	-	-	-	-	-	-	-			
CRD	制御棒駆動系	○	67	12	●	-	-	-	-	-	-	-	-	-			
CUW	原子炉浄化系	○	158	158	-	-	-	-	-	□	-	-	-	-			
RCW(A)	原子炉補機冷却系(非常用系)	○	199	-	-	-	-	●	-	-	-	●	-	-			
RCW(B)	原子炉補機冷却系(非常用系)	○	208	-	●	-	-	-	-	-	-	-	-	-			
RCW(N)	原子炉補機冷却系(常用系)	○	208	-	●	-	-	-	-	-	-	-	-	-			
HVD	ドライウェル冷却系	○	208	223	□	-	-	□	-	□	-	-	-	-			
HVCW	空機機殻冷却水系	○	208	223	□	-	-	□	-	□	-	-	-	-			
RSW(A)	原子炉補機海水系(I)	○	457	-	-	-	-	-	-	-	-	-	-	-			
RSW(B)	原子炉補機海水系(II)	○	457	-	-	-	-	-	-	-	-	-	-	-			
FPC	燃料プール冷却系	○	○	-	-	-	-	-	-	-	-	-	-	-			
HPCW	高圧炉心スプレイ補機冷却系	○	43	-	-	-	-	-	-	●	-	-	-	-			
HPSW	高圧炉心スプレイ補機海水系	○	-	-	-	-	-	-	-	-	-	-	-	-			
RCIC	原子炉隔離時冷却系	○	-	-	-	-	-	-	-	-	-	-	-	-			
RHRA(A)	残留熱除去系(A)	○	-	-	-	-	-	-	-	-	-	-	-	-			
RHRA(B)	残留熱除去系(B)	○	-	-	-	-	-	-	-	-	-	-	-	-			
RHRA(C)	残留熱除去系(C)	○	-	-	-	-	-	-	-	-	-	-	-	-			
LPDS	低圧炉心スプレイ系	○	-	-	-	-	-	-	-	-	-	-	-	-			
HPCS	高圧炉心スプレイ系	○	495	-	□	-	-	-	-	□	-	-	-	-			
SLC	ほう酸水注入系	○	-	-	-	-	-	-	-	-	-	-	-	-			
RWL(RD)	液体廃棄物処理系(放射性ドレン移送系・機器)	○	-	-	-	-	-	-	-	-	-	-	-	-			
RWL(ED)	液体廃棄物処理系(機器ドレン)	○	39	11	-	-	-	-	-	-	-	-	-	-			
RWL(RD)	液体廃棄物処理系(放射性ドレン移送系・床)	○	-	-	-	-	-	-	-	-	-	-	-	-			
RWL(F)	液体廃棄物処理系(床ドレン・化学廃液系)	○	-	-	-	-	-	-	-	-	-	-	-	-			
RWL(MS)	液体廃棄物処理系(非放射性ドレン移送系)	○	18	1	●	-	-	-	-	-	-	-	-	-			
CWT	復水輸送系	○	65	34	□	-	-	□	□	□	-	-	-	-			
MUW	補給水系	○	35	32	●	●	-	-	-	-	-	-	-	-			
FP	消火系	○	77	69	□	-	-	□	□	□	□	-	-	-			
HS	所内蒸気系(蒸気凝縮水戻り側)	○	-	-	-	-	-	-	-	-	-	-	-	-			
DEGOW(A)	非常用ディーゼル発電機系(冷却水系)(A)	○	-	-	-	-	-	-	-	-	-	-	-	-			
DEGOW(B)	非常用ディーゼル発電機系(冷却水系)(B)	○	-	-	-	-	-	-	-	-	-	-	-	-			
DEGLO(A)	非常用ディーゼル発電機系(潤滑油系)(A)	○	-	-	-	-	-	-	-	-	-	-	-	-			
DEGLO(B)	非常用ディーゼル発電機系(潤滑油系)(B)	○	-	-	-	-	-	-	-	-	-	-	-	-			
DEGFO(A)	非常用ディーゼル発電機系(燃料油系)(A)	○	29	-	-	-	-	-	-	-	-	-	-	-			
DEGFO(B)	非常用ディーゼル発電機系(燃料油系)(B)	○	29	-	-	-	-	-	-	-	-	-	-	-			
DEGOWH	非常用ディーゼル発電機系(冷却水系)(HPCS)	○	-	-	-	-	-	-	-	-	-	-	-	-			
DEGLOH	非常用ディーゼル発電機系(潤滑油系)(HPCS)	○	-	-	-	-	-	-	-	-	-	-	-	-			
DEGFOH	非常用ディーゼル発電機系(燃料油系)(HPCS)	○	22	-	-	-	-	-	-	-	-	-	-	-			
FMW	燃料プール補給水系	○	-	1	●	-	-	-	-	-	-	-	-	-			

●:溢水量あり
□:溢水量あり(耐震B,Cクラスであるが、基準地震動S1による地震力に対してハングリ機能が保持できる)
-:溢水量なし

<p style="text-align: center;">柏崎刈羽原子力発電所 6 / 7号炉 (2017.12.20版)</p> <p style="text-align: center;">添付第3.1-7表 地震時に溢水源とする機器としない機器(配管系)</p> <p style="text-align: center;">6号及び7号炉コントロール建屋(2/3)</p> <table border="1" style="width: 100%; border-collapse: collapse; text-align: center;"> <thead> <tr> <th rowspan="2">区画 No</th> <th colspan="8">配管系統 【○:溢水源としない(耐震性を確認) ×溢水源とする -:当該区画に水を内包する配管が存在しない】</th> <th rowspan="2">飲料水系</th> </tr> <tr> <th>DW</th> <th>FP</th> <th>HNCW</th> <th>MSC</th> <th>MUWP</th> <th>RCW</th> <th>RD</th> <th>TCW</th> </tr> </thead> <tbody> <tr><td>C-B1-3</td><td>-</td><td>-</td><td>-</td><td>-</td><td>-</td><td>-</td><td>-</td><td>-</td><td>-</td></tr> <tr><td>C-B1-4</td><td>-</td><td>-</td><td>-</td><td>-</td><td>-</td><td>-</td><td>-</td><td>-</td><td>-</td></tr> <tr><td>C-B1-5</td><td>-</td><td>-</td><td>-</td><td>-</td><td>-</td><td>-</td><td>-</td><td>-</td><td>-</td></tr> <tr><td>C-B1-6</td><td>-</td><td>○</td><td>○</td><td>-</td><td>○</td><td>-</td><td>-</td><td>-</td><td>-</td></tr> <tr><td>C-B1-7</td><td>-</td><td>-</td><td>-</td><td>-</td><td>-</td><td>-</td><td>-</td><td>-</td><td>○</td></tr> <tr><td>C-B1-8A</td><td>-</td><td>○</td><td>○</td><td>-</td><td>-</td><td>-</td><td>-</td><td>-</td><td>○</td></tr> <tr><td>C-B1-9C</td><td>-</td><td>○</td><td>○</td><td>-</td><td>-</td><td>-</td><td>-</td><td>-</td><td>-</td></tr> <tr><td>C-B1-9</td><td>-</td><td>-</td><td>-</td><td>-</td><td>-</td><td>-</td><td>-</td><td>-</td><td>-</td></tr> <tr><td>C-B1-10</td><td>-</td><td>-</td><td>-</td><td>-</td><td>-</td><td>-</td><td>-</td><td>-</td><td>-</td></tr> <tr><td>C-B1-11</td><td>-</td><td>-</td><td>-</td><td>-</td><td>-</td><td>-</td><td>-</td><td>-</td><td>-</td></tr> <tr><td>C-MB2-1</td><td>-</td><td>-</td><td>-</td><td>-</td><td>-</td><td>-</td><td>-</td><td>-</td><td>-</td></tr> <tr><td>C-MB2-2①</td><td>-</td><td>○</td><td>○</td><td>-</td><td>-</td><td>-</td><td>-</td><td>-</td><td>-</td></tr> <tr><td>C-MB2-2②</td><td>-</td><td>○</td><td>-</td><td>-</td><td>-</td><td>-</td><td>-</td><td>-</td><td>-</td></tr> <tr><td>C-MB2-2③</td><td>-</td><td>○</td><td>○</td><td>-</td><td>-</td><td>-</td><td>-</td><td>-</td><td>-</td></tr> <tr><td>C-MB2-2④</td><td>-</td><td>-</td><td>○</td><td>-</td><td>-</td><td>-</td><td>-</td><td>-</td><td>○</td></tr> <tr><td>C-MB2-3</td><td>-</td><td>-</td><td>-</td><td>-</td><td>-</td><td>-</td><td>-</td><td>-</td><td>-</td></tr> <tr><td>C-B2-1</td><td>-</td><td>○</td><td>-</td><td>-</td><td>-</td><td>-</td><td>-</td><td>-</td><td>-</td></tr> </tbody> </table>	区画 No	配管系統 【○:溢水源としない(耐震性を確認) ×溢水源とする -:当該区画に水を内包する配管が存在しない】								飲料水系	DW	FP	HNCW	MSC	MUWP	RCW	RD	TCW	C-B1-3	-	-	-	-	-	-	-	-	-	C-B1-4	-	-	-	-	-	-	-	-	-	C-B1-5	-	-	-	-	-	-	-	-	-	C-B1-6	-	○	○	-	○	-	-	-	-	C-B1-7	-	-	-	-	-	-	-	-	○	C-B1-8A	-	○	○	-	-	-	-	-	○	C-B1-9C	-	○	○	-	-	-	-	-	-	C-B1-9	-	-	-	-	-	-	-	-	-	C-B1-10	-	-	-	-	-	-	-	-	-	C-B1-11	-	-	-	-	-	-	-	-	-	C-MB2-1	-	-	-	-	-	-	-	-	-	C-MB2-2①	-	○	○	-	-	-	-	-	-	C-MB2-2②	-	○	-	-	-	-	-	-	-	C-MB2-2③	-	○	○	-	-	-	-	-	-	C-MB2-2④	-	-	○	-	-	-	-	-	○	C-MB2-3	-	-	-	-	-	-	-	-	-	C-B2-1	-	○	-	-	-	-	-	-	-	<p style="text-align: center;">東海第二発電所 (2018.9.18版)</p>	<p style="text-align: center;">島根原子力発電所 2号炉</p> <p style="text-align: center;">表1-2 溢水源となり得る系統の設置区画及び溢水量(16/27)</p> <p style="text-align: center;">原子炉建物 地下1階</p> <table border="1" style="width: 100%; border-collapse: collapse; text-align: center;"> <thead> <tr> <th rowspan="3">系統 路称</th> <th rowspan="3">系統名称</th> <th colspan="2">耐震クラス</th> <th colspan="2">溢水量</th> <th colspan="11">区画番号及び区画滞留面積(上段:区画番号,下段:区画滞留面積[m²])</th> </tr> <tr> <th rowspan="2">S</th> <th rowspan="2">B, C</th> <th rowspan="2">想定 破損 [m³]</th> <th rowspan="2">地震 起因 [m³]</th> <th colspan="11">二次格内 一次格内 (管理区域)</th> </tr> <tr> <th>R-B1F- 2BN</th> <th>R-B1F- 30N</th> <th>R-B1F- 32N</th> <th>R-B1F- 33N</th> <th>R-B1F- 14-1N</th> <th>R-B1F- 14-2N</th> <th>R-B1F- 15N</th> <th>R-B1F- 16-1N</th> <th>R-B1F- 16-2N</th> </tr> </thead> <tbody> <tr> <td></td> <td></td> <td></td> <td></td> <td></td> <td></td> <td>9</td> <td>-</td> <td>5</td> <td>1</td> <td>15</td> <td>13</td> <td>243</td> <td>38</td> <td>11</td> </tr> <tr><td>CW</td><td>硬水給水系</td><td></td><td>○</td><td>-</td><td>-</td><td>-</td><td>-</td><td>-</td><td>-</td><td>-</td><td>-</td><td>-</td><td>-</td><td>-</td><td>-</td></tr> <tr><td>FW</td><td>制振棟駆動系</td><td></td><td>○</td><td>67</td><td>12</td><td>-</td><td>-</td><td>-</td><td>-</td><td>-</td><td>-</td><td>-</td><td>-</td><td>-</td><td>-</td></tr> <tr><td>GRD</td><td>原子浄化系</td><td></td><td>○</td><td>158</td><td>158</td><td>-</td><td>-</td><td>●</td><td>-</td><td>-</td><td>-</td><td>-</td><td>-</td><td>-</td><td>-</td></tr> <tr><td>CLW</td><td>原子浄化系</td><td></td><td>○</td><td>158</td><td>158</td><td>-</td><td>-</td><td>●</td><td>-</td><td>-</td><td>-</td><td>-</td><td>-</td><td>-</td><td>-</td></tr> <tr><td>RCWA</td><td>原子炉補機冷却系(非常用HVC(A)系)</td><td></td><td>○</td><td>199</td><td>-</td><td>●</td><td>-</td><td>-</td><td>-</td><td>-</td><td>-</td><td>-</td><td>-</td><td>-</td><td>-</td></tr> <tr><td>HVC(A)</td><td>原子炉補機冷却系(非常用HVC(B)系)</td><td></td><td>○</td><td>208</td><td>-</td><td>-</td><td>-</td><td>-</td><td>-</td><td>-</td><td>-</td><td>-</td><td>-</td><td>-</td><td>-</td></tr> <tr><td>RCWB</td><td>原子炉補機冷却系(非常用HVC(B)系)</td><td></td><td>○</td><td>208</td><td>-</td><td>-</td><td>-</td><td>-</td><td>-</td><td>-</td><td>-</td><td>-</td><td>-</td><td>-</td><td>-</td></tr> <tr><td>HVC(B)</td><td>原子炉補機冷却系(非常用HVC(B)系)</td><td></td><td>○</td><td>208</td><td>-</td><td>-</td><td>-</td><td>-</td><td>-</td><td>-</td><td>-</td><td>-</td><td>-</td><td>-</td><td>-</td></tr> <tr><td>RCWA</td><td>原子炉補機冷却系(非常用HVC(B)系)</td><td></td><td>○</td><td>208</td><td>-</td><td>-</td><td>-</td><td>-</td><td>-</td><td>-</td><td>-</td><td>-</td><td>-</td><td>-</td><td>-</td></tr> <tr><td>HVD</td><td>ドライウェル冷却系</td><td></td><td>○</td><td>208</td><td>223</td><td>-</td><td>-</td><td>-</td><td>-</td><td>-</td><td>-</td><td>-</td><td>-</td><td>-</td><td>-</td></tr> <tr><td>HVCW</td><td>空冷機冷却系</td><td></td><td>○</td><td>208</td><td>223</td><td>-</td><td>-</td><td>-</td><td>-</td><td>-</td><td>-</td><td>-</td><td>-</td><td>-</td><td>-</td></tr> <tr><td>RSWA</td><td>原子炉補機海水系(I)</td><td></td><td>○</td><td>457</td><td>-</td><td>-</td><td>-</td><td>-</td><td>-</td><td>-</td><td>-</td><td>-</td><td>-</td><td>-</td><td>-</td></tr> <tr><td>RSWB</td><td>原子炉補機海水系(II)</td><td></td><td>○</td><td>457</td><td>-</td><td>-</td><td>-</td><td>-</td><td>-</td><td>-</td><td>-</td><td>-</td><td>-</td><td>-</td><td>-</td></tr> <tr><td>FPC</td><td>燃料プール冷却系</td><td></td><td>○</td><td>○</td><td>-</td><td>-</td><td>-</td><td>-</td><td>-</td><td>-</td><td>-</td><td>-</td><td>-</td><td>-</td><td>-</td></tr> <tr><td>HPCW</td><td>高圧炉心スプレイ補機冷却系</td><td></td><td>○</td><td>43</td><td>-</td><td>-</td><td>-</td><td>-</td><td>-</td><td>-</td><td>-</td><td>-</td><td>-</td><td>-</td><td>-</td></tr> <tr><td>HPSW</td><td>高圧炉心スプレイ補機海水系</td><td></td><td>○</td><td>-</td><td>-</td><td>-</td><td>-</td><td>-</td><td>-</td><td>-</td><td>-</td><td>-</td><td>-</td><td>-</td><td>-</td></tr> <tr><td>RCIC</td><td>原子炉隔離時冷却系</td><td></td><td>○</td><td>-</td><td>-</td><td>-</td><td>-</td><td>●</td><td>-</td><td>-</td><td>-</td><td>-</td><td>-</td><td>-</td><td>-</td></tr> <tr><td>RHRA</td><td>残留熱除去系(A)</td><td></td><td>○</td><td>-</td><td>-</td><td>-</td><td>-</td><td>-</td><td>-</td><td>-</td><td>-</td><td>-</td><td>-</td><td>-</td><td>-</td></tr> <tr><td>RHRE</td><td>残留熱除去系(B)</td><td></td><td>○</td><td>-</td><td>-</td><td>-</td><td>-</td><td>-</td><td>-</td><td>-</td><td>-</td><td>-</td><td>-</td><td>-</td><td>-</td></tr> <tr><td>RHRC</td><td>残留熱除去系(C)</td><td></td><td>○</td><td>-</td><td>-</td><td>-</td><td>-</td><td>-</td><td>-</td><td>-</td><td>-</td><td>-</td><td>-</td><td>-</td><td>-</td></tr> <tr><td>LPCS</td><td>低圧炉心スプレイ系</td><td></td><td>○</td><td>-</td><td>-</td><td>-</td><td>-</td><td>-</td><td>-</td><td>-</td><td>-</td><td>-</td><td>-</td><td>-</td><td>-</td></tr> <tr><td>HPCS</td><td>高圧炉心スプレイ系</td><td></td><td>○</td><td>495</td><td>-</td><td>-</td><td>-</td><td>-</td><td>-</td><td>-</td><td>-</td><td>-</td><td>-</td><td>-</td><td>-</td></tr> <tr><td>SLC</td><td>ほう酸水注入系</td><td></td><td>○</td><td>-</td><td>-</td><td>-</td><td>-</td><td>-</td><td>-</td><td>-</td><td>-</td><td>-</td><td>-</td><td>-</td><td>-</td></tr> <tr><td>RWL(RD)</td><td>液体廃棄物処理系(放射性ドレン移送系・機器)</td><td></td><td>○</td><td>-</td><td>-</td><td>-</td><td>-</td><td>-</td><td>-</td><td>-</td><td>-</td><td>-</td><td>-</td><td>-</td><td>-</td></tr> <tr><td>RWL(E)</td><td>液体廃棄物処理系(機器ドレン)</td><td></td><td>○</td><td>39</td><td>11</td><td>-</td><td>-</td><td>-</td><td>-</td><td>-</td><td>-</td><td>-</td><td>●</td><td>-</td><td>-</td></tr> <tr><td>RWL(RD)</td><td>液体廃棄物処理系(放射性ドレン移送系・庄)</td><td></td><td>○</td><td>-</td><td>-</td><td>-</td><td>-</td><td>-</td><td>-</td><td>-</td><td>-</td><td>-</td><td>-</td><td>-</td><td>-</td></tr> <tr><td>RWL(F)</td><td>液体廃棄物処理系(放射能化学廃液系)</td><td></td><td>○</td><td>-</td><td>-</td><td>-</td><td>-</td><td>-</td><td>-</td><td>-</td><td>-</td><td>-</td><td>-</td><td>-</td><td>-</td></tr> <tr><td>RWL(MSC)</td><td>液体廃棄物処理系(非放射性ドレン移送系)</td><td></td><td>○</td><td>18</td><td>1</td><td>-</td><td>-</td><td>-</td><td>-</td><td>-</td><td>-</td><td>-</td><td>-</td><td>●</td><td>-</td></tr> <tr><td>CWT</td><td>硬水輸送系</td><td></td><td>○</td><td>65</td><td>34</td><td>-</td><td>-</td><td>-</td><td>-</td><td>-</td><td>-</td><td>-</td><td>-</td><td>-</td><td>-</td></tr> <tr><td>MLW</td><td>補給水系</td><td></td><td>○</td><td>35</td><td>32</td><td>-</td><td>-</td><td>-</td><td>-</td><td>-</td><td>-</td><td>-</td><td>●</td><td>-</td><td>-</td></tr> <tr><td>FP</td><td>消火系</td><td></td><td>○</td><td>77</td><td>69</td><td>-</td><td>-</td><td>-</td><td>-</td><td>-</td><td>-</td><td>-</td><td>●</td><td>□</td><td>-</td></tr> <tr><td>HS</td><td>所内蒸気系(蒸気凝縮水戻り側)</td><td></td><td>○</td><td>-</td><td>-</td><td>-</td><td>-</td><td>-</td><td>-</td><td>-</td><td>-</td><td>-</td><td>-</td><td>-</td><td>-</td></tr> <tr><td>DEG(WDA)</td><td>非常用ディーゼル発電機冷却系(A)</td><td></td><td>○</td><td>-</td><td>-</td><td>-</td><td>-</td><td>-</td><td>-</td><td>-</td><td>-</td><td>-</td><td>-</td><td>-</td><td>-</td></tr> <tr><td>DEG(WDB)</td><td>非常用ディーゼル発電機冷却系(B)</td><td></td><td>○</td><td>-</td><td>-</td><td>-</td><td>-</td><td>-</td><td>-</td><td>-</td><td>-</td><td>-</td><td>-</td><td>-</td><td>-</td></tr> <tr><td>DEG(LDA)</td><td>非常用ディーゼル発電機潤滑油系(A)</td><td></td><td>○</td><td>-</td><td>-</td><td>-</td><td>-</td><td>-</td><td>-</td><td>-</td><td>-</td><td>-</td><td>-</td><td>-</td><td>-</td></tr> <tr><td>DEG(LDB)</td><td>非常用ディーゼル発電機潤滑油系(B)</td><td></td><td>○</td><td>-</td><td>-</td><td>-</td><td>-</td><td>-</td><td>-</td><td>-</td><td>-</td><td>-</td><td>-</td><td>-</td><td>-</td></tr> <tr><td>DEG(FDA)</td><td>非常用ディーゼル発電機燃料油系(A)</td><td></td><td>○</td><td>29</td><td>-</td><td>-</td><td>-</td><td>-</td><td>-</td><td>-</td><td>-</td><td>-</td><td>-</td><td>-</td><td>-</td></tr> <tr><td>DEG(FDB)</td><td>非常用ディーゼル発電機燃料油系(B)</td><td></td><td>○</td><td>29</td><td>-</td><td>-</td><td>-</td><td>-</td><td>-</td><td>-</td><td>-</td><td>-</td><td>●</td><td>-</td><td>-</td></tr> <tr><td>DEG(WDA)</td><td>非常用ディーゼル発電機冷却系(HPCS)</td><td></td><td>○</td><td>-</td><td>-</td><td>-</td><td>-</td><td>-</td><td>-</td><td>-</td><td>-</td><td>-</td><td>-</td><td>-</td><td>-</td></tr> <tr><td>DEG(LDA)</td><td>非常用ディーゼル発電機潤滑油系(HPCS)</td><td></td><td>○</td><td>-</td><td>-</td><td>-</td><td>-</td><td>-</td><td>-</td><td>-</td><td>-</td><td>-</td><td>-</td><td>-</td><td>-</td></tr> <tr><td>DEG(FDA)</td><td>非常用ディーゼル発電機燃料油系(HPCS)</td><td></td><td>○</td><td>22</td><td>-</td><td>-</td><td>-</td><td>-</td><td>-</td><td>-</td><td>-</td><td>-</td><td>●</td><td>-</td><td>-</td></tr> <tr><td>FMW</td><td>燃料プール補給水系</td><td></td><td>○</td><td>-</td><td>1</td><td>-</td><td>-</td><td>-</td><td>-</td><td>-</td><td>-</td><td>-</td><td>-</td><td>-</td><td>-</td></tr> </tbody> </table> <p style="font-size: small;">●:溢水量あり □:溢水量あり(耐震B,Cクラスであるが、基準地震動SeIによる地震力に対してバウンダリ機能が保持できる) -:溢水量なし</p>	系統 路称	系統名称	耐震クラス		溢水量		区画番号及び区画滞留面積(上段:区画番号,下段:区画滞留面積[m ²])											S	B, C	想定 破損 [m ³]	地震 起因 [m ³]	二次格内 一次格内 (管理区域)											R-B1F- 2BN	R-B1F- 30N	R-B1F- 32N	R-B1F- 33N	R-B1F- 14-1N	R-B1F- 14-2N	R-B1F- 15N	R-B1F- 16-1N	R-B1F- 16-2N							9	-	5	1	15	13	243	38	11	CW	硬水給水系		○	-	-	-	-	-	-	-	-	-	-	-	-	FW	制振棟駆動系		○	67	12	-	-	-	-	-	-	-	-	-	-	GRD	原子浄化系		○	158	158	-	-	●	-	-	-	-	-	-	-	CLW	原子浄化系		○	158	158	-	-	●	-	-	-	-	-	-	-	RCWA	原子炉補機冷却系(非常用HVC(A)系)		○	199	-	●	-	-	-	-	-	-	-	-	-	HVC(A)	原子炉補機冷却系(非常用HVC(B)系)		○	208	-	-	-	-	-	-	-	-	-	-	-	RCWB	原子炉補機冷却系(非常用HVC(B)系)		○	208	-	-	-	-	-	-	-	-	-	-	-	HVC(B)	原子炉補機冷却系(非常用HVC(B)系)		○	208	-	-	-	-	-	-	-	-	-	-	-	RCWA	原子炉補機冷却系(非常用HVC(B)系)		○	208	-	-	-	-	-	-	-	-	-	-	-	HVD	ドライウェル冷却系		○	208	223	-	-	-	-	-	-	-	-	-	-	HVCW	空冷機冷却系		○	208	223	-	-	-	-	-	-	-	-	-	-	RSWA	原子炉補機海水系(I)		○	457	-	-	-	-	-	-	-	-	-	-	-	RSWB	原子炉補機海水系(II)		○	457	-	-	-	-	-	-	-	-	-	-	-	FPC	燃料プール冷却系		○	○	-	-	-	-	-	-	-	-	-	-	-	HPCW	高圧炉心スプレイ補機冷却系		○	43	-	-	-	-	-	-	-	-	-	-	-	HPSW	高圧炉心スプレイ補機海水系		○	-	-	-	-	-	-	-	-	-	-	-	-	RCIC	原子炉隔離時冷却系		○	-	-	-	-	●	-	-	-	-	-	-	-	RHRA	残留熱除去系(A)		○	-	-	-	-	-	-	-	-	-	-	-	-	RHRE	残留熱除去系(B)		○	-	-	-	-	-	-	-	-	-	-	-	-	RHRC	残留熱除去系(C)		○	-	-	-	-	-	-	-	-	-	-	-	-	LPCS	低圧炉心スプレイ系		○	-	-	-	-	-	-	-	-	-	-	-	-	HPCS	高圧炉心スプレイ系		○	495	-	-	-	-	-	-	-	-	-	-	-	SLC	ほう酸水注入系		○	-	-	-	-	-	-	-	-	-	-	-	-	RWL(RD)	液体廃棄物処理系(放射性ドレン移送系・機器)		○	-	-	-	-	-	-	-	-	-	-	-	-	RWL(E)	液体廃棄物処理系(機器ドレン)		○	39	11	-	-	-	-	-	-	-	●	-	-	RWL(RD)	液体廃棄物処理系(放射性ドレン移送系・庄)		○	-	-	-	-	-	-	-	-	-	-	-	-	RWL(F)	液体廃棄物処理系(放射能化学廃液系)		○	-	-	-	-	-	-	-	-	-	-	-	-	RWL(MSC)	液体廃棄物処理系(非放射性ドレン移送系)		○	18	1	-	-	-	-	-	-	-	-	●	-	CWT	硬水輸送系		○	65	34	-	-	-	-	-	-	-	-	-	-	MLW	補給水系		○	35	32	-	-	-	-	-	-	-	●	-	-	FP	消火系		○	77	69	-	-	-	-	-	-	-	●	□	-	HS	所内蒸気系(蒸気凝縮水戻り側)		○	-	-	-	-	-	-	-	-	-	-	-	-	DEG(WDA)	非常用ディーゼル発電機冷却系(A)		○	-	-	-	-	-	-	-	-	-	-	-	-	DEG(WDB)	非常用ディーゼル発電機冷却系(B)		○	-	-	-	-	-	-	-	-	-	-	-	-	DEG(LDA)	非常用ディーゼル発電機潤滑油系(A)		○	-	-	-	-	-	-	-	-	-	-	-	-	DEG(LDB)	非常用ディーゼル発電機潤滑油系(B)		○	-	-	-	-	-	-	-	-	-	-	-	-	DEG(FDA)	非常用ディーゼル発電機燃料油系(A)		○	29	-	-	-	-	-	-	-	-	-	-	-	DEG(FDB)	非常用ディーゼル発電機燃料油系(B)		○	29	-	-	-	-	-	-	-	-	●	-	-	DEG(WDA)	非常用ディーゼル発電機冷却系(HPCS)		○	-	-	-	-	-	-	-	-	-	-	-	-	DEG(LDA)	非常用ディーゼル発電機潤滑油系(HPCS)		○	-	-	-	-	-	-	-	-	-	-	-	-	DEG(FDA)	非常用ディーゼル発電機燃料油系(HPCS)		○	22	-	-	-	-	-	-	-	-	●	-	-	FMW	燃料プール補給水系		○	-	1	-	-	-	-	-	-	-	-	-	-	<p style="text-align: center;">備考</p>
区画 No		配管系統 【○:溢水源としない(耐震性を確認) ×溢水源とする -:当該区画に水を内包する配管が存在しない】									飲料水系																																																																																																																																																																																																																																																																																																																																																																																																																																																																																																																																																																																																																																																																																																																																																																																																																																																																																																																																												
	DW	FP	HNCW	MSC	MUWP	RCW	RD	TCW																																																																																																																																																																																																																																																																																																																																																																																																																																																																																																																																																																																																																																																																																																																																																																																																																																																																																																																																															
C-B1-3	-	-	-	-	-	-	-	-	-																																																																																																																																																																																																																																																																																																																																																																																																																																																																																																																																																																																																																																																																																																																																																																																																																																																																																																																																														
C-B1-4	-	-	-	-	-	-	-	-	-																																																																																																																																																																																																																																																																																																																																																																																																																																																																																																																																																																																																																																																																																																																																																																																																																																																																																																																																														
C-B1-5	-	-	-	-	-	-	-	-	-																																																																																																																																																																																																																																																																																																																																																																																																																																																																																																																																																																																																																																																																																																																																																																																																																																																																																																																																														
C-B1-6	-	○	○	-	○	-	-	-	-																																																																																																																																																																																																																																																																																																																																																																																																																																																																																																																																																																																																																																																																																																																																																																																																																																																																																																																																														
C-B1-7	-	-	-	-	-	-	-	-	○																																																																																																																																																																																																																																																																																																																																																																																																																																																																																																																																																																																																																																																																																																																																																																																																																																																																																																																																														
C-B1-8A	-	○	○	-	-	-	-	-	○																																																																																																																																																																																																																																																																																																																																																																																																																																																																																																																																																																																																																																																																																																																																																																																																																																																																																																																																														
C-B1-9C	-	○	○	-	-	-	-	-	-																																																																																																																																																																																																																																																																																																																																																																																																																																																																																																																																																																																																																																																																																																																																																																																																																																																																																																																																														
C-B1-9	-	-	-	-	-	-	-	-	-																																																																																																																																																																																																																																																																																																																																																																																																																																																																																																																																																																																																																																																																																																																																																																																																																																																																																																																																														
C-B1-10	-	-	-	-	-	-	-	-	-																																																																																																																																																																																																																																																																																																																																																																																																																																																																																																																																																																																																																																																																																																																																																																																																																																																																																																																																														
C-B1-11	-	-	-	-	-	-	-	-	-																																																																																																																																																																																																																																																																																																																																																																																																																																																																																																																																																																																																																																																																																																																																																																																																																																																																																																																																														
C-MB2-1	-	-	-	-	-	-	-	-	-																																																																																																																																																																																																																																																																																																																																																																																																																																																																																																																																																																																																																																																																																																																																																																																																																																																																																																																																														
C-MB2-2①	-	○	○	-	-	-	-	-	-																																																																																																																																																																																																																																																																																																																																																																																																																																																																																																																																																																																																																																																																																																																																																																																																																																																																																																																																														
C-MB2-2②	-	○	-	-	-	-	-	-	-																																																																																																																																																																																																																																																																																																																																																																																																																																																																																																																																																																																																																																																																																																																																																																																																																																																																																																																																														
C-MB2-2③	-	○	○	-	-	-	-	-	-																																																																																																																																																																																																																																																																																																																																																																																																																																																																																																																																																																																																																																																																																																																																																																																																																																																																																																																																														
C-MB2-2④	-	-	○	-	-	-	-	-	○																																																																																																																																																																																																																																																																																																																																																																																																																																																																																																																																																																																																																																																																																																																																																																																																																																																																																																																																														
C-MB2-3	-	-	-	-	-	-	-	-	-																																																																																																																																																																																																																																																																																																																																																																																																																																																																																																																																																																																																																																																																																																																																																																																																																																																																																																																																														
C-B2-1	-	○	-	-	-	-	-	-	-																																																																																																																																																																																																																																																																																																																																																																																																																																																																																																																																																																																																																																																																																																																																																																																																																																																																																																																																														
系統 路称	系統名称	耐震クラス		溢水量		区画番号及び区画滞留面積(上段:区画番号,下段:区画滞留面積[m ²])																																																																																																																																																																																																																																																																																																																																																																																																																																																																																																																																																																																																																																																																																																																																																																																																																																																																																																																																																	
		S	B, C	想定 破損 [m ³]	地震 起因 [m ³]	二次格内 一次格内 (管理区域)																																																																																																																																																																																																																																																																																																																																																																																																																																																																																																																																																																																																																																																																																																																																																																																																																																																																																																																																																	
						R-B1F- 2BN	R-B1F- 30N	R-B1F- 32N	R-B1F- 33N	R-B1F- 14-1N	R-B1F- 14-2N	R-B1F- 15N	R-B1F- 16-1N	R-B1F- 16-2N																																																																																																																																																																																																																																																																																																																																																																																																																																																																																																																																																																																																																																																																																																																																																																																																																																																																																																																																									
						9	-	5	1	15	13	243	38	11																																																																																																																																																																																																																																																																																																																																																																																																																																																																																																																																																																																																																																																																																																																																																																																																																																																																																																																																									
CW	硬水給水系		○	-	-	-	-	-	-	-	-	-	-	-	-																																																																																																																																																																																																																																																																																																																																																																																																																																																																																																																																																																																																																																																																																																																																																																																																																																																																																																																																								
FW	制振棟駆動系		○	67	12	-	-	-	-	-	-	-	-	-	-																																																																																																																																																																																																																																																																																																																																																																																																																																																																																																																																																																																																																																																																																																																																																																																																																																																																																																																																								
GRD	原子浄化系		○	158	158	-	-	●	-	-	-	-	-	-	-																																																																																																																																																																																																																																																																																																																																																																																																																																																																																																																																																																																																																																																																																																																																																																																																																																																																																																																																								
CLW	原子浄化系		○	158	158	-	-	●	-	-	-	-	-	-	-																																																																																																																																																																																																																																																																																																																																																																																																																																																																																																																																																																																																																																																																																																																																																																																																																																																																																																																																								
RCWA	原子炉補機冷却系(非常用HVC(A)系)		○	199	-	●	-	-	-	-	-	-	-	-	-																																																																																																																																																																																																																																																																																																																																																																																																																																																																																																																																																																																																																																																																																																																																																																																																																																																																																																																																								
HVC(A)	原子炉補機冷却系(非常用HVC(B)系)		○	208	-	-	-	-	-	-	-	-	-	-	-																																																																																																																																																																																																																																																																																																																																																																																																																																																																																																																																																																																																																																																																																																																																																																																																																																																																																																																																								
RCWB	原子炉補機冷却系(非常用HVC(B)系)		○	208	-	-	-	-	-	-	-	-	-	-	-																																																																																																																																																																																																																																																																																																																																																																																																																																																																																																																																																																																																																																																																																																																																																																																																																																																																																																																																								
HVC(B)	原子炉補機冷却系(非常用HVC(B)系)		○	208	-	-	-	-	-	-	-	-	-	-	-																																																																																																																																																																																																																																																																																																																																																																																																																																																																																																																																																																																																																																																																																																																																																																																																																																																																																																																																								
RCWA	原子炉補機冷却系(非常用HVC(B)系)		○	208	-	-	-	-	-	-	-	-	-	-	-																																																																																																																																																																																																																																																																																																																																																																																																																																																																																																																																																																																																																																																																																																																																																																																																																																																																																																																																								
HVD	ドライウェル冷却系		○	208	223	-	-	-	-	-	-	-	-	-	-																																																																																																																																																																																																																																																																																																																																																																																																																																																																																																																																																																																																																																																																																																																																																																																																																																																																																																																																								
HVCW	空冷機冷却系		○	208	223	-	-	-	-	-	-	-	-	-	-																																																																																																																																																																																																																																																																																																																																																																																																																																																																																																																																																																																																																																																																																																																																																																																																																																																																																																																																								
RSWA	原子炉補機海水系(I)		○	457	-	-	-	-	-	-	-	-	-	-	-																																																																																																																																																																																																																																																																																																																																																																																																																																																																																																																																																																																																																																																																																																																																																																																																																																																																																																																																								
RSWB	原子炉補機海水系(II)		○	457	-	-	-	-	-	-	-	-	-	-	-																																																																																																																																																																																																																																																																																																																																																																																																																																																																																																																																																																																																																																																																																																																																																																																																																																																																																																																																								
FPC	燃料プール冷却系		○	○	-	-	-	-	-	-	-	-	-	-	-																																																																																																																																																																																																																																																																																																																																																																																																																																																																																																																																																																																																																																																																																																																																																																																																																																																																																																																																								
HPCW	高圧炉心スプレイ補機冷却系		○	43	-	-	-	-	-	-	-	-	-	-	-																																																																																																																																																																																																																																																																																																																																																																																																																																																																																																																																																																																																																																																																																																																																																																																																																																																																																																																																								
HPSW	高圧炉心スプレイ補機海水系		○	-	-	-	-	-	-	-	-	-	-	-	-																																																																																																																																																																																																																																																																																																																																																																																																																																																																																																																																																																																																																																																																																																																																																																																																																																																																																																																																								
RCIC	原子炉隔離時冷却系		○	-	-	-	-	●	-	-	-	-	-	-	-																																																																																																																																																																																																																																																																																																																																																																																																																																																																																																																																																																																																																																																																																																																																																																																																																																																																																																																																								
RHRA	残留熱除去系(A)		○	-	-	-	-	-	-	-	-	-	-	-	-																																																																																																																																																																																																																																																																																																																																																																																																																																																																																																																																																																																																																																																																																																																																																																																																																																																																																																																																								
RHRE	残留熱除去系(B)		○	-	-	-	-	-	-	-	-	-	-	-	-																																																																																																																																																																																																																																																																																																																																																																																																																																																																																																																																																																																																																																																																																																																																																																																																																																																																																																																																								
RHRC	残留熱除去系(C)		○	-	-	-	-	-	-	-	-	-	-	-	-																																																																																																																																																																																																																																																																																																																																																																																																																																																																																																																																																																																																																																																																																																																																																																																																																																																																																																																																								
LPCS	低圧炉心スプレイ系		○	-	-	-	-	-	-	-	-	-	-	-	-																																																																																																																																																																																																																																																																																																																																																																																																																																																																																																																																																																																																																																																																																																																																																																																																																																																																																																																																								
HPCS	高圧炉心スプレイ系		○	495	-	-	-	-	-	-	-	-	-	-	-																																																																																																																																																																																																																																																																																																																																																																																																																																																																																																																																																																																																																																																																																																																																																																																																																																																																																																																																								
SLC	ほう酸水注入系		○	-	-	-	-	-	-	-	-	-	-	-	-																																																																																																																																																																																																																																																																																																																																																																																																																																																																																																																																																																																																																																																																																																																																																																																																																																																																																																																																								
RWL(RD)	液体廃棄物処理系(放射性ドレン移送系・機器)		○	-	-	-	-	-	-	-	-	-	-	-	-																																																																																																																																																																																																																																																																																																																																																																																																																																																																																																																																																																																																																																																																																																																																																																																																																																																																																																																																								
RWL(E)	液体廃棄物処理系(機器ドレン)		○	39	11	-	-	-	-	-	-	-	●	-	-																																																																																																																																																																																																																																																																																																																																																																																																																																																																																																																																																																																																																																																																																																																																																																																																																																																																																																																																								
RWL(RD)	液体廃棄物処理系(放射性ドレン移送系・庄)		○	-	-	-	-	-	-	-	-	-	-	-	-																																																																																																																																																																																																																																																																																																																																																																																																																																																																																																																																																																																																																																																																																																																																																																																																																																																																																																																																								
RWL(F)	液体廃棄物処理系(放射能化学廃液系)		○	-	-	-	-	-	-	-	-	-	-	-	-																																																																																																																																																																																																																																																																																																																																																																																																																																																																																																																																																																																																																																																																																																																																																																																																																																																																																																																																								
RWL(MSC)	液体廃棄物処理系(非放射性ドレン移送系)		○	18	1	-	-	-	-	-	-	-	-	●	-																																																																																																																																																																																																																																																																																																																																																																																																																																																																																																																																																																																																																																																																																																																																																																																																																																																																																																																																								
CWT	硬水輸送系		○	65	34	-	-	-	-	-	-	-	-	-	-																																																																																																																																																																																																																																																																																																																																																																																																																																																																																																																																																																																																																																																																																																																																																																																																																																																																																																																																								
MLW	補給水系		○	35	32	-	-	-	-	-	-	-	●	-	-																																																																																																																																																																																																																																																																																																																																																																																																																																																																																																																																																																																																																																																																																																																																																																																																																																																																																																																																								
FP	消火系		○	77	69	-	-	-	-	-	-	-	●	□	-																																																																																																																																																																																																																																																																																																																																																																																																																																																																																																																																																																																																																																																																																																																																																																																																																																																																																																																																								
HS	所内蒸気系(蒸気凝縮水戻り側)		○	-	-	-	-	-	-	-	-	-	-	-	-																																																																																																																																																																																																																																																																																																																																																																																																																																																																																																																																																																																																																																																																																																																																																																																																																																																																																																																																								
DEG(WDA)	非常用ディーゼル発電機冷却系(A)		○	-	-	-	-	-	-	-	-	-	-	-	-																																																																																																																																																																																																																																																																																																																																																																																																																																																																																																																																																																																																																																																																																																																																																																																																																																																																																																																																								
DEG(WDB)	非常用ディーゼル発電機冷却系(B)		○	-	-	-	-	-	-	-	-	-	-	-	-																																																																																																																																																																																																																																																																																																																																																																																																																																																																																																																																																																																																																																																																																																																																																																																																																																																																																																																																								
DEG(LDA)	非常用ディーゼル発電機潤滑油系(A)		○	-	-	-	-	-	-	-	-	-	-	-	-																																																																																																																																																																																																																																																																																																																																																																																																																																																																																																																																																																																																																																																																																																																																																																																																																																																																																																																																								
DEG(LDB)	非常用ディーゼル発電機潤滑油系(B)		○	-	-	-	-	-	-	-	-	-	-	-	-																																																																																																																																																																																																																																																																																																																																																																																																																																																																																																																																																																																																																																																																																																																																																																																																																																																																																																																																								
DEG(FDA)	非常用ディーゼル発電機燃料油系(A)		○	29	-	-	-	-	-	-	-	-	-	-	-																																																																																																																																																																																																																																																																																																																																																																																																																																																																																																																																																																																																																																																																																																																																																																																																																																																																																																																																								
DEG(FDB)	非常用ディーゼル発電機燃料油系(B)		○	29	-	-	-	-	-	-	-	-	●	-	-																																																																																																																																																																																																																																																																																																																																																																																																																																																																																																																																																																																																																																																																																																																																																																																																																																																																																																																																								
DEG(WDA)	非常用ディーゼル発電機冷却系(HPCS)		○	-	-	-	-	-	-	-	-	-	-	-	-																																																																																																																																																																																																																																																																																																																																																																																																																																																																																																																																																																																																																																																																																																																																																																																																																																																																																																																																								
DEG(LDA)	非常用ディーゼル発電機潤滑油系(HPCS)		○	-	-	-	-	-	-	-	-	-	-	-	-																																																																																																																																																																																																																																																																																																																																																																																																																																																																																																																																																																																																																																																																																																																																																																																																																																																																																																																																								
DEG(FDA)	非常用ディーゼル発電機燃料油系(HPCS)		○	22	-	-	-	-	-	-	-	-	●	-	-																																																																																																																																																																																																																																																																																																																																																																																																																																																																																																																																																																																																																																																																																																																																																																																																																																																																																																																																								
FMW	燃料プール補給水系		○	-	1	-	-	-	-	-	-	-	-	-	-																																																																																																																																																																																																																																																																																																																																																																																																																																																																																																																																																																																																																																																																																																																																																																																																																																																																																																																																								

表 1-2 溢水源となり得る系統の設置区画及び溢水量 (18/27)

原子炉建物 地下1階

系統略称	系統名称	耐震クラス		溢水量		区画番号及び区画滞留面積(上段:区画番号, 下段:区画滞留面積(m ²))								
		S	B, C	想定破損 [m]	地震起因 [m ³]	二次補弁 (非管理区域)								
						R-B1F-17-2N	R-B1F-18-3N	R-B1F-20N	R-B1F-23N	R-B1F-24N	R-B1F-25N	R-B1F-29N		
CW FW	復水給水系		○	-	-	-	-	-	-	-	-	-	-	-
CRD	制御棒駆動系		○	67	12	-	-	-	-	-	-	-	-	-
CUW	原子炉浄化系		○	158	158	-	-	-	-	-	-	-	-	-
RCW(A) HVC(A)	原子炉補機冷却系(非常用系I)		○	199	-	-	-	●	-	-	-	-	-	-
RCW(B) HVC(B)	原子炉補機冷却系(非常用系II)		○	208	-	-	-	-	-	-	-	-	-	-
RCW(N) HVD HVCW	原子炉補機冷却系(非常用系) ドライウェル冷却系 空機換気設備冷却水系		○	208	223	□	-	●	-	-	-	-	-	-
RSW(A)	原子炉補機海水系(I)		○	457	-	-	-	●	-	-	-	-	-	-
RSW(B)	原子炉補機海水系(II)		○	457	-	-	-	●	-	-	-	-	-	-
FPC	燃料プール冷却系		○	○	-	-	-	-	-	-	-	-	-	-
HPCW	高圧炉心スプレイ補機冷却系		○	43	-	-	-	●	-	-	-	-	-	-
HPSW	高圧炉心スプレイ補機海水系		○	-	-	-	-	-	-	-	-	-	-	-
RCIC	原子炉隔離時冷却系		○	-	-	-	-	-	-	-	-	-	-	-
RHRA	残留熱除去系(A)		○	-	-	-	-	-	-	-	-	-	-	-
RHR(B)	残留熱除去系(B)		○	-	-	-	-	-	-	-	-	-	-	-
RHR(C)	残留熱除去系(C)		○	-	-	-	-	-	-	-	-	-	-	-
LPCS	低圧炉心スプレイ系		○	-	-	-	-	-	-	-	-	-	-	-
HPCS	高圧炉心スプレイ系		○	495	-	-	-	-	-	-	-	-	-	-
SLC	ほう酸水注入系		○	-	-	-	-	-	-	-	-	-	-	-
RWL(RD1)	液体廃棄物処理系(放射性ドレン移送系・機器)		○	-	-	-	-	-	-	-	-	-	-	-
RWL(E)	液体廃棄物処理系(機器ドレン)		○	39	11	-	-	-	-	-	-	-	-	-
RWL(RD2)	液体廃棄物処理系(放射性ドレン移送系・床)		○	-	-	-	-	-	-	-	-	-	-	-
RWL(F)	液体廃棄物処理系(床ドレン・化学廃棄系)		○	-	-	-	-	-	-	-	-	-	-	-
RWL(MSC)	液体廃棄物処理系(非放射性ドレン移送系)		○	18	1	-	-	●	-	-	-	-	-	-
CWT	復水輸送系		○	65	34	-	-	-	-	-	-	-	-	-
MUW	補給水系		○	35	32	-	-	●	-	-	-	-	□	-
FP	消火系		○	77	69	□	-	●	-	-	-	-	-	-
HS	所内蒸気系(蒸気凝縮水戻り側)		○	-	-	-	-	-	-	-	-	-	-	-
DEIG(WA)	非常用ディーゼル発電機系(冷却水系)(A)		○	-	-	-	-	-	-	-	-	-	-	-
DEIG(WB)	非常用ディーゼル発電機系(冷却水系)(B)		○	-	-	-	-	-	-	-	-	-	-	-
DEIG(DA)	非常用ディーゼル発電機系(潤滑油系)(A)		○	-	-	-	-	-	-	-	-	-	-	-
DEIG(DB)	非常用ディーゼル発電機系(潤滑油系)(B)		○	-	-	-	-	-	-	-	-	-	-	-
DEIG(OA)	非常用ディーゼル発電機系(燃料油系)(A)		○	29	-	-	-	-	-	-	-	-	-	-
DEIG(OB)	非常用ディーゼル発電機系(燃料油系)(B)		○	29	-	-	-	-	-	-	-	-	-	-
DEIG(WH)	非常用ディーゼル発電機系(冷却水系)(HPCS)		○	-	-	-	-	-	-	-	-	-	-	-
DEIG(OH)	非常用ディーゼル発電機系(潤滑油系)(HPCS)		○	-	-	-	-	-	-	-	-	-	-	-
DEIG(DH)	非常用ディーゼル発電機系(燃料油系)(HPCS)		○	22	-	-	-	●	-	●	-	-	-	-
FMW	燃料プール補給水系		○	-	1	-	-	-	-	-	-	-	-	-

●: 溢水源あり
□: 溢水源あり(耐震B,Cクラスであるが、基準地震動S_eによる地震力に対してバウンダリ機能が保持できる)
-: 溢水源なし

表 1-2 溢水源となり得る系統の設置区画及び溢水量 (19/27)

原子炉建物 地下2階

系統略称	系統名称	耐震クラス		溢水量		区画番号及び区画滞留面積(上段: 区画番号, 下段: 区画滞留面積[m ²])										
		S	B、C	想定破砕 [m ³]	地震揺動 [m]	二次格内										
						R-B2F-01N	R-B2F-02N	R-B2F-03N	R-B2F-09N	R-B2F-10N	R-B2F-15N	R-B2F-21N	R-B2F-22-1N2N	R-B2F-24-1N2N		
						92	53	110	51	52	53	11	4	4		
CW FW	復水給水系	○		-	-	-	-	-	-	-	-	-	-	-	-	-
CRD	制御棒駆動系	○		67	12	-	-	-	-	-	-	-	-	-	-	-
CUW	原子炉浄化系	○		158	158	-	-	-	-	-	-	-	-	-	-	-
RCW(A) HVC(A)	原子炉種機冷却系(非常用系)	○		205	-	●	●	-	●	-	-	-	-	-	-	-
RCW(B) HVC(B)	原子炉種機冷却系(非常用系)	○		215	-	-	-	●	-	●	-	-	-	-	-	-
RCW(N) HVD HVCW	原子炉種機冷却系(常用系) ドライウェル冷却系 空熱熱気設備冷却水系	○		209	224	-	-	-	-	-	-	-	-	-	-	-
RSW(A)	原子炉種機海水系(Ⅰ)	○		-	-	-	-	-	-	-	-	-	-	-	-	-
RSW(B)	原子炉種機海水系(Ⅱ)	○		-	-	-	-	-	-	-	-	-	-	-	-	-
FPC	燃料プール冷却系	○	○	154	63	-	-	-	-	-	-	-	-	-	-	-
HPCW	高圧炉心スプレイト種機冷却系	○		43	-	-	-	-	-	●	-	-	-	-	-	-
HPSW	高圧炉心スプレイト種機海水系	○		119	-	-	-	-	-	-	-	-	-	-	-	-
RCIC	原子炉隔離時冷却系	○		-	-	□	-	-	-	-	-	-	-	-	-	-
RHRA(A)	残留熱除去系(A)	○		311	-	●	●	-	●	-	-	-	-	-	-	-
RHRA(B)	残留熱除去系(B)	○		306	-	-	-	●	-	-	●	-	-	-	-	-
RHRA(C)	残留熱除去系(C)	○		235	-	-	-	●	-	-	-	-	-	-	-	-
LPDS	低圧炉心スプレイト系	○		231	-	-	-	-	●	-	-	-	-	-	-	-
HPCS	高圧炉心スプレイト系	○		495	-	-	-	-	-	□	-	-	-	-	-	-
SLC	ほう酸水注入系	○		-	-	-	-	-	-	-	-	-	-	-	-	-
RWLORB1	液体廃棄物処理系(放射性ドレン移送系:機器)	○		10	6	-	●	-	-	-	-	-	-	-	-	-
RWLU1E	液体廃棄物処理系(機器ドレン)	○		182	182	-	-	-	-	□	-	-	-	-	-	-
RWLORB2	液体廃棄物処理系(放射性ドレン移送系:床)	○		20	6	-	●	●	●	●	-	-	-	-	-	-
RWLUF	液体廃棄物処理系(床ドレン-化学廃液系)	○		-	-	-	-	-	-	-	-	-	-	-	-	-
RWLMSG	液体廃棄物処理系(非放射性ドレン移送系)	○		18	1	-	-	-	-	-	-	-	-	-	-	-
CWT	復水輸送系	○		65	34	-	-	-	-	□	□	-	-	-	-	-
MUW	補給水系	○		35	32	-	-	□	□	-	□	-	-	-	-	-
FP	消火系	○		77	69	□	□	-	□	□	□	-	-	-	-	-
HS	所内蒸気系	○		-	-	-	-	-	-	-	-	-	-	-	-	-
DESGWA(A)	非常用ディーゼル発電機系(冷却水系)(A)	○		11	-	-	-	-	-	-	-	-	-	-	-	-
DESGWB(B)	非常用ディーゼル発電機系(冷却水系)(B)	○		11	-	-	-	-	-	-	-	-	-	-	-	-
DESGWA(A)	非常用ディーゼル発電機系(黒油水系)(A)	○		13	-	-	-	-	-	-	-	-	-	-	-	-
DESGWB(B)	非常用ディーゼル発電機系(黒油水系)(B)	○		13	-	-	-	-	-	-	-	-	-	-	-	-
DESGWA(A)	非常用ディーゼル発電機系(燃料水系)(A)	○		29	-	-	-	-	-	-	-	-	-	-	-	-
DESGWB(B)	非常用ディーゼル発電機系(燃料水系)(B)	○		29	-	-	-	-	-	-	-	-	-	-	-	-
DESGWA(H)	非常用ディーゼル発電機系(冷却水系)(HPCS)	○		11	-	-	-	-	-	-	-	-	-	-	-	-
DESGWB(H)	非常用ディーゼル発電機系(黒油水系)(HPCS)	○		13	-	-	-	-	-	-	-	-	-	-	-	-
DESGWA(H)	非常用ディーゼル発電機系(燃料水系)(HPCS)	○		22	-	-	-	-	-	-	-	-	-	-	-	-
FMW	燃料プール補給水系	○		-	1	-	-	-	-	-	-	-	-	-	-	-

●: 溢水源あり
 □: 溢水源あり(耐震B0クラスであるが, 基準地震動S1による地震力に対してハングリ機能が保持できる)
 -: 溢水源なし

表 1-2 溢水源となり得る系統の設置区画及び溢水量 (20/27)

原子炉建物 地下2階

系統略称	系統名称	耐震クラス		溢水量		区画番号及び区画滞留面積(上段:区画番号, 下段:区画滞留面積[m ²])									
		S	B, C	想定 破損 [m ²]	地震 起因 [m ²]	二次格内									
						(非管理区域)									
						R-B2F- 26-1N2N	R-B2F- 27-1N2N	R-B2F- 31N	R-B2F- 04N	R-B2F- 05N	R-B2F- 06N	R-B2F- 07N	R-B2F- 08N	R-B2F- 11N	
CW	復水給水系	○	-	-	-	-	-	-	-	-	-	-	-	-	
FR	制御棒駆動系	○	67	12	-	-	●	-	-	-	-	-	-	-	
CUW	原子炉浄化系	○	158	158	-	-	●	-	-	-	-	-	-	-	
RCWA	原子炉種機冷却系(非常用系)	○	205	-	-	-	●	●	●	-	-	-	-	-	
HVCA	原子炉種機冷却系(非常用系)	○	215	-	-	-	●	-	-	●	-	●	-	-	
RCWN	原子炉種機冷却系(常用系)	○	209	224	-	-	●	-	-	-	-	-	-	-	
HVD	ドライウェル冷却系	○	-	-	-	-	-	-	-	-	-	-	-	-	
HVGW	空調換気設備冷却水系	○	-	-	-	-	-	-	-	-	-	-	-	-	
RSWA	原子炉種機海水系(I)	○	-	-	-	-	-	-	-	-	-	-	-	-	
RSWB	原子炉種機海水系(II)	○	-	-	-	-	-	-	-	-	-	-	-	-	
FPC	燃料プール冷却系	○	154	63	-	-	-	-	-	-	-	-	-	-	
HPCW	高圧炉心スプレイ種機冷却系	○	43	-	-	-	-	-	-	-	-	●	-	-	
HPSW	高圧炉心スプレイ種機海水系	○	119	-	-	-	-	-	-	-	-	-	-	-	
RCIC	原子炉隔離時冷却系	○	-	-	-	-	□	-	-	-	-	-	-	-	
RHRA	残留熱除去系(A)	○	311	-	-	-	●	-	-	-	-	-	-	-	
RHRI	残留熱除去系(B)	○	306	-	-	-	●	-	-	-	-	-	-	-	
RHRC	残留熱除去系(C)	○	235	-	-	-	●	-	-	-	-	-	-	-	
LPCS	低圧炉心スプレイ系	○	231	-	-	-	●	-	-	-	-	-	-	-	
HPCS	高圧炉心スプレイ系	○	495	-	-	-	□	-	-	-	-	-	-	-	
SLC	ほう酸水注入系	○	-	-	-	-	-	-	-	-	-	-	-	-	
RWL(RD)	液体廃棄物処理系(放射性ドレン移送系・機器)	○	10	6	-	-	●	-	-	-	-	-	-	-	
RWL(E)	液体廃棄物処理系(機器ドレン)	○	182	182	-	-	●	-	-	-	-	-	-	-	
RWL(RD)	液体廃棄物処理系(放射性ドレン移送系・床)	○	20	6	-	-	●	-	-	-	-	-	-	-	
RWL(F)	液体廃棄物処理系(床ドレン・化学廃液)	○	-	-	-	-	-	-	-	-	-	-	-	-	
RWL(MSC)	液体廃棄物処理系(非放射性ドレン移送系)	○	18	1	-	-	-	●	-	●	●	-	-	-	
CWT	復水移送系	○	65	34	-	-	●	-	-	-	-	-	-	-	
MUW	補給水系	○	35	32	-	-	●	□	-	□	□	-	-	-	
FP	消火系	○	77	69	-	-	-	-	-	-	-	-	□	□	
HS	所内蒸気系	○	-	-	-	-	-	-	-	-	-	-	-	-	
DEGOWA	非常用ディーゼル発電機系(冷却水系)(A)	○	11	-	-	-	-	●	-	-	-	-	-	-	
DEGOWB	非常用ディーゼル発電機系(冷却水系)(B)	○	11	-	-	-	-	-	-	●	-	-	-	-	
DEGLXA	非常用ディーゼル発電機系(燃料油系)(A)	○	13	-	-	-	-	●	-	-	-	-	-	-	
DEGLXB	非常用ディーゼル発電機系(燃料油系)(B)	○	13	-	-	-	-	-	-	●	-	-	-	-	
DEGFOXA	非常用ディーゼル発電機系(燃料油系)(A)	○	29	-	-	-	-	●	-	-	-	-	-	-	
DEGFOXB	非常用ディーゼル発電機系(燃料油系)(B)	○	29	-	-	-	-	-	-	●	-	-	-	-	
DEGOWC	非常用ディーゼル発電機系(冷却水系)(HPCS)	○	11	-	-	-	-	-	-	-	●	-	-	-	
DEGLXC	非常用ディーゼル発電機系(燃料油系)(HPCS)	○	13	-	-	-	-	-	-	-	-	●	-	-	
DEGFOXC	非常用ディーゼル発電機系(燃料油系)(HPCS)	○	22	-	-	-	-	-	-	-	-	●	-	-	
FMW	燃料プール補給水系	○	-	1	-	-	●	-	-	-	-	-	-	-	

●: 溢水源あり
 □: 溢水源あり(耐震Bクラスであるが、基準地震動Ssによる地震力に対して、ハンダリ機能が保持できる)
 -: 溢水源なし

表 1-2 溢水源となり得る系統の設置区画及び溢水量 (21/27)

原子炉建物 地下2階

系統略称	系統名称	耐震クラス		溢水量		区画番号及び区画滞留面積(上段: 区画番号, 下段: 区画滞留面積(m ²))										
		S	B, C	想定破壊 [m ³]	地震起因 [m ³]	R-B2F-12N	R-B2F-13N	R-B2F-14N	R-B2F-16N	R-B2F-17N 18N 19N	R-B2F-20N	R-B2F-23N	R-B2F-25N	R-B2F-28N		
CW	復水給水系	○	-	-	-	-	-	-	-	-	-	-	-	-	-	-
CRD	制御棒駆動系	○	67	12	-	-	-	-	-	-	-	-	-	-	-	-
CUW	原子炉浄化系	○	158	158	-	-	-	-	-	-	-	-	-	-	-	-
RCWA	原子炉補機冷却系(非常用系)	○	205	-	-	-	-	-	-	-	-	-	-	-	-	-
HVCA	原子炉補機冷却系(非常用系)	○	215	-	-	-	-	-	-	-	-	-	-	-	-	-
RWCN	原子炉補機冷却系(常用系)	○	209	224	-	-	-	●	-	-	-	-	-	-	-	-
HVD	ドライウェル冷却系	○	-	-	-	-	-	-	-	-	-	-	-	-	-	-
HVCW	空調換気設備冷却水系	○	-	-	-	-	-	-	-	-	-	-	-	-	-	-
RSWA	原子炉補機海水系(I)	○	-	-	-	-	-	-	-	-	-	-	-	-	-	-
RSWB	原子炉補機海水系(II)	○	-	-	-	-	-	-	-	-	-	-	-	-	-	-
FPC	燃料プール冷却系	○	154	63	-	-	-	-	-	-	-	-	-	-	-	-
HPCW	高圧炉心スプレイ補機冷却系	○	43	-	●	-	●	●	-	-	-	-	-	-	-	-
HPSW	高圧炉心スプレイ補機海水系	○	119	-	●	-	-	●	-	-	-	-	-	-	-	-
RCIC	原子炉隔離時冷却系	○	-	-	-	-	-	-	-	-	-	-	-	-	-	-
RHRA	残留熱除去系(A)	○	311	-	-	-	-	-	-	-	-	-	-	-	-	-
RHRB	残留熱除去系(B)	○	306	-	-	-	-	-	-	-	-	-	-	-	-	-
RHRC	残留熱除去系(C)	○	235	-	-	-	-	-	-	-	-	-	-	-	-	-
LPCS	低圧炉心スプレイ系	○	231	-	-	-	-	-	-	-	-	-	-	-	-	-
HPCS	高圧炉心スプレイ系	○	495	-	-	-	-	-	-	-	-	-	-	-	-	-
SLC	ほう融水注入系	○	-	-	-	-	-	-	-	-	-	-	-	-	-	-
RWLDR1	液体廃棄物処理系(放射性ドレン移送系-機器)	○	10	6	-	-	-	-	-	-	-	-	-	-	-	-
RWLE1	液体廃棄物処理系(機器ドレン移送系-床)	○	182	182	-	-	-	-	-	-	-	-	-	-	-	-
RWLDR2	液体廃棄物処理系(放射性ドレン移送系-床)	○	20	6	-	-	-	-	-	-	-	-	-	-	-	-
RWLF1	液体廃棄物処理系(床ドレン・化学後遺系)	○	-	-	-	-	-	-	-	-	-	-	-	-	-	-
RWLMSC	液体廃棄物処理系(非放射性ドレン移送系)	○	18	1	-	-	-	●	-	-	-	-	-	-	-	-
CWT	復水輸送系	○	65	34	-	-	-	-	-	-	-	-	-	-	-	-
MUW	補給水系	○	35	32	□	□	□	●	-	-	-	-	-	-	-	-
FP	消火系	○	77	69	-	-	-	-	□	□	-	-	-	-	-	-
HS	所内蒸気系	○	-	-	-	-	-	-	-	-	-	-	-	-	-	-
DEGOWA	非常用ディーゼル発電機系(冷却水系)(A)	○	11	-	-	-	-	-	-	-	-	-	-	-	-	-
DEGOWB	非常用ディーゼル発電機系(冷却水系)(B)	○	11	-	-	-	-	-	-	-	-	-	-	-	-	-
DEGOWA	非常用ディーゼル発電機系(蒸発水系)(A)	○	13	-	-	-	-	-	-	-	-	-	-	-	-	-
DEGOWB	非常用ディーゼル発電機系(蒸発水系)(B)	○	13	-	-	-	-	-	-	-	-	-	-	-	-	-
DEGOWA	非常用ディーゼル発電機系(燃料水系)(A)	○	29	-	-	-	-	●	-	-	-	-	-	-	-	-
DEGOWB	非常用ディーゼル発電機系(燃料水系)(B)	○	29	-	-	-	-	●	●	-	-	-	-	-	-	-
DEGOWC	非常用ディーゼル発電機系(冷却水系)(HPCS)	○	11	-	-	-	-	-	-	-	-	-	-	-	-	-
DEGOWD	非常用ディーゼル発電機系(蒸発水系)(HPCS)	○	13	-	-	-	-	-	-	-	-	-	-	-	-	-
DEGOWE	非常用ディーゼル発電機系(燃料水系)(HPCS)	○	22	-	-	-	-	●	●	-	-	-	-	-	-	-
FMW	燃料プール補給水系	○	-	1	-	-	-	-	-	-	-	-	-	-	-	-

● 溢水源あり
 □ 溢水源あり(耐震B,Cクラスであるが、基準地震動S₁による地震力に対してバウンダリ機能が保持できる)
 - 溢水源なし

表 1-2 溢水源となり得る系統の設置区画及び溢水量 (22/27)

原子炉建物 地下2階

系統略称	系統名称	耐震クラス		溢水量		区画番号及び区画滞留面積(上段:区画番号,下段:区画滞留面積[m ²] 二次格外(非管理区域))	
		S	B, C	想定破損 [m ³]	地震起因 [m ³]	R-B2F-29N	R-B2F-30N
OW FW	復水給水系		○	-	-	-	-
CRD	制御棒駆動系		○	67	12	-	-
CUW	原子炉浄化系		○	158	158	-	-
RCW(A) HVC(A)	原子炉補機冷却系(非常用系I)	○		205	-	-	-
RCW(B) HVC(B)	原子炉補機冷却系(非常用系II)	○		215	-	-	-
RCW(N) HVD HVCW	原子炉補機冷却系(常用系) ドライウェル冷却系 空調換気設備冷却水系		○	209	224	-	-
RSW(A)	原子炉補機海水系(I)	○		-	-	-	-
RSW(B)	原子炉補機海水系(II)	○		-	-	-	-
FPC	燃料プール冷却系	○	○	154	63	-	-
HPCW	高圧炉心スプレイ補機冷却系	○		43	-	-	-
HPSW	高圧炉心スプレイ補機海水系	○		119	-	-	-
RCIC	原子炉隔離時冷却系	○		-	-	-	-
RHR(A)	残留熱除去系(A)	○		311	-	-	-
RHR(B)	残留熱除去系(B)	○		306	-	-	-
RHR(C)	残留熱除去系(C)	○		235	-	-	-
LPCS	低圧炉心スプレイ系	○		231	-	-	-
HPCS	高圧炉心スプレイ系	○		495	-	-	-
SLC	ほう酸水注入系	○		-	-	-	-
RWL(RD1)	液体廃棄物処理系(放射性ドレン移送系・機器)		○	10	6	-	-
RWL(E)	液体廃棄物処理系(機器ドレン)		○	182	182	-	-
RWL(RD2)	液体廃棄物処理系(放射性ドレン移送系・床)		○	20	6	-	-
RWL(F)	液体廃棄物処理系(床ドレン・化学廃液系)		○	-	-	-	-
RWL(MSC)	液体廃棄物処理系(非放射性ドレン移送系)		○	18	1	-	-
CWT	復水輸送系		○	65	34	-	-
MUW	補給水系		○	35	32	-	-
FP	消火系		○	77	69	-	-
HS	所内蒸気系		○	-	-	-	-
DEQOW(A)	非常用ディーゼル発電機系(冷却水系)(A)		○	11	-	-	-
DEQOW(B)	非常用ディーゼル発電機系(冷却水系)(B)		○	11	-	-	-
DEQLO(A)	非常用ディーゼル発電機系(潤滑油系)(A)		○	13	-	-	-
DEQLO(B)	非常用ディーゼル発電機系(潤滑油系)(B)		○	13	-	-	-
DEQFOX(A)	非常用ディーゼル発電機系(燃料油系)(A)		○	29	-	-	-
DEQFOX(B)	非常用ディーゼル発電機系(燃料油系)(B)		○	29	-	-	-
DEQOW(H)	非常用ディーゼル発電機系(冷却水系)(HPCS)		○	11	-	-	-
DEQLO(H)	非常用ディーゼル発電機系(潤滑油系)(HPCS)		○	13	-	-	-
DEQFOX(H)	非常用ディーゼル発電機系(燃料油系)(HPCS)		○	22	-	-	-
FMW	燃料プール補給水系		○	-	1	-	-

●: 溢水源あり
 ○: 溢水源あり(耐震B,Cクラスであるが, 基準地震動Saによる地震力に対してバウンダリ機能が保持できる)
 -: 溢水源なし

表 1-2 溢水源となり得る系統の設置区画及び溢水量 (23/27)

廃棄物処理建物 2階

系統略称	系統名称	耐震クラス		溢水量		区画番号及び区画滞留面積(上段:区画番号,下段:区画滞留面積(m ²))	
		S	B, C	想定破損 [m ³]	地震起因 [m ³]	非管理区域	
						RW-2F-01N	RW-2F-02N
						126	263
CW	複水系		○	-	-	-	-
CRD	制御棒駆動系		○	-	-	-	-
CUW	原子炉浄化系		○	-	-	-	-
ROW(A)	原子炉補機冷却系(非常用系I)		○	141	-	-	● 想定破損除外
HVC(A)	中央制御室空調換気系I		○	-	-	-	-
ROW(B)	原子炉補機冷却系(非常用系II)		○	166	-	-	● 想定破損除外
HVC(B)	中央制御室空調換気系II		○	-	-	-	-
ROW(N)	原子炉補機冷却系(常用系)		○	178	189	-	□ 想定破損除外
HVCW	空調換気設備冷却水系		○	-	-	-	-
FPC	燃料プール冷却系		○	-	-	-	-
RWL	液体廃棄物処理系(放射性ドレン移送系・機器)		○	-	-	-	-
RWL(E)	液体廃棄物処理系(機器ドレン)		○	-	-	-	-
RWL(F)	液体廃棄物処理系(保ドレン・化学廃液系)		○	-	-	-	-
RWL(LD)	液体廃棄物処理系(ランドリドレン系)		○	-	-	-	-
RWS	固体廃棄物処理系(濃縮廃液系)		○	-	-	-	-
(CONW)							
RWS(SS)	固体廃棄物処理系(フィルタスラッジ系)		○	-	-	-	-
RWS	固体廃棄物処理系(使用済樹脂系)		○	-	-	-	-
RWS(LD)	固体廃棄物処理系(ランドリドレン系)		○	-	-	-	-
CWT	復水輸送系		○	-	-	-	-
MUW	補給水系		○	-	-	-	-
FP	消火系		○	68	60	□ 想定破損除外	□ 想定破損除外
HW	所内上水系		○	-	2	-	-
HS	所内蒸気系(蒸気凝縮水戻り側)		○	-	-	-	-
RAC	再生薬品系		○	-	-	-	-

●: 溢水源あり
 □: 溢水源あり(耐震B,Cクラスであるが、基準地震動Ssによる地震力に対してバウンダリ機能が保持できる)
 -: 溢水源なし

表 1-2 溢水源となり得る系統の設置区画及び溢水量 (24/27)

廃棄物処理建物 1 階

系統略称	系統名称	耐震クラス		溢水量		区画番号及び区画滞留面積(上段:区画番号,下段:区画滞留面積[m ³])		
		S	B, C	想定破損 [m ³]	地震起因 [m ³]	非管理区域		
						RW-1F-05N 07N	RW-1F-10N	RW-1F-11N
						190	94	43
CW	復水系		○	-	-	-	-	-
CRD	制御棒駆動系		○	-	-	-	-	-
CUW	原子炉浄化系		○	-	-	-	-	-
RW(A)	原子炉補機冷却系(非常用系I)		○	-	-	-	-	-
HVCA	中央制御室空調換気系 I		○	-	-	-	-	-
RW(B)	原子炉補機冷却系(非常用系II)		○	-	-	-	-	-
HVCB	中央制御室空調換気系 II		○	-	-	-	-	-
RW(N)	原子炉補機冷却系(常用系)		○	-	-	-	-	-
HVCW	空調換気設備冷却水系		○	-	-	-	-	-
FPC	燃料プール冷却系		○	-	-	-	-	-
RWL	液体廃棄物処理系(放射性ドレン移送系・機器)		○	-	-	-	-	-
RW(L)E	液体廃棄物処理系(機器ドレン)		○	-	-	-	-	-
RW(L)F	液体廃棄物処理系(床ドレン・化学廃液系)		○	-	-	-	-	-
RW(L)LD	液体廃棄物処理系(ランドリドレン系)		○	-	-	-	-	-
RWS	固体廃棄物処理系(濃縮廃液系)		○	-	-	-	-	-
(CONW)								
RWS(SS)	固体廃棄物処理系(フィルタスラッジ系)		○	-	-	-	-	-
RWS	固体廃棄物処理系(使用済樹脂系)		○	-	-	-	-	-
RWS(LD)	固体廃棄物処理系(ランドリドレン系)		○	-	-	-	-	-
CWT	復水輸送系		○	-	-	-	-	-
MUW	補給水系		○	-	-	-	-	-
FP	消火系		○	-	-	-	-	-
HW	所内上水系		○	-	-	-	-	-
HS	所内蒸気系(蒸気凝縮水戻り側)		○	-	-	-	-	-
RAC	再生薬品系		○	-	-	-	-	-

●:溢水源あり
 □:溢水源あり(耐震B,Cクラスであるが、基準地震動Saによる地震力に対してバウンダリ機能が保持できる)
 -:溢水源なし

表 1-2 溢水源となり得る系統の設置区画及び溢水量 (25/27)

廃棄物処理建物 中地下1階

系統略称	系統名称	耐震クラス		溢水量		区画番号及び区画滞留面積(上段:区画番号,下段:区画滞留面積[m ²])		
		S	B, C	想定破損 [m ³]	地震起因 [m ³]	非管理区域		
						RW-MB1F-05N	RW-MB1F-06N	RW-MB1F-08N
						110	18	40
CW	復水系		○	-	-	-	-	-
CRD	制御棒駆動系		○	-	-	-	-	-
CUW	原子炉浄化系		○	-	-	-	-	-
RCWA)	原子炉補機冷却系(非常用系I)	○		-	-	-	-	-
HVCA)	中央制御室空調換気系I			-	-	-	-	-
RCWB)	原子炉補機冷却系(非常用系II)	○		-	-	-	-	-
HVCB)	中央制御室空調換気系II			-	-	-	-	-
RCWN)	原子炉補機冷却系(常用系)		○	-	-	-	-	-
HVCW)	空調換気設備冷却水系		○	-	-	-	-	-
FPC	燃料プール冷却系		○	-	-	-	-	-
RWL(RD1)	液体廃棄物処理系(放射性ドレン移送系・機器)		○	-	-	-	-	-
RWL(E)	液体廃棄物処理系(機器ドレン)		○	-	-	-	-	-
RWL(F)	液体廃棄物処理系(床ドレン・化学廃液系)		○	-	-	-	-	-
RWL(LD)	液体廃棄物処理系(ランドリドレン系)		○	-	-	-	-	-
RWS(CGNW)	固体廃棄物処理系(濃縮廃液系)		○	-	-	-	-	-
RWS(SS)	固体廃棄物処理系(フィルタスラッジ系)		○	-	-	-	-	-
RWS	固体廃棄物処理系(使用済樹脂系)		○	-	-	-	-	-
RWS(LD)	固体廃棄物処理系(ランドリドレン系)		○	-	-	-	-	-
CWT	復水輸送系		○	-	-	-	-	-
MUW	補給水系		○	-	-	-	-	-
FP	消火系		○	-	-	-	-	-
HW	所内上水系		○	-	-	-	-	-
HS	所内蒸気系(蒸気凝縮水戻り側)		○	-	-	-	-	-
RAC	再生薬品系		○	-	-	-	-	-

●:溢水源あり
 □:溢水源あり(耐震B,Cクラスであるが、基準地震動Ssによる地震力に対してバウンダリ機能が保持できる)
 -:溢水源なし

表 1-2 溢水源となり得る系統の設置区画及び溢水量 (26/27)

制御室建物

系統略称	系統名称	耐震クラス		溢水量		区画番号及び区画滞留面積(上段:区画番号, 下段:区画滞留面積[m ²])	
		S	B, C	想定破壊 [m]	地震起因 [m]	非管理区域	
						C-4F-01N	
						408	
RCW(B) HVC(B) II)	原子炉補機冷却系(非常用系)	○		-	-	-	
TOW	タービン補機冷却系		○	-	-	-	
MUW	補給水系		○	-	-	-	
FP	消火系		○	-	-	-	
HW	所内上水系		○	-	-	-	

●: 溢水源あり
 ○: 溢水源あり(耐震B,Cクラスであるが、基準地震動Ss1による地震力に対してバウンダリ機能が保持できる)
 -: 溢水源なし

表 1-2 溢水源となり得る系統の設置区画及び溢水量 (27/27)

取水槽, 排気筒エリア, B-ディーゼル燃料貯蔵タンク格納槽

系統略称	系統名称	耐震クラス		溢水量		区画番号及び区画滞留面積(上段:区画番号, 下段:区画滞留面積[m ²])							
		S	B, C	想定破壊 [m]	地震起因 [m]	非管理区域							
						Y-24AN	Y-24BN	Y-24CN	Y-18N	Y-23N	Y-30N	Y-31N	Y-73
						54	38	20	7	8	12	57	35
RSWA(A)	原子炉補機海水系(A)	○		5425	-	●	-	-	-	-	-	-	-
RSWB(B)	原子炉補機海水系(B)	○		5425	-	●	-	-	-	-	-	-	-
HPSW	高圧炉心スレイ補機海水系	○		1867	-	-	●	-	-	-	-	-	-
TSW	タービン補機海水系(取水エリア)	○		4315	129	●	-	-	-	-	-	-	-
MUW	補給水系		○	57	17	□	□	-	-	-	-	-	-
FP	消火系		○	905	70	□	□	□	-	-	-	-	-
OTC	取水槽設備系		○	2947	-	●	●	-	-	-	-	-	-
DEGFO(A)	非常用ディーゼル発電機系(A) (燃料油系)		○	13	-	-	-	-	●	-	-	-	-
DEGFO(B)	非常用ディーゼル発電機系(B) (燃料油系)		○	13	-	-	-	-	-	-	-	-	●
DEGFO(H)	非常用ディーゼル発電機系(H) (燃料油系)(HPCS)		○	13	-	-	-	-	-	●	-	-	-

●: 溢水源あり
 ○: 溢水源あり(耐震B,Cクラスであるが、基準地震動Ss1による地震力に対してバウンダリ機能が保持できる)
 -: 溢水源なし

柏崎刈羽原子力発電所 6 / 7号炉 (2017. 12. 20 版)	東海第二発電所 (2018. 9. 18 版)	島根原子力発電所 2号炉	備考
		 <p data-bbox="2448 367 2487 1192" style="writing-mode: vertical-rl; text-orientation: upright;">図 1-1 溢水源となり得る主な機器の配置 (原子炉建物 4 階 EL42.8m)</p>	<p data-bbox="2528 256 2813 373">・島根 2 号炉は溢水源となりうる主な機器の配置を記載</p> <p data-bbox="2528 388 2813 424">【柏崎 6/7, 東海第二】</p>

柏崎刈羽原子力発電所 6 / 7号炉 (2017. 12. 20 版)	東海第二発電所 (2018. 9. 18 版)	島根原子力発電所 2号炉	備考
			

図 1-2 溢水源となり得る主な機器の配置 (原子炉建物3階 EL34.8m)

柏崎刈羽原子力発電所 6 / 7号炉 (2017. 12. 20 版)	東海第二発電所 (2018. 9. 18 版)	島根原子力発電所 2号炉	備考
			

図 1-3 溢水源となり得る主な機器の配置 (原子炉建物中 2階 EL:30.5m)

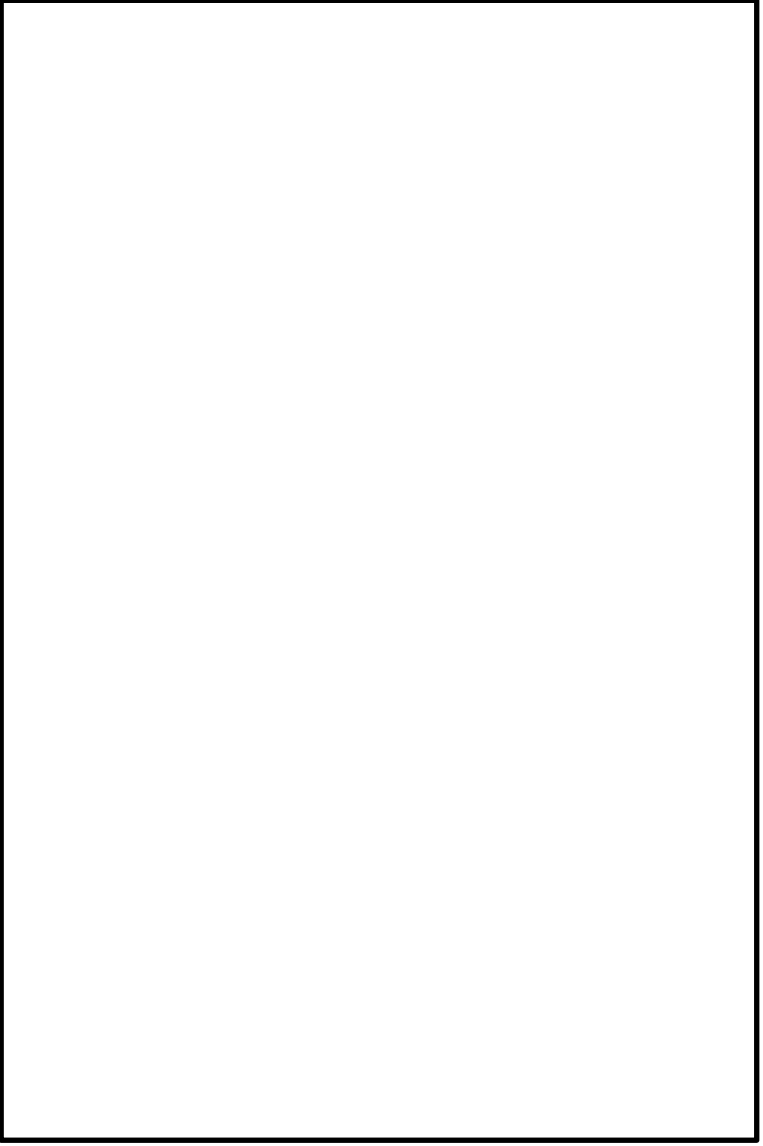

柏崎刈羽原子力発電所 6 / 7号炉 (2017. 12. 20 版)	東海第二発電所 (2018. 9. 18 版)	島根原子力発電所 2号炉	備考
			

図 1-4 溢水源となり得る主な機器の配置 (原子炉建物 2階 EL23. 8m)

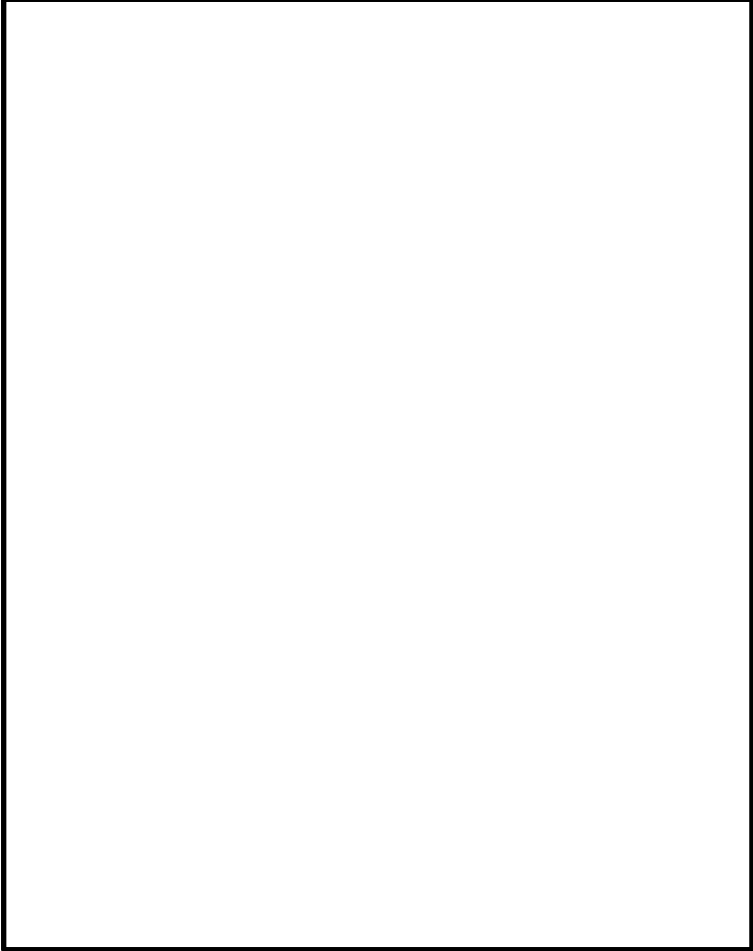
柏崎刈羽原子力発電所 6 / 7号炉 (2017. 12. 20 版)	東海第二発電所 (2018. 9. 18 版)	島根原子力発電所 2号炉	備考
			<p data-bbox="2457 338 2496 1167">図 1-5 溢水源となり得る主な機器の配置 (原子炉建物 1 階 EL15. 3m)</p>

柏崎刈羽原子力発電所 6 / 7号炉 (2017. 12. 20 版)	東海第二発電所 (2018. 9. 18 版)	島根原子力発電所 2号炉	備考
			

図 1-6 溢水源となり得る主な機器の配置 (原子炉建物地下 1 階 EL8. 8m 及び原子炉容器内 EL10. 1m)

柏崎刈羽原子力発電所 6 / 7号炉 (2017. 12. 20 版)	東海第二発電所 (2018. 9. 18 版)	島根原子力発電所 2号炉	備考
			

図 1-7 溢水源となり得る主な機器の配置 (原子炉建物地下2階 EL1.3m)

柏崎刈羽原子力発電所 6 / 7号炉 (2017.12.20版)	東海第二発電所 (2018.9.18版)	島根原子力発電所 2号炉	備考
		<div data-bbox="1745 258 2487 898" data-label="Image"> </div> <div data-bbox="1855 919 2374 1003" data-label="Caption"> <p>図 1-8 溢水源となり得る主な機器の配置 (制御室建物 2階 EL8.8m)</p> </div> <div data-bbox="1745 1062 2487 1686" data-label="Image"> </div> <div data-bbox="1855 1686 2374 1770" data-label="Caption"> <p>図 1-9 溢水源となり得る主な機器の配置 (廃棄物処理建物 5階 EL37.5m)</p> </div>	

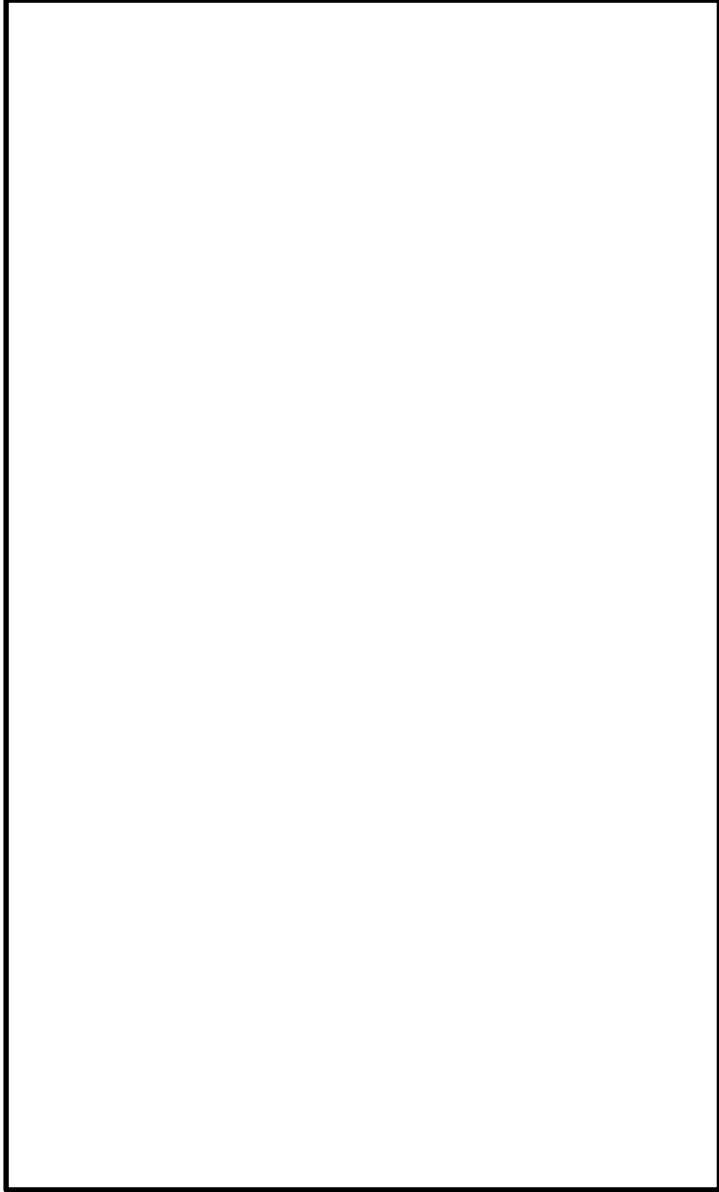
柏崎刈羽原子力発電所 6 / 7号炉 (2017.12.20版)	東海第二発電所 (2018.9.18版)	島根原子力発電所 2号炉	備考
		<div data-bbox="1745 260 2472 863" data-label="Image"> </div> <div data-bbox="1863 884 2377 957" data-label="Caption"> <p>図 1-10 溢水源となり得る主な機器の配置 (<u>廃棄物処理建物 3階 EL26.7m</u>)</p> </div> <div data-bbox="1745 978 2502 1577" data-label="Image"> </div> <div data-bbox="1863 1598 2377 1671" data-label="Caption"> <p>図 1-11 溢水源となり得る主な機器の配置 (<u>廃棄物処理建物 2階 EL22.1m</u>)</p> </div>	

柏崎刈羽原子力発電所 6 / 7号炉 (2017.12.20版)	東海第二発電所 (2018.9.18版)	島根原子力発電所 2号炉	備考
		<div data-bbox="1792 254 2436 936" data-label="Image"> </div> <div data-bbox="1863 968 2377 1052" data-label="Caption"> <p>図 1-12 溢水源となり得る主な機器の配置 (廃棄物処理建物 1階 EL15.3m)</p> </div> <div data-bbox="1792 1079 2436 1713" data-label="Image"> </div> <div data-bbox="1863 1734 2377 1818" data-label="Caption"> <p>図 1-13 溢水源となり得る主な機器の配置 (廃棄物処理建物地下中 1階 EL12.3m)</p> </div>	

柏崎刈羽原子力発電所 6 / 7号炉 (2017.12.20版)	東海第二発電所 (2018.9.18版)	島根原子力発電所 2号炉	備考
		<div data-bbox="1739 285 2478 907" data-label="Image"> </div> <div data-bbox="1863 926 2374 1003" data-label="Caption"> <p>図 1-14 溢水源となり得る主な機器の配置 (廃棄物処理建物地下1階 EL8.8m)</p> </div> <div data-bbox="1739 1052 2478 1539" data-label="Image"> </div> <div data-bbox="1863 1558 2374 1635" data-label="Caption"> <p>図 1-15 溢水源となり得る主な機器の配置 (廃棄物処理建物地下2階 EL3.0m)</p> </div>	

柏崎刈羽原子力発電所 6 / 7号炉 (2017.12.20版)	東海第二発電所 (2018.9.18版)	島根原子力発電所 2号炉	備考
		 <p data-bbox="2445 495 2481 1360">図1-16 溢水源となり得る主な機器の配置 (タービン建物3階 EL20.6m)</p>	

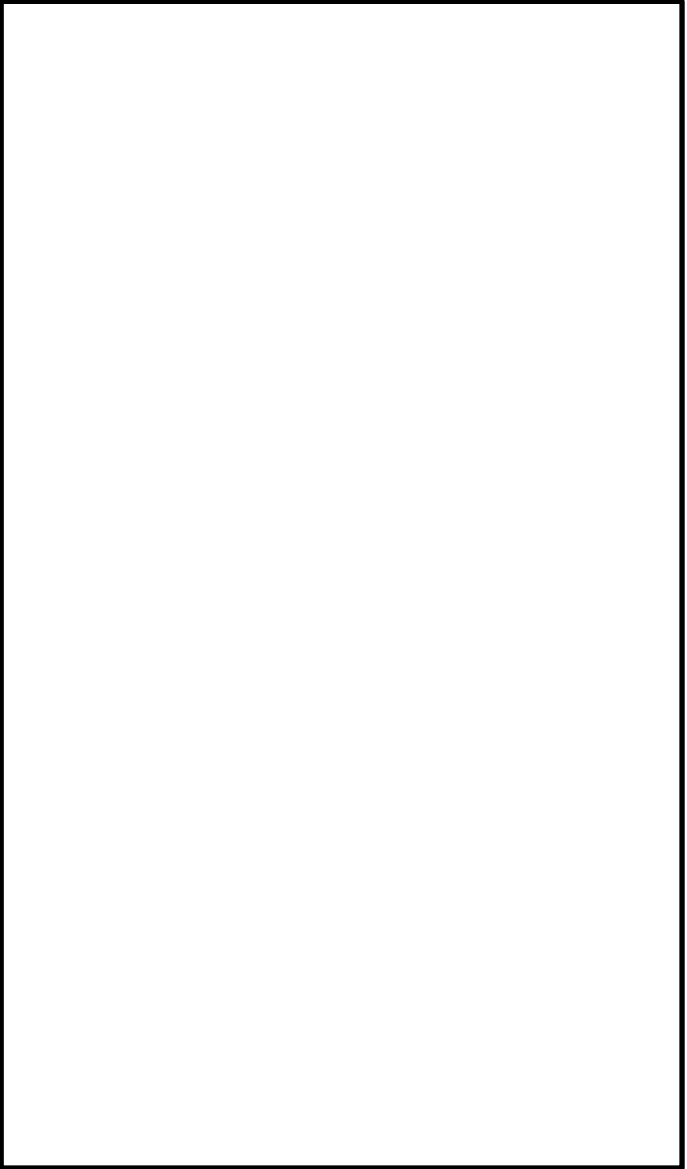
柏崎刈羽原子力発電所 6 / 7号炉 (2017.12.20版)	東海第二発電所 (2018.9.18版)	島根原子力発電所 2号炉	備考
		 <p data-bbox="2427 428 2475 1293">図 1-17 溢水源となり得る主な機器の配置 (タービン建物 2階 EL12.5m)</p>	

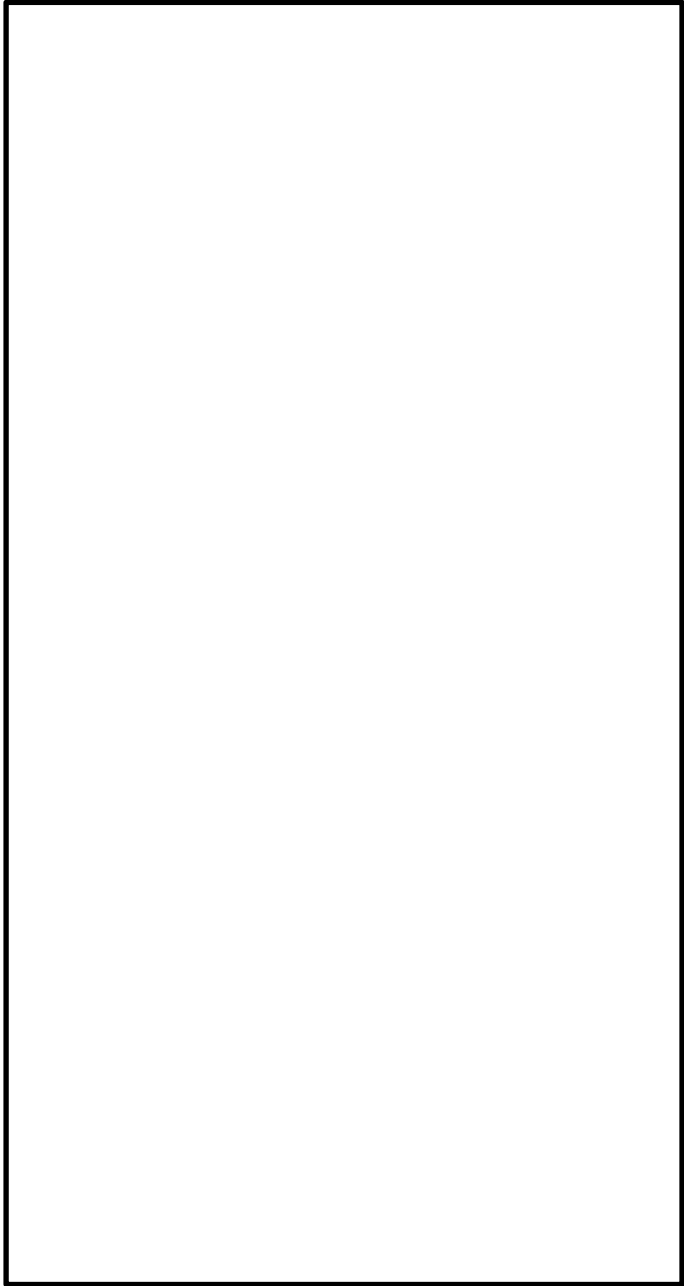
柏崎刈羽原子力発電所 6 / 7号炉 (2017.12.20版)	東海第二発電所 (2018.9.18版)	島根原子力発電所 2号炉	備考
		 <p data-bbox="2427 525 2472 1386">図 1-18 溢水源となり得る主な機器の配置 (タービン建物1階 EL5.5m)</p>	

柏崎刈羽原子力発電所 6 / 7号炉 (2017.12.20版)	東海第二発電所 (2018.9.18版)	島根原子力発電所 2号炉	備考
			

図 1-19 溢水源となり得る主な機器の配置 (タービン建物地下1階 EL2.0m)

柏崎刈羽原子力発電所 6 / 7号炉 (2017. 12. 20 版)	東海第二発電所 (2018. 9. 18 版)	島根原子力発電所 2号炉	備考																																																																													
		<p>1.2 地震起因による溢水源の設定及び溢水源としない機器について</p> <p>地震起因の没水・被水影響評価フロー（本文 図 7-5, 7-8）に基づき影響評価を行い、溢水源とする機器と、Ss 機能維持評価により溢水源としない機器を選定した。溢水源とする機器としない機器を表 1-3 に、Ss 機能維持評価により溢水源としない配管を表 1-4 に示す。</p> <p style="text-align: center;">表 1-3 溢水源とする機器としない機器 (1/4)</p> <table border="1" data-bbox="1760 661 2496 1585"> <thead> <tr> <th>建物</th> <th>設置階^{※1}</th> <th>機器</th> <th>溢水源とする機器</th> <th>溢水源としない機器</th> </tr> </thead> <tbody> <tr> <td rowspan="23">原子炉建物</td> <td rowspan="5">地上3階 (EL34. 8m)</td> <td>ドライウエル冷凍機</td> <td>○</td> <td>—</td> </tr> <tr> <td>燃料プール冷却系熱交換器</td> <td>—</td> <td>○</td> </tr> <tr> <td>燃料プール冷却系ろ過脱塩器逆洗水タンク</td> <td>○</td> <td>—</td> </tr> <tr> <td>燃料プール冷却系ろ過脱塩器プリコートタンク</td> <td>○</td> <td>—</td> </tr> <tr> <td>原子炉浄化系ろ過脱塩装置ろ過脱塩器</td> <td>○</td> <td>—</td> </tr> <tr> <td rowspan="6">地上中2階 (EL30. 5m)</td> <td>燃料プール冷却系ろ過脱塩装置ろ過脱塩器</td> <td>○</td> <td>—</td> </tr> <tr> <td>原子炉浄化系サージタンク</td> <td>○</td> <td>—</td> </tr> <tr> <td>原子炉浄化系非再生熱交換器</td> <td>○</td> <td>—</td> </tr> <tr> <td>原子炉浄化系脱塩装置脱塩器</td> <td>○</td> <td>—</td> </tr> <tr> <td>燃料プール冷却水ポンプ</td> <td>—</td> <td>○</td> </tr> <tr> <td>原子炉浄化ろ過脱塩装置ホールディングポンプ</td> <td>—</td> <td>○</td> </tr> <tr> <td rowspan="4">地上2階 (EL23. 8m)</td> <td>スクラム排水容器</td> <td>○</td> <td>—</td> </tr> <tr> <td>空調換気設備冷却水冷凍機</td> <td>○</td> <td>—</td> </tr> <tr> <td>原子炉浄化系再生熱交換器</td> <td>○</td> <td>—</td> </tr> <tr> <td>原子炉浄化系補助熱交換器</td> <td>○</td> <td>—</td> </tr> <tr> <td rowspan="5">地上1階 (EL15. 3m)</td> <td>原子炉浄化循環ポンプ</td> <td>—</td> <td>○</td> </tr> <tr> <td>P L R ポンプ用MGセット油冷却器</td> <td>—</td> <td>○</td> </tr> <tr> <td>P L R ポンプ用MGセット誘導電動機用空気冷却器</td> <td>—</td> <td>○</td> </tr> <tr> <td>P L R ポンプ用MGセット交流発電機空気冷却器</td> <td>—</td> <td>○</td> </tr> <tr> <td>P L R ポンプ用MGセット室冷却機</td> <td>—</td> <td>○</td> </tr> <tr> <td rowspan="2">地下1階 (EL8. 8m)</td> <td>復水輸送ポンプ</td> <td>—</td> <td>○</td> </tr> <tr> <td>原子炉浄化補助ポンプ</td> <td>—</td> <td>○</td> </tr> </tbody> </table> <p>※1 () 内は、設置階の基準床高さを示す。</p>	建物	設置階 ^{※1}	機器	溢水源とする機器	溢水源としない機器	原子炉建物	地上3階 (EL34. 8m)	ドライウエル冷凍機	○	—	燃料プール冷却系熱交換器	—	○	燃料プール冷却系ろ過脱塩器逆洗水タンク	○	—	燃料プール冷却系ろ過脱塩器プリコートタンク	○	—	原子炉浄化系ろ過脱塩装置ろ過脱塩器	○	—	地上中2階 (EL30. 5m)	燃料プール冷却系ろ過脱塩装置ろ過脱塩器	○	—	原子炉浄化系サージタンク	○	—	原子炉浄化系非再生熱交換器	○	—	原子炉浄化系脱塩装置脱塩器	○	—	燃料プール冷却水ポンプ	—	○	原子炉浄化ろ過脱塩装置ホールディングポンプ	—	○	地上2階 (EL23. 8m)	スクラム排水容器	○	—	空調換気設備冷却水冷凍機	○	—	原子炉浄化系再生熱交換器	○	—	原子炉浄化系補助熱交換器	○	—	地上1階 (EL15. 3m)	原子炉浄化循環ポンプ	—	○	P L R ポンプ用MGセット油冷却器	—	○	P L R ポンプ用MGセット誘導電動機用空気冷却器	—	○	P L R ポンプ用MGセット交流発電機空気冷却器	—	○	P L R ポンプ用MGセット室冷却機	—	○	地下1階 (EL8. 8m)	復水輸送ポンプ	—	○	原子炉浄化補助ポンプ	—	○	<p>・設備の相違 【柏崎 6/7, 東海第二】</p>
建物	設置階 ^{※1}	機器	溢水源とする機器	溢水源としない機器																																																																												
原子炉建物	地上3階 (EL34. 8m)	ドライウエル冷凍機	○	—																																																																												
		燃料プール冷却系熱交換器	—	○																																																																												
		燃料プール冷却系ろ過脱塩器逆洗水タンク	○	—																																																																												
		燃料プール冷却系ろ過脱塩器プリコートタンク	○	—																																																																												
		原子炉浄化系ろ過脱塩装置ろ過脱塩器	○	—																																																																												
	地上中2階 (EL30. 5m)	燃料プール冷却系ろ過脱塩装置ろ過脱塩器	○	—																																																																												
		原子炉浄化系サージタンク	○	—																																																																												
		原子炉浄化系非再生熱交換器	○	—																																																																												
		原子炉浄化系脱塩装置脱塩器	○	—																																																																												
		燃料プール冷却水ポンプ	—	○																																																																												
		原子炉浄化ろ過脱塩装置ホールディングポンプ	—	○																																																																												
	地上2階 (EL23. 8m)	スクラム排水容器	○	—																																																																												
		空調換気設備冷却水冷凍機	○	—																																																																												
		原子炉浄化系再生熱交換器	○	—																																																																												
		原子炉浄化系補助熱交換器	○	—																																																																												
	地上1階 (EL15. 3m)	原子炉浄化循環ポンプ	—	○																																																																												
		P L R ポンプ用MGセット油冷却器	—	○																																																																												
		P L R ポンプ用MGセット誘導電動機用空気冷却器	—	○																																																																												
		P L R ポンプ用MGセット交流発電機空気冷却器	—	○																																																																												
		P L R ポンプ用MGセット室冷却機	—	○																																																																												
	地下1階 (EL8. 8m)	復水輸送ポンプ	—	○																																																																												
		原子炉浄化補助ポンプ	—	○																																																																												

柏崎刈羽原子力発電所 6 / 7号炉 (2017.12.20版)	東海第二発電所 (2018.9.18版)	島根原子力発電所 2号炉	備考																																																																																				
		<p style="text-align: center;">表 1-3 溢水源とする機器としない機器(2/4)</p> <table border="1" style="width: 100%; border-collapse: collapse;"> <thead> <tr> <th style="width: 10%;">建物</th> <th style="width: 10%;">設置階^{※1}</th> <th style="width: 40%;">機器</th> <th style="width: 15%;">溢水源とする機器</th> <th style="width: 15%;">溢水源としない機器</th> </tr> </thead> <tbody> <tr> <td rowspan="14">原子炉建物</td> <td rowspan="4">地下1階 (EL8.8m)</td> <td>CRDポンプ室冷却機</td> <td style="text-align: center;">-</td> <td style="text-align: center;">○</td> </tr> <tr> <td>CRDポンプ油冷却器</td> <td style="text-align: center;">-</td> <td style="text-align: center;">○</td> </tr> <tr> <td>R C I Cポンプ室冷却機</td> <td style="text-align: center;">-</td> <td style="text-align: center;">○</td> </tr> <tr> <td>N2ガス製造装置空気圧縮機</td> <td style="text-align: center;">-</td> <td style="text-align: center;">○</td> </tr> <tr> <td rowspan="8">地下2階 (EL1.3m)</td> <td>R/B北西コーナ室 床ドレンサンプ</td> <td style="text-align: center;">○</td> <td style="text-align: center;">-</td> </tr> <tr> <td>R/B北東コーナ室 床ドレンサンプ</td> <td style="text-align: center;">○</td> <td style="text-align: center;">-</td> </tr> <tr> <td>DEG室床ドレンサンプ</td> <td style="text-align: center;">○</td> <td style="text-align: center;">-</td> </tr> <tr> <td>HPCSポンプ室 床ドレンサンプタンク</td> <td style="text-align: center;">○</td> <td style="text-align: center;">-</td> </tr> <tr> <td>RHRポンプ室 床ドレンサンプタンク</td> <td style="text-align: center;">○</td> <td style="text-align: center;">-</td> </tr> <tr> <td>LPCSポンプ室 床ドレンサンプタンク</td> <td style="text-align: center;">○</td> <td style="text-align: center;">-</td> </tr> <tr> <td>原子炉建物 機器ドレンサンプタンク</td> <td style="text-align: center;">○</td> <td style="text-align: center;">-</td> </tr> <tr> <td>原子炉建物 床ドレンサンプタンク</td> <td style="text-align: center;">○</td> <td style="text-align: center;">-</td> </tr> <tr> <td>-</td> <td>配管</td> <td style="text-align: center;">○^{※2}</td> <td style="text-align: center;">○^{※3}</td> </tr> <tr> <td rowspan="2">制御室建物</td> <td>地上2階 (EL8.8m)</td> <td>電気温水ボイラ</td> <td style="text-align: center;">○</td> <td style="text-align: center;">-</td> </tr> <tr> <td>-</td> <td>配管</td> <td style="text-align: center;">○^{※2}</td> <td style="text-align: center;">○^{※3}</td> </tr> <tr> <td rowspan="9">廃棄物処理建物</td> <td rowspan="6">地上5階 (EL37.5m)</td> <td>ランドリ・ドレン 濃縮器復水器</td> <td style="text-align: center;">○</td> <td style="text-align: center;">-</td> </tr> <tr> <td>ランドリ・ドレン脱塩器</td> <td style="text-align: center;">○</td> <td style="text-align: center;">-</td> </tr> <tr> <td>ランドリ・ドレン インヒビタ添加タンク</td> <td style="text-align: center;">○</td> <td style="text-align: center;">-</td> </tr> <tr> <td>ランドリ・ドレン 乾燥機復水器</td> <td style="text-align: center;">○</td> <td style="text-align: center;">-</td> </tr> <tr> <td>ランドリ・ドレン濃縮器</td> <td style="text-align: center;">○</td> <td style="text-align: center;">-</td> </tr> <tr> <td>地上3階 (EL26.7m)</td> <td>化学廃液濃縮器復水器</td> <td style="text-align: center;">○</td> <td style="text-align: center;">-</td> </tr> <tr> <td>床ドレン濃縮器復水器</td> <td style="text-align: center;">○</td> <td style="text-align: center;">-</td> </tr> <tr> <td>真空発生装置循環水タンク</td> <td style="text-align: center;">○</td> <td style="text-align: center;">-</td> </tr> </tbody> </table> <p>※1 ()内は、設置階の基準床高さを示す。 ※2 右記以外。 ※3 詳細は表 1-4 による。</p>	建物	設置階 ^{※1}	機器	溢水源とする機器	溢水源としない機器	原子炉建物	地下1階 (EL8.8m)	CRDポンプ室冷却機	-	○	CRDポンプ油冷却器	-	○	R C I Cポンプ室冷却機	-	○	N2ガス製造装置空気圧縮機	-	○	地下2階 (EL1.3m)	R/B北西コーナ室 床ドレンサンプ	○	-	R/B北東コーナ室 床ドレンサンプ	○	-	DEG室床ドレンサンプ	○	-	HPCSポンプ室 床ドレンサンプタンク	○	-	RHRポンプ室 床ドレンサンプタンク	○	-	LPCSポンプ室 床ドレンサンプタンク	○	-	原子炉建物 機器ドレンサンプタンク	○	-	原子炉建物 床ドレンサンプタンク	○	-	-	配管	○ ^{※2}	○ ^{※3}	制御室建物	地上2階 (EL8.8m)	電気温水ボイラ	○	-	-	配管	○ ^{※2}	○ ^{※3}	廃棄物処理建物	地上5階 (EL37.5m)	ランドリ・ドレン 濃縮器復水器	○	-	ランドリ・ドレン脱塩器	○	-	ランドリ・ドレン インヒビタ添加タンク	○	-	ランドリ・ドレン 乾燥機復水器	○	-	ランドリ・ドレン濃縮器	○	-	地上3階 (EL26.7m)	化学廃液濃縮器復水器	○	-	床ドレン濃縮器復水器	○	-	真空発生装置循環水タンク	○	-	
建物	設置階 ^{※1}	機器	溢水源とする機器	溢水源としない機器																																																																																			
原子炉建物	地下1階 (EL8.8m)	CRDポンプ室冷却機	-	○																																																																																			
		CRDポンプ油冷却器	-	○																																																																																			
		R C I Cポンプ室冷却機	-	○																																																																																			
		N2ガス製造装置空気圧縮機	-	○																																																																																			
	地下2階 (EL1.3m)	R/B北西コーナ室 床ドレンサンプ	○	-																																																																																			
		R/B北東コーナ室 床ドレンサンプ	○	-																																																																																			
		DEG室床ドレンサンプ	○	-																																																																																			
		HPCSポンプ室 床ドレンサンプタンク	○	-																																																																																			
		RHRポンプ室 床ドレンサンプタンク	○	-																																																																																			
		LPCSポンプ室 床ドレンサンプタンク	○	-																																																																																			
		原子炉建物 機器ドレンサンプタンク	○	-																																																																																			
		原子炉建物 床ドレンサンプタンク	○	-																																																																																			
	-	配管	○ ^{※2}	○ ^{※3}																																																																																			
	制御室建物	地上2階 (EL8.8m)	電気温水ボイラ	○	-																																																																																		
-		配管	○ ^{※2}	○ ^{※3}																																																																																			
廃棄物処理建物	地上5階 (EL37.5m)	ランドリ・ドレン 濃縮器復水器	○	-																																																																																			
		ランドリ・ドレン脱塩器	○	-																																																																																			
		ランドリ・ドレン インヒビタ添加タンク	○	-																																																																																			
		ランドリ・ドレン 乾燥機復水器	○	-																																																																																			
		ランドリ・ドレン濃縮器	○	-																																																																																			
		地上3階 (EL26.7m)	化学廃液濃縮器復水器	○	-																																																																																		
	床ドレン濃縮器復水器	○	-																																																																																				
	真空発生装置循環水タンク	○	-																																																																																				

柏崎刈羽原子力発電所 6 / 7号炉 (2017.12.20版)	東海第二発電所 (2018.9.18版)	島根原子力発電所 2号炉	備考																																																																																						
		<p align="center">表 1-3 溢水源とする機器としない機器(3/4)</p> <table border="1"> <thead> <tr> <th>建物</th> <th>設置階※1</th> <th>機器</th> <th>溢水源とする機器</th> <th>溢水源としない機器</th> </tr> </thead> <tbody> <tr> <td rowspan="23">廃棄物 処理 建物</td> <td rowspan="5">地上3階 (EL26.7m)</td> <td>ランドリ・ドレン すすぎ水受タンク</td> <td align="center">○</td> <td align="center">-</td> </tr> <tr> <td>ランドリ・ドレン 収集タンク</td> <td align="center">○</td> <td align="center">-</td> </tr> <tr> <td>ランドリ・ドレン サンプルタンク</td> <td align="center">○</td> <td align="center">-</td> </tr> <tr> <td>濃縮廃液タンク用 温水タンク</td> <td align="center">○</td> <td align="center">-</td> </tr> <tr> <td>ランドリ・ドレン 濃縮廃液タンク</td> <td align="center">○</td> <td align="center">-</td> </tr> <tr> <td rowspan="7">地上2階 (EL22.1m)</td> <td>床ドレン濃縮器</td> <td align="center">○</td> <td align="center">-</td> </tr> <tr> <td>ランドリ・ドレン サンプルタンク</td> <td align="center">○</td> <td align="center">-</td> </tr> <tr> <td>機器ドレンろ過脱塩器</td> <td align="center">○</td> <td align="center">-</td> </tr> <tr> <td>機器ドレン脱塩器</td> <td align="center">○</td> <td align="center">-</td> </tr> <tr> <td>機器ドレンろ過脱塩装置</td> <td align="center">○</td> <td align="center">-</td> </tr> <tr> <td>ブリコートタンク</td> <td align="center">○</td> <td align="center">-</td> </tr> <tr> <td>凝縮水ろ過脱塩器</td> <td align="center">○</td> <td align="center">-</td> </tr> <tr> <td rowspan="2">地上1階 (EL15.3m)</td> <td>インヒビタ添加タンク</td> <td align="center">○</td> <td align="center">-</td> </tr> <tr> <td>硫酸添加タンク</td> <td align="center">○</td> <td align="center">-</td> </tr> <tr> <td>地下中1階 (EL12.3m)</td> <td>濃縮廃液ポンプ封水用 冷却器</td> <td align="center">○</td> <td align="center">-</td> </tr> <tr> <td rowspan="4">地下1階 (EL8.8m)</td> <td>RW/B陰イオン フロックタンク</td> <td align="center">○</td> <td align="center">-</td> </tr> <tr> <td>RW/B陽イオン フロックタンク</td> <td align="center">○</td> <td align="center">-</td> </tr> <tr> <td>復水系スラッジ貯蔵タンク</td> <td align="center">○</td> <td align="center">-</td> </tr> <tr> <td>復水系樹脂貯蔵タンク</td> <td align="center">○</td> <td align="center">-</td> </tr> <tr> <td rowspan="4">地下2階 (EL3.0m)</td> <td>原子炉浄化系樹脂貯蔵 タンク</td> <td align="center">○</td> <td align="center">-</td> </tr> <tr> <td>RW/B所内蒸気 ドレン回収タンク</td> <td align="center">○</td> <td align="center">-</td> </tr> <tr> <td>機器ドレンタンク</td> <td align="center">○</td> <td align="center">-</td> </tr> <tr> <td>機器ドレン処理水タンク</td> <td align="center">○</td> <td align="center">-</td> </tr> <tr> <td></td> <td></td> <td>凝縮水受タンク</td> <td align="center">○</td> <td align="center">-</td> </tr> </tbody> </table> <p>※1 ()内は、設置階の基準床高さを示す。</p>	建物	設置階※1	機器	溢水源とする機器	溢水源としない機器	廃棄物 処理 建物	地上3階 (EL26.7m)	ランドリ・ドレン すすぎ水受タンク	○	-	ランドリ・ドレン 収集タンク	○	-	ランドリ・ドレン サンプルタンク	○	-	濃縮廃液タンク用 温水タンク	○	-	ランドリ・ドレン 濃縮廃液タンク	○	-	地上2階 (EL22.1m)	床ドレン濃縮器	○	-	ランドリ・ドレン サンプルタンク	○	-	機器ドレンろ過脱塩器	○	-	機器ドレン脱塩器	○	-	機器ドレンろ過脱塩装置	○	-	ブリコートタンク	○	-	凝縮水ろ過脱塩器	○	-	地上1階 (EL15.3m)	インヒビタ添加タンク	○	-	硫酸添加タンク	○	-	地下中1階 (EL12.3m)	濃縮廃液ポンプ封水用 冷却器	○	-	地下1階 (EL8.8m)	RW/B陰イオン フロックタンク	○	-	RW/B陽イオン フロックタンク	○	-	復水系スラッジ貯蔵タンク	○	-	復水系樹脂貯蔵タンク	○	-	地下2階 (EL3.0m)	原子炉浄化系樹脂貯蔵 タンク	○	-	RW/B所内蒸気 ドレン回収タンク	○	-	機器ドレンタンク	○	-	機器ドレン処理水タンク	○	-			凝縮水受タンク	○	-	
建物	設置階※1	機器	溢水源とする機器	溢水源としない機器																																																																																					
廃棄物 処理 建物	地上3階 (EL26.7m)	ランドリ・ドレン すすぎ水受タンク	○	-																																																																																					
		ランドリ・ドレン 収集タンク	○	-																																																																																					
		ランドリ・ドレン サンプルタンク	○	-																																																																																					
		濃縮廃液タンク用 温水タンク	○	-																																																																																					
		ランドリ・ドレン 濃縮廃液タンク	○	-																																																																																					
	地上2階 (EL22.1m)	床ドレン濃縮器	○	-																																																																																					
		ランドリ・ドレン サンプルタンク	○	-																																																																																					
		機器ドレンろ過脱塩器	○	-																																																																																					
		機器ドレン脱塩器	○	-																																																																																					
		機器ドレンろ過脱塩装置	○	-																																																																																					
		ブリコートタンク	○	-																																																																																					
		凝縮水ろ過脱塩器	○	-																																																																																					
	地上1階 (EL15.3m)	インヒビタ添加タンク	○	-																																																																																					
		硫酸添加タンク	○	-																																																																																					
	地下中1階 (EL12.3m)	濃縮廃液ポンプ封水用 冷却器	○	-																																																																																					
	地下1階 (EL8.8m)	RW/B陰イオン フロックタンク	○	-																																																																																					
		RW/B陽イオン フロックタンク	○	-																																																																																					
		復水系スラッジ貯蔵タンク	○	-																																																																																					
		復水系樹脂貯蔵タンク	○	-																																																																																					
	地下2階 (EL3.0m)	原子炉浄化系樹脂貯蔵 タンク	○	-																																																																																					
		RW/B所内蒸気 ドレン回収タンク	○	-																																																																																					
		機器ドレンタンク	○	-																																																																																					
		機器ドレン処理水タンク	○	-																																																																																					
		凝縮水受タンク	○	-																																																																																					

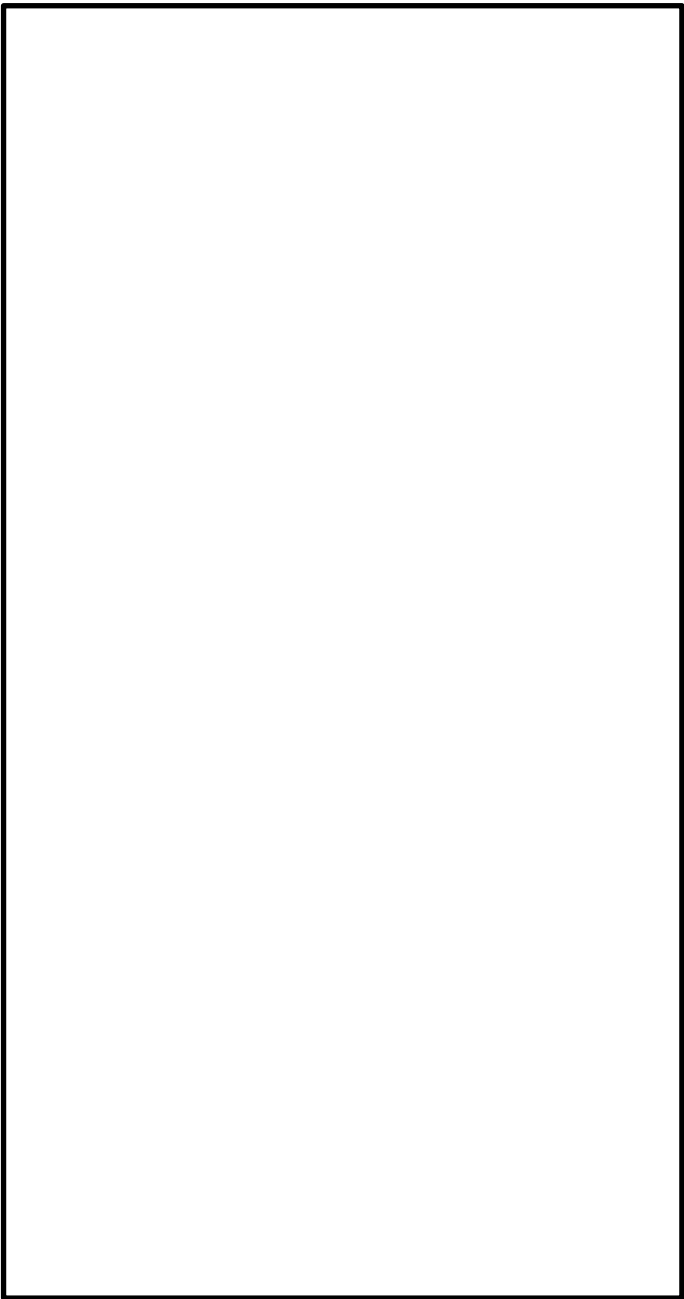
柏崎刈羽原子力発電所 6 / 7号炉 (2017.12.20版)	東海第二発電所 (2018.9.18版)	島根原子力発電所 2号炉	備考																																																				
		<p style="text-align: center;"><u>表 1-3 溢水源とする機器としない機器(4/4)</u></p> <table border="1" data-bbox="1745 352 2493 991"> <thead> <tr> <th>建物</th> <th>設置階^{※1}</th> <th>機器</th> <th>溢水源とする機器</th> <th>溢水源としない機器</th> </tr> </thead> <tbody> <tr><td rowspan="14">廃棄物処理建物</td><td rowspan="14">地下2階 (EL3.0m)</td><td>処理水タンク</td><td>○</td><td>—</td></tr> <tr><td>床ドレンタンク</td><td>○</td><td>—</td></tr> <tr><td>化学廃液タンク</td><td>○</td><td>—</td></tr> <tr><td>ランドリ・ドレンタンク</td><td>○</td><td>—</td></tr> <tr><td>濃縮廃液タンク</td><td>○</td><td>—</td></tr> <tr><td>復水スラッジ分離タンク</td><td>○</td><td>—</td></tr> <tr><td>機器ドレンろ過脱塩装置 逆洗水受タンク</td><td>○</td><td>—</td></tr> <tr><td>機器ドレンスラッジ 分離タンク</td><td>○</td><td>—</td></tr> <tr><td>原子炉浄化系スラッジ 貯蔵タンク</td><td>○</td><td>—</td></tr> <tr><td>廃棄物処理建物 機器ドレンサンプタンク</td><td>○</td><td>—</td></tr> <tr><td>廃棄物処理建物 床ドレンサンプタンク</td><td>○</td><td>—</td></tr> <tr><td>廃棄物処理建物 化学廃液サンプタンク</td><td>○</td><td>—</td></tr> <tr><td>—</td><td>配管</td><td>○^{※2}</td><td>○^{※3}</td></tr> <tr><td>海水ポンプエリア</td><td>— (EL1.1m)</td><td>配管</td><td>—</td><td>○^{※3}</td></tr> </tbody> </table> <p>※1 () 内は、設置階の基準床高さを示す。 ※2 右記以外。 ※3 詳細は表 1-4 による。</p>	建物	設置階 ^{※1}	機器	溢水源とする機器	溢水源としない機器	廃棄物処理建物	地下2階 (EL3.0m)	処理水タンク	○	—	床ドレンタンク	○	—	化学廃液タンク	○	—	ランドリ・ドレンタンク	○	—	濃縮廃液タンク	○	—	復水スラッジ分離タンク	○	—	機器ドレンろ過脱塩装置 逆洗水受タンク	○	—	機器ドレンスラッジ 分離タンク	○	—	原子炉浄化系スラッジ 貯蔵タンク	○	—	廃棄物処理建物 機器ドレンサンプタンク	○	—	廃棄物処理建物 床ドレンサンプタンク	○	—	廃棄物処理建物 化学廃液サンプタンク	○	—	—	配管	○ ^{※2}	○ ^{※3}	海水ポンプエリア	— (EL1.1m)	配管	—	○ ^{※3}	
建物	設置階 ^{※1}	機器	溢水源とする機器	溢水源としない機器																																																			
廃棄物処理建物	地下2階 (EL3.0m)	処理水タンク	○	—																																																			
		床ドレンタンク	○	—																																																			
		化学廃液タンク	○	—																																																			
		ランドリ・ドレンタンク	○	—																																																			
		濃縮廃液タンク	○	—																																																			
		復水スラッジ分離タンク	○	—																																																			
		機器ドレンろ過脱塩装置 逆洗水受タンク	○	—																																																			
		機器ドレンスラッジ 分離タンク	○	—																																																			
		原子炉浄化系スラッジ 貯蔵タンク	○	—																																																			
		廃棄物処理建物 機器ドレンサンプタンク	○	—																																																			
		廃棄物処理建物 床ドレンサンプタンク	○	—																																																			
		廃棄物処理建物 化学廃液サンプタンク	○	—																																																			
		—	配管	○ ^{※2}	○ ^{※3}																																																		
		海水ポンプエリア	— (EL1.1m)	配管	—	○ ^{※3}																																																	

柏崎刈羽原子力発電所 6 / 7号炉 (2017. 12. 20 版)	東海第二発電所 (2018. 9. 18 版)	島根原子力発電所 2号炉	備考																																																												
		<p style="text-align: center;">表 1-4 溢水源としない配管 (1/5)</p> <table border="1" style="width: 100%; border-collapse: collapse;"> <thead> <tr> <th style="width: 15%;">建物</th> <th style="width: 15%;">設置階*</th> <th style="width: 15%;">設置区画</th> <th style="width: 55%;">配管</th> </tr> </thead> <tbody> <tr> <td rowspan="22" style="text-align: center; vertical-align: middle;">原子炉建物</td> <td rowspan="1">地上 4 階 (EL42. 8m)</td> <td>R-4F-01-1N</td> <td>燃料プール冷却系</td> </tr> <tr> <td rowspan="10">地上 3 階 (EL34. 8m)</td> <td>R-3F-04-1N</td> <td>原子炉補機冷却系</td> </tr> <tr> <td>R-3F-04-2N</td> <td>空調換気設備冷却水系</td> </tr> <tr> <td>R-3F-07N</td> <td>復水輸送系</td> </tr> <tr> <td>R-3F-16-1N</td> <td>補給水系 消火系</td> </tr> <tr> <td>R-3F-06N</td> <td>空調換気設備冷却水系 補給水系</td> </tr> <tr> <td>R-3F-05N</td> <td>消火系</td> </tr> <tr> <td>R-3F-11N</td> <td>原子炉浄化系</td> </tr> <tr> <td>R-3F-25N</td> <td>消火系</td> </tr> <tr> <td>R-3F-12-2N</td> <td>消火系</td> </tr> <tr> <td>R-3F-100N</td> <td>補給水系 消火系</td> </tr> <tr> <td>R-3F-02N</td> <td>空調換気設備冷却水系 消火系</td> </tr> <tr> <td>R-3F-03N</td> <td>消火系</td> </tr> <tr> <td>R-3F-14N</td> <td>消火系</td> </tr> <tr> <td rowspan="10">地上中 2 階 (EL30. 5m)</td> <td>R-M2F-3N</td> <td>原子炉浄化系</td> </tr> <tr> <td>R-M2F-4N</td> <td></td> </tr> <tr> <td>R-M2F-5N</td> <td></td> </tr> <tr> <td>R-M2F-06N</td> <td>原子炉補機冷却系 燃料プール冷却系</td> </tr> <tr> <td>R-M2F-07N</td> <td>ドライウエル冷却系 空調換気設備冷却水系 補給水系 消火系</td> </tr> <tr> <td>R-M2F-08N</td> <td>原子炉浄化系</td> </tr> <tr> <td>R-M2F-11N</td> <td>原子炉浄化系</td> </tr> <tr> <td>R-M2F-12N</td> <td>補給水系</td> </tr> <tr> <td>R-M2F-26N</td> <td>消火系</td> </tr> <tr> <td>R-M2F-18-1N</td> <td>原子炉補機冷却系</td> </tr> <tr> <td>R-M2F-21N</td> <td>空調換気設備冷却水系</td> </tr> <tr> <td>R-M2F-22N</td> <td>消火系</td> </tr> </tbody> </table> <p>※ () 内は, 設置階の基準床高さを示す。</p>	建物	設置階*	設置区画	配管	原子炉建物	地上 4 階 (EL42. 8m)	R-4F-01-1N	燃料プール冷却系	地上 3 階 (EL34. 8m)	R-3F-04-1N	原子炉補機冷却系	R-3F-04-2N	空調換気設備冷却水系	R-3F-07N	復水輸送系	R-3F-16-1N	補給水系 消火系	R-3F-06N	空調換気設備冷却水系 補給水系	R-3F-05N	消火系	R-3F-11N	原子炉浄化系	R-3F-25N	消火系	R-3F-12-2N	消火系	R-3F-100N	補給水系 消火系	R-3F-02N	空調換気設備冷却水系 消火系	R-3F-03N	消火系	R-3F-14N	消火系	地上中 2 階 (EL30. 5m)	R-M2F-3N	原子炉浄化系	R-M2F-4N		R-M2F-5N		R-M2F-06N	原子炉補機冷却系 燃料プール冷却系	R-M2F-07N	ドライウエル冷却系 空調換気設備冷却水系 補給水系 消火系	R-M2F-08N	原子炉浄化系	R-M2F-11N	原子炉浄化系	R-M2F-12N	補給水系	R-M2F-26N	消火系	R-M2F-18-1N	原子炉補機冷却系	R-M2F-21N	空調換気設備冷却水系	R-M2F-22N	消火系	<p>・設備の相違 【柏崎 6/7, 東海第二】</p>
建物	設置階*	設置区画	配管																																																												
原子炉建物	地上 4 階 (EL42. 8m)	R-4F-01-1N	燃料プール冷却系																																																												
	地上 3 階 (EL34. 8m)	R-3F-04-1N	原子炉補機冷却系																																																												
		R-3F-04-2N	空調換気設備冷却水系																																																												
		R-3F-07N	復水輸送系																																																												
		R-3F-16-1N	補給水系 消火系																																																												
		R-3F-06N	空調換気設備冷却水系 補給水系																																																												
		R-3F-05N	消火系																																																												
		R-3F-11N	原子炉浄化系																																																												
		R-3F-25N	消火系																																																												
		R-3F-12-2N	消火系																																																												
		R-3F-100N	補給水系 消火系																																																												
	R-3F-02N	空調換気設備冷却水系 消火系																																																													
	R-3F-03N	消火系																																																													
	R-3F-14N	消火系																																																													
	地上中 2 階 (EL30. 5m)	R-M2F-3N	原子炉浄化系																																																												
		R-M2F-4N																																																													
		R-M2F-5N																																																													
		R-M2F-06N	原子炉補機冷却系 燃料プール冷却系																																																												
		R-M2F-07N	ドライウエル冷却系 空調換気設備冷却水系 補給水系 消火系																																																												
		R-M2F-08N	原子炉浄化系																																																												
		R-M2F-11N	原子炉浄化系																																																												
		R-M2F-12N	補給水系																																																												
R-M2F-26N		消火系																																																													
R-M2F-18-1N		原子炉補機冷却系																																																													
R-M2F-21N	空調換気設備冷却水系																																																														
R-M2F-22N	消火系																																																														

柏崎刈羽原子力発電所 6 / 7号炉 (2017. 12. 20 版)	東海第二発電所 (2018. 9. 18 版)	島根原子力発電所 2号炉	備考																																													
		<p style="text-align: center;"><u>表 1-4 溢水源としない配管 (2/5)</u></p> <table border="1" style="width: 100%; border-collapse: collapse;"> <thead> <tr> <th style="width: 15%;">建物</th> <th style="width: 15%;">設置階*</th> <th style="width: 15%;">設置区画</th> <th style="width: 55%;">配管</th> </tr> </thead> <tbody> <tr> <td rowspan="18" style="text-align: center; vertical-align: middle;">原子炉建物</td> <td rowspan="4" style="text-align: center; vertical-align: middle;">地上中 2 階 (EL30. 5m)</td> <td style="text-align: center;">R-M2F-18-2N</td> <td>原子炉浄化系 原子炉補機冷却系 ドライウエル冷却系 消火系</td> </tr> <tr> <td style="text-align: center;">R-M2F-20N</td> <td>原子炉補機冷却系 ドライウエル冷却系 空調換気設備冷却水系</td> </tr> <tr> <td style="text-align: center;">R-M2F-27N</td> <td>復水輸送系</td> </tr> <tr> <td style="text-align: center;">R-M2F-02N</td> <td>消火系</td> </tr> <tr> <td rowspan="14" style="text-align: center; vertical-align: middle;">地上 2 階 (EL23. 8m)</td> <td style="text-align: center;">R-2F-09N</td> <td>原子炉浄化系</td> </tr> <tr> <td style="text-align: center;">R-2F-10N</td> <td>燃料プール冷却系 消火系</td> </tr> <tr> <td style="text-align: center;">R-2F-11N</td> <td>原子炉浄化系</td> </tr> <tr> <td style="text-align: center;">R-2F-12N</td> <td>消火系</td> </tr> <tr> <td style="text-align: center;">R-2F-18N</td> <td></td> </tr> <tr> <td style="text-align: center;">R-2F-19N</td> <td></td> </tr> <tr> <td style="text-align: center;">R-2F-24N</td> <td></td> </tr> <tr> <td style="text-align: center;">R-2F-25N</td> <td></td> </tr> <tr> <td style="text-align: center;">R-2F-14N</td> <td>制御棒駆動系 原子炉浄化系 復水輸送系</td> </tr> <tr> <td style="text-align: center;">R-2F-15N</td> <td>復水輸送系</td> </tr> <tr> <td style="text-align: center;">R-2F-08N</td> <td>原子炉補機冷却系 空調換気設備冷却水系 消火系</td> </tr> <tr> <td style="text-align: center;">R-2F-04N</td> <td>消火系</td> </tr> <tr> <td style="text-align: center;">R-2F-05N</td> <td>消火系</td> </tr> <tr> <td style="text-align: center;">R-2F-06N</td> <td>消火系</td> </tr> <tr> <td style="text-align: center;">R-2F-21N</td> <td>消火系</td> </tr> </tbody> </table> <p>※ () 内は、設置階の基準床高さを示す。</p>	建物	設置階*	設置区画	配管	原子炉建物	地上中 2 階 (EL30. 5m)	R-M2F-18-2N	原子炉浄化系 原子炉補機冷却系 ドライウエル冷却系 消火系	R-M2F-20N	原子炉補機冷却系 ドライウエル冷却系 空調換気設備冷却水系	R-M2F-27N	復水輸送系	R-M2F-02N	消火系	地上 2 階 (EL23. 8m)	R-2F-09N	原子炉浄化系	R-2F-10N	燃料プール冷却系 消火系	R-2F-11N	原子炉浄化系	R-2F-12N	消火系	R-2F-18N		R-2F-19N		R-2F-24N		R-2F-25N		R-2F-14N	制御棒駆動系 原子炉浄化系 復水輸送系	R-2F-15N	復水輸送系	R-2F-08N	原子炉補機冷却系 空調換気設備冷却水系 消火系	R-2F-04N	消火系	R-2F-05N	消火系	R-2F-06N	消火系	R-2F-21N	消火系	
建物	設置階*	設置区画	配管																																													
原子炉建物	地上中 2 階 (EL30. 5m)	R-M2F-18-2N	原子炉浄化系 原子炉補機冷却系 ドライウエル冷却系 消火系																																													
		R-M2F-20N	原子炉補機冷却系 ドライウエル冷却系 空調換気設備冷却水系																																													
		R-M2F-27N	復水輸送系																																													
		R-M2F-02N	消火系																																													
	地上 2 階 (EL23. 8m)	R-2F-09N	原子炉浄化系																																													
		R-2F-10N	燃料プール冷却系 消火系																																													
		R-2F-11N	原子炉浄化系																																													
		R-2F-12N	消火系																																													
		R-2F-18N																																														
		R-2F-19N																																														
		R-2F-24N																																														
		R-2F-25N																																														
		R-2F-14N	制御棒駆動系 原子炉浄化系 復水輸送系																																													
		R-2F-15N	復水輸送系																																													
		R-2F-08N	原子炉補機冷却系 空調換気設備冷却水系 消火系																																													
		R-2F-04N	消火系																																													
		R-2F-05N	消火系																																													
		R-2F-06N	消火系																																													
R-2F-21N	消火系																																															

柏崎刈羽原子力発電所 6 / 7号炉 (2017. 12. 20 版)	東海第二発電所 (2018. 9. 18 版)	島根原子力発電所 2号炉	備考																																																					
		<p style="text-align: center;"><u>表 1-4 溢水源としない配管 (3/5)</u></p> <table border="1" style="width: 100%; border-collapse: collapse;"> <thead> <tr> <th style="width: 15%;">建物</th> <th style="width: 15%;">設置階*</th> <th style="width: 20%;">設置区画</th> <th style="width: 50%;">配管</th> </tr> </thead> <tbody> <tr> <td rowspan="15" style="text-align: center; vertical-align: middle;">原子炉建物</td> <td rowspan="10" style="text-align: center; vertical-align: middle;">地上 1 階 (EL15. 3m)</td> <td>R-1F-03N</td> <td>復水輸送系</td> </tr> <tr> <td>R-1F-22N</td> <td>消火系</td> </tr> <tr> <td>R-1F-07-1N</td> <td>原子炉浄化系</td> </tr> <tr> <td rowspan="3">R-1F-07-2N</td> <td>原子炉補機冷却系</td> </tr> <tr> <td>ドライウエル冷却系</td> </tr> <tr> <td>空調換気設備冷却水系</td> </tr> <tr> <td>R-1F-10N</td> <td>消火系</td> </tr> <tr> <td>R-1F-13N</td> <td>復水輸送系</td> </tr> <tr> <td>R-1F-33N</td> <td>空調換気設備冷却水系</td> </tr> <tr> <td>R-1F-01-1N</td> <td>補給水系</td> </tr> <tr> <td rowspan="2">R-1F-02N</td> <td>原子炉補機冷却系</td> </tr> <tr> <td>空調換気設備冷却水系</td> </tr> <tr> <td rowspan="3">R-1F-14N</td> <td>原子炉補機冷却系</td> </tr> <tr> <td>原子炉補機海水系</td> </tr> <tr> <td>空調換気設備冷却水系</td> </tr> <tr> <td rowspan="4">R-1F-15N</td> <td>原子炉補機冷却系</td> </tr> <tr> <td>原子炉補機海水系</td> </tr> <tr> <td>ドライウエル冷却系</td> </tr> <tr> <td>空調換気設備冷却水系</td> </tr> <tr> <td rowspan="3">R-1F-24-2N</td> <td>補給水系</td> </tr> <tr> <td>消火系</td> </tr> <tr> <td>消火系</td> </tr> <tr> <td rowspan="3" style="text-align: center; vertical-align: middle;">地下 1 階 (EL8. 8m)</td> <td rowspan="2">R-B1F-01N R-B1F-08N</td> <td>原子炉補機冷却系</td> </tr> <tr> <td>高圧炉心スプレイ系</td> </tr> <tr> <td>R-B1F-07N</td> <td>空調換気設備冷却水系</td> </tr> <tr> <td rowspan="2">R-B1F-09N</td> <td>復水輸送系</td> </tr> <tr> <td>消火系</td> </tr> <tr> <td></td> <td></td> <td></td> <td></td> </tr> </tbody> </table> <p>※ () 内は, 設置階の基準床高さを示す。</p>	建物	設置階*	設置区画	配管	原子炉建物	地上 1 階 (EL15. 3m)	R-1F-03N	復水輸送系	R-1F-22N	消火系	R-1F-07-1N	原子炉浄化系	R-1F-07-2N	原子炉補機冷却系	ドライウエル冷却系	空調換気設備冷却水系	R-1F-10N	消火系	R-1F-13N	復水輸送系	R-1F-33N	空調換気設備冷却水系	R-1F-01-1N	補給水系	R-1F-02N	原子炉補機冷却系	空調換気設備冷却水系	R-1F-14N	原子炉補機冷却系	原子炉補機海水系	空調換気設備冷却水系	R-1F-15N	原子炉補機冷却系	原子炉補機海水系	ドライウエル冷却系	空調換気設備冷却水系	R-1F-24-2N	補給水系	消火系	消火系	地下 1 階 (EL8. 8m)	R-B1F-01N R-B1F-08N	原子炉補機冷却系	高圧炉心スプレイ系	R-B1F-07N	空調換気設備冷却水系	R-B1F-09N	復水輸送系	消火系					
建物	設置階*	設置区画	配管																																																					
原子炉建物	地上 1 階 (EL15. 3m)	R-1F-03N	復水輸送系																																																					
		R-1F-22N	消火系																																																					
		R-1F-07-1N	原子炉浄化系																																																					
		R-1F-07-2N	原子炉補機冷却系																																																					
			ドライウエル冷却系																																																					
			空調換気設備冷却水系																																																					
		R-1F-10N	消火系																																																					
		R-1F-13N	復水輸送系																																																					
		R-1F-33N	空調換気設備冷却水系																																																					
		R-1F-01-1N	補給水系																																																					
	R-1F-02N	原子炉補機冷却系																																																						
		空調換気設備冷却水系																																																						
	R-1F-14N	原子炉補機冷却系																																																						
		原子炉補機海水系																																																						
		空調換気設備冷却水系																																																						
R-1F-15N	原子炉補機冷却系																																																							
	原子炉補機海水系																																																							
	ドライウエル冷却系																																																							
	空調換気設備冷却水系																																																							
R-1F-24-2N	補給水系																																																							
	消火系																																																							
	消火系																																																							
地下 1 階 (EL8. 8m)	R-B1F-01N R-B1F-08N	原子炉補機冷却系																																																						
		高圧炉心スプレイ系																																																						
	R-B1F-07N	空調換気設備冷却水系																																																						
R-B1F-09N	復水輸送系																																																							
	消火系																																																							

柏崎刈羽原子力発電所 6 / 7号炉 (2017. 12. 20 版)	東海第二発電所 (2018. 9. 18 版)	島根原子力発電所 2号炉	備考																																															
		<p style="text-align: center;"><u>表 1-4 溢水源としない配管 (4/5)</u></p> <table border="1" style="width: 100%; border-collapse: collapse;"> <thead> <tr> <th style="width: 15%;">建物</th> <th style="width: 15%;">設置階※</th> <th style="width: 15%;">設置区画</th> <th style="width: 55%;">配管</th> </tr> </thead> <tbody> <tr> <td rowspan="20" style="text-align: center; vertical-align: middle;">原子炉建物</td> <td rowspan="10" style="text-align: center; vertical-align: middle;">地下1階 (EL8. 8m)</td> <td style="text-align: center;">R-B1F-10N</td> <td>原子炉浄化系 原子炉補機冷却系 復水輸送系 消火系</td> </tr> <tr> <td style="text-align: center;">R-B1F-13N</td> <td>消火系</td> </tr> <tr> <td style="text-align: center;">R-B1F-18-1N</td> <td>消火系</td> </tr> <tr> <td style="text-align: center;">R-B1F-21N</td> <td>原子炉隔離時冷却系 高圧炉心スプレイ系</td> </tr> <tr> <td style="text-align: center;">R-B1F-11N</td> <td>原子炉補機海水系</td> </tr> <tr> <td style="text-align: center;">R-B1F-12N</td> <td>補給水系</td> </tr> <tr> <td style="text-align: center;">R-B1F-16N</td> <td>消火系</td> </tr> <tr> <td style="text-align: center;">R-B1F-17-1N</td> <td>消火系</td> </tr> <tr> <td style="text-align: center;">R-B1F-17-2N</td> <td>原子炉補機冷却系 消火系</td> </tr> <tr> <td style="text-align: center;">R-B1F-20N</td> <td>原子炉補機海水系</td> </tr> <tr> <td style="text-align: center;">R-B1F-29N</td> <td>補給水系</td> </tr> <tr> <td rowspan="10" style="text-align: center; vertical-align: middle;">地下2階 (EL1. 3m)</td> <td style="text-align: center;">R-B2F-01N</td> <td>原子炉隔離時冷却系 消火系</td> </tr> <tr> <td style="text-align: center;">R-B2F-02N</td> <td>補給水系 消火系</td> </tr> <tr> <td style="text-align: center;">R-B2F-03N</td> <td>補給水系</td> </tr> <tr> <td style="text-align: center;">R-B2F-09N</td> <td>復水輸送系 消火系</td> </tr> <tr> <td style="text-align: center;">R-B2F-10N</td> <td>高圧炉心スプレイ系 液体廃棄物処理系 (機器ドレン系) 復水輸送系 補給水系 消火系</td> </tr> <tr> <td style="text-align: center;">R-B2F-15N</td> <td>消火系</td> </tr> <tr> <td style="text-align: center;">R-B2F-31N</td> <td>原子炉隔離時冷却系 高圧炉心スプレイ系</td> </tr> <tr> <td colspan="3"></td> <td>※ () 内は、設置階の基準床高さを示す。</td> </tr> </tbody> </table>	建物	設置階※	設置区画	配管	原子炉建物	地下1階 (EL8. 8m)	R-B1F-10N	原子炉浄化系 原子炉補機冷却系 復水輸送系 消火系	R-B1F-13N	消火系	R-B1F-18-1N	消火系	R-B1F-21N	原子炉隔離時冷却系 高圧炉心スプレイ系	R-B1F-11N	原子炉補機海水系	R-B1F-12N	補給水系	R-B1F-16N	消火系	R-B1F-17-1N	消火系	R-B1F-17-2N	原子炉補機冷却系 消火系	R-B1F-20N	原子炉補機海水系	R-B1F-29N	補給水系	地下2階 (EL1. 3m)	R-B2F-01N	原子炉隔離時冷却系 消火系	R-B2F-02N	補給水系 消火系	R-B2F-03N	補給水系	R-B2F-09N	復水輸送系 消火系	R-B2F-10N	高圧炉心スプレイ系 液体廃棄物処理系 (機器ドレン系) 復水輸送系 補給水系 消火系	R-B2F-15N	消火系	R-B2F-31N	原子炉隔離時冷却系 高圧炉心スプレイ系				※ () 内は、設置階の基準床高さを示す。	
建物	設置階※	設置区画	配管																																															
原子炉建物	地下1階 (EL8. 8m)	R-B1F-10N	原子炉浄化系 原子炉補機冷却系 復水輸送系 消火系																																															
		R-B1F-13N	消火系																																															
		R-B1F-18-1N	消火系																																															
		R-B1F-21N	原子炉隔離時冷却系 高圧炉心スプレイ系																																															
		R-B1F-11N	原子炉補機海水系																																															
		R-B1F-12N	補給水系																																															
		R-B1F-16N	消火系																																															
		R-B1F-17-1N	消火系																																															
		R-B1F-17-2N	原子炉補機冷却系 消火系																																															
		R-B1F-20N	原子炉補機海水系																																															
	R-B1F-29N	補給水系																																																
	地下2階 (EL1. 3m)	R-B2F-01N	原子炉隔離時冷却系 消火系																																															
		R-B2F-02N	補給水系 消火系																																															
		R-B2F-03N	補給水系																																															
		R-B2F-09N	復水輸送系 消火系																																															
		R-B2F-10N	高圧炉心スプレイ系 液体廃棄物処理系 (機器ドレン系) 復水輸送系 補給水系 消火系																																															
		R-B2F-15N	消火系																																															
		R-B2F-31N	原子炉隔離時冷却系 高圧炉心スプレイ系																																															
					※ () 内は、設置階の基準床高さを示す。																																													

柏崎刈羽原子力発電所 6 / 7号炉 (2017.12.20版)	東海第二発電所 (2018.9.18版)	島根原子力発電所 2号炉	備考																																								
		<p style="text-align: center;"><u>表 1-4 溢水源としない配管 (5/5)</u></p> <table border="1" data-bbox="1754 359 2496 1087"> <thead> <tr> <th>建物</th> <th>設置階*</th> <th>設置区画</th> <th>配管系統</th> </tr> </thead> <tbody> <tr> <td rowspan="10">原子炉建物</td> <td rowspan="10">地下2階 (EL1.3m)</td> <td>R-B2F-04N</td> <td>補給水系</td> </tr> <tr> <td>R-B2F-06N</td> <td>補給水系</td> </tr> <tr> <td>R-B2F-07N</td> <td>補給水系</td> </tr> <tr> <td>R-B2F-08N</td> <td>消火系</td> </tr> <tr> <td>R-B2F-11N</td> <td>消火系</td> </tr> <tr> <td>R-B2F-12N</td> <td>高圧炉心スプレイ系 補給水系</td> </tr> <tr> <td>R-B2F-13N</td> <td>補給水系</td> </tr> <tr> <td>R-B2F-14N</td> <td>補給水系</td> </tr> <tr> <td>R-B2F-16N</td> <td>高圧炉心スプレイ補機海水系 消火系</td> </tr> <tr> <td>R-B2F-17N R-B2F-18N R-B2F-19N</td> <td>消火系</td> </tr> <tr> <td rowspan="2">廃棄物処理建物</td> <td rowspan="2">地上2階 (EL22.1m)</td> <td>RW-2F-01N</td> <td>消火系</td> </tr> <tr> <td>RW-2F-02N</td> <td>原子炉補機冷却系 消火系</td> </tr> <tr> <td rowspan="3">海水ポンプ エリア</td> <td rowspan="3">— (EL1.1m)</td> <td>Y-24AN</td> <td>補給水系 消火系</td> </tr> <tr> <td>Y-24BN</td> <td>補給水系 消火系</td> </tr> <tr> <td>Y-24CN</td> <td>消火系</td> </tr> </tbody> </table> <p>※ () 内は、設置階の基準床高さを示す。</p>	建物	設置階*	設置区画	配管系統	原子炉建物	地下2階 (EL1.3m)	R-B2F-04N	補給水系	R-B2F-06N	補給水系	R-B2F-07N	補給水系	R-B2F-08N	消火系	R-B2F-11N	消火系	R-B2F-12N	高圧炉心スプレイ系 補給水系	R-B2F-13N	補給水系	R-B2F-14N	補給水系	R-B2F-16N	高圧炉心スプレイ補機海水系 消火系	R-B2F-17N R-B2F-18N R-B2F-19N	消火系	廃棄物処理建物	地上2階 (EL22.1m)	RW-2F-01N	消火系	RW-2F-02N	原子炉補機冷却系 消火系	海水ポンプ エリア	— (EL1.1m)	Y-24AN	補給水系 消火系	Y-24BN	補給水系 消火系	Y-24CN	消火系	
建物	設置階*	設置区画	配管系統																																								
原子炉建物	地下2階 (EL1.3m)	R-B2F-04N	補給水系																																								
		R-B2F-06N	補給水系																																								
		R-B2F-07N	補給水系																																								
		R-B2F-08N	消火系																																								
		R-B2F-11N	消火系																																								
		R-B2F-12N	高圧炉心スプレイ系 補給水系																																								
		R-B2F-13N	補給水系																																								
		R-B2F-14N	補給水系																																								
		R-B2F-16N	高圧炉心スプレイ補機海水系 消火系																																								
		R-B2F-17N R-B2F-18N R-B2F-19N	消火系																																								
廃棄物処理建物	地上2階 (EL22.1m)	RW-2F-01N	消火系																																								
		RW-2F-02N	原子炉補機冷却系 消火系																																								
海水ポンプ エリア	— (EL1.1m)	Y-24AN	補給水系 消火系																																								
		Y-24BN	補給水系 消火系																																								
		Y-24CN	消火系																																								

柏崎刈羽原子力発電所 6 / 7号炉 (2017. 12. 20 版)	東海第二発電所 (2018. 9. 18 版)	島根原子力発電所 2号炉	備考
<p style="text-align: right;">添付資料4</p> <p style="text-align: center;">溢水影響評価において期待することができる設備</p> <p>4.1 伝播経路に対する溢水防護の概要</p> <p>「ガイド」に従い、内部溢水の発生を想定した場合、貫通部や扉の間隙などを介して広範囲に溢水が伝播するおそれがある。このような伝播経路に対して止水処置などの溢水防護対策を実施することにより、防護対象設備が設置される区画への溢水の伝播を防ぐなど、溢水の影響を限定的にすることができ、溢水想定下においても安全機能を維持することが可能となる。</p> <p>上記を踏まえ、発生要因毎の溢水源の特性を考慮し、以下の基本方針に基づき溢水防護対策を実施している。</p> <p>4.1.1 想定破損による溢水</p> <p>溢水源の想定にあたっては、防護対象設備自体を含め、一系統における単一の機器の破損による溢水を想定する。このため、多重性または多様性を有する機器の間に伝播経路が存在する場合、単一の機器の破損により、同一の機能を有する複数の系統に影響を与えるおそれがある。</p> <p>上記を踏まえ、多重性・多様性が損なわれないよう、止水処置による安全系統の分離を行っている。(添付第4.1.1-1 図参照)</p>	<p style="text-align: right;">添付資料-4</p> <p style="text-align: center;">溢水影響評価において期待する設備について</p> <p>4.1 伝播経路に対する溢水防護の概要</p> <p>溢水評価ガイドに従い、内部溢水の発生を想定した場合、貫通部や扉の間隙などを介して広範囲に溢水が伝播するおそれがある。このような伝播経路に対して止水措置などの溢水防護対策を実施することにより、防護対象設備が設置される区画への溢水の伝播を防ぐなど、溢水の影響を限定的にすることができ、溢水想定下においても安全機能を維持することが可能となる。</p> <p>上記を踏まえ、発生要因毎の溢水源の特性を考慮し、以下の基本方針に基づき溢水防護対策を検討した。</p> <p>4.1.1 想定破損 (想定する機器の単一破損により生じる溢水)</p> <p>溢水源の想定にあたっては、防護対象設備自体を含め、一系統における単一の機器の破損による溢水を想定する。単一の機器の破損により、多重性又は多様性を有する機器の間に伝播経路が存在する場合、同一の機能を有する複数の系統に影響を与えるおそれがある。</p> <p>上記を踏まえ、多重性・多様性が損なわれないよう、止水措置による安全系統の分離を行う。これらの概要を第1図に示す。</p>	<p style="text-align: center;">添付資料 4 溢水影響評価において期待することができる設備</p> <p>1. 溢水防護の概要</p> <p>1.1 溢水経路に対する対策</p> <p>評価ガイドに従い、内部溢水の発生を想定した場合、貫通部や扉の間隙等を介して広範囲に溢水が伝播するおそれがある。このような溢水伝播経路に対する止水措置、並びに発生した溢水を排水するための排水設備の設置(以下「排水措置」という。)の溢水防護対策を実施することにより、溢水防護対象設備が設置される区画への溢水の伝播を防ぐ等、溢水の影響を限定的にすることができ、溢水想定下においても安全機能を維持することが可能となる。</p> <p>上記を踏まえ、発生要因毎の溢水源の特性を考慮し、以下の基本方針に基づき溢水防護対策を実施している。</p> <p>なお、ここで示す溢水防護対策は基本設計段階での評価であり、今後各種対策の実現性・詳細設計等を精査するに伴い変更が必要となる場合は、適宜反映する。</p> <p>1.1.1 想定破損 (溢水の影響を評価するために想定する機器の破損等により生じる溢水)</p> <p>溢水源の想定にあたっては、溢水防護対象設備自体を含め、一系統における単一の機器の破損による溢水を想定する。このため、多重性又は多様性を有する機器の間に溢水伝播経路が存在する場合、単一の機器の破損により、同一の機能を有する複数の系統に影響を与えるおそれがある。</p> <p>上記を踏まえ、多重性又は多様性が損なわれないよう、止水措置による安全系統の分離を行っている(図1-1参照)。また、多重性又は多様性が損なわれないよう、排水措置による溢水の影響緩和を行っている(図1-2参照)。</p>	<p>・設備の相違</p> <p>【柏崎 6/7, 東海第二】</p> <p>島根 2号炉は溢水水位低減対策として通水扉を設置(排水措置について以下同じ)</p> <p>・設備の相違</p> <p>【柏崎 6/7, 東海第二】</p>

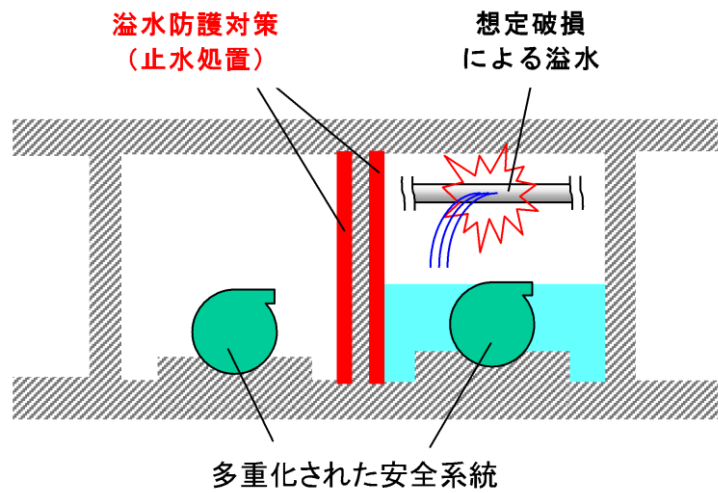

添付第4.1.1-1 図 想定破損による溢水に対する防護概念図

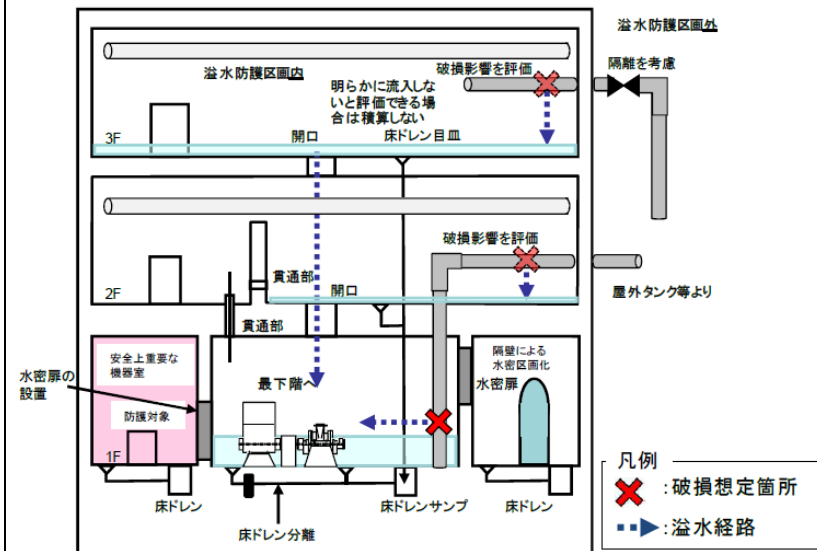

第1 図 想定破損に対する溢水防護概念図



図 1-1 想定破損に対する溢水防護概念図



図 1-2 排水措置の溢水防護概念図

・設備の相違
【柏崎 6/7, 東海第二】

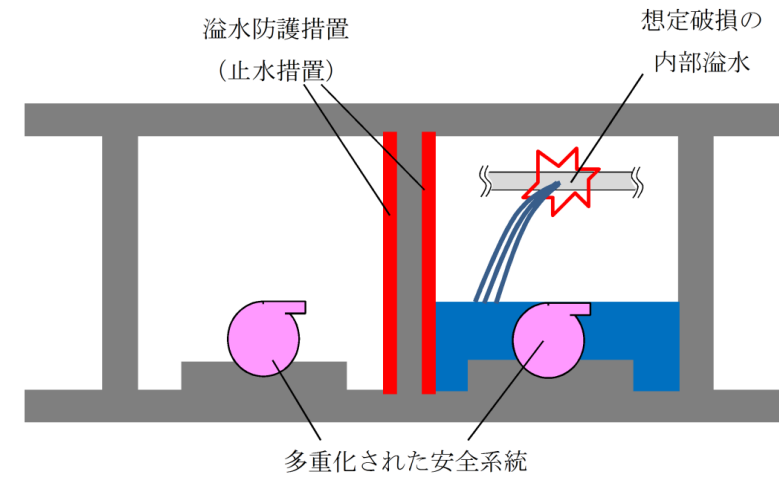
4.1.2 消火水の放水による溢水

溢水源の想定にあたっては、4.1.1 の想定破損と同様に、消火活動に伴う放水による溢水を想定する。このため、伝播経路に対する溢水防護対策も想定破損と同様に実施している。

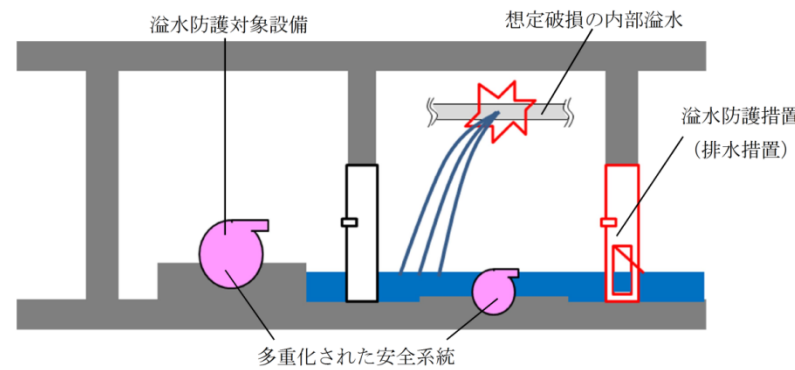
4.1.2 消火系統等の作動(発電所内で生じる異常状態(火災を含む)の拡大防止のために設置される系統からの放水による溢水)

溢水源の想定にあたっては、4.1.1 の想定破損と同様に、消火活動に伴う放水による単一の溢水を想定する。伝播経路に対する溢水防護も想定破損と同様に実施している。

1.1.2 消火水等の溢水(発電所内で生じる異常状態(火災を含む)の拡大防止のために設置される系統からの放水による溢水)

溢水源の想定にあたっては、1.1.1 の想定破損と同様に、消火活動に伴う放水による単一の溢水を想定する。このため、溢水伝播経路に対する溢水防護も想定破損と同様に実施している。

4.1.3 地震起因による溢水

溢水源の想定にあたっては、基準地震動による地震力に対する耐震性が確認されていない耐震B, Cクラスに属する系統からの溢水を保守的に想定する。

4.1.1, 4.1.2 と異なり複数箇所における溢水が想定されるため、想定破損に比べて相対的に溢水量が多く、溢水防護区画外からの溢水の影響が大きくなる傾向となる。

上記を踏まえ、溢水防護区画外の溢水により多重性または多様性を有する安全機能が損なわれないよう止水処置により溢水防護区画と他の区画との分離を行っている。なお、溢水防護区画内の溢水源については原則として耐震性を確保し、溢水防護区画内での溢水の発生を防止している。(添付第4.1.3-1図参照)

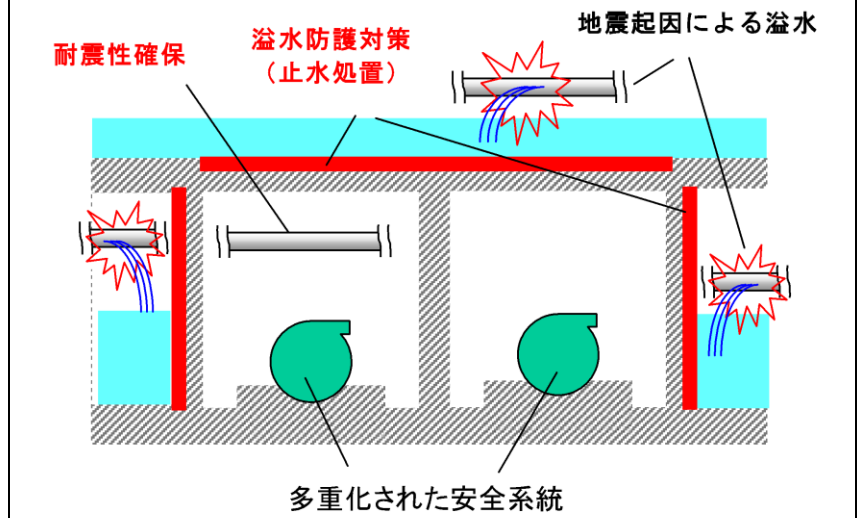

添付第4.1.3-1 図 地震起因による溢水に対する溢水防護概念

4.1.3 地震起因の破損（地震に起因する機器の破損等により生じる溢水）

溢水源の想定にあたっては、基準地震動 S_s による地震力に対する耐震性が確認されていない耐震B, Cクラスに属する系統からの溢水を想定する。

4.1.1, 4.1.2 と異なり複数の破損が想定されるため、想定破損に比べて溢水防護区画外からの溢水の影響が大きくなる。

上記を踏まえ、溢水防護区画外の溢水により多重性又は多様性を有する安全機能が損なわれないよう止水措置により溢水防護区画と他の区画との分離を行う。これらの概要を第2図に示す。

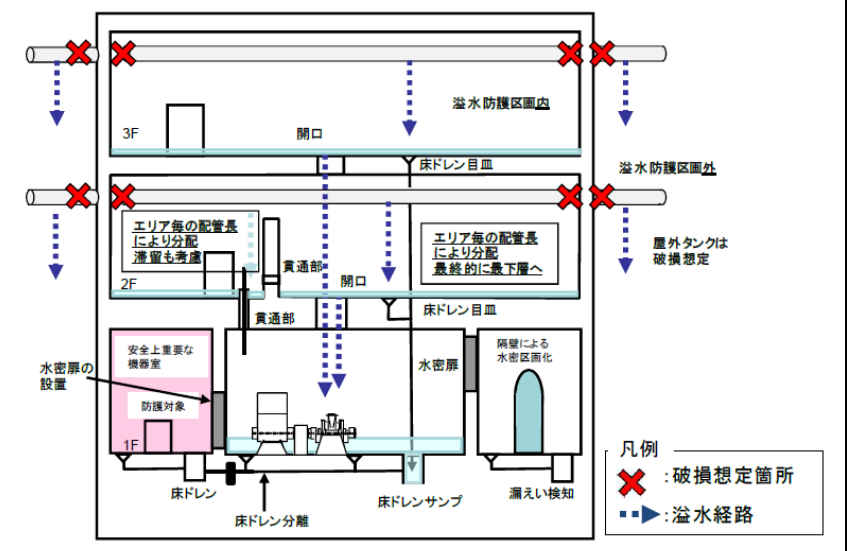

第2図 地震起因の破損等に対する溢水防護概念図

1.1.3 地震起因の破損（地震に起因する機器の破損等により生じる溢水）

溢水源の想定にあたっては、基準地震動 S_s による地震力に対する耐震性が確認されていない耐震 B, C クラスに属する系統からの溢水を保守的に想定する。

1.1.1, 1.1.2 と異なり単一以上の破損が想定されるため、想定破損に比べて相対的に溢水量が大きく、溢水防護区画外からの溢水の影響が大きくなる傾向となる。

上記を踏まえ、溢水防護区画外の溢水により多重性又は多様性を有する安全機能が損なわれないよう止水措置又は排水措置を行っている。なお、溢水防護区画内の溢水源については、必要に応じて基準地震動 S_s による地震力に対して耐震性を確保し、溢水防護区画内での溢水の発生を防止している（図1-3参照）。



図1-3 地震起因の破損に対する溢水防護概念図

1.2 溢水防護対象設備に対する対策

内部溢水の発生を想定した場合に、没水、被水及び蒸気の影響により溢水防護対象設備が機能喪失するおそれがある。このような溢水防護対象設備に対する止水措置又は被水措置の溢水防護対策を実施することにより、溢水想定下においても安全機能を維持することが可能になる。別添1.2.3で示している防護するための設計方針に基づき溢水対策を実施した。

なお、ここで示す溢水防護対策は基本設計段階での評価であ

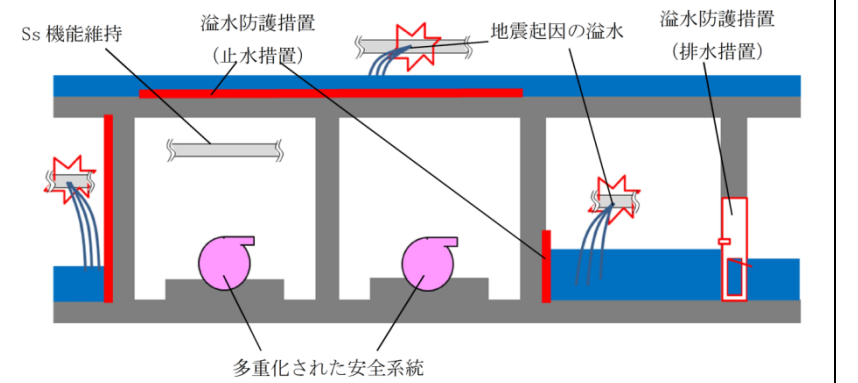
・設備の相違
【柏崎6/7, 東海第二】

・設備の相違
【柏崎6/7, 東海第二】

4.2 溢水防護対策

溢水防護対策が必要となる伝播経路には壁面・床面貫通部（配管、電線管、ケーブルトレイ、空調ダクト）、ハッチ、扉、床ドレン等があり、構造に応じた溢水防護対策を実施している。（添付第4.2-1 図参照）

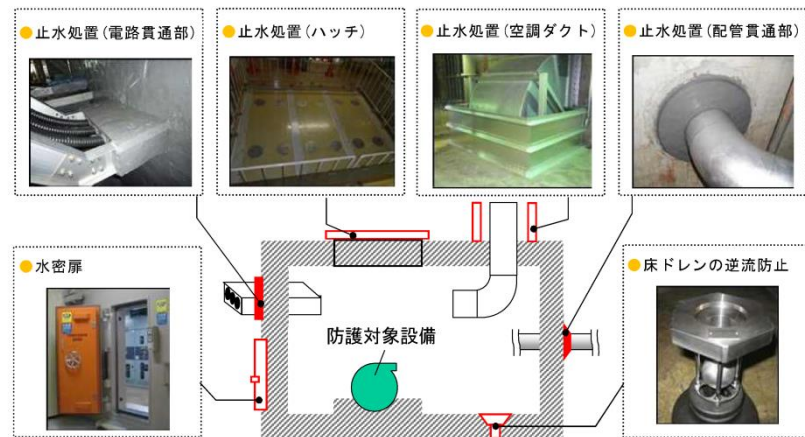

添付第4.2-1 図 主要な溢水防護対策の施工例

4.2 溢水防護対策

溢水防護が必要となる伝播経路には壁面・床面貫通部（配管、電線管、ケーブルトレイ、空調ダクト）、ハッチ、扉、床ドレン等があり、構造に応じた溢水防護対策を実施する。

防護対策の例を第3図及び第4図に、溢水防護対策上止水に期待する設備を第1表に示す。また、設備の位置、仕様、構造を第5図に示す。

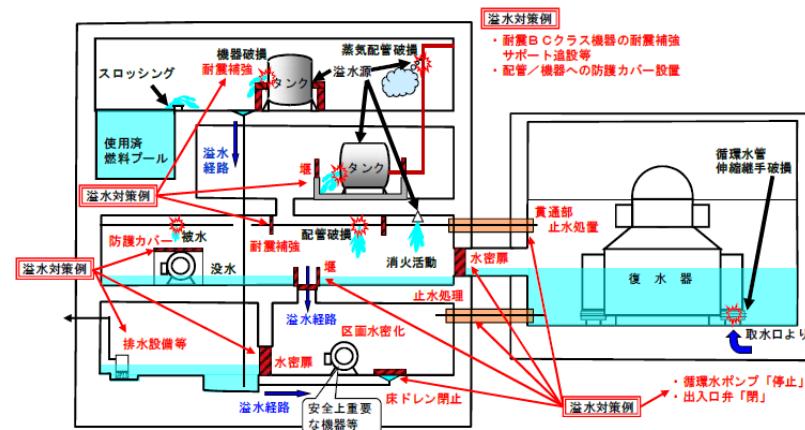

第3図 溢水防護対策（例）

2. 溢水防護対策

溢水防護が必要となる溢水経路又は溢水防護対象設備に水密扉、堰、又は壁面・床面貫通部止水処置（シリコン、ラバーブーツ、モルタル）等の溢水防護対策を実施している（図2-1参照）。



図2-1 主要な溢水防護対策の施工例

水密扉	止水措置（機器ハッチ）
止水措置（堰）	止水措置（床ファンネル）

第4図 既設浸水防護対策（例）

・設備の相違
【柏崎6/7，東海第二】

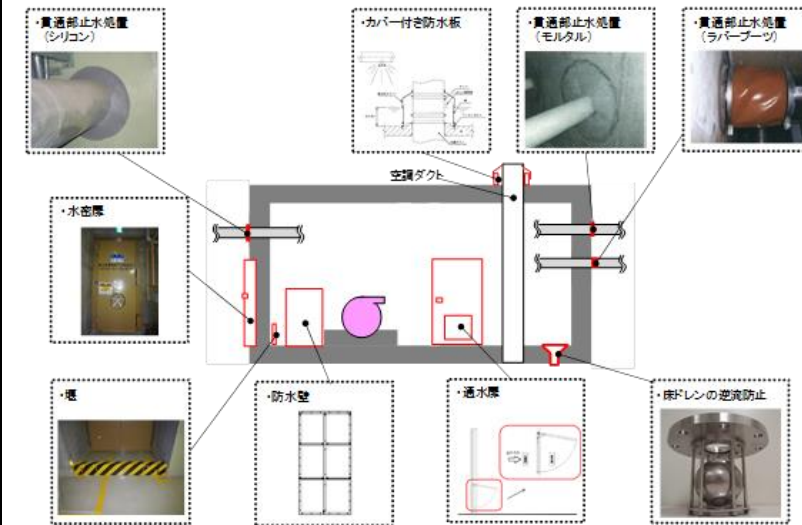
柏崎刈羽原子力発電所 6 / 7号炉 (2017.12.20版)	東海第二発電所 (2018.9.18版)	島根原子力発電所 2号炉	備考			
第1表 溢水防護対策上止水に期待する設備						
	原子炉 建屋 原子炉棟	設置建屋	階層(EL. m)	設備名	区分	箇所数
			46.5	堰	新設	1
				堰	改造	7
			38.8	堰	新設	3
				堰	改造	2
				堰	既設	5
			29.0	堰	新設	3
				堰	改造	1
				堰	既設	12
			20.3	堰	新設	4
				堰	改造	3
				堰	既設	2
			14.0	堰	新設	3
				堰	改造	1
				堰	既設	5
			8.2	堰	改造	4
				堰	既設	1
				水密扉	既設	3
			2.0	堰	新設	1
				堰	改造	5
	堰	既設		3		
	-4.0	堰	既設	13		
		水密扉	既設	4		
		逆流防止装置	既設	15		

柏崎刈羽原子力発電所 6 / 7号炉 (2017.12.20版)	東海第二発電所 (2018.9.18版)	島根原子力発電所 2号炉	備考																																																																																					
<p>4.2.1 溢水防護対策の概要及び止水性能</p> <p>溢水防護対策の概要及び止水性能を下記(1)～(7)に記す。</p>	<p>4.2.1 堰の設置高さおよび溢水経路の設定の関係について</p> <p>第4.2章にて示した、第4.2-4図 溢水伝播経路図(全体共通)においては、溢水防護の観点から溢水経路をコントロールする開口部、階段部の堰を示しており、これらは溢水拡大防止堰及び溢水拡大軽減堰に分類される。堰の高さを設定する際の考え方を第2表に示す。</p> <p style="text-align: center;">第2表 堰高さの設定の考え方</p> <table border="1" data-bbox="943 625 1703 890"> <thead> <tr> <th rowspan="2">設置箇所</th> <th colspan="2">堰の種類</th> <th rowspan="2">堰の高さ</th> <th rowspan="2">設定の考え方</th> <th colspan="2">溢水影響評価</th> </tr> <tr> <th></th> <th></th> <th>水位評価時の考慮</th> <th>溢水伝播時の考慮</th> </tr> </thead> <tbody> <tr> <td rowspan="2">開口部及び階段部</td> <td rowspan="2">溢水拡大防止堰</td> <td rowspan="2">溢水伝播を制限するための堰</td> <td>40cm</td> <td>想定破損による溢水水位に基づき設定(原子炉建屋6階)</td> <td>○</td> <td>○ (流下経路としない)</td> </tr> <tr> <td>30cm</td> <td>溢水拡大軽減堰の高さに床勾配及び揺らぎを考慮した値(20cm)を加え設定</td> <td>○</td> <td>○ (流下経路としない)</td> </tr> <tr> <td></td> <td>溢水拡大軽減堰(自主設備)</td> <td>溢水影響範囲を軽減させるための堰</td> <td>10cm</td> <td>アクセス性に影響しないよう滞留水位の最大値(20cm)より低い高さを設定</td> <td>○</td> <td>- (流下経路とする)</td> </tr> </tbody> </table> <p style="text-align: right; font-size: small;">○：堰があるものとして取扱う -：堰がないものとして取扱う</p>	設置箇所	堰の種類		堰の高さ	設定の考え方	溢水影響評価				水位評価時の考慮	溢水伝播時の考慮	開口部及び階段部	溢水拡大防止堰	溢水伝播を制限するための堰	40cm	想定破損による溢水水位に基づき設定(原子炉建屋6階)	○	○ (流下経路としない)	30cm	溢水拡大軽減堰の高さに床勾配及び揺らぎを考慮した値(20cm)を加え設定	○	○ (流下経路としない)		溢水拡大軽減堰(自主設備)	溢水影響範囲を軽減させるための堰	10cm	アクセス性に影響しないよう滞留水位の最大値(20cm)より低い高さを設定	○	- (流下経路とする)	<p>2.1 溢水防護対策の概要</p> <p>2.1.1 止水措置</p> <p>溢水防護対象設備を防護するため、止水設備を設置する。貫通部止水処置を除く溢水防護対象設備の設置箇所一覧を表2-1に示す。</p> <p style="text-align: center;">表2-1 止水設備設置箇所一覧(1/2)</p> <table border="1" data-bbox="1736 604 2499 1663"> <thead> <tr> <th>設置場所</th> <th>設置高さ(EL[m])</th> <th>対象</th> <th>箇所数</th> </tr> </thead> <tbody> <tr> <td rowspan="16">原子炉 建物</td> <td>42.8</td> <td>堰</td> <td>5</td> </tr> <tr> <td rowspan="2">34.8</td> <td>堰</td> <td>8</td> </tr> <tr> <td>防水壁</td> <td>1</td> </tr> <tr> <td>31.1</td> <td>堰</td> <td>1</td> </tr> <tr> <td>30.5</td> <td>堰</td> <td>3</td> </tr> <tr> <td rowspan="2">28.3</td> <td>堰</td> <td>2</td> </tr> <tr> <td>堰</td> <td>13</td> </tr> <tr> <td rowspan="2">15.3</td> <td>防水壁</td> <td>1</td> </tr> <tr> <td>堰</td> <td>7</td> </tr> <tr> <td>10.3</td> <td>堰</td> <td>3</td> </tr> <tr> <td rowspan="2">8.8</td> <td>水密扉</td> <td>5</td> </tr> <tr> <td>堰</td> <td>3</td> </tr> <tr> <td rowspan="3">2.8</td> <td>水密扉</td> <td>2</td> </tr> <tr> <td>堰</td> <td>1</td> </tr> <tr> <td>逆止弁</td> <td>5</td> </tr> <tr> <td rowspan="2">2.6</td> <td>水密扉</td> <td>3</td> </tr> <tr> <td>逆止弁</td> <td>2</td> </tr> <tr> <td rowspan="3">1.3</td> <td>水密扉</td> <td>7</td> </tr> <tr> <td>逆止弁</td> <td>15</td> </tr> <tr> <td>被水カバー</td> <td>2</td> </tr> </tbody> </table>	設置場所	設置高さ(EL[m])	対象	箇所数	原子炉 建物	42.8	堰	5	34.8	堰	8	防水壁	1	31.1	堰	1	30.5	堰	3	28.3	堰	2	堰	13	15.3	防水壁	1	堰	7	10.3	堰	3	8.8	水密扉	5	堰	3	2.8	水密扉	2	堰	1	逆止弁	5	2.6	水密扉	3	逆止弁	2	1.3	水密扉	7	逆止弁	15	被水カバー	2	<p>・設備及び仕様の相違【柏崎6/7, 東海第二】</p>
設置箇所	堰の種類		堰の高さ	設定の考え方			溢水影響評価																																																																																	
					水位評価時の考慮	溢水伝播時の考慮																																																																																		
開口部及び階段部	溢水拡大防止堰	溢水伝播を制限するための堰	40cm	想定破損による溢水水位に基づき設定(原子炉建屋6階)	○	○ (流下経路としない)																																																																																		
			30cm	溢水拡大軽減堰の高さに床勾配及び揺らぎを考慮した値(20cm)を加え設定	○	○ (流下経路としない)																																																																																		
	溢水拡大軽減堰(自主設備)	溢水影響範囲を軽減させるための堰	10cm	アクセス性に影響しないよう滞留水位の最大値(20cm)より低い高さを設定	○	- (流下経路とする)																																																																																		
設置場所	設置高さ(EL[m])	対象	箇所数																																																																																					
原子炉 建物	42.8	堰	5																																																																																					
	34.8	堰	8																																																																																					
		防水壁	1																																																																																					
	31.1	堰	1																																																																																					
	30.5	堰	3																																																																																					
	28.3	堰	2																																																																																					
		堰	13																																																																																					
	15.3	防水壁	1																																																																																					
		堰	7																																																																																					
	10.3	堰	3																																																																																					
	8.8	水密扉	5																																																																																					
		堰	3																																																																																					
	2.8	水密扉	2																																																																																					
		堰	1																																																																																					
		逆止弁	5																																																																																					
	2.6	水密扉	3																																																																																					
逆止弁		2																																																																																						
1.3	水密扉	7																																																																																						
	逆止弁	15																																																																																						
	被水カバー	2																																																																																						



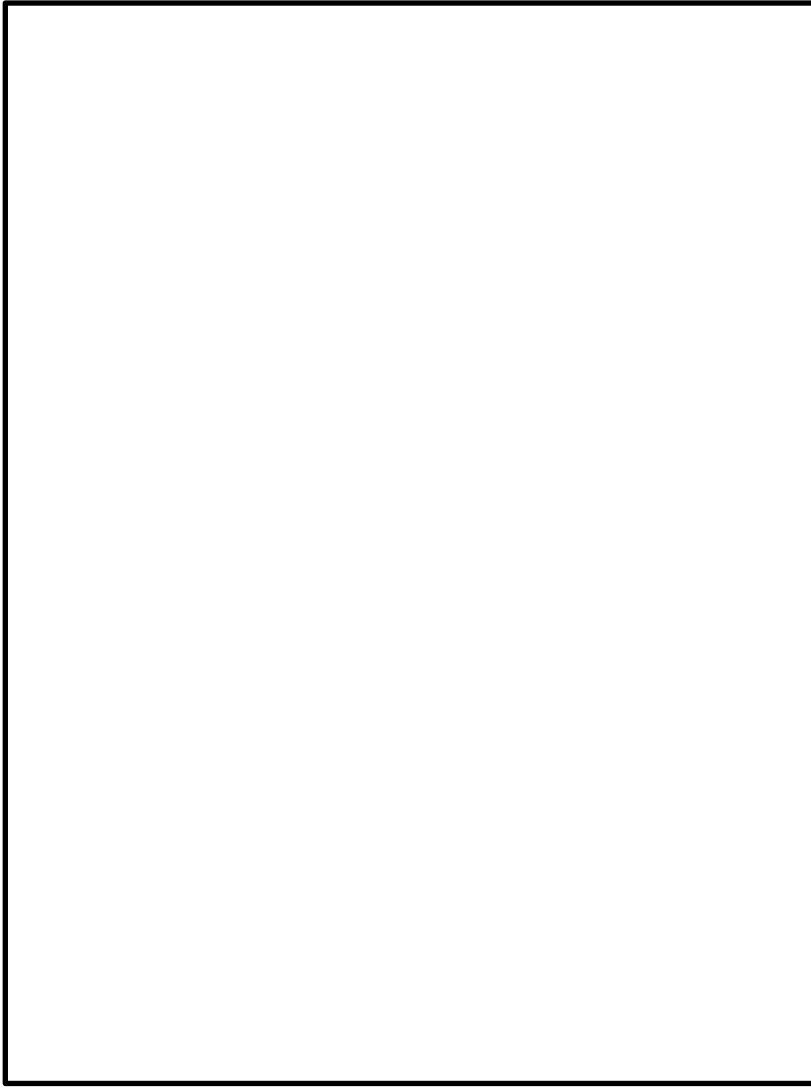
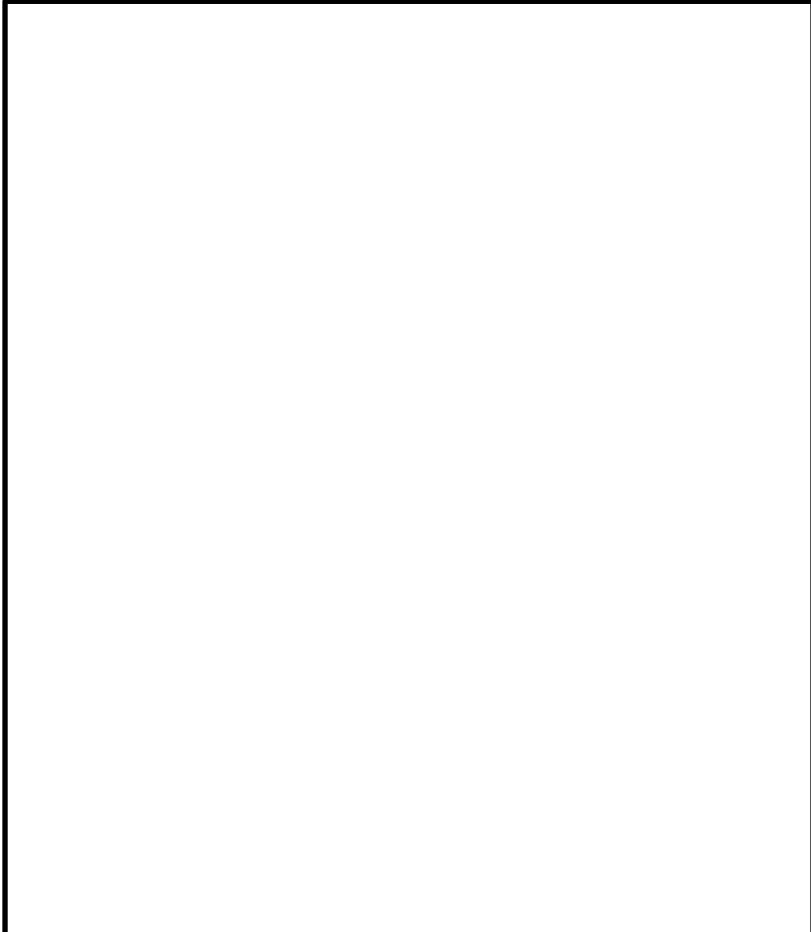

柏崎刈羽原子力発電所 6 / 7号炉 (2017.12.20版)	東海第二発電所 (2018.9.18版)	島根原子力発電所 2号炉	備考																																			
		<p style="text-align: center;">表 2-1 止水設備設置箇所一覧 (2/2)</p> <table border="1" data-bbox="1736 336 2502 888"> <thead> <tr> <th>設置場所</th> <th>設置高さ (EL[m])</th> <th>対象</th> <th>箇所数</th> </tr> </thead> <tbody> <tr> <td rowspan="5">廃棄物処理 建物</td> <td>25.3</td> <td>水密扉</td> <td>1</td> </tr> <tr> <td>22.1</td> <td>堰</td> <td>2</td> </tr> <tr> <td>16.9</td> <td>堰</td> <td>10</td> </tr> <tr> <td>12.5</td> <td>水密扉</td> <td>1</td> </tr> <tr> <td>8.8</td> <td>水密扉</td> <td>1</td> </tr> <tr> <td>制御室建物</td> <td>16.9</td> <td>堰</td> <td>4</td> </tr> <tr> <td rowspan="2">取水槽</td> <td>1.1</td> <td>水密扉</td> <td>3</td> </tr> <tr> <td>8.8</td> <td>防水壁</td> <td>1</td> </tr> <tr> <td>排気筒 エリア</td> <td>8.8</td> <td>堰</td> <td>1</td> </tr> </tbody> </table>	設置場所	設置高さ (EL[m])	対象	箇所数	廃棄物処理 建物	25.3	水密扉	1	22.1	堰	2	16.9	堰	10	12.5	水密扉	1	8.8	水密扉	1	制御室建物	16.9	堰	4	取水槽	1.1	水密扉	3	8.8	防水壁	1	排気筒 エリア	8.8	堰	1	
設置場所	設置高さ (EL[m])	対象	箇所数																																			
廃棄物処理 建物	25.3	水密扉	1																																			
	22.1	堰	2																																			
	16.9	堰	10																																			
	12.5	水密扉	1																																			
	8.8	水密扉	1																																			
制御室建物	16.9	堰	4																																			
取水槽	1.1	水密扉	3																																			
	8.8	防水壁	1																																			
排気筒 エリア	8.8	堰	1																																			

柏崎刈羽原子力発電所 6 / 7号炉 (2017. 12. 20 版)	東海第二発電所 (2018. 9. 18 版)	島根原子力発電所 2号炉	備考												
<p>①配管貫通部への止水処置</p> <p>①シーリング材</p> <table border="1" data-bbox="163 430 908 1318"> <tr> <td data-bbox="163 430 320 982">概要図</td> <td data-bbox="320 430 908 982">  </td> </tr> <tr> <td data-bbox="163 982 320 1024">主要寸法*</td> <td data-bbox="320 982 908 1024">口径：20A～850A</td> </tr> <tr> <td data-bbox="163 1024 320 1066">主要材料</td> <td data-bbox="320 1024 908 1066">シリコンシーリング材</td> </tr> <tr> <td data-bbox="163 1066 320 1136">箇所数*</td> <td data-bbox="320 1066 908 1136"> <ul style="list-style-type: none"> ・6号炉（共用建屋含む。）：約190箇所 ・7号炉：約240箇所 </td> </tr> <tr> <td data-bbox="163 1136 320 1178">最高使用温度</td> <td data-bbox="320 1136 908 1178">100℃</td> </tr> <tr> <td data-bbox="163 1178 320 1318">止水性能</td> <td data-bbox="320 1178 908 1318"> モックアップ試験により下記性能を確認 <ul style="list-style-type: none"> ・耐圧性：0.2～0.4MPa（静水圧20m～40m相当） ・止水性：24時間保持の耐圧試験で漏れ無し </td> </tr> </table> <p>※工事の進捗に応じて変動する可能性あり</p>	概要図		主要寸法*	口径：20A～850A	主要材料	シリコンシーリング材	箇所数*	<ul style="list-style-type: none"> ・6号炉（共用建屋含む。）：約190箇所 ・7号炉：約240箇所 	最高使用温度	100℃	止水性能	モックアップ試験により下記性能を確認 <ul style="list-style-type: none"> ・耐圧性：0.2～0.4MPa（静水圧20m～40m相当） ・止水性：24時間保持の耐圧試験で漏れ無し 	 <p data-bbox="1098 1323 1558 1365">第5図 既設設備(1) 逆流防止装置</p>	<p>2.1.1.1 止水設備の構造及び性能 止水設備の構造及び性能について、代表例を図2-2～11に示す。</p> <p>(1) 水密扉</p>  <p data-bbox="2018 1323 2211 1365">図2-2 水密扉</p>	備考
概要図															
主要寸法*	口径：20A～850A														
主要材料	シリコンシーリング材														
箇所数*	<ul style="list-style-type: none"> ・6号炉（共用建屋含む。）：約190箇所 ・7号炉：約240箇所 														
最高使用温度	100℃														
止水性能	モックアップ試験により下記性能を確認 <ul style="list-style-type: none"> ・耐圧性：0.2～0.4MPa（静水圧20m～40m相当） ・止水性：24時間保持の耐圧試験で漏れ無し 														

柏崎刈羽原子力発電所 6 / 7号炉 (2017. 12. 20 版)	東海第二発電所 (2018. 9. 18 版)	島根原子力発電所 2号炉	備考												
<p>②ラバーブーツ</p> <table border="1"> <tr> <td data-bbox="160 296 320 871">概要図</td> <td data-bbox="320 296 908 871"> <div style="border: 1px solid black; padding: 5px; text-align: center;"> <small>黒枠囲みの内容は機密事項に属しますので公開できません</small> </div> </td> </tr> <tr> <td data-bbox="160 871 320 947">主要寸法*</td> <td data-bbox="320 871 908 947">口径：25A～600A</td> </tr> <tr> <td data-bbox="160 947 320 993">主要材料</td> <td data-bbox="320 947 908 993">クロロプレングム</td> </tr> <tr> <td data-bbox="160 993 320 1083">箇所数*</td> <td data-bbox="320 993 908 1083"> <ul style="list-style-type: none"> ・ 6号炉（共用建屋含む。）：約 60箇所 ・ 7号炉：約 50箇所 </td> </tr> <tr> <td data-bbox="160 1083 320 1129">最高使用温度</td> <td data-bbox="320 1083 908 1129">100℃</td> </tr> <tr> <td data-bbox="160 1129 320 1281">止水性能</td> <td data-bbox="320 1129 908 1281"> モックアップ試験により下記性能を確認 <ul style="list-style-type: none"> ・ 耐圧性：0.4MPa（静水圧 40m 相当） ・ 止水性：24 時間保持の耐圧試験で漏えい無し </td> </tr> </table> <p>※工事の進捗に応じて変動する可能性あり</p>	概要図	<div style="border: 1px solid black; padding: 5px; text-align: center;"> <small>黒枠囲みの内容は機密事項に属しますので公開できません</small> </div>	主要寸法*	口径：25A～600A	主要材料	クロロプレングム	箇所数*	<ul style="list-style-type: none"> ・ 6号炉（共用建屋含む。）：約 60箇所 ・ 7号炉：約 50箇所 	最高使用温度	100℃	止水性能	モックアップ試験により下記性能を確認 <ul style="list-style-type: none"> ・ 耐圧性：0.4MPa（静水圧 40m 相当） ・ 止水性：24 時間保持の耐圧試験で漏えい無し 			
概要図	<div style="border: 1px solid black; padding: 5px; text-align: center;"> <small>黒枠囲みの内容は機密事項に属しますので公開できません</small> </div>														
主要寸法*	口径：25A～600A														
主要材料	クロロプレングム														
箇所数*	<ul style="list-style-type: none"> ・ 6号炉（共用建屋含む。）：約 60箇所 ・ 7号炉：約 50箇所 														
最高使用温度	100℃														
止水性能	モックアップ試験により下記性能を確認 <ul style="list-style-type: none"> ・ 耐圧性：0.4MPa（静水圧 40m 相当） ・ 止水性：24 時間保持の耐圧試験で漏えい無し 														
<p>第 5 図 既設設備（2） 水密扉 2</p>															

柏崎刈羽原子力発電所 6 / 7号炉 (2017.12.20版)	東海第二発電所 (2018.9.18版)	島根原子力発電所 2号炉	備考												
<p>③高温ラバーブーツ</p> <table border="1" data-bbox="160 317 908 1276"> <tr> <td data-bbox="160 317 320 909">概要図</td> <td data-bbox="320 317 908 909"> <div style="border: 1px solid black; padding: 5px; text-align: center;"> <small>黒枠囲みの内容は機密事項に属しますので公開できません</small> </div> </td> </tr> <tr> <td data-bbox="160 909 320 957">主要寸法*</td> <td data-bbox="320 909 908 957">口径：65A～300A</td> </tr> <tr> <td data-bbox="160 957 320 1005">主要材料</td> <td data-bbox="320 957 908 1005">シリコンラバー引布</td> </tr> <tr> <td data-bbox="160 1005 320 1081">箇所数*</td> <td data-bbox="320 1005 908 1081"> <ul style="list-style-type: none"> ・6号炉（共用建屋含む。）：6箇所 ・7号炉：3箇所 </td> </tr> <tr> <td data-bbox="160 1081 320 1129">最高使用温度</td> <td data-bbox="320 1081 908 1129">300℃</td> </tr> <tr> <td data-bbox="160 1129 320 1276">止水性能</td> <td data-bbox="320 1129 908 1276"> モックアップ試験により下記性能を確認 <ul style="list-style-type: none"> ・耐圧性：0.2MPa（静水圧20m相当） ・止水性：24時間保持の耐圧試験で漏えい無し </td> </tr> </table> <p>※ 工事の進捗に応じて変動する可能性あり</p>	概要図	<div style="border: 1px solid black; padding: 5px; text-align: center;"> <small>黒枠囲みの内容は機密事項に属しますので公開できません</small> </div>	主要寸法*	口径：65A～300A	主要材料	シリコンラバー引布	箇所数*	<ul style="list-style-type: none"> ・6号炉（共用建屋含む。）：6箇所 ・7号炉：3箇所 	最高使用温度	300℃	止水性能	モックアップ試験により下記性能を確認 <ul style="list-style-type: none"> ・耐圧性：0.2MPa（静水圧20m相当） ・止水性：24時間保持の耐圧試験で漏えい無し 	<div style="border: 2px solid black; width: 100%; height: 100%; margin: 0 auto;"></div> <p>第5図 既設設備（2） 水密扉3</p>		
概要図	<div style="border: 1px solid black; padding: 5px; text-align: center;"> <small>黒枠囲みの内容は機密事項に属しますので公開できません</small> </div>														
主要寸法*	口径：65A～300A														
主要材料	シリコンラバー引布														
箇所数*	<ul style="list-style-type: none"> ・6号炉（共用建屋含む。）：6箇所 ・7号炉：3箇所 														
最高使用温度	300℃														
止水性能	モックアップ試験により下記性能を確認 <ul style="list-style-type: none"> ・耐圧性：0.2MPa（静水圧20m相当） ・止水性：24時間保持の耐圧試験で漏えい無し 														

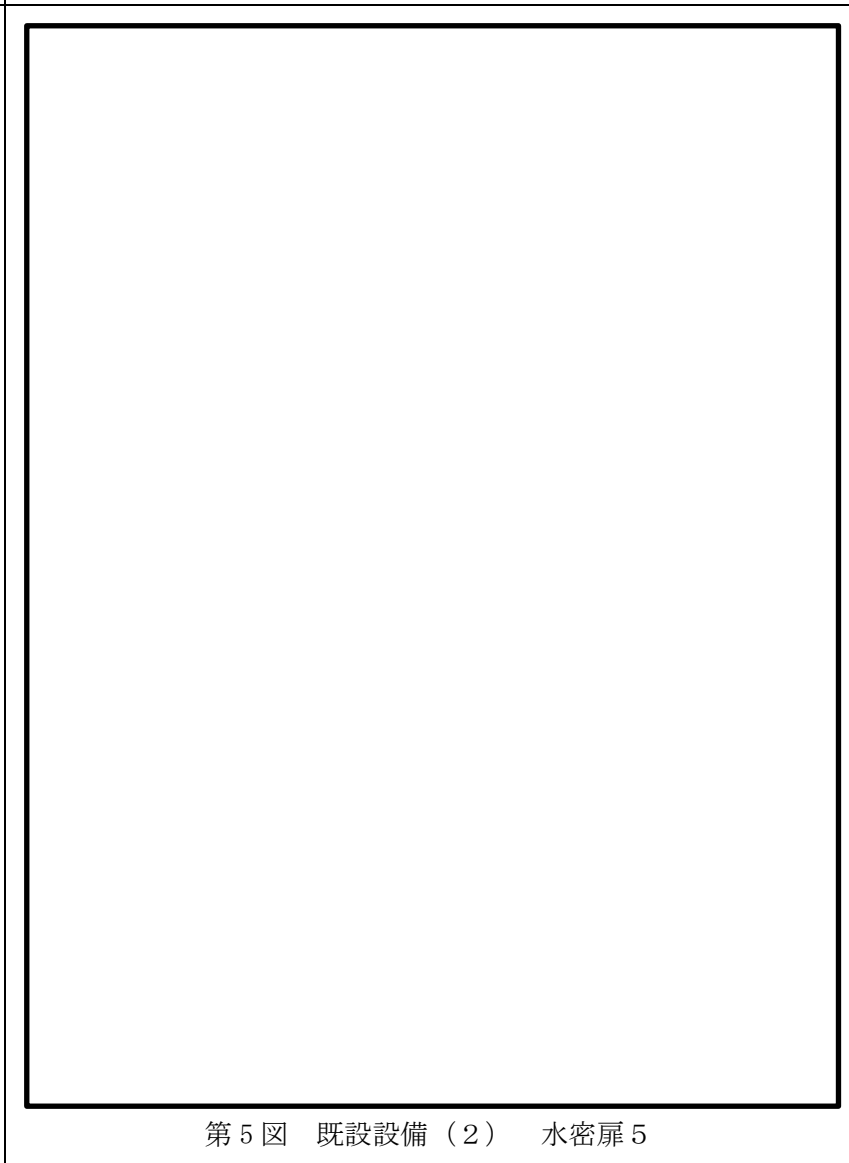

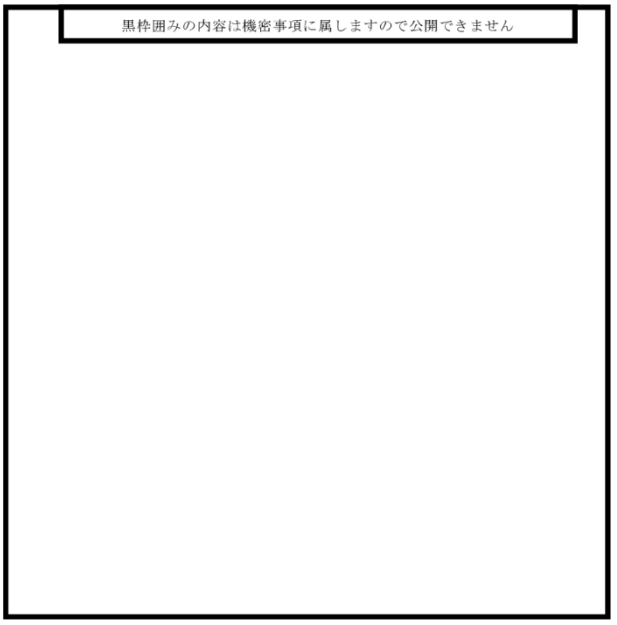
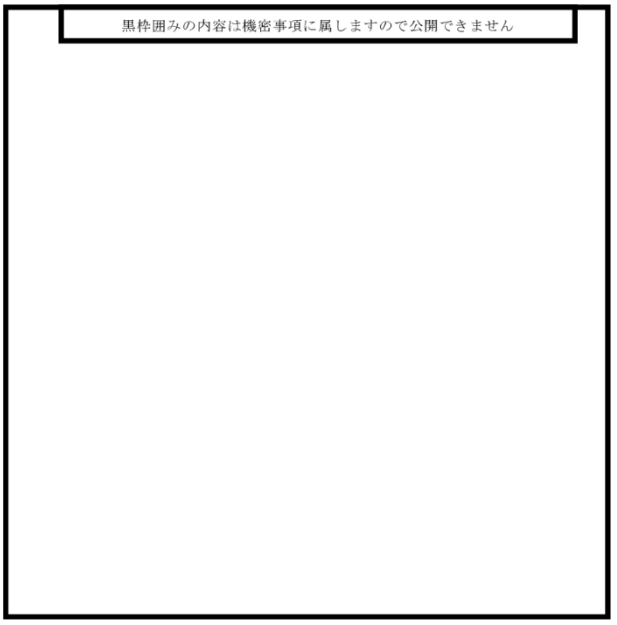
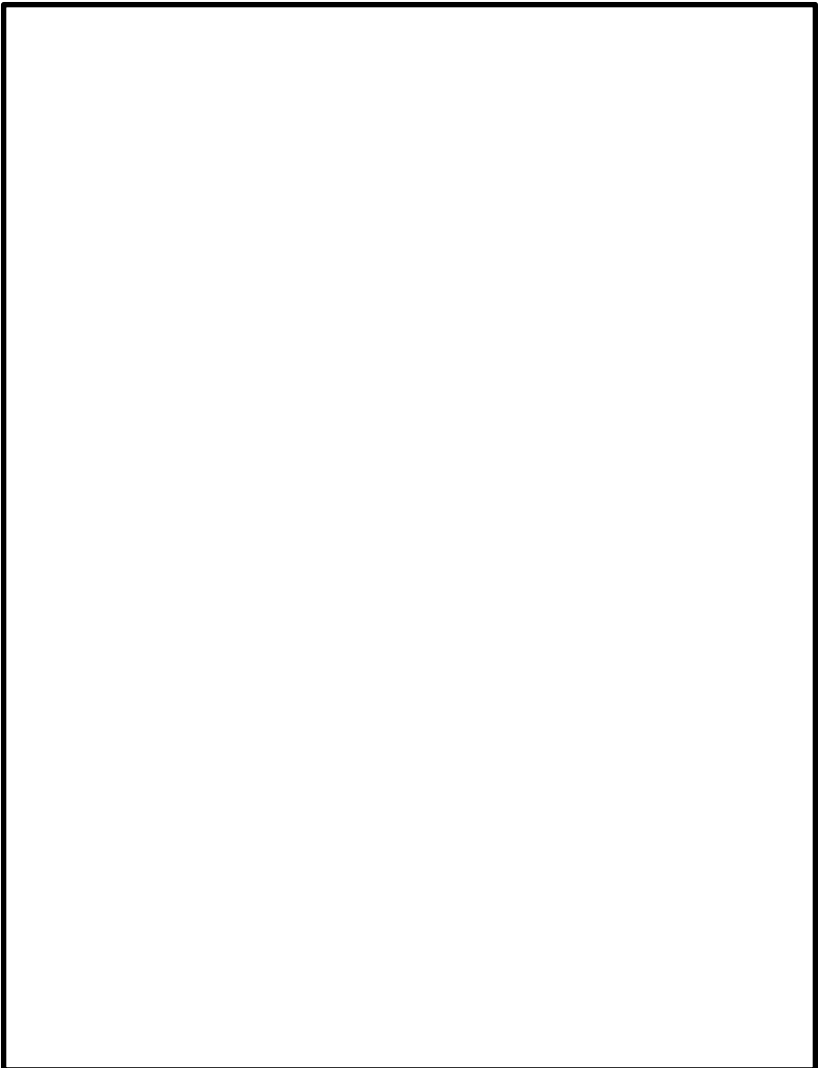
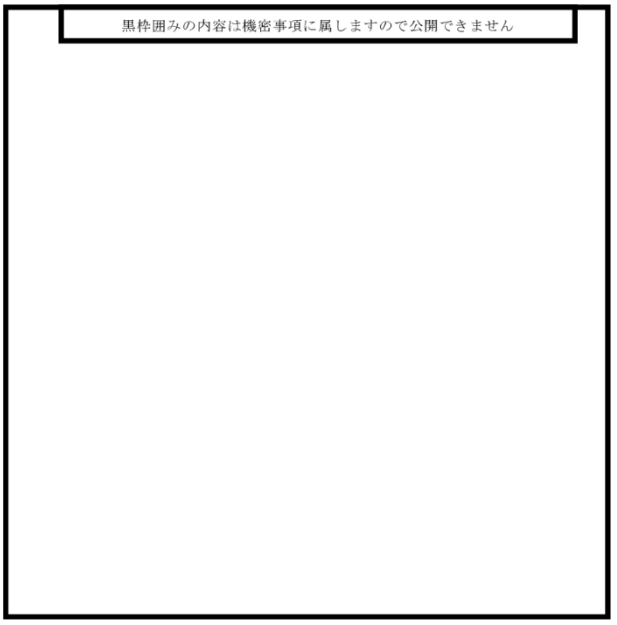

柏崎刈羽原子力発電所 6 / 7号炉 (2017.12.20版)	東海第二発電所 (2018.9.18版)	島根原子力発電所 2号炉	備考												
<p>④高温シール材</p> <table border="1" data-bbox="160 310 905 1304"> <tr> <td data-bbox="160 310 320 913">概要図</td> <td data-bbox="320 310 905 913"> <div data-bbox="371 321 866 352" style="border: 1px solid black; padding: 2px;">黒枠囲みの内容は機密事項に属しますので公開できません</div> </td> </tr> <tr> <td data-bbox="160 913 320 961">主要寸法*</td> <td data-bbox="320 913 905 961">口径：20A～550A</td> </tr> <tr> <td data-bbox="160 961 320 1024">主要材料</td> <td data-bbox="320 961 905 1024">耐熱シリコンシール材</td> </tr> <tr> <td data-bbox="160 1024 320 1102">箇所数*</td> <td data-bbox="320 1024 905 1102"> <ul style="list-style-type: none"> ・6号炉（共用建屋含む。）：1箇所 ・7号炉：約60箇所 </td> </tr> <tr> <td data-bbox="160 1102 320 1159">最高使用温度</td> <td data-bbox="320 1102 905 1159">250℃</td> </tr> <tr> <td data-bbox="160 1159 320 1304">止水性能</td> <td data-bbox="320 1159 905 1304"> モックアップ試験により下記性能を確認 <ul style="list-style-type: none"> ・耐圧性：0.4MPa（静水圧40m相当） ・止水性：24時間保持の耐圧試験で漏えい無し </td> </tr> </table>	概要図	<div data-bbox="371 321 866 352" style="border: 1px solid black; padding: 2px;">黒枠囲みの内容は機密事項に属しますので公開できません</div>	主要寸法*	口径：20A～550A	主要材料	耐熱シリコンシール材	箇所数*	<ul style="list-style-type: none"> ・6号炉（共用建屋含む。）：1箇所 ・7号炉：約60箇所 	最高使用温度	250℃	止水性能	モックアップ試験により下記性能を確認 <ul style="list-style-type: none"> ・耐圧性：0.4MPa（静水圧40m相当） ・止水性：24時間保持の耐圧試験で漏えい無し 	<div data-bbox="952 260 1709 1272" style="border: 2px solid black; width: 100%; height: 100%;"></div> <p>第5図 既設設備（2） 水密扉4</p>		
概要図	<div data-bbox="371 321 866 352" style="border: 1px solid black; padding: 2px;">黒枠囲みの内容は機密事項に属しますので公開できません</div>														
主要寸法*	口径：20A～550A														
主要材料	耐熱シリコンシール材														
箇所数*	<ul style="list-style-type: none"> ・6号炉（共用建屋含む。）：1箇所 ・7号炉：約60箇所 														
最高使用温度	250℃														
止水性能	モックアップ試験により下記性能を確認 <ul style="list-style-type: none"> ・耐圧性：0.4MPa（静水圧40m相当） ・止水性：24時間保持の耐圧試験で漏えい無し 														
<p>※ 工事の進捗に応じて変動する可能性あり</p>															

柏崎刈羽原子力発電所 6 / 7号炉 (2017. 12. 20 版)	東海第二発電所 (2018. 9. 18 版)	島根原子力発電所 2号炉	備考										
<p>(2) 電線管への止水処置</p> <p>①シール材</p> <table border="1" data-bbox="163 357 908 1327"> <tr> <td data-bbox="163 357 305 982">概要図</td> <td data-bbox="305 357 908 982">  </td> </tr> <tr> <td data-bbox="163 982 305 1045">主要寸法*</td> <td data-bbox="305 982 908 1045">口径：約 16mmΦ～約 104mmΦ</td> </tr> <tr> <td data-bbox="163 1045 305 1108">主要材料</td> <td data-bbox="305 1045 908 1108">シリコンシール材</td> </tr> <tr> <td data-bbox="163 1108 305 1203">箇所数*</td> <td data-bbox="305 1108 908 1203"> <ul style="list-style-type: none"> ・ 6号炉（共用建屋含む。）：約 570箇所 ・ 7号炉：約 330箇所 </td> </tr> <tr> <td data-bbox="163 1203 305 1327">止水性能</td> <td data-bbox="305 1203 908 1327"> モックアップ試験により下記性能を確認 耐圧性：0.25MPa（静水圧 25m 相当） 止水性：24 時間保持の耐圧試験で漏えい無し </td> </tr> </table>	概要図		主要寸法*	口径：約 16mmΦ～約 104mmΦ	主要材料	シリコンシール材	箇所数*	<ul style="list-style-type: none"> ・ 6号炉（共用建屋含む。）：約 570箇所 ・ 7号炉：約 330箇所 	止水性能	モックアップ試験により下記性能を確認 耐圧性：0.25MPa（静水圧 25m 相当） 止水性：24 時間保持の耐圧試験で漏えい無し			
概要図													
主要寸法*	口径：約 16mmΦ～約 104mmΦ												
主要材料	シリコンシール材												
箇所数*	<ul style="list-style-type: none"> ・ 6号炉（共用建屋含む。）：約 570箇所 ・ 7号炉：約 330箇所 												
止水性能	モックアップ試験により下記性能を確認 耐圧性：0.25MPa（静水圧 25m 相当） 止水性：24 時間保持の耐圧試験で漏えい無し												
<p>※工事の進捗に応じて変動する可能性あり</p>													
<p style="text-align: center;">第 5 図 既設設備（2） 水密扉 5</p>													

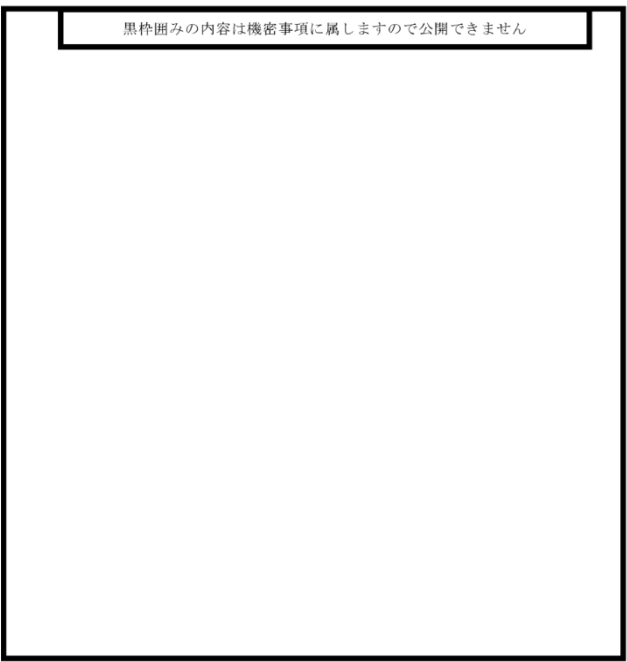
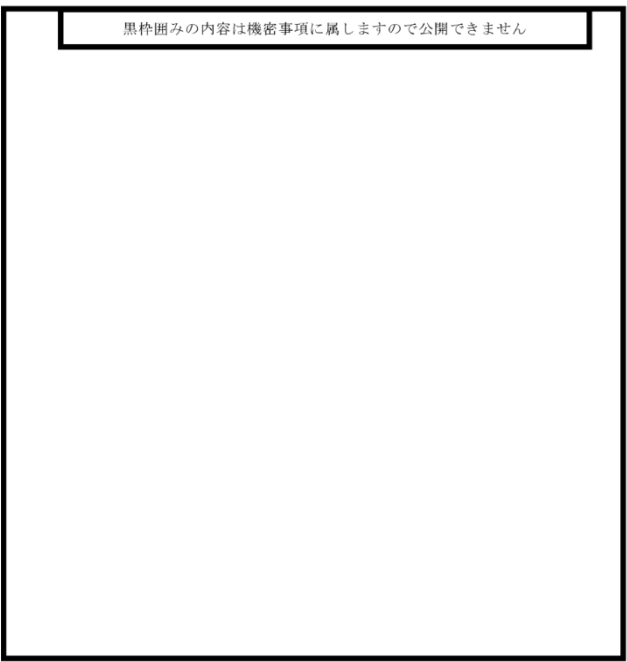
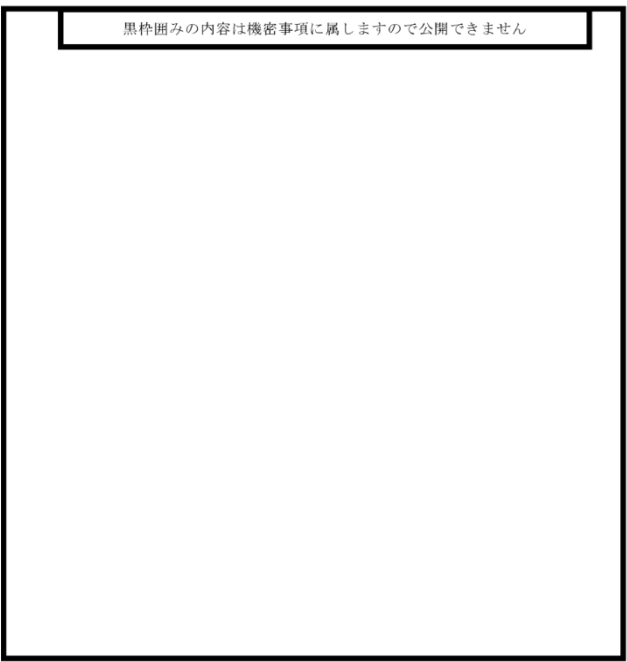

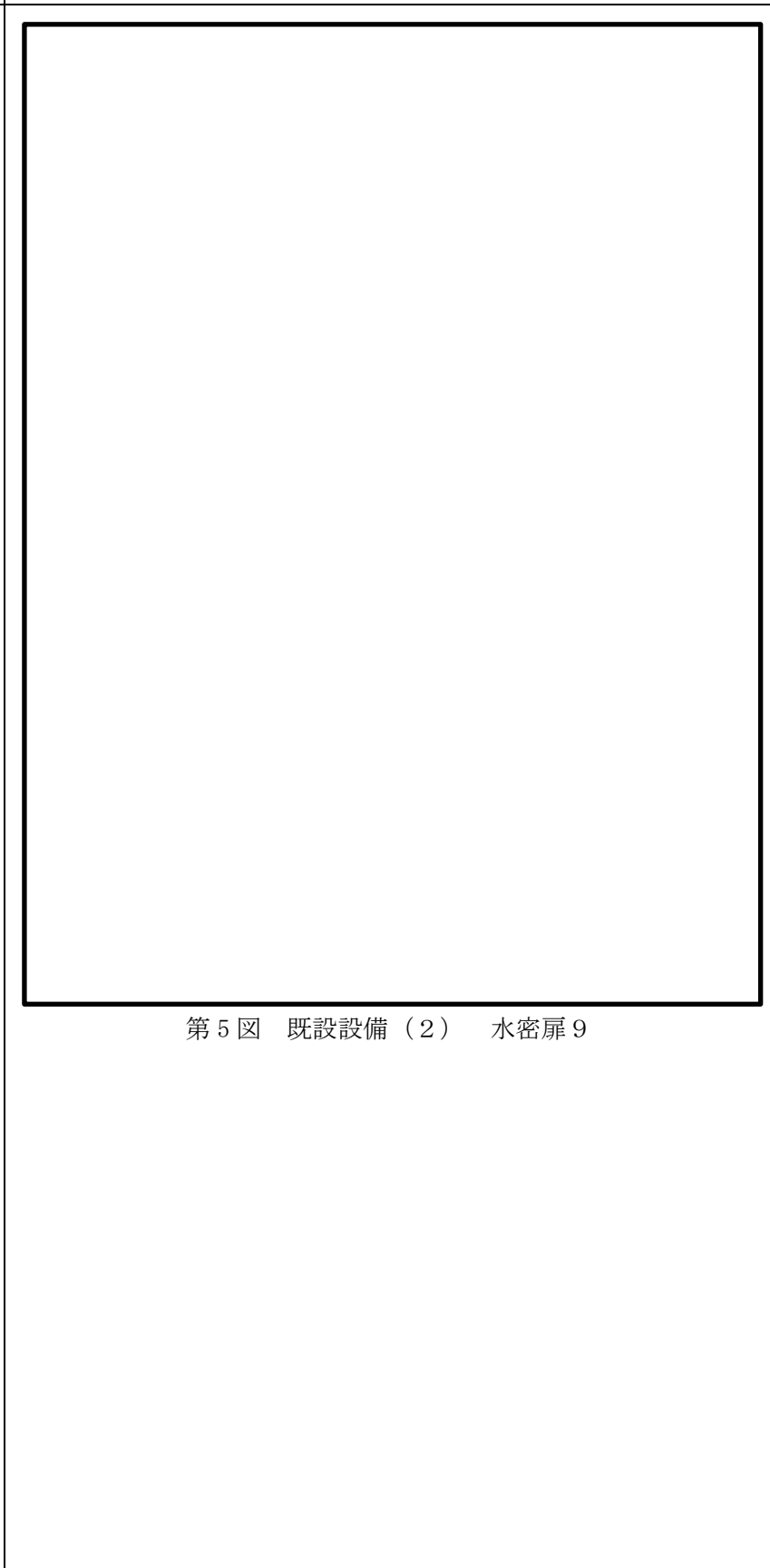

柏崎刈羽原子力発電所 6 / 7号炉 (2017.12.20版)	東海第二発電所 (2018.9.18版)	島根原子力発電所 2号炉	備考										
<p>(3) ケーブルトレイへの止水処置 ①シール材</p> <table border="1" data-bbox="160 348 914 1358"> <tr> <td data-bbox="160 348 302 949">概要図</td> <td data-bbox="302 348 914 949">  </td> </tr> <tr> <td data-bbox="160 949 302 1060">主要寸法*</td> <td data-bbox="302 949 914 1060"> (開口寸法) 幅：約0.5m～約2.5m 高さ：約0.3m～約1.9m </td> </tr> <tr> <td data-bbox="160 1060 302 1123">主要材料</td> <td data-bbox="302 1060 914 1123">シリコンシール材</td> </tr> <tr> <td data-bbox="160 1123 302 1215">箇所数*</td> <td data-bbox="302 1123 914 1215"> ・6号炉（共用建屋含む。）：約30箇所 ・7号炉：約20箇所 </td> </tr> <tr> <td data-bbox="160 1215 302 1358">止水性能</td> <td data-bbox="302 1215 914 1358"> モックアップ試験により下記性能を確認 耐圧性：0.25MPa（静水圧25m相当） 止水性：24時間保持の耐圧試験で漏えい量8cc/h以下 </td> </tr> </table> <p>※工事の進捗に応じて変動する可能性あり</p>	概要図		主要寸法*	(開口寸法) 幅：約0.5m～約2.5m 高さ：約0.3m～約1.9m	主要材料	シリコンシール材	箇所数*	・6号炉（共用建屋含む。）：約30箇所 ・7号炉：約20箇所	止水性能	モックアップ試験により下記性能を確認 耐圧性：0.25MPa（静水圧25m相当） 止水性：24時間保持の耐圧試験で漏えい量8cc/h以下	 <p style="text-align: center;">第5図 既設設備(2) 水密扉6</p>		
概要図													
主要寸法*	(開口寸法) 幅：約0.5m～約2.5m 高さ：約0.3m～約1.9m												
主要材料	シリコンシール材												
箇所数*	・6号炉（共用建屋含む。）：約30箇所 ・7号炉：約20箇所												
止水性能	モックアップ試験により下記性能を確認 耐圧性：0.25MPa（静水圧25m相当） 止水性：24時間保持の耐圧試験で漏えい量8cc/h以下												

柏崎刈羽原子力発電所 6 / 7号炉 (2017. 12. 20 版)	東海第二発電所 (2018. 9. 18 版)	島根原子力発電所 2号炉	備考										
<p>②鋼板</p> <table border="1"> <tr> <td data-bbox="160 310 296 903">概要図</td> <td data-bbox="296 310 884 903">  </td> </tr> <tr> <td data-bbox="160 903 296 1039">主要寸法*</td> <td data-bbox="296 903 884 1039"> (開口寸法) 幅：約 0.5m～約 2.1m 奥行き：約 0.2m～約 2.7m 高さ：約 0.3m～約 1.1m </td> </tr> <tr> <td data-bbox="160 1039 296 1102">主要材料</td> <td data-bbox="296 1039 884 1102">鋼材 (SS400) , シリコーンシール材</td> </tr> <tr> <td data-bbox="160 1102 296 1186">箇所数*</td> <td data-bbox="296 1102 884 1186"> <ul style="list-style-type: none"> ・ 6号炉 (共用建屋含む。) : 約 20箇所 ・ 7号炉 : 約 10箇所 </td> </tr> <tr> <td data-bbox="160 1186 296 1312">止水性能</td> <td data-bbox="296 1186 884 1312"> モックアップ試験により下記性能を確認 <ul style="list-style-type: none"> ・ 耐圧性 : 0.018MPa (静水圧 1.8m 相当) ・ 止水性 : 24時間保持の耐圧試験で漏えい無し </td> </tr> </table> <p>※工事の進捗に応じて変動する可能性あり</p>	概要図		主要寸法*	(開口寸法) 幅：約 0.5m～約 2.1m 奥行き：約 0.2m～約 2.7m 高さ：約 0.3m～約 1.1m	主要材料	鋼材 (SS400) , シリコーンシール材	箇所数*	<ul style="list-style-type: none"> ・ 6号炉 (共用建屋含む。) : 約 20箇所 ・ 7号炉 : 約 10箇所 	止水性能	モックアップ試験により下記性能を確認 <ul style="list-style-type: none"> ・ 耐圧性 : 0.018MPa (静水圧 1.8m 相当) ・ 止水性 : 24時間保持の耐圧試験で漏えい無し 			
概要図													
主要寸法*	(開口寸法) 幅：約 0.5m～約 2.1m 奥行き：約 0.2m～約 2.7m 高さ：約 0.3m～約 1.1m												
主要材料	鋼材 (SS400) , シリコーンシール材												
箇所数*	<ul style="list-style-type: none"> ・ 6号炉 (共用建屋含む。) : 約 20箇所 ・ 7号炉 : 約 10箇所 												
止水性能	モックアップ試験により下記性能を確認 <ul style="list-style-type: none"> ・ 耐圧性 : 0.018MPa (静水圧 1.8m 相当) ・ 止水性 : 24時間保持の耐圧試験で漏えい無し 												
		<p>第5図 既設設備 (2) 水密扉7</p>											

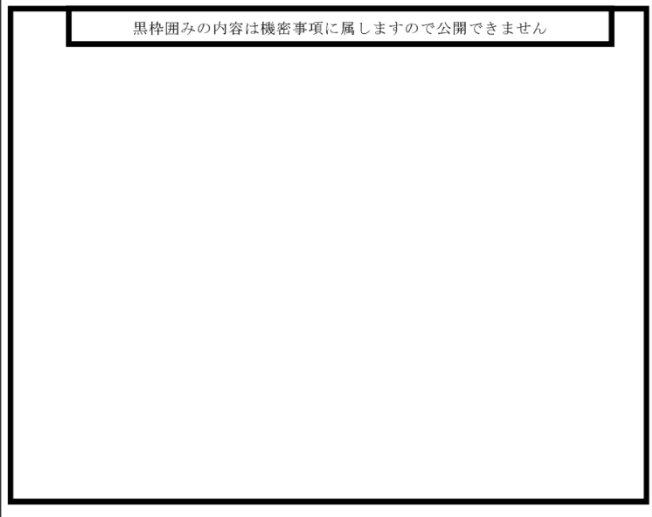
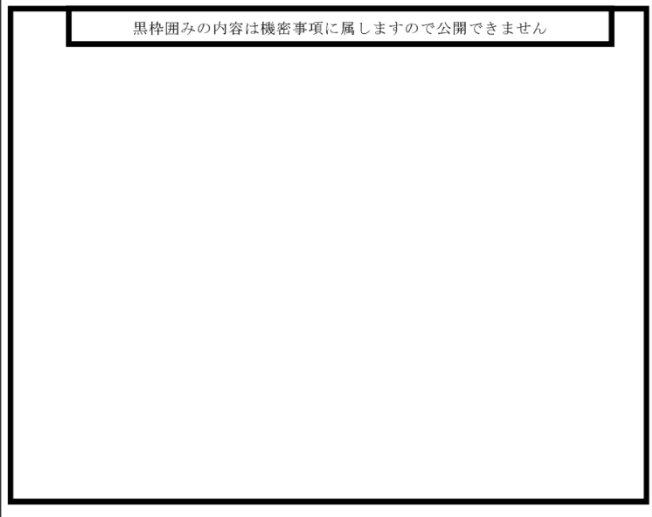
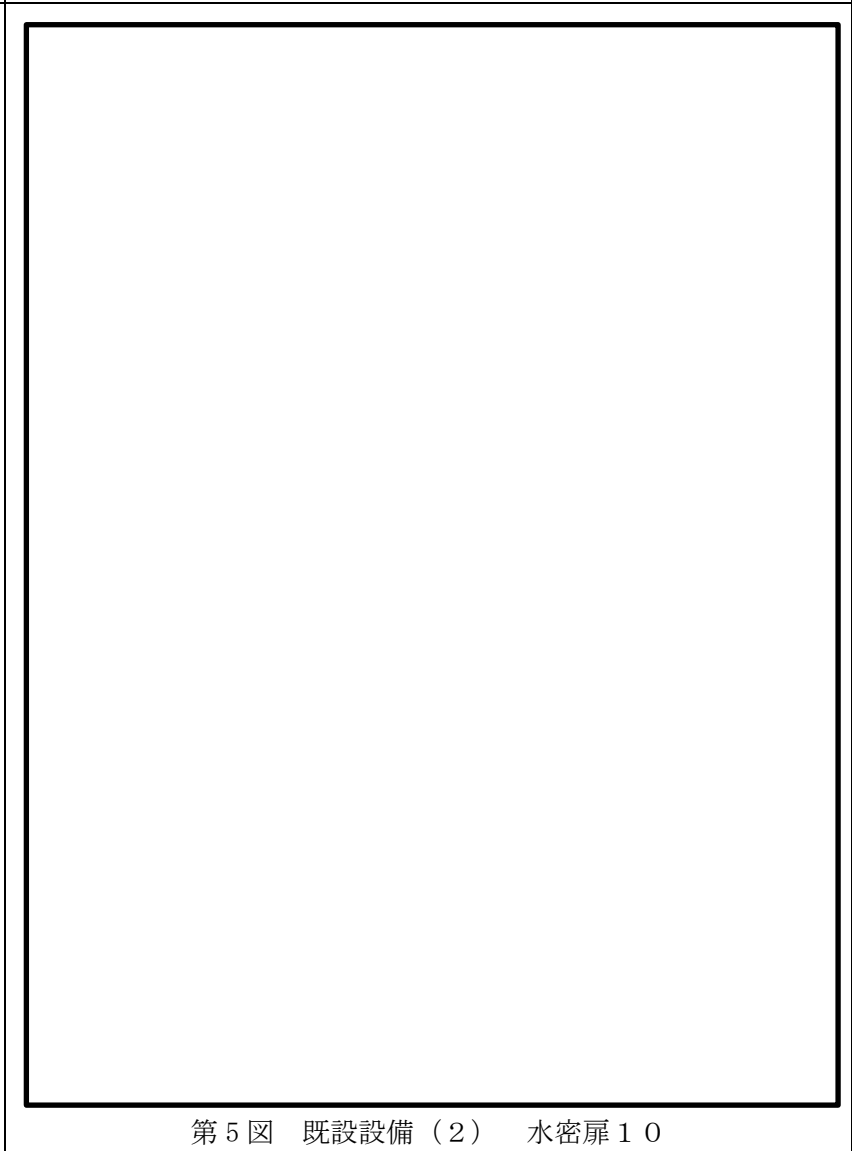
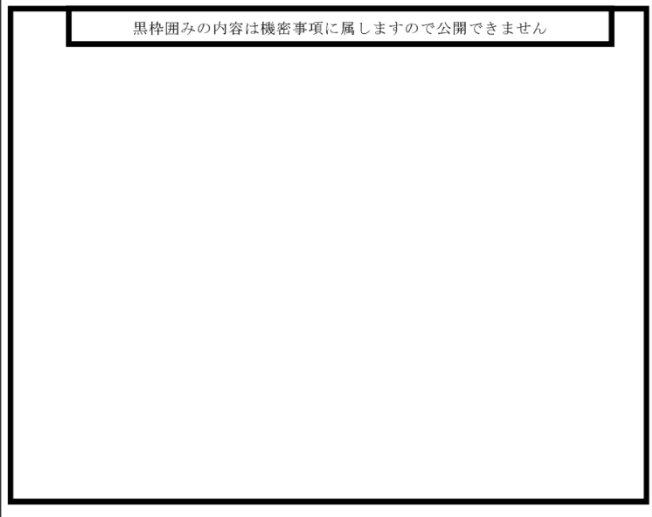

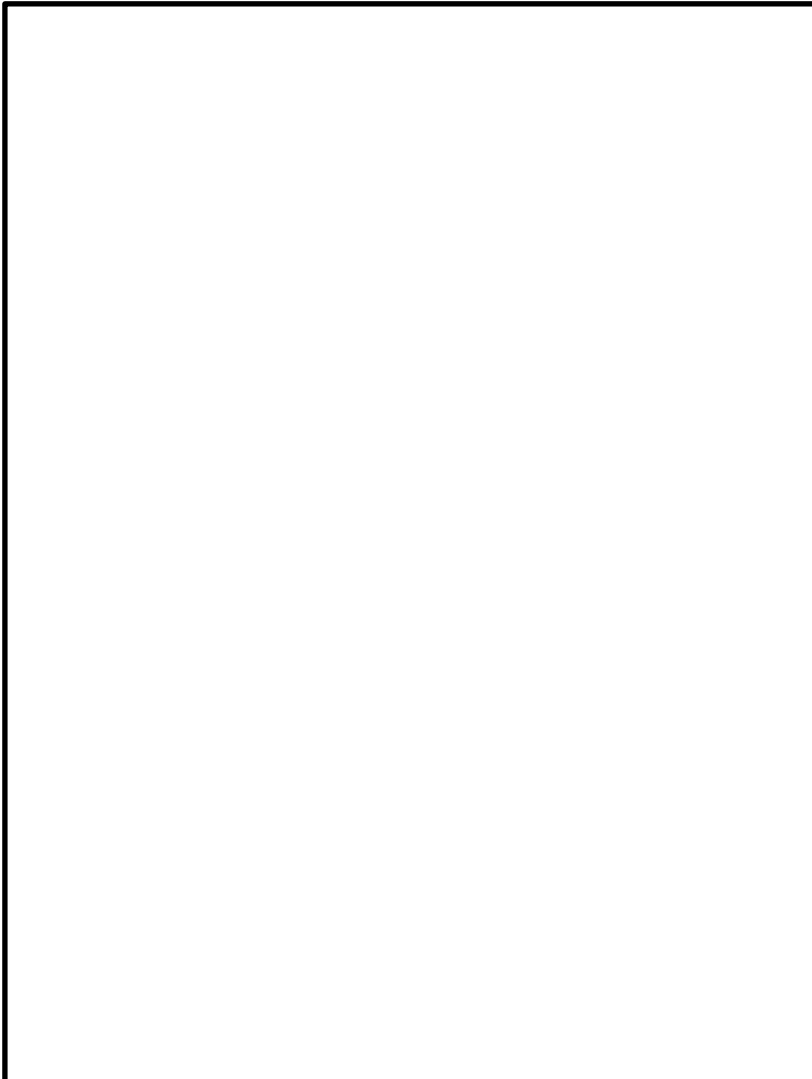

柏崎刈羽原子力発電所 6 / 7号炉 (2017. 12. 20 版)	東海第二発電所 (2018. 9. 18 版)	島根原子力発電所 2号炉	備考										
<p>(4) 空調ダクトへの止水処置</p> <p>①鋼板</p> <table border="1" data-bbox="157 348 908 1360"> <tr> <td data-bbox="157 348 311 974">概要図</td> <td data-bbox="311 348 908 974">  </td> </tr> <tr> <td data-bbox="157 974 311 1083">主要寸法*</td> <td data-bbox="311 974 908 1083">幅：約 0.2m～約 3.4m 奥行き：約 0.05m～約 4.0m 高さ：約 0.4m～約 1.7m</td> </tr> <tr> <td data-bbox="157 1083 311 1142">主要材料</td> <td data-bbox="311 1083 908 1142">鋼材 (SS400) , シリコンシーラ材</td> </tr> <tr> <td data-bbox="157 1142 311 1234">箇所数*</td> <td data-bbox="311 1142 908 1234">・ 6号炉 (共用建屋含む。) : 約 100箇所 ・ 7号炉 : 約 60箇所</td> </tr> <tr> <td data-bbox="157 1234 311 1360">止水性能</td> <td data-bbox="311 1234 908 1360">モックアップ試験により下記性能を確認 ・ 耐圧性 : 0.019MPa (静水圧 1.9m 相当) ・ 止水性 : 24時間保持の耐圧試験で漏えい無し</td> </tr> </table>	概要図		主要寸法*	幅：約 0.2m～約 3.4m 奥行き：約 0.05m～約 4.0m 高さ：約 0.4m～約 1.7m	主要材料	鋼材 (SS400) , シリコンシーラ材	箇所数*	・ 6号炉 (共用建屋含む。) : 約 100箇所 ・ 7号炉 : 約 60箇所	止水性能	モックアップ試験により下記性能を確認 ・ 耐圧性 : 0.019MPa (静水圧 1.9m 相当) ・ 止水性 : 24時間保持の耐圧試験で漏えい無し			
概要図													
主要寸法*	幅：約 0.2m～約 3.4m 奥行き：約 0.05m～約 4.0m 高さ：約 0.4m～約 1.7m												
主要材料	鋼材 (SS400) , シリコンシーラ材												
箇所数*	・ 6号炉 (共用建屋含む。) : 約 100箇所 ・ 7号炉 : 約 60箇所												
止水性能	モックアップ試験により下記性能を確認 ・ 耐圧性 : 0.019MPa (静水圧 1.9m 相当) ・ 止水性 : 24時間保持の耐圧試験で漏えい無し												
<p>※工事の進捗に応じて変動する可能性あり</p>	<p>第5図 既設設備 (2) 水密扉 8</p>												

柏崎刈羽原子力発電所 6 / 7号炉 (2017. 12. 20 版)	東海第二発電所 (2018. 9. 18 版)	島根原子力発電所 2号炉	備考										
<p>(5) ハッチへの止水処置 ①シール材</p> <table border="1" data-bbox="163 346 914 1375"> <tr> <td data-bbox="163 346 302 934">概要図</td> <td data-bbox="302 346 914 934">  </td> </tr> <tr> <td data-bbox="163 934 302 1039">主要寸法*</td> <td data-bbox="302 934 914 1039">(ハッチ開口部寸法) 幅：約 1.7m～約 5.2m 奥行き：約 4.2m～約 4.9m</td> </tr> <tr> <td data-bbox="163 1039 302 1102">主要材料</td> <td data-bbox="302 1039 914 1102">シリコンシール材</td> </tr> <tr> <td data-bbox="163 1102 302 1207">箇所数*</td> <td data-bbox="302 1102 914 1207"> <ul style="list-style-type: none"> ・6号炉（共用建屋含む。）：約 1箇所 ・7号炉：約 2箇所 </td> </tr> <tr> <td data-bbox="163 1207 302 1375">止水性能</td> <td data-bbox="302 1207 914 1375"> モックアップ試験により下記性能を確認 <ul style="list-style-type: none"> ・耐圧性：0.09MPa（静水圧 9m 相当） ・止水性：0.0m³/h・m² </td> </tr> </table> <p>※工事の進捗に応じて変動する可能性あり</p>	概要図		主要寸法*	(ハッチ開口部寸法) 幅：約 1.7m～約 5.2m 奥行き：約 4.2m～約 4.9m	主要材料	シリコンシール材	箇所数*	<ul style="list-style-type: none"> ・6号炉（共用建屋含む。）：約 1箇所 ・7号炉：約 2箇所 	止水性能	モックアップ試験により下記性能を確認 <ul style="list-style-type: none"> ・耐圧性：0.09MPa（静水圧 9m 相当） ・止水性：0.0m³/h・m² 	 <p>第5図 既設設備（2） 水密扉9</p>		
概要図													
主要寸法*	(ハッチ開口部寸法) 幅：約 1.7m～約 5.2m 奥行き：約 4.2m～約 4.9m												
主要材料	シリコンシール材												
箇所数*	<ul style="list-style-type: none"> ・6号炉（共用建屋含む。）：約 1箇所 ・7号炉：約 2箇所 												
止水性能	モックアップ試験により下記性能を確認 <ul style="list-style-type: none"> ・耐圧性：0.09MPa（静水圧 9m 相当） ・止水性：0.0m³/h・m² 												

柏崎刈羽原子力発電所 6 / 7号炉 (2017.12.20版)	東海第二発電所 (2018.9.18版)	島根原子力発電所 2号炉	備考										
<p>②鋼材・コンクリート</p> <table border="1"> <tr> <td data-bbox="160 302 302 785">概要図</td> <td data-bbox="302 302 911 785">  </td> </tr> <tr> <td data-bbox="160 785 302 928">主要寸法*</td> <td data-bbox="302 785 911 928"> (ハッチ開口部寸法) 幅：約 0.2m～約 10.0m 奥行き：約 0.3m～約 3.0m 堰高さ：約 0.3m～約 1.2m </td> </tr> <tr> <td data-bbox="160 928 302 1003">主要材料</td> <td data-bbox="302 928 911 1003"> 鋼材(SS400) 鉄筋コンクリート </td> </tr> <tr> <td data-bbox="160 1003 302 1079">箇所数*</td> <td data-bbox="302 1003 911 1079"> ・6号炉(共用建屋含む。)：4箇所 ・7号炉：5箇所 </td> </tr> <tr> <td data-bbox="160 1079 302 1318">止水性能</td> <td data-bbox="302 1079 911 1318"> 《鋼製堰》 モックアップ試験により下記性能を確認 ・耐圧性：0.004～0.005MPa(静水圧0.4～0.5m相当) ・止水性：耐圧試験にて漏えい無し 《鉄筋コンクリート堰》 ・浸水深(約0.2m～約0.4m)に対して止水性を担保 </td> </tr> </table> <p>※工事の進捗に応じて変動する可能性あり</p>	概要図		主要寸法*	(ハッチ開口部寸法) 幅：約 0.2m～約 10.0m 奥行き：約 0.3m～約 3.0m 堰高さ：約 0.3m～約 1.2m	主要材料	鋼材(SS400) 鉄筋コンクリート	箇所数*	・6号炉(共用建屋含む。)：4箇所 ・7号炉：5箇所	止水性能	《鋼製堰》 モックアップ試験により下記性能を確認 ・耐圧性：0.004～0.005MPa(静水圧0.4～0.5m相当) ・止水性：耐圧試験にて漏えい無し 《鉄筋コンクリート堰》 ・浸水深(約0.2m～約0.4m)に対して止水性を担保	 <p>第5図 既設設備(2) 水密扉10</p>		
概要図													
主要寸法*	(ハッチ開口部寸法) 幅：約 0.2m～約 10.0m 奥行き：約 0.3m～約 3.0m 堰高さ：約 0.3m～約 1.2m												
主要材料	鋼材(SS400) 鉄筋コンクリート												
箇所数*	・6号炉(共用建屋含む。)：4箇所 ・7号炉：5箇所												
止水性能	《鋼製堰》 モックアップ試験により下記性能を確認 ・耐圧性：0.004～0.005MPa(静水圧0.4～0.5m相当) ・止水性：耐圧試験にて漏えい無し 《鉄筋コンクリート堰》 ・浸水深(約0.2m～約0.4m)に対して止水性を担保												

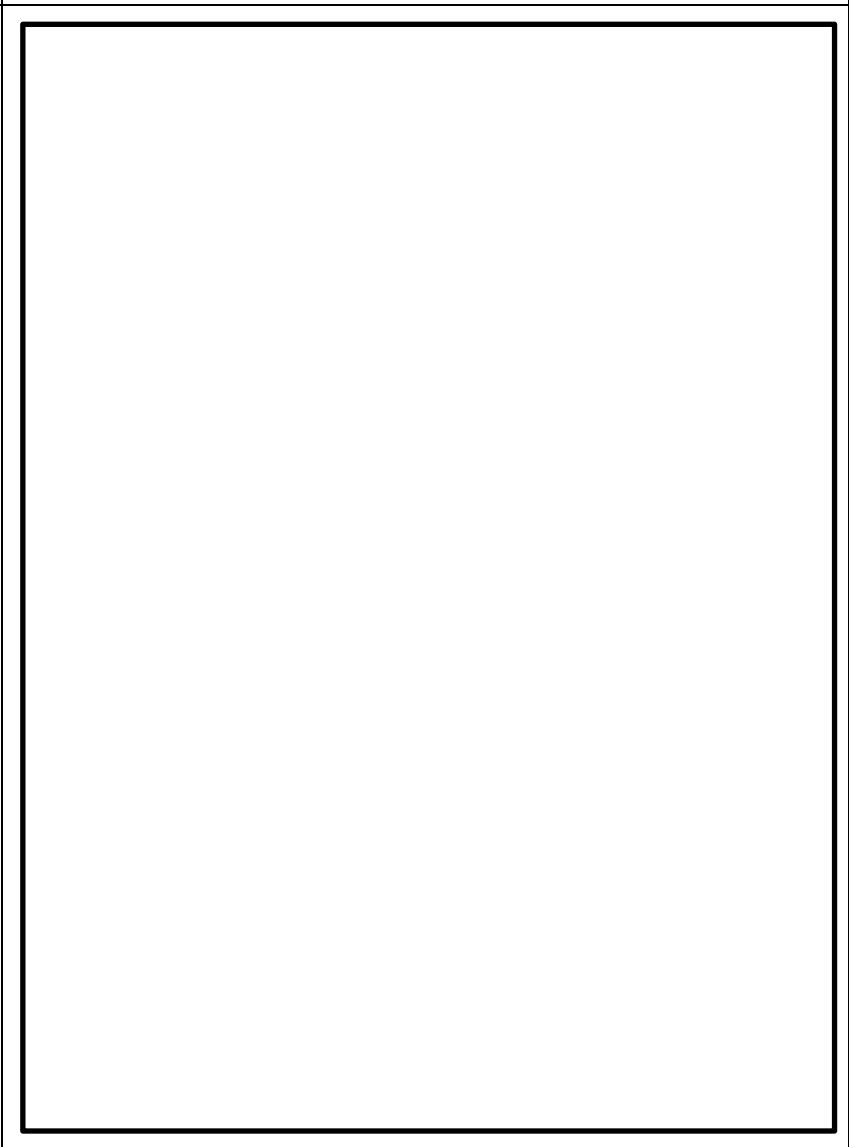

柏崎刈羽原子力発電所 6 / 7号炉 (2017. 12. 20 版)	東海第二発電所 (2018. 9. 18 版)	島根原子力発電所 2号炉	備考										
<p>(6)扉 ①水密扉</p> <table border="1" data-bbox="163 357 905 1312"> <tr> <td data-bbox="163 357 296 871">概要図</td> <td data-bbox="296 357 905 871">  </td> </tr> <tr> <td data-bbox="163 871 296 966">主要寸法*</td> <td data-bbox="296 871 905 966">幅：約 0.6m～約 5.5m 高さ：約 1.5m～約 5.6m</td> </tr> <tr> <td data-bbox="163 966 296 1060">主要材料</td> <td data-bbox="296 966 905 1060">鋼材 (SS400) , ネオプレンスポンジ</td> </tr> <tr> <td data-bbox="163 1060 296 1165">箇所数*</td> <td data-bbox="296 1060 905 1165">・ 6号炉 (共用建屋含む。) : 約 70箇所 ・ 7号炉 : 約 70箇所</td> </tr> <tr> <td data-bbox="163 1165 296 1312">止水性能</td> <td data-bbox="296 1165 905 1312">モックアップ試験により下記性能を確認 ・ 耐圧性 : 0.083～0.201MPa (静水圧 8.3～20.1m 相当) ・ 止水性 : 許容漏洩量 0.01～0.02m³/h・m²</td> </tr> </table> <p>※工事の進捗に応じて変動する可能性あり</p>	概要図		主要寸法*	幅：約 0.6m～約 5.5m 高さ：約 1.5m～約 5.6m	主要材料	鋼材 (SS400) , ネオプレンスポンジ	箇所数*	・ 6号炉 (共用建屋含む。) : 約 70箇所 ・ 7号炉 : 約 70箇所	止水性能	モックアップ試験により下記性能を確認 ・ 耐圧性 : 0.083～0.201MPa (静水圧 8.3～20.1m 相当) ・ 止水性 : 許容漏洩量 0.01～0.02m ³ /h・m ²	 <p>第 5 図 既設設備 (2) 水密扉 1 1</p>		
概要図													
主要寸法*	幅：約 0.6m～約 5.5m 高さ：約 1.5m～約 5.6m												
主要材料	鋼材 (SS400) , ネオプレンスポンジ												
箇所数*	・ 6号炉 (共用建屋含む。) : 約 70箇所 ・ 7号炉 : 約 70箇所												
止水性能	モックアップ試験により下記性能を確認 ・ 耐圧性 : 0.083～0.201MPa (静水圧 8.3～20.1m 相当) ・ 止水性 : 許容漏洩量 0.01～0.02m ³ /h・m ²												

柏崎刈羽原子力発電所 6 / 7号炉 (2017.12.20版)	東海第二発電所 (2018.9.18版)	島根原子力発電所 2号炉	備考										
<p>②鋼材・コンクリート</p> <table border="1"> <tr> <td data-bbox="163 304 302 892">概要図</td> <td data-bbox="302 304 908 892"> <div style="border: 2px solid black; padding: 5px; text-align: center;"> 黒枠囲みの内容は機密事項に属しますので公開できません </div> </td> </tr> <tr> <td data-bbox="163 892 302 955">主要寸法*</td> <td data-bbox="302 892 908 955">堰高さ：約 0.2m～約 1.5m</td> </tr> <tr> <td data-bbox="163 955 302 1018">主要材料</td> <td data-bbox="302 955 908 1018">鋼材 (SS400) , シリコーンシール材 鉄筋コンクリート</td> </tr> <tr> <td data-bbox="163 1018 302 1081">箇所数*</td> <td data-bbox="302 1018 908 1081">・ 6号炉 (共用建屋含む。) : 約 70箇所 ・ 7号炉 : 約 90箇所</td> </tr> <tr> <td data-bbox="163 1081 302 1312">止水性能</td> <td data-bbox="302 1081 908 1312"> 《鋼製堰》 モックアップ試験により下記性能を確認 ・ 耐圧性 : 0.006MPa (静水圧 0.6m 相当) 以下 ・ 止水性 : 耐圧試験にて漏えい無し 《鉄筋コンクリート堰》 ・ 浸水深 (約 1.0m 以下) に対して止水性を担保 </td> </tr> </table> <p>※工事の進捗に応じて変動する可能性あり</p>	概要図	<div style="border: 2px solid black; padding: 5px; text-align: center;"> 黒枠囲みの内容は機密事項に属しますので公開できません </div>	主要寸法*	堰高さ：約 0.2m～約 1.5m	主要材料	鋼材 (SS400) , シリコーンシール材 鉄筋コンクリート	箇所数*	・ 6号炉 (共用建屋含む。) : 約 70箇所 ・ 7号炉 : 約 90箇所	止水性能	《鋼製堰》 モックアップ試験により下記性能を確認 ・ 耐圧性 : 0.006MPa (静水圧 0.6m 相当) 以下 ・ 止水性 : 耐圧試験にて漏えい無し 《鉄筋コンクリート堰》 ・ 浸水深 (約 1.0m 以下) に対して止水性を担保	<div style="border: 2px solid black; height: 400px; width: 100%;"></div> <p style="text-align: center;">第 5 図 既設設備 (2) 水密扉 1 2</p>		
概要図	<div style="border: 2px solid black; padding: 5px; text-align: center;"> 黒枠囲みの内容は機密事項に属しますので公開できません </div>												
主要寸法*	堰高さ：約 0.2m～約 1.5m												
主要材料	鋼材 (SS400) , シリコーンシール材 鉄筋コンクリート												
箇所数*	・ 6号炉 (共用建屋含む。) : 約 70箇所 ・ 7号炉 : 約 90箇所												
止水性能	《鋼製堰》 モックアップ試験により下記性能を確認 ・ 耐圧性 : 0.006MPa (静水圧 0.6m 相当) 以下 ・ 止水性 : 耐圧試験にて漏えい無し 《鉄筋コンクリート堰》 ・ 浸水深 (約 1.0m 以下) に対して止水性を担保												

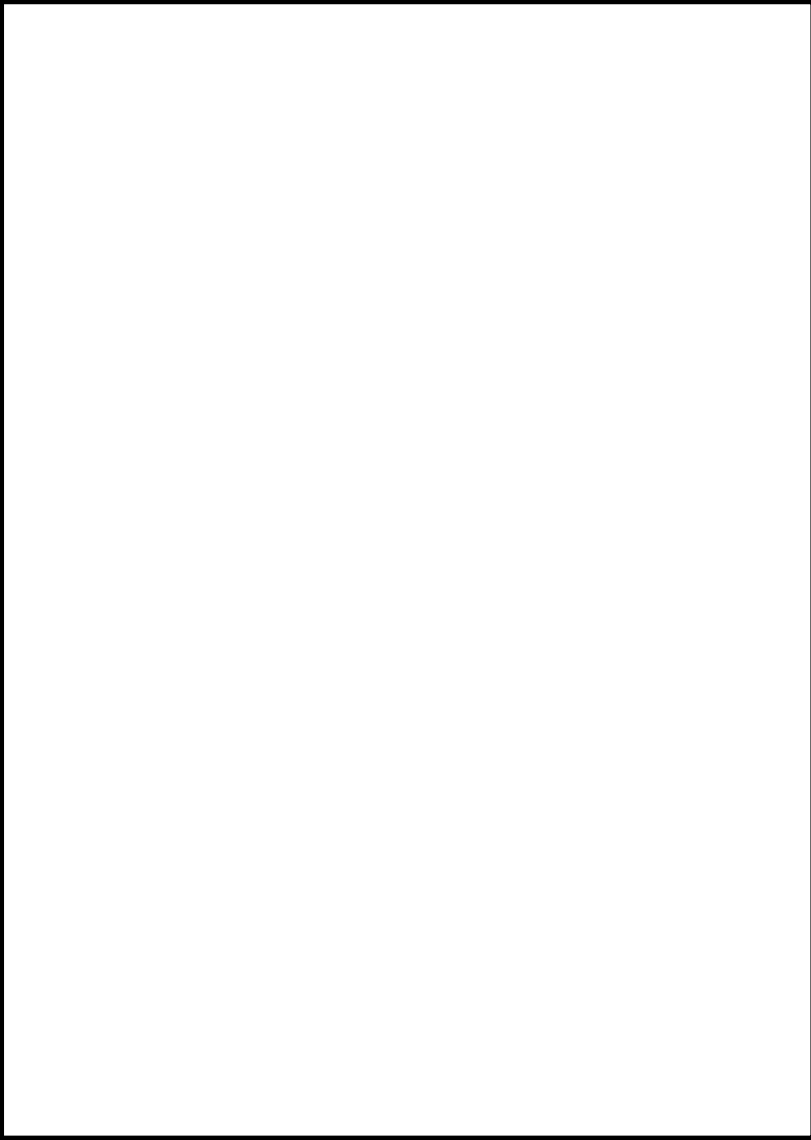
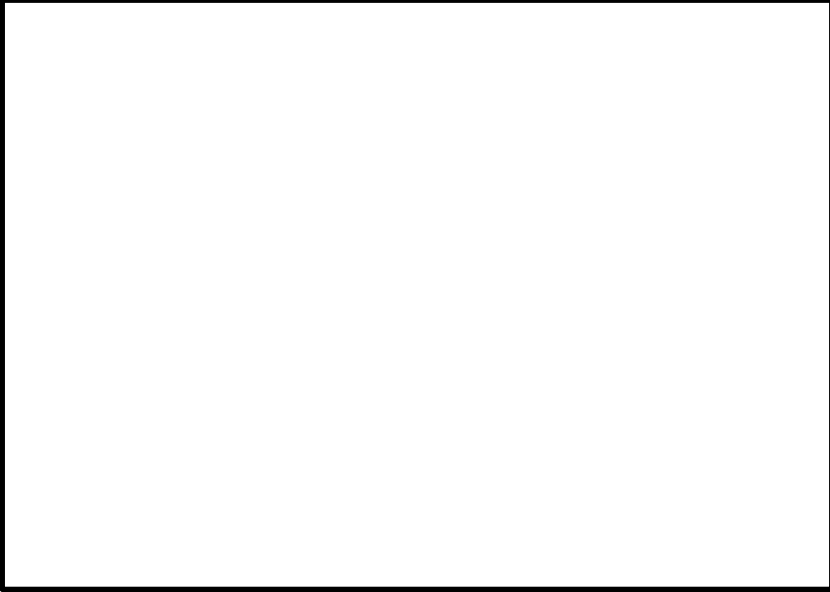
柏崎刈羽原子力発電所 6 / 7号炉 (2017. 12. 20 版)	東海第二発電所 (2018. 9. 18 版)	島根原子力発電所 2号炉	備考										
<p>(7) 床ドレン</p> <table border="1" data-bbox="163 310 911 1306"> <tr> <td data-bbox="163 310 305 898">概要図</td> <td data-bbox="305 310 911 898">  </td> </tr> <tr> <td data-bbox="163 898 305 961">主要寸法*</td> <td data-bbox="305 898 911 961">口径：80A</td> </tr> <tr> <td data-bbox="163 961 305 1056">主要材料</td> <td data-bbox="305 961 911 1056">鋼材 (SUS303, SUS304, SUS316L) フッ素ゴム</td> </tr> <tr> <td data-bbox="163 1056 305 1150">箇所数*</td> <td data-bbox="305 1056 911 1150"> <ul style="list-style-type: none"> ・ 6号炉 (共用建屋含む。) : 約 380 箇所 ・ 7号炉 : 約 210 箇所 </td> </tr> <tr> <td data-bbox="163 1150 305 1306">止水性能</td> <td data-bbox="305 1150 911 1306"> モックアップ試験により下記性能を確認 <ul style="list-style-type: none"> ・ 耐圧性 : 0.3MPa (静水圧 30m 相当) ・ 止水性 : 1 分間保持の耐圧試験にて漏えい無し </td> </tr> </table> <p data-bbox="163 1312 578 1339">※工事の進捗に応じて変動する可能性あり</p>	概要図		主要寸法*	口径：80A	主要材料	鋼材 (SUS303, SUS304, SUS316L) フッ素ゴム	箇所数*	<ul style="list-style-type: none"> ・ 6号炉 (共用建屋含む。) : 約 380 箇所 ・ 7号炉 : 約 210 箇所 	止水性能	モックアップ試験により下記性能を確認 <ul style="list-style-type: none"> ・ 耐圧性 : 0.3MPa (静水圧 30m 相当) ・ 止水性 : 1 分間保持の耐圧試験にて漏えい無し 			
概要図													
主要寸法*	口径：80A												
主要材料	鋼材 (SUS303, SUS304, SUS316L) フッ素ゴム												
箇所数*	<ul style="list-style-type: none"> ・ 6号炉 (共用建屋含む。) : 約 380 箇所 ・ 7号炉 : 約 210 箇所 												
止水性能	モックアップ試験により下記性能を確認 <ul style="list-style-type: none"> ・ 耐圧性 : 0.3MPa (静水圧 30m 相当) ・ 止水性 : 1 分間保持の耐圧試験にて漏えい無し 												
<p data-bbox="1098 1333 1558 1365">第 5 図 既設設備 (2) 水密扉 1 3</p>													

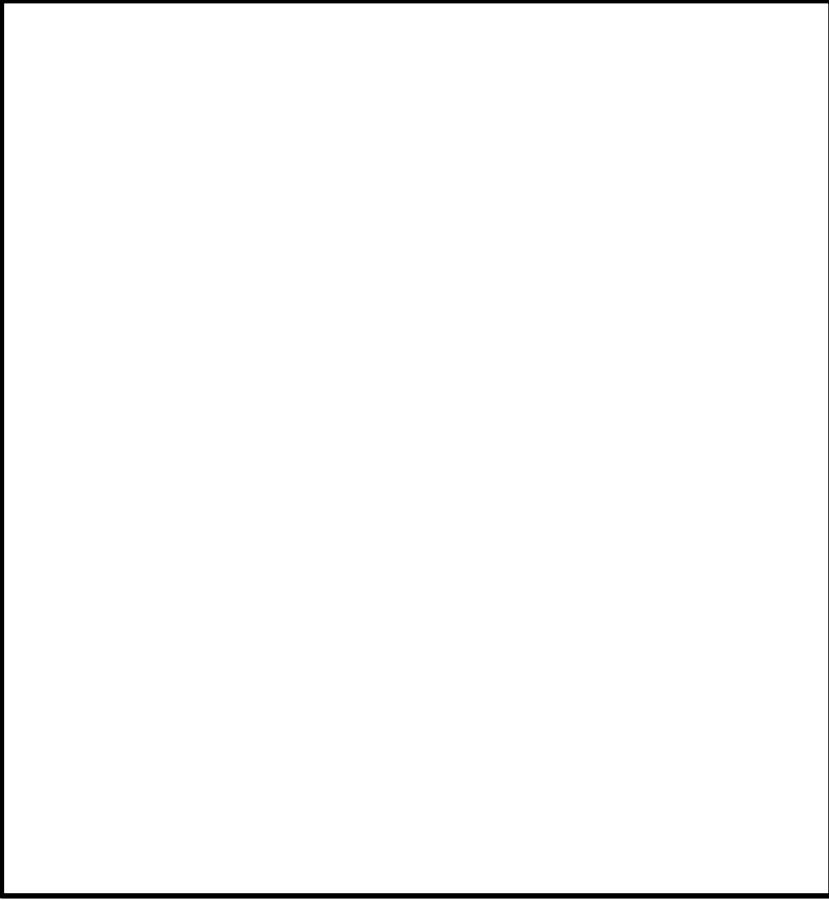
柏崎刈羽原子力発電所 6 / 7号炉 (2017.12.20版)	東海第二発電所 (2018.9.18版)	島根原子力発電所 2号炉	備考
	 <p data-bbox="1151 1373 1501 1409">第5図 既設設備(3) 堰</p>	<p data-bbox="1739 300 1816 331">(2) 堰</p>  <p data-bbox="2053 926 2184 957">図 2-3 堰</p>	

柏崎刈羽原子力発電所 6 / 7号炉 (2017.12.20版)	東海第二発電所 (2018.9.18版)	島根原子力発電所 2号炉	備考
		<p>(3) 防水壁</p>  <p>図 2-4 防水壁</p>	<p>・設備の相違 【柏崎 6/7, 東海第二】</p>

柏崎刈羽原子力発電所 6 / 7号炉 (2017.12.20版)	東海第二発電所 (2018.9.18版)	島根原子力発電所 2号炉	備考				
		<p>(4) 逆止弁</p> <table border="1" data-bbox="1736 346 2499 378"> <thead> <tr> <th data-bbox="1736 346 1935 378">種類</th> <th data-bbox="1935 346 2499 378">フロート式* 配管フランジタイプ</th> </tr> </thead> <tbody> <tr> <td colspan="2" data-bbox="1736 378 2499 1197" style="text-align: center;">  </td> </tr> </tbody> </table> <p style="text-align: center;">図 2-5 逆止弁</p>	種類	フロート式* 配管フランジタイプ			
種類	フロート式* 配管フランジタイプ						
							

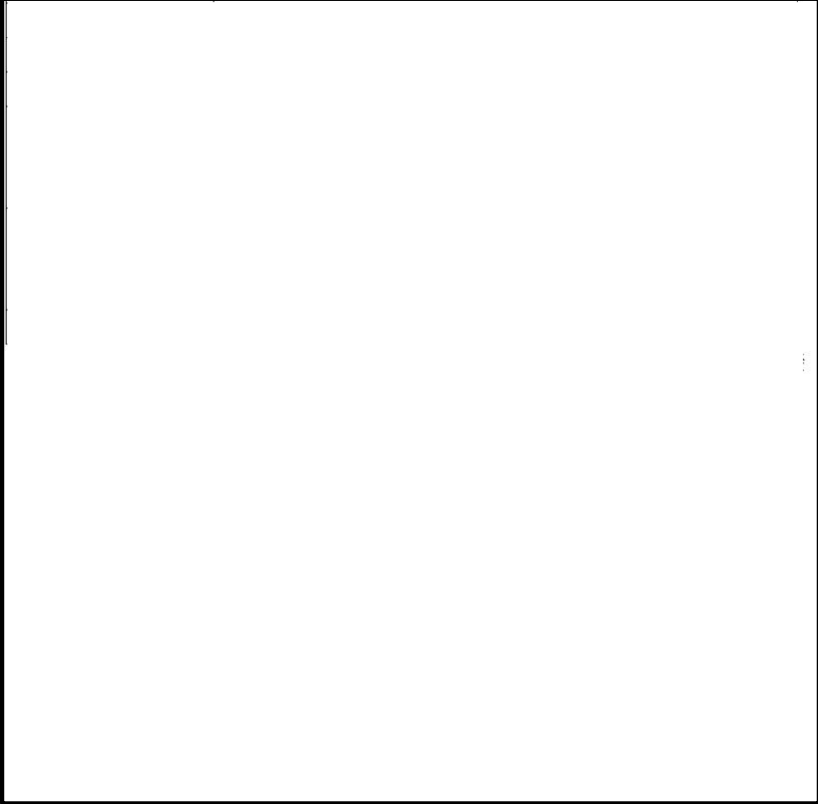
柏崎刈羽原子力発電所 6 / 7号炉 (2017.12.20版)	東海第二発電所 (2018.9.18版)	島根原子力発電所 2号炉	備考		
		<p>(5) 逆止弁</p> <table border="1" data-bbox="1736 346 2499 378"> <tr> <td data-bbox="1736 346 1929 378">種類</td> <td data-bbox="1929 346 2499 378">フロート式* 目皿タイプ</td> </tr> </table>  <p data-bbox="2018 1144 2211 1186">図 2-6 逆止弁</p>	種類	フロート式* 目皿タイプ	
種類	フロート式* 目皿タイプ				

柏崎刈羽原子力発電所 6 / 7号炉 (2017.12.20版)	東海第二発電所 (2018.9.18版)	島根原子力発電所 2号炉	備考		
		<p>(6) 貫通部止水処置</p> <table border="1" data-bbox="1736 336 2478 367"> <tr> <td data-bbox="1736 336 1944 367">種類</td> <td data-bbox="1944 336 2478 367">シリコン</td> </tr> </table>  <p>図 2-7 貫通部止水処置 (シリコン)</p>	種類	シリコン	
種類	シリコン				

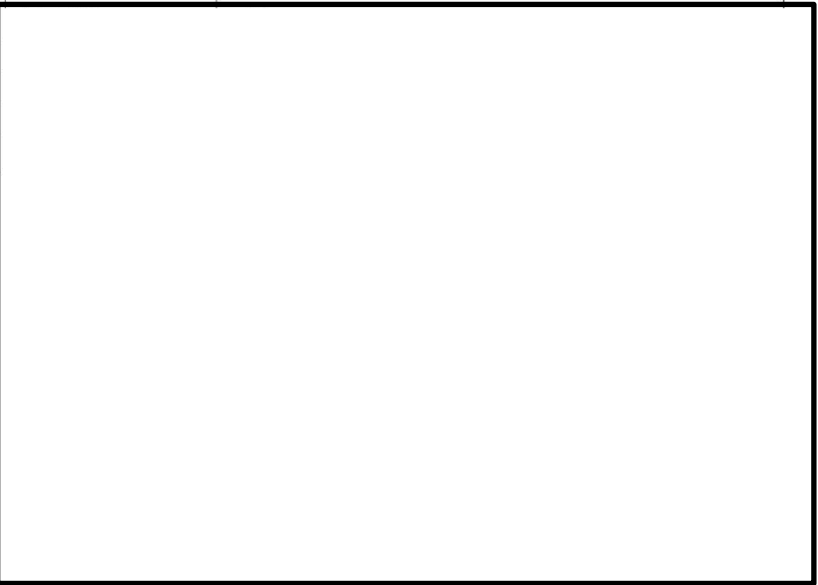
柏崎刈羽原子力発電所 6 / 7号炉 (2017.12.20版)	東海第二発電所 (2018.9.18版)	島根原子力発電所 2号炉	備考		
		<p>(7) 貫通部止水処置</p> <table border="1" data-bbox="1739 342 2472 369"> <tr> <td data-bbox="1739 342 1938 369">種類</td> <td data-bbox="1938 342 2472 369">ラバーブーツ</td> </tr> </table>  <p>図 2-8 貫通部止水処置 (ラバーブーツ)</p>	種類	ラバーブーツ	
種類	ラバーブーツ				

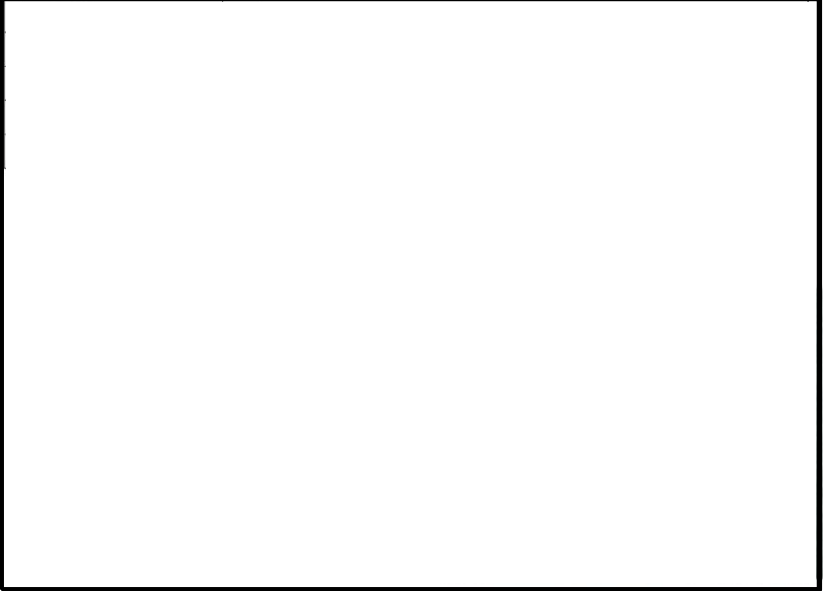
柏崎刈羽原子力発電所 6 / 7号炉 (2017.12.20版)	東海第二発電所 (2018.9.18版)	島根原子力発電所 2号炉	備考		
		<p>(8) 貫通部止水処置</p> <table border="1" data-bbox="1736 310 2504 346"> <tr> <td data-bbox="1736 310 1941 346">種類</td> <td data-bbox="1941 310 2504 346">モルタル</td> </tr> </table>  <p data-bbox="1893 926 2326 961">図 2-9 貫通部止水処置 (モルタル)</p>	種類	モルタル	
種類	モルタル				

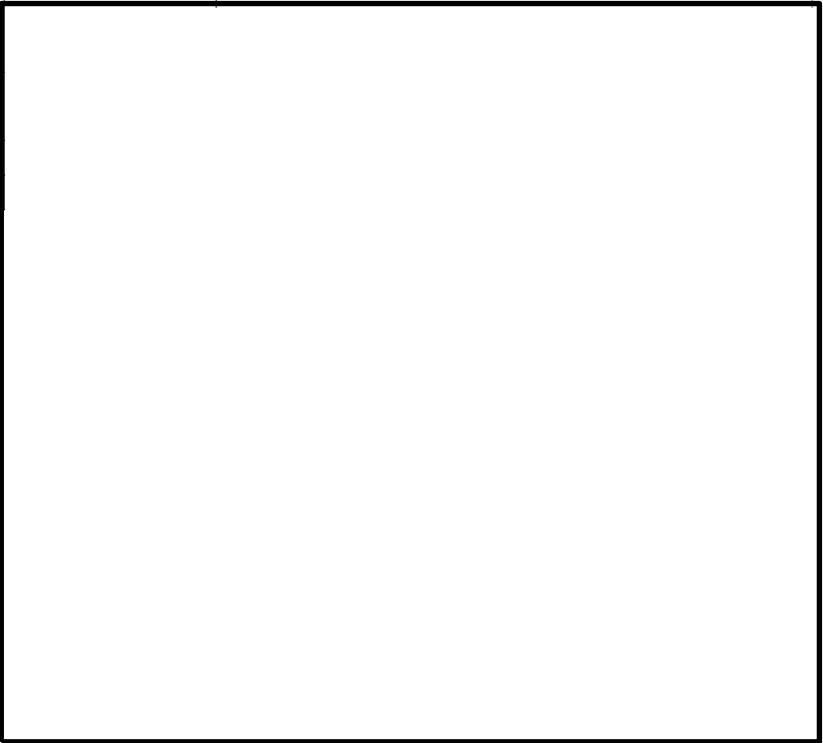
柏崎刈羽原子力発電所 6 / 7号炉 (2017.12.20版)	東海第二発電所 (2018.9.18版)	島根原子力発電所 2号炉	備考		
		<p>(9) 貫通部止水処置</p> <table border="1" data-bbox="1736 310 2504 342"> <tr> <td data-bbox="1736 310 1932 342">種類</td> <td data-bbox="1932 310 2504 342">カバー付き防水板</td> </tr> </table>  <p data-bbox="1952 1060 2288 1092">図 2-10 カバー付き防水板</p>	種類	カバー付き防水板	
種類	カバー付き防水板				

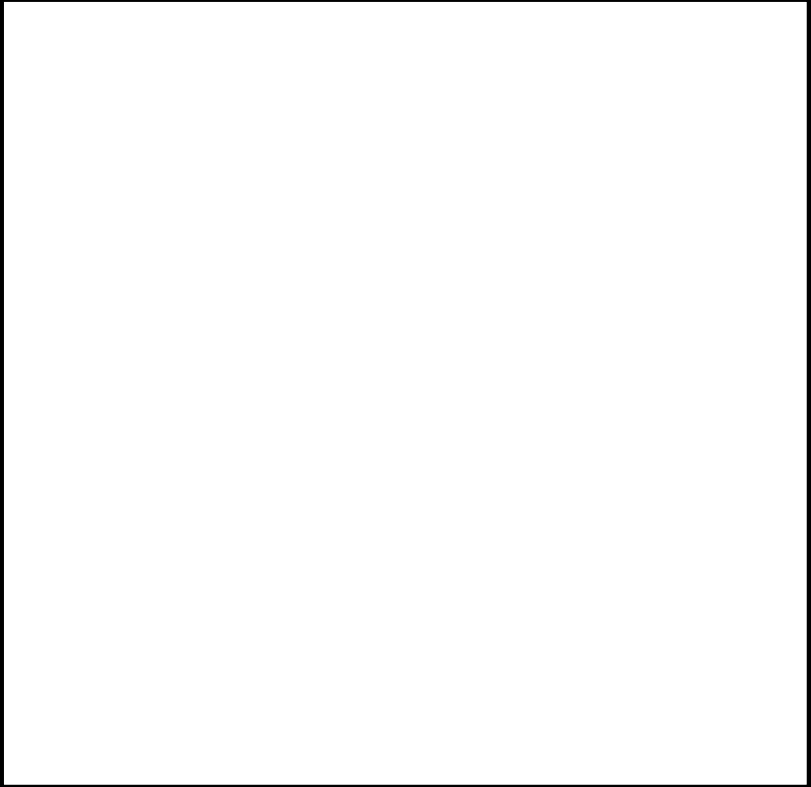
柏崎刈羽原子力発電所 6 / 7号炉 (2017.12.20版)	東海第二発電所 (2018.9.18版)	島根原子力発電所 2号炉	備考
		<p>(10) 被水カバー</p>  <p>図 2-11 被水カバー (例)</p>	

柏崎刈羽原子力発電所 6 / 7号炉 (2017.12.20版)	東海第二発電所 (2018.9.18版)	島根原子力発電所 2号炉	備考																						
		<p>2.1.2 排水措置 <u>溢水防護対象設備を防護するため、排水設備を設置する。設備設置箇所一覧を表 2-2 に示す。</u></p> <p>表 2-2 排水設備設置箇所一覧</p> <table border="1" data-bbox="1739 470 2499 655"> <thead> <tr> <th>設置場所</th> <th>設置高さ (EL[m])</th> <th>対象</th> <th>箇所数</th> </tr> </thead> <tbody> <tr> <td>原子炉</td> <td>23.8</td> <td>通水扉</td> <td>2</td> </tr> <tr> <td>建物</td> <td>15.3</td> <td>通水扉</td> <td>2</td> </tr> </tbody> </table> <p>2.1.2.1 排水設備の構造 <u>排水設備の構造及び性能を図 2-12 に記す。</u></p> <p>(1) 通水扉</p> <table border="1" data-bbox="1748 932 2484 1087"> <tbody> <tr> <td>種類</td> <td>小扉フラップ型</td> </tr> <tr> <td>主要寸法</td> <td>開口サイズ 600mm×600mm</td> </tr> <tr> <td>主要材料</td> <td>溶融亜鉛めっき鋼板</td> </tr> <tr> <td>通水性能</td> <td>制限水位以下で開放すること</td> </tr> <tr> <td>耐震性</td> <td>基準地震動 Ss による地震力に対して機能維持</td> </tr> </tbody> </table> <p>図 2-12 通水扉</p>	設置場所	設置高さ (EL[m])	対象	箇所数	原子炉	23.8	通水扉	2	建物	15.3	通水扉	2	種類	小扉フラップ型	主要寸法	開口サイズ 600mm×600mm	主要材料	溶融亜鉛めっき鋼板	通水性能	制限水位以下で開放すること	耐震性	基準地震動 Ss による地震力に対して機能維持	<p>・設備の相違 【柏崎 6/7, 東海第二】</p>
設置場所	設置高さ (EL[m])	対象	箇所数																						
原子炉	23.8	通水扉	2																						
建物	15.3	通水扉	2																						
種類	小扉フラップ型																								
主要寸法	開口サイズ 600mm×600mm																								
主要材料	溶融亜鉛めっき鋼板																								
通水性能	制限水位以下で開放すること																								
耐震性	基準地震動 Ss による地震力に対して機能維持																								

柏崎刈羽原子力発電所 6 / 7号炉 (2017.12.20版)	東海第二発電所 (2018.9.18版)	島根原子力発電所 2号炉	備考
	<p>4.2.2 耐津波の浸水防護施設との関連</p> <p>(1) 原子炉建屋の津波対策</p> <p>津波防護対象設備を内包する建屋・壁のうち原子炉建屋についての浸水防止対策を示す。津波から区画を防護する止水バウンダリは、建屋外壁部となる。ここでは、基準津波は敷地に浸水させないことから、基準津波を越え敷地に浸水する津波が対象となる。浸水防護施設による浸水対策の位置、仕様、構造を第3表、第6図、第7図及び止水対策状況を補足説明資料-14に示す。</p> <p>また、建屋地下外壁部の貫通部については、補足説明資料-37に詳細を示す。</p> <p>① 水密扉の構造等</p> <p>水密扉及び貫通部止水措置の耐水圧は、数値シミュレーションによる津波評価に基づく、各建屋、壁の位置における最大浸水深に対する静水圧に耐える設計とする。</p> <p>基準地震動S_gによる地震力等の溢水の要因となる事象に伴い生じる荷重や環境に対して必要な動作機能及び構造強度が損なわれない設計とする。</p>		<p>・島根2号炉は基準津波を越え、敷地に浸水する津波を想定していない</p> <p>【東海第二】</p>

柏崎刈羽原子力発電所 6 / 7号炉 (2017.12.20版)	東海第二発電所 (2018.9.18版)	島根原子力発電所 2号炉	備考																																																																																																					
	<p style="text-align: center;">第3表 敷地に遡る津波に対応する設備</p> <table border="1" style="width: 100%; border-collapse: collapse;"> <thead> <tr> <th style="width: 15%;">種類 (名称)</th> <th colspan="4">主要寸法, 材料及び取付箇所</th> </tr> </thead> <tbody> <tr> <td rowspan="4">水密扉 (R/B-1F-09)</td> <td rowspan="2">主要寸法</td> <td>たて</td> <td>mm</td> <td>(5400)</td> </tr> <tr> <td>横</td> <td>mm</td> <td>(4900)</td> </tr> <tr> <td colspan="2">材料</td> <td>—</td> <td>鋼材</td> </tr> <tr> <td colspan="2">取付箇所</td> <td>—</td> <td>原子炉建屋1階</td> </tr> <tr> <td rowspan="4">水密扉 (R/B-1F-11)</td> <td rowspan="2">主要寸法</td> <td>たて</td> <td>mm</td> <td>(2290)</td> </tr> <tr> <td>横</td> <td>mm</td> <td>(1520)</td> </tr> <tr> <td colspan="2">材料</td> <td>—</td> <td>鋼材</td> </tr> <tr> <td colspan="2">取付箇所</td> <td>—</td> <td>原子炉建屋1階</td> </tr> <tr> <td rowspan="4">水密扉 (R/B-1F-13)</td> <td rowspan="2">主要寸法</td> <td>たて</td> <td>mm</td> <td>(3080)</td> </tr> <tr> <td>横</td> <td>mm</td> <td>(1815)</td> </tr> <tr> <td colspan="2">材料</td> <td>—</td> <td>鋼材</td> </tr> <tr> <td colspan="2">取付箇所</td> <td>—</td> <td>原子炉建屋1階</td> </tr> <tr> <td rowspan="4">水密扉 (R/B-1F-14)</td> <td rowspan="2">主要寸法</td> <td>たて</td> <td>mm</td> <td>(2030)</td> </tr> <tr> <td>横</td> <td>mm</td> <td>(1100)</td> </tr> <tr> <td colspan="2">材料</td> <td>—</td> <td>鋼材</td> </tr> <tr> <td colspan="2">取付箇所</td> <td>—</td> <td>原子炉建屋1階</td> </tr> <tr> <td rowspan="4">水密扉 (T/B-R/B-1F-01)</td> <td rowspan="2">主要寸法</td> <td>たて</td> <td>mm</td> <td>(2025)</td> </tr> <tr> <td>横</td> <td>mm</td> <td>(850)</td> </tr> <tr> <td colspan="2">材料</td> <td>—</td> <td>鋼材</td> </tr> <tr> <td colspan="2">取付箇所</td> <td>—</td> <td>原子炉建屋1階</td> </tr> <tr> <td rowspan="4">水密扉 (T/B-R/B-1F-02)</td> <td rowspan="2">主要寸法</td> <td>たて</td> <td>mm</td> <td>(2025)</td> </tr> <tr> <td>横</td> <td>mm</td> <td>(850)</td> </tr> <tr> <td colspan="2">材料</td> <td>—</td> <td>鋼材</td> </tr> <tr> <td colspan="2">取付箇所</td> <td>—</td> <td>原子炉建屋1階</td> </tr> </tbody> </table> <p>注：() 内は公称値を示す。</p>	種類 (名称)	主要寸法, 材料及び取付箇所				水密扉 (R/B-1F-09)	主要寸法	たて	mm	(5400)	横	mm	(4900)	材料		—	鋼材	取付箇所		—	原子炉建屋1階	水密扉 (R/B-1F-11)	主要寸法	たて	mm	(2290)	横	mm	(1520)	材料		—	鋼材	取付箇所		—	原子炉建屋1階	水密扉 (R/B-1F-13)	主要寸法	たて	mm	(3080)	横	mm	(1815)	材料		—	鋼材	取付箇所		—	原子炉建屋1階	水密扉 (R/B-1F-14)	主要寸法	たて	mm	(2030)	横	mm	(1100)	材料		—	鋼材	取付箇所		—	原子炉建屋1階	水密扉 (T/B-R/B-1F-01)	主要寸法	たて	mm	(2025)	横	mm	(850)	材料		—	鋼材	取付箇所		—	原子炉建屋1階	水密扉 (T/B-R/B-1F-02)	主要寸法	たて	mm	(2025)	横	mm	(850)	材料		—	鋼材	取付箇所		—	原子炉建屋1階		
種類 (名称)	主要寸法, 材料及び取付箇所																																																																																																							
水密扉 (R/B-1F-09)	主要寸法	たて	mm	(5400)																																																																																																				
		横	mm	(4900)																																																																																																				
	材料		—	鋼材																																																																																																				
	取付箇所		—	原子炉建屋1階																																																																																																				
水密扉 (R/B-1F-11)	主要寸法	たて	mm	(2290)																																																																																																				
		横	mm	(1520)																																																																																																				
	材料		—	鋼材																																																																																																				
	取付箇所		—	原子炉建屋1階																																																																																																				
水密扉 (R/B-1F-13)	主要寸法	たて	mm	(3080)																																																																																																				
		横	mm	(1815)																																																																																																				
	材料		—	鋼材																																																																																																				
	取付箇所		—	原子炉建屋1階																																																																																																				
水密扉 (R/B-1F-14)	主要寸法	たて	mm	(2030)																																																																																																				
		横	mm	(1100)																																																																																																				
	材料		—	鋼材																																																																																																				
	取付箇所		—	原子炉建屋1階																																																																																																				
水密扉 (T/B-R/B-1F-01)	主要寸法	たて	mm	(2025)																																																																																																				
		横	mm	(850)																																																																																																				
	材料		—	鋼材																																																																																																				
	取付箇所		—	原子炉建屋1階																																																																																																				
水密扉 (T/B-R/B-1F-02)	主要寸法	たて	mm	(2025)																																																																																																				
		横	mm	(850)																																																																																																				
	材料		—	鋼材																																																																																																				
	取付箇所		—	原子炉建屋1階																																																																																																				

柏崎刈羽原子力発電所 6 / 7号炉 (2017.12.20版)	東海第二発電所 (2018.9.18版)	島根原子力発電所 2号炉	備考
	<div data-bbox="952 264 1709 783" data-label="Image"> </div> <div data-bbox="1113 831 1528 871" data-label="Caption"> <p>第6図 津波防護の水密扉の配置</p> </div> <div data-bbox="952 1205 1709 1724" data-label="Image"> </div> <div data-bbox="943 1730 1700 1770" data-label="Caption"> <p>第7図 原子炉建屋地上部外壁の止水対策箇所図箇所配置計画</p> </div>		

柏崎刈羽原子力発電所 6 / 7号炉 (2017.12.20版)	東海第二発電所 (2018.9.18版)	島根原子力発電所 2号炉	備考																									
	<p>4.3 貫通部シール材等の止水性能及び耐震性について 貫通部止水対策と使用するシール材及びラバーブーツの止水性能及び耐震性を性能試験等で確認する。</p> <p>4.3.1 シール材, ラバーブーツ及びモルタルの止水性能について</p> <p>(1) シール材及びラバーブーツ</p> <p>シール材及びラバーブーツは, 規格化された物性値がないため, 実機と同等の形状, 寸法を模擬した試験体を用いた性能試験により要求される許容漏水量を満足する止水性能を確認する。第8図に性能試験装置の概要を示す。</p> <p>試験体の選定にあたり設計条件の包絡性を評価した代表仕様とする。また, 試験条件は, 貫通部止水材料の種類, 形状(直管, 曲げ管等), 想定荷重, 荷重作用方向, 試験体数及び耐圧保持時間等を考慮し適切に設定する。</p> <p>性能試験の結果より評価モデルから, 評価基準を設ける。なお, 評価基準を設けるにあたり評価モデルでの止水性能との関係を確認する主な項目は次のとおりとする。</p> <ul style="list-style-type: none"> 貫通部止水材料のシール材種類 貫通部止水材料の内径, 厚さ(脚長等), 隙間等 実機施工条件等 	<p>2.1.3 溢水防護対策に用いる材料の選定について</p> <p>建物の配管等貫通部については, 貫通物の種類, 温度等に応じて水密性のあるシール材の充填等による止水処理を実施する。建物の配管等貫通部における止水処理の例を表2-3に示す。</p> <p>また, 溢水防護対策に用いる材料の選定にあたっては, 火災防護上, 火災荷重を可能な限り低減させる配慮を行っている。具体的には, 配管貫通部やケーブルトレイ貫通部, 水密扉やハッチ, 堰, 防水壁等の止水に用いるシール材には不燃性又は難燃性の材料を選定する。</p> <p>表2-3 建物の配管等貫通部における止水処理(例)</p> <table border="1" data-bbox="1739 747 2493 1577"> <thead> <tr> <th rowspan="2">貫通物</th> <th rowspan="2">止水処理</th> <th colspan="2">施工内容</th> <th rowspan="2">説明</th> </tr> <tr> <th>断面図</th> <th>写真</th> </tr> </thead> <tbody> <tr> <td rowspan="2">低温配管</td> <td>モルタル</td> <td rowspan="6" style="text-align: center; vertical-align: middle;">[断面図と写真の領域]</td> <td rowspan="6" style="text-align: center; vertical-align: middle;">[写真領域]</td> <td>貫通スリーブと配管の間にモルタルを充填する</td> </tr> <tr> <td>シリコン</td> <td>貫通スリーブと配管の間にシリコンを充填する</td> </tr> <tr> <td rowspan="2">高温配管</td> <td>ラバーブーツ</td> <td>貫通スリーブと配管にラバーブーツの端部を固定する</td> </tr> <tr> <td>シリコン</td> <td>貫通スリーブとケーブルトレイの間, ケーブルトレイ内にシリコンを充填する</td> </tr> <tr> <td>ケーブルトレイ</td> <td>シリコン</td> <td>電線管が接続するブルボックス内にシリコンを充填する</td> </tr> <tr> <td>電線管</td> <td></td> <td></td> </tr> </tbody> </table>	貫通物	止水処理	施工内容		説明	断面図	写真	低温配管	モルタル	[断面図と写真の領域]	[写真領域]	貫通スリーブと配管の間にモルタルを充填する	シリコン	貫通スリーブと配管の間にシリコンを充填する	高温配管	ラバーブーツ	貫通スリーブと配管にラバーブーツの端部を固定する	シリコン	貫通スリーブとケーブルトレイの間, ケーブルトレイ内にシリコンを充填する	ケーブルトレイ	シリコン	電線管が接続するブルボックス内にシリコンを充填する	電線管			<p>(柏崎6/7は「4.2.4 溢水防護対策に用いる材料の選定について」で記載)</p>
貫通物	止水処理	施工内容			説明																							
		断面図	写真																									
低温配管	モルタル	[断面図と写真の領域]	[写真領域]	貫通スリーブと配管の間にモルタルを充填する																								
	シリコン			貫通スリーブと配管の間にシリコンを充填する																								
高温配管	ラバーブーツ			貫通スリーブと配管にラバーブーツの端部を固定する																								
	シリコン			貫通スリーブとケーブルトレイの間, ケーブルトレイ内にシリコンを充填する																								
ケーブルトレイ	シリコン			電線管が接続するブルボックス内にシリコンを充填する																								
電線管																												

2.1.4 貫通部の止水対策の耐水圧性能及び地震時の健全性について

貫通部については止水対策が必要となる箇所に対して、シール材、ラバーブーツ及びモルタル施工を実施することとしており、これらの止水措置の耐水圧性能及び地震時の健全性を以下のとおり確認している。

2.1.4.1 シール材、ラバーブーツ及びモルタルの止水性能について

(1) シール材

a. シリコン (配管貫通部)

配管貫通部の止水処理に用いるシリコンについては、図2-13に示す試験体による耐圧試験により止水性能を確認した。なお、保守的に試験体には配管を模擬していない。

本試験において得られたシリコンの許容耐圧値は [] (試験体6体のうち最も低い破壊限界値)であり、約 [] の静水圧に相当することから、止水性能は確保できる。

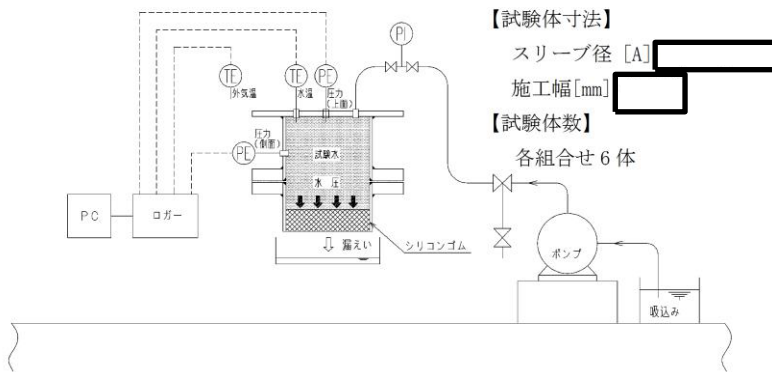

【試験方法】

試験装置に注水後、水により加圧
試験圧力 [] , 保持時間 15分

図 2-13 試験体形状

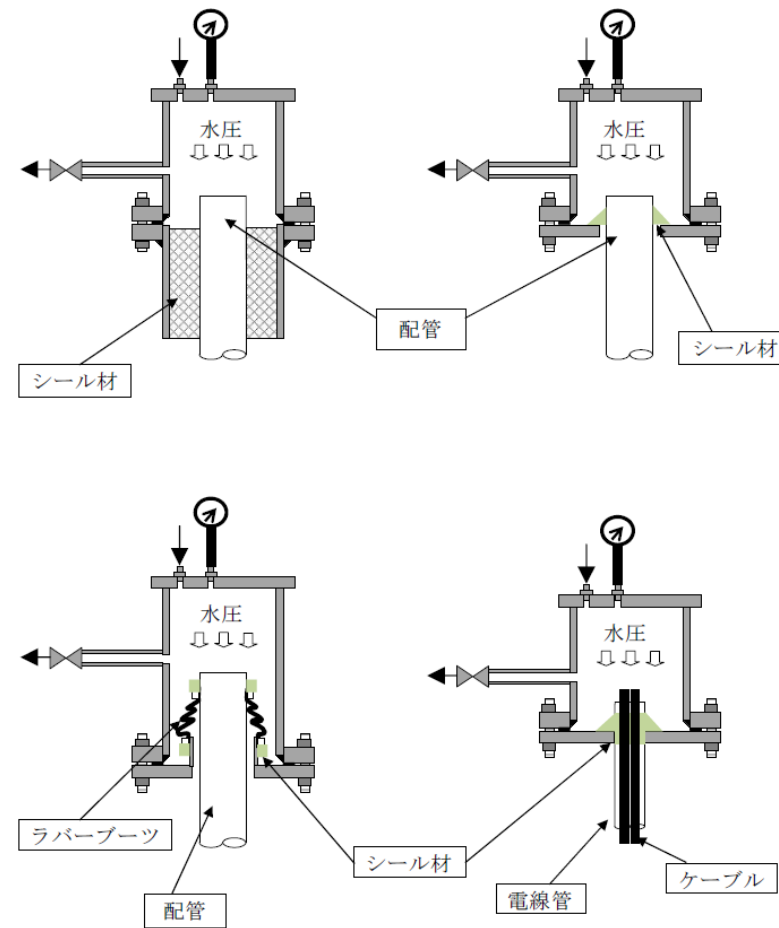

第8図 性能試験装置概要

(柏崎 6/7 は「4.2.3 壁貫通部の止水対策の耐水圧性能及び地震時の健全性について」で記載)

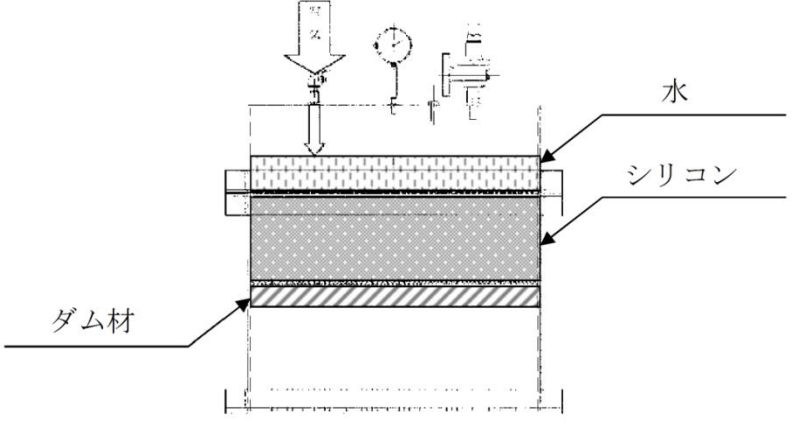
柏崎刈羽原子力発電所 6 / 7号炉 (2017. 12. 20 版)	東海第二発電所 (2018. 9. 18 版)	島根原子力発電所 2号炉	備考
		<p>b. シリコン (ケーブルトレイ, 電線管)</p> <p>ケーブルトレイ, 電線管の止水処理に用いるシリコンについては, 図 2-14 に示すとおり, 試験圧力 0.15MPa (静水圧 15m 相当) で継続加圧した結果, 漏えいは認められなかったため, 止水性能は十分に確保できる。</p>  <p>【試験条件】 シリコン充填高さ : <input type="text"/></p> <p>【試験方法】 試験装置に注水後, 空気により加圧 試験圧力 (0.15MPa) , 保持時間 72 時間</p> <p>図 2-14 試験装置全体図</p>	

(2) ラバーブーツ

配管貫通部の止水処理に用いるラバーブーツについては、耐圧試験によって耐水性を確認し、配管貫通部に要求される耐水性を満足するものを使用する。

図 2-15 に示す試験体による耐圧試験により止水性能を確認した。試験体の諸元及び試験結果を表 2-4、2-5 に示す。



図 2-15 試験装置全体図

表 2-4 試験体諸元・試験結果 (型式 1)

No.	呼び寸法		許容耐圧値 [MPa]	
	配管径 [A]	スリーブ径 [A]	内圧	外圧
1	[Redacted]		0.04	0.03
2			0.03	0.02

表 2-5 試験体諸元・試験結果※ (型式 2)

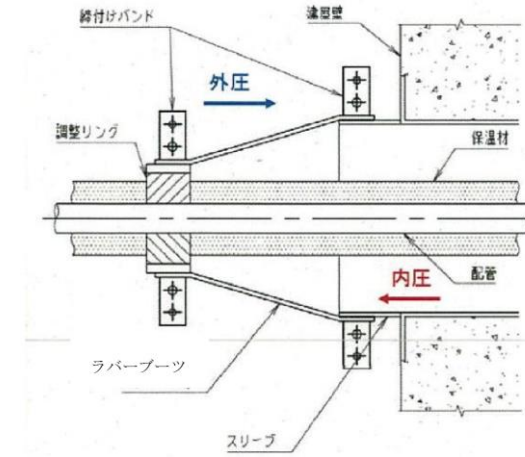
No.	呼び寸法		許容耐圧値 [MPa]	
	配管径 [A]	スリーブ径 [A]	内圧	外圧
1	[Redacted]		0.20	0.20
2			0.20	0.20
3			0.20	-

※「原子カプラントにおける貫通部シール水密性能検証試験」(三菱重工業株式会社)より抜粋

【試験方法】

ラバーブーツ内側・外側から水により加圧

(2) モルタル

モルタル材料は、土木・建築分野で構造評価手法が広く普及しているため、策定した評価モデルを基にそれらの評価手法を準用する。

評価手法として、想定される静水頭圧によりモルタル部受圧面積に作用する荷重が、モルタルが壁及び配管と接触する部分に生じる許容せん断荷重に対して、モルタルの付着強度が確保されていることを確認する。モルタル部の評価モデルの概要を第9図に示す。なお、せん断応力は、土木、建築学会等が発行している各種示方書等に記載のコンクリートと鉄筋等の付着強度/応力度を参照する。

- ・スリーブ径：D (mm)
- ・モルタル充填深さ：L (mm)
- ・モルタルの許容せん断荷重： τ (N/mm²)
- ・配管径：d (mm)
- ・静水頭圧：P (N/mm²)

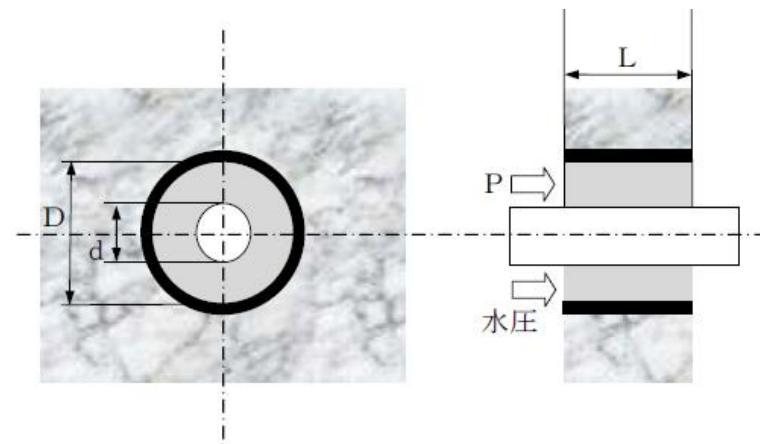

第9図 モルタル評価モデル概念図

a. 静水頭圧によってモルタルに作用する荷重 (F1)

$$F1 (N) = P \times (\pi / 4 \times (D^2 - d^2))$$

b. モルタルに生じる許容せん断荷重 (F2)

$$F2 (N) = \tau \times (\pi \times (D + d) \times L)$$

c. 性能評価

a, bで算出した荷重に対して以下の関係が成り立つことを確

(3) モルタル

貫通部の止水処理に用いるモルタルについては、以下のとおり静水圧に対し十分な耐性を有していることを確認している。モルタルの評価概要を図2-16に示す。

【検討条件】

- ・スリーブ径：D [mm]
 - ・モルタルの充填深さ：L [mm]
 - ・配管径：d [mm]
 - ・モルタル許容付着強度*：2.0 [N/mm²]
 - ・静水圧：0.2 [N/mm²] (保守的に20m相当の静水圧を想定)
- ※「鉄筋コンクリート構造計算基準・同解説2010」による。



図2-16 モルタル評価概要図

① モルタル部分に作用する水圧荷重 (P1)

静水圧がモルタル部分に作用したときに生じる荷重は以下のとおり。

$$P1 [N] = 0.2 [N/mm^2] \times (\pi \times (D^2 - d^2) / 4) [mm^2]$$

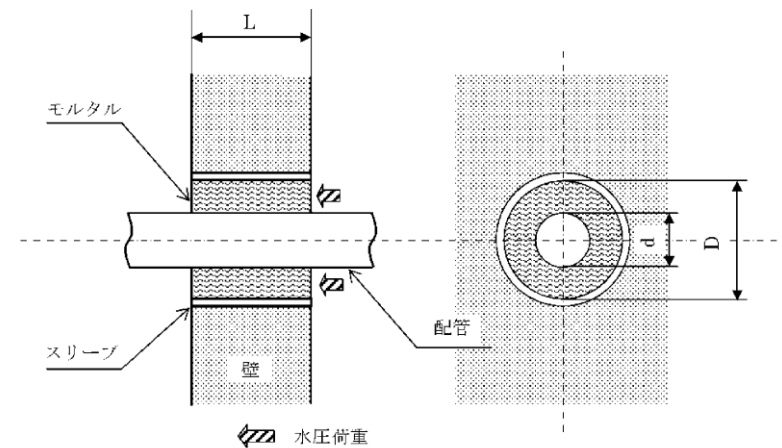
② モルタルの許容付着荷重 (P2)

柏崎刈羽原子力発電所 6 / 7号炉 (2017. 12. 20 版)	東海第二発電所 (2018. 9. 18 版)	島根原子力発電所 2号炉	備考
	<p>認する。 $F1 < F2$</p> <p>上式より、モルタル施工箇所が止水性能を発揮するためには、評価対象貫通部での貫通スリーブ径と配管径に対する最少充填深さを確保することで止水性能は確保できる。</p> <p>4.3.2 シール材、ラバーブーツ及びモルタルの耐震性について (1) シール材及びラバーブーツ シール材及びラバーブーツは、伸縮性や配管変位追従性を考慮して設計を行い、貫通部止水構造に地震が作用した場合の性能試験にて耐震性を確認する。模擬体に地震時に相当する荷重（又は変位）を付与した後、静水頭圧を作用させ確認する。また、余震が作用することも考慮し、本震時に相当する荷重（又は変位）を付与した後、静水頭圧を作用させた状態で、余震時に相当する荷重（又は変位）を付与し、貫通部止水材料の浸水抑制性能を確認する。 これらの結果から、貫通部止水材料が浸水抑制性能を有する限界荷重（又は変位）と浸水抑制性能との関係を確認する。 設計においては、これらの検証結果から、貫通部止水構造</p>	<p>静水圧がモルタル部分に作用したときに、モルタルが耐える限界の付着荷重は以下のとおり。</p> $P2 [N] = 2.0 [N/mm^2] \times (\pi \times (D+d) \times L) [mm^2]$ <p>モルタルの付着強度は、付着面積及び充填深さに比例するため、ここでは、保守的に貫通部に配管がない状態 (d=0) を想定し評価を行った。</p> <p>静水圧に対して止水性能を確保するためには、$P1 \leq P2$ であるため、以下のように整理できる。</p> $0.03 \times D [mm] \leq L [mm]$ <p>上式より、モルタル施工箇所が止水性能を発揮するためには、貫通スリーブ径の 3%以上の充填深さが必要である。例えば 400mm の貫通スリーブに対して、約 12mm 以上の充填深さが必要であるが、実機における対象貫通部の最小厚さ 200mm に対し、モルタルは壁厚さと同程度の厚さで充填されていることを踏まえると、止水性能は十分に確保できる。</p> <p>2.1.4.2 シール材、ラバーブーツ及びモルタルの耐震性について (1) シール材及びラバーブーツ シリコンは伸縮性に優れたシール材であり、また、ラバーブーツについては、配管等の変位追従性に優れた構造となっていることから、地震によりシール材及びラバーブーツの健全性が損なわれることはない。</p>	

柏崎刈羽原子力発電所 6 / 7号炉 (2017.12.20版)	東海第二発電所 (2018.9.18版)	島根原子力発電所 2号炉	備考																			
	<p>の荷重（又は変位）が許容限界以上とならないよう、貫通物を固定する等の設備補強を実施することも考慮する。</p> <p>(2) モルタル</p> <p>モルタルを充填した評価対象貫通部でのモルタル充填深から基準地震動 S_s において貫通部に発生する圧縮・付着荷重が、モルタルの許容荷重以下になることを確認する。</p>	<p>(2) モルタル</p> <p>モルタルを充填した貫通部のうち配管口径 100A 以下かつモルタル充填深さ 500mm 以上のものについては、配管口径 100A 及びモルタル充填深さ 500mm を代表ケースとして、また、配管口径が 100A を超えるか、又はモルタル充填深さが 500mm 未満のものについては個々の配管口径及びモルタル充填深さによる評価を行い、表 2-6 のとおり基準地震動 S_s による地震力において貫通部に発生する圧縮・付着荷重が、モルタルの許容荷重以下になることを確認した。</p> <p>表 2-6 貫通部に発生する荷重とモルタルの許容荷重</p> <table border="1" data-bbox="1736 919 2499 1241"> <thead> <tr> <th rowspan="2">評価 ケース</th> <th rowspan="2">配管 口径 [A]</th> <th rowspan="2">モル タル 充 填 深 さ [mm]</th> <th colspan="2">圧縮荷重評価</th> <th colspan="2">付着荷重評価</th> </tr> <tr> <th>発生 荷重 [kN]</th> <th>許容 荷重^{※2} [kN]</th> <th>発生 荷重 [kN]</th> <th>許容 荷重^{※2} [kN]</th> </tr> </thead> <tbody> <tr> <td>代表</td> <td colspan="6" rowspan="2" style="background-color: #cccccc;"></td> </tr> <tr> <td>個別^{※1}</td> </tr> </tbody> </table> <p>※1 代表ケースに包含されないもののうち、裕度が最小のものを記載。</p> <p>※2 「鉄筋コンクリート構造計画基準・同解説 2010」による。</p>	評価 ケース	配管 口径 [A]	モル タル 充 填 深 さ [mm]	圧縮荷重評価		付着荷重評価		発生 荷重 [kN]	許容 荷重 ^{※2} [kN]	発生 荷重 [kN]	許容 荷重 ^{※2} [kN]	代表							個別 ^{※1}	
評価 ケース	配管 口径 [A]	モル タル 充 填 深 さ [mm]				圧縮荷重評価		付着荷重評価														
			発生 荷重 [kN]	許容 荷重 ^{※2} [kN]	発生 荷重 [kN]	許容 荷重 ^{※2} [kN]																
代表																						
個別 ^{※1}																						

柏崎刈羽原子力発電所 6 / 7号炉 (2017.12.20版)	東海第二発電所 (2018.9.18版)	島根原子力発電所 2号炉	備考
		<p data-bbox="1736 254 2504 327"><u>2.1.5 止水設備及び排水設備が内部火災影響評価に与える影響について</u></p> <p data-bbox="1757 342 2504 821">止水及び排水設備の主要材料は鋼板等の金属材料であるが、水密扉に内包するグリス等の可燃性材料を一部使用している。ただし、これらの可燃性材料は微量であり、内部火災影響評価で用いる各区画の等価時間（発熱量と火災荷重より算出）に十分包含されるため、止水及び排水設備の新規設置により、内部火災影響評価へ影響を与えない。また、止水設備の設置箇所と内部火災対策で設置する耐火壁（貫通部シール、防火扉及び防火ダンパ）の設置箇所が重複する場合は、止水及び耐火の両方の性能を満足できるように設備を設置する。具体例としては水密扉と防火扉の両方を設置する対策があり、図 2-17 に原子炉建物地下 1 階の設置箇所を示す。</p> <div data-bbox="1736 835 2496 1451" style="border: 1px solid black; height: 293px; width: 256px; margin: 10px auto;"></div> <p data-bbox="1863 1465 2377 1539">図 2-17 止水設備と耐火壁の重複設置の例 (原子炉建物地下 1 階)</p>	<p data-bbox="2528 254 2813 373">・島根 2 号炉は止水設備と耐火壁の重複設置の例を記載</p> <p data-bbox="2528 388 2813 422">【柏崎 6/7, 東海第二】</p>

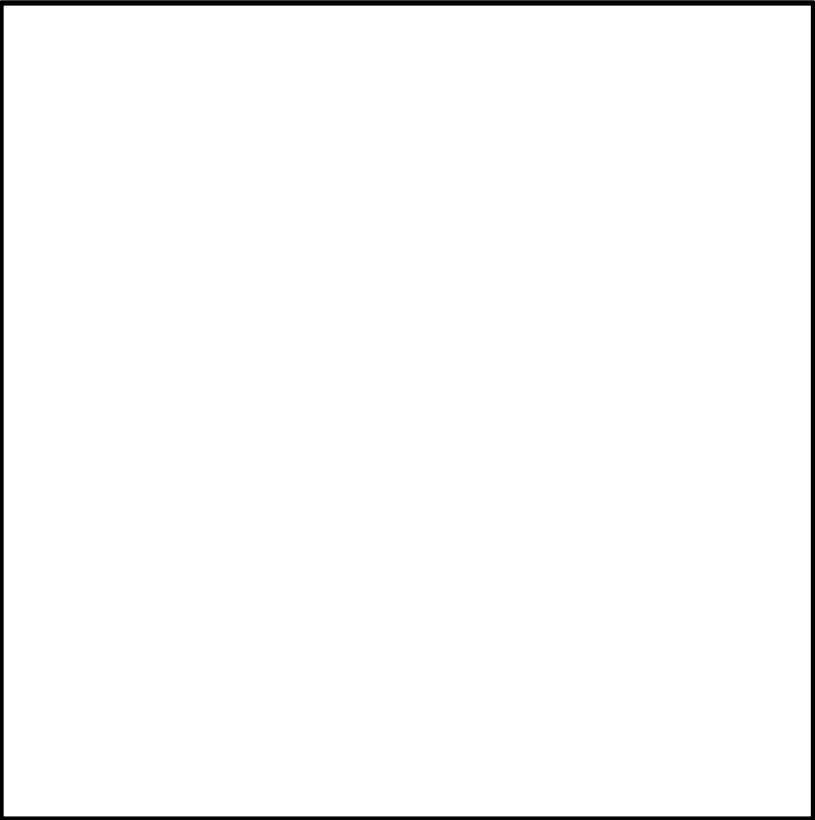
柏崎刈羽原子力発電所 6 / 7号炉 (2017. 12. 20 版)	東海第二発電所 (2018. 9. 18 版)	島根原子力発電所 2号炉	備考
<p>4.2.2 溢水防護対策の主要な施工対象範囲</p> <p>溢水防護対策の施工対象となる壁面／天井面については、その面に接する区画間の一方又は両方向の伝播を防止するための処置を実施する。主要な範囲を以下の(1)～(5)に示す。</p> <p>(1) 6号炉 原子炉建屋</p>  <p>添付第4.2.2-1 図 6号炉 原子炉建屋 (T.M.S.L.-8200) 施工対象範囲</p>		<p>2.2 溢水防護対策設備設置箇所</p> <p>2.2.1 溢水防護対策設備設置箇所 (貫通部止水処置除く)</p> <p>貫通部止水処置を除いた溢水防護対策設備の設置箇所を図2-18～39に示す。</p> <p>2.2.2 貫通部止水処置の施工対象範囲</p> <p>貫通部止水処置の施工対象となる壁面及び床面を以下の図2-40～61に示す。</p>  <p>図 2-18 原子炉建物地下2階 溢水防護対策設備設置箇所</p>	<p>(東海第二は補足説明資料 38, 39 に記載)</p> <p>・設備の相違【柏崎 6/7】</p>

柏崎刈羽原子力発電所 6 / 7号炉 (2017. 12. 20 版)	東海第二発電所 (2018. 9. 18 版)	島根原子力発電所 2号炉	備考
<div data-bbox="166 510 917 1346" data-label="Image"> </div> <div data-bbox="142 1371 923 1455" data-label="Caption"> <p>添付第4. 2. 2-2 図 6号炉 原子炉建屋 (T. M. S. L. -1700) 施工対象 範囲</p> </div>		<div data-bbox="1739 300 2421 1455" data-label="Image"> </div> <div data-bbox="2442 615 2487 1308" data-label="Caption"> <p>図 2-19 原子炉建物地下 1 階 溢水防護対策設備設置箇所</p> </div>	

柏崎刈羽原子力発電所 6 / 7号炉 (2017.12.20版)	東海第二発電所 (2018.9.18版)	島根原子力発電所 2号炉	備考
<div data-bbox="166 520 914 1444" data-label="Image"> </div> <div data-bbox="148 1459 920 1543" data-label="Caption"> <p>添付第4.2.2-3 図 6号炉 原子炉建屋 (T.M.S.L.1500) 施工対象 範囲</p> </div>		<div data-bbox="1736 298 2418 1444" data-label="Image"> </div> <div data-bbox="2448 598 2493 1249" data-label="Caption"> <p>図 2-20 原子炉建物1階 溢水防漏対策設備設置箇所</p> </div>	

柏崎刈羽原子力発電所 6 / 7号炉 (2017. 12. 20 版)	東海第二発電所 (2018. 9. 18 版)	島根原子力発電所 2号炉	備考
<div data-bbox="163 504 914 1444" data-label="Image"> </div> <div data-bbox="148 1459 920 1543" data-label="Caption"> <p>添付第4.2.2-4 図 6号炉 原子炉建屋 (T.M.S.L. 4800) 施工対象 範囲</p> </div>		<div data-bbox="1736 304 2380 1486" data-label="Image"> </div> <div data-bbox="2404 556 2448 1197" data-label="Caption"> <p>図 2-21 原子炉建物 2階 溢水防護対策設備設置箇所</p> </div>	

柏崎刈羽原子力発電所 6 / 7号炉 (2017. 12. 20 版)	東海第二発電所 (2018. 9. 18 版)	島根原子力発電所 2号炉	備考
<div data-bbox="166 510 914 1367" data-label="Image"> </div> <div data-bbox="148 1417 920 1501" data-label="Caption"> <p>添付第4.2.2-5 図 6号炉 原子炉建屋 (T.M.S.L. 8500) 施工対象 範囲</p> </div>		<div data-bbox="1730 275 2415 1356" data-label="Image"> </div> <div data-bbox="2427 451 2469 1123" data-label="Caption"> <p>図 2-22 原子炉建屋中 2 階 溢水防護対策設置箇所</p> </div>	

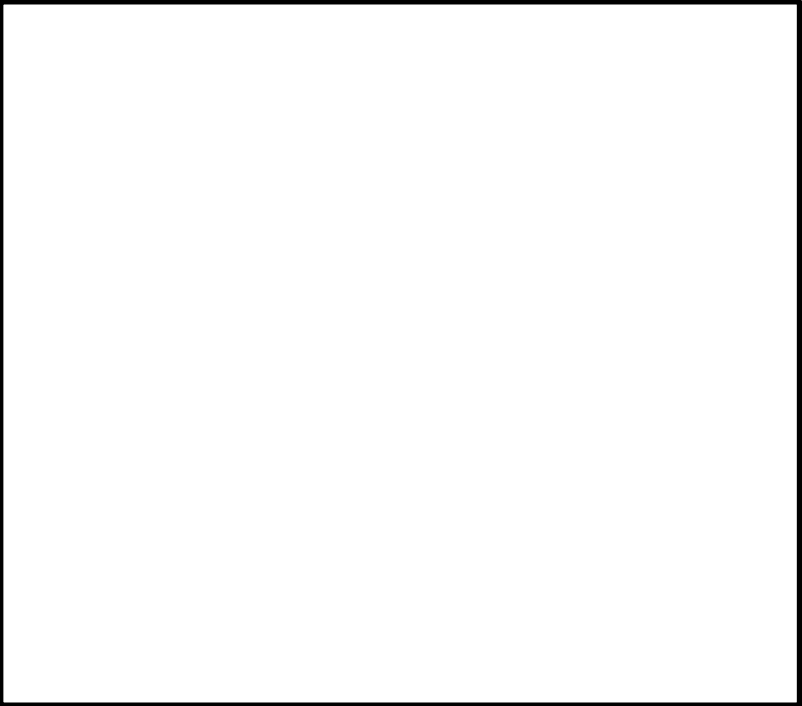
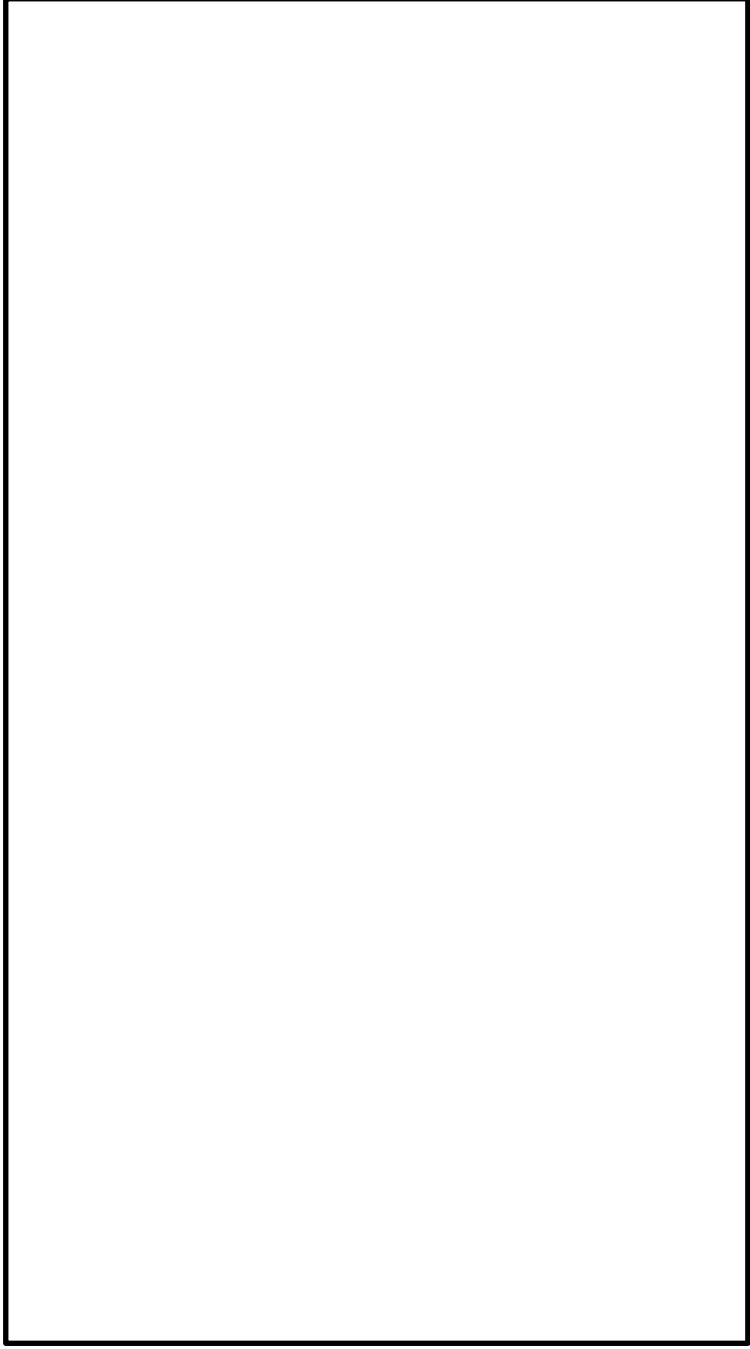

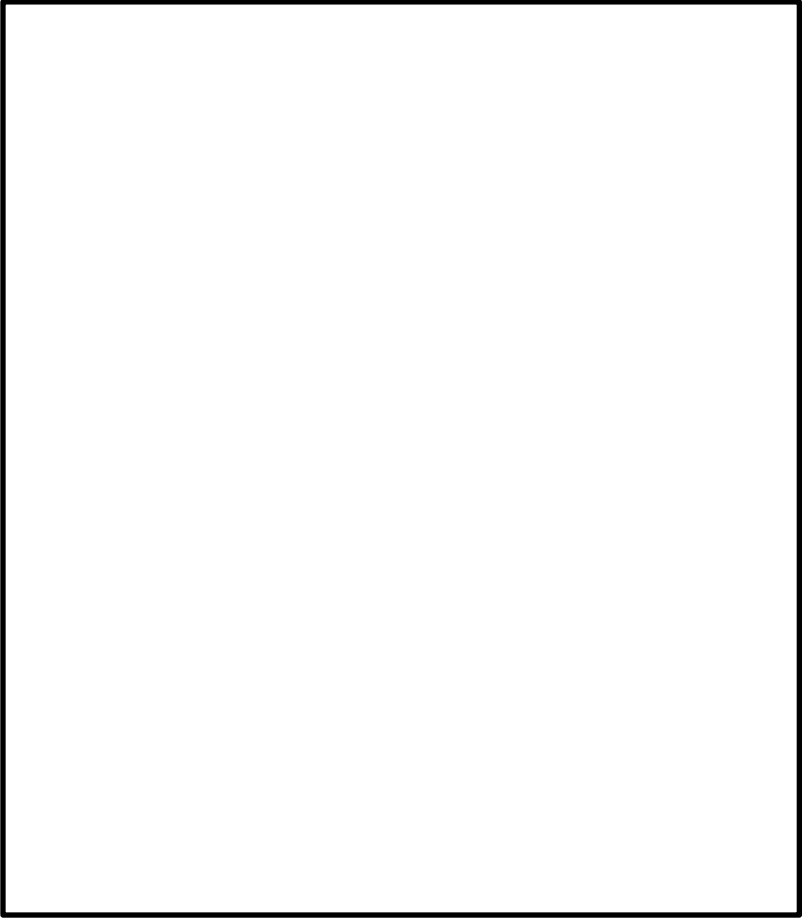
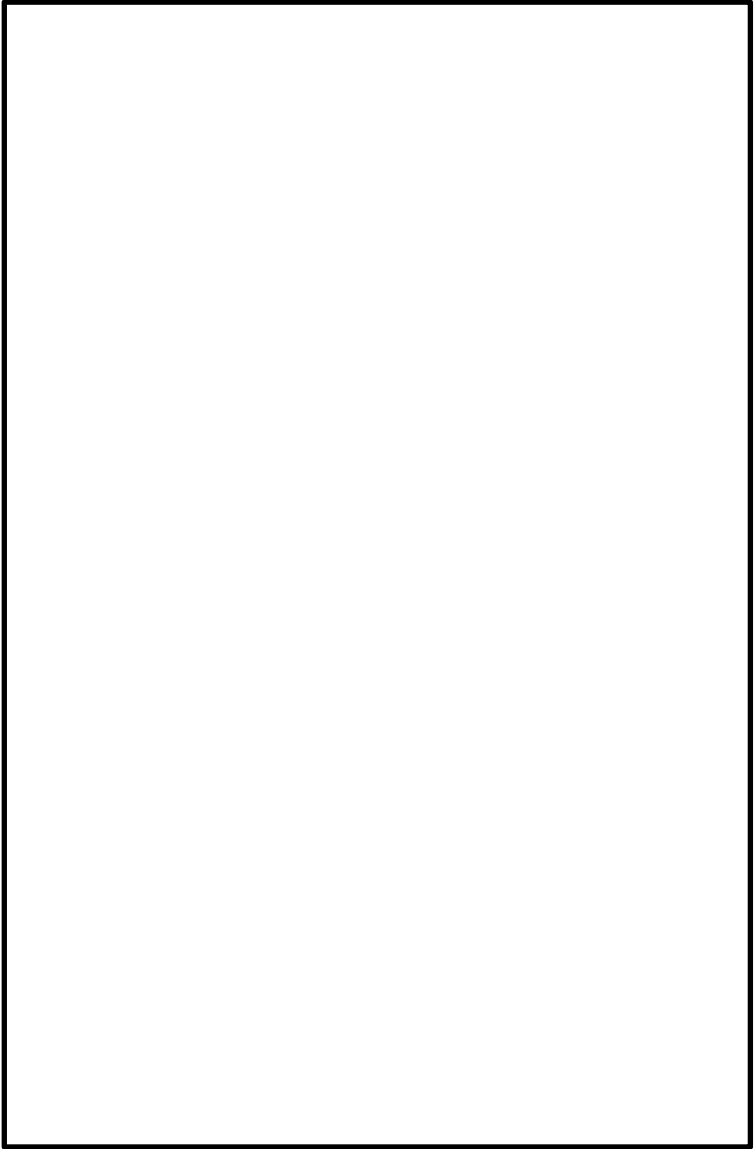
柏崎刈羽原子力発電所 6 / 7号炉 (2017. 12. 20 版)	東海第二発電所 (2018. 9. 18 版)	島根原子力発電所 2号炉	備考
 <p data-bbox="154 1243 914 1318">添付第4.2.2-6 図 6号炉 原子炉建屋 (T.M.S.L.12300) 施工対象 範囲</p>		 <p data-bbox="2445 735 2481 1373">図 2-23 原子炉建物 3階 溢水防護対策設備設置箇所</p>	

柏崎刈羽原子力発電所 6 / 7号炉 (2017. 12. 20 版)	東海第二発電所 (2018. 9. 18 版)	島根原子力発電所 2号炉	備考
 <p data-bbox="154 1419 923 1499">添付第4.2.2-7 図 6号炉 原子炉建屋 (T.M.S.L.18100) 施工対象 範囲</p>		 <p data-bbox="2457 510 2496 1150">図 2-24 原子炉建物 4階 溢水防護対策設備設置箇所</p>	

柏崎刈羽原子力発電所 6 / 7号炉 (2017. 12. 20 版)	東海第二発電所 (2018. 9. 18 版)	島根原子力発電所 2号炉	備考
<div data-bbox="166 512 914 1346" data-label="Image"> </div> <p data-bbox="151 1373 923 1451">添付第4. 2. 2-8 図 6号炉 原子炉建屋 (T. M. S. L. 23500) 施工対象 範囲</p>		<div data-bbox="1745 256 2475 951" data-label="Image"> </div> <p data-bbox="1733 972 2481 1003">図 2-25 廃棄物処理建物地下 2階 溢水防護対策設備設置箇所</p> <div data-bbox="1745 1066 2475 1761" data-label="Image"> </div> <p data-bbox="1733 1782 2481 1814">図 2-26 廃棄物処理建物地下 1階 溢水防護対策設備設置箇所</p>	

柏崎刈羽原子力発電所 6 / 7号炉 (2017. 12. 20 版)	東海第二発電所 (2018. 9. 18 版)	島根原子力発電所 2号炉	備考
<div data-bbox="151 527 917 1478" data-label="Image"> </div> <div data-bbox="142 1507 928 1591" data-label="Caption"> <p>添付第4.2.2-9 図 6号炉 原子炉建屋 (T.M.S.L.27200) 施工対象 範囲</p> </div>		<div data-bbox="1792 296 2448 999" data-label="Image"> </div> <div data-bbox="1721 1014 2513 1052" data-label="Caption"> <p>図 2-27 廃棄物処理建物地下中 1階 溢水防護対策設備設置箇所</p> </div> <div data-bbox="1792 1064 2448 1768" data-label="Image"> </div> <div data-bbox="1760 1778 2475 1816" data-label="Caption"> <p>図 2-28 廃棄物処理建物 1階 溢水防護対策設備設置箇所</p> </div>	

柏崎刈羽原子力発電所 6 / 7号炉 (2017. 12. 20 版)	東海第二発電所 (2018. 9. 18 版)	島根原子力発電所 2号炉	備考
<div data-bbox="166 533 902 1297" data-label="Image"> </div> <div data-bbox="148 1327 920 1409" data-label="Caption"> <p>添付第4.2.2-10 図 6号炉 原子炉建屋 (T.M.S.L.31700) 施工対象範囲</p> </div>		<div data-bbox="1795 260 2421 915" data-label="Image"> </div> <div data-bbox="1765 926 2466 957" data-label="Caption"> <p>図 2-29 廃棄物処理建物 2階 溢水防護対策設備設置箇所</p> </div> <div data-bbox="1795 995 2421 1675" data-label="Image"> </div> <div data-bbox="1765 1688 2466 1719" data-label="Caption"> <p>図 2-30 廃棄物処理建物 3階 溢水防護対策設備設置箇所</p> </div>	

柏崎刈羽原子力発電所 6 / 7号炉 (2017. 12. 20 版)	東海第二発電所 (2018. 9. 18 版)	島根原子力発電所 2号炉	備考
<p data-bbox="154 613 457 642">(2) 6号炉 タービン建屋</p>  <p data-bbox="154 1514 914 1587">添付第4.2.2-11 図 6号炉 タービン建屋 (T.M.S.L.-5100) 施工 対象範囲</p>		 <p data-bbox="1774 974 2463 1003">図 2-31 廃棄物処理建物4階 溢水防護対策設備設置箇所</p>  <p data-bbox="1774 1738 2463 1768">図 2-32 廃棄物処理建物5階 溢水防護対策設備設置箇所</p>	

柏崎刈羽原子力発電所 6 / 7号炉 (2017. 12. 20 版)	東海第二発電所 (2018. 9. 18 版)	島根原子力発電所 2号炉	備考
<div data-bbox="151 533 914 1409" data-label="Image"> </div> <div data-bbox="151 1419 914 1499" data-label="Caption"> <p>添付第4. 2. 2-12 図 6号炉 タービン建屋 (T.M.S.L. -1100) 施工 対象範囲</p> </div>		<div data-bbox="1760 247 2475 911" data-label="Image"> </div> <div data-bbox="1798 926 2436 957" data-label="Caption"> <p>図 2-33 制御室建物 1階 溢水防護対策設備設置箇所</p> </div> <div data-bbox="1760 989 2475 1673" data-label="Image"> </div> <div data-bbox="1783 1688 2451 1719" data-label="Caption"> <p>図 2-34 制御室建物中 2階 溢水防護対策設備設置箇所</p> </div>	

柏崎刈羽原子力発電所 6 / 7号炉 (2017. 12. 20 版)	東海第二発電所 (2018. 9. 18 版)	島根原子力発電所 2号炉	備考
<div data-bbox="151 512 914 1297" data-label="Image"> </div> <p data-bbox="151 1329 923 1409">添付第4.2.2-13 図 6号炉 タービン建屋 (T.M.S.L. 4900) 施工対象範囲</p>		<div data-bbox="1762 247 2472 911" data-label="Image"> </div> <p data-bbox="1798 926 2436 957">図 2-35 制御室建物 2階 溢水防護対策設備設置箇所</p> <div data-bbox="1762 972 2472 1728" data-label="Image"> </div> <p data-bbox="1798 1738 2436 1770">図 2-36 制御室建物 3階 溢水防護対策設備設置箇所</p>	

柏崎刈羽原子力発電所 6 / 7号炉 (2017. 12. 20 版)	東海第二発電所 (2018. 9. 18 版)	島根原子力発電所 2号炉	備考
<div data-bbox="163 535 914 1297" data-label="Image"> </div> <p data-bbox="151 1329 917 1409">添付第4.2.2-14 図 6号炉 タービン建屋 (T.M.S.L.12300) 施工 対象範囲</p>		<div data-bbox="1768 262 2478 909" data-label="Image"> </div> <p data-bbox="1834 926 2407 961">図 2-37 制御室建物 4階 溢水防護対策設備設</p> <div data-bbox="1760 974 2478 1591" data-label="Image"> </div> <p data-bbox="1849 1602 2386 1633">図 2-38 取水槽 溢水防護対策設備設置箇所</p>	

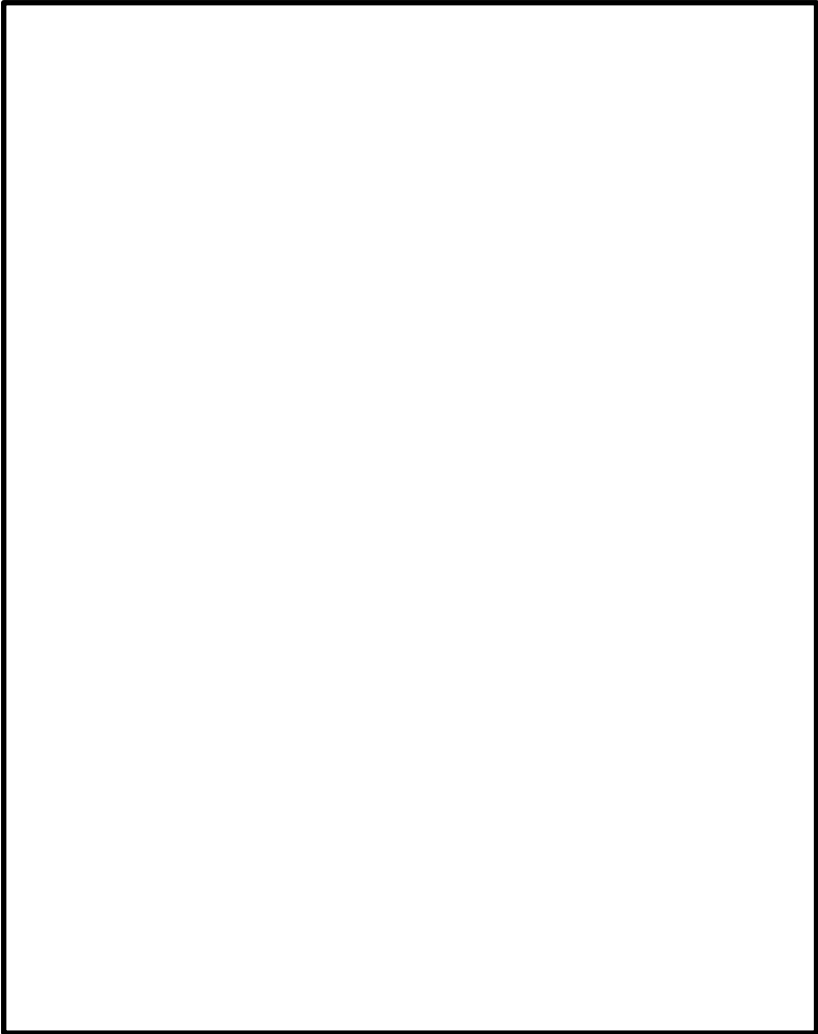
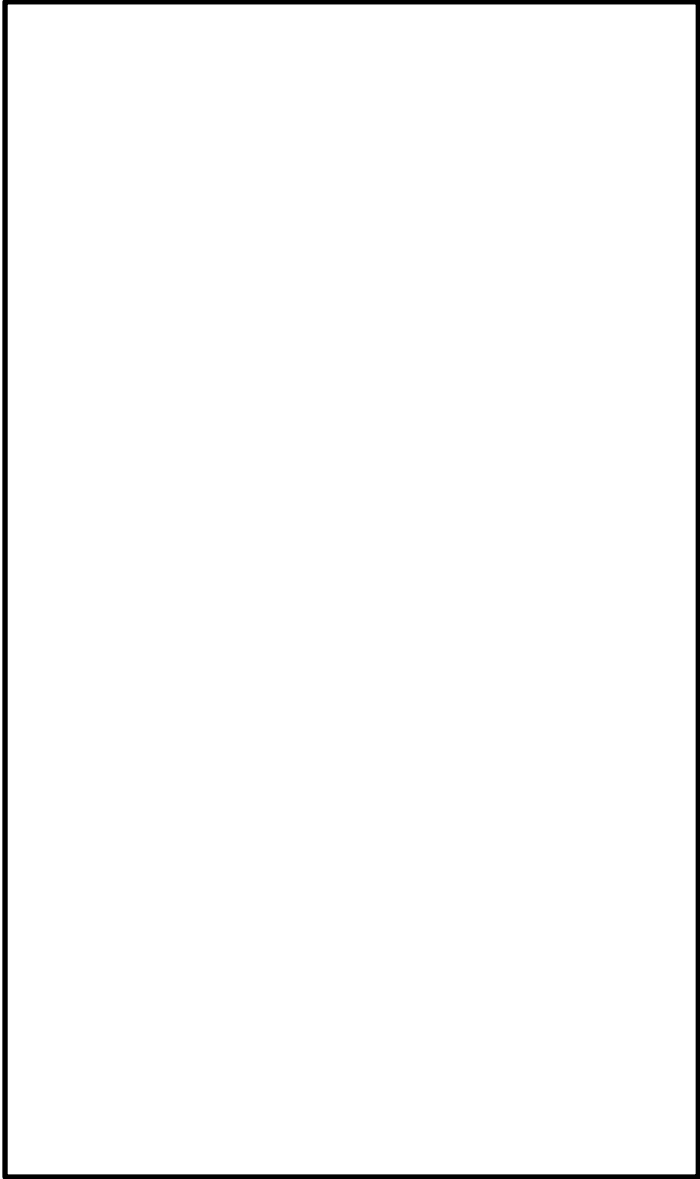
柏崎刈羽原子力発電所 6 / 7号炉 (2017. 12. 20 版)	東海第二発電所 (2018. 9. 18 版)	島根原子力発電所 2号炉	備考
 <p data-bbox="151 1646 914 1724">添付第4. 2. 2-15 図 6号炉 タービン建屋 (T.M.S.L. 17000) 施工 対象範囲</p>		 <p data-bbox="2421 695 2457 1276">図 2-39 排気筒エリア 溢水防護対策設備設置箇</p>	

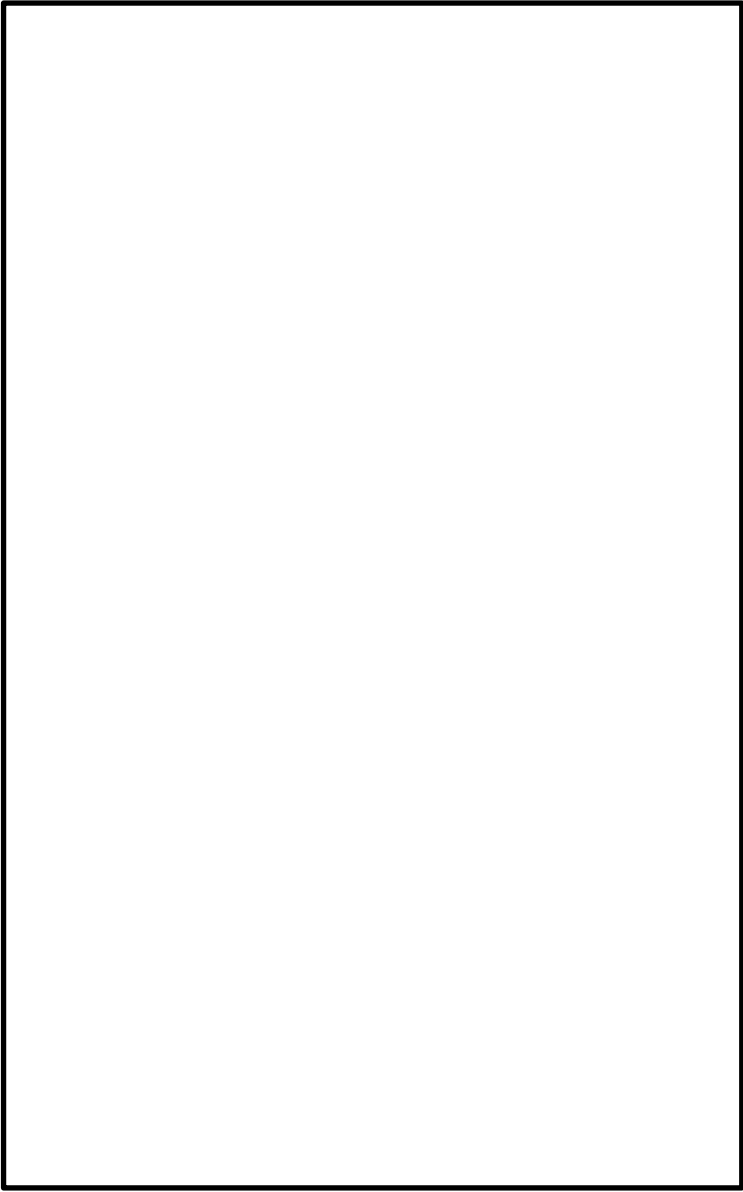
柏崎刈羽原子力発電所 6 / 7号炉 (2017. 12. 20 版)	東海第二発電所 (2018. 9. 18 版)	島根原子力発電所 2号炉	備考
 <p data-bbox="154 1648 902 1722">添付第4. 2. 2-16 図 6号炉 タービン建屋 (T.M.S.L. 20400) 施工 対象範囲</p>		 <p data-bbox="2448 661 2493 1375">図 2-40 原子炉建物地下 2 階 貫通部止水処置施工対象範囲</p>	

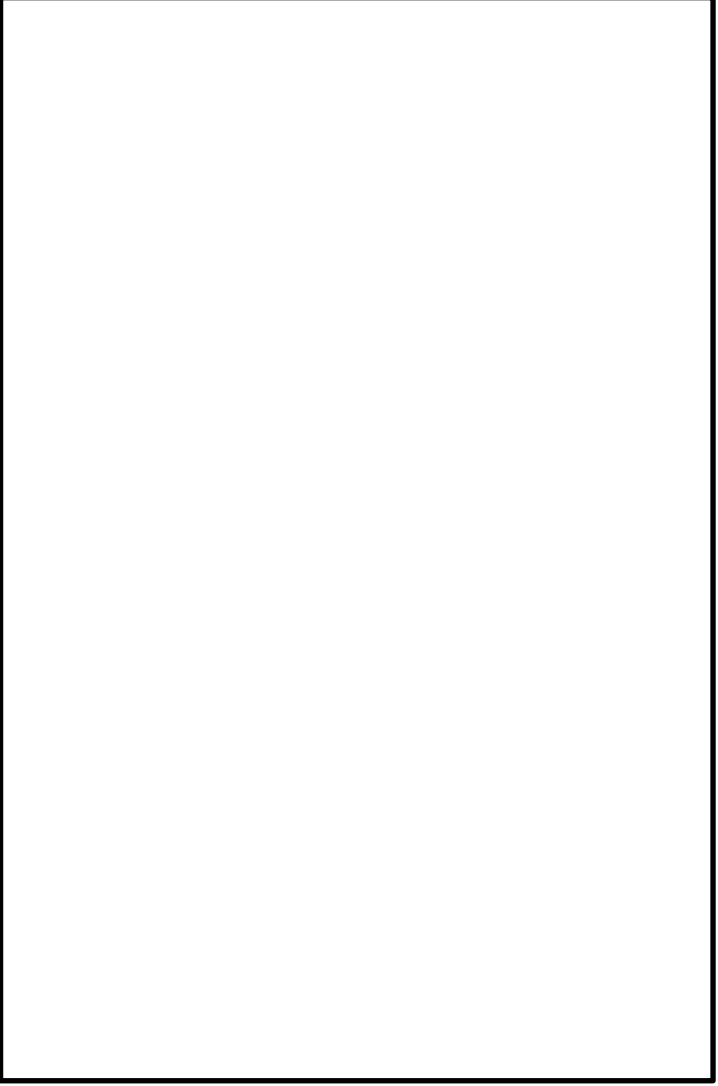
柏崎刈羽原子力発電所 6 / 7号炉 (2017. 12. 20 版)	東海第二発電所 (2018. 9. 18 版)	島根原子力発電所 2号炉	備考
<p data-bbox="154 478 430 508">(3) 7号炉 原子炉建屋</p>  <p data-bbox="154 1690 914 1768">添付第4.2.2-17 図 7号炉 原子炉建屋 (T.M.S.L.-8200) 施工対象範囲</p>		 <p data-bbox="2439 688 2478 1243">図 2-41 原子炉建物地下1階 貫通部止水処</p>	

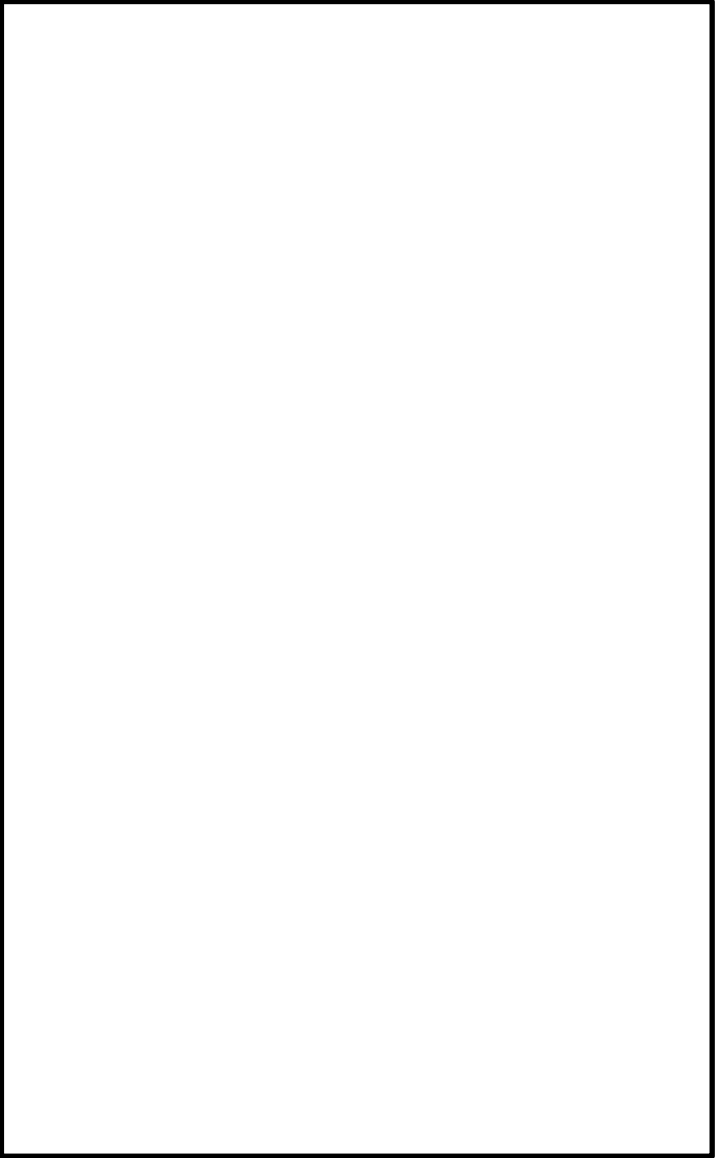

柏崎刈羽原子力発電所 6 / 7号炉 (2017. 12. 20 版)	東海第二発電所 (2018. 9. 18 版)	島根原子力発電所 2号炉	備考
<div data-bbox="151 510 914 1323" data-label="Image"> </div> <p data-bbox="151 1373 914 1453">添付第4. 2. 2-18 図 7号炉 原子炉建屋 (T. M. S. L. -1700) 施工対象範囲</p>		<div data-bbox="1754 443 2412 1535" data-label="Image"> </div> <p data-bbox="2427 682 2472 1262">図 2-42 原子炉建物1階 貫通部止水処置施工</p>	

柏崎刈羽原子力発電所 6 / 7号炉 (2017. 12. 20 版)	東海第二発電所 (2018. 9. 18 版)	島根原子力発電所 2号炉	備考
 <p data-bbox="151 1329 923 1409">添付第4. 2. 2-19 図 7号炉 原子炉建屋 (T. M. S. L. 1500) 施工対象 範囲</p>		 <p data-bbox="2445 556 2481 1220">図 2-43 原子炉建物 2階 貫通部止水処置施工対象範囲</p>	

柏崎刈羽原子力発電所 6 / 7号炉 (2017.12.20版)	東海第二発電所 (2018.9.18版)	島根原子力発電所 2号炉	備考
<div data-bbox="166 558 902 1436" data-label="Image"> </div> <div data-bbox="142 1465 931 1549" data-label="Caption"> <p>添付第4.2.2-20 図 7号炉 原子炉建屋 (T.M.S.L.4800) 施工対象 範囲</p> </div>		<div data-bbox="1754 470 2415 1402" data-label="Image"> </div> <div data-bbox="2427 554 2469 1247" data-label="Caption"> <p>図 2-44 原子炉建屋中2階 貫通部止水処置施工対象範囲</p> </div>	

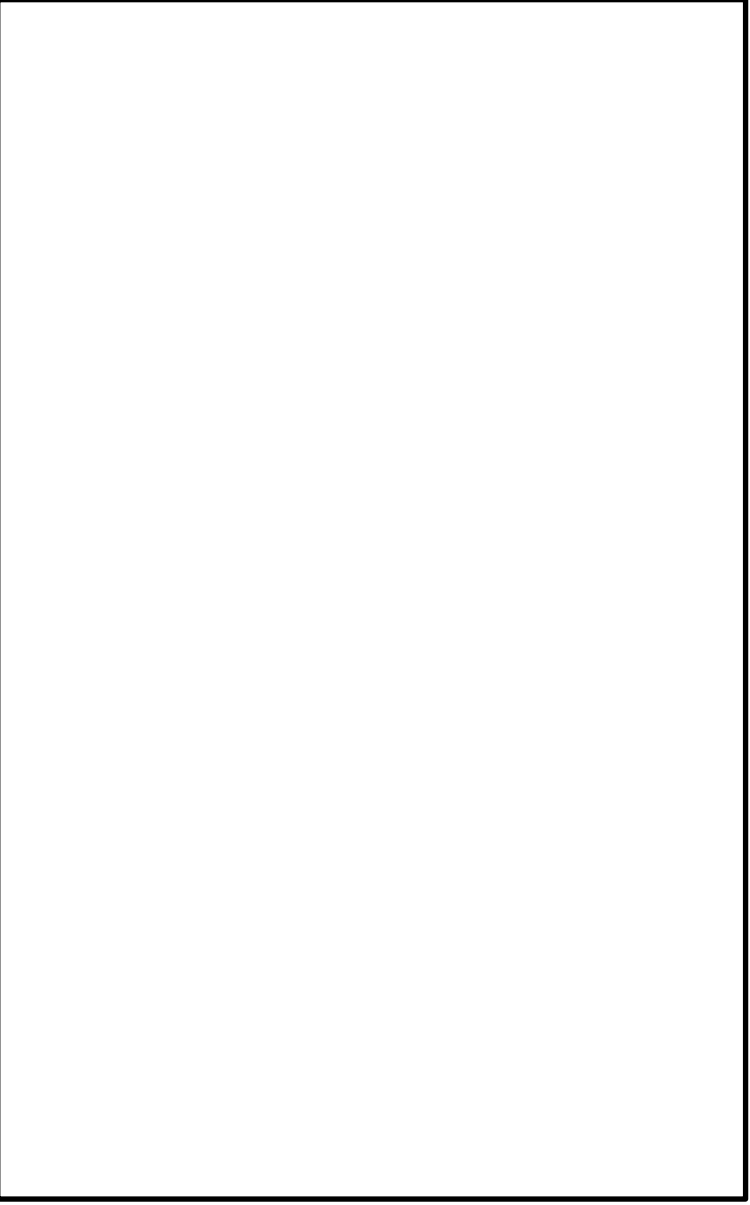
柏崎刈羽原子力発電所 6 / 7号炉 (2017. 12. 20 版)	東海第二発電所 (2018. 9. 18 版)	島根原子力発電所 2号炉	備考
<div data-bbox="151 489 914 1388" data-label="Image"> </div> <div data-bbox="142 1417 928 1501" data-label="Caption"> <p>添付第4.2.2-21 図 7号炉 原子炉建屋 (T.M.S.L. 8500) 施工対象 範囲</p> </div>		<div data-bbox="1733 512 2415 1579" data-label="Image"> </div> <div data-bbox="2436 705 2487 1373" data-label="Caption"> <p>図 2-45 原子炉建物 3 階 貫通部止水処置施工対象範囲</p> </div>	

柏崎刈羽原子力発電所 6 / 7号炉 (2017. 12. 20 版)	東海第二発電所 (2018. 9. 18 版)	島根原子力発電所 2号炉	備考
 <p data-bbox="154 1465 914 1543">添付第4. 2. 2-22 図 7号炉 原子炉建屋 (T.M.S.L. 12300) 施工対象範囲</p>		 <p data-bbox="2457 640 2496 1276">図 2-46 原子炉建物 4階 貫通部止水処置施工対象</p>	

柏崎刈羽原子力発電所 6 / 7号炉 (2017. 12. 20 版)	東海第二発電所 (2018. 9. 18 版)	島根原子力発電所 2号炉	備考
 <p data-bbox="154 1554 914 1627">添付第4. 2. 2-23 図 7号炉 原子炉建屋 (T.M.S.L. 18100) 施工対象範囲</p>		 <p data-bbox="2439 724 2478 1491">図 2-47 廃棄物処理建物地下2階 貫通部止水処置施工対象範囲</p>	

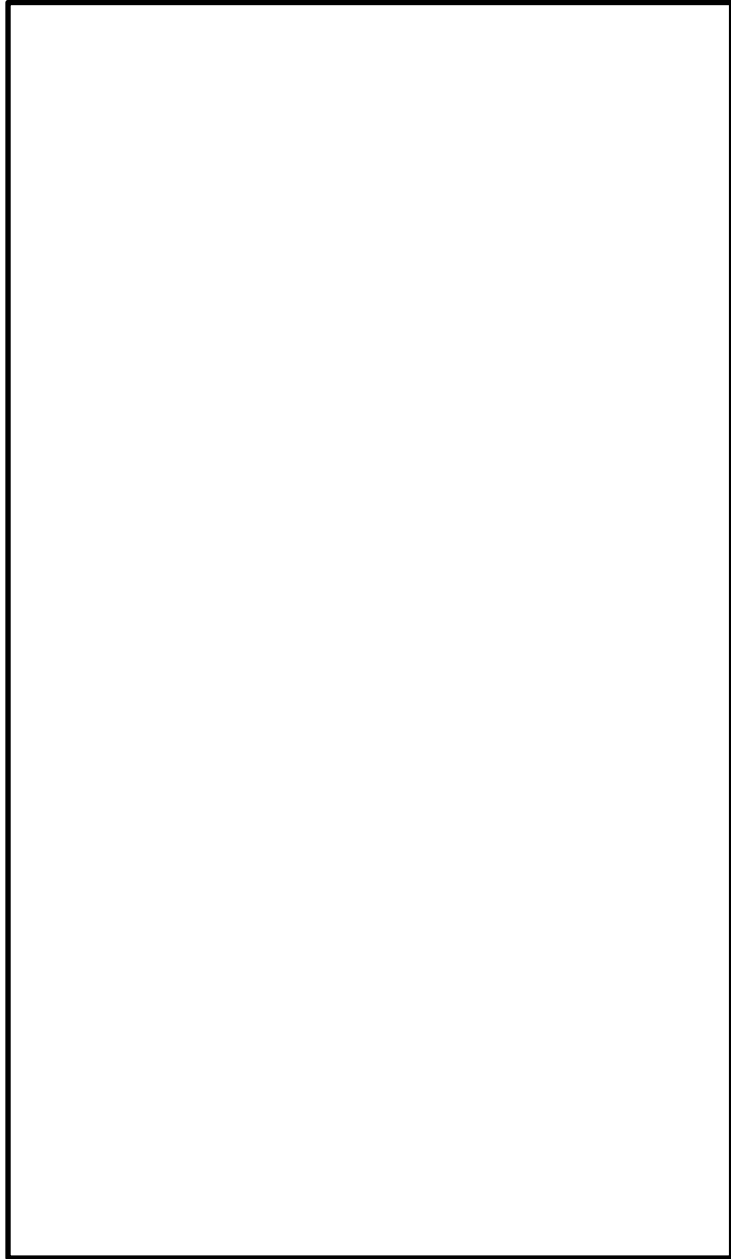
柏崎刈羽原子力発電所 6 / 7号炉 (2017. 12. 20 版)	東海第二発電所 (2018. 9. 18 版)	島根原子力発電所 2号炉	備考
 <p data-bbox="154 1554 914 1627">添付第4. 2. 2-24 図 7号炉 原子炉建屋 (T. M. S. L. 23500) 施工対象範囲</p>		 <p data-bbox="2427 724 2478 1501">図 2-48 廃棄物処理建物地下1階 貫通部止水処置施工対象範囲</p>	

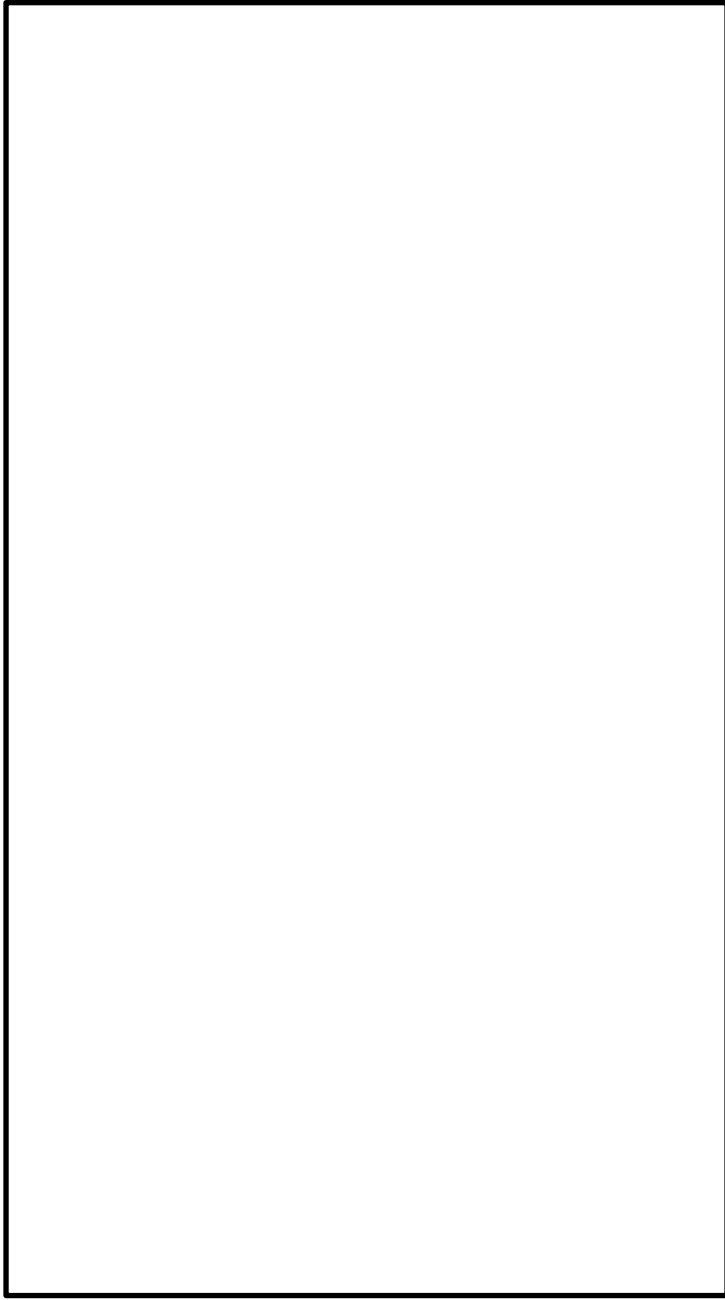

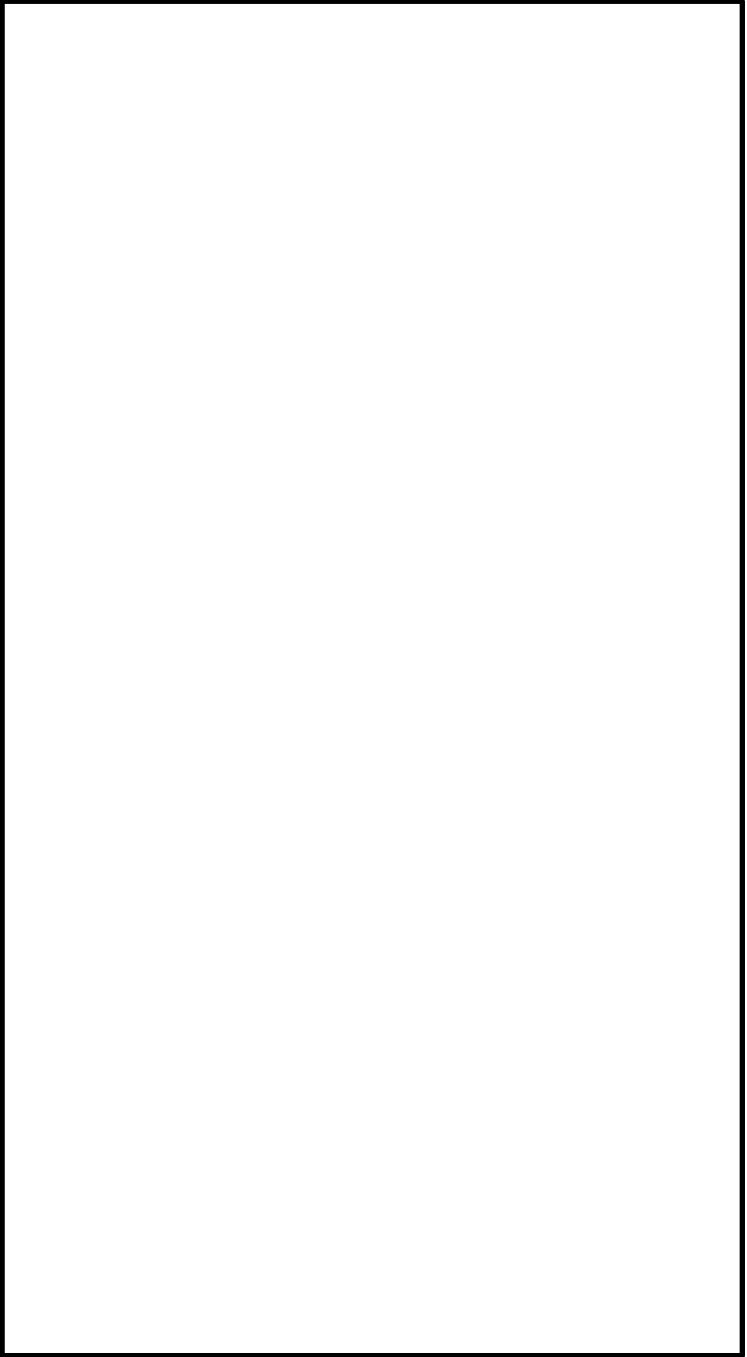
柏崎刈羽原子力発電所 6 / 7号炉 (2017. 12. 20 版)	東海第二発電所 (2018. 9. 18 版)	島根原子力発電所 2号炉	備考
 <p data-bbox="154 1507 914 1591">添付第4. 2. 2-25 図 7号炉 原子炉建屋 (T. M. S. L. 27200) 施工対象範囲</p>		 <p data-bbox="2427 575 2469 1373">図 2-49 廃棄物処理建物地下中 1階 貫通部止水処置施工対象範囲</p>	

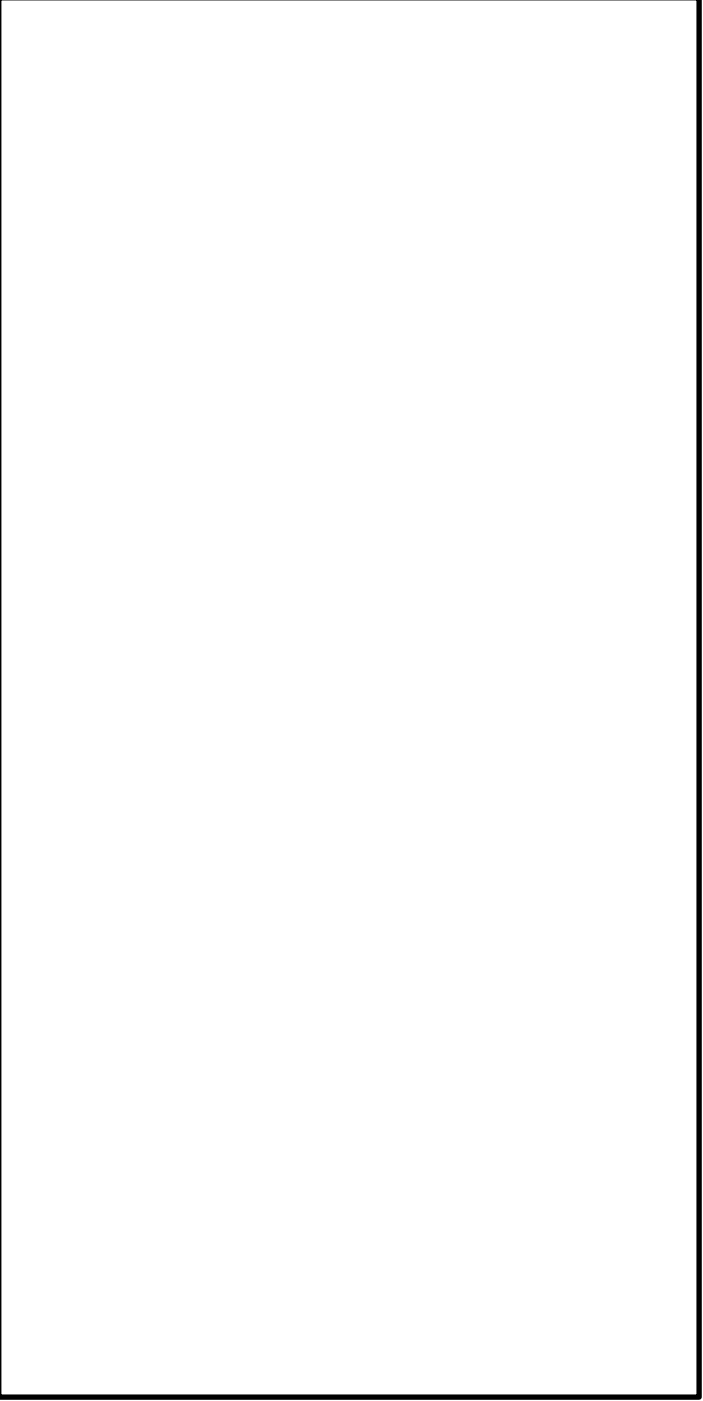

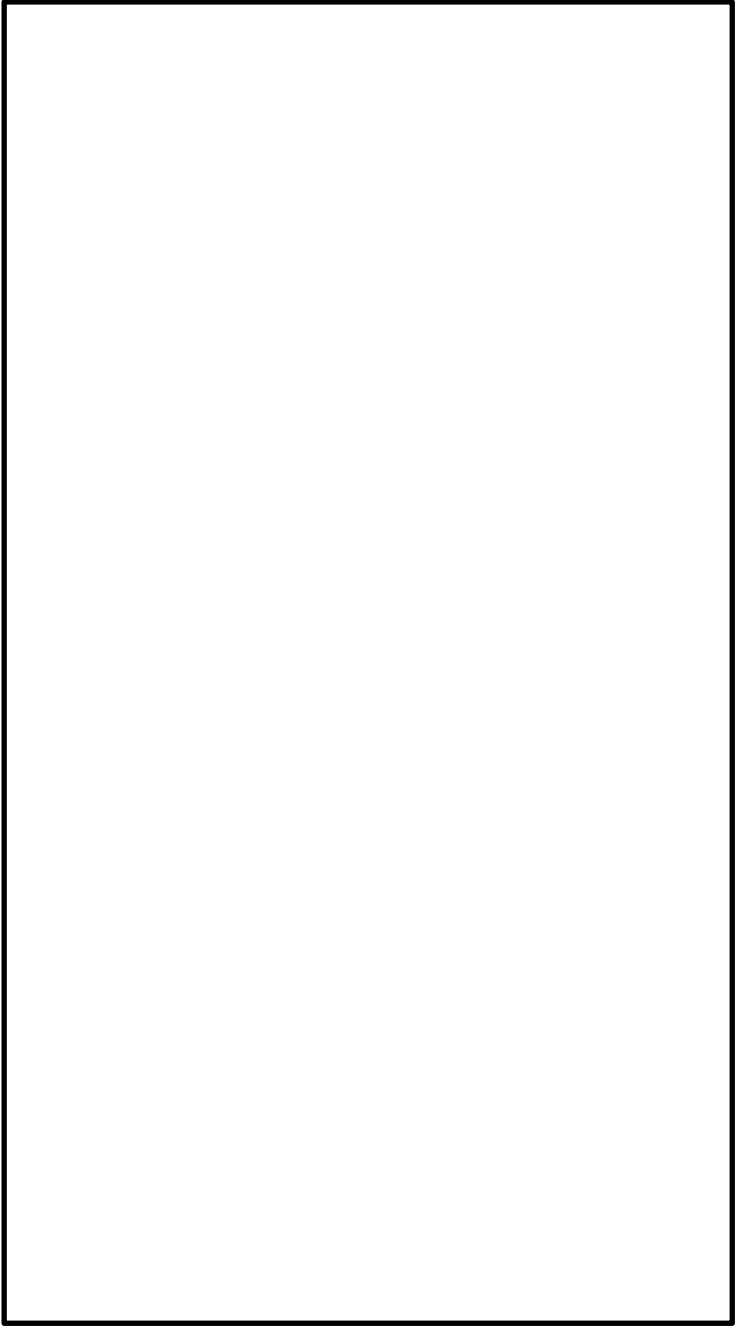
柏崎刈羽原子力発電所 6 / 7号炉 (2017. 12. 20 版)	東海第二発電所 (2018. 9. 18 版)	島根原子力発電所 2号炉	備考
 <p data-bbox="154 1646 914 1724">添付第4. 2. 2-26 図 7号炉 原子炉建屋 (T. M. S. L. 31700) 施工対象範囲</p>		 <p data-bbox="2448 810 2487 1528">図 2-50 廃棄物処理建物 1 階 貫通部止水処置施工対象範囲</p>	

柏崎刈羽原子力発電所 6 / 7号炉 (2017.12.20版)	東海第二発電所 (2018.9.18版)	島根原子力発電所 2号炉	備考
<p data-bbox="154 478 457 510">(4) <u>7号炉 タービン建屋</u></p>  <p data-bbox="154 1377 914 1451"><u>添付第4.2.2-27 図 7号炉 タービン建屋 (T.M.S.L.-5100) 施工対象範囲</u></p>		 <p data-bbox="2407 646 2436 1360" style="writing-mode: vertical-rl; text-orientation: upright;"><u>図 2-51 廃棄物処理建物 2階 貫通部止水処置施工対象範囲</u></p>	

柏崎刈羽原子力発電所 6 / 7号炉 (2017. 12. 20 版)	東海第二発電所 (2018. 9. 18 版)	島根原子力発電所 2号炉	備考
 <p data-bbox="151 1465 917 1543">添付第4.2.2-28 図 7号炉 タービン建屋 (T.M.S.L.-1100) 施工 対象範囲</p>		 <p data-bbox="2442 569 2481 1283">図 2-52 廃棄物処理建物 3階 貫通部止水処置施工対象範囲</p>	

柏崎刈羽原子力発電所 6 / 7号炉 (2017. 12. 20 版)	東海第二発電所 (2018. 9. 18 版)	島根原子力発電所 2号炉	備考
<div data-bbox="175 489 914 1276" data-label="Image"> </div> <div data-bbox="142 1325 923 1409" data-label="Caption"> <p>添付第4. 2. 2-29 図 7号炉 タービン建屋 (T.M.S.L. 4900) 施工対象範囲</p> </div>		<div data-bbox="1736 304 2427 1690" data-label="Image"> </div> <div data-bbox="2436 747 2475 1465" data-label="Caption"> <p>図 2-53 廃棄物処理建物 4階 貫通部止水処置施工対象範囲</p> </div>	

柏崎刈羽原子力発電所 6 / 7号炉 (2017. 12. 20 版)	東海第二発電所 (2018. 9. 18 版)	島根原子力発電所 2号炉	備考
 <p data-bbox="154 1507 917 1591">添付第4. 2. 2-30 図 7号炉 タービン建屋 (T.M.S.L. 12300) 施工 対象範囲</p>		 <p data-bbox="2427 850 2469 1564">図 2-54 廃棄物処理建物 5階 貫通部止水処置施工対象範囲</p>	

柏崎刈羽原子力発電所 6 / 7号炉 (2017. 12. 20 版)	東海第二発電所 (2018. 9. 18 版)	島根原子力発電所 2号炉	備考
 <p data-bbox="154 1644 917 1724">添付第4. 2. 2-31 図 7号炉 タービン建屋 (T. M. S. L. 20400) 施工 対象範囲</p>		 <p data-bbox="2445 953 2484 1619">図 2-55 制御室建物 1階 貫通部止水処置施工対象範囲</p>	

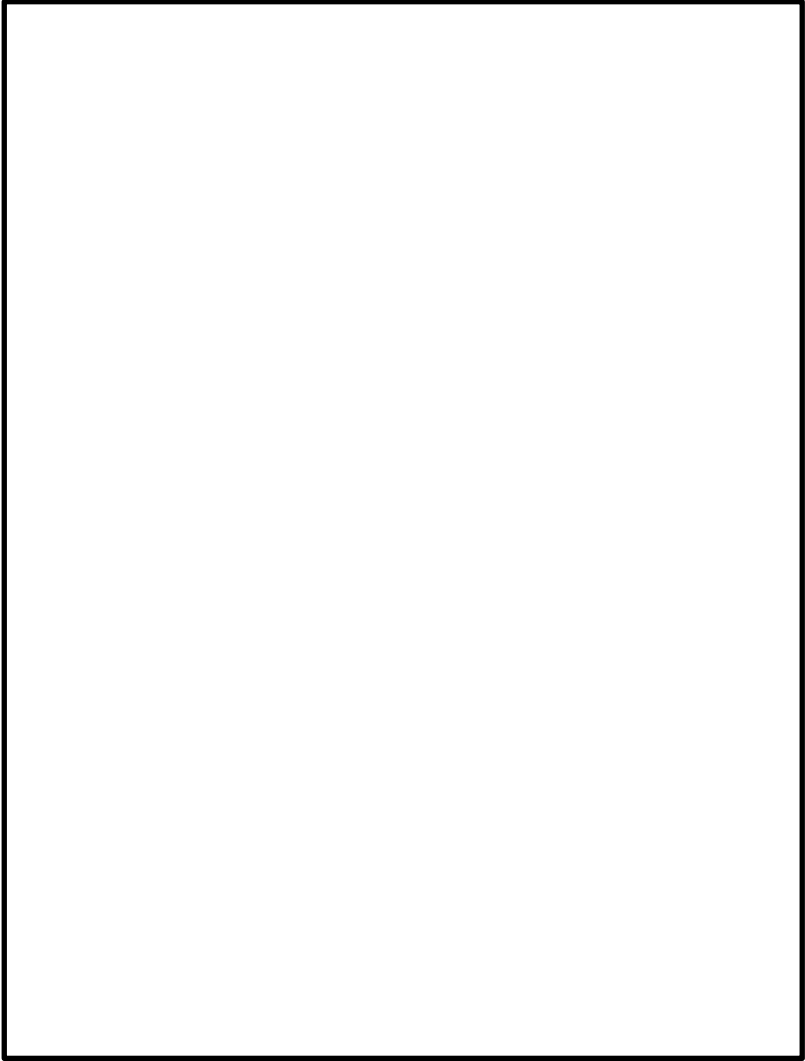
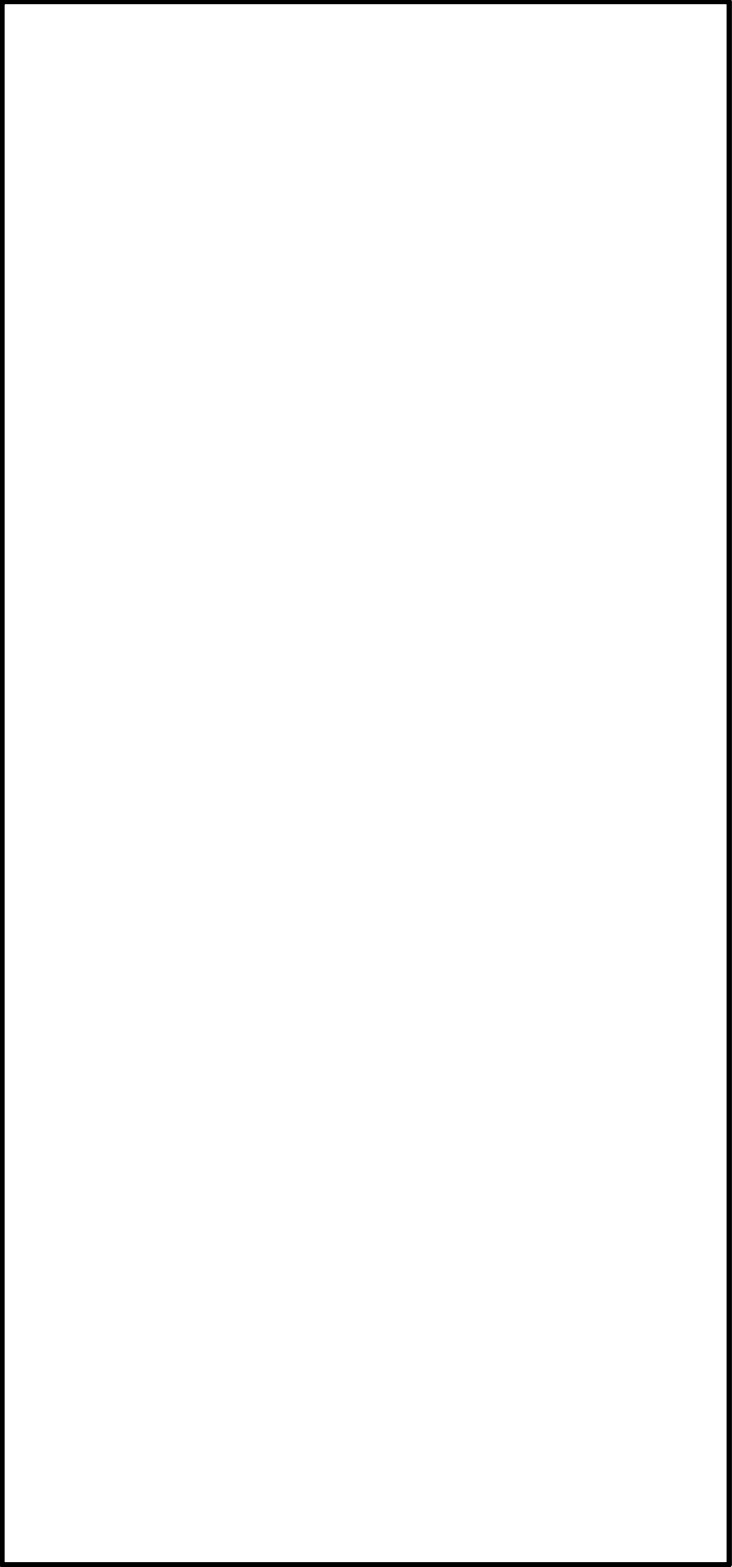
柏崎刈羽原子力発電所 6 / 7号炉 (2017.12.20版)	東海第二発電所 (2018.9.18版)	島根原子力発電所 2号炉	備考
<p data-bbox="151 478 537 510">(5) 6・7号炉 コントロール建屋</p>  <p data-bbox="151 1556 917 1587">添付第4.2.2-32 図 6・7号炉 コントロール建屋 (T.M.S.L.-2700)</p> <p data-bbox="454 1602 617 1633"><u>施工対象範囲</u></p>		 <p data-bbox="2457 909 2496 1598">図 2-56 制御室建物中2階 貫通部止水処置施工対象範囲</p>	

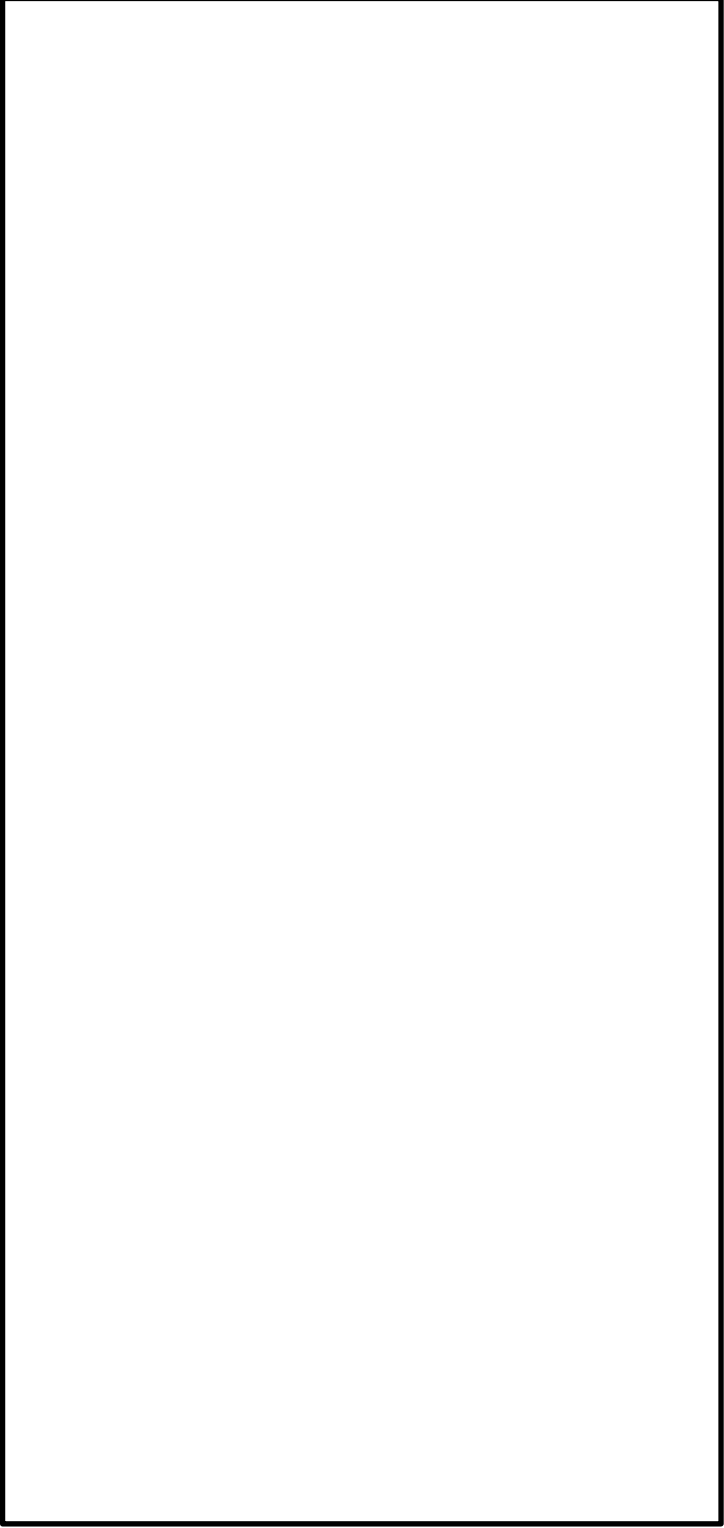
柏崎刈羽原子力発電所 6 / 7号炉 (2017. 12. 20 版)	東海第二発電所 (2018. 9. 18 版)	島根原子力発電所 2号炉	備考
 <p data-bbox="154 1648 914 1732">添付第4. 2. 2-33 図 6・7 号炉 コントロール建屋 (T. M. S. L. 1000) <u>施工対象範囲</u></p>		 <p data-bbox="2448 961 2478 1627">図 2-57 制御室建物 2 階 貫通部止水処置施工対象範囲</p>	

柏崎刈羽原子力発電所 6 / 7号炉 (2017.12.20版)	東海第二発電所 (2018.9.18版)	島根原子力発電所 2号炉	備考
<div data-bbox="151 514 914 1522" style="border: 1px solid black; height: 480px; width: 257px;"></div> <p data-bbox="151 1556 914 1587">添付第4.2.2-34 図 6・7号炉 コントロール建屋 (T.M.S.L.6500)</p> <p data-bbox="457 1602 617 1633"><u>施工対象範囲</u></p>		<div data-bbox="1754 338 2436 1751" style="border: 1px solid black; height: 673px; width: 230px;"></div> <p data-bbox="2457 825 2496 1486" style="writing-mode: vertical-rl; text-orientation: upright;">図 2-58 制御室建物3階 貫通部止水処置施工対象範囲</p>	

柏崎刈羽原子力発電所 6 / 7号炉 (2017. 12. 20 版)	東海第二発電所 (2018. 9. 18 版)	島根原子力発電所 2号炉	備考
<div data-bbox="154 512 914 1457" data-label="Image"> </div> <div data-bbox="142 1507 920 1591" data-label="Caption"> <p>添付第4.2.2-35 図 6・7号炉 コントロール建屋 (T.M.S.L.9500) <u>施工対象範囲</u></p> </div>		<div data-bbox="1736 344 2418 1797" data-label="Image"> </div> <div data-bbox="2448 898 2493 1562" data-label="Caption"> <p>図 2-59 <u>制御室建物 4 階 貫通部止水処置施工対象範囲</u></p> </div>	

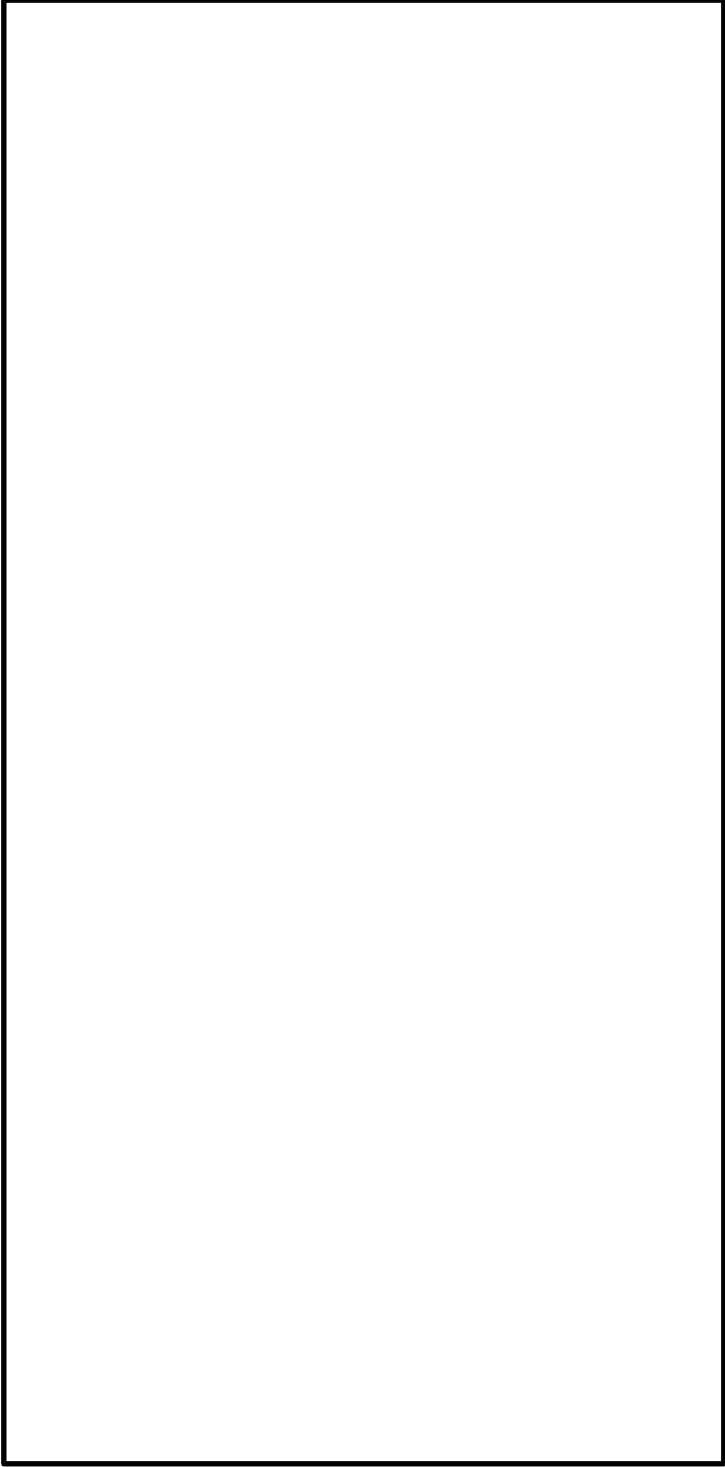
柏崎刈羽原子力発電所 6 / 7号炉 (2017. 12. 20 版)	東海第二発電所 (2018. 9. 18 版)	島根原子力発電所 2号炉	備考
 <p data-bbox="151 1507 917 1541">添付第4.2.2-36 図 6・7号炉 コントロール建屋 (T.M.S.L. 12300)</p> <p data-bbox="454 1556 614 1587">施工対象範囲</p>		 <p data-bbox="2436 814 2472 1373">図 2-60 取水槽 貫通部止水処 施工対象範囲</p>	

柏崎刈羽原子力発電所 6 / 7号炉 (2017.12.20版)	東海第二発電所 (2018.9.18版)	島根原子力発電所 2号炉	備考
<div data-bbox="166 512 914 1411" data-label="Image"> </div> <div data-bbox="142 1417 920 1453" data-label="Caption"> <p>添付第4.2.2-37 図 6・7号炉 コントロール建屋 (T.M.S.L.17300)</p> </div> <div data-bbox="439 1459 623 1501" data-label="Text"> <p><u>施工対象範囲</u></p> </div>		<div data-bbox="1745 302 2356 1503" data-label="Image"> </div> <div data-bbox="2415 651 2469 1297" data-label="Caption"> <p>図 2-61 排気筒エリア 貫通部止水処置施工対象範囲</p> </div>	

柏崎刈羽原子力発電所 6/7号炉 (2017.12.20版)	東海第二発電所 (2018.9.18版)	島根原子力発電所 2号炉	備考
<p>4.2.3 壁貫通部の止水対策の耐水圧性能及び地震時の健全性について</p> <p>壁貫通部については止水対策が必要となる箇所に対して、シーリング材及びモルタル施工を実施することとしており、これらの止水処置の耐水圧性能及び地震時の健全性を以下の通り確認している。</p> <p>(1) 貫通部シーリング材の耐水圧性能及び地震時の健全性</p> <p>①耐水圧性能について</p> <p>保守的な条件にて貫通部シーリング材の耐圧・漏水試験を実施しており、想定する浸水に対して十分な耐水圧性能を有することを確認している。</p>  <p>耐圧，漏水試験により，約0.2MPa（静水圧20m相当）以上の耐水圧性能を有することを確認</p> <p>添付第4.2.3-1 図 モックアップ概要</p> <p>②地震時の健全性</p> <p>壁貫通部を通る配管等の貫通物は同一建屋内の支持構造物により拘束されており、地震時は建屋と配管等が連動した振動となることから、シーリング材への影響は軽微であり、健全性が損なわれることは無いと考えられる。なお、建屋間を貫通する配管の貫通部止水処置については、地震時における建屋間の相対変位を考慮し、変位追従性に優れたラバーブーツを使用している。</p>			<p>(島根2号炉は「2.1.4 貫通部の止水対策の耐水圧性能及び地震時の健全性について」に記載)</p>

柏崎刈羽原子力発電所 6 / 7号炉 (2017. 12. 20 版)	東海第二発電所 (2018. 9. 18 版)	島根原子力発電所 2号炉	備考
<div data-bbox="172 373 890 619" data-label="Image"> </div> <p data-bbox="172 655 890 688">添付第4.2.3-2 図 建屋間を貫通する配管の貫通部止水処置例</p> <p data-bbox="151 745 706 779">(2) モルタルの耐水圧性能及び地震時の健全性</p> <p data-bbox="172 791 468 825">①水圧荷重に対する評価</p> <p data-bbox="151 835 914 913">以下にモルタルが静水圧に対して十分な耐性を有していることを評価した結果を示す。</p> <p data-bbox="181 970 320 1003">【検討条件】</p> <ul data-bbox="181 1014 890 1228" style="list-style-type: none"> ・スリーブ径：R (mm) ・モルタル充てん深さ：L (mm) ・配管径：r (mm) ・モルタル許容付着強度※：1.3 (N/mm²) ・静水圧：0.2 (N/mm²) (保守的に20m 相当の静水圧を想定) <p data-bbox="172 1239 816 1272">※「鉄筋コンクリート構造計算規準・同解説」による。</p> <p data-bbox="181 1329 676 1362">i モルタル部分に作用する水圧荷重 (P1)</p> <p data-bbox="151 1373 914 1451">静水圧がモルタル部分に作用したときに生じる荷重は以下のとおり。</p> $P1[N]=0.2[N/mm^2] \times (\pi/4 \times R^2) [mm^2]$ <p data-bbox="181 1598 569 1631">ii モルタルの許容付着荷重 (P2)</p> <p data-bbox="151 1642 914 1719">静水圧がモルタル部分に作用したときに、モルタルが耐える限界の付着荷重は以下のとおり。</p> $P2[N]=1.3[N/mm^2] \times (\pi \times (R+r) \times L) [mm^2]$			

柏崎刈羽原子力発電所 6/7号炉 (2017.12.20版)	東海第二発電所 (2018.9.18版)	島根原子力発電所 2号炉	備考
<p>モルタルの付着強度は、付着面積及び充てん深さに比例するため、ここでは、保守的に貫通部に配管がない状態 (r=0) を評価する。</p> $P2[N]=1.3 [N/mm^2] \times (\pi \times R \times L) [mm^2]$ <p>静水圧に対して水密性を確保するためには、$P1 < P2$ である必要があるため、以下のように整理できる。</p> $0.04 \times R[mm] \leq L[mm]$ <p>上式より、モルタル施工箇所が水密性能を発揮するためには、貫通スリーブ径の4%以上の長さの充てんが必要になる。主要なスリーブ径は100A~600A であり、600A の場合の必要充てん厚さは約25mm となる。モルタルは壁厚さと同程度施工されており、モルタル施工のスリーブがある壁は30mm 以上の厚さを有していることから、主要なモルタル充てん箇所は十分な水密性能を確保していると評価できる。なお、例外的に600A を超えるものについては個別にモルタル充てん厚さが貫通スリーブ径の4%以上になることを確認している。</p>  <p>添付第4.2.3-3 図 モルタル施工箇所概念図</p> <p>②配管反力に対する試算結果例</p> <p>Ss地震時に配管に発生する荷重とモルタルの圧縮許容荷重及び付着許容荷重について、最大口径配管を代表ケースとして比較し、圧縮・付着ともに許容荷重以下になることを確認</p>			

柏崎刈羽原子力発電所 6 / 7号炉 (2017. 12. 20 版)	東海第二発電所 (2018. 9. 18 版)	島根原子力発電所 2号炉	備考																
<p>している。</p> <p>添付第4.2.3-1 表 配管反力と許容荷重</p> <table border="1" data-bbox="157 394 914 527"> <thead> <tr> <th rowspan="2">配管径</th> <th rowspan="2">壁厚</th> <th colspan="2">モルタル圧縮評価</th> <th colspan="2">モルタル付着評価</th> </tr> <tr> <th>発生荷重</th> <th>許容荷重^{※1}</th> <th>発生荷重</th> <th>許容荷重^{※2}</th> </tr> </thead> <tbody> <tr> <td>850A</td> <td>1100mm</td> <td>1182kN</td> <td>10164kN</td> <td>2364kN</td> <td>3879kN</td> </tr> </tbody> </table> <p>※1 モルタル圧縮強度×配管投影面積より ※2 モルタル付着強度×モルタル付着面積より</p> <p>4.2.4 溢水防護対策に用いる材料の選定について 溢水防護対策に用いる材料の選定にあたっては、火災防護上、火災荷重を可能な限り低減させる配慮を行っている。具体的には、配管貫通部やケーブルトレイ貫通部、水密扉やハッチ、堰の止水に用いるシール材には難燃性のシリコーンシール材を選定することとしている。</p>	配管径	壁厚	モルタル圧縮評価		モルタル付着評価		発生荷重	許容荷重 ^{※1}	発生荷重	許容荷重 ^{※2}	850A	1100mm	1182kN	10164kN	2364kN	3879kN			<p>(島根2号炉は「2.1.3 溢水防護対策に用いる材料の選定について」に記載)</p>
配管径			壁厚	モルタル圧縮評価		モルタル付着評価													
	発生荷重	許容荷重 ^{※1}		発生荷重	許容荷重 ^{※2}														
850A	1100mm	1182kN	10164kN	2364kN	3879kN														

柏崎刈羽原子力発電所 6 / 7号炉 (2017.12.20版)	東海第二発電所 (2018.9.18版)	島根原子力発電所 2号炉	備考
		<p><u>2.3 内部流体漏えい対策について</u></p> <p>2.3.1 はじめに</p> <p>本資料は地震時の内部流体漏えい対策として実施する以下の(1)～(4)について説明するものである。</p> <p>(1) 主蒸気隔離弁漏えい制御系の撤去 (2) 大型タンク遮断弁の設置 (3) 循環水ポンプ停止及び循環水系弁閉止インターロックの設置 (4) 燃料プール冷却系弁閉止インターロックの設置</p> <p>2.3.2 対策内容</p> <p>(1) 主蒸気隔離弁漏えい制御系の撤去</p> <p>主蒸気隔離弁漏えい制御系は、事故時主蒸気隔離弁からの漏えい蒸気を抑制するため設けているがシート性能が向上した主蒸気隔離弁を採用しており、主蒸気隔離弁の後備設備として設置しておく必要性がなくなったことから、地震時の内部流体漏えい対策として、当該系統の撤去を行う。</p> <p>a. 系統概要</p> <p>主蒸気隔離弁漏えい制御系は、主蒸気隔離弁の下流側の主蒸気管に設ける主蒸気第3弁と、漏えい蒸気を各主蒸気隔離弁及び主蒸気第3弁間からサブプレッション・プール水中に導く配管系及び原子炉棟に導く配管系で構成する。系統概要図を図2-62に示す。</p> <p>主蒸気第3弁の下流側における主蒸気管破断事故時、主蒸気管流量大又は主蒸気管周囲温度高の信号による主蒸気隔離弁閉等の信号を確認した後、本系統を手動にて作動させ主蒸気隔離弁からの漏えい蒸気をサブプレッション・プール水中に排出し、プール水中で凝縮することによって、破断口への蒸気の漏えいを制御することができる。冷却材喪失事故時には、主蒸気隔離弁からの漏えい蒸気を原子炉棟内に導き、非常用ガス処理系にて処理することができる。</p>	<p>・島根2号炉はその他の内部流体漏えい対策を記載</p> <p>【柏崎6/7, 東海第二】</p>



図 2-62 主蒸気隔離弁漏えい制御系系統概要図

b. 撤去範囲

主蒸気隔離弁漏えい制御系の機能のみを有する範囲についてその他の既設設備へ影響のない範囲で撤去する。ただし、既設設備への影響を考慮し、主蒸気隔離弁漏えい制御系以外の機能も有する範囲については、表 2-7 に示すとおり、今後も維持する。また、機能廃止範囲を図 2-63 に示す。

表 2-7 今後も維持する範囲

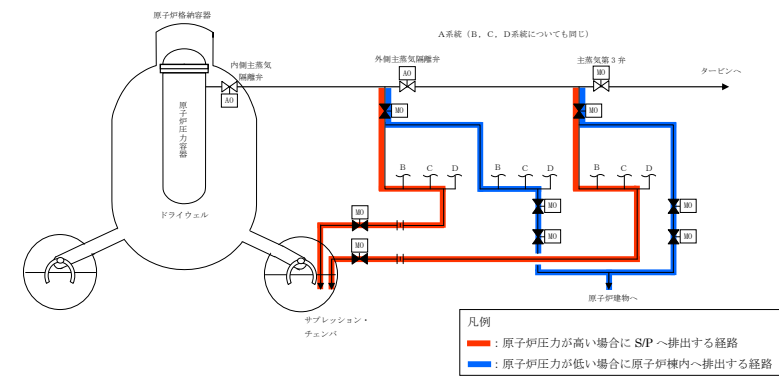
維持する範囲	機能概要
主蒸気第 3 弁	主蒸気管の機器クラスを当該弁により区分する。具体的にはクラス 2 機器とクラス 3 機器を区分する。
主蒸気隔離弁内側及び外側間に設置されているサブプレッション・プールへのベントライン	プラント停止時における主蒸気管の水抜きのため、ドレンラインとして活用する。



図 2-63 主蒸気隔離弁漏えい制御系の機能廃止範囲

柏崎刈羽原子力発電所 6 / 7号炉 (2017.12.20版)	東海第二発電所 (2018.9.18版)	島根原子力発電所 2号炉	備考
		<p>c. 撤去理由</p> <p>主蒸気隔離弁漏えい制御系は、主蒸気管破断事故時等に主蒸気隔離弁からの漏えい蒸気を制御するため設置したものである。島根2号炉では、シート性能が向上した主蒸気隔離弁を採用しているため、主蒸気隔離弁の漏えい率検査では、判定基準に対し十分低い漏えい率であることを確認しており、主蒸気隔離弁が高い信頼性を有していることから、主蒸気隔離弁漏えい制御系は主蒸気隔離弁の後備設備として設置しておく必要性がなくなっている。</p> <p>このため、通常運転時に地震等が発生し、本系統配管の破損による蒸気や放射性物質の漏えいリスク低減のために主蒸気隔離弁漏えい制御系を撤去する。</p> <p>(a) 主蒸気隔離弁のシート性能向上</p> <p>島根2号炉の主蒸気隔離弁は、漏えいリスク低減を考慮した改良型を採用している。改良型とは、弁座シート面と弁体が安定して接触するように従来型から弁体の上部ガイド径を縮小することで、シート性能を向上させている。図2-64に主蒸気隔離弁の全体図、図2-65に弁体の改良内容の概略説明を示す。</p> <div data-bbox="1745 1171 2496 1801" style="border: 1px solid black; height: 300px; width: 100%;"></div> <p style="text-align: center;">図2-64 主蒸気隔離弁全体図</p>	

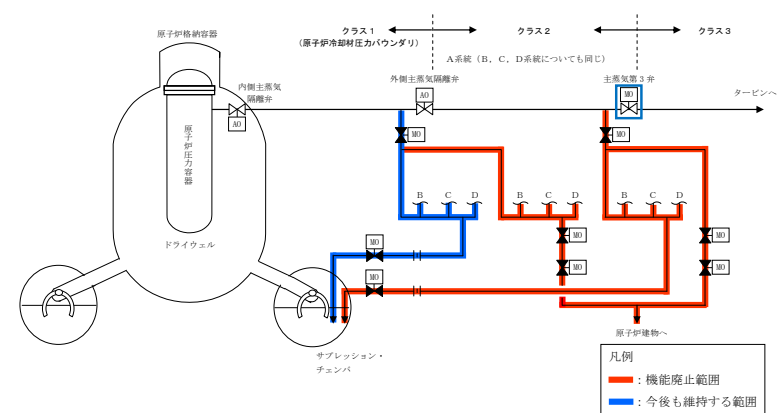

図 2-65 弁体の改良内容の概略説明

(b) 主蒸気隔離弁漏えい率試験

島根 2号炉の主蒸気隔離弁漏えい率試験（全8弁：内側4弁，外側4弁）の結果を図 2-66 に示す。判定基準 10%/day 以下に対し，漏えい率は十分低い結果となっている。

島根2号炉 主蒸気隔離弁(内側弁)漏えい率

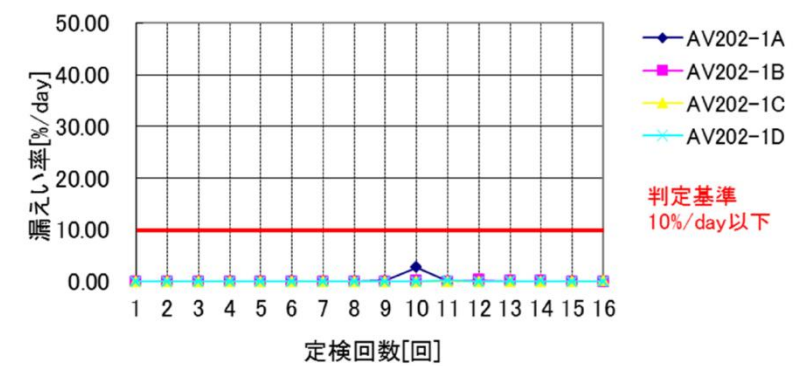

島根2号炉 主蒸気隔離弁(外側弁)漏えい率



図 2-66 島根 2号炉 主蒸気隔離弁漏えい率

柏崎刈羽原子力発電所 6 / 7号炉 (2017.12.20版)	東海第二発電所 (2018.9.18版)	島根原子力発電所 2号炉	備考
		<p>(2) 大型タンク遮断弁の設置</p> <p>a. 概要</p> <p>地震によって屋外の大型タンク及び配管が破損せず、大型タンクに接続する系統が地震時に建物内で破損した場合、大型タンク内の保有水が流入することにより、溢水防護対象設備が機能喪失に至るおそれがある。このため、大型タンク遮断弁（以下「遮断弁」という。）及び地震時に遮断弁を閉止するインターロックを設置し、図 2-67 に示す大型タンクについて建物内への流入を低減する。</p> <p>なお、大型タンク遮断弁を設置する復水貯蔵タンク等は重大事故等対処設備の水源として期待していない。</p> <div data-bbox="1736 756 2478 1354" style="border: 1px solid black; height: 285px; width: 250px; margin: 10px auto;"></div> <p>図 2-67 建物内への流入を抑制する大型タンク</p> <p>b. 遮断弁について</p> <p>大型タンク毎の遮断弁の系統構成を図 2-68 に、遮断弁の設置例を図 2-69 に示す。復水貯蔵タンク及び補助復水貯蔵タンクについては制御棒駆動系等への供給水源であること、ろ過水タンクについては消火活動の際の供給水源であることから、当該タンクの遮断弁については単一故障を考慮し多重化を図っている。多重化された遮断弁の電源は、電源区分を分離する。遮断弁及び遮断弁から上流側の建物境界部までの配管は基準地震動 Ss による地震力に対して機能維持する設計とする。</p> <p>なお、復水貯蔵タンクの遮断弁は、非常用炉心冷却系の配管</p>	

には設置せず、常用系の配管にのみ設置する。

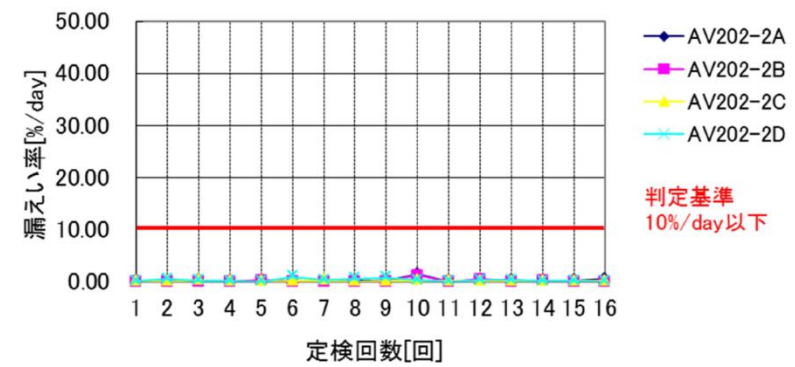
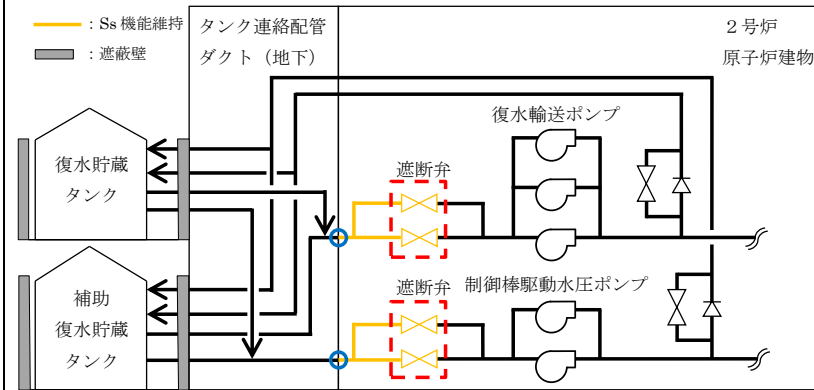

(1) 復水貯蔵タンク及び補助復水貯蔵タンクの遮断弁の系統構成

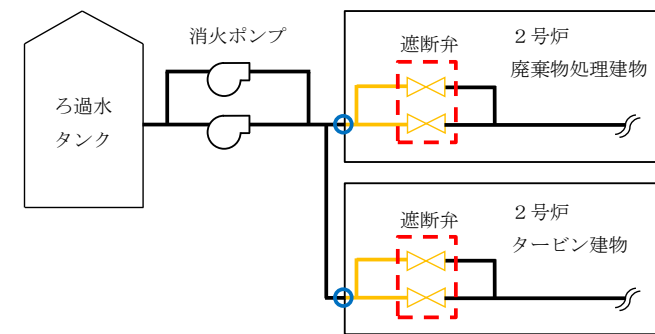

(2) ろ過水タンクの遮断弁の系統構成

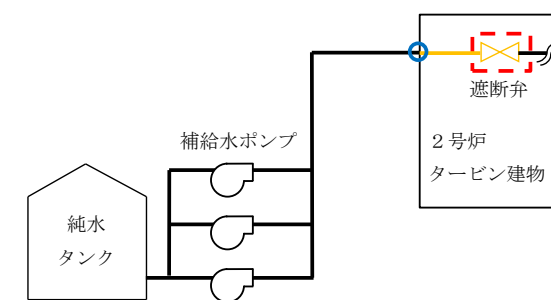

(3) 純水タンクの遮断弁の系統構成

○ : 建物境界の貫通部止水処置がシリコンの場合は、建物外の2方向拘束点まで、モルタルの場合は、モルタルが2方向拘束点となるため建物境界までを Ss 機能維持

図 2-68 大型タンク遮断弁の系統構成

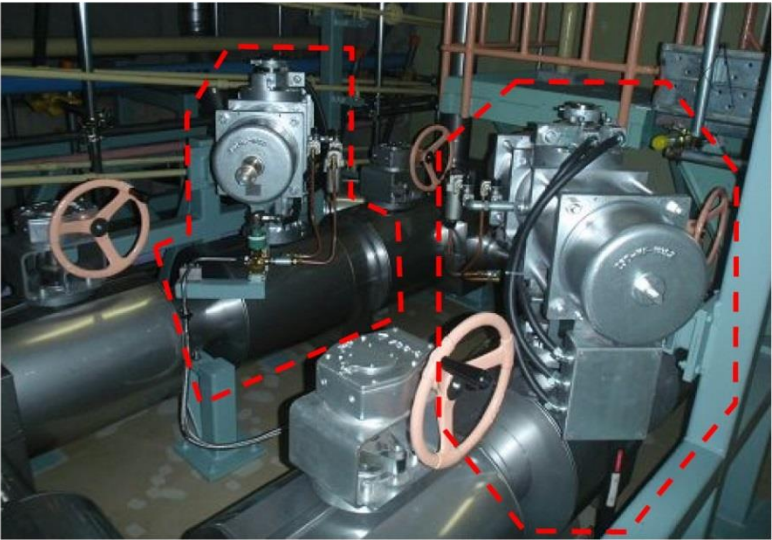
柏崎刈羽原子力発電所 6 / 7号炉 (2017. 12. 20 版)	東海第二発電所 (2018. 9. 18 版)	島根原子力発電所 2号炉	備考
		 <p data-bbox="1733 835 2496 867">図 2-69 遮断弁の設置例(消火系配管 2号炉 廃棄物処理建物)</p> <p data-bbox="1733 972 2169 1003">c. 遮断弁のインターロックについて</p> <p data-bbox="1789 1014 2496 1045">図 2-70 に示すように、地震大信号により遮断弁を閉止する。</p> <div data-bbox="1733 1066 2504 1129" style="border: 1px solid black; padding: 5px; display: flex; align-items: center;"> <div style="border: 1px solid black; padding: 2px 10px; margin-right: 10px;">地震大</div> <div style="flex-grow: 1; border-bottom: 1px solid black; position: relative;"> <div style="position: absolute; right: -10px; top: -5px;">→</div> </div> <div style="border: 1px solid black; padding: 2px 10px;">大型タンク遮断弁閉止</div> </div> <p data-bbox="1902 1150 2332 1182">図 2-70 遮断弁閉止インターロック</p>	

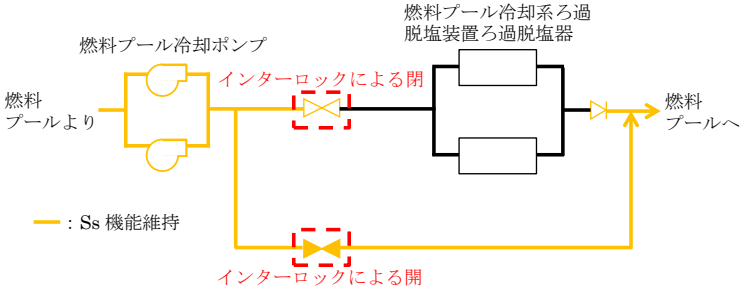
柏崎刈羽原子力発電所 6 / 7号炉 (2017.12.20版)	東海第二発電所 (2018.9.18版)	島根原子力発電所 2号炉	備考
		<p>(3) 循環水ポンプ停止及び循環水系弁閉止インターロックの設置 地震時に復水器エリア内の伸縮継手部が破損した場合に備えてインターロックを設置している (本文 9.1.1 (2)参照)。</p> <p>(4) 燃料プール冷却系弁閉止インターロックの設置</p> <p>a. 概要 地震時に燃料プール冷却系のうち、ろ過脱塩装置ろ過脱塩器周りからの溢水影響を低減させるために、図 2-71 に示す燃料プール冷却系ろ過脱塩装置入口弁の閉止を行うインターロックを設置する。当該弁を含むろ過脱塩装置ろ過脱塩器周り以外の範囲は基準地震動 S_s による地震力に対して機能維持する設計とする。</p>  <p>図 2-71 燃料プール冷却系インターロック設置概要図</p>	

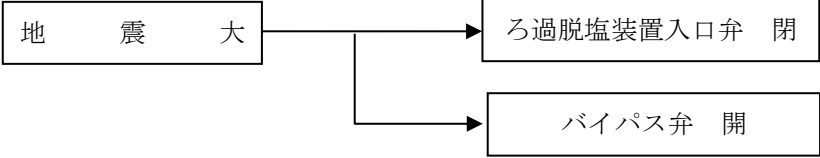
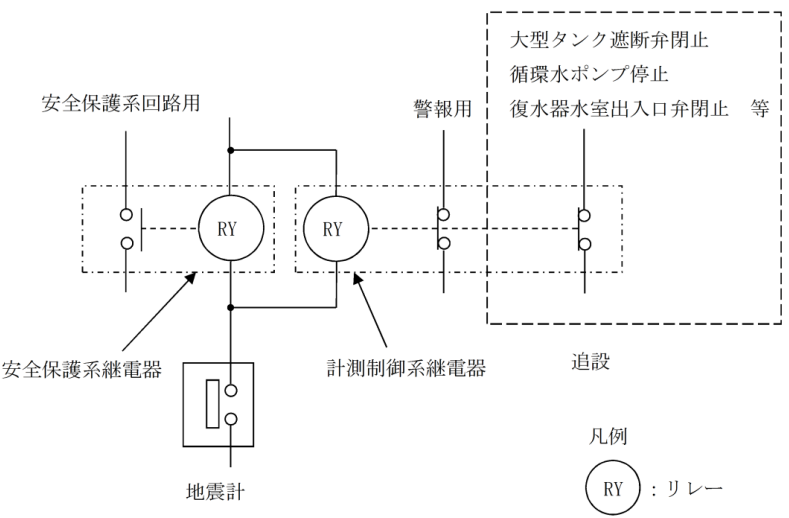
柏崎刈羽原子力発電所 6 / 7号炉 (2017. 12. 20 版)	東海第二発電所 (2018. 9. 18 版)	島根原子力発電所 2号炉	備考
		<p>b. インターロックについて 図 2-72 に示すように、地震大信号により弁を閉止又は開する。</p>  <p>図 2-72 弁開閉インターロック</p> <p>2.3.3 既設回路への影響について 2.3.3.1 安全保護系と計測制御系の分離 大型タンク遮断弁閉止，循環水ポンプ停止及び循環水系弁閉止，並びに燃料プール冷却系弁閉止インターロックは，計測制御系（常用系）の信号にて設計している。ただし，検出部である地震計は安全保護系と共用しているが，地震計からの「地震大」信号は，図 2-73 に示すように継電器にて安全保護系と計測制御系を電氣的に分離しており，計測制御系統側で短絡，地絡等の故障が生じた場合でも安全保護系側にその影響を与えない設計としている。したがって，「設置許可基準規則」第二十四条第一項第七号『計測制御系統施設の一部を安全保護回路と共用する場合には、その安全保護機能を失わないよう、計測制御系統施設から機能的に分離されたものとする。』を満足している。</p>  <p>図 2-73 「地震大」信号の分岐方法</p>	

柏崎刈羽原子力発電所 6 / 7号炉 (2017.12.20版)	東海第二発電所 (2018.9.18版)	島根原子力発電所 2号炉	備考
		<p>2.3.3.2 安全解析への影響</p> <p>(1) 主蒸気隔離弁漏えい制御系の撤去 主蒸気隔離弁漏えい制御系は、設計基準事故「原子炉冷却材喪失」及び「主蒸気管破断」時に、閉止した主蒸気隔離弁を通してタービン建物へ流入する蒸気漏えい量の低減を目的に設置しているが、安全解析ではその効果を考慮していない。このため、主蒸気隔離弁漏えい制御系の撤去による安全解析への影響はない。</p> <p>(2) 大型タンク遮断弁の設置 大型タンク遮断弁及び地震時に弁を閉止するインターロックを設置し、建物内への大型タンク保有水の流入を抑制することとしているが、大型タンク遮断弁を設置する系統は、安全解析で想定する事象に対処するための安全機能に該当しない。このため、大型タンク遮断弁の設置による安全解析への影響はない。</p> <p>(3) 循環水ポンプ停止及び循環水系弁閉止インターロックの設置 本インターロックの設置により、誤動作した場合には復水器の真空が低下しタービントリップに伴う原子炉圧力の上昇に至る可能性があるが、「負荷の喪失（発電機負荷遮断、タービンバイパス弁不作動）」事象よりも圧力上昇が緩慢であることから厳しい結果とはならず、本インターロックの設置による安全解析への影響はない。</p> <p>(4) 燃料プール冷却系弁閉止インターロックの設置 本インターロックを設置し溢水影響を低減させることとしているが、燃料プール冷却系は、安全解析で想定する事象に対処するための安全機能に該当しない。このため、本インターロックの設置による安全解析への影響はない。</p>	

柏崎刈羽原子力発電所 6 / 7号炉 (2017.12.20版)	東海第二発電所 (2018.9.18版)	島根原子力発電所 2号炉	備考
	<p style="text-align: right;">添付資料-5</p> <p style="text-align: center;">想定破損による評価結果について</p> <p>6. <u>の想定破損評価方針より実施した評価内容の溢水源、最終滞留区画及びその最終滞留水位について第1表に、評価において考慮した区画分離図を第1図に示す。没水による防護対象設備の機能維持の確認及びプラントの安全機能維持が確保されていることを確認した結果を第2表に示す。</u></p> <p><u>また、被水における各防護対象機器の影響結果を第3表に示す。</u></p>	<p>添付資料5 <u>想定破損による溢水影響評価について</u></p> <p>1. <u>想定破損による没水影響評価結果まとめ</u> <u>想定破損による没水影響評価結果を表1-1に示す。</u></p> <p>2. <u>想定破損による被水影響評価結果まとめ</u> <u>想定破損による被水影響評価結果を表2-1に示す。</u></p> <p>3. <u>想定破損による蒸気影響評価結果まとめ</u> <u>想定破損による蒸気影響評価結果を表3-1及び蒸気源有無の全体概略図を図3-1に示す。</u></p>	

第1表 想定破損による没水影響評価まとめ(1/7)

発生区画	区画分離	想定破損系統(総水量最大系統部)	区画内系統 想定破損系統(総水量最大系統部)	溢水量 ^{※1} (m ³)	系統略称	最終滞留エリア	最終滞留水位 ^{※2} (m)	他区画への影響
RB-6-1	西側エリア		原子炉補機供給系	298	RCV	西側サンプ	1.54	東側エリアへの伝播影響無し。
			原子炉補機供給系	33	FP			
RB-5-1	東側エリア		原子炉補機供給系	127	MUV	東側サンプ	3.9	西側エリアへの伝播影響無し。
			原子炉補機供給系	298	RCV			
RB-5-2	西側エリア		原子炉補機供給系	144	MUV	西側サンプ	1.54	東側エリアへの伝播影響無し。
			原子炉補機供給系	33	FP			
RB-5-3	西側エリア		原子炉補機供給系	298	DHC(RCV)	西側サンプ	1.54	東側エリアへの伝播影響無し。
			原子炉補機供給系	298	DHC(RCV)			
RB-5-4	西側エリア		原子炉補機供給系	22	SLC	西側サンプ	1.54	東側エリアへの伝播影響無し。
			原子炉補機供給系	124	MUV			
RB-5-5	西側エリア		原子炉補機供給系	298	DHC(RCV)	西側サンプ	1.54	東側エリアへの伝播影響無し。
			原子炉補機供給系	0	—			
RB-5-6	西側エリア		原子炉補機供給系	133	MUV	西側サンプ	0.69	東側エリアへの伝播影響無し。
			原子炉補機供給系	54	CUW			
RB-5-7	西側エリア		原子炉補機供給系	0	—	—	—	—
			原子炉補機供給系	—	—			
RB-5-8	西側エリア		原子炉冷却貯蔵系	54	CUW	西側サンプ	0.28	東側エリアへの伝播影響無し。
			原子炉冷却貯蔵系	54	CUW			
RB-5-9	西側エリア		原子炉冷却貯蔵系	0	—	—	—	—
			原子炉冷却貯蔵系	—	—			
RB-5-10	西側エリア		原子炉冷却貯蔵系	133	MUV	東側サンプ	1.74	西側エリアへの伝播影響無し。
			原子炉冷却貯蔵系	83	FPC			
RB-5-11	東側エリア		原子炉冷却貯蔵系	133	MUV	東側サンプ	1.74	西側エリアへの伝播影響無し。
			原子炉冷却貯蔵系	0	—			
RB-5-12	東側エリア		原子炉冷却貯蔵系	133	MUV	—	—	—
			原子炉冷却貯蔵系	0	—			
RB-5-13	東側エリア		原子炉冷却貯蔵系	138	MUV	東側サンプ	1.81	西側エリアへの伝播影響無し。
			原子炉冷却貯蔵系	0	—			
RB-5-14	西側エリア		原子炉冷却貯蔵系	0	—	—	—	—
			原子炉冷却貯蔵系	—	—			
RB-5-15	西側エリア		原子炉冷却貯蔵系	298	RCV	東側サンプ	3.9	西側エリアへの伝播影響無し。
			原子炉冷却貯蔵系	298	DHC(RCV)			
RB-4-1	東側エリア		原子炉冷却貯蔵系	83	FPC	東側サンプ	—	—
			原子炉冷却貯蔵系	298	RCIC			
			原子炉冷却貯蔵系	190	RHRA	—	—	—
			原子炉冷却貯蔵系	33	FP			
			原子炉冷却貯蔵系	144	MUV			

・没水影響評価結果まとめは作成していない
【東海第二】

第1表 想定破損による没水影響評価まとめ(2/7)

発生区画	区分分種	想定破損系統(注水量最大黒仲部)	注水量 ²¹ (m ³)	系統名称	最終滞留エリア	最終滞留水位 ²² (m)	他区画への影響
RB-4-2	西側エリア	ドライウエル冷却系(原子炉補機冷却系)	298	DHC(RCW)	西側サンプ	1.54	東側エリアへの 伝播影響無し。
		原子炉補機冷却系	267	RCW			
		復水・海水移送系	154	MUW			
		原子炉冷却系	33	FP			
RB-4-3	東側エリア	原子炉冷却系(復水・海水移送系)	128	CLW	東側サンプ	4.23	西側エリアへの 伝播影響無し。
		残留冷却系(海水)	99	RHRS(B)			
		残留冷却系(海水)	324	RHRA)			
		燃料プール冷却系	83	FPC			
RB-4-4	西側エリア	無し	0	無し	無し	無し	無し
RB-4-5	西側エリア	燃料プール冷却系	83	FPC	西側サンプ	0.43	東側エリアへの 伝播影響無し。
RB-4-6	東側エリア	燃料プール冷却系	83	FPC	東側サンプ	1.09	西側エリアへの 伝播影響無し。
RB-4-7	東側エリア	燃料プール冷却系	83	FPC	東側サンプ	1.09	西側エリアへの 伝播影響無し。
RB-4-8	東側エリア	燃料プール冷却系	無し	無し	無し	無し	無し
RB-4-9	東側エリア	燃料プール冷却系	83	FPC	東側サンプ	1.09	西側エリアへの 伝播影響無し。
RB-4-10	東側エリア	無し	0	無し	無し	無し	無し
RB-4-11	西側エリア	原子炉補機冷却系	267	RCW	西側サンプ	1.38	東側エリアへの 伝播影響無し。
RB-4-12	西側エリア	原子炉補機冷却系	54	CLW	無し	無し	無し
RB-4-13	東側エリア	無し	0	無し	無し	無し	無し
RB-4-14	東側エリア	無し	0	無し	無し	無し	無し
RB-4-15	東側エリア	原子炉補機冷却系	298	RCW	東側サンプ	3.9	西側エリアへの 伝播影響無し。
		原子炉冷却系	83	FPC			
RB-4-16	東側エリア	原子炉補機冷却系	54	CLW	無し	無し	無し
RB-4-17	東側エリア	原子炉補機冷却系	298	RCW	東側サンプ	3.9	西側エリアへの 伝播影響無し。
RB-4-18	東側エリア	復水・海水移送系	154	MUW	東側サンプ	3.9	西側エリアへの 伝播影響無し。
RB-4-19	東側エリア	原子炉補機冷却系	267	RCW	東側サンプ	3.49	西側エリアへの 伝播影響無し。
RB-4-20	東側エリア	燃料プール冷却系	83	FPC	無し	無し	無し
RB-4-21	東側エリア	無し	0	無し	無し	無し	無し
RB-4-22	東側エリア	屋内排水系	33	FP	東側サンプ	0.44	西側エリアへの 伝播影響無し。
RB-4-23	東側エリア	復水・海水移送系	130	MUW	東側サンプ	1.7	西側エリアへの 伝播影響無し。

第1表 想定破損による没水影響評価まとめ(3/7)

発生区画	区画分層	区内系統 想定破損系統(注水量最大点部)	注水量 ⁹¹ (m ³)	系統名称	最終滞留エリア	最終滞留水位 ⁹² (m)	他区画への影響
RB-3-1	東側エリア	熱源除去系	324	RHRA	東側ポンプ	4.23	西側エリアへの 伝播影響無し。
		燃料プール冷却ポンプ系	83	FP			
		原子炉冷却ポンプ系	300	LPCS			
		原子炉冷却ポンプ系	50	RWC			
		原子炉冷却ポンプ系	50	RP			
		熱源除去系(復水)	90	RHSA			
		熱源除去系(復水)	208	RCW			
		原子炉冷却ポンプ系	68	CRD			
		原子炉冷却ポンプ系	144	MUW			
		原子炉冷却ポンプ系(原子炉冷却ポンプ系)	208	DHC(RCWO)			
		熱源除去系	352	RHRA			
		熱源除去系	571	MUW			
		熱源除去系	571	MUW			
		原子炉冷却ポンプ系	267	RCW			
		原子炉冷却ポンプ系	68	CRD			
RB-3-2	西側エリア	熱源除去系	378	HPCS	西側ポンプ	1.98	東側エリアへの 伝播影響無し。
		原子炉冷却ポンプ系	382	RHRC			
		原子炉冷却ポンプ系	127	MUW			
		原子炉冷却ポンプ系	68	CRD			
		原子炉冷却ポンプ系	119	RHRA			
		原子炉冷却ポンプ系	127	MUW			
		原子炉冷却ポンプ系	33	FP			
		原子炉冷却ポンプ系	68	CRD			
		原子炉冷却ポンプ系	1	PLR			
		原子炉冷却ポンプ系	1	PLR			
		原子炉冷却ポンプ系	267	RCW			
		原子炉冷却ポンプ系	154	MUW			
		熱源除去系	382	RHRA			
		熱源除去系	382	RHRC			
		RB-3-3	東側エリア	熱源除去系			
原子炉冷却ポンプ系	289			FDW			
原子炉冷却ポンプ系	54			CUW			
原子炉冷却ポンプ系	231			TCW			
熱源除去系	324			RHRA			
熱源除去系	324			RHRC			
熱源除去系	324			RHRC			
熱源除去系	324			RHRC			
熱源除去系	324			RHRC			
熱源除去系	324			RHRC			
熱源除去系	324			RHRC			
熱源除去系	324			RHRC			
熱源除去系	324			RHRC			
熱源除去系	324			RHRC			
熱源除去系	324			RHRC			

第1表 想定破損による没水影響評価まとめ(4/7)

発生区画	区画分離	想定破損系統(没水量最大黒枠部)	没水量 ⁴⁾ (m ³)	系統略称	最終滞留エリア	最終滞留水位 ⁵⁾ (m)	他区画への影響
RB-2-4	西側エリア	区内系統					
RB-2-5	東側エリア	残留熱除去系	382	RHR(B)	西側ポンプ	1.98	東側エリアへの 伝播影響無し。
RB-2-6	東側エリア	残留熱除去系海水系	267	RHR(S(B))	東側ポンプ	3.49	西側エリアへの 伝播影響無し。
RB-2-7	東側エリア	無し	0	---	---	---	---
		残留熱除去系	324	RHR(A)	---	---	---
		管内排水系	50	FP	---	---	---
		低圧排水系	300	LPCS	---	---	---
		原子炉補機冷却系	288	RC(C)	---	---	---
		原子炉補機冷却系	143	MUW	---	---	---
		海水・海水移送系	143	MUW	---	---	---
		ドライウェル冷却系(原子炉補機冷却系)	298	DHC(RCW)	---	---	---
		残留熱除去系	382	RHR(B)	---	---	---
		管内排水系	382	RHR(C)	---	---	---
		管内排水系	30	FP	---	---	---
		原子炉補機冷却系	68	CRD	---	---	---
		海水・海水移送系	154	MUW	---	---	---
		原子炉補機冷却系	276	RCW	---	---	---
		高圧排水系	378	HPCS	---	---	---
		原子炉補機冷却系	267	RCW	---	---	---
		海水・海水移送系	127	MUW	---	---	---
		原子炉補機冷却系	54	CUW	---	---	---
		原子炉補機冷却系	267	RCW	---	---	---
		原子炉補機冷却系	54	CUW	---	---	---
		原子炉補機冷却系	267	RCW	---	---	---
		原子炉補機冷却系	54	CUW	---	---	---
		残留熱除去系	382	RHR(A)	---	---	---
		管内排水系	50	FP	---	---	---
		低圧排水系	300	LPCS	---	---	---
		原子炉補機冷却系	288	RC(C)	---	---	---
		原子炉補機冷却系	298	RCW	---	---	---
		海水・海水移送系	154	MUW	---	---	---
		残留熱除去系	382	RHR(B)	---	---	---
		残留熱除去系	382	RHR(C)	---	---	---
		海水・海水移送系	154	MUW	---	---	---
		原子炉補機冷却系	298	RCW	---	---	---
		原子炉補機冷却系	68	CRD	---	---	---
		管内排水系	54	CUW	---	---	---
		管内排水系	50	FP	---	---	---
		高圧排水系	378	HPCS	---	---	---
RB-1-1	東側エリア	管内排水系	50	FP	東側ポンプ	4.99	西側エリアへの 伝播影響無し。
RB-1-2	西側エリア	管内排水系	50	FP	西側ポンプ	1.98	東側エリアへの 伝播影響無し。

第1表 想定破損による浸水影響評価まとめ(5/7)

発生区画	区画分離	区画内系統 想定破損系統(浸水量最大黒枠部)	浸水量 ⁸¹⁾ (m ³)	系統略称	最終滞留エリア	最終滞留水位 ⁸²⁾ (m)	他区画への影響
RB-1-3	東側エリア	残留熱除去系	382	RHR(A)	RHR(A)熱交廻り	5.45	西側エリアへの伝播影響無し。
RB-1-4	東側エリア	復水・排水移送系	144	MUW	—	—	—
RB-1-5	西側エリア	無し	0	—	—	—	—
RB-1-6	東側エリア	無し	0	—	—	—	—
RB-1-7	西側エリア	残留熱除去系	382	RHR(B)	西側タンク	1.98	東側エリアへの伝播影響無し。
RB-B1-1	東側エリア	残留熱除去系	382	RHR(B)	東側タンク	4.99	西側エリアへの伝播影響無し。
		復水・排水移送系	272	RHR(SB)			
		原子炉相機汚濁系	382	RHR(A)			
		原子炉相機汚濁系	298	RCW			
		低圧炉心スプレイズ系	300	LPCS			
		原子炉相機汚濁系	288	RCIC			
		原子炉冷却材浄化系	92	FP			
		原子炉冷却材浄化系	54	CUW			
		復水・排水移送系	154	MLW			
		補助系	9	—			
RB-B1-2	西側エリア	残留熱除去系	382	RHR(B)	西側タンク	1.98	東側エリアへの伝播影響無し。
		復水・排水移送系	325	MUW			
		原子炉相機汚濁系	298	RCW			
		原子炉冷却材浄化系	51	CUW			
		原子炉冷却材浄化系	52	FP			
		原子炉冷却材浄化系	287	HPCS			
		補助系	9	—			
		残留熱除去系	382	RHR(C)			
		残留熱除去系	272	RHR(SB)			
		原子炉冷却材浄化系	50	FP			
RB-B1-3	西側エリア	残留熱除去系	382	RHR(A)	RHR(A)熱交廻り	5.45	西側エリアへの伝播影響無し。
		復水・排水移送系	272	RHR(SA)			
		原子炉相機汚濁系	144	MUW			
		原子炉冷却材浄化系	54	CUW			
		原子炉冷却材浄化系	272	RHR(SA)			
RB-B1-4	東側エリア	残留熱除去系	144	MUW	東側タンク	3.56	西側エリアへの伝播影響無し。
		復水・排水移送系	272	RHR(SA)			
		原子炉冷却材浄化系	144	MUW			
RB-B1-5	東側エリア	無し	0	—	—	—	—
RB-B1-6	西側エリア	無し	0	—	—	—	—
RB-B1-7	東側エリア	無し	0	—	—	—	—

第1表 想定破損による没水影響評価まとめ(6/7)

発生区画	区画分類	想定破損系統(没水量最大熱中時)	没水水量 ¹⁾ (m ³)	系統名称	最終滞留エリア	最終滞留水位 ²⁾ (m)	他区画への影響
RB-B1-8	西側エリア	区内系統	382	RHR(B)	西側ポンプ	1.98	東側エリアへの 伝播影響無し。
		破損系統	270	RCV			
		原子炉内閉鎖系	92	FP			
		補助系	9	—			
RB-B1-9	西側エリア	復水・配水移送系	163	MUW	西側ポンプ	1.96	東側エリアへの 伝播影響無し。
		副循環駆動系	68	CRD			
		復水・配水移送系	163	MUW			
		原子炉内閉鎖系	276	RCV			
		残留冷却系連動系	350	RHR(A)(B)			
		高圧炉心スプレイズ系	378	HPCS			
RB-B2-1	西側エリア	補助系	387	RCV	HPCSポンプ室	5.19	東側エリアへの 伝播影響無し。
		高圧炉心スプレイズ系	131	HPCS			
		補助系	4	—			
		HPCS	—	—			
RB-B2-2	西側エリア	高圧炉心スプレイズ系(注)	62	HPCS-DG/SW	西側ポンプ	1.49	東側エリアへの 伝播影響無し。
		原子炉内閉鎖系	33	FP			
		補助系	267	RCV			
		補助系	9	—			
RB-B2-3	西側エリア	破損系統	382	RHR(B)	西側ポンプ	1.98	東側エリアへの 伝播影響無し。
		原子炉内閉鎖系	33	FP			
		残留冷却系連動系	108	RHR(B)			
		副循環駆動系	117	RCV			
RB-B2-4	西側エリア	復水・配水移送系	131	MUW	西側ポンプ	1.98	東側エリアへの 伝播影響無し。
		副循環駆動系	382	RHR(B)			
		残留冷却系連動系	272	RHR(B)			
		原子炉内閉鎖系	33	FP			
RB-B2-5	西側エリア	残留冷却系連動系	382	RHR(C)	西側ポンプ	1.98	東側エリアへの 伝播影響無し。
		復水・配水移送系	131	MUW			
		副循環駆動系	99	RHR(B)			
		補助系	33	FP			
RB-B2-6	西側エリア	破損系統	382	RHR(C)	西側ポンプ	1.98	東側エリアへの 伝播影響無し。
		原子炉内閉鎖系	131	MUW			
		残留冷却系連動系	108	RHR(B)			
		副循環駆動系	117	RCV			
RB-B2-7	東側エリア	復水・配水移送系	382	MUW	RHR(A)ポンプ室	全没水	西側エリアへの 伝播影響無し。
		副循環駆動系	131	RHR(A)			
		残留冷却系連動系	382	MUW			
		補助系	131	MUW			
RB-B2-8	東側エリア	原子炉内閉鎖系	383	RHR(A)	RHR(A)熱交換器	5.45	西側エリアへの 伝播影響無し。
		残留冷却系連動系	108	RHR(A)			
		復水・配水移送系	154	MUW			
		原子炉内閉鎖系	33	FP			

第1表 想定破損による没水影響評価まとめ(7/7)

発生区画	区分分離	区内系統 想定破損系統(溢水量最大箇所)	溢水量 ^{※1} (m³)	系統名称	最終滞留エリア	最終滞留水位 ^{※2} (m)	他区画への影響
RB-B2-9	東側エリア	残留熱除去系 原子炉冷却系	282 33	RHSA RHSA	RHR(A) 熱交換器	5.45	西側エリアへの 伝播影響無し。
RB-B2-10	東側エリア	残留熱除去系 原子炉冷却系	288 108	RHSA RHSA	RCICポンプ室	4.76	西側エリアへの 伝播影響無し。
RB-B2-11	東側エリア	残留熱除去系 原子炉冷却系	37 9	RP RHSA	東側ポンプ	3.49	西側エリアへの 伝播影響無し。
RB-B2-12	東側エリア	原子炉冷却系 残留熱除去系	300 108	RP RHSA	東側ポンプ	3.92	西側エリアへの 伝播影響無し。
RB-B2-13	東側エリア	残留熱除去系 原子炉冷却系	300 60	RP RHSA	東側ポンプ	3.92	西側エリアへの 伝播影響無し。
RB-B2-14	西側エリア	残留熱除去系 原子炉冷却系	267 33	RP RHSA	西側ポンプ	1.98	東側エリアへの 伝播影響無し。
RB-B2-15	東側エリア	残留熱除去系 原子炉冷却系	382 108	RHSA RHSA	RHR(A) ポンプ室	金口水	西側エリアへの 伝播影響無し。
RB-B2-16	東側エリア	残留熱除去系 原子炉冷却系	183 33	RP RHSA	RCICポンプ室	3.02	西側エリアへの 伝播影響無し。
RB-B2-18	西側エリア	原子炉冷却系 残留熱除去系	297 32	RP RHSA	HPCSポンプ室	金口水	東側エリアへの 伝播影響無し。
RB-B2-19	西側エリア	原子炉冷却系 残留熱除去系	9 9	RP RHSA	HPCSポンプ室	1.01	東側エリアへの 伝播影響無し。

※1：溢水量については、各区内布設配管最大口径より算定。
 ※2：最終滞留水位算定において、想定破損系統（黒枠部）の溢水量より算定。

柏崎刈羽原子力発電所 6 / 7号炉 (2017.12.20版)	東海第二発電所 (2018.9.18版)	島根原子力発電所 2号炉	備考
	<div data-bbox="1020 527 1620 1146" data-label="Image"> </div> <div data-bbox="1442 1161 1644 1188" data-label="Text"> <p>— : 西側エリア</p> </div> <div data-bbox="943 1245 1709 1318" data-label="Text"> <p>補足：当該エリアでの溢水は、西側床ファンネルが伝播経路となるため、当該エリアは、西側エリアとする。</p> </div> <div data-bbox="1169 1352 1486 1381" data-label="Caption"> <p>第1図 区画分離図(1/10)</p> </div>		<p>・島根2号炉は東西に区画を分離して想定破損評価を実施していないため、区分分離図を作成していない</p> <p>【東海第二】</p>

柏崎刈羽原子力発電所 6 / 7号炉 (2017.12.20版)	東海第二発電所 (2018.9.18版)	島根原子力発電所 2号炉	備考
	<div data-bbox="943 556 1706 1123" style="border: 1px solid black; height: 270px; width: 257px; margin: 0 auto;"></div> <div data-bbox="1454 1176 1647 1249" style="margin-left: 400px;"> <p>— : 東側エリア</p> <p>— : 西側エリア</p> </div> <div data-bbox="1157 1323 1484 1365" style="text-align: center;"> <p><u>第1図 区画分離図(2/10)</u></p> </div>		

柏崎刈羽原子力発電所 6 / 7号炉 (2017.12.20版)	東海第二発電所 (2018.9.18版)	島根原子力発電所 2号炉	備考
	<div data-bbox="943 485 1709 1262" style="border: 1px solid black; height: 370px; margin-bottom: 10px;"></div> <div data-bbox="1484 1297 1676 1369"> <p>— : 東側エリア — : 西側エリア</p> </div> <div data-bbox="1169 1419 1486 1453" style="text-align: center;"> <p><u>第1図 区画分離図(3/10)</u></p> </div>		

柏崎刈羽原子力発電所 6 / 7号炉 (2017.12.20版)	東海第二発電所 (2018.9.18版)	島根原子力発電所 2号炉	備考
	<div data-bbox="943 457 1703 1272" style="border: 1px solid black; height: 388px; width: 256px; margin: 0 auto;"></div> <div data-bbox="1466 1314 1662 1386" style="margin-left: 400px;"> <p>— : 東側エリア</p> <p>— : 西側エリア</p> </div> <div data-bbox="1169 1423 1484 1457" style="text-align: center;"> <p><u>第1図 区画分離図(4/10)</u></p> </div>		

柏崎刈羽原子力発電所 6 / 7号炉 (2017.12.20版)	東海第二発電所 (2018.9.18版)	島根原子力発電所 2号炉	備考
	<div data-bbox="943 541 1703 1360" data-label="Image"> </div> <div data-bbox="1448 1411 1650 1486" data-label="Text"> <p>— : 東側エリア — : 西側エリア</p> </div> <div data-bbox="1169 1541 1489 1579" data-label="Caption"> <p>第1図 区画分離図(5/10)</p> </div>		

柏崎刈羽原子力発電所 6 / 7号炉 (2017.12.20版)	東海第二発電所 (2018.9.18版)	島根原子力発電所 2号炉	備考
	<div data-bbox="943 449 1703 1264" style="border: 1px solid black; height: 388px; width: 256px; margin: 0 auto;"></div> <div data-bbox="1448 1327 1644 1402" style="margin-left: 400px;"> <p>— : 東側エリア</p> <p>— : 西側エリア</p> </div> <div data-bbox="1169 1465 1484 1499" style="text-align: center;"> <p><u>第1図 区画分離図(6/10)</u></p> </div>		

柏崎刈羽原子力発電所 6 / 7号炉 (2017.12.20版)	東海第二発電所 (2018.9.18版)	島根原子力発電所 2号炉	備考
	<div data-bbox="943 478 1703 1285" style="border: 1px solid black; width: 256px; height: 384px; margin: 0 auto;"></div> <div data-bbox="1457 1289 1650 1360" style="margin-left: 400px;"> <p>— : 東側エリア</p> <p>— : 西側エリア</p> </div> <div data-bbox="1169 1419 1486 1453" style="text-align: center; margin-top: 20px;"> <p><u>第1図 区画分離図(7/10)</u></p> </div>		

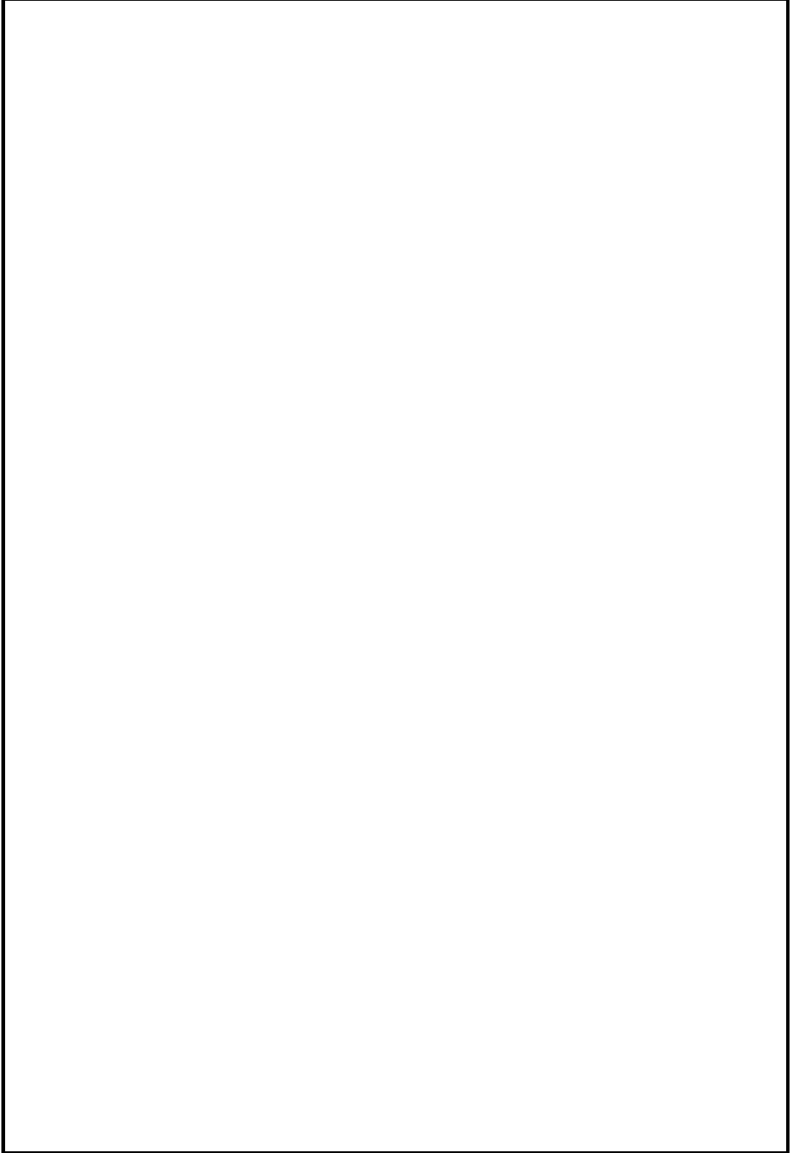
柏崎刈羽原子力発電所 6 / 7号炉 (2017.12.20版)	東海第二発電所 (2018.9.18版)	島根原子力発電所 2号炉	備考
	 <p data-bbox="1169 1556 1486 1587">第1図 区画分離図(8/10)</p>		

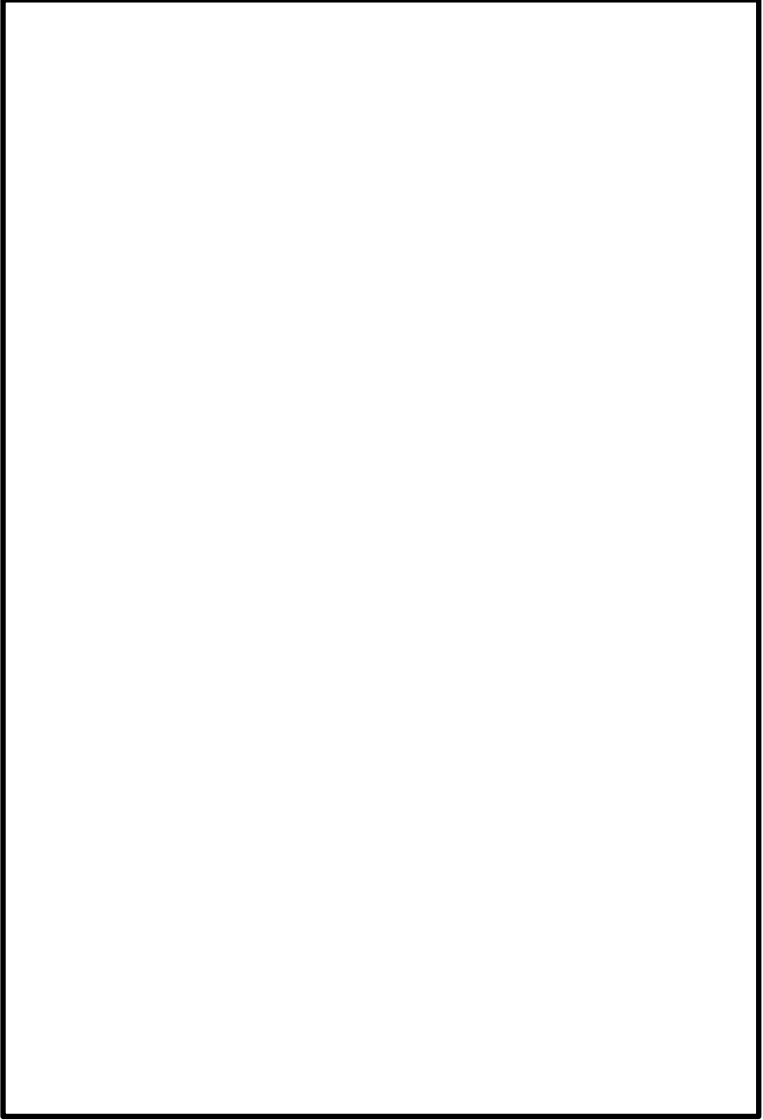
柏崎刈羽原子力発電所 6 / 7号炉 (2017.12.20版)	東海第二発電所 (2018.9.18版)	島根原子力発電所 2号炉	備考
	 <p data-bbox="1172 1507 1498 1543">第1図 区画分離図(9/10)</p>		

柏崎刈羽原子力発電所 6 / 7号炉 (2017.12.20版)	東海第二発電所 (2018.9.18版)	島根原子力発電所 2号炉	備考
	<div data-bbox="961 445 1673 1054" data-label="Image"> </div> <div data-bbox="1151 1146 1495 1188" data-label="Caption"> <p>第1図 区画分離図(10/10)</p> </div>		

添付5.1-1表 6号炉 想定破損による没水影響評価結果まとめ

評価種別: 想定 没水発生区画: B-6F-1 没水源: 10H1 没水量 (Q2): 97	総合判定: 総合判定: ○ 詳細判定: A	備考:
原子炉施設		
安全機能	安全機能	安全機能
機能判定	機能判定	機能判定
系統	系統	系統
区分	区分	区分
判定	判定	判定

第2表 想定破損による没水影響評価結果まとめ (1/99)

評価種別: 想定 没水発生区画: BB-6-1 没水源: RCW 没水量: 29S (m)	総合判定: 総合判定: ○ 評価方法: ① ※1	備考:
原子炉施設		
安全機能	安全機能	安全機能
機能判定	機能判定	機能判定
主たる系統	主たる系統	主たる系統
系統 (安全区分)	系統 (安全区分)	系統 (安全区分)
安全機能の維持	安全機能の維持	安全機能の維持

表 1-1 想定破損による没水影響評価結果

評価種別: 想定 没水発生区画: BB-6-1 没水源: RCW 没水量: 29S (m)	総合判定: 総合判定: ○ 評価方法: ① ※1	備考:
原子炉施設		
安全機能	安全機能	安全機能
機能判定	機能判定	機能判定
主たる系統	主たる系統	主たる系統
系統 (安全区分)	系統 (安全区分)	系統 (安全区分)
安全機能の維持	安全機能の維持	安全機能の維持

・設備及び評価条件の相違
【柏崎6/7, 東海第二】

(想定破損による没水影響評価結果の表の比較については以降の記載を省略)

添付 5.1-2 表 7 号炉 想定破損による没水影響評価結果まとめ

柏崎刈羽原子力発電所 6 / 7 号炉 (2017. 12. 20 版)

評価種別： 想定	総合判定	○
没水発生区画： R-B1-3	評価方法	-
没水原因： 給水断無し	注1	
没水量 (t/h)： 0		

原子炉施設		原子炉施設		原子炉施設		原子炉施設		原子炉施設		原子炉施設		原子炉施設	
a. 止める		b. c. 冷やす		d. 閉じ込める		e. プール冷却		f. プールへの給水		g. f.		監視機能	
安全機能	緊急停止機能	原子炉隔離時減圧注水機能	低圧注水/冷温停止機能	格納容器除熱機能	隔離機能	放射線物質損じ防止機能 (減圧)	格納容器内の可溶性ガス抑制機能	安全機能	注水機能	監視機能	安全機能	注水機能	監視機能
機能判定	○	○	○	○	○	○	○	○	○	○	○	○	
系統機器	水圧制御ユニット	原子炉隔離時減圧注水系統	格納容器除熱系統	格納容器スプレッドシステム (DWS)	格納容器スプレッドシステム (DWS)	格納容器スプレッドシステム (DWS)	格納容器スプレッドシステム (DWS)	燃料冷却系統	燃料冷却系統	燃料冷却系統	燃料冷却系統	燃料冷却系統	
区分	(A) (B)	(A) (B) (C)	(A) (B) (C)	(A) (B) (C)	(A) (B) (C)	(A) (B) (C)	(A) (B) (C)	(A) (B) (C)	(A) (B) (C)	(A) (B) (C)	(A) (B)	(A) (B)	
判定	○	○	○	○	○	○	○	○	○	○	○	○	

原子炉施設		原子炉施設		原子炉施設		原子炉施設		原子炉施設		原子炉施設		原子炉施設	
e. サポート系		e. サポート系		e. サポート系		e. サポート系		e. サポート系		e. サポート系		e. サポート系	
安全機能	補助冷却水機能/冷却用海水供給機能	原子炉隔離時減圧機能	原子炉隔離時減圧機能	原子炉隔離時減圧機能	原子炉隔離時減圧機能	原子炉隔離時減圧機能	原子炉隔離時減圧機能	原子炉隔離時減圧機能	原子炉隔離時減圧機能	原子炉隔離時減圧機能	原子炉隔離時減圧機能	原子炉隔離時減圧機能	原子炉隔離時減圧機能
機能判定	○	○	○	○	○	○	○	○	○	○	○	○	○
系統機器	原子炉隔離時減圧システム	原子炉隔離時減圧システム	原子炉隔離時減圧システム	原子炉隔離時減圧システム	原子炉隔離時減圧システム	原子炉隔離時減圧システム	原子炉隔離時減圧システム	原子炉隔離時減圧システム	原子炉隔離時減圧システム	原子炉隔離時減圧システム	原子炉隔離時減圧システム	原子炉隔離時減圧システム	原子炉隔離時減圧システム
区分	(A) (B) (C)	(A) (B) (C) (D)	(A) (B) (C) (D)	(A) (B) (C) (D)	(A) (B) (C) (D)	(A) (B) (C) (D)	(A) (B) (C) (D)	(A) (B) (C) (D)	(A) (B) (C) (D)	(A) (B) (C) (D)	(A) (B) (C) (D)	(A) (B) (C) (D)	(A) (B) (C) (D)
判定	○	○	○	○	○	○	○	○	○	○	○	○	○

注1: 基本評価 (流出流量; 当該系統の最大口径, 系統保有水量; 当該系統の全保有水量)
 A: 詳細評価 (流出流量; 当該区画における当該系統の最大口径, 系統保有水量; エネルギーレベルを考慮した保有水量, 隔離時間; インターロックによる自動隔離, 又はアンネルによる排水を考慮)

東海第二発電所 (2018. 9. 18 版)

島根原子力発電所 2号炉

備考

5.2 想定破損による被水影響評価結果まとめ
添付 5.2-1 表 6号炉 想定破損による被水影響評価結果まとめ

Table with columns: 区画, 溢水源, 一次判定, 相対位置関係考慮, 被水対策実施, 最終判定, 備考. Rows include R-4F-1, R-4F-2, R-4F-3C, R-4F-3共, R-4MF-1, R-4MF-3, R-4MF-4A, R-4MF-4C, R-4MF-4共, R-4MF-5B, R-4MF-5共1, R-4MF-5共2, R-3F-1共, R-3F-1A, R-3F-2, R-3F-3.

第3表 想定破損による被水影響評価結果まとめ (1/23)

Table with columns: 系統名称, 機器名称, 機器番号, 区画番号, 被水部又は貫通部の有無, 多重化・区画化, 防護仕様・被水防護措置, 判定基準, 対策実施, 評価結果. Rows include 制御棒駆動系, 燃料取扱装置, 格納容器雰囲気監視系, CIMS (A)系, CIMS (B)系, CIMS (C)系, etc.

判定基準
A: 被水防護対象設備が多重化又は区画化されており、各々が別区画に設置される等により、同時に機能喪失しない。
B: 被水防護対象設備が「JIS C 0920 電気機械器具の外観による保護等級 (IPコード)」(NEMA (National Electrical Manufacturers Association)による保護等級) 等による防護仕様を有している。又は被水防護対象設備を防護するために必要な防護措置がなされている。
C: 被水防護対象設備が「JIS C 0920 電気機械器具の外観による保護等級 (IPコード)」(NEMA (National Electrical Manufacturers Association)による保護等級) 等による防護仕様を有している。又は被水防護対象設備を防護するために必要な防護措置がなされている。

表2-1 想定破損による被水影響評価結果 (1/20)

Table with columns: 系統名称, 設備番号, 設備名称, 設置区画, 被水部又は貫通部の有無, 多重化・多様化, 防護仕様, 判定基準, 保護等級, 評価結果, 備考. Rows include 原子炉補給冷却系, 原子炉熱源系, 原子炉熱交換器, 原子炉熱交換器冷却水ポンプ, etc.

A: 被水防護対象設備が多重化又は区画化されており、各々が別区画に設置される等により、同時に機能喪失しない。
B: 被水防護対象設備が「JIS C 0920 電気機械器具の外観による保護等級 (IPコード)」(NEMA (National Electrical Manufacturers Association)による保護等級) 等による防護仕様を有している。又は被水防護対象設備を防護するために必要な防護措置がなされている。
C: 被水防護対象設備が「JIS C 0920 電気機械器具の外観による保護等級 (IPコード)」(NEMA (National Electrical Manufacturers Association)による保護等級) 等による防護仕様を有している。又は被水防護対象設備を防護するために必要な防護措置がなされている。

・設備及び評価条件の相違
【柏崎6/7, 東海第二】

添付 5. 2-1 表 6 号炉 想定破損による被水影響評価結果まとめ

区画	溢水源	一次判定	相対位置 関係考慮	被水対策 実施	最終判定	備考
R-3F-4	有り	×	-	○	○	区分 I、II の機器が同一区画に存在するため被水対策(区画内溢水源の想定除外)を実施 非常用ガス処理系(A),(B)
R-3F-5	有り	○	-	-	○	
R-3F-6	有り	○	-	-	○	区分 I、II、III の機器が同一区画に存在
R-2F-1	有り	×	-	-	○	残留熱除去系弁 E11-MO-F015 サプレッションポンプ浄化系弁 G51-MO-F014 燃料プール冷却浄化系弁 G41-MO-F005A G41-MO-F012 G41-MO-F021A, B バルブライン構成は維持されるため、使用中のFPC系統の機能は喪失しない。また現場操作にてRHR系統のバルブ構成を実施し、注水・冷却も可能。
R-2F-2p1	無	○	-	-	○	
R-2F-2p2	有り	○	-	-	○	
R-2F-2共1	有り	○	-	-	○	
R-2F-2共2	有り	○	-	-	○	

第 3 表 想定破損による被水影響評価結果まとめ (2/23)

系統名称	機器名称	機器番号	区画番号	被水漏、天井開口又は貫通部の有無	多重化・区画化	防滴仕様・被水防護措置	判定基準	対策実施	評価結果
原子炉系	COND VAC (B) (伝送器)	PT-22-3075B	TB-1-1	-	-	○IP67	C	-	○
原子炉系	COND VAC (C) (伝送器)	PT-22-3075C	TB-1-1	-	-	○IP67	C	-	○
原子炉系	COND VAC (D) (伝送器)	PT-22-3075D	TB-1-1	-	-	○IP67	C	-	○
原子炉系	MSL PRESS ISO (A) (伝送器)	PT-22-3076A	TB-1-20	-	-	○IP67	C	-	○
原子炉系	MSL PRESS ISO (B) (伝送器)	PT-22-3076B	TB-1-20	-	-	○IP67	C	-	○
原子炉系	MSL PRESS ISO (C) (伝送器)	PT-22-3076C	TB-1-2	-	-	○IP67	C	-	○
原子炉系	MSL PRESS ISO (D) (伝送器)	PT-22-3076D	TB-1-2	-	-	○IP67	C	-	○
原子炉補機冷却系	RCV SURGE TANK LEVEL (d/f)	LSL-9-192	RB-6-1	-	-	-	-	-	○
原子炉補機冷却系	RCV SURGE TANK LEVEL (伝送器)	LT-9-192	RB-6-1	-	-	○IP67	C	-	○
原子炉補機冷却系	RCV ドライブ (A)	RCV-PMP-A	TB-1-1	-	-	-	-	○	○
原子炉補機冷却系	RCV ドライブ (B)	RCV-PMP-B	TB-1-1	-	-	-	-	○	○
原子炉補機冷却系	RCV ドライブ (C)	RCV-PMP-C	TB-1-1	-	-	-	-	○	○
原子炉補機冷却系	174F15内機器 原子炉補機冷却系隔離弁	2-9330 000	RB-2-8	-	-	-	-	○	○
原子炉補機冷却系	174F15内機器 原子炉補機冷却系排水弁	2-9333 000	RB-2-8	-	-	-	-	○	○
原子炉補機冷却系	RCV 機器冷却器行き弁	7-9331 000	RB-B1-1	-	-	-	-	○	○
原子炉補機冷却系	RCV 熱交換器温度制御弁	TCV-9-92	TB-1-1	-	-	-	-	○	○
原子炉補機冷却系	RCV TEMP CONTROL (指示調節計)	TIC-9-92	TB-1-1	-	-	-	-	○	○
原子炉保護系	RFS M-G (t) (2A) 制御盤	LCP-184A	CS-1-3	○	-	-	A	-	○
原子炉保護系	RFS M-G (t) (2B) 制御盤	LCP-184B	CS-1-3	○	-	-	A	-	○
原子炉保護系	RFS 分電盤 (A)	PXL-C72-P001	CS-1-3	○	-	-	A	-	○
原子炉保護系	RFS 分電盤 (B)	PXL-C72-P002	CS-1-3	○	-	-	A	-	○
原子炉保護系	RFS M-G (t) (2A) (発電機/電動機)	RFS-MG-A-GEN /RFS-MG-A-MTR	CS-1-3	○	-	-	A	-	○
原子炉保護系	RFS M-G (t) (2B) (発電機/電動機)	RFS-MG-B-GEN /RFS-MG-B-MTR	CS-1-3	○	-	-	A	-	○
原子炉保護系	水平方向地震加速度検出器	C72-3009A	RB-2-9	-	-	-	B	-	○
原子炉保護系	水平方向地震加速度検出器	C72-3009B	RB-2-9	-	-	-	B	-	○
原子炉保護系	水平方向地震加速度検出器	C72-3009C	RB-2-8	-	-	-	B	-	○
原子炉保護系	水平方向地震加速度検出器	C72-3009D	RB-2-8	-	-	-	B	-	○
原子炉保護系	水平方向地震加速度検出器	C72-3010A	RB-2-3	-	-	-	B	-	○
原子炉保護系	水平方向地震加速度検出器	C72-3010B	RB-2-3	-	-	-	B	-	○
原子炉保護系	鉛直方向地震加速度検出器	C72-3011A	RB-2-3	-	-	-	B	-	○
原子炉保護系	鉛直方向地震加速度検出器	C72-3011B	RB-2-3	-	-	-	B	-	○
原子炉保護系	水平方向地震加速度検出器	C72-3010C	RB-2-8	-	-	-	B	-	○
原子炉保護系	水平方向地震加速度検出器	C72-3010D	RB-2-8	-	-	-	B	-	○
原子炉保護系	鉛直方向地震加速度検出器	C72-3011C	RB-2-8	-	-	-	B	-	○
原子炉保護系	鉛直方向地震加速度検出器	C72-3011D	RB-2-8	-	-	-	B	-	○

判定基準
 A：溢水防護対象設備設置区画に破損を想定する被水漏がなく、上部の天井面に開口部又は貫通部がない。
 B：溢水防護対象設備が多重化又は区画化されており、各々が別区画に設置される等により、同時に機能喪失しない。
 C：溢水防護対象設備が「JIS C 0920 電気機械器具の外郭による保護等級 (IPコード)」「NEMA (National Electrical Manufacturers Association) による保護等級」等による防護仕様を有している。又は溢水防護対象設備を防護するために必要な防護措置がなされている。
 -：被水による影響あり。

表 2-1 想定破損による被水影響評価結果 (2/20)

系統名称	設備番号	設備名称	設置区画	被水漏、天井開口又は貫通部の有無	多重化・多様化	防滴仕様	判定基準	保護等級	評価結果	備考
燃料ドライ冷却系	P216-1B	B-燃料ド→冷却水ポンプ	R-22F-11N R-22F-12N R-22F-20N	-	○	-	B	-	○	
燃料ド→冷却系	TE216-50-55	燃料プール-A水位・温度 (SA)	R-3F-04-1N R-3F-04-2A R-3F-07A R-3F-10-1N	-	○	-	B	IPX5	○	
燃料ド→冷却系	M216-5A	A-FW 蒸気入口弁	R-3F-06N	-	○	-	B	IP55	○	
燃料ド→冷却系	M216-5B	B-FW 蒸気入口弁	R-3F-06N	-	○	-	B	IP55	○	
燃料ド→冷却系	M216-6	FCV 714 (安全弁)	R-3F-06N	-	○	-	B	IP55	○	
燃料ド→冷却系	LS216-2	燃料プール-A水位	R-4F-01-1N	-	○	-	B	IP65	○	
燃料ド→冷却系	TE216-3	燃料プール-B温度	R-4F-01-1N	-	○	-	B	-	○	
蒸気ド→冷却系	P217-2B	174F15圧力	R-2F-11N R-2F-12N R-2F-15N R-2F-19N R-2F-24N R-2F-25N	-	-	-	C	IP67	○	
蒸気ド→冷却系	M217-18	非常用ド→処理入口隔離弁	R-2F-04-1N R-2F-04-2A R-3F-07A R-3F-10-1N	-	○	-	B	IP55	○	
高圧冷却水ド→冷却系	P218-1	高圧冷却水ド→冷却水ポンプ	R-22F-12N	-	○	-	B	IP44	○	
高圧冷却水ド→冷却系	M219-1	高圧冷却水ド→冷却水ポンプ	R-22F-12N	-	○	-	B	IP55	○	
高圧冷却水ド→冷却系	P219-1	高圧冷却水ド→冷却水ポンプ	Y-24CN	-	○	-	B	IP44	○	
原子炉隔離時冷却系	M221-1	原子炉隔離時冷却系ポンプ	Y-24CN	-	○	-	B	IP44	○	
原子炉隔離時冷却系	M221-2	注水弁	R-22F-01N	-	○	-	B	-	○	
原子炉隔離時冷却系	M221-22	717蒸気入口弁	R-22F-01N	-	○	-	B	IP55	○	
原子炉隔離時冷却系	M221-3	マフラー入り入口弁	R-22F-01N	-	○	-	B	IP55	○	
原子炉隔離時冷却系	M221-51	RCIC 主蒸気弁	R-22F-01N	-	○	-	B	-	○	
原子炉隔離時冷却系	M221-6	717マフラー弁	R-22F-01N	-	○	-	B	IP55	○	

A：溢水防護対象設備から放射性物質を考慮した範囲に破損を想定する被水漏がなく、上部の天井面に開口部又は貫通部がない。
 B：溢水防護対象設備が多重化又は区画化されており、各々が別区画に設置される等により、同時に機能喪失しない。
 C：溢水防護対象設備が「JIS C 0920 電気機械器具の外郭による保護等級 (IPコード)」「NEMA (National Electrical Manufacturers Association) による保護等級」等による防護仕様を有している。又は溢水防護対象設備を防護するために必要な防護措置がなされている。

添付5.2-1 表 6号炉 想定破損による被水影響評価結果まとめ

Table with 6 columns: 区画, 溢水源, 一次判定, 相対位置関係考慮, 被水対策実施, 最終判定. Rows include R-1F-4 to R-1F-11 and R-B-14 to R-B-15b.

第3表 想定破損による被水影響評価結果まとめ (4/23)

Table with 10 columns: 系統名称, 機器名称, 機器番号, 区画番号, 被水漏天井開口又は貫通部の有無, 多重化・区画化, 防滴仕様・被水防滴装置, 判定基準, 対策実施, 評価結果.

判定基準
A: 被水防護対象設置区画に破損を想定する被水漏がなく、上部の天井面に開口部又は貫通部がない。
B: 被水防護対象設置区画が多重化又は区画化されており、各々が別区画に設置される等により、同時に機能喪失しない。
C: 被水防護対象設置区画が「JIS C 0920 電気機械器具の外郭による保護等級 (IPコード)」(NEMA (National Electrical Manufacturers Association) による保護等級) 等による防護仕様を有している。又は被水防護対象設備を防護するために必要な防護措置がなされている。

表 2-1 想定破損による被水影響評価結果 (4/20)

Table with 11 columns: 系統名称, 設備番号, 設備名称, 設置区画, 被水漏・天井開口又は貫通部の有無, 多重化・多様化, 防滴仕様, 判定基準, 対策実施, 評価結果, 備考.

A: 被水防護対象設備から放射線量を考慮した範囲に破損を想定する被水漏がなく、上部の天井面に開口部又は貫通部がない。
B: 被水防護対象設備が多重化又は区画化されており、各々が別区画に設置される等により、同時に機能喪失しない。
C: 被水防護対象設置区画が「JIS C 0920 電気機械器具の外郭による保護等級 (IPコード)」による防護仕様を有している。又は被水防護対象設備を防護するために必要な防護措置がなされている。

添付 5.2-1 表 6 号炉 想定破損による被水影響評価結果まとめ

区画	溢水源	一次判定	相対位置 関係考慮	被水対策 実施	最終判定	備考
R-B1-2	有り	×	○	-	○	区分II、IIIの機器が同一区画に存在するが、 時機能喪失せず(補足説明資料26参照) 原子炉補機冷却水系弁 P21-M0-F055B, C, E, F 区分I、IIの機器が同一区画に存在するが、 時機能喪失せず(補足説明資料26参照) 格納容器内委閉気モニタ系 コネクタ保護ボックス (023 保護ボックス) D23-D006A, B イオンチェンハンハ検出器 D23-RE006A, B
R-B1-3	無		-	-	○	
R-B1-4	有り	○	-	-	○	
R-B1-5	有り	○	-	-	○	
R-B1-6	有り	○	-	-	○	
R-B1-7	無	○	-	-	○	
R-B1-8	無	○	-	-	○	
R-B1-10	有り	○	-	-	○	
R-B1-12	無	○	-	-	○	
R-B1-13	有り	○	-	-	○	
R-B1-16	有り	○	-	-	○	
R-B1-17	有り	○	-	-	○	

第 3 表 想定破損による被水影響評価結果まとめ (5/23)

系統名称	機器名称	機器番号	区画番号	被水原因 天井開口 又は貫通 部の有無 ○：有 ●：無	多重化・ 区画化 ○：有 ●：無	防滴仕 様・被水 防護措置 ○：有 ●：無	判定 基準 ○：有 ●：無	対策 実施 ○：有 ●：無	評価 結果 ○：良 ×：否
所内電源系	MCC 2C-9	MCC 2C-9	RB-4-1	○	○	○	○	○	○
所内電源系	MCC 2D-9	MCC 2D-9	RB-4-2	○	○	○	○	○	○
所内電源系	MCC HPCS	MCC HPCS	CS-B1-4	○	○	○	○	○	○
所内電源系	R/B INST DIST PNL 1	-	RB-1-1	○	○	○	○	○	○
所内電源系	R/B INST DIST PNL 2	-	RB-1-1	○	○	○	○	○	○
所内電源系	R/B INST DIST PNL 3	-	RB-B1-5	○	○	○	○	○	○
所内電源系	中央制御室 120V 交流計用 分電盤 2A-1	PNL-DP-2A-1-AC	CS-2-1	○	○	○	A	○	○
所内電源系	中央制御室 120V 交流計用 分電盤 2B-1	PNL-DP-2B-1-AC	CS-2-1	○	○	○	A	○	○
所内電源系	中央制御室 120V 交流計用 分電盤 2A-2	PNL-DP-2A-2-AC	CS-2-1	○	○	○	A	○	○
所内電源系	中央制御室 120V 交流計用 分電盤 2B-2	PNL-DP-2B-2-AC	CS-2-1	○	○	○	A	○	○
所内電源系	120/240V AC INST. DIST. CTR	-	CS-1-3	○	○	○	A	○	○
所内電源系	120V AC INST HPCS DIST PNL	-	CS-1-4	○	○	○	A	○	○
所内電源系	120V AC MCR DIST PNL NOR	-	CS-1-3	○	○	○	A	○	○
所内電源系	480V PWR. CTR. 2C	-	CS-B2-1	○	○	○	A	○	○
所内電源系	480V PWR. CTR. 2D	-	CS-B1-1	○	○	○	A	○	○
所内電源系	480V PWR. CTR. 2B-2	-	CS-B1-1	○	○	○	A	○	○
所内電源系	6.9kV SWGR. 2A-1	-	CS-B2-1	○	○	○	A	○	○
所内電源系	6.9kV SWGR. 2B-1	-	CS-B1-1	○	○	○	A	○	○
所内電源系	6.9kV SWGR. 2A-2	-	CS-B2-1	○	○	○	A	○	○
所内電源系	6.9kV SWGR. 2B-2	-	CS-B1-1	○	○	○	A	○	○
所内電源系	6.9kV SWGR. 2C	-	CS-B2-1	○	○	○	A	○	○
所内電源系	6.9kV SWGR. 2D	-	CS-B1-1	○	○	○	A	○	○
所内電源系	6.9kV SWGR. 2E	-	CS-B1-2	○	○	○	A	○	○
所内電源系	6.9kV SWGR. HPCS	-	CS-B2-2	○	○	○	A	○	○
所内電源系	TB 120V AC INST DIST PNL 1	-	TB-1-12	○	○	○	○	○	○
所内電源系	MCC 2A3-1	-	TB-1-12	○	○	○	○	○	○
所内電源系	MCC 2B3-1	-	TB-1-12	○	○	○	○	○	○
所内電源系	PC 2A-3	-	TB-1-12	○	○	○	○	○	○
所内電源系	PC 2B-3	-	TB-1-12	○	○	○	○	○	○
制御用圧縮空気系	1"7分6制鋼用空気供給弁	2-16V11(00)	RB-2-8	○	○	○	○	○	○
制御用圧縮空気系	1"7分6制鋼用空気供給弁	2-16V12A(00)	RB-3-1	○	○	○	○	○	○
制御用圧縮空気系	1"7分6制鋼用空気供給弁	2-16V12B(00)	RB-3-2	○	○	○	○	○	○
制御用圧縮空気系	1"7分6制鋼用空気供給弁	2-16V13A(00)	RB-3-1	○	○	○	○	○	○
制御用圧縮空気系	1"7分6制鋼用空気供給弁	2-16V13B(00)	RB-3-2	○	○	○	○	○	○
制御用圧縮空気系	1"7分6制鋼用空気供給弁	3-16V900A(A0)	RB-3-1	○	○	○	B	○	○

判定基準
 A : 被水防護対象設備設置区画に破損を想定する被水原因なく、上部の天井面に開口部又は貫通部がない。
 B : 被水防護対象設備が多重化又は区画化されており、各々が別区画に設置される等により、同時に機能喪失しない。
 C : 被水防護対象設備が JIS C 0920 電気機械器具の外部による保護等級 (IP コード)「NEMA(National Electrical Manufacturers Association)による保護等
 級」等による防護仕様を有している。又は被水防護対象設備を防護するために必要な防護措置がなされている。
 ○ : 被水による影響あり。

表 2-1 想定破損による被水影響評価結果 (5/20)

系統名称	設備番号	設備名称	設置区画	被水原因、天井開口 又は貫通部の有無		多重化・ 区画化	防滴仕様 又は被水 防護措置	判定 基準	対策 実施	評価 結果	評価等級	評価結果	備考
				○：有 ●：無	○：有 ●：無								
ほう入水注入系	W225-2B	B-SIC 注入弁	F-3F-04-IN F-3F-04-2N F-3F-07N F-3F-16-IN	○	○	○	○	○	○	IP55	○		
ほう入水注入系	F225-1A	A-ほう入水注入マフ	F-3F-04-IN F-3F-04-2N F-3F-07N F-3F-16-IN	○	○	○	○	○	○	-	○		
ほう入水注入系	F225-1B	B-ほう入水注入マフ	F-3F-04-IN F-3F-04-2N F-3F-07N F-3F-16-IN	○	○	○	○	○	○	-	○		
ほう入水注入系	FS225-1A	A-SIC 注入ポンプ潤滑油正 力	F-3F-04-IN F-3F-04-2N F-3F-07N F-3F-16-IN	○	○	○	○	○	○	-	○		
ほう入水注入系	FS225-1B	B-SIC 注入ポンプ潤滑油正 力	F-3F-04-IN F-3F-04-2N F-3F-07N F-3F-16-IN	○	○	○	○	○	○	-	○		
非常用#1処理系	D226-1A	A-SGT 前継#1処理装置	F-3F-04-IN F-3F-04-2N F-3F-07N F-3F-16-IN	○	○	○	○	○	○	-	○		
非常用#1処理系	D226-1B	B-SGT 前継#1処理装置	F-3F-04-IN F-3F-04-2N F-3F-07N F-3F-16-IN	○	○	○	○	○	○	-	○		
非常用#2処理系	D226-2A	A-SGT 後継#2処理装置	F-3F-04-IN F-3F-04-2N F-3F-07N F-3F-16-IN	○	○	○	○	○	○	-	○		
非常用#2処理系	D226-2B	B-SGT 後継#2処理装置	F-3F-04-IN F-3F-04-2N F-3F-07N F-3F-16-IN	○	○	○	○	○	○	-	○		

A : 被水防護対象設備から放物軌道を考慮した範囲に破損を想定する被水原因なく、上部の天井面に開口部又は貫通部がない。
 B : 被水防護対象設備が多重化又は区画化されており、各々が別区画に設置される等により、同時に機能喪失しない。
 C : 被水防護対象設備が JIS C 0920 電気機械器具の外部による保護等級 (IP コード)「NEMA(National Electrical Manufacturers Association)による保護等
 級」等による防護仕様を有している。又は被水防護対象設備を防護するために必要な防護措置がなされている。
 ○ : 被水による影響あり。

添付 5.2-1 表 6号炉 想定破損による被水影響評価結果まとめ

柏崎刈羽原子力発電所 6 / 7号炉 (2017. 12. 20 版)

Table with 6 columns: 区画, 溢水源, 一次判定, 相対位置関係考慮, 被水対策実施, 最終判定. It lists various equipment like R-B1-18, R-B2-2, R-B2-3, etc., and their status regarding water damage assessment.

東海第二発電所 (2018. 9. 18 版)

第3表 想定破損による被水影響評価結果まとめ (6/23)

Table with 11 columns: 系統名称, 機器名称, 機器番号, 区画番号, 被水原天井開口又は貫通部の有無, 多重化・区画化, 防護仕様・被水防護措置, 判定基準, 対策実施, 評価結果. It lists equipment like 制御用圧縮空気系, 中央制御室換気系, etc., and their assessment results.

判定基準
A: 被水防護対象設備設置区画に破損を想定する被水原がなく、上部の天井面に開口部又は貫通部がない。
B: 被水防護対象設備が多重化又は区画化されており、各々が別区画に設置される等により、同時に機能喪失しない。
C: 被水防護対象設備が「JIS C 0920 電気機械器具の外装による保護等級 (IPコード)」(NEMA National Electrical Manufacturers Association)による保護等級等による防護仕様を有している。又は被水防護対象設備を防護するために必要な防護措置がなされている。

島根原子力発電所 2号炉

備考

表 2-1 想定破損による被水影響評価結果 (6/20)

Table with 10 columns: 系統名称, 設備番号, 設備名称, 設置区画, 被水原、天井開口又は貫通部の有無, 多重化・区画化, 防護仕様, 判定基準, 保護等級, 評価結果. It lists equipment like 非常用*処理系, 非常用*排気系, etc., and their assessment results.

A: 被水防護対象設備から、送水機を考慮した範囲に破損を想定する被水原がなく、上部の天井面に開口部又は貫通部がない。
B: 被水防護対象設備が多重化又は区画化されており、各々が別区画に設置される等により、同時に機能喪失しない。
C: 被水防護対象設備が「JIS C 0920 電気機械器具の外装による保護等級 (IPコード)」(NEMA National Electrical Manufacturers Association)による保護等級等による防護仕様を有している。又は被水防護対象設備を防護するために必要な防護措置がなされている。

添付 5.2-1 表 6号炉 想定破損による被水影響評価結果まとめ

柏崎刈羽原子力発電所 6 / 7号炉 (2017.12.20版)

Table with columns: 区画, 溢水源, 一次判定, 相対位置関係考慮, 被水対策実施, 最終判定, 備考. Rows include various area codes (T-2F-1A to T-B2-4) and a summary row (C-2F-1).

区分 I, II の機器が同一区画に存在するため被水対策(区画内溢水源の想定除外)を実施

中央制御室換気空調系(A), (B)

東海第二発電所 (2018.9.18版)

第3表 想定破損による被水影響評価結果まとめ (7/23)

Table with columns: 系統名称, 機器名称, 機器番号, 区画番号, 被水漏天井開口又は貫通部の有無, 多重化・区画化, 防滴仕様・被水防護措置, 判定基準, 対策実施, 評価結果. Rows list various equipment like pumps and batteries across different areas.

判定基準
A : 被水防護対象設備設置区画に破損を想定する被水漏なく、上部の天井面に開口部又は貫通部がない。
B : 被水防護対象設備が多重化又は区画化されており、各々が別区画に設置される等により、同時に機能喪失しない。
C : 被水防護対象設備が「JIS C 0920 電気機械器具の外郭による保護等級 (IPコード)」「NEMA(National Electrical Manufacturers Association)による保護等級」等による防滴仕様を有している。又は被水防護対象設備を防護するために必要な防護措置がなされている。
- : 被水による影響あり。

島根原子力発電所 2号炉

備考

表2-1 想定破損による被水影響評価結果 (7/20)

Table with columns: 系統名称, 設備番号, 設備名称, 設置区画, 被水漏天井開口又は貫通部の有無, 多重化・多様化, 防滴仕様, 判定基準, 保護等級, 評価結果, 備考. Rows list various equipment like pumps and batteries across different areas.

A : 被水防護対象設備から放射線等を考慮した範囲に破損を想定する被水漏がなく、上部の天井面に開口部又は貫通部がない。
B : 被水防護対象設備が多重化又は多様化されており、各々が別区画に設置される等により、同時に機能喪失しない。
C : 被水防護対象設備が「JIS C 0920 電気機械器具の外郭による保護等級 (IPコード)」による防滴仕様を有している。又は被水防護対象設備を防護するために必要な防護措置がなされている。

添付5.2-1表 6号炉 想定破損による被水影響評価結果まとめ

区画	溢水源	一次判定	相対位置 関係考慮	被水対策 実施	最終判定	備考	
						区分Ⅰ,Ⅱの機器が同一区画に存在するため被水対策(区画内溢水源の想定除外)を実施	中央制御室換気空調系(A),(B) コントロール建屋計測制御電源盤区域(A)換気空調系
C-1F-2	有り	×	-	○	○		
C-1F-3	無	○	-	-	○		
C-1F-4A	無	○	-	-	○		
C-1F-4B	有り	○	-	-	○		
C-1F-5	無	○	-	-	○		
C-1F-6	無	○	-	-	○		
C-1F-7	有り	○	-	-	○		
C-1F-8	無	○	-	-	○		
C-1F-9	無	○	-	-	○		
C-1F-10	有り	○	-	-	○		
C-1F-11	無	○	-	-	○		
C-B1-1	有り	○	-	-	○		
C-B1-2	無	○	-	-	○		
C-B1-3	無	○	-	-	○		
C-B1-4	無	○	-	-	○		
C-B1-5	無	○	-	-	○		
C-B1-6	有り	○	-	-	○		
C-B1-7	無	○	-	-	○		
C-B1-8A	有り	×	-	○	○		

区分Ⅰ,Ⅱの機器が同一区画に存在するため被水対策(区画内溢水源の想定除外)を実施
中央制御室換気空調系(A),(B)
コントロール建屋計測制御電源盤区域(A)換気空調系

第3表 想定破損による被水影響評価結果まとめ (8/23)

系統名称	機器名称	機器番号	区画番号	被水時 天井開口 又は貫通 部の有無	多重化・ 区画化 の有無	防滴仕 様・潜水 防滴措置	判定 基準	対策 実施	評価 結果
直流電源設備	直流 125V 分電盤(2B-1)	125V DC DIST PNL 2B-1	CS-1-3	○	-	-	A	-	○
直流電源設備	直流 125V 分電盤(2B-2)	125V DC DIST PNL 2B-2	CS-1-3	○	-	-	A	-	○
直流電源設備	直流 125V 分電盤(2A-2-1)	125V DC DIST PNL 2A-2-1	CS-R2-1	○	-	-	A	-	○
直流電源設備	直流 125V 分電盤(2B-2-1)	125V DC DIST PNL 2B-2-1	CS-1-5	○	-	-	A	-	○
直流電源設備	直流 125V 分電盤(1PCS)	125V DC DIST PNL 1PCS	CS-1-4	○	-	-	A	-	○
直流電源設備	直流 ±24V 分電盤(2A)	24V DC DIST PNL 2A	CS-1-3	○	-	-	A	-	○
直流電源設備	直流 ±24V 分電盤(2B)	24V DC DIST PNL 2B	CS-1-3	○	-	-	A	-	○
直流電源設備	直流 ±24V 充電器(2A)	24V DC 2A BATT. CHARGER	CS-1-3	○	-	-	A	-	○
直流電源設備	直流 ±24V 充電器(2B)	24V DC 2B BATT. CHARGER	CS-1-3	○	-	-	A	-	○
直流電源設備	直流 ±24V 蓄電池(2A)	24V DC 2A BATTERY	CS-1-6	○	-	-	A	-	○
直流電源設備	直流 ±24V 蓄電池(2B)	24V DC 2B BATTERY	CS-1-8	○	-	-	A	-	○
直流電源設備	地絡検出装置(直流分電盤 2A-1)	PNL-LCP-177	CS-1-3	○	-	-	A	-	○
直流電源設備	地絡検出装置(直流分電盤 2A-2)	PNL-LCP-178	CS-1-3	○	-	-	A	-	○
直流電源設備	地絡検出装置(直流分電盤 2B-1)	PNL-LCP-179	CS-1-3	○	-	-	A	-	○
燃料冷却浄化系	FPC/D/MAIN CONTROL PNL	PNL-641-2010-100	BB-5-1	-	-	-	○	○	○
燃料冷却浄化系	FPC SYS PUMP AREA PNL	641-P002	BB-4-1	-	-	-	-	○	○
燃料冷却浄化系	FPC F/D INST. BACK	PNL-LR-R-46A	BB-5-1	-	-	○IP67	C	-	○
燃料冷却浄化系	FPC F/D INST. BACK	PNL-LR-R-46B	BB-5-1	-	-	○IP67	C	-	○
燃料冷却浄化系	FPC SKIMMER SURGE TANK LI	PNL-LCP-133	BB-6-1	-	-	-	○	○	○
燃料冷却浄化系	FPC 再循環ポンプ(A)	FPC-PMP-C001A	BB-4-19	-	-	-	○	○	○
燃料冷却浄化系	FPC 再循環ポンプ(B)	FPC-PMP-C001B	BB-4-19	-	-	-	-	○	○
燃料冷却浄化系	FPC F/D(A)出口弁	641-102A(A0)	BB-4-6	-	-	B	-	○	○
燃料冷却浄化系	FPC F/D(B)出口弁	641-102B(A0)	BB-4-9	-	-	B	-	○	○
燃料冷却浄化系	FPC F/D(A)出口流量制御弁	641-FCV-11A	BB-4-6	-	-	B	-	○	○
燃料冷却浄化系	FPC F/D(B)出口流量制御弁	641-FCV-11B	BB-4-9	-	-	B	-	○	○
燃料冷却浄化系	FPC 3ヶ月スケジューリング補助弁	7-18V71000	BB-5-1	-	-	-	○	○	○
燃料冷却浄化系	SKIMMER SURGE TANK HI LEVEL (3ヶ月)	L5B-G41-3004	BB-5-6	-	-	-	-	○	○
燃料冷却浄化系	SKIMMER SURGE TANK LO LEVEL (3ヶ月)	L5L-G41-3005	BB-5-6	-	-	-	-	○	○
燃料冷却浄化系	SKIMMER SURGE TANK LO LEVEL (伝達器)	L5L-G41-3006	BB-5-6	-	-	-	-	○	○
燃料冷却浄化系	SKIMMER SURGE TANK HI LEVEL (伝送器)	LT-G41-3100	BB-5-6	-	-	○IP67	C	-	○
燃料冷却浄化系	PUMP SECTION LO PRESS & ALARM (3ヶ月)	PNL-G41-3007A	BB-4-1	-	-	○NEMA-4	C	-	○
燃料冷却浄化系	PUMP SECTION LO PRESS & ALARM (3ヶ月)	PNL-G41-3007B	BB-4-1	-	-	○NEMA-4	C	-	○
燃料冷却浄化系	FUEL POOL TEMP (検出器)	TE-G41-3015	SFP内	-	-	-	-	○	○
交流電源設備	交流分電盤	PNL-VITAL-AC-1	CS-2-1	○	-	-	A	-	○

判定基準
A：潜水防護対象設備設置区画に破損を想定する被水がなく、上部の天井面に開口部又は貫通部がない。
B：潜水防護対象設備が多重化又は区画化されており、各々が別区画に設置される等により、同時に機能喪失しない。
C：潜水防護対象設備が「JIS C 0920 電気機械器具の外郭による保護等級(IPコード)」「NEMA(National Electrical Manufacturers Association)による保護等級」等による防護仕様を有している。又は潜水防護対象設備を防護するために必要な防護措置がなされている。
-：被水による影響あり。

表2-1 想定破損による被水影響評価結果 (8/20)

系統名称	設備番号	設備名称	設置区画	被水時 天井開口 又は貫通 部の有無	多重化・ 区画化 の有無	防滴仕 様・潜水 防滴措置	判定 基準	対策 実施	評価 結果	備考
可燃性ガス濃度警報系	W229-4A	A-FCS 系統入口流量調節弁	R-3F-04-IN R-3F-04-ZN R-3F-07N R-3F-16-IN	-	-	-	B	-	IP55	○
可燃性ガス濃度警報系	W229-4B	B-FCS 系統入口流量調節弁	R-3F-04-IN R-3F-04-ZN R-3F-07N R-3F-16-IN	-	-	-	B	-	IP55	○
可燃性ガス濃度警報系	W229-5A	A-FCS 再循環流量調節弁	R-3F-04-IN R-3F-04-ZN R-3F-07N R-3F-16-IN	-	-	-	B	-	IP55	○
可燃性ガス濃度警報系	W229-5B	B-FCS 再循環流量調節弁	R-3F-04-IN R-3F-04-ZN R-3F-07N R-3F-16-IN	-	-	-	B	-	IP55	○
可燃性ガス濃度警報系	W229-6A	A-FCS 冷却水供給弁	R-3F-04-IN R-3F-04-ZN R-3F-07N R-3F-16-IN	-	-	-	B	-	IP55	○
可燃性ガス濃度警報系	W229-6B	B-FCS 冷却水供給弁	R-3F-04-IN R-3F-04-ZN R-3F-07N R-3F-16-IN	-	-	-	B	-	IP55	○
所内電気設備系	-	2-WCTC 直流-C/C	R-3R1F-16X	-	-	-	B	-	-	○
所内電気設備系	-	2U-R/B-C/C	R-2F-04N	-	-	-	B	-	-	○
所内電気設備系	-	非常用1F/F流量(2C-W/C)	R-2F-04N	-	-	-	B	-	-	○
所内電気設備系	-	非常用1F/F流量(2C-L/C)	R-2F-04N	-	-	-	B	-	-	○
所内電気設備系	-	2D-R/B-C/C	R-2F-05N	-	-	-	B	-	-	○
所内電気設備系	-	非常用1F/F流量(2D-W/C)	R-2F-05N	-	-	-	B	-	-	○
所内電気設備系	-	非常用1F/F流量(2D-L/C)	R-2F-05N	-	-	-	B	-	-	○
所内電気設備系	-	2A-BG-C/C	R-2B-05N	-	-	-	B	-	-	○
所内電気設備系	-	2B-BG-C/C	R-2B-05N	-	-	-	B	-	-	○
所内電気設備系	-	2BPCS-C/C	R-2B-11N	-	-	-	B	-	-	○

A：潜水防護対象設備から放射線源を考慮した範囲に破損を想定する被水がなく、上部の天井面に開口部又は貫通部がない。
B：潜水防護対象設備が多重化又は区画化されており、各々が別区画に設置される等により、同時に機能喪失しない。
C：潜水防護対象設備が「JIS C 0920 電気機械器具の外郭による保護等級(IPコード)」による防護仕様を有している。又は潜水防護対象設備を防護するために必要な防護措置がなされている。

添付5.2-1表 7号炉 想定破損による被水影響評価結果まとめ

区画	溢水源	一次判定	相対位置 関係考慮	被水対策 実施	最終判定	備考
R-4F-1	有り	○	-	-	○	区分Ⅰ,Ⅲの機器が同一区画に存在するが、隔離、遮蔽により同時機能喪失せず(補足説明資料26参照)
R-4F-2A	有り	×	○	-	○	原子炉補機冷却水系サージタンク水位 P21-L1-022A,C
R-4F-2B	有り	○	-	-	○	
R-4F-2C	無し	○	-	-	○	
R-4F-3	有り	×	○	-	○	区分Ⅰ～Ⅳの機器が同一区画に存在するが、隔離、遮蔽により同時機能喪失せず(補足説明資料26参照) 燃料取替エリア排気放射線モニタ D11-RE-066A,B,C,D
R-4MF-1	有り	○	-	-	○	
R-4MF-2	有り	○	-	-	○	
R-4MF-3	有り	○	-	-	○	
R-4MF-4A	有り	○	-	-	○	
R-4MF-4B	有り	○	-	-	○	
R-4MF-4C	有り	○	-	-	○	
R-4MF-4共	有り	○	-	-	○	
R-4MF-5共①	有り	○	-	-	○	
R-4MF-5共②	有り	○	-	-	○	
R-4MF-5B	有り	○	-	-	○	
R-3F-1共	有り	×	○	-	○	区分Ⅰ,Ⅱの機器が同一区画に存在するが、隔離、遮蔽により同時機能喪失せず(補足説明資料26参照) 原子炉格納容器圧力 T31-PT-026A,B
R-3F-1A	有り	○	-	-	○	
R-3F-2	有り	○	-	-	○	

第3表 想定破損による被水影響評価結果まとめ (10/23)

系統名称	機器名称	機器番号	区画 番号	被水 原因 又は貫通 部の有無 ○:有 -:無	多重化・ 区画化 ○:有 -:無	防滴仕 様・被水 防護措置 ○:有 -:無	判定 基準 ○:有 -:無	対策 実施 ○:有 -:無	評価 結果 ○:良 ×:否
非常用1'系地理系	SGTS INST. RACK (B)	PNL-1R-R-48	RB-5-14	-	-	○IP67	C	-	○
非常用1'系地理系	SGTS 排風機(A)	BVAC-E2-10A	RB-5-14	-	-	-	-	○	○
非常用1'系地理系	SGTS 排風機(B)	BVAC-E2-10B	RB-5-14	-	-	-	-	○	○
非常用1'系地理系	SGTS トコ(A)ﾌﾗｲ	SGTS-FLT-A	RB-5-14	-	-	-	-	○	○
非常用1'系地理系	SGTS トコ(B)ﾌﾗｲ	SGTS-FLT-B	RB-5-14	-	-	-	-	○	○
非常用1'系地理系	SGTS トコ(A)ﾍﾞｰ	SGTS-HEX-EM2-7A	RB-5-14	-	-	-	-	○	○
非常用1'系地理系	SGTS トコ(B)ﾍﾞｰ	SGTS-HEX-EM2-7B	RB-5-14	-	-	-	-	○	○
非常用1'系地理系	SGTS トコ(A)入口ﾌﾝｸﾞ	SR2-9A(40)	RB-5-14	-	-	-	-	○	○
非常用1'系地理系	SGTS トコ(B)入口ﾌﾝｸﾞ	SR2-9B(40)	RB-5-14	-	-	-	-	○	○
非常用1'系地理系	SGTS トコ(A)出口ﾌﾝｸﾞ	SR2-11A(40)	RB-5-14	-	-	-	-	○	○
非常用1'系地理系	SGTS トコ(B)出口ﾌﾝｸﾞ	SR2-11B(40)	RB-5-14	-	-	-	-	○	○
非常用1'系地理系	SGTS TRAIN (A) ADSOVER IN TEMP (検出器)	TE-26-921A	RB-5-14	-	-	-	-	○	○
非常用1'系地理系	SGTS TRAIN (B) ADSOVER IN TEMP (検出器)	TE-26-921B	RB-5-14	-	-	-	-	○	○
非常用1'系地理系	SGTS TRAIN (A) ADSOVER OUT TEMP (検出器)	TE-26-922A	RB-5-14	-	-	-	-	○	○
非常用1'系地理系	SGTS TRAIN (B) ADSOVER OUT TEMP (検出器)	TE-26-922B	RB-5-14	-	-	-	-	○	○
非常用1'系地理系	SGTS (A) AIR HEATER AUTO RESET (検出器)	TE-26-950A	RB-5-14	-	-	-	-	○	○
非常用1'系地理系	SGTS (B) AIR HEATER AUTO RESET (検出器)	TE-26-950B	RB-5-14	-	-	-	-	○	○
非常用1'系地理系	SGTS (A) AIR HEATER HAND RESET (検出器)	TE-26-951A	RB-5-14	-	-	-	-	○	○
非常用1'系地理系	SGTS (B) AIR HEATER HAND RESET (検出器)	TE-26-951B	RB-5-14	-	-	-	-	○	○
非常用1'系地理系	SGTS TRAIN (A) INLET TEMP (検出器)	TE-26-30.1A	RB-5-14	-	-	-	-	○	○
非常用1'系地理系	SGTS TRAIN (B) INLET TEMP (検出器)	TE-26-30.1B	RB-5-14	-	-	-	-	○	○
非常用1'系地理系	SGTS TRAIN (A) OUTLET TEMP (検出器)	TE-26-30.4A	RB-5-14	-	-	-	-	○	○
非常用1'系地理系	SGTS TRAIN (B) OUTLET TEMP (検出器)	TE-26-30.4B	RB-5-14	-	-	-	-	○	○
非常用1'系再循環系/非常用1'系地理系	FRYS-SGTS(A)HEATER CONT. PNL	LCP-133	RB-5-14	-	-	-	-	○	○
非常用1'系再循環系/非常用1'系地理系	FRYS-SGTS(B)HEATER CONT. PNL	LCP-134	RB-5-14	-	-	-	-	○	○
非常用1'系再循環系/非常用1'系地理系	FRYS SGTS系入口ﾌﾝｸﾞ (SR2-4A)	SR2-4A(40)	RB-5-1	-	-	-	-	○	○
非常用1'系再循環系/非常用1'系地理系	FRYS SGTS系入口ﾌﾝｸﾞ (SR2-4B)	SR2-4B(40)	RB-5-1	-	-	-	-	○	○
非常用1'系再循環系/非常用1'系地理系	DG 2C 制御盤	DGCP/2C	CS-B1-5	-	-	-	-	○	○
非常用1'系再循環系/非常用1'系地理系	DG 2C 中性点接地変圧器盤	PNL-NGT-2C	CS-B1-5	-	-	-	-	○	○
非常用1'系再循環系/非常用1'系地理系	DG 2C 自動電圧調整器盤	PNL-DG-AVR-2C	CS-B1-5	-	-	-	-	○	○
非常用1'系再循環系/非常用1'系地理系	DG 2C 交流177V盤	PNL-DG-SR-2C	CS-B1-5	-	-	-	-	○	○
非常用1'系再循環系/非常用1'系地理系	DG 2C 交流177V盤	PNL-MCX-2C	CS-B1-5	-	-	-	-	○	○
非常用1'系再循環系/非常用1'系地理系	DG 2C 整流器用変圧器盤	PNL-SRT-2C	CS-B1-5	-	-	-	-	○	○
非常用1'系再循環系/非常用1'系地理系	DG 2C 可飽和変流器	PNL-SCT-2C	CS-B1-5	-	-	-	-	○	○

判定基準
A: 被水防護対象設備設置区画に破損を想定する被水原因なく、上部の天井面に開口部又は貫通部がない。
B: 被水防護対象設備が多重化又は区画化されており、各々が別区画に設置される等により、同時に機能喪失しない。
C: 被水防護対象設備が「JIS C 0920 電気機械器具の外装による保護等級 (IPコード)」 「NEMA (National Electrical Manufacturers Association) による保護等級」等による防護仕様を有している。又は被水防護対象設備を防護するために必要な防護措置がなされている。
-: 被水による影響あり。

表2-1 想定破損による被水影響評価結果 (10/20)

系統名称	設備番号	設備名称	設置区画	被水原因、天井開口 又は貫通部の有無 ○:有 -:無	多重化・ 多様化 ○:有 -:無	防滴仕様 又は貫通部 の有無 ○:有 -:無	判定 基準 ○:有 -:無	対策 実施 ○:有 -:無	評価 結果 ○:良 ×:否
所内電気設備系	2-2263A	A=原子炉中性子計測用分電盤	RW-1F-10N	○	-	-	A	-	○
所内電気設備系	2-2265A	A=115V系配電盤	RW-1F-10N	○	-	-	A	-	○
所内電気設備系	2-2267A	A=115V系充電器盤	RW-1F-10N	○	-	-	A	-	○
所内電気設備系	2-2268A	A=原子炉中性子計測用充電盤	RW-1F-10N	○	-	-	A	-	○
所内電気設備系	-	A=115V系蓄電池	RW-1F-11N	○	-	-	A	-	○
所内電気設備系	-	A=原子炉中性子計測用蓄電池	RW-1F-11N	○	-	-	A	-	○
原子炉再循環系	H261-3	DN3537P 密閉冷却機	R-2F-13N	-	○	○	B	IP44	○
原子炉再循環系	H261-4C	C=DR377P 密閉冷却機	R-2F-13N	-	○	○	B	IP44	○
原子炉再循環系	H261-7A	A=DR377P 密閉冷却機	R-2F-13N	-	○	○	B	-	○
原子炉再循環系	H261-7B	B=DR377P 密閉冷却機	R-2F-13N	-	○	○	B	-	○
原子炉再循環系	H261-4B	B=DR377P 密閉冷却機	R-2F-13N	-	○	○	B	IP44	○
原子炉再循環系	H261-4A	A=DR377P 密閉冷却機	R-2F-13N	-	○	○	B	IP44	○
原子炉再循環系	H261-2	DN3537P 密閉冷却機	R-2F-62N	-	○	○	B	IP44	○
原子炉再循環系	H261-1A	A=中央制御室空気調和装置	RW-2F-02N	○	-	-	A	-	○
原子炉再循環系	H261-1B	B=中央制御室空気調和装置	RW-2F-02N	○	-	-	A	-	○
原子炉再循環系	H261-1A	A=中央制御室冷凍機	RW-2F-02N	○	-	-	A	-	○
原子炉再循環系	H261-1B	B=中央制御室冷凍機	RW-2F-02N	○	-	-	A	-	○
原子炉再循環系	H261-1A	A=中央制御室送風機	RW-2F-02N	○	-	-	A	-	○
原子炉再循環系	H261-1B	B=中央制御室送風機	RW-2F-02N	○	-	-	A	-	○
原子炉再循環系	H261-1A	A=中央制御室送風機	RW-2F-02N	○	-	-	A	-	○
原子炉再循環系	H261-1B	B=中央制御室送風機	RW-2F-02N	○	-	-	A	-	○
原子炉再循環系	H261-3A	A=中央制御室排風機	RW-2F-02N	○	-	-	A	-	○
原子炉再循環系	H261-3B	B=中央制御室排風機	RW-2F-02N	○	-	-	A	-	○
原子炉再循環系	P261-1A	A=中央制御室冷水循環ポンプ	RW-2F-02N	○	-	-	A	-	○

A: 被水防護対象設備から放物軌道を考慮した範囲に破損を想定する被水原因なく、上部の天井面に開口部又は貫通部がない。
B: 被水防護対象設備が多重化又は多様化されており、各々が別区画に設置される等により、同時に機能喪失しない。
C: 被水防護対象設備が「JIS C 0920 電気機械器具の外装による保護等級 (IPコード)」 「NEMA (National Electrical Manufacturers Association) による保護等級」等による防護仕様を有している。又は被水防護対象設備を防護するために必要な防護措置がなされている。

添付 5.2-1 表 7号炉 想定破損による被水影響評価結果まとめ

区画	溢水源	一次判定	相対位置関係考慮	被水対策実施	最終判定	備考
R-3F-3	有り	○	-	-	○	
R-3F-4	有り	×	-	○	○	区分 I, II の機器が同一区画に存在するため被水対策(区画内溢水源の想定除外)を実施 非常用ガス処理系(A), (B)
R-3F-5	有り	○	-	-	○	区分 I, II, III の機器が同一区画に存在 残留熱除去系弁 E11-MO-F015 サブレンジオンプール浄化系弁 G51-MO-F015 燃料プールの右封浄化系弁 G41-MO-F005A G41-MO-F013 G41-MO-F021A, B
R-2F-1	有り	×	-	-	○	バルブライオン構成は維持されるため、使用中のEPC系統の機能は喪失しない。また、現場操作にてRRR系統のバルブ構成を実施し、注水・冷却も可能。
R-2F-2p1	無	○	-	-	○	
R-2F-2p2	無	○	-	-	○	
R-2F-2共1	有り	○	-	-	○	

第3表 想定破損による被水影響評価結果まとめ (11/23)

系統名称	機器名称	機器番号	区画番号	被水源・天井開口又は貫通部の有無 ○：有 ○：無	多重化・区画化 ○：有 ○：無	防漏仕舞・被水防護措置 ○：有 ○：無	判定基準 ○：有 ○：無	対策実施 ○：有 ○：無	評価結果 ○：良 ○：否
非常用ディーゼル発電設備	DG 2C INST. RACK	R-56	CS-B1-5	-	○	-	B	-	○
非常用ディーゼル発電設備	DG 2C DIESEL ENGINE INST. RACK	R-65	CS-B1-5	-	○	-	B	-	○
非常用ディーゼル発電設備	2C ディーゼル発電機/機関	GEN-26-2C/DGE-2C	CS-B1-5	-	○	-	B	-	○
非常用ディーゼル発電設備	DG 2C 吸気系7149(L側)	DG-2C-AE-FLT -INTAKE-L	(C/S屋上)	-	-	-	-	-	-
非常用ディーゼル発電設備	DG 2C 吸気系7149(R側)	DG-2C-AE-FLT -INTAKE-R	(C/S屋上)	-	-	-	-	-	-
非常用ディーゼル発電設備	DG 2C 潤滑油ワケツ	DG-VSL-2C-DGLO-1	CS-B2-5	-	○	-	B	-	○
非常用ディーゼル発電設備	DG 2C シフト油ワケ	DG-VSL-2C-DGLO-2	CS-B1-5	-	○	-	B	-	○
非常用ディーゼル発電設備	DG 2C 機関油ワケ	7-8-DGLO-113	(C/S屋上)	-	-	-	-	-	-
非常用ディーゼル発電設備	DG 2C 潤滑油ワケワケ管	7-6-DGLO-125	(C/S屋上)	-	-	-	-	-	-
非常用ディーゼル発電設備	DG 2C 燃料油ワケ(燃料ワケ)	DG-VSL-2C-DGLO-1	CS-B1-8	-	-	-	-	-	-
非常用ディーゼル発電設備	DG 2C 燃料油ワケ管	3-11/4-DGLO-120	(C/S屋上)	-	-	-	-	-	-
非常用ディーゼル発電設備	DG 2C 始動用電磁弁(No.1)	3-14E147D-1	CS-B1-5	-	○	-	B	-	○
非常用ディーゼル発電設備	DG 2C 始動用電磁弁(No.2)	3-14E147D-2	CS-B1-5	-	○	-	B	-	○
非常用ディーゼル発電設備	燃料ワケ配管側の圧力検知(2C)	DG-L1T5-105	CS-B1-8	-	-	-	-	-	-
非常用ディーゼル発電設備	DG 2D 制御盤	DGCP2D	CS-B1-3	-	○	-	B	-	○
非常用ディーゼル発電設備	DG 2D 中性点接地変圧器盤	PNL-30T-2D	CS-B1-3	-	○	-	B	-	○
非常用ディーゼル発電設備	DG 2D 自動電圧調整器盤	PNL-06-AVR-2D	CS-B1-3	-	○	-	B	-	○
非常用ディーゼル発電設備	DG 2D シット電流器盤	PNL-DG-SR-2D	CS-B1-3	-	○	-	B	-	○
非常用ディーゼル発電設備	DG 2D 交差ワケ盤	PNL-MCX-2D	CS-B1-3	-	○	-	B	-	○
非常用ディーゼル発電設備	DG 2D シット整流器用変圧器盤	PNL-SRT-2D	CS-B1-3	-	○	-	B	-	○
非常用ディーゼル発電設備	DG 2D 可能変流器	PNL-SCT-2D	CS-B1-3	-	○	-	B	-	○
非常用ディーゼル発電設備	DG 2D INST. RACK	R-52	CS-B1-3	-	-	-	B	-	○
非常用ディーゼル発電設備	DG 2D DIESEL ENGINE INST. RACK	R-64	CS-B1-3	-	-	-	B	-	○
非常用ディーゼル発電設備	2D ディーゼル発電機/機関	GEN-26-2D/DGE-2D	CS-B1-3	-	○	-	B	-	○
非常用ディーゼル発電設備	DG 2D 吸気系7149(L側)	DG-2D-AE-FLT -INTAKE-L	(C/S屋上)	-	-	-	-	-	-
非常用ディーゼル発電設備	DG 2D 吸気系7149(R側)	DG-2D-AE-FLT -INTAKE-R	(C/S屋上)	-	-	-	-	-	-
非常用ディーゼル発電設備	DG 2D 潤滑油ワケツ	DG-VSL-2D-DGLO-1	CS-B2-3	-	○	-	B	-	○
非常用ディーゼル発電設備	DG 2D シフト油ワケ	DG-VSL-2D-DGLO-2	CS-B1-3	-	○	-	B	-	○
非常用ディーゼル発電設備	DG 2D 機関油ワケ	7-8-DGLO-13	(C/S屋上)	-	-	-	-	-	-
非常用ディーゼル発電設備	DG 2D 潤滑油ワケワケ管	7-6-DGLO-25	(C/S屋上)	-	-	-	-	-	-
非常用ディーゼル発電設備	DG 2D 燃料油ワケ(燃料ワケ)	DG-VSL-2D-DGLO-1	CS-B1-6	-	-	-	-	-	-
非常用ディーゼル発電設備	DG 2D 燃料油ワケ管	3-11/4-DGLO-20	(C/S屋上)	-	-	-	-	-	-
非常用ディーゼル発電設備	DG 2D 始動用電磁弁(No.1)	3-14-E47D-1	CS-B1-3	-	○	-	B	-	○
非常用ディーゼル発電設備	DG 2D 始動用電磁弁(No.2)	3-14-E47D-2	CS-B1-3	-	○	-	B	-	○

判定基準
A : 被水防護対象設備区画に破損を想定する被水源がなく、上部の天井開口又は貫通部がない。
B : 被水防護対象設備が多重化又は区画化されており、各々が別区画に設置される等により、同時に機能喪失しない。
C : 被水防護対象設備が「JIS C 0920 電気機械器具の外装による保護等級 (IP コード)」(NEMA (National Electrical Manufacturers Association) による保護等級) 等による防漏仕舞を有している。又は被水防護対象設備を防護するために必要な防護措置がなされている。
- : 被水による影響あり。

表2-1 想定破損による被水影響評価結果 (11/20)

系統名称	設備番号	設備名称	設置区画	被水源・天井開口又は貫通部の有無 ○：有 ○：無	多重化・多様化 ○：有 ○：無	防漏仕舞 ○：有 ○：無	判定基準 ○：有 ○：無	保護等級	評価結果 ○：良 ○：否	備考
中央制御室空調換気系	F204-1B	B-中央制御室冷水循環ポンプ	R-2F-02N	○	-	-	A	-	○	
中央制御室空調換気系	D204-3	中央制御室非常用再循環処理装置	R-2F-01N	○	-	-	A	-	○	
中央制御室空調換気系	M204-2A	A-中央制御室非常用再循環送風機	R-2F-01N	○	-	-	A	IP44	○	
中央制御室空調換気系	M204-2B	B-中央制御室非常用再循環送風機	R-2F-01N	○	-	-	A	IP44	○	
原子炉建物付換気系	I208-4A	A-HVAC 377 熱交換器室冷却機	R-1F-14N	-	○	-	B	IP44	○	
原子炉建物付換気系	M208-1	A-非常用 DC 室送風機	R-2F-06N	-	○	-	B	IP44	○	
原子炉建物付換気系	M208-2	B-非常用 DC 室送風機	R-2F-07N	○	-	-	A	IP44	○	
原子炉建物付換気系	D208-3	HPCS 電気室外処理装置	R-2F-21N	-	-	-	C	-	○	内部に浸水しない構造
原子炉建物付換気系	I208-4B	B-HVAC 377 熱交換器室冷却機	R-2F-21N	-	-	-	C	IP55	○	
原子炉建物付換気系	M208-5A	A-HPCS 電気室送風機	R-2F-21N	-	-	-	C	IP55	○	
原子炉建物付換気系	M208-5B	B-HPCS 電気室送風機	R-2F-21N	-	-	-	C	IP55	○	
原子炉建物付換気系	M208-5A	A-HPCS 電気室送風機	R-2F-21N	-	-	-	C	IP55	○	
原子炉建物付換気系	M208-5B	B-HPCS 電気室送風機	R-2F-21N	-	-	-	C	IP55	○	
原子炉建物付換気系	M208-5A	A-HPCS 電気室送風機	R-2F-21N	-	-	-	C	IP55	○	
原子炉建物付換気系	M208-5B	B-HPCS 電気室送風機	R-2F-21N	-	-	-	C	IP55	○	
原子炉建物付換気系	M208-3	HPCS-DG 室送風機	R-2F-22N	-	-	-	C	IP55	○	
原子炉建物付換気系	D208-1	A-非常用電気室外処理装置	R-3F-02N	○	-	-	A	-	○	内部に浸水しない構造
原子炉建物付換気系	M208-1A	A1-非常用電気室送風機	R-3F-02N	-	-	-	B	IP44	○	
原子炉建物付換気系	M208-1B	A2-非常用電気室送風機	R-3F-02N	-	-	-	B	IP44	○	

A : 被水防護対象設備から放射状道を考慮した範囲に破損を想定する被水源がなく、上部の天井開口又は貫通部がない。
B : 被水防護対象設備が多重化又は区画化されており、各々が別区画に設置される等により、同時に機能喪失しない。
C : 被水防護対象設備が「JIS C 0920 電気機械器具の外装による保護等級 (IP コード)」(NEMA (National Electrical Manufacturers Association) による保護等級) 等による防漏仕舞を有している。又は被水防護対象設備を防護するために必要な防護措置がなされている。

添付 5.2-1 表 7号炉 想定破損による被水影響評価結果まとめ

区画	溢水源	一次判定	相対位置関係考慮	被水対策実施	最終判定	備考
R-2F-2共2	有り	×	-	○	○	区分IIの機器が区分Iの配管破断時に被水する可能性があるため、被水対策 (防滴仕様の確認; IP55, IP56相当) を実施 格納容器内雰囲気モニタ系弁 D23-M0-F004B D23-M0-F005B D23-S0-F001B
R-2F-2共3	有り	×	-	○	○	区分Iの機器が区分IIの配管破断時に被水する可能性があるため、被水対策 (防滴仕様の確認; IP55相当) を実施 格納容器内雰囲気モニタ系弁 D23-M0-F004A D23-M0-F005A
R-2F-3	有り	○	-	-	○	
R-2F-4	有り	○	-	-	○	
R-2F-5	有り	○	-	-	○	
R-2F-6	有り	○	-	-	○	
R-2F-7	無	○	-	-	○	
R-2F-8	無	○	-	-	○	
R-2F-9上	無	○	-	-	○	
R-2F-9下	有り	○	-	-	○	
R-2F-10上	有り	○	-	-	○	
R-2F-10下	有り	○	-	-	○	
R-2F-11	有り	○	-	-	○	
R-2F-12	有り	○	-	-	○	
R-1F-1	有り	○	-	-	○	

第3表 想定破損による被水影響評価結果まとめ (12/23)

系統名称	機器名称	機器番号	区画番号	被水原因 天井開口 又は貫通部 の有無 ○:有 ○:無	多重化・ 区画化 ○:有 ○:無	防滴仕 様・被水 防護措置 ○:有 ○:無	判定 基準 ○:有 ○:無	対策 実施 ○:有 ○:無	詳細 結果 ○:良 ○:否
非常用1号機	燃料ポンプ駆動機	DG-LITS-5	CS-B1-6	-	○	-	B	-	○
非常用2号機	DGS8ポンプ(2C)	DGS8-PMP-2C	(取水口)	-	-	○	屋外仕様	C	○
非常用3号機	DGS8ポンプ(2D)	DGS8-PMP-2D	(取水口)	-	-	○	屋外仕様	C	○
高圧中心冷却水	DG HPCS 制御盤	DGCP/2H	CS-B1-4	-	○	-	B	-	○
高圧中心冷却水	HPCS DG 中性点接地変圧器盤	PNL-NGT-HPCS	CS-B1-4	-	○	-	B	-	○
高圧中心冷却水	HPCS DG 自動電圧調整器盤	PNL-DG-AVR-HPCS	CS-B1-4	-	○	-	B	-	○
高圧中心冷却水	HPCS DG リンシ整流器盤	PNL-DG-SR-HPCS	CS-B1-4	-	○	-	B	-	○
高圧中心冷却水	HPCS DG 交流ケーブル盤	PNL-ACI-HPCS	CS-B1-4	-	○	-	B	-	○
高圧中心冷却水	HPCS DG リンシ整流器用変圧器盤	PNL-SRT-HPCS	CS-B1-4	-	○	-	B	-	○
高圧中心冷却水	HPCS DG 可飽和変流器盤	PNL-SCT-HPCS	CS-B1-4	-	○	-	B	-	○
高圧中心冷却水	DG HPCS INST. RACK	R-60	CS-B1-4	-	○	-	B	-	○
高圧中心冷却水	DG HPCS DIESEL ENGINE INST. RACK	R-66	CS-B1-4	-	○	-	B	-	○
高圧中心冷却水	HPCS DG 吸気系リフト機/機関	GEN-DG-HPCS/ EG-HPCS	CS-B1-4	-	○	-	B	-	○
高圧中心冷却水	HPCS DG 吸気系リフト機(L側)	DG-HPCS-AE-FLT -INTAKE-L	(C/S層上)	-	-	-	-	-	○
高圧中心冷却水	HPCS DG 吸気系リフト機(R側)	DG-HPCS-AE-FLT -INTAKE-R	(C/S層上)	-	-	-	-	-	○
高圧中心冷却水	HPCS DG 潤滑油ポンプ	DG-VSL-HPCS-DGLO-1	CS-B2-4	-	○	-	B	-	○
高圧中心冷却水	HPCS DG 潤滑油ポンプ	DG-VSL-HPCS-DGLO-2	CS-B1-4	-	○	-	B	-	○
高圧中心冷却水	HPCS DG 潤滑油ポンプ	7-8-DGLO-213	(C/S層上)	-	-	-	-	-	○
高圧中心冷却水	HPCS DG 潤滑油ポンプ	7-6-DGLO-225	(C/S層上)	-	-	-	-	-	○
高圧中心冷却水	HPCS DG 燃料油ポンプ	DG-VSL-HPCS-DO-1	CS-B1-7	-	○	-	B	-	○
高圧中心冷却水	HPCS DG 燃料油ポンプ	3-11/4-90-220	(C/S層上)	-	-	-	-	-	○
高圧中心冷却水	HPCS DG 起動用電磁弁	3-14E24D-1	CS-B1-4	-	○	-	B	-	○
高圧中心冷却水	HPCS DG 起動用電磁弁	3-14E24D-2	CS-B1-4	-	○	-	B	-	○
高圧中心冷却水	燃料ポンプ駆動機	DG-LITS-205	CS-B1-7	-	○	-	B	-	○
非常用1号機	DGS8ポンプ	DGS8-PMP-HPCS	(取水口)	-	-	○	屋外仕様	C	○
2号機	DG 2号機冷却水ポンプ	PV2-10	(C/S層上)	-	-	○	屋外仕様	C	○
2号機	DG 2号機冷却水ポンプ	PV2-11	(C/S層上)	-	-	○	屋外仕様	C	○
2号機	DG 2号機冷却水ポンプ	PV2-6	(C/S層上)	-	-	○	屋外仕様	C	○
2号機	DG 2号機冷却水ポンプ	PV2-7	(C/S層上)	-	-	○	屋外仕様	C	○
2号機	DG HPCS 冷却水ポンプ	PV2-8	(C/S層上)	-	-	○	屋外仕様	C	○
2号機	DG HPCS 冷却水ポンプ	PV2-9	(C/S層上)	-	-	○	屋外仕様	C	○
2号機	DG 室外気取入ポンプ(A)	A0-T41-F060A	(C/S層上)	-	○	-	B	-	○
2号機	DG 室外気取入ポンプ(B)	A0-T41-F060B	(C/S層上)	-	○	-	B	-	○
2号機	DG 室外気取入ポンプ(C)	A0-T41-F060C	(C/S層上)	-	○	-	B	-	○
2号機	DG 室外気取入ポンプ(D)	A0-T41-F060D	(C/S層上)	-	○	-	B	-	○

判定基準
 A: 溢水防護対象設備設置区画に破損を想定する被水がなく、上部の天井開口又は貫通部がない。
 B: 溢水防護対象設備が多重化又は区画化されており、各々が別区画に設置される等により、同時に機能喪失しない。
 C: 溢水防護対象設備が「JIS C 0920 電気機械器具の外部による保護等級 (IPコード)」「NEMA(National Electrical Manufacturers Association)による保護等級」等による防滴仕様を有している。又は溢水防護対象設備を防護するために必要な防護措置がなされている。
 -: 被水による影響あり。

表 2-1 想定破損による被水影響評価結果 (12/20)

系統名称	設備番号	設備名称	設置区画	被水原因・天井開口 又は貫通部の有無 ○:有 ○:無	多重化・ 区画化 ○:有 ○:無	防滴仕 様・被水 防護措置 ○:有 ○:無	判定 基準 ○:有 ○:無	対策 実施 ○:有 ○:無	詳細 結果 ○:良 ○:否	備考
原子炉建屋付風機空調機	M268-5A	A1-非常用電気空調機	R-3F-02N	-	-	-	B	-	○	
原子炉建屋付風機空調機	M268-5B	A2-非常用電気空調機	R-3F-02N	-	-	-	B	-	○	
原子炉建屋付風機空調機	M268-2	B1-非常用電気空調機	R-3F-03N	-	-	-	B	-	○	内部に浸水しない構
原子炉建屋付風機空調機	M268-6A	B2-非常用電気空調機	R-3F-03N	-	-	-	B	-	○	
原子炉建屋付風機空調機	M268-6B	B1-非常用電気空調機	R-3F-03N	-	-	-	B	-	○	
原子炉建屋付風機空調機	M268-7A	B2-非常用電気空調機	R-3F-03N	-	-	-	B	-	○	
原子炉建屋付風機空調機	M268-7B	B1-非常用電気空調機	R-3F-03N	-	-	-	B	-	○	
非常用1号機	LS280-151A	A-06G 燃料ポンプ/減圧	R-31F-01N	-	○	-	B	-	○	
非常用1号機	AV280-300A-1	起動用空気停止弁	R-32F-01N	-	○	-	B	-	○	
非常用1号機	AV280-300A-2	起動用空気停止弁	R-32F-01N	-	○	-	B	-	○	
非常用1号機	CV280-1A	1次水温度調整弁	R-32F-01N	-	○	-	B	-	○	
非常用1号機	CV280-200A	潤滑油温度調整弁	R-32F-01N	-	○	-	B	-	○	
非常用1号機	M280-1A	A-非常用ポンプ	R-32F-01N	-	○	-	B	-	○	
非常用1号機	M280-3A	A-非常用ポンプ	R-32F-01N	-	○	-	B	-	○	
非常用1号機	AV280-300B-1	起動用空気停止弁	R-32F-01N	-	○	-	B	-	○	
非常用1号機	AV280-300B-2	起動用空気停止弁	R-32F-01N	-	○	-	B	-	○	
非常用1号機	CV280-1B	1次水温度調整弁	R-32F-01N	-	○	-	B	-	○	

A: 溢水防護対象設備から放物軌道を考慮した範囲に破損を想定する被水がなく、上部の天井開口又は貫通部がない。
 B: 溢水防護対象設備が多重化又は区画化されており、各々が別区画に設置される等により、同時に機能喪失しない。
 C: 溢水防護対象設備が「JIS C 0920 電気機械器具の外部による保護等級 (IPコード)」「NEMA(National Electrical Manufacturers Association)による保護等級」等による防滴仕様を有している。又は溢水防護対象設備を防護するために必要な防護措置がなされている。

柏崎刈羽原子力発電所 6 / 7号炉 (2017. 12. 20版)

添付5.2-1表 想定破損による被水影響評価結果まとめ

区画	溢水源	一次判定	相対位置 関係考慮	被水対策 実施	最終判定	備考
R-1F-2共	有り	×	-	○	○	区分IIの機器が区分Iの配管破断時に被水する可能性があるため、被水対策(防滴仕様の確認; IP55相当)を実施 可燃性ガス濃度制御系弁 T49-M0-F001B T49-M0-F003B
R-1F-2p1	有り	○	-	-	○	
R-1F-2p2	無し	○	-	-	○	
R-1F-2p3	無し	○	-	-	○	
R-1F-2p4	有り	○	-	-	○	
R-1F-3	有り	○	-	-	○	
R-1F-4	有り	×	○	-	○	区分I, IIIの機器が同一区画に存在するが、隔離、遮蔽により同時機能喪失せず(補足説明資料26参照) 非常用ディーゼル発電機監視操作盤 H21-P600A, C
R-1F-5	有り	○	-	-	○	
R-1F-6	有り	○	-	-	○	
R-1F-7	有り	○	-	-	○	
R-1F-8	有り	○	-	-	○	
R-1F-9	有り	○	-	-	○	
R-1F-10	有り	×	-	○	○	区分Iの機器が区分II又は区分IIIの配管破断時に被水する可能性があるため、被水対策(防滴仕様の確認; IP55相当)を実施 残留熱除去系弁 E11-M0-F005A
R-1F-11	有り	○	-	-	○	

東海第二発電所 (2018. 9. 18版)

第3表 想定破損による被水影響評価結果まとめ (13/23)

系統名称	機器名称	機器番号	区画番号	被水原因 天井開口 又は貫通 部の有無	多量化・ 区画化	防滴仕 様・被水 防護措置	判定 基準	対策 実施	評価 結果
予備機	2D DG 室外気取入ファン(B)	A0-T41-F000E	(C/S 屋上)	-	○	-	B	-	○
予備機	2D DG 室外気取入ファン(F)	A0-T41-F000F	(C/S 屋上)	-	○	-	B	-	○
予備機	2D DG 室外気取入ファン(A)	A0-T41-F001A	(C/S 屋上)	-	○	-	B	-	○
予備機	2D DG 室外気取入ファン(B)	A0-T41-F001B	(C/S 屋上)	-	○	-	B	-	○
予備機	2D DG 室外気取入ファン(C)	A0-T41-F001C	(C/S 屋上)	-	○	-	B	-	○
予備機	2D DG 室外気取入ファン(D)	A0-T41-F001D	(C/S 屋上)	-	○	-	B	-	○
予備機	HVAC D/G 2D EQUIP ROOM VENTILATING SYS.	PNL-T41-F008	CS-B1-3	-	○	-	B	-	○
予備機	HPCS DG 室外気取入ファン(A)	A0-T41-F002A	(C/S 屋上)	-	○	-	B	-	○
予備機	HPCS DG 室外気取入ファン(B)	A0-T41-F002B	(C/S 屋上)	-	○	-	B	-	○
予備機	HPCS DG 室外気取入ファン(C)	A0-T41-F002C	(C/S 屋上)	-	○	-	B	-	○
予備機	HPCS DG 室外気取入ファン(D)	A0-T41-F002D	(C/S 屋上)	-	○	-	B	-	○
予備機	HPCS DG 室外気取入ファン(A)	A0-T41-F003A	(C/S 屋上)	-	○	-	B	-	○
予備機	HPCS DG 室外気取入ファン(B)	A0-T41-F003B	(C/S 屋上)	-	○	-	B	-	○
予備機	HPCS DG 室外気取入ファン(C)	A0-T41-F003C	(C/S 屋上)	-	○	-	B	-	○
予備機	HPCS DG 室外気取入ファン(D)	A0-T41-F003D	(C/S 屋上)	-	○	-	B	-	○
予備機	HVAC D/G HPCS EQUIP ROOM VENTILATING SYS.	PNL-T41-F009	CS-B1-4	-	○	-	B	-	○
予備機	2C DG 室外気取入ファン(A)	A0-T41-F004A	(C/S 屋上)	-	○	-	B	-	○
予備機	2C DG 室外気取入ファン(B)	A0-T41-F004B	(C/S 屋上)	-	○	-	B	-	○
予備機	2C DG 室外気取入ファン(C)	A0-T41-F004C	(C/S 屋上)	-	○	-	B	-	○
予備機	2C DG 室外気取入ファン(D)	A0-T41-F004D	(C/S 屋上)	-	○	-	B	-	○
予備機	2C DG 室外気取入ファン(A)	A0-T41-F005A	(C/S 屋上)	-	○	-	B	-	○
予備機	2C DG 室外気取入ファン(B)	A0-T41-F005B	(C/S 屋上)	-	○	-	B	-	○
予備機	2C DG 室外気取入ファン(C)	A0-T41-F005C	(C/S 屋上)	-	○	-	B	-	○
予備機	2C DG 室外気取入ファン(D)	A0-T41-F005D	(C/S 屋上)	-	○	-	B	-	○
予備機	HVAC D/G 2C EQUIP ROOM VENTILATING SYS.	PNL-T41-F010	CS-B1-5	-	○	-	B	-	○
予備機	燃料移送ポンプ(A)	DO-PMP-A	(屋外)	-	-	-	-	-	○
予備機	燃料移送ポンプ(B)	DO-PMP-B	(屋外)	-	-	-	-	-	○
予備機	燃料移送ポンプ(C)	DO-PMP-C	(屋外)	-	-	-	-	-	○
予備機	軽油貯蔵タンク	-	(屋外)	-	-	-	-	-	○
予備機	MAIN STEAM LINE (A) RADIATION MONITOR(検出器)	D17-N003A	BB-3-2	-	-	-	-	-	○
予備機	MAIN STEAM LINE (B) RADIATION MONITOR(検出器)	D17-N003B	BB-3-2	-	-	-	-	-	○
予備機	MAIN STEAM LINE (C) RADIATION MONITOR(検出器)	D17-N003C	BB-3-2	-	-	-	-	-	○
予備機	MAIN STEAM LINE (D) RADIATION MONITOR(検出器)	D17-N003D	BB-3-2	-	-	-	-	-	○
予備機	原子炉建屋排気筒1(F) (A)	D17-N009A	CS-3-2	○	-	-	A	-	○
予備機	原子炉建屋排気筒1(F) (B)	D17-N009B	CS-3-2	○	-	-	A	-	○

判定基準
A: 雨水防護対象設備設置区画に破損を想定する被水原因がなく、上部の天井面に開口部又は貫通部がない。
B: 雨水防護対象設備が多量化又は区画化されており、各々が別区画に設置される等により、同時に機能喪失しない。
C: 雨水防護対象設備が「JIS C 0920 電気機械器具の外部による保護等級 (IPコード)」「NEMA (National Electrical Manufacturers Association)による保護等級」等による防滴仕様を有している。又は雨水防護対象設備を防護するために必要な防護措置がなされている。
-: 被水による影響あり。

島根原子力発電所 2号炉

備考

表2-1 想定破損による被水影響評価結果 (13/20)

系統名称	設備番号	設備名称	設置区画	被水原因・天井開口 又は貫通部の有無	多量化・ 区画化	防滴仕 様・被水 防護措置	判定 基準	対策 実施	評価 結果
非常用予備機	CV280-200B	潤滑油温度調整弁	R-BE1-00N	-	○	-	B	-	○
非常用予備機	M280-1B	B-非常用予備機	R-BE1-00N	-	○	-	B	-	○
非常用予備機	M280-3B	B-非常用予備機	R-BE1-00N	-	○	-	B	-	○
非常用予備機	AV280-300H-1	始動用空気停止弁	R-BE1-07N	-	○	-	B	-	○
非常用予備機	AV280-300H-2	始動用空気停止弁	R-BE1-07N	-	○	-	B	-	○
非常用予備機	CV280-1H	1次水温調整弁	R-BE1-07N	-	○	-	B	-	○
非常用予備機	CV280-200H	潤滑油温度調整弁	R-BE1-07N	-	○	-	B	-	○
非常用予備機	M280-1H	高圧炉心炉心リレー系予備機	R-BE1-07N	-	○	-	B	-	○
非常用予備機	M280-3H	高圧炉心炉心リレー系予備機	R-BE1-07N	-	○	-	B	-	○
非常用予備機	LS280-151B	B-065燃料ポンプ	R-BIF-06N	-	○	-	B	-	○
非常用予備機	LS280-151H	H-065燃料ポンプ	R-BIF-06N	-	○	-	B	-	○
非常用予備機	P280-1A	A-燃料移送ポンプ	Y-18N	-	○	-	B	-	○
非常用予備機	P280-1B	B-燃料移送ポンプ	V-72N	-	○	-	B	-	○
非常用予備機	P280-1H	高圧炉心炉心リレー系燃料移送 ポンプ	V-23N	-	○	-	B	-	○
非常用予備機	W285-1	DMMポンプ入口弁	R-BIF-01N	-	○	-	B	-	○
非常用予備機	W285-2	DMMポンプ出口弁	R-BIF-01N	-	○	-	B	-	○
非常用予備機	P285-1	燃料ポンプ補助ポンプ	R-BIF-01N	-	○	-	B	-	○

A: 雨水防護対象設備から外部から破損を想定する被水原因がなく、上部の天井面に開口部又は貫通部がない。
B: 雨水防護対象設備が多量化又は区画化されており、各々が別区画に設置される等により、同時に機能喪失しない。
C: 雨水防護対象設備が「JIS C 0920 電気機械器具の外部による保護等級 (IPコード)」「NEMA (National Electrical Manufacturers Association)による保護等級」等による防滴仕様を有している。又は雨水防護対象設備を防護するために必要な防護措置がなされている。

添付 5.2-1 表 7 号炉 想定破損による被水影響評価結果まとめ

区画	溢水源	一次判定	相対位置 関係考慮	被水対策 実施	最終判定	備考
R-1F-12	有り	×	-	○	○	区分 I, II の機器が同一区画に存在するため被水対策(区画内溢水源の想定除外)を実施 可燃性ガス濃度制御系(A), (B)
R-B-14	有り	○	-	-	○	区分 I, II の機器が同一区画に存在するが, 隔離, 遮蔽により同時機能喪失せず(補足説明資料26参照) 残留熱除去系弁 E11-MO-F014A, B 可燃性ガス濃度制御系弁 T49-MO-F010A, B
R-B-15	有り	×	○	-	○	区分 I, II の機器が同一区画に存在するが, 隔離, 遮蔽により同時機能喪失せず(補足説明資料26参照) 原子炉格納容器エリア放射線量率(高レンジ) D23-RE-006A, B
R-B1-3	無	○	-	-	○	
R-B1-4	有り	○	-	-	○	
R-B1-5	有り	○	-	-	○	
R-B1-6	有り	○	-	-	○	
R-B1-7	無	○	-	-	○	
R-B1-8	無	○	-	-	○	
R-B1-9	無	○	-	-	○	
R-B1-10	有り	○	-	-	○	
R-B1-11	有り	○	-	-	○	
R-B1-12	無	○	-	-	○	
R-B1-13	有り	○	-	-	○	
R-B1-16	有り	○	-	-	○	

柏崎刈羽原子力発電所 6 / 7 号炉 (2017. 12. 20 版)

第 3 表 想定破損による被水影響評価結果まとめ (14/23)

系統名称	機器名称	機器番号	区画番号	被水原因 天井開口 又は貫通部 の有無 ○:有 ○:無	多重化・ 区画化 ○:有 ○:無	防護仕 様 被水 防護措置 ○:有 ○:無	判定 基準 ○:有 ○:無	対策 実施 ○:有 ○:無	評価 結果 ○:良 ×:否
原子炉保護系	原子炉建屋排気筒(3) (C) (検出器)	D17-N006C	CS-3-2	○	-	-	A	-	○
原子炉保護系	原子炉建屋排気筒(3) (D) (検出器)	D17-N006D	CS-3-2	○	-	-	A	-	○
原子炉保護系	R/B REFUELING EXHAUST RADIATION MONITOR (A) (検出器)	D17-N300A	RB-6-1	-	-	-	-	○	○
原子炉保護系	R/B REFUELING EXHAUST RADIATION MONITOR (B) (検出器)	D17-N300B	RB-6-1	-	-	-	-	○	○
原子炉保護系	R/B REFUELING EXHAUST RADIATION MONITOR (C) (検出器)	D17-N300C	RB-6-1	-	-	-	-	○	○
原子炉保護系	R/B REFUELING EXHAUST RADIATION MONITOR (D) (検出器)	D17-N300D	RB-6-1	-	-	-	-	○	○
原子炉保護系	OFF GAS PRE HOLD UP (A) アフタ	RAM-D17-K020A	TB-1-2	-	-	-	-	○	○
原子炉保護系	OFF GAS PRE HOLD UP (B) アフタ	RAM-D17-K020B	TB-1-2	-	-	-	-	○	○
原子炉保護系	OFF GAS PRE HOLD UP (A) (検出器)	D17-N002A	TB-B1-1	-	-	-	-	○	○
原子炉保護系	OFF GAS PRE HOLD UP (B) (検出器)	D17-N002B	TB-B1-1	-	-	-	-	○	○
原子炉保護系	OFF GAS PRE TREATMENT (A) アフタ	RAM-D17-K030A	RB-2-11	-	-	-	-	○	○
原子炉保護系	OFF GAS PRE TREATMENT (B) アフタ	RAM-D17-K030B	RB-2-11	-	-	-	-	○	○
原子炉保護系	OFF GAS PRE TREATMENT (A) (検出器)	D17-N022A	RB-2-11	-	-	-	-	○	○
原子炉保護系	OFF GAS PRE TREATMENT (B) (検出器)	D17-N022B	RB-2-11	-	-	-	-	○	○
原子炉保護系	OFF GAS POST TREATMENT (A) アフタ	RAM-D17-K500A	RB-2-3	-	-	-	-	○	○
原子炉保護系	OFF GAS POST TREATMENT (B) アフタ	RAM-D17-K500B	RB-2-3	-	-	-	-	○	○
原子炉保護系	OFF GAS POST TREATMENT SAMPLE BACK	D17-J011	RB-2-3	-	-	-	-	○	○
原子炉保護系	OFF GAS POST TREATMENT SAMPLE BACK	D17-J011-1	RB-2-3	-	-	-	-	○	○
原子炉保護系	OFF GAS PRE HOLD UP LINEAR (検出器)	D17-N021	TB-B1-1	-	-	-	-	○	○
原子炉保護系	光度検出器受納盤	D17-P112	CS-B1-1	○	-	-	A	-	○
原子炉保護系	光度検出器受納盤	-	3/F建屋	○	-	-	A	-	○
原子炉保護系	排気筒(1)盤	D17-P012	3/F建屋	○	-	-	A	-	○
原子炉保護系	主排気筒(1) アフタ(A)	D17-P101A	3/F建屋	○	-	-	A	-	○
原子炉保護系	主排気筒(1) アフタ(B)	D17-P101B	3/F建屋	○	-	-	A	-	○
ほうばり水注入系	SLC 貯蔵(2)F	RZ2-P011	RB-5-3	-	-	-	-	○	○
ほうばり水注入系	ほうばり水注入ポンプ(A)	SLC-PMP-C001A	RB-5-3	-	-	-	-	○	○
ほうばり水注入系	ほうばり水注入ポンプ(B)	SLC-PMP-C001B	RB-5-3	-	-	-	-	○	○
ほうばり水注入系	ほうばり水貯蔵(2)F	SLC-VSL-A001	RB-5-3	-	-	-	-	○	○
ほうばり水注入系	SLC 貯蔵(2)F出口弁(A)	C41-F001A(00)	RB-5-3	-	-	-	-	○	○
ほうばり水注入系	SLC 貯蔵(2)F出口弁(B)	C41-F001B(00)	RB-5-3	-	-	-	-	○	○
ほうばり水注入系	SLC 導流弁(A)	C41-F004A	RB-5-3	-	-	-	-	○	○
ほうばり水注入系	SLC 導流弁(B)	C41-F004B	RB-5-3	-	-	-	-	○	○
ほうばり水注入系	SLC 3分停止弁(1)F3弁	C41-F7004(00)	RB-3-2	-	-	-	-	○	○
ほうばり水注入系	SLC PMP DISCH PRESS (伝送器)	PT-C41-3004	RB-5-3	-	-	-	-	○	○
補機冷却水系	ASV ボンプ(A)	ASV-PMP-A	(取水口)	-	-	○屋外仕様	C	-	○
補機冷却水系	ASV ボンプ(B)	ASV-PMP-B	(取水口)	-	-	○屋外仕様	C	-	○

判定基準
 A : 溢水防護対象設備設置区画に破損を想定する被水原因がなく, 上部の天井開口又は貫通部がない。
 B : 溢水防護対象設備が多重化又は区画化されており, 各々が別区画に設置される等により, 同時に機能喪失しない。
 C : 溢水防護対象設備が「JIS C 0920 電気機械器具の外装による保護等級 (IPコード)」(NEMA National Electrical Manufacturers Association)による保護等級) 等による防護仕様を有している。又は溢水防護対象設備を防護するために必要な防護措置がなされている。
 - : 被水による影響あり。

東海第二発電所 (2018. 9. 18 版)

島根原子力発電所 2号炉

備考

表 2-1 想定破損による被水影響評価結果 (14/20)

系統名称	設備番号	設備名称	設置区画	被水原因 天井開口 又は貫通部 の有無 ○:有 ○:無	多重化・ 多層化 ○:有 ○:無	防護仕様 ○:有 ○:無	判定 基準 ○:有 ○:無	対策 実施 ○:有 ○:無	評価結果 ○:良 ×:否	備考
原子炉保護系	Pos206-0A-1	主蒸気調整弁開度スイッチ	R-1F-00N R-1F-20N	-	○	-	B	-	○	
原子炉保護系	Pos206-0A-2	主蒸気調整弁開度スイッチ	R-1F-00N R-1F-20N	-	○	-	B	-	○	
原子炉保護系	Pos206-0B-1	主蒸気調整弁開度スイッチ	R-1F-00N R-1F-20N	-	○	-	B	-	○	
原子炉保護系	Pos206-0B-2	主蒸気調整弁開度スイッチ	R-1F-00N R-1F-20N	-	○	-	B	-	○	
原子炉保護系	Pos206-0C-1	主蒸気調整弁開度スイッチ	R-1F-00N R-1F-20N	-	○	-	B	-	○	
原子炉保護系	Pos206-0C-2	主蒸気調整弁開度スイッチ	R-1F-00N R-1F-20N	-	○	-	B	-	○	
原子炉保護系	Pos206-0D-1	主蒸気調整弁開度スイッチ	R-1F-00N R-1F-20N	-	○	-	B	-	○	
原子炉保護系	Pos206-0D-2	主蒸気調整弁開度スイッチ	R-1F-00N R-1F-20N	-	○	-	B	-	○	
原子炉保護系	AMP206-20A	A-格納容器蒸気スイッチ(1) F7	R-R1F-10N	-	○	-	B	-	○	
原子炉保護系	RE206-20A	A-格納容器蒸気スイッチ(1) F7	R-R2F-31N	-	-	○	C	IP55	○	PVC遮蔽内に設置されて おり, 被水しない
原子炉保護系	RE206-20B	B-格納容器蒸気スイッチ(1) F7	R-R2F-31N	-	-	○	C	IP55	○	
原子炉保護系	AMP206-20A	A-格納容器蒸気スイッチ(1) F7	R-1F-02N	-	○	○	B	IPX5	○	
原子炉保護系	RE206-20A	A-格納容器蒸気スイッチ(1) F7	R-1F-07-1N	-	○	-	B	-	○	
原子炉保護系	AMP206-20B	B-格納容器蒸気スイッチ(1) F7	R-1F-15N	-	○	-	B	-	○	
原子炉保護系	RE206-20B	B-格納容器蒸気スイッチ(1) F7	R-1F-12N	-	○	-	B	-	○	
原子炉保護系	AMP206-20B	B-格納容器蒸気スイッチ(1) F7	R-R1F-17-1N	-	○	-	B	-	○	
原子炉保護系	2-V006-4A	A-排気筒(1) アフタ	V-30N	○	-	-	A	-	○	

A : 溢水防護対象設備から放射線道を考慮した範囲に破損を想定する被水原因がなく, 上部の天井開口又は貫通部がない。
 B : 溢水防護対象設備が多重化又は多層化されており, 各々が別区画に設置される等により, 同時に機能喪失しない。
 C : 溢水防護対象設備が「JIS C 0920 電気機械器具の外装による保護等級 (IPコード)」による防護仕様を有している。
 - : 溢水による影響あり。

添付5.2-1表 7号炉 想定破損による被水影響評価結果まとめ

柏崎刈羽原子力発電所 6 / 7号炉 (2017.12.20版)

Table with columns: 区画, 溢水源, 一次判定, 相対位置関係考慮, 被水対策実施, 最終判定, 備考. Row R-B2-2 has '有り' for overflow source and '×' for relative position consideration. The note mentions '区分Ⅰ,Ⅱ,Ⅲの機器が同一区画に存在するため,被水対策(防滴仕様の確認;IP55相当)を実施'.

東海第二発電所 (2018.9.18版)

第3表 想定破損による被水影響評価結果まとめ (15/23)

Table with columns: 系統名称, 機器名称, 機器番号, 区画番号, 被水源, 多量化・区画化, 防滴仕様・被水防護措置, 判定基準, 対策実施, 評価結果. Lists various equipment like ASWポンプ, MSL AREA TEMP, and their statuses.

判定基準 A: 被水防護対象設備設置区画に破損を想定する被水がなく、上部の天井面に開口部又は貫通部がない。 B: 被水防護対象設備が多量化又は区画化されており、各々が別区画に設置される等により、同時に機能喪失しない。 C: 被水防護対象設備が「JIS C 0920 電気機械器具の外部による保護等級 (IPコード)」「NEMA (National Electrical Manufacturers Association) による保護等級」等による防滴仕様を有している。又は被水防護対象設備を防護するために必要な防護措置がなされている。
--: 被水による影響あり。

島根原子力発電所 2号炉

表 2-1 想定破損による被水影響評価結果 (15/20)

Table with columns: 系統名称, 設備番号, 設備名称, 設置区画, 被水源, 多量化・多量化, 防滴仕様, 判定基準, 保護等級, 評価結果, 備考. Includes details for pressure gauges (A-1, B-1, C-1, D-1) and flow meters (A-RRR, B-RRR, C-RRR, D-RRR).

A: 被水防護対象設備から放物軌道を考慮した範囲に破損を想定する被水がなく、上部の天井面に開口部又は貫通部がない。 B: 被水防護対象設備が多量化又は区画化されており、各々が別区画に設置される等により、同時に機能喪失しない。 C: 被水防護対象設備が「JIS C 0920 電気機械器具の外部による保護等級 (IPコード)」による防滴仕様を有している。又は被水防護対象設備を防護するために必要な防護措置がなされている。

備考

添付 5. 2-1 表 7 号炉 想定破損による被水影響評価結果まとめ

柏崎刈羽原子力発電所 6 / 7 号炉 (2017. 12. 20 版)

Table with 7 columns: 区画, 溢水源, 一次判定, 相対位置関係考慮, 被水対策実施, 最終判定, 備考. Rows include T-1F-2 through C-1F-4A and C-2F-3.

区分IIIの区画内に区分Iの配管が存在するため、被水対策(区分Iの溢水源(原子炉補機冷却水系(A))の想定除外)を実施

原子炉補機冷却水系(C)

区分I, IIの機器が同一区画に存在するため被水対策(区画内溢水源の想定除外)を実施

中央制御室換気空調系(A), (B)

東海第二発電所 (2018. 9. 18 版)

第 3 表 想定破損による被水影響評価結果まとめ (16/23)

Table with 8 columns: 系統名称, 機器名称, 機器番号, 区画番号, 被水源, 多重化・区画化, 防滴仕様・被水防護措置, 判定基準, 対策実施, 評価結果. Rows include MSL AREA TEMP and FCS systems.

判定基準
A: 被水防護対象設備設置区画に破損を想定する被水源がなく、上部の天井面に開口部又は貫通部がない。
B: 被水防護対象設備が多重化又は区画化されており、各々が別区画に設置される等により、同時に機能喪失しない。
C: 被水防護対象設備が「JIS C 0920 電気機械器具の外装による保護等級 (IP コード)」 「NEMA(National Electrical Manufacturers Association)による保護等級」等による防滴仕様を有している。又は被水防護対象設備を防護するために必要な防護措置がなされている。

島根原子力発電所 2号炉

表 2-1 想定破損による被水影響評価結果 (16/20)

Table with 9 columns: 系統名称, 設備番号, 設備名称, 設置区画, 被水原・圧力開口又は貫通部の有無, 多重化・多様化, 防滴仕様, 判定基準, 評価結果. Rows include A-RLE and B-RLE equipment.

A: 被水防護対象設備から放物軌道を考慮した範囲に破損を想定する被水源がなく、上部の天井面に開口部又は貫通部がない。
B: 被水防護対象設備が多重化又は多様化されており、各々が別区画に設置される等により、同時に機能喪失しない。
C: 被水防護対象設備が「JIS C 0920 電気機械器具の外装による保護等級 (IP コード)」による防滴仕様を有している。又は被水防護対象設備を防護するために必要な対策がなされている。

備考

添付5.2-1表 7号炉 想定破損による被水影響評価結果まとめ

区画	溢水源	一次判定	相対位置関係考慮	被水対策実施	最終判定	備考
C-1F-4B	有り	×	-	○	○	区分IIの区画内に区分Iの配管が存在するため被水対策(区分Iの溢水源(換気空調補機非常用冷却水系(A))の想定除外)を実施
C-1F-5	有り	○	-	-	○	コントロール建屋計測制御電源盤区域(B)換気空調系
C-1F-6	無	○	-	-	○	区分I, IIの機器が同一区画に存在するため被水対策(区画内溢水源の想定除外)を実施
C-1F-7	有り	×	-	○	○	中央制御室換気空調系(A), (B)
C-1F-8	無	○	-	-	○	
C-1F-9	無	○	-	-	○	
C-1F-10	有り	○	-	-	○	
C-1F-11	無	○	-	-	○	
C-B1-1	有り	○	-	-	○	
C-B1-2	無	○	-	-	○	
C-B1-3	無	○	-	-	○	
C-B1-4	無	○	-	-	○	
C-B1-5	無	○	-	-	○	
C-B1-6	有り	×	-	○	○	区分IIIの区画内に区分I, IIの配管が存在するため、被水対策(区分I, IIの溢水源(換気空調補機非常用冷却水系(A), (B))の想定除外)を実施
C-B1-7	無	○	-	-	○	コントロール建屋計測制御電源盤区域(C)換気空調系
C-B1-8A	有り	○	-	-	○	
C-B1-8C	有り	○	-	-	○	
C-B1-9	無	○	-	-	○	
C-B1-10	無	○	-	-	○	
C-B1-11	無	○	-	-	○	

柏崎刈羽原子力発電所 6 / 7号炉 (2017.12.20版)

東海第二発電所 (2018.9.18版)

第3表 想定破損による被水影響評価結果まとめ (17/23)

系統名称	機器名称	機器番号	区画番号	被水源 天井開口 又は貫通部の有無	多重化・ 区画化	防漏仕 様・被水 防護措置	判定 基準	対策 実施	評価 結果
				○:有 ●:無	○:有 ●:無	○:有 ●:無	○:有 ●:無	○:有 ●:無	○:良 ●:否
可燃性 ³ A濃度制御系	PCS(A)系出口管隔離弁	2-43V-3A(00)	RB-1-1	-	-	-	-	-	○
可燃性 ³ B濃度制御系	PCS(B)系出口管隔離弁	2-43V-3B(00)	RB-1-2	-	-	-	-	-	○
可燃性 ³ A入口 ³ A温度(検出器)	TE-T49-2A	RB-3-1	RB-3-1	-	○	-	B	-	○
可燃性 ³ B入口 ³ B温度(検出器)	TE-T49-2B	RB-3-2	RB-3-2	-	○	-	B	-	○
可燃性 ³ A濃度制御系	加熱管 2/3 位置(A) 温度(検出器)	TE-T49-4A	RB-3-1	-	○	-	B	-	○
可燃性 ³ B濃度制御系	加熱管 2/3 位置(B) 温度(検出器)	TE-T49-4B	RB-3-2	-	○	-	B	-	○
可燃性 ³ A濃度制御系	加熱管(A) 出口 温度(検出器)	TE-T49-5A	RB-3-1	-	○	-	B	-	○
可燃性 ³ B濃度制御系	加熱管(B) 出口 温度(検出器)	TE-T49-5B	RB-3-2	-	○	-	B	-	○
可燃性 ³ A濃度制御系	加熱管(A) 出口壁温度(検出器)	TE-T49-6A	RB-3-1	-	○	-	B	-	○
可燃性 ³ B濃度制御系	加熱管(B) 出口壁温度(検出器)	TE-T49-6B	RB-3-2	-	○	-	B	-	○
可燃性 ³ A濃度制御系	再結合(A) 温度(検出器)	TE-T49-7A	RB-3-1	-	○	-	B	-	○
可燃性 ³ B濃度制御系	再結合(B) 温度(検出器)	TE-T49-7B	RB-3-2	-	○	-	B	-	○
可燃性 ³ A濃度制御系	再結合器(A) 壁温度(検出器)	TE-T49-8A	RB-3-1	-	○	-	B	-	○
可燃性 ³ B濃度制御系	再結合器(B) 壁温度(検出器)	TE-T49-8B	RB-3-2	-	○	-	B	-	○
可燃性 ³ A濃度制御系	再循環(A) 温度(検出器)	TE-T49-9A	RB-3-1	-	○	-	B	-	○
可燃性 ³ B濃度制御系	再循環(B) 温度(検出器)	TE-T49-9B	RB-3-2	-	○	-	B	-	○
原子炉隔離時冷却系	RCIC DIV-II 計装???	R22-P017	RB-B1-1	-	-	○IP67	C	-	○
原子炉隔離時冷却系	RCIC DIV-II 計装???	R22-P029	RB-B1-9	-	-	○IP67	C	-	○
原子炉隔離時冷却系	RCIC TURBINE CONTROL BOX	LCP-105	CS-3-1	-	-	-	B	-	○
原子炉隔離時冷却系	FI-E51-3002 計器収納箱	-	RB-B2-10	-	-	-	B	-	○
原子炉隔離時冷却系	RCIC 8' x 7' x 6' x 5' x 4' x 3' x 2' x 1' x 0' x -1' x -2' x -3' x -4' x -5' x -6' x -7' x -8' x -9' x -10' x -11' x -12' x -13' x -14' x -15' x -16' x -17' x -18' x -19' x -20' x -21' x -22' x -23' x -24' x -25' x -26' x -27' x -28' x -29' x -30' x -31' x -32' x -33' x -34' x -35' x -36' x -37' x -38' x -39' x -40' x -41' x -42' x -43' x -44' x -45' x -46' x -47' x -48' x -49' x -50' x -51' x -52' x -53' x -54' x -55' x -56' x -57' x -58' x -59' x -60' x -61' x -62' x -63' x -64' x -65' x -66' x -67' x -68' x -69' x -70' x -71' x -72' x -73' x -74' x -75' x -76' x -77' x -78' x -79' x -80' x -81' x -82' x -83' x -84' x -85' x -86' x -87' x -88' x -89' x -90' x -91' x -92' x -93' x -94' x -95' x -96' x -97' x -98' x -99' x -100' x -101' x -102' x -103' x -104' x -105' x -106' x -107' x -108' x -109' x -110' x -111' x -112' x -113' x -114' x -115' x -116' x -117' x -118' x -119' x -120' x -121' x -122' x -123' x -124' x -125' x -126' x -127' x -128' x -129' x -130' x -131' x -132' x -133' x -134' x -135' x -136' x -137' x -138' x -139' x -140' x -141' x -142' x -143' x -144' x -145' x -146' x -147' x -148' x -149' x -150' x -151' x -152' x -153' x -154' x -155' x -156' x -157' x -158' x -159' x -160' x -161' x -162' x -163' x -164' x -165' x -166' x -167' x -168' x -169' x -170' x -171' x -172' x -173' x -174' x -175' x -176' x -177' x -178' x -179' x -180' x -181' x -182' x -183' x -184' x -185' x -186' x -187' x -188' x -189' x -190' x -191' x -192' x -193' x -194' x -195' x -196' x -197' x -198' x -199' x -200' x -201' x -202' x -203' x -204' x -205' x -206' x -207' x -208' x -209' x -210' x -211' x -212' x -213' x -214' x -215' x -216' x -217' x -218' x -219' x -220' x -221' x -222' x -223' x -224' x -225' x -226' x -227' x -228' x -229' x -230' x -231' x -232' x -233' x -234' x -235' x -236' x -237' x -238' x -239' x -240' x -241' x -242' x -243' x -244' x -245' x -246' x -247' x -248' x -249' x -250' x -251' x -252' x -253' x -254' x -255' x -256' x -257' x -258' x -259' x -260' x -261' x -262' x -263' x -264' x -265' x -266' x -267' x -268' x -269' x -270' x -271' x -272' x -273' x -274' x -275' x -276' x -277' x -278' x -279' x -280' x -281' x -282' x -283' x -284' x -285' x -286' x -287' x -288' x -289' x -290' x -291' x -292' x -293' x -294' x -295' x -296' x -297' x -298' x -299' x -300' x -301' x -302' x -303' x -304' x -305' x -306' x -307' x -308' x -309' x -310' x -311' x -312' x -313' x -314' x -315' x -316' x -317' x -318' x -319' x -320' x -321' x -322' x -323' x -324' x -325' x -326' x -327' x -328' x -329' x -330' x -331' x -332' x -333' x -334' x -335' x -336' x -337' x -338' x -339' x -340' x -341' x -342' x -343' x -344' x -345' x -346' x -347' x -348' x -349' x -350' x -351' x -352' x -353' x -354' x -355' x -356' x -357' x -358' x -359' x -360' x -361' x -362' x -363' x -364' x -365' x -366' x -367' x -368' x -369' x -370' x -371' x -372' x -373' x -374' x -375' x -376' x -377' x -378' x -379' x -380' x -381' x -382' x -383' x -384' x -385' x -386' x -387' x -388' x -389' x -390' x -391' x -392' x -393' x -394' x -395' x -396' x -397' x -398' x -399' x -400' x -401' x -402' x -403' x -404' x -405' x -406' x -407' x -408' x -409' x -410' x -411' x -412' x -413' x -414' x -415' x -416' x -417' x -418' x -419' x -420' x -421' x -422' x -423' x -424' x -425' x -426' x -427' x -428' x -429' x -430' x -431' x -432' x -433' x -434' x -435' x -436' x -437' x -438' x -439' x -440' x -441' x -442' x -443' x -444' x -445' x -446' x -447' x -448' x -449' x -450' x -451' x -452' x -453' x -454' x -455' x -456' x -457' x -458' x -459' x -460' x -461' x -462' x -463' x -464' x -465' x -466' x -467' x -468' x -469' x -470' x -471' x -472' x -473' x -474' x -475' x -476' x -477' x -478' x -479' x -480' x -481' x -482' x -483' x -484' x -485' x -486' x -487' x -488' x -489' x -490' x -491' x -492' x -493' x -494' x -495' x -496' x -497' x -498' x -499' x -500' x -501' x -502' x -503' x -504' x -505' x -506' x -507' x -508' x -509' x -510' x -511' x -512' x -513' x -514' x -515' x -516' x -517' x -518' x -519' x -520' x -521' x -522' x -523' x -524' x -525' x -526' x -527' x -528' x -529' x -530' x -531' x -532' x -533' x -534' x -535' x -536' x -537' x -538' x -539' x -540' x -541' x -542' x -543' x -544' x -545' x -546' x -547' x -548' x -549' x -550' x -551' x -552' x -553' x -554' x -555' x -556' x -557' x -558' x -559' x -560' x -561' x -562' x -563' x -564' x -565' x -566' x -567' x -568' x -569' x -570' x -571' x -572' x -573' x -574' x -575' x -576' x -577' x -578' x -579' x -580' x -581' x -582' x -583' x -584' x -585' x -586' x -587' x -588' x -589' x -590' x -591' x -592' x -593' x -594' x -595' x -596' x -597' x -598' x -599' x -600' x -601' x -602' x -603' x -604' x -605' x -606' x -607' x -608' x -609' x -610' x -611' x -612' x -613' x -614' x -615' x -616' x -617' x -618' x -619' x -620' x -621' x -622' x -623' x -624' x -625' x -626' x -627' x -628' x -629' x -630' x -631' x -632' x -633' x -634' x -635' x -636' x -637' x -638' x -639' x -640' x -641' x -642' x -643' x -644' x -645' x -646' x -647' x -648' x -649' x -650' x -651' x -652' x -653' x -654' x -655' x -656' x -657' x -658' x -659' x -660' x -661' x -662' x -663' x -664' x -665' x -666' x -667' x -668' x -669' x -670' x -671' x -672' x -673' x -674' x -675' x -676' x -677' x -678' x -679' x -680' x -681' x -682' x -683' x -684' x -685' x -686' x -687' x -688' x -689' x -690' x -691' x -692' x -693' x -694' x -695' x -696' x -697' x -698' x -699' x -700' x -701' x -702' x -703' x -704' x -705' x -706' x -707' x -708' x -709' x -710' x -711' x -712' x -713' x -714' x -715' x -716' x -717' x -718' x -719' x -720' x -721' x -722' x -723' x -724' x -725' x -726' x -727' x -728' x -729' x -730' x -731' x -732' x -733' x -734' x -735' x -736' x -737' x -738' x -739' x -740' x -741' x -742' x -743' x -744' x -745' x -746' x -747' x -748' x -749' x -750' x -751' x -752' x -753' x -754' x -755' x -756' x -757' x -758' x -759' x -760' x -761' x -762' x -763' x -764' x -765' x -766' x -767' x -768' x -769' x -770' x -771' x -772' x -773' x -774' x -775' x -776' x -777' x -778' x -779' x -780' x -781' x -782' x -783' x -784' x -785' x -786' x -787' x -788' x -789' x -790' x -791' x -792' x -793' x -794' x -795' x -796' x -797' x -798' x -799' x -800' x -801' x -802' x -803' x -804' x -805' x -806' x -807' x -808' x -809' x -810' x -811' x -812' x -813' x -814' x -815' x -816' x -817' x -818' x -819' x -820' x -821' x -822' x -823' x -824' x -825' x -826' x -827' x -828' x -829' x -830' x -831' x -832' x -833' x -834' x -835' x -836' x -837' x -838' x -839' x -840' x -841' x -842' x -843' x -844' x -845' x -846' x -847' x -848' x -849' x -850' x -851' x -852' x -853' x -854' x -855' x -856' x -857' x -858' x -859' x -860' x -861' x -862' x -863' x -864' x -865' x -866' x -867' x -868' x -869' x -870' x -871' x -872' x -873' x -874' x -875' x -876' x -877' x -878' x -879' x -880' x -881' x -882' x -883' x -884' x -885' x -886' x -887' x -888' x -889' x -890' x -891' x -892' x -893' x -894' x -895' x -896' x -897' x -898' x -899' x -900' x -901' x -902' x -903' x -904' x -905' x -906' x -907' x -908' x -909' x -910' x -911' x -912' x -913' x -914' x -915' x -916' x -917' x -918' x -919' x -920' x -921' x -922' x -923' x -924' x -925' x -926' x -927' x -928' x -929' x -930' x -931' x -932' x -933' x -934' x -935' x -936' x -937' x -938' x -939' x -940' x -941' x -942' x -943' x -944' x -945' x -946' x -947' x -948' x -949' x -950' x -951' x -952' x -953' x -954' x -955' x -956' x -957' x -958' x -959' x -960' x -961' x -962' x -963' x -964' x -965' x -966' x -967' x -968' x -969' x -970' x -971' x -972' x -973' x -974' x -975' x -976' x -977' x -978' x -979' x -980' x -981' x -982' x -983' x -984' x -985' x -986' x -987' x -988' x -989' x -990' x -991' x -992' x -993' x -994' x -995' x -996' x -997' x -998' x -999' x -1000' x -1001' x -1002' x -1003' x -1004' x -1005' x -1006' x -1007' x -1008' x -1009' x -1010' x -1011' x -1012' x -1013' x -1014' x -1015' x -1016' x -1017' x -1018' x -1019' x -1020' x -1021' x -1022' x -1023' x -1024' x -1025' x -1026' x -1027' x -1028' x -1029' x -1030' x -1031' x -1032' x -1033' x -1034' x -1035' x -1036' x -1037' x -1038' x -1039' x -1040' x -1041' x -1042' x -1043' x -1044' x -1045' x -1046' x -1047' x -1048' x -1049' x -1050' x -1051' x -1052' x -1053' x -1054' x -1055' x -1056' x -1057' x -1058' x -1059' x -1060' x -1061' x -1062' x -1063' x -1064' x -1065' x -1066' x -1067' x -1068' x -1069' x -1070' x -1071' x -1072' x -1073' x -1074' x -1075' x -1076' x -1077' x -1078' x -1079' x -1080' x -1081' x -1082' x -1083' x -1084' x -1085' x -1086' x -1087' x -1088' x -1089' x -1090' x -1091' x -1092' x -1093' x -1094' x -1095' x -1096' x -1097' x -1098' x -1099' x -1100' x -1101' x -1102' x -1103' x -1104' x -1105' x -1106' x -1107' x -1108' x -1109' x -1110' x -1111' x -1112' x -1113' x -1114' x -1115' x -1116' x -1117' x -1118' x -1119' x -1120' x -1121' x -1122' x -1123' x -1124' x -1125' x -1126' x -1127' x -1128' x -1129' x -1130' x -1131' x -1132' x -1133' x -1134' x -1135' x -1136' x -1137' x -1138' x -1139' x -1140' x -1141' x -1142' x -1143' x -1144' x -1145' x -1146' x -1147' x -1148' x -1149' x -1150' x -1151' x -1152' x -1153' x -1154' x -1155' x -1156' x -1157' x -1158' x -1159' x -1160' x -1161' x -1162' x -1163' x -1164' x -1165' x -1166' x -1167' x -1168' x -1169' x -1170' x -1171' x -1172' x -1173' x -1174' x -1175' x -1176' x -1177' x -1178' x -1179' x -1180' x -1181' x -1182' x -1183' x -1184' x -1185' x -1186' x -1187' x -1188' x -1189' x -1190' x -1191' x -1192' x -1193' x -1194' x -1195' x -1196' x -1197' x -1198' x -1199' x -1200' x -1201' x -1202' x -1203' x -1204' x -1205' x -1206' x -1207' x -1208' x -1209' x -1210' x -1211' x -1212' x -1213' x -1214' x -1215' x -1216' x -1217' x -1218' x -1219' x -1220' x -1221' x -1222' x -1223' x -1224' x -1225' x -1226' x -1227' x -1228' x -1229' x -1230' x -1231' x -1232' x -1233' x -1234' x -1235' x -1236' x -1237' x -1238' x -1239' x -1240' x -1241' x -1242' x -1243' x -1244' x -1245' x -1246' x -1247' x -1248' x -1249' x -1250' x -1251' x -1252' x -1253' x -1254' x -1255' x -1256' x -1257' x -1258' x -1259' x -1260' x -1261' x -1262' x -1263' x -1264' x -1265' x -1266' x -1267' x -1268' x -1269' x -1270' x -1271' x -1272' x -1273' x -1274' x -1275' x -1276' x -1277' x -1278' x -1279' x -1280' x -1281' x -1282' x -1283' x -1284' x -1285' x -1286' x -1287' x -1288' x -1289' x -1290' x -1291' x -1292' x -1293' x -1294' x -1295' x -1296' x -1297' x -1298' x -1299' x -1300' x -1301' x -1302' x -1303' x -1304' x -1305' x -1306' x -1307' x -1308' x -1309' x -1310' x -1311' x -1312' x -1313' x -1314' x -1315' x -1316' x -1317' x -1318' x -1319' x -1320' x -1321' x -1322' x -1323' x -1324' x -1325' x -1326' x -1327' x -1328' x -1329' x -1330' x -1331' x -1332' x -1333' x -1334' x -1335' x -1336' x -1337' x -1338' x -1339' x -1340' x -1341' x -1342' x -1343' x -1344' x -1345' x -1346' x -1347' x -1348' x -1349' x -1350' x -1351' x -1352' x -1353' x -1354' x -1355' x -1356' x -1357' x -1358' x -1359' x -1360' x -1361' x -1362' x -1363' x -1364' x -1365' x -1366' x -1367' x -1368' x -1369' x -1370' x -1371' x -1372' x -1373' x -1374' x -1375' x -1376' x -1377' x -1378' x -1379' x -1380' x -1381' x -1382' x -1383' x -1384								

添付 5.2-1 表 7 号炉 想定破損による被水影響評価結果まとめ

区画	溢水源	一次判定	相対位置 関係考慮	被水対策 実施	最終判定	備考
C-MB2-1	無	○	-	-	○	
C-MB2-2(1)	有り	○	-	-	○	
C-MB2-2(2)	有り	○	-	-	○	
C-MB2-2(3)	有り	○	-	-	○	
C-MB2-2(4)	有り	○	-	-	○	
C-MB2-3	無	○	-	-	○	
C-B2-1	有り	○	-	-	○	
C-B2-2	有り	○	-	-	○	
C-B2-3	有り	×	-	○	○	
C-B2-4	有り	○	-	-	○	
C-B2-5	有り	○	-	-	○	

区分Ⅰの区画内に区分Ⅰの配管が存在するため被水対策(区分Ⅰの溢水源(換気空調補機非常用冷却水系(A))の想定除外)を実施
 換気空調補機非常用冷却水系(B)

第3表 想定破損による被水影響評価結果まとめ (18/23)

系統名称	機器名称	機器番号	区画番号	被水原因 天井開口 又は貫通部 の有無 ○:有 ×:無	多重化・ 区画化 ○:有 ×:無	防滴仕 様・被水 防護措置 ○:有 ×:無	判定 基準 ○:有 ×:無	対策 実施 ○:有 ×:無	評価 結果 ○:良 ×:否
原子炉隔離時冷却系	RCIC 外側循環弁	E51-F064(00)	RB-3-6	-	-	-	-	○	○
原子炉隔離時冷却系	RCIC トビン稼働弁	E51-F068(00)	RB-B1-1	-	-	-	-	○	○
原子炉隔離時冷却系	RCIC 真空ポンプ出口弁	E51-F069(00)	RB-B1-1	-	-	-	-	○	○
原子炉隔離時冷却系	RCIC 弁(E51-F045)ノズル弁	E51-F065(00)	RB-B2-10	-	○	-	B	-	○
原子炉隔離時冷却系	RCIC 弁(E51-F065)均圧弁	E51-F068(00)	RB-4-1	-	-	-	-	○	○
原子炉隔離時冷却系	PMP DISCHARGE PRESS(1分)	PSH-E51-N020	RB-B2-10	-	○	-	B	-	○
原子炉隔離時冷却系	PMP DISCHARGE H/L FLOW(伝送部)	FT-E51-N002	RB-B2-10	-	○	-	B	-	○
原子炉隔離時冷却系	RCIC PMP DISCHARGE FLOW(伝送部)	FT-E51-N003	RB-B2-10	-	○	-	B	-	○
原子炉建屋換気系	HPCS エンジン室空調機	HVAC-AR2-1	RB-B2-19	-	○	-	B	-	○
原子炉建屋換気系	HPCS エンジン室空調機	HVAC-AR2-2	RB-B2-1	-	○	-	B	-	○
原子炉建屋換気系	LPCS エンジン室空調機	HVAC-AR2-3	RB-B2-13	-	○	-	B	-	○
原子炉建屋換気系	RCIC エンジン・トビン室空調機	HVAC-AR2-4	RB-B2-17	-	○	-	B	-	○
原子炉建屋換気系	RBR(B) エンジン室空調機	HVAC-AR2-5	RB-B2-3	-	○	-	B	-	○
原子炉建屋換気系	RBR(C) エンジン室空調機	HVAC-AR2-6	RB-B2-6	-	○	-	B	-	○
原子炉建屋換気系	RBR(A) エンジン室空調機	HVAC-AR2-7	RB-B2-7	-	○	-	B	-	○
原子炉建屋換気系	C/S給気隔離ポンプ(通常系)	SR2-1A(A0)	CS-3-1	-	-	-	-	○	○
原子炉建屋換気系	C/S給気隔離ポンプ(通常系)	SR2-1B(A0)	CS-3-1	-	-	-	-	○	○
原子炉建屋換気系	C/S給気隔離ポンプ	SR2-1C(A0)	CS-3-1	-	-	-	-	○	○
原子炉建屋換気系	C/S給気隔離ポンプ	SR2-1D(A0)	CS-3-1	-	-	-	-	○	○
原子炉建屋換気系	C/S排気隔離ポンプ(通常系)	SR2-2A(A0)	CS-3-2	○	-	-	A	-	○
原子炉建屋換気系	C/S排気隔離ポンプ(通常系)	SR2-2B(A0)	CS-3-2	○	-	-	A	-	○
原子炉建屋換気系	C/S排気隔離ポンプ	SR2-2C(A0)	CS-3-3	○	-	-	A	-	○
原子炉建屋換気系	C/S排気隔離ポンプ	SR2-2D(A0)	CS-3-3	○	-	-	A	-	○
原子炉再循環系	原子炉再循環系(A)計装ポンプ	R22-F022	RB-2-9	-	-	○IP67	C	-	○
原子炉再循環系	原子炉再循環系(B)計装ポンプ	R22-F006	RB-2-8	-	-	○IP67	C	-	○
原子炉再循環系	原子炉再循環ポンプ(A) 流量制御弁	B35-F060A-V1(A0)	RB-3-6	-	-	-	-	○	○
原子炉再循環系	原子炉再循環ポンプ(B) 流量制御弁	B35-F060B-V2(A0)	RB-3-5	-	-	-	-	○	○
原子炉再循環系	原子炉再循環ポンプ(A) 流量制御弁	B35-F060A-V3(A0)	RB-3-6	-	-	-	-	○	○
原子炉再循環系	原子炉再循環ポンプ(B) 流量制御弁	B35-F060B-V4(A0)	RB-3-5	-	-	-	-	○	○
原子炉再循環系	原子炉再循環ポンプ(A) 流量制御弁	B35-F060A-V5(A0)	RB-3-6	-	-	-	-	○	○
原子炉再循環系	原子炉再循環ポンプ(B) 流量制御弁	B35-F060B-V6(A0)	RB-3-5	-	-	-	-	○	○
原子炉再循環系	原子炉再循環ポンプ(A) 流量制御弁	B35-F060A-V7(A0)	RB-3-6	-	-	-	-	○	○
原子炉再循環系	原子炉再循環ポンプ(B) 流量制御弁	B35-F060B-V8(A0)	RB-3-5	-	-	-	-	○	○
原子炉冷却材浄化系	CLW 外側循環弁	G33-F004(00)	RB-2-10	-	-	-	-	○	○
高圧炉心レベル系	HPCS DIV-III計装ポンプ	R22-P004	RB-B1-9	-	-	○IP67	C	-	○

判定基準
 A: 溢水防護対象設置区画に破損を想定する被水原因なく、上部の天井面に開口部又は貫通部がない。
 B: 溢水防護対象設備が多重化又は区画化されており、各々が別区画に設置される等により、同時に機能喪失しない。
 C: 溢水防護対象設備が「JIS C 0920 電気機械器具の外部による保護等級 (IPコード)」(NEMA(National Electrical Manufacturers Association)による保護等級)等による防滴仕様を有している、又は溢水防護対象設備を防護するために必要な防護措置がなされている。
 -: 被水による影響あり。

表 2-1 想定破損による被水影響評価結果 (18/20)

系統名称	設備番号	設備名称	設置区画	被水原因 天井開口 又は貫通部 の有無 ○:有 ×:無	多重化・ 区画化 ○:有 ×:無	防滴仕 様・被水 防護措置 ○:有 ×:無	判定 基準 ○:有 ×:無	対策 実施 ○:有 ×:無	評価 結果 ○:良 ×:否	備考
中央制御室機器・現 地制御盤	2-1(B)-1A	1-BSM エンジン 出口圧力計器 取付部	設置区画 Y-24BX	-	○	-	B	-	○	

A: 溢水防護対象設備から放物軌道を考慮した範囲に破損を想定する被水原因なく、上部の天井面に開口部又は貫通部がない。
 B: 溢水防護対象設備が多重化又は区画化されており、各々が別区画に設置される等により、同時に機能喪失しない。
 C: 溢水防護対象設備が「JIS C 0920 電気機械器具の外部による保護等級 (IPコード)」(NEMA(National Electrical Manufacturers Association)による保護等級)等による防滴仕様を有している、又は溢水防護対象設備を防護するために必要な防護措置がなされている。

第3表 想定破損による被水影響評価結果まとめ (19/23)

系統名称	機器名称	機器番号	区画番号	被水部、天井開口又は貫通部の有無 ○：有 ○：無	多重化・区画化 ○：有 ○：無	防漏仕様・被水防護措置 ○：有 ○：無	判定基準	対策実施 ○：有 ○：無	評価結果 ○：良 ○：否
高圧炉心V1系	IPCSポンプ	IPCS-P00-C001	BB-02-18	-	○	-	B	-	○
高圧炉心V1系	IPCSポンプ 入口弁 (CST 側)	E22-P001 000	BB-01-2	-	○	-	B	-	○
高圧炉心V1系	IPCS 圧入弁	E22-P004 000	BB-3-2	-	-	-	-	○	○
高圧炉心V1系	IPCS ミラー弁	E22-P012 000	BB-02-19	-	-	-	-	○	○
高圧炉心V1系	IPCSポンプ 入口弁 (S/P 側)	E22-P015 000	BB-02-1	-	-	-	-	○	○
高圧炉心V1系	CST WATER LEVEL (伝送器)	LT-E22-9054A	CST-01-1	-	○	-	B	-	○
高圧炉心V1系	CST WATER LEVEL (伝送器)	LT-E22-9054B	CST-01-1	-	○	-	B	-	○
高圧炉心V1系	CST WATER LEVEL (伝送器)	LT-E22-9054C	CST-01-1	-	○	-	B	-	○
高圧炉心V1系	CST WATER LEVEL (伝送器)	LT-E22-9054D	CST-01-1	-	○	-	B	-	○
低圧炉心V1系	LPCS 計装77	R22-P001	BB-01-1	-	-	○IP07	C	-	○
低圧炉心V1系	LPCSポンプ	LPCS-P00-C001	BB-02-12	-	○	-	B	-	○
低圧炉心V1系	LPCSポンプ 入口弁	E21-P001 000	BB-02-12	-	-	-	-	○	○
低圧炉心V1系	LPCS 圧入弁	E21-P005 000	BB-3-1	-	-	-	-	○	○
低圧炉心V1系	LPCS ミラー弁	E21-P011 000	BB-02-12	-	-	-	-	○	○

判定基準
 A：被水防護対象設備設置区画に破損を想定する被水部がなく、上部の天井面に開口部又は貫通部がない。
 B：被水防護対象設備が多重化又は区画化されており、各々が別区画に設置される等により、同時に機能喪失しない。
 C：被水防護対象設備が「JIS C 0920 電気機械器具の外部による保護等級 (IP コード)」「NEMA (National Electrical Manufacturers Association) による保護等級」等による防護仕様を有している。又は被水防護対象設備を防護するために必要な防護措置がなされている。
 -：被水による影響あり。

表2-1 想定破損による被水影響評価結果 (19/20)

系統名称	設備番号	設備名称	設置区画	被水部、天井開口又は貫通部の有無 ○：有 ○：無	多重化・区画化 ○：有 ○：無	防漏仕様 ○：有 ○：無	判定基準	保護等級	評価結果 ○：良 ○：否	備考
中央制御室機器・現地制御盤	2-920A	A-BBR-LPCS 継電器盤	RR-1F-06N	○	-	-	A	-	○	
中央制御室機器・現地制御盤	2-920B	B-C-BBR 継電器盤	RR-1F-06N	○	-	-	A	-	○	
中央制御室機器・現地制御盤	2-921	IPCS 継電器盤	RR-1F-07N	○	-	-	A	-	○	
中央制御室機器・現地制御盤	2-921A	IPCS トリップ 設定回路	RR-1F-07N	○	-	-	A	-	○	
中央制御室機器・現地制御盤	2-923A	A-格納容器隔離電源装置	RR-1F-07N	○	-	-	A	-	○	
中央制御室機器・現地制御盤	2-923B	B-格納容器隔離電源装置	RR-1F-07N	○	-	-	A	-	○	
中央制御室機器・現地制御盤	2-924A	A-原子炉保護トリップ 設定回路	RR-1F-07N	○	-	-	A	-	○	
中央制御室機器・現地制御盤	2-924A1	A1-原子炉保護トリップ 設定回路	RR-1F-07N	○	-	-	A	-	○	
中央制御室機器・現地制御盤	2-924A2	A2-原子炉保護トリップ 設定回路	RR-1F-07N	○	-	-	A	-	○	
中央制御室機器・現地制御盤	2-924B	B-原子炉保護電源装置	RR-1F-07N	○	-	-	A	-	○	
中央制御室機器・現地制御盤	2-924B1	B1-原子炉保護トリップ 設定回路	RR-1F-07N	○	-	-	A	-	○	
中央制御室機器・現地制御盤	2-924B2	B2-原子炉保護トリップ 設定回路	RR-1F-07N	○	-	-	A	-	○	
中央制御室機器・現地制御盤	2-925	制御機77777777	RR-1F-07N	○	-	-	A	-	○	
中央制御室機器・現地制御盤	2-934A	A-原子炉77 #6 計測盤	RR-1F-07N	○	-	-	A	-	○	
中央制御室機器・現地制御盤	2-934B	B-原子炉77 #6 計測盤	RR-1F-07N	○	-	-	A	-	○	

A：被水防護対象設備から放射線が漏れ出ることを想定する被水部がなく、上部の天井面に開口部又は貫通部がない。
 B：被水防護対象設備が多重化又は区画化されており、各々が別区画に設置される等により、同時に機能喪失しない。
 C：被水防護対象設備が「JIS C 0920 電気機械器具の外部による保護等級 (IP コード)」「NEMA (National Electrical Manufacturers Association) による保護等級」等による防護仕様を有している。又は被水防護対象設備を防護するために必要な防護措置がなされている。

第3表 想定破損による被水影響評価結果まとめ (20/23)

系統名称	機器名称	機器番号	区画番号	被水、天井開口又は貫通部の有無 ○：有 ○：無	多重化、区画化 ○：有 ○：無	防滴仕様・被水防護措置 ○：有 ○：無	判定基準	対策実施 ○：有 ○：無	評価結果 ○：良 ○：否
中央制御室制御盤	自動減圧系(B)継電器盤	H13-P631	CS-2-1	○	-	-	A	-	○
中央制御室制御盤	漏えい検出系操作盤	H13-P632	CS-2-1	○	-	-	A	-	○
中央制御室制御盤	アラーム放射線計測、起動時領域等(A)操作盤	H13-P635	CS-2-1	○	-	-	A	-	○
中央制御室制御盤	アラーム放射線計測、起動時領域等(B)操作盤	H13-P636	CS-2-1	○	-	-	A	-	○
中央制御室制御盤	格納容器常時監視系(A)操作盤	H13-P638	CS-2-1	○	-	-	A	-	○
中央制御室制御盤	格納容器常時監視系(B)操作盤	H13-P639	CS-2-1	○	-	-	A	-	○
中央制御室制御盤	漏えい検出系操作盤	H13-P642	CS-2-1	○	-	-	A	-	○
中央制御室制御盤	アラーム放射線計測(A)	H13-P689	CS-2-1	○	-	-	A	-	○
中央制御室制御盤	アラーム放射線計測(B)	H13-P690	CS-2-1	○	-	-	A	-	○
中央制御室制御盤	原子炉保護系(1A)アラーム盤	H13-P921	CS-2-1	○	-	-	A	-	○
中央制御室制御盤	原子炉保護系(1B)アラーム盤	H13-P922	CS-2-1	○	-	-	A	-	○
中央制御室制御盤	原子炉保護系(2A)アラーム盤	H13-P923	CS-2-1	○	-	-	A	-	○
中央制御室制御盤	原子炉保護系(2B)アラーム盤	H13-P924	CS-2-1	○	-	-	A	-	○
中央制御室制御盤	緊急炉心冷却系(DIV-I-1)アラーム盤	H13-P925	CS-2-1	○	-	-	A	-	○
中央制御室制御盤	緊急炉心冷却系(DIV-II-1)アラーム盤	H13-P926	CS-2-1	○	-	-	A	-	○
中央制御室制御盤	緊急炉心冷却系(DIV-I-2)アラーム盤	H13-P927	CS-2-1	○	-	-	A	-	○
中央制御室制御盤	高圧炉心冷却系アラーム盤	H13-P929	CS-2-1	○	-	-	A	-	○
中央制御室制御盤	所内電気操作盤	CP-1	CS-2-1	○	-	-	A	-	○
中央制御室制御盤	予備電気操作盤	CP-2	CS-2-1	○	-	-	A	-	○
中央制御室制御盤	予備補機操作盤	CP-3	CS-2-1	○	-	-	A	-	○
中央制御室制御盤	予備補機	CP-4	CS-2-1	○	-	-	A	-	○
中央制御室制御盤	真空蒸機-空調換気制御盤	CP-5	CS-2-1	○	-	-	A	-	○
中央制御室制御盤	非常用炉心監視系、非常用炉心監視系(A)操作盤	CP-6A	CS-2-1	○	-	-	A	-	○
中央制御室制御盤	非常用炉心監視系、非常用炉心監視系(B)操作盤	CP-6B	CS-2-1	○	-	-	A	-	○
中央制御室制御盤	TURB. GEN TESTCHECKOUT V, B	CP-7	CS-2-1	○	-	-	A	-	○
中央制御室制御盤	TURBINE GENERATOR V, B	CP-8	CS-2-1	○	-	-	A	-	○
中央制御室制御盤	予備補機補助継電器盤	CP-9	CS-2-1	○	-	-	A	-	○
中央制御室制御盤	発電機・主変圧器保護リレー盤	CP-10A	CS-2-1	○	-	-	A	-	○
中央制御室制御盤	発電機・主変圧器保護リレー盤	CP-10B	CS-2-1	○	-	-	A	-	○
中央制御室制御盤	予備変圧器保護リレー盤	CP-10C	CS-2-1	○	-	-	A	-	○
中央制御室制御盤	予備補機	CP-11	CS-2-1	○	-	-	A	-	○
中央制御室制御盤	MSIV-LCS(A)制御盤	CP-13	CS-2-1	○	-	-	A	-	○
中央制御室制御盤	MSIV-LCS(B)制御盤	CP-14	CS-2-1	○	-	-	A	-	○
中央制御室制御盤	可燃性ガス濃度制御盤(A)	CP-15	CS-2-1	○	-	-	A	-	○
中央制御室制御盤	可燃性ガス濃度制御盤(B)	CP-16	CS-2-1	○	-	-	A	-	○

判定基準
 A：被水防護対象設備設置区画に破損を想定する被水漏れがなく、上部の天井開口又は貫通部がない。
 B：被水防護対象設備が多重化又は区画化されており、各々が別区画に設置される等により、同時に機能喪失しない。
 C：被水防護対象設備が「JIS C 0920 電気機械器具の外箱による保護等級 (IPコード)」「NEMA(National Electrical Manufacturers Association)による保護等級」等による防滴仕様を有している。又は被水防護対象設備を防護するために必要な防護措置がなされている。
 -：被水による影響あり。

表2-1 想定破損による被水影響評価結果 (20/20)

系統名称	設備番号	設備名称	設置区画	被水、天井開口又は貫通部の有無 ○：有 ○：無	多重化、区画化 ○：有 ○：無	防滴仕様 ○：有 ○：無	判定基準	保護等級	評価結果 ○：良 ○：否
中央制御室機器・現地制御盤	2-961C2	B=直流地絡検出装置	RF-1F-05N	○	-	-	A	-	○
中央制御室機器・現地制御盤	2-970A	A=自動減圧継電器盤	RF-1F-05N	○	-	-	A	-	○
中央制御室機器・現地制御盤	2-970B	B=自動減圧継電器盤	RF-1F-07N	○	-	-	A	-	○
中央制御室機器・現地制御盤	2-972A	A=原子炉補助継電器盤	RF-1F-05N	○	-	-	A	-	○
中央制御室機器・現地制御盤	2-972B	B=原子炉補助継電器盤	RF-1F-07N	○	-	-	A	-	○
中央制御室機器・現地制御盤	2-973A-2	A=格納容器12/02 温度計演算器盤	RF-1F-05N	○	-	-	A	-	○
中央制御室機器・現地制御盤	2-973B-2	B=格納容器12/02 温度計演算器盤	RF-1F-07N	○	-	-	A	-	○
中央制御室機器・現地制御盤	2-975A	S I -工学的安全風設リフト設定器盤	RF-1F-05N	○	-	-	A	-	○
中央制御室機器・現地制御盤	2-975B	S II -工学的安全風設リフト設定器盤	RF-1F-07N	○	-	-	A	-	○
中央制御室機器・現地制御盤	2-976A	原子炉警報電源盤	RF-1F-05N	○	-	-	A	-	○
中央制御室機器・現地制御盤	2-976B	A=中央制御室冷凍機制御盤	RF-1F-07N	○	-	-	A	-	○
中央制御室機器・現地制御盤	2-984A	B=中央制御室冷凍機制御盤	RF-2F-02N	○	-	-	A	-	○
中央制御室機器・現地制御盤	2-2256A	中央制御室冷凍機制御盤	RF-2F-02N	○	-	-	A	-	○
中央制御室機器・現地制御盤	2-2256B	中央制御室冷凍機制御盤	RF-2F-02N	○	-	-	A	-	○
中央制御室機器・現地制御盤	2-211E-2-6A	中央制御室冷凍機制御盤	RF-2F-02N	○	-	-	A	-	○
中央制御室機器・現地制御盤	2-211E-2-6B	中央制御室冷凍機制御盤	RF-2F-02N	○	-	-	A	-	○

A：被水防護対象設備から、被水漏れを想定した範囲に破損を想定する被水漏れがなく、上部の天井開口又は貫通部がない。
 B：被水防護対象設備が多重化又は区画化されており、各々が別区画に設置される等により、同時に機能喪失しない。
 C：被水防護対象設備が「JIS C 0920 電気機械器具の外箱による保護等級 (IPコード)」「NEMA(National Electrical Manufacturers Association)による保護等級」等による防滴仕様を有している。又は被水防護対象設備を防護するために必要な防護措置がなされている。

第3表 想定破損による被水影響評価結果まとめ (21/23)

系統名称	機器名称	機器番号	区画番号	被水部、又は貫通部又は貫通部の有無 ○:有 -:無	多重化・区画化 ○:有 -:無	防護仕様・被水防護措置 ○:有 -:無	判定基準	対策実施 ○:有 -:無	評価結果 ○:良 ×:否
中央制御室制御盤	送・受電系統制御盤	CP-30	CS-2-1	○	-	-	A	-	○
中央制御室制御盤	OFF GAS CHACOAL SYS. V. B	CP-31	CS-2-1	○	-	-	A	-	○
中央制御室制御盤	開閉所保護1-盤	CP-32	CS-2-1	○	-	-	A	-	○
中性子計装系	IRM&SM PREAMP. CABINET	R22-P030	RB-3-1	-	○	-	B	-	○
中性子計装系	IRM&SM PREAMP. CABINET	R22-P031	RB-3-2	-	○	-	B	-	○
中性子計装系	IRM&SM PREAMP. CABINET	R22-P032	RB-3-1	-	○	-	B	-	○
中性子計装系	IRM&SM PREAMP. CABINET	R22-P033	RB-3-2	-	○	-	B	-	○
中性子計装系	TIP 駆動装置電気盤	LCP-200	RB-2-8	-	-	-	-	○	○
中性子計装系	TIP N2 隔離弁	G51-S0-F010 (電磁弁)	RB-2-6	-	-	-	-	○	○
主蒸気隔離弁 漏えい抑制系	MSIV 33A-1ドレイン弁(A)	E32-FF009A(00)	RB-1-1	-	-	-	-	○	○
主蒸気隔離弁 漏えい抑制系	MSIV 33A-1ドレイン弁(B)	E32-FF009B(00)	RB-1-2	-	-	-	-	○	○
3号炉冷却系	3号炉冷却水入口隔離弁	7-90V13(00)	RB-2-8	-	-	-	-	○	○
3号炉冷却系	3号炉冷却水出口隔離弁	7-90V17(00)	RB-2-8	-	-	-	-	○	○
不活性ガス系	2号炉供給入口弁	2-20B-1(A0)	RB-2-8	-	-	-	-	○	○
不活性ガス系	格納容器ベント弁	2-20B-2(A0)	RB-2-9	-	-	-	-	○	○
不活性ガス系	9号炉真空破壊止め弁	2-20B-3(A0)	RB-1-1	-	-	-	-	○	○
不活性ガス系	9号炉真空破壊止め弁	2-20B-4(A0)	RB-1-1	-	-	-	-	○	○
不活性ガス系	9号炉真空破壊止め弁	2-20B-5(A0)	RB-1-1	-	-	-	-	○	○
不活性ガス系	9号炉真空破壊止め弁	2-20B-6(A0)	RB-1-1	-	-	-	-	○	○
不活性ガス系	格納容器/9号炉真空破壊止め弁	2-20B-7(A0)	RB-2-8	-	-	-	-	○	○
不活性ガス系	N2ベント供給弁	2-20B-8(A0)	RB-2-8	-	-	-	-	○	○
不活性ガス系	格納容器N2供給弁	2-20B-9(A0)	RB-2-9	-	-	-	-	○	○
不活性ガス系	9号炉真空破壊止め弁	2-20B-10(A0)	RB-1-2	-	-	-	-	○	○
不活性ガス系	9号炉真空破壊止め弁	2-20B-11(A0)	RB-1-2	-	-	-	-	○	○
不活性ガス系	3号炉ベント弁	2-20B-12(A0)	RB-4-3	-	-	-	-	○	○
不活性ガス系	原子炉循環機熱交換器ベント弁(SR2-14)	2-20B-13(A0)	RB-6-14	-	-	-	-	○	○
不活性ガス系	FRVSベント弁(SR2-3)	2-20B-14(A0)	RB-6-14	-	-	-	-	○	○
不活性ガス系	3号炉20℃ベント弁	2-20V9(A0)	RB-4-3	-	-	-	-	○	○
不活性ガス系	3号炉真空破壊止め弁用電磁弁	2-20V81(電磁弁)	RB-01-1	-	-	-	-	○	○
不活性ガス系	3号炉真空破壊止め弁用電磁弁	2-20V82(電磁弁)	RB-01-1	-	-	-	-	○	○
不活性ガス系	3号炉真空破壊止め弁用電磁弁	2-20V83(電磁弁)	RB-01-1	-	-	-	-	○	○
不活性ガス系	3号炉真空破壊止め弁用電磁弁	2-20V84(電磁弁)	RB-01-1	-	-	-	-	○	○
不活性ガス系	3号炉真空破壊止め弁用電磁弁	2-20V85(電磁弁)	RB-01-1	-	-	-	-	○	○
不活性ガス系	3号炉真空破壊止め弁用電磁弁	2-20V86(電磁弁)	RB-01-1	-	-	-	-	○	○
不活性ガス系	3号炉真空破壊止め弁用電磁弁	2-20V87(電磁弁)	RB-01-2	-	-	-	-	○	○

判定基準
 A：海水防護対象設備設置区画に破損を想定する被水部がなく、上部の天井面に開口部又は貫通部がない。
 B：海水防護対象設備が多重化又は区画化されており、各々が別区画に設置される等により、同時に機能喪失しない。
 C：海水防護対象設備が「JIS C 0920 電気機械器具の外郭による保護等級 (IPコード)」「NEMA (National Electrical Manufacturers Association) による保護等級」等による防護仕様を有している、又は海水防護対象設備を防護するために必要な防護措置がなされている。
 -：被水による影響あり。

第3表 想定破損による被水影響評価結果まとめ (22/23)

系統名称	機器名称	機器番号	区画番号	被水源、天井開口又は貫通部の有無 -:有 ○:無	多重化・区画化 ○:有 -:無	防滴仕様・被水防護措置 ○:有 -:無	判定基準	対策実施 ○:有 -:無	評価結果 ○:良 ×:否
不活性ガス系	ドラフト真空破壊弁(1)用電磁弁	2-26V88(電磁弁)	RB-B1-2	-	-	-	-	○	○
不活性ガス系	ドラフト真空破壊弁(2)用電磁弁	2-26V89(電磁弁)	RB-B1-2	-	-	-	-	○	○
不活性ガス系	ドラフト真空破壊弁(3)用電磁弁	2-26V90(電磁弁)	RB-B1-2	-	-	-	-	○	○
不活性ガス系	ドラフト真空破壊弁(4)用電磁弁	2-26V91(電磁弁)	RB-B1-2	-	-	-	-	○	○
不活性ガス系	PCV PRESS (A) (伝送器)	PT-26-79.51A	RB-3-2	-	-	○IP67	C	-	○
不活性ガス系	PCV PRESS (B) (伝送器)	PT-26-79.51B	RB-3-2	-	-	○IP67	C	-	○
不活性ガス系	PCV PRESS	PT-26-79.53	RB-3-1	-	-	○IP67	C	-	○
不活性ガス系	PCV PRESS (伝送器)	PT-26-79.5B	RB-3-2	-	-	○IP67	C	-	○
不活性ガス系	SUPP CHAMBER PRESS	PT-26-79.52A	RB-1-1	-	○	-	B	-	○
不活性ガス系	SUPP CHAMBER PRESS	PT-26-79.52B	RB-1-2	-	○	-	B	-	○
不活性ガス系	SUPP CHAMBER LEVEL (伝送器)	LT-26-79.5B	RB-B2-6	-	-	○IP67	C	-	○
不活性ガス系	SUPP CHAMBER LEVEL (A) (伝送器)	LT-26-79.5A	RB-B2-13	-	○	-	B	-	○
不活性ガス系	SUPP CHAMBER LEVEL (B) (伝送器)	LT-26-79.5B	RB-B2-6	-	○	-	B	-	○
事故時ワンプラント系	D/W内ワンプラントガス弁	V25-1008(電磁弁)	RB-3-1	-	○	-	B	-	○
試料採取系	格納容器酸素分析系ワンプ弁	25-51A1(電磁弁)	RB-4-2	-	-	-	-	○	○
試料採取系	格納容器酸素分析系ワンプ弁	25-51A2(電磁弁)	RB-4-2	-	-	-	-	○	○
試料採取系	格納容器酸素分析系ワンプ弁	25-51B1(電磁弁)	RB-3-2	-	-	-	-	○	○
試料採取系	格納容器酸素分析系ワンプ弁	25-51B2(電磁弁)	RB-3-2	-	-	-	-	○	○
試料採取系	格納容器酸素分析系ワンプ弁	25-51C1(電磁弁)	RB-2-3	-	-	-	-	○	○
試料採取系	格納容器酸素分析系ワンプ弁	25-51C2(電磁弁)	RB-2-3	-	-	-	-	○	○
試料採取系	格納容器酸素分析系ワンプ弁	25-51D1(電磁弁)	RB-1-2	-	-	-	-	○	○
試料採取系	格納容器酸素分析系ワンプ弁	25-51D2(電磁弁)	RB-1-2	-	-	-	-	○	○
試料採取系	格納容器酸素分析系排気弁	25-51E1(電磁弁)	RB-B1-1	-	-	-	-	○	○
試料採取系	格納容器酸素分析系排気弁	25-51E2(電磁弁)	RB-B1-1	-	-	-	-	○	○
試料採取系	PLR 排水ワンプ弁 (外部隔離弁)	B3G-F020(A0)	RB-3-2	-	-	-	-	○	○
放射性廃棄物処理系	原子炉格納容器1号系圧力隔離弁(外側)	G13-F129(A0)	RB-B1-8	-	-	-	-	○	○
放射性廃棄物処理系	原子炉格納容器1号系圧力隔離弁(内側)	G13-F130(A0)	RB-B1-8	-	-	-	-	○	○
放射性廃棄物処理系	原子炉格納容器1号系機器1号隔離弁(外側)	G13-F132(A0)	RB-B1-8	-	-	-	-	○	○
放射性廃棄物処理系	原子炉格納容器1号系機器1号隔離弁(内側)	G13-F133(A0)	RB-B1-8	-	-	-	-	○	○
復水移送系	復水移送ポンプ(A)	MW-PMP-CST-A	TB-B1-6	-	-	-	-	○	○
復水移送系	復水移送ポンプ(B)	MW-PMP-CST-B	TB-B1-6	-	-	-	-	○	○
復水移送系	COND TRANS PUMP DISCH PRESS	PT-18-190.5	TB-B1-6	-	-	○IP67	C	-	○
復水移送系	CST (A) LEVEL(伝送器)	LT-18-190A	CST-B1-2	-	-	○IP67	C	-	○
復水移送系	CST (B) LEVEL(伝送器)	LT-18-190B	CST-B1-2	-	-	○IP67	C	-	○
気体廃棄物処理系	OFF GAS SYSTEM INST. RACK	PML-LR-R-4	TB-1-4	-	-	○IP67	C	-	○

判定基準
 A: 浸水防護対象設備設置区画に破損を想定する被水がなく、上部の天井面に開口部又は貫通部がない。
 B: 浸水防護対象設備が多重化又は区画化されており、各々が別区画に設置される等により、同時に機能喪失しない。
 C: 浸水防護対象設備が「JIS C 0920 電気機械器具の外装による保護等級 (IPコード)」(NEMA(National Electrical Manufacturers Association)による保護等級) 等による防滴仕様を有している、又は浸水防護対象設備を防護するために必要な防護措置がなされている。
 -: 被水による影響あり。

第3表 想定破損による被水影響評価結果まとめ (23/23)

系統名称	機器名称	機器番号	区画番号	被水部、天井開口又は貫通部の有無 -:有 ○:無	多重化・区画化 ○:有 -:無	防護仕様・被水防護措置 ○:有 -:無	判定基準	対策実施 ○:有 -:無	評価結果 ○:良 ×:否
気体廃棄物処理系	OFF GAS PREHEATERS TEMP	TE-23-164	TB-1-8	-	-	-	-	○	○
気体廃棄物処理系	主蒸気式空気抽出器(A)出口弁	6-231000	TB-1-8	-	-	-	-	○	○
気体廃棄物処理系	主蒸気式空気抽出器(B)出口弁	6-232000	TB-1-8	-	-	-	-	○	○
気体廃棄物処理系	#7炉プレハ(A)入口弁	6-2330(A)	TB-1-19	-	-	-	-	○	○
気体廃棄物処理系	#7炉プレハ(B)入口弁	6-2340(A)	TB-1-17	-	-	-	-	○	○
気体廃棄物処理系	排#1予熱器(A)蒸気温度制御弁	TCV-23-164.1A(00)	TB-1-2	-	-	-	-	○	○
気体廃棄物処理系	排#1予熱器(B)蒸気温度制御弁	TCV-23-164.1B(00)	TB-1-6	-	-	-	-	○	○
気体廃棄物処理系	排#1空気抽出器(A)入口弁	06C-F019A(00)	RW-1-4	-	-	-	-	○	○
気体廃棄物処理系	排#1空気抽出器(B)入口弁	06C-F019B(00)	RW-1-4	-	-	-	-	○	○
気体廃棄物処理系	排#1空気抽出器(A)再循環圧力制御弁	PCV-F051A	RW-1-4	-	-	-	-	○	○
気体廃棄物処理系	排#1空気抽出器(B)再循環圧力制御弁	PCV-F051B	RW-1-4	-	-	-	-	○	○
気体廃棄物処理系	排#1空気抽出器(A)入口弁	06C-F103A(00)	RW-1-4	-	-	-	-	○	○
気体廃棄物処理系	排#1空気抽出器(B)入口弁	06C-F103B(00)	RW-1-4	-	-	-	-	○	○
気体廃棄物処理系	OFF GAS RECOMBINER HEATER(A)	-	TB-1-19	-	-	-	-	○	○
気体廃棄物処理系	OFF GAS RECOMBINER HEATER(B)	-	TB-1-17	-	-	-	-	○	○
空気抽出系	第1段SJAE(A)空気入口弁	6-2292000	TB-1-8	-	-	-	-	○	○
空気抽出系	第1段SJAE(B)空気入口弁	6-2293000	TB-1-8	-	-	-	-	○	○
空気抽出系	SJAE 蒸気 BLOCK	40-7-119A	TB-1-8	-	-	-	-	○	○
空気抽出系	SJAE 蒸気 BLOCK	40-7-119B	TB-1-8	-	-	-	-	○	○
#4炉補助蒸気系	主蒸気式空気抽出器(A)第1段蒸気入口弁	6-731A000	TB-1-8	-	-	-	-	○	○
#4炉補助蒸気系	主蒸気式空気抽出器(A)第2段蒸気入口弁	6-731B000	TB-1-8	-	-	-	-	○	○
#4炉補助蒸気系	主蒸気式空気抽出器(B)第1段蒸気入口弁	6-732A000	TB-1-8	-	-	-	-	○	○
#4炉補助蒸気系	主蒸気式空気抽出器(B)第2段蒸気入口弁	6-732B000	TB-1-8	-	-	-	-	○	○

判定基準
 A: 被水防護対象設備設置区画に破損を想定する被水部がなく、上部の天井開口又は貫通部がない。
 B: 被水防護対象設備が多重化又は区画化されており、各々が別区画に設置される等により、同時に機能喪失しない。
 C: 被水防護対象設備が「JIS C 0920 電気機械器具の外郭による保護等級 (IP コード)」 「NEMA (National Electrical Manufacturers Association) による保護等級」等による防護仕様を有している、又は被水防護対象設備を防護するために必要な防護措置がなされている。
 -: 被水による影響あり。

5.3 想定破損による蒸気影響評価結果まとめ

添付第5.3-1表 想定破損による蒸気影響評価結果

防護対象設備の設置区域	区域内の蒸気源	他区域からの蒸気の流入	蒸気影響を考慮した仕様(耐蒸気仕様)	多重性又は多様性を有する系統の同時機能喪失	機能維持判定	備考
原子炉建屋 二次格納施設	主蒸気系 給水系 原子炉隔離時冷却系 原子炉冷却材浄化系 (所内蒸気系*)	あり	○** (一部考慮なし)**	なし**	○	* 所内蒸気系は上流側のタービン機室内で常時隔離運用するため、蒸気漏れとして想定せず、また他区域からの流入もない ** 二次格納施設内の防護対象設備は、二次格納施設内に存在する高エネルギー配管破断による蒸気影響を考慮した設計としている ○ ほうげん水注入系は耐蒸気仕様ではないが、同種の機能を有する水圧制御ユニットが耐蒸気仕様であることから、多重性又は多様性を有する系統が同時機能喪失しないとして評価 二次格納施設内の防護対象設備に対する機能維持判定の詳細を添付第5.3.2表に示す
原子炉建屋 附属区域	なし (所内蒸気系*)	なし**	—	—	○	* 所内蒸気系は上流側のタービン機室内で常時隔離運用するため、蒸気漏れとして想定しない ** 蒸気源を内包する他区域との境界は気密性を考慮した設計のため、蒸気の流入はない(第4.2.3-1表参照)
タービン建屋 海水熱交換器 区域	なし	なし*	—	—	○	* 蒸気源を内包する他区域との境界は気密性を考慮した設計のため、蒸気の流入はない(第4.2.3-1表参照)
コントロール 建屋	なし	なし*	—	—	○	* 蒸気源を内包する他区域との境界は気密性を考慮した設計のため、蒸気の流入はない(第4.2.3-1表参照)

表3-1 想定破損による蒸気影響評価結果

防護対象設備	蒸気源、又は他区域からの流入 ^{※1}	多重化・区画化 ○:有 —:無	機能要求 ○:有 —:無	耐環境仕様 ○:有 —:無	判定基準 ^{※2} ○:良 —:否	対策実施 ○:有 —:無	評価結果 ○:良 —:否	判定理由
原子炉建屋 二次格納施設	主蒸気系 給水系 原子炉隔離時冷却系 原子炉冷却材浄化系 (所内蒸気系)	—	○	○	B	○	○	高エネルギー配管の破断を考慮した設計 (1)耐環境仕様 (2)ブローアウトパイルの設置 * ほうげん水注入系は耐蒸気仕様ではないが、水圧制御ユニットが耐蒸気仕様であることから、多重化又は多様化された系統が同時に機能喪失しない * 所内蒸気系配管に対しては、以下の対策を実施 (1)止め弁の設置による常時隔離(運用の変更) (2)配管のルート変更等 * 原子炉建屋付属機との境界は気密性を考慮した設計のため伝播しない
原子炉建屋 付属機	— (所内蒸気系)	—	○	—	A	○	○	所内蒸気系配管に対しては以下の対策を実施 (1)止め弁の設置による常時隔離(運用の変更) (2)配管のルート変更等 * 原子炉建屋二次格納施設との境界は気密性を考慮した設計のため伝播しない
廃棄物処理建物	— (所内蒸気系)	—	○	—	A	○	○	所内蒸気系配管については、以下の対策を実施 (1)配管のルート変更等 (2)止水防護対象区域間境界は気密性を考慮した設計のため伝播しない
制御室建物	— (所内蒸気系)	—	○	—	A	○	○	所内蒸気系配管に対しては以下の対策を実施 止水防護対象区域間境界は気密性を考慮した設計のため伝播しない
海水ポンプエリア	—	—	○	—	A	—	○	—
排気筒エリア	—	—	○	—	A	—	○	—
B-7「B」燃料貯蔵 炉格納槽	—	—	○	—	A	—	○	—

※1 0. 内は防護用の蒸気源、又は他区域から流入する蒸気源を示す
 ※2 判定基準 記号A: 止水防護対象区域間に蒸気を内包する蒸気源がなく、区域外からの蒸気の伝播がない。 区域外からの蒸気の伝播がない。 同時に機能喪失しない。
 B: 止水防護対象設備が多重化又は多様化されており、各々が別区域に設置されており、各々が別区域に設置されている等により、各々が別区域に設置されている等により、同時に機能喪失しない。
 C: 止水防護対象設備が耐蒸気仕様を有している。又は止水防護対象設備を防護するための必要な対策がなされている。

・設備及び評価条件の相違
 【柏崎6/7】
 (東海第二は別添1本文6.4に記載)

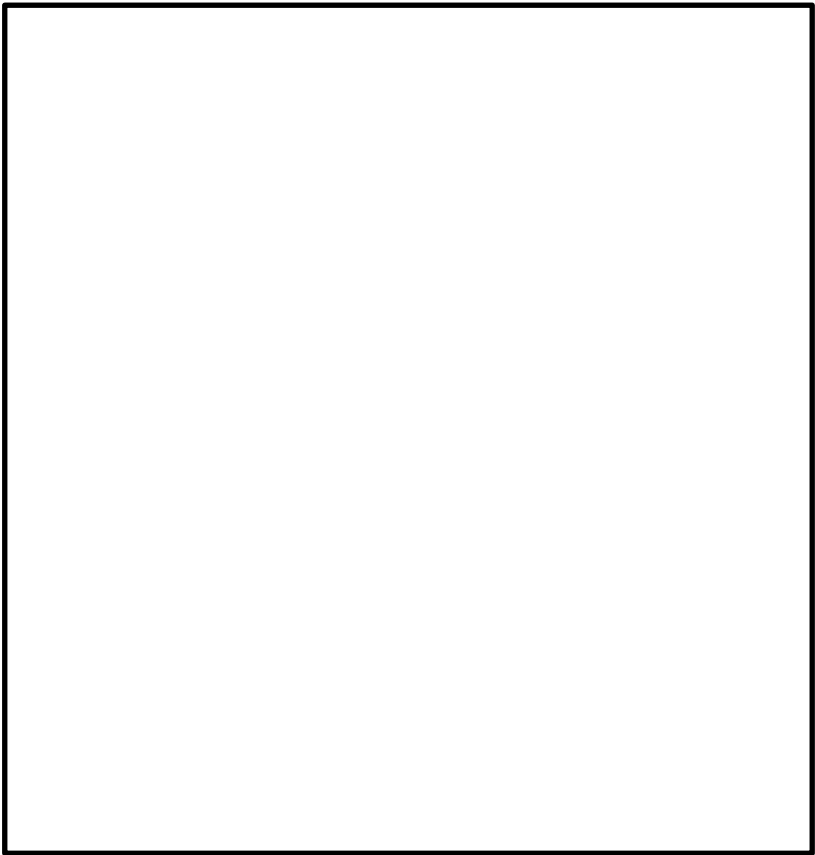
柏崎刈羽原子力発電所 6 / 7号炉 (2017. 12. 20 版)	東海第二発電所 (2018. 9. 18 版)	島根原子力発電所 2号炉	備考																																																																																													
<p>添付第 5.3-2 表 6 号炉原子炉二次格納施設内防護対象設備の蒸気影響確認結果</p> <table border="1" data-bbox="151 352 884 1249"> <thead> <tr> <th>系統</th> <th>設備</th> <th>蒸気評価</th> </tr> </thead> <tbody> <tr><td>原子炉系</td><td>原子炉水位 (B21-LT003A)</td><td>○</td></tr> <tr><td>原子炉系</td><td>原子炉水位 (B21-LT003B)</td><td>○</td></tr> <tr><td>原子炉系</td><td>原子炉水位 (B21-LT003C)</td><td>○</td></tr> <tr><td>原子炉系</td><td>原子炉水位 (B21-LT003D)</td><td>○</td></tr> <tr><td>原子炉系</td><td>原子炉水位 (B21-LT003E)</td><td>○</td></tr> <tr><td>原子炉系</td><td>原子炉水位 (B21-LT003F)</td><td>○</td></tr> <tr><td>原子炉系</td><td>原子炉水位 (B21-LT003G)</td><td>○</td></tr> <tr><td>原子炉系</td><td>原子炉水位 (B21-LT003H)</td><td>○</td></tr> <tr><td>原子炉系</td><td>原子炉水位 (B21-LT006A)</td><td>○</td></tr> <tr><td>原子炉系</td><td>原子炉水位 (B21-LT006B)</td><td>○</td></tr> <tr><td>原子炉系</td><td>原子炉圧力 (B21-PT007A)</td><td>○</td></tr> <tr><td>原子炉系</td><td>原子炉圧力 (B21-PT007B)</td><td>○</td></tr> <tr><td>原子炉系</td><td>原子炉圧力 (B21-PT007C)</td><td>○</td></tr> <tr><td>原子炉系</td><td>原子炉圧力 (B21-PT007D)</td><td>○</td></tr> <tr><td>制御棒駆動系</td><td>水圧制御ユニット (C12-D004) (東側)</td><td>○</td></tr> <tr><td>制御棒駆動系</td><td>水圧制御ユニット (C12-D004) (西側)</td><td>○</td></tr> <tr><td>ほう酸水注入系</td><td>ほう酸水注入系ポンプ (C41-C001A)</td><td>○</td></tr> <tr><td>ほう酸水注入系</td><td>ほう酸水注入系ポンプ (C41-C001B)</td><td>○</td></tr> <tr><td>ほう酸水注入系</td><td>ほう酸水注入系ポンプ用潤滑油ポンプ (C41-C002A)</td><td>○</td></tr> <tr><td>ほう酸水注入系</td><td>ほう酸水注入系ポンプ用潤滑油ポンプ (C41-C002B)</td><td>○</td></tr> <tr><td>ほう酸水注入系</td><td>ほう酸水注入系弁 (C41-MO-F001A)</td><td>○</td></tr> <tr><td>ほう酸水注入系</td><td>ほう酸水注入系弁 (C41-MO-F001B)</td><td>○</td></tr> <tr><td>ほう酸水注入系</td><td>ほう酸水注入系弁 (C41-MO-F006A)</td><td>○</td></tr> <tr><td>ほう酸水注入系</td><td>ほう酸水注入系弁 (C41-MO-F006B)</td><td>○</td></tr> <tr><td>格納容器内雰囲気モニタ系</td><td>格納容器内雰囲気モニタ系コネクタ保護ボックス (D23 コレクタ保護ボックス)</td><td>○</td></tr> <tr><td>格納容器内雰囲気モニタ系</td><td>格納容器内雰囲気モニタ系コネクタ保護ボックス (D23 コレクタ保護ボックス)</td><td>○</td></tr> <tr><td>格納容器内雰囲気モニタ系</td><td>格納容器内雰囲気モニタ系コネクタ保護ボックス (D23 コレクタ保護ボックス)</td><td>○</td></tr> <tr><td>格納容器内雰囲気モニタ系</td><td>格納容器内雰囲気モニタ系コネクタ保護ボックス (D23 コレクタ保護ボックス)</td><td>○</td></tr> <tr><td>格納容器内雰囲気モニタ系</td><td>水素系検出ユニット (D23-H2T001A)</td><td>○</td></tr> <tr><td>格納容器内雰囲気モニタ系</td><td>水素系検出ユニット (D23-H2T001B)</td><td>○</td></tr> </tbody> </table>	系統	設備	蒸気評価	原子炉系	原子炉水位 (B21-LT003A)	○	原子炉系	原子炉水位 (B21-LT003B)	○	原子炉系	原子炉水位 (B21-LT003C)	○	原子炉系	原子炉水位 (B21-LT003D)	○	原子炉系	原子炉水位 (B21-LT003E)	○	原子炉系	原子炉水位 (B21-LT003F)	○	原子炉系	原子炉水位 (B21-LT003G)	○	原子炉系	原子炉水位 (B21-LT003H)	○	原子炉系	原子炉水位 (B21-LT006A)	○	原子炉系	原子炉水位 (B21-LT006B)	○	原子炉系	原子炉圧力 (B21-PT007A)	○	原子炉系	原子炉圧力 (B21-PT007B)	○	原子炉系	原子炉圧力 (B21-PT007C)	○	原子炉系	原子炉圧力 (B21-PT007D)	○	制御棒駆動系	水圧制御ユニット (C12-D004) (東側)	○	制御棒駆動系	水圧制御ユニット (C12-D004) (西側)	○	ほう酸水注入系	ほう酸水注入系ポンプ (C41-C001A)	○	ほう酸水注入系	ほう酸水注入系ポンプ (C41-C001B)	○	ほう酸水注入系	ほう酸水注入系ポンプ用潤滑油ポンプ (C41-C002A)	○	ほう酸水注入系	ほう酸水注入系ポンプ用潤滑油ポンプ (C41-C002B)	○	ほう酸水注入系	ほう酸水注入系弁 (C41-MO-F001A)	○	ほう酸水注入系	ほう酸水注入系弁 (C41-MO-F001B)	○	ほう酸水注入系	ほう酸水注入系弁 (C41-MO-F006A)	○	ほう酸水注入系	ほう酸水注入系弁 (C41-MO-F006B)	○	格納容器内雰囲気モニタ系	格納容器内雰囲気モニタ系コネクタ保護ボックス (D23 コレクタ保護ボックス)	○	格納容器内雰囲気モニタ系	格納容器内雰囲気モニタ系コネクタ保護ボックス (D23 コレクタ保護ボックス)	○	格納容器内雰囲気モニタ系	格納容器内雰囲気モニタ系コネクタ保護ボックス (D23 コレクタ保護ボックス)	○	格納容器内雰囲気モニタ系	格納容器内雰囲気モニタ系コネクタ保護ボックス (D23 コレクタ保護ボックス)	○	格納容器内雰囲気モニタ系	水素系検出ユニット (D23-H2T001A)	○	格納容器内雰囲気モニタ系	水素系検出ユニット (D23-H2T001B)	○		 <p style="text-align: center;">図 3-1 蒸気源有無の全体概略図</p>	
系統	設備	蒸気評価																																																																																														
原子炉系	原子炉水位 (B21-LT003A)	○																																																																																														
原子炉系	原子炉水位 (B21-LT003B)	○																																																																																														
原子炉系	原子炉水位 (B21-LT003C)	○																																																																																														
原子炉系	原子炉水位 (B21-LT003D)	○																																																																																														
原子炉系	原子炉水位 (B21-LT003E)	○																																																																																														
原子炉系	原子炉水位 (B21-LT003F)	○																																																																																														
原子炉系	原子炉水位 (B21-LT003G)	○																																																																																														
原子炉系	原子炉水位 (B21-LT003H)	○																																																																																														
原子炉系	原子炉水位 (B21-LT006A)	○																																																																																														
原子炉系	原子炉水位 (B21-LT006B)	○																																																																																														
原子炉系	原子炉圧力 (B21-PT007A)	○																																																																																														
原子炉系	原子炉圧力 (B21-PT007B)	○																																																																																														
原子炉系	原子炉圧力 (B21-PT007C)	○																																																																																														
原子炉系	原子炉圧力 (B21-PT007D)	○																																																																																														
制御棒駆動系	水圧制御ユニット (C12-D004) (東側)	○																																																																																														
制御棒駆動系	水圧制御ユニット (C12-D004) (西側)	○																																																																																														
ほう酸水注入系	ほう酸水注入系ポンプ (C41-C001A)	○																																																																																														
ほう酸水注入系	ほう酸水注入系ポンプ (C41-C001B)	○																																																																																														
ほう酸水注入系	ほう酸水注入系ポンプ用潤滑油ポンプ (C41-C002A)	○																																																																																														
ほう酸水注入系	ほう酸水注入系ポンプ用潤滑油ポンプ (C41-C002B)	○																																																																																														
ほう酸水注入系	ほう酸水注入系弁 (C41-MO-F001A)	○																																																																																														
ほう酸水注入系	ほう酸水注入系弁 (C41-MO-F001B)	○																																																																																														
ほう酸水注入系	ほう酸水注入系弁 (C41-MO-F006A)	○																																																																																														
ほう酸水注入系	ほう酸水注入系弁 (C41-MO-F006B)	○																																																																																														
格納容器内雰囲気モニタ系	格納容器内雰囲気モニタ系コネクタ保護ボックス (D23 コレクタ保護ボックス)	○																																																																																														
格納容器内雰囲気モニタ系	格納容器内雰囲気モニタ系コネクタ保護ボックス (D23 コレクタ保護ボックス)	○																																																																																														
格納容器内雰囲気モニタ系	格納容器内雰囲気モニタ系コネクタ保護ボックス (D23 コレクタ保護ボックス)	○																																																																																														
格納容器内雰囲気モニタ系	格納容器内雰囲気モニタ系コネクタ保護ボックス (D23 コレクタ保護ボックス)	○																																																																																														
格納容器内雰囲気モニタ系	水素系検出ユニット (D23-H2T001A)	○																																																																																														
格納容器内雰囲気モニタ系	水素系検出ユニット (D23-H2T001B)	○																																																																																														

柏崎刈羽原子力発電所 6 / 7号炉 (2017.12.20版)	東海第二発電所 (2018.9.18版)	島根原子力発電所 2号炉	備考																																																																																																						
添付第 5.3-2 表 6号炉原子炉二次格納施設内防護対象設備の蒸気影響確認結果																																																																																																									
<table border="1"> <thead> <tr> <th>系統</th> <th>設備</th> <th>蒸気評価</th> </tr> </thead> <tbody> <tr><td>格納容器内雰囲気モニタ系</td><td>酸素系検出ユニット (D23-O2T003A)</td><td>○</td></tr> <tr><td>格納容器内雰囲気モニタ系</td><td>酸素系検出ユニット (D23-O2T003B)</td><td>○</td></tr> <tr><td>格納容器内雰囲気モニタ系</td><td>イオンチェンバ検出器 (D23-RE005A)</td><td>○</td></tr> <tr><td>格納容器内雰囲気モニタ系</td><td>イオンチェンバ検出器 (D23-RE005B)</td><td>○</td></tr> <tr><td>格納容器内雰囲気モニタ系</td><td>イオンチェンバ検出器 (D23-RE006A)</td><td>○</td></tr> <tr><td>格納容器内雰囲気モニタ系</td><td>イオンチェンバ検出器 (D23-RE006B)</td><td>○</td></tr> <tr><td>格納容器内雰囲気モニタ系</td><td>格納容器内雰囲気モニタ系弁 (D23-SO-F001A)</td><td>○</td></tr> <tr><td>格納容器内雰囲気モニタ系</td><td>格納容器内雰囲気モニタ系弁 (D23-SO-F001B)</td><td>○</td></tr> <tr><td>格納容器内雰囲気モニタ系</td><td>格納容器内雰囲気モニタ系弁 (D23-SO-F002A)</td><td>○</td></tr> <tr><td>格納容器内雰囲気モニタ系</td><td>格納容器内雰囲気モニタ系弁 (D23-SO-F002B)</td><td>○</td></tr> <tr><td>格納容器内雰囲気モニタ系</td><td>格納容器内雰囲気モニタ系弁 (D23-SO-F003A)</td><td>○</td></tr> <tr><td>格納容器内雰囲気モニタ系</td><td>格納容器内雰囲気モニタ系弁 (D23-SO-F003B)</td><td>○</td></tr> <tr><td>格納容器内雰囲気モニタ系</td><td>格納容器内雰囲気モニタ系弁 (D23-SO-F004A)</td><td>○</td></tr> <tr><td>格納容器内雰囲気モニタ系</td><td>格納容器内雰囲気モニタ系弁 (D23-SO-F004B)</td><td>○</td></tr> <tr><td>残留熱除去系</td><td>残留熱除去系ポンプ (E11-C001A)</td><td>○</td></tr> <tr><td>残留熱除去系</td><td>残留熱除去系ポンプ (E11-C001B)</td><td>○</td></tr> <tr><td>残留熱除去系</td><td>残留熱除去系ポンプ (E11-C001C)</td><td>○</td></tr> <tr><td>残留熱除去系</td><td>残留熱除去系弁 (E11-F016A)</td><td>○</td></tr> <tr><td>残留熱除去系</td><td>残留熱除去系弁 (E11-F016B)</td><td>○</td></tr> <tr><td>残留熱除去系</td><td>残留熱除去系弁 (E11-F016C)</td><td>○</td></tr> <tr><td>残留熱除去系</td><td>残留熱除去系系統流量 (E11-FT008A)</td><td>○</td></tr> <tr><td>残留熱除去系</td><td>残留熱除去系系統流量 (E11-FT008B)</td><td>○</td></tr> <tr><td>残留熱除去系</td><td>残留熱除去系系統流量 (E11-FT008C)</td><td>○</td></tr> <tr><td>残留熱除去系</td><td>残留熱除去系弁 (E11-MO-F001A)</td><td>○</td></tr> <tr><td>残留熱除去系</td><td>残留熱除去系弁 (E11-MO-F001B)</td><td>○</td></tr> <tr><td>残留熱除去系</td><td>残留熱除去系弁 (E11-MO-F001C)</td><td>○</td></tr> <tr><td>残留熱除去系</td><td>残留熱除去系弁 (E11-MO-F004A)</td><td>○</td></tr> <tr><td>残留熱除去系</td><td>残留熱除去系弁 (E11-MO-F004B)</td><td>○</td></tr> <tr><td>残留熱除去系</td><td>残留熱除去系弁 (E11-MO-F004C)</td><td>○</td></tr> <tr><td>残留熱除去系</td><td>残留熱除去系弁 (E11-MO-F005A)</td><td>○</td></tr> <tr><td>残留熱除去系</td><td>残留熱除去系弁 (E11-MO-F005B)</td><td>○</td></tr> <tr><td>残留熱除去系</td><td>残留熱除去系弁 (E11-MO-F005C)</td><td>○</td></tr> <tr><td>残留熱除去系</td><td>残留熱除去系弁 (E11-MO-F008A)</td><td>○</td></tr> </tbody> </table>	系統	設備	蒸気評価	格納容器内雰囲気モニタ系	酸素系検出ユニット (D23-O2T003A)	○	格納容器内雰囲気モニタ系	酸素系検出ユニット (D23-O2T003B)	○	格納容器内雰囲気モニタ系	イオンチェンバ検出器 (D23-RE005A)	○	格納容器内雰囲気モニタ系	イオンチェンバ検出器 (D23-RE005B)	○	格納容器内雰囲気モニタ系	イオンチェンバ検出器 (D23-RE006A)	○	格納容器内雰囲気モニタ系	イオンチェンバ検出器 (D23-RE006B)	○	格納容器内雰囲気モニタ系	格納容器内雰囲気モニタ系弁 (D23-SO-F001A)	○	格納容器内雰囲気モニタ系	格納容器内雰囲気モニタ系弁 (D23-SO-F001B)	○	格納容器内雰囲気モニタ系	格納容器内雰囲気モニタ系弁 (D23-SO-F002A)	○	格納容器内雰囲気モニタ系	格納容器内雰囲気モニタ系弁 (D23-SO-F002B)	○	格納容器内雰囲気モニタ系	格納容器内雰囲気モニタ系弁 (D23-SO-F003A)	○	格納容器内雰囲気モニタ系	格納容器内雰囲気モニタ系弁 (D23-SO-F003B)	○	格納容器内雰囲気モニタ系	格納容器内雰囲気モニタ系弁 (D23-SO-F004A)	○	格納容器内雰囲気モニタ系	格納容器内雰囲気モニタ系弁 (D23-SO-F004B)	○	残留熱除去系	残留熱除去系ポンプ (E11-C001A)	○	残留熱除去系	残留熱除去系ポンプ (E11-C001B)	○	残留熱除去系	残留熱除去系ポンプ (E11-C001C)	○	残留熱除去系	残留熱除去系弁 (E11-F016A)	○	残留熱除去系	残留熱除去系弁 (E11-F016B)	○	残留熱除去系	残留熱除去系弁 (E11-F016C)	○	残留熱除去系	残留熱除去系系統流量 (E11-FT008A)	○	残留熱除去系	残留熱除去系系統流量 (E11-FT008B)	○	残留熱除去系	残留熱除去系系統流量 (E11-FT008C)	○	残留熱除去系	残留熱除去系弁 (E11-MO-F001A)	○	残留熱除去系	残留熱除去系弁 (E11-MO-F001B)	○	残留熱除去系	残留熱除去系弁 (E11-MO-F001C)	○	残留熱除去系	残留熱除去系弁 (E11-MO-F004A)	○	残留熱除去系	残留熱除去系弁 (E11-MO-F004B)	○	残留熱除去系	残留熱除去系弁 (E11-MO-F004C)	○	残留熱除去系	残留熱除去系弁 (E11-MO-F005A)	○	残留熱除去系	残留熱除去系弁 (E11-MO-F005B)	○	残留熱除去系	残留熱除去系弁 (E11-MO-F005C)	○	残留熱除去系	残留熱除去系弁 (E11-MO-F008A)	○			
系統	設備	蒸気評価																																																																																																							
格納容器内雰囲気モニタ系	酸素系検出ユニット (D23-O2T003A)	○																																																																																																							
格納容器内雰囲気モニタ系	酸素系検出ユニット (D23-O2T003B)	○																																																																																																							
格納容器内雰囲気モニタ系	イオンチェンバ検出器 (D23-RE005A)	○																																																																																																							
格納容器内雰囲気モニタ系	イオンチェンバ検出器 (D23-RE005B)	○																																																																																																							
格納容器内雰囲気モニタ系	イオンチェンバ検出器 (D23-RE006A)	○																																																																																																							
格納容器内雰囲気モニタ系	イオンチェンバ検出器 (D23-RE006B)	○																																																																																																							
格納容器内雰囲気モニタ系	格納容器内雰囲気モニタ系弁 (D23-SO-F001A)	○																																																																																																							
格納容器内雰囲気モニタ系	格納容器内雰囲気モニタ系弁 (D23-SO-F001B)	○																																																																																																							
格納容器内雰囲気モニタ系	格納容器内雰囲気モニタ系弁 (D23-SO-F002A)	○																																																																																																							
格納容器内雰囲気モニタ系	格納容器内雰囲気モニタ系弁 (D23-SO-F002B)	○																																																																																																							
格納容器内雰囲気モニタ系	格納容器内雰囲気モニタ系弁 (D23-SO-F003A)	○																																																																																																							
格納容器内雰囲気モニタ系	格納容器内雰囲気モニタ系弁 (D23-SO-F003B)	○																																																																																																							
格納容器内雰囲気モニタ系	格納容器内雰囲気モニタ系弁 (D23-SO-F004A)	○																																																																																																							
格納容器内雰囲気モニタ系	格納容器内雰囲気モニタ系弁 (D23-SO-F004B)	○																																																																																																							
残留熱除去系	残留熱除去系ポンプ (E11-C001A)	○																																																																																																							
残留熱除去系	残留熱除去系ポンプ (E11-C001B)	○																																																																																																							
残留熱除去系	残留熱除去系ポンプ (E11-C001C)	○																																																																																																							
残留熱除去系	残留熱除去系弁 (E11-F016A)	○																																																																																																							
残留熱除去系	残留熱除去系弁 (E11-F016B)	○																																																																																																							
残留熱除去系	残留熱除去系弁 (E11-F016C)	○																																																																																																							
残留熱除去系	残留熱除去系系統流量 (E11-FT008A)	○																																																																																																							
残留熱除去系	残留熱除去系系統流量 (E11-FT008B)	○																																																																																																							
残留熱除去系	残留熱除去系系統流量 (E11-FT008C)	○																																																																																																							
残留熱除去系	残留熱除去系弁 (E11-MO-F001A)	○																																																																																																							
残留熱除去系	残留熱除去系弁 (E11-MO-F001B)	○																																																																																																							
残留熱除去系	残留熱除去系弁 (E11-MO-F001C)	○																																																																																																							
残留熱除去系	残留熱除去系弁 (E11-MO-F004A)	○																																																																																																							
残留熱除去系	残留熱除去系弁 (E11-MO-F004B)	○																																																																																																							
残留熱除去系	残留熱除去系弁 (E11-MO-F004C)	○																																																																																																							
残留熱除去系	残留熱除去系弁 (E11-MO-F005A)	○																																																																																																							
残留熱除去系	残留熱除去系弁 (E11-MO-F005B)	○																																																																																																							
残留熱除去系	残留熱除去系弁 (E11-MO-F005C)	○																																																																																																							
残留熱除去系	残留熱除去系弁 (E11-MO-F008A)	○																																																																																																							

柏崎刈羽原子力発電所 6 / 7号炉 (2017. 12. 20 版)	東海第二発電所 (2018. 9. 18 版)	島根原子力発電所 2号炉	備考																																																																																																
<p>添付第 5.3-2 表 6 号炉原子炉二次格納施設内防護対象設備の蒸気影響確認結果</p> <table border="1"> <thead> <tr> <th>系統</th> <th>設備</th> <th>蒸気評価</th> </tr> </thead> <tbody> <tr><td>残留熱除去系</td><td>残留熱除去系弁 (E11-MO-F008B)</td><td>○</td></tr> <tr><td>残留熱除去系</td><td>残留熱除去系弁 (E11-MO-F008C)</td><td>○</td></tr> <tr><td>残留熱除去系</td><td>残留熱除去系弁 (E11-MO-F011A)</td><td>○</td></tr> <tr><td>残留熱除去系</td><td>残留熱除去系弁 (E11-MO-F011B)</td><td>○</td></tr> <tr><td>残留熱除去系</td><td>残留熱除去系弁 (E11-MO-F011C)</td><td>○</td></tr> <tr><td>残留熱除去系</td><td>残留熱除去系弁 (E11-MO-F012A)</td><td>○</td></tr> <tr><td>残留熱除去系</td><td>残留熱除去系弁 (E11-MO-F012B)</td><td>○</td></tr> <tr><td>残留熱除去系</td><td>残留熱除去系弁 (E11-MO-F012C)</td><td>○</td></tr> <tr><td>残留熱除去系</td><td>残留熱除去系弁 (E11-MO-F013A)</td><td>○</td></tr> <tr><td>残留熱除去系</td><td>残留熱除去系弁 (E11-MO-F013B)</td><td>○</td></tr> <tr><td>残留熱除去系</td><td>残留熱除去系弁 (E11-MO-F013C)</td><td>○</td></tr> <tr><td>残留熱除去系</td><td>残留熱除去系弁 (E11-MO-F014A)</td><td>○</td></tr> <tr><td>残留熱除去系</td><td>残留熱除去系弁 (E11-MO-F014B)</td><td>○</td></tr> <tr><td>残留熱除去系</td><td>残留熱除去系弁 (E11-MO-F014C)</td><td>○</td></tr> <tr><td>残留熱除去系</td><td>残留熱除去系弁 (E11-MO-F015)</td><td>○</td></tr> <tr><td>残留熱除去系</td><td>残留熱除去系弁 (E11-MO-F017B)</td><td>○</td></tr> <tr><td>残留熱除去系</td><td>残留熱除去系弁 (E11-MO-F017C)</td><td>○</td></tr> <tr><td>残留熱除去系</td><td>残留熱除去系弁 (E11-MO-F018B)</td><td>○</td></tr> <tr><td>残留熱除去系</td><td>残留熱除去系弁 (E11-MO-F018C)</td><td>○</td></tr> <tr><td>残留熱除去系</td><td>残留熱除去系弁 (E11-MO-F019B)</td><td>○</td></tr> <tr><td>残留熱除去系</td><td>残留熱除去系弁 (E11-MO-F019C)</td><td>○</td></tr> <tr><td>残留熱除去系</td><td>残留熱除去系弁 (E11-MO-F021A)</td><td>○</td></tr> <tr><td>残留熱除去系</td><td>残留熱除去系弁 (E11-MO-F021B)</td><td>○</td></tr> <tr><td>残留熱除去系</td><td>残留熱除去系弁 (E11-MO-F021C)</td><td>○</td></tr> <tr><td>高圧炉心注水系</td><td>高圧炉心注水系ポンプ (E22-C001B)</td><td>○</td></tr> <tr><td>高圧炉心注水系</td><td>高圧炉心注水系ポンプ (E22-C001C)</td><td>○</td></tr> <tr><td>高圧炉心注水系</td><td>高圧炉心注水系系統流量 (E22-FT008B-1)</td><td>○</td></tr> <tr><td>高圧炉心注水系</td><td>高圧炉心注水系系統流量 (E22-FT008C-1)</td><td>○</td></tr> <tr><td>高圧炉心注水系</td><td>高圧炉心注水系系統流量 (E22-LT010A)</td><td>○</td></tr> <tr><td>高圧炉心注水系</td><td>高圧炉心注水系系統流量 (E22-LT010B)</td><td>○</td></tr> <tr><td>高圧炉心注水系</td><td>高圧炉心注水系系統流量 (E22-LT010C)</td><td>○</td></tr> </tbody> </table>	系統	設備	蒸気評価	残留熱除去系	残留熱除去系弁 (E11-MO-F008B)	○	残留熱除去系	残留熱除去系弁 (E11-MO-F008C)	○	残留熱除去系	残留熱除去系弁 (E11-MO-F011A)	○	残留熱除去系	残留熱除去系弁 (E11-MO-F011B)	○	残留熱除去系	残留熱除去系弁 (E11-MO-F011C)	○	残留熱除去系	残留熱除去系弁 (E11-MO-F012A)	○	残留熱除去系	残留熱除去系弁 (E11-MO-F012B)	○	残留熱除去系	残留熱除去系弁 (E11-MO-F012C)	○	残留熱除去系	残留熱除去系弁 (E11-MO-F013A)	○	残留熱除去系	残留熱除去系弁 (E11-MO-F013B)	○	残留熱除去系	残留熱除去系弁 (E11-MO-F013C)	○	残留熱除去系	残留熱除去系弁 (E11-MO-F014A)	○	残留熱除去系	残留熱除去系弁 (E11-MO-F014B)	○	残留熱除去系	残留熱除去系弁 (E11-MO-F014C)	○	残留熱除去系	残留熱除去系弁 (E11-MO-F015)	○	残留熱除去系	残留熱除去系弁 (E11-MO-F017B)	○	残留熱除去系	残留熱除去系弁 (E11-MO-F017C)	○	残留熱除去系	残留熱除去系弁 (E11-MO-F018B)	○	残留熱除去系	残留熱除去系弁 (E11-MO-F018C)	○	残留熱除去系	残留熱除去系弁 (E11-MO-F019B)	○	残留熱除去系	残留熱除去系弁 (E11-MO-F019C)	○	残留熱除去系	残留熱除去系弁 (E11-MO-F021A)	○	残留熱除去系	残留熱除去系弁 (E11-MO-F021B)	○	残留熱除去系	残留熱除去系弁 (E11-MO-F021C)	○	高圧炉心注水系	高圧炉心注水系ポンプ (E22-C001B)	○	高圧炉心注水系	高圧炉心注水系ポンプ (E22-C001C)	○	高圧炉心注水系	高圧炉心注水系系統流量 (E22-FT008B-1)	○	高圧炉心注水系	高圧炉心注水系系統流量 (E22-FT008C-1)	○	高圧炉心注水系	高圧炉心注水系系統流量 (E22-LT010A)	○	高圧炉心注水系	高圧炉心注水系系統流量 (E22-LT010B)	○	高圧炉心注水系	高圧炉心注水系系統流量 (E22-LT010C)	○			
系統	設備	蒸気評価																																																																																																	
残留熱除去系	残留熱除去系弁 (E11-MO-F008B)	○																																																																																																	
残留熱除去系	残留熱除去系弁 (E11-MO-F008C)	○																																																																																																	
残留熱除去系	残留熱除去系弁 (E11-MO-F011A)	○																																																																																																	
残留熱除去系	残留熱除去系弁 (E11-MO-F011B)	○																																																																																																	
残留熱除去系	残留熱除去系弁 (E11-MO-F011C)	○																																																																																																	
残留熱除去系	残留熱除去系弁 (E11-MO-F012A)	○																																																																																																	
残留熱除去系	残留熱除去系弁 (E11-MO-F012B)	○																																																																																																	
残留熱除去系	残留熱除去系弁 (E11-MO-F012C)	○																																																																																																	
残留熱除去系	残留熱除去系弁 (E11-MO-F013A)	○																																																																																																	
残留熱除去系	残留熱除去系弁 (E11-MO-F013B)	○																																																																																																	
残留熱除去系	残留熱除去系弁 (E11-MO-F013C)	○																																																																																																	
残留熱除去系	残留熱除去系弁 (E11-MO-F014A)	○																																																																																																	
残留熱除去系	残留熱除去系弁 (E11-MO-F014B)	○																																																																																																	
残留熱除去系	残留熱除去系弁 (E11-MO-F014C)	○																																																																																																	
残留熱除去系	残留熱除去系弁 (E11-MO-F015)	○																																																																																																	
残留熱除去系	残留熱除去系弁 (E11-MO-F017B)	○																																																																																																	
残留熱除去系	残留熱除去系弁 (E11-MO-F017C)	○																																																																																																	
残留熱除去系	残留熱除去系弁 (E11-MO-F018B)	○																																																																																																	
残留熱除去系	残留熱除去系弁 (E11-MO-F018C)	○																																																																																																	
残留熱除去系	残留熱除去系弁 (E11-MO-F019B)	○																																																																																																	
残留熱除去系	残留熱除去系弁 (E11-MO-F019C)	○																																																																																																	
残留熱除去系	残留熱除去系弁 (E11-MO-F021A)	○																																																																																																	
残留熱除去系	残留熱除去系弁 (E11-MO-F021B)	○																																																																																																	
残留熱除去系	残留熱除去系弁 (E11-MO-F021C)	○																																																																																																	
高圧炉心注水系	高圧炉心注水系ポンプ (E22-C001B)	○																																																																																																	
高圧炉心注水系	高圧炉心注水系ポンプ (E22-C001C)	○																																																																																																	
高圧炉心注水系	高圧炉心注水系系統流量 (E22-FT008B-1)	○																																																																																																	
高圧炉心注水系	高圧炉心注水系系統流量 (E22-FT008C-1)	○																																																																																																	
高圧炉心注水系	高圧炉心注水系系統流量 (E22-LT010A)	○																																																																																																	
高圧炉心注水系	高圧炉心注水系系統流量 (E22-LT010B)	○																																																																																																	
高圧炉心注水系	高圧炉心注水系系統流量 (E22-LT010C)	○																																																																																																	

柏崎刈羽原子力発電所 6 / 7号炉 (2017. 12. 20 版)	東海第二発電所 (2018. 9. 18 版)	島根原子力発電所 2号炉	備考																																																																																																						
添付第 5.3-2 表 6号炉原子炉二次格納施設内防護対象設備の蒸気影響確認結果																																																																																																									
<table border="1"> <thead> <tr> <th>系統</th> <th>設備</th> <th>蒸気評価</th> </tr> </thead> <tbody> <tr><td>高圧炉心注水系</td><td>高圧炉心注水系系統流量 (E22-LT010D)</td><td>○</td></tr> <tr><td>高圧炉心注水系</td><td>高圧炉心注水系弁 (E22-MO-F001B)</td><td>○</td></tr> <tr><td>高圧炉心注水系</td><td>高圧炉心注水系弁 (E22-MO-F001C)</td><td>○</td></tr> <tr><td>高圧炉心注水系</td><td>高圧炉心注水系弁 (E22-MO-F003B)</td><td>○</td></tr> <tr><td>高圧炉心注水系</td><td>高圧炉心注水系弁 (E22-MO-F003C)</td><td>○</td></tr> <tr><td>高圧炉心注水系</td><td>高圧炉心注水系弁 (E22-MO-F006B)</td><td>○</td></tr> <tr><td>高圧炉心注水系</td><td>高圧炉心注水系弁 (E22-MO-F006C)</td><td>○</td></tr> <tr><td>高圧炉心注水系</td><td>高圧炉心注水系弁 (E22-MO-F010B)</td><td>○</td></tr> <tr><td>高圧炉心注水系</td><td>高圧炉心注水系弁 (E22-MO-F010C)</td><td>○</td></tr> <tr><td>原子炉隔離時冷却系</td><td>原子炉隔離時冷却系ポンプ (E51-C001)</td><td>○</td></tr> <tr><td>原子炉隔離時冷却系</td><td>原子炉隔離時冷却系蒸気タービン (E51-C002)</td><td>○</td></tr> <tr><td>原子炉隔離時冷却系</td><td>原子炉隔離時冷却系復水ポンプ (E51-C003)</td><td>○</td></tr> <tr><td>原子炉隔離時冷却系</td><td>原子炉隔離時冷却系真空ポンプ (E51-C004)</td><td>○</td></tr> <tr><td>原子炉隔離時冷却系</td><td>原子炉隔離時冷却系主油ポンプ (E51-C005)</td><td>○</td></tr> <tr><td>原子炉隔離時冷却系</td><td>原子炉隔離時冷却系系統流量 (E51-FT007)</td><td>○</td></tr> <tr><td>原子炉隔離時冷却系</td><td>原子炉隔離時冷却系弁 (E51-HO-F069)</td><td>○</td></tr> <tr><td>原子炉隔離時冷却系</td><td>原子炉隔離時冷却系弁 (E51-MO-F001)</td><td>○</td></tr> <tr><td>原子炉隔離時冷却系</td><td>原子炉隔離時冷却系弁 (E51-MO-F004)</td><td>○</td></tr> <tr><td>原子炉隔離時冷却系</td><td>原子炉隔離時冷却系弁 (E51-MO-F006)</td><td>○</td></tr> <tr><td>原子炉隔離時冷却系</td><td>原子炉隔離時冷却系弁 (E51-MO-F011)</td><td>○</td></tr> <tr><td>原子炉隔離時冷却系</td><td>原子炉隔離時冷却系弁 (E51-MO-F012)</td><td>○</td></tr> <tr><td>原子炉隔離時冷却系</td><td>原子炉隔離時冷却系弁 (E51-MO-F036)</td><td>○</td></tr> <tr><td>原子炉隔離時冷却系</td><td>原子炉隔離時冷却系弁 (E51-MO-F037)</td><td>○</td></tr> <tr><td>原子炉隔離時冷却系</td><td>原子炉隔離時冷却系弁 (E51-MO-F068)</td><td>○</td></tr> <tr><td>原子炉冷却材浄化系</td><td>原子炉冷却材浄化系弁 (G31-MO-F003)</td><td>○</td></tr> <tr><td>燃料プール冷却浄化系</td><td>燃料プール冷却浄化系ポンプ (G41-C001A)</td><td>○</td></tr> <tr><td>燃料プール冷却浄化系</td><td>燃料プール冷却浄化系ポンプ (G41-C001B)</td><td>○</td></tr> <tr><td>燃料プール冷却浄化系</td><td>燃料プール冷却浄化系弁 (G41-F020)</td><td>○</td></tr> <tr><td>燃料プール冷却浄化系</td><td>燃料プール冷却浄化系弁 (G41-MO-F005A)</td><td>○</td></tr> <tr><td>燃料プール冷却浄化系</td><td>燃料プール冷却浄化系弁 (G41-MO-F012)</td><td>○</td></tr> <tr><td>燃料プール冷却浄化系</td><td>燃料プール冷却浄化系弁 (G41-MO-F021A)</td><td>○</td></tr> <tr><td>燃料プール冷却浄化系</td><td>燃料プール冷却浄化系弁 (G41-MO-F021B)</td><td>○</td></tr> <tr><td>サブプレッションプール浄化系</td><td>サブプレッションプール浄化系ポンプ (G51-C001)</td><td>○</td></tr> </tbody> </table>	系統	設備	蒸気評価	高圧炉心注水系	高圧炉心注水系系統流量 (E22-LT010D)	○	高圧炉心注水系	高圧炉心注水系弁 (E22-MO-F001B)	○	高圧炉心注水系	高圧炉心注水系弁 (E22-MO-F001C)	○	高圧炉心注水系	高圧炉心注水系弁 (E22-MO-F003B)	○	高圧炉心注水系	高圧炉心注水系弁 (E22-MO-F003C)	○	高圧炉心注水系	高圧炉心注水系弁 (E22-MO-F006B)	○	高圧炉心注水系	高圧炉心注水系弁 (E22-MO-F006C)	○	高圧炉心注水系	高圧炉心注水系弁 (E22-MO-F010B)	○	高圧炉心注水系	高圧炉心注水系弁 (E22-MO-F010C)	○	原子炉隔離時冷却系	原子炉隔離時冷却系ポンプ (E51-C001)	○	原子炉隔離時冷却系	原子炉隔離時冷却系蒸気タービン (E51-C002)	○	原子炉隔離時冷却系	原子炉隔離時冷却系復水ポンプ (E51-C003)	○	原子炉隔離時冷却系	原子炉隔離時冷却系真空ポンプ (E51-C004)	○	原子炉隔離時冷却系	原子炉隔離時冷却系主油ポンプ (E51-C005)	○	原子炉隔離時冷却系	原子炉隔離時冷却系系統流量 (E51-FT007)	○	原子炉隔離時冷却系	原子炉隔離時冷却系弁 (E51-HO-F069)	○	原子炉隔離時冷却系	原子炉隔離時冷却系弁 (E51-MO-F001)	○	原子炉隔離時冷却系	原子炉隔離時冷却系弁 (E51-MO-F004)	○	原子炉隔離時冷却系	原子炉隔離時冷却系弁 (E51-MO-F006)	○	原子炉隔離時冷却系	原子炉隔離時冷却系弁 (E51-MO-F011)	○	原子炉隔離時冷却系	原子炉隔離時冷却系弁 (E51-MO-F012)	○	原子炉隔離時冷却系	原子炉隔離時冷却系弁 (E51-MO-F036)	○	原子炉隔離時冷却系	原子炉隔離時冷却系弁 (E51-MO-F037)	○	原子炉隔離時冷却系	原子炉隔離時冷却系弁 (E51-MO-F068)	○	原子炉冷却材浄化系	原子炉冷却材浄化系弁 (G31-MO-F003)	○	燃料プール冷却浄化系	燃料プール冷却浄化系ポンプ (G41-C001A)	○	燃料プール冷却浄化系	燃料プール冷却浄化系ポンプ (G41-C001B)	○	燃料プール冷却浄化系	燃料プール冷却浄化系弁 (G41-F020)	○	燃料プール冷却浄化系	燃料プール冷却浄化系弁 (G41-MO-F005A)	○	燃料プール冷却浄化系	燃料プール冷却浄化系弁 (G41-MO-F012)	○	燃料プール冷却浄化系	燃料プール冷却浄化系弁 (G41-MO-F021A)	○	燃料プール冷却浄化系	燃料プール冷却浄化系弁 (G41-MO-F021B)	○	サブプレッションプール浄化系	サブプレッションプール浄化系ポンプ (G51-C001)	○			
系統	設備	蒸気評価																																																																																																							
高圧炉心注水系	高圧炉心注水系系統流量 (E22-LT010D)	○																																																																																																							
高圧炉心注水系	高圧炉心注水系弁 (E22-MO-F001B)	○																																																																																																							
高圧炉心注水系	高圧炉心注水系弁 (E22-MO-F001C)	○																																																																																																							
高圧炉心注水系	高圧炉心注水系弁 (E22-MO-F003B)	○																																																																																																							
高圧炉心注水系	高圧炉心注水系弁 (E22-MO-F003C)	○																																																																																																							
高圧炉心注水系	高圧炉心注水系弁 (E22-MO-F006B)	○																																																																																																							
高圧炉心注水系	高圧炉心注水系弁 (E22-MO-F006C)	○																																																																																																							
高圧炉心注水系	高圧炉心注水系弁 (E22-MO-F010B)	○																																																																																																							
高圧炉心注水系	高圧炉心注水系弁 (E22-MO-F010C)	○																																																																																																							
原子炉隔離時冷却系	原子炉隔離時冷却系ポンプ (E51-C001)	○																																																																																																							
原子炉隔離時冷却系	原子炉隔離時冷却系蒸気タービン (E51-C002)	○																																																																																																							
原子炉隔離時冷却系	原子炉隔離時冷却系復水ポンプ (E51-C003)	○																																																																																																							
原子炉隔離時冷却系	原子炉隔離時冷却系真空ポンプ (E51-C004)	○																																																																																																							
原子炉隔離時冷却系	原子炉隔離時冷却系主油ポンプ (E51-C005)	○																																																																																																							
原子炉隔離時冷却系	原子炉隔離時冷却系系統流量 (E51-FT007)	○																																																																																																							
原子炉隔離時冷却系	原子炉隔離時冷却系弁 (E51-HO-F069)	○																																																																																																							
原子炉隔離時冷却系	原子炉隔離時冷却系弁 (E51-MO-F001)	○																																																																																																							
原子炉隔離時冷却系	原子炉隔離時冷却系弁 (E51-MO-F004)	○																																																																																																							
原子炉隔離時冷却系	原子炉隔離時冷却系弁 (E51-MO-F006)	○																																																																																																							
原子炉隔離時冷却系	原子炉隔離時冷却系弁 (E51-MO-F011)	○																																																																																																							
原子炉隔離時冷却系	原子炉隔離時冷却系弁 (E51-MO-F012)	○																																																																																																							
原子炉隔離時冷却系	原子炉隔離時冷却系弁 (E51-MO-F036)	○																																																																																																							
原子炉隔離時冷却系	原子炉隔離時冷却系弁 (E51-MO-F037)	○																																																																																																							
原子炉隔離時冷却系	原子炉隔離時冷却系弁 (E51-MO-F068)	○																																																																																																							
原子炉冷却材浄化系	原子炉冷却材浄化系弁 (G31-MO-F003)	○																																																																																																							
燃料プール冷却浄化系	燃料プール冷却浄化系ポンプ (G41-C001A)	○																																																																																																							
燃料プール冷却浄化系	燃料プール冷却浄化系ポンプ (G41-C001B)	○																																																																																																							
燃料プール冷却浄化系	燃料プール冷却浄化系弁 (G41-F020)	○																																																																																																							
燃料プール冷却浄化系	燃料プール冷却浄化系弁 (G41-MO-F005A)	○																																																																																																							
燃料プール冷却浄化系	燃料プール冷却浄化系弁 (G41-MO-F012)	○																																																																																																							
燃料プール冷却浄化系	燃料プール冷却浄化系弁 (G41-MO-F021A)	○																																																																																																							
燃料プール冷却浄化系	燃料プール冷却浄化系弁 (G41-MO-F021B)	○																																																																																																							
サブプレッションプール浄化系	サブプレッションプール浄化系ポンプ (G51-C001)	○																																																																																																							

柏崎刈羽原子力発電所 6 / 7号炉 (2017. 12. 20 版)	東海第二発電所 (2018. 9. 18 版)	島根原子力発電所 2号炉	備考																																																																																																							
添付第 5.3-2 表 6 号炉原子炉二次格納施設内防護対象設備の蒸気影響確認結果																																																																																																										
<table border="1"> <thead> <tr> <th>系統</th> <th>設備</th> <th>蒸気評価</th> </tr> </thead> <tbody> <tr><td>サブプレッションプル浄化系</td><td>サブプレッションプル浄化系弁 (G51-MO-F014)</td><td>○</td></tr> <tr><td>盤類</td><td>格納容器内雰囲気モニタヒータ制御盤 (H21-P334)</td><td>○</td></tr> <tr><td>盤類</td><td>格納容器内雰囲気モニタヒータ制御盤 (H21-P335)</td><td>○</td></tr> <tr><td>盤類</td><td>原子炉系計装ラック (H22-P001)</td><td>○</td></tr> <tr><td>盤類</td><td>原子炉系計装ラック (H22-P002)</td><td>○</td></tr> <tr><td>盤類</td><td>原子炉系計装ラック (H22-P003)</td><td>○</td></tr> <tr><td>盤類</td><td>原子炉系計装ラック (H22-P004)</td><td>○</td></tr> <tr><td>盤類</td><td>格納容器内雰囲気モニタサンプリングラック (H22-P311)</td><td>○</td></tr> <tr><td>盤類</td><td>格納容器内雰囲気モニタサンプリングラック (H22-P312)</td><td>○</td></tr> <tr><td>盤類</td><td>格納容器内雰囲気モニタ校正ラック (H22-P313)</td><td>○</td></tr> <tr><td>盤類</td><td>格納容器内雰囲気モニタ校正ラック (H22-P314)</td><td>○</td></tr> <tr><td>原子炉補機冷却水系</td><td>原子炉補機冷却水系弁 (P21-MO-F013A)</td><td>○</td></tr> <tr><td>原子炉補機冷却水系</td><td>原子炉補機冷却水系弁 (P21-MO-F013B)</td><td>○</td></tr> <tr><td>原子炉補機冷却水系</td><td>原子炉補機冷却水系弁 (P21-MO-F013C)</td><td>○</td></tr> <tr><td>原子炉補機冷却水系</td><td>原子炉補機冷却水系弁 (P21-MO-F055A)</td><td>○</td></tr> <tr><td>原子炉補機冷却水系</td><td>原子炉補機冷却水系弁 (P21-MO-F055B)</td><td>○</td></tr> <tr><td>原子炉補機冷却水系</td><td>原子炉補機冷却水系弁 (P21-MO-F055C)</td><td>○</td></tr> <tr><td>原子炉補機冷却水系</td><td>原子炉補機冷却水系弁 (P21-MO-F055D)</td><td>○</td></tr> <tr><td>原子炉補機冷却水系</td><td>原子炉補機冷却水系弁 (P21-MO-F055E)</td><td>○</td></tr> <tr><td>原子炉補機冷却水系</td><td>原子炉補機冷却水系弁 (P21-MO-F055F)</td><td>○</td></tr> <tr><td>原子炉補機冷却水系</td><td>原子炉補機冷却水系弁 (P21-MO-F074A)</td><td>○</td></tr> <tr><td>原子炉補機冷却水系</td><td>原子炉補機冷却水系弁 (P21-MO-F074B)</td><td>○</td></tr> <tr><td>原子炉補機冷却水系</td><td>原子炉補機冷却水系弁 (P21-MO-F074C)</td><td>○</td></tr> <tr><td>原子炉補機冷却水系</td><td>原子炉補機冷却水系弁 (P21-MO-F082A)</td><td>○</td></tr> <tr><td>原子炉補機冷却水系</td><td>原子炉補機冷却水系弁 (P21-MO-F082B)</td><td>○</td></tr> <tr><td>原子炉補機冷却水系</td><td>原子炉補機冷却水系弁 (P21-MO-F082C)</td><td>○</td></tr> <tr><td>高圧窒素ガス供給系</td><td>高圧窒素ガス供給系弁 (P54-MO-F018A)</td><td>○</td></tr> <tr><td>高圧窒素ガス供給系</td><td>高圧窒素ガス供給系弁 (P54-MO-F018B)</td><td>○</td></tr> <tr><td>高圧窒素ガス供給系</td><td>高圧窒素ガス供給系弁 (P54-MO-F027A)</td><td>○</td></tr> <tr><td>高圧窒素ガス供給系</td><td>高圧窒素ガス供給系弁 (P54-MO-F027B)</td><td>○</td></tr> <tr><td>非常用ガス処理系</td><td>非常用ガス処理系弁 (T22-AO-F001A)</td><td>○</td></tr> <tr><td>非常用ガス処理系</td><td>非常用ガス処理系弁 (T22-AO-F001B)</td><td>○</td></tr> <tr><td>非常用ガス処理系</td><td>非常用ガス処理系排風機 (T22-C001A)</td><td>○</td></tr> </tbody> </table>	系統	設備	蒸気評価	サブプレッションプル浄化系	サブプレッションプル浄化系弁 (G51-MO-F014)	○	盤類	格納容器内雰囲気モニタヒータ制御盤 (H21-P334)	○	盤類	格納容器内雰囲気モニタヒータ制御盤 (H21-P335)	○	盤類	原子炉系計装ラック (H22-P001)	○	盤類	原子炉系計装ラック (H22-P002)	○	盤類	原子炉系計装ラック (H22-P003)	○	盤類	原子炉系計装ラック (H22-P004)	○	盤類	格納容器内雰囲気モニタサンプリングラック (H22-P311)	○	盤類	格納容器内雰囲気モニタサンプリングラック (H22-P312)	○	盤類	格納容器内雰囲気モニタ校正ラック (H22-P313)	○	盤類	格納容器内雰囲気モニタ校正ラック (H22-P314)	○	原子炉補機冷却水系	原子炉補機冷却水系弁 (P21-MO-F013A)	○	原子炉補機冷却水系	原子炉補機冷却水系弁 (P21-MO-F013B)	○	原子炉補機冷却水系	原子炉補機冷却水系弁 (P21-MO-F013C)	○	原子炉補機冷却水系	原子炉補機冷却水系弁 (P21-MO-F055A)	○	原子炉補機冷却水系	原子炉補機冷却水系弁 (P21-MO-F055B)	○	原子炉補機冷却水系	原子炉補機冷却水系弁 (P21-MO-F055C)	○	原子炉補機冷却水系	原子炉補機冷却水系弁 (P21-MO-F055D)	○	原子炉補機冷却水系	原子炉補機冷却水系弁 (P21-MO-F055E)	○	原子炉補機冷却水系	原子炉補機冷却水系弁 (P21-MO-F055F)	○	原子炉補機冷却水系	原子炉補機冷却水系弁 (P21-MO-F074A)	○	原子炉補機冷却水系	原子炉補機冷却水系弁 (P21-MO-F074B)	○	原子炉補機冷却水系	原子炉補機冷却水系弁 (P21-MO-F074C)	○	原子炉補機冷却水系	原子炉補機冷却水系弁 (P21-MO-F082A)	○	原子炉補機冷却水系	原子炉補機冷却水系弁 (P21-MO-F082B)	○	原子炉補機冷却水系	原子炉補機冷却水系弁 (P21-MO-F082C)	○	高圧窒素ガス供給系	高圧窒素ガス供給系弁 (P54-MO-F018A)	○	高圧窒素ガス供給系	高圧窒素ガス供給系弁 (P54-MO-F018B)	○	高圧窒素ガス供給系	高圧窒素ガス供給系弁 (P54-MO-F027A)	○	高圧窒素ガス供給系	高圧窒素ガス供給系弁 (P54-MO-F027B)	○	非常用ガス処理系	非常用ガス処理系弁 (T22-AO-F001A)	○	非常用ガス処理系	非常用ガス処理系弁 (T22-AO-F001B)	○	非常用ガス処理系	非常用ガス処理系排風機 (T22-C001A)	○				
系統	設備	蒸気評価																																																																																																								
サブプレッションプル浄化系	サブプレッションプル浄化系弁 (G51-MO-F014)	○																																																																																																								
盤類	格納容器内雰囲気モニタヒータ制御盤 (H21-P334)	○																																																																																																								
盤類	格納容器内雰囲気モニタヒータ制御盤 (H21-P335)	○																																																																																																								
盤類	原子炉系計装ラック (H22-P001)	○																																																																																																								
盤類	原子炉系計装ラック (H22-P002)	○																																																																																																								
盤類	原子炉系計装ラック (H22-P003)	○																																																																																																								
盤類	原子炉系計装ラック (H22-P004)	○																																																																																																								
盤類	格納容器内雰囲気モニタサンプリングラック (H22-P311)	○																																																																																																								
盤類	格納容器内雰囲気モニタサンプリングラック (H22-P312)	○																																																																																																								
盤類	格納容器内雰囲気モニタ校正ラック (H22-P313)	○																																																																																																								
盤類	格納容器内雰囲気モニタ校正ラック (H22-P314)	○																																																																																																								
原子炉補機冷却水系	原子炉補機冷却水系弁 (P21-MO-F013A)	○																																																																																																								
原子炉補機冷却水系	原子炉補機冷却水系弁 (P21-MO-F013B)	○																																																																																																								
原子炉補機冷却水系	原子炉補機冷却水系弁 (P21-MO-F013C)	○																																																																																																								
原子炉補機冷却水系	原子炉補機冷却水系弁 (P21-MO-F055A)	○																																																																																																								
原子炉補機冷却水系	原子炉補機冷却水系弁 (P21-MO-F055B)	○																																																																																																								
原子炉補機冷却水系	原子炉補機冷却水系弁 (P21-MO-F055C)	○																																																																																																								
原子炉補機冷却水系	原子炉補機冷却水系弁 (P21-MO-F055D)	○																																																																																																								
原子炉補機冷却水系	原子炉補機冷却水系弁 (P21-MO-F055E)	○																																																																																																								
原子炉補機冷却水系	原子炉補機冷却水系弁 (P21-MO-F055F)	○																																																																																																								
原子炉補機冷却水系	原子炉補機冷却水系弁 (P21-MO-F074A)	○																																																																																																								
原子炉補機冷却水系	原子炉補機冷却水系弁 (P21-MO-F074B)	○																																																																																																								
原子炉補機冷却水系	原子炉補機冷却水系弁 (P21-MO-F074C)	○																																																																																																								
原子炉補機冷却水系	原子炉補機冷却水系弁 (P21-MO-F082A)	○																																																																																																								
原子炉補機冷却水系	原子炉補機冷却水系弁 (P21-MO-F082B)	○																																																																																																								
原子炉補機冷却水系	原子炉補機冷却水系弁 (P21-MO-F082C)	○																																																																																																								
高圧窒素ガス供給系	高圧窒素ガス供給系弁 (P54-MO-F018A)	○																																																																																																								
高圧窒素ガス供給系	高圧窒素ガス供給系弁 (P54-MO-F018B)	○																																																																																																								
高圧窒素ガス供給系	高圧窒素ガス供給系弁 (P54-MO-F027A)	○																																																																																																								
高圧窒素ガス供給系	高圧窒素ガス供給系弁 (P54-MO-F027B)	○																																																																																																								
非常用ガス処理系	非常用ガス処理系弁 (T22-AO-F001A)	○																																																																																																								
非常用ガス処理系	非常用ガス処理系弁 (T22-AO-F001B)	○																																																																																																								
非常用ガス処理系	非常用ガス処理系排風機 (T22-C001A)	○																																																																																																								

柏崎刈羽原子力発電所 6 / 7号炉 (2017. 12. 20 版)	東海第二発電所 (2018. 9. 18 版)	島根原子力発電所 2号炉	備考																																																																																																						
添付第 5.3-2 表 6号炉原子炉二次格納施設内防護対象設備の蒸気影響確認結果																																																																																																									
<table border="1"> <thead> <tr> <th>系統</th> <th>設備</th> <th>蒸気評価</th> </tr> </thead> <tbody> <tr><td>非常用ガス処理系</td><td>非常用ガス処理系排風機 (T22-C001B)</td><td>○</td></tr> <tr><td>非常用ガス処理系</td><td>非常用ガス処理系乾燥装置 (T22-D001A)</td><td>○</td></tr> <tr><td>非常用ガス処理系</td><td>非常用ガス処理系乾燥装置 (T22-D001B)</td><td>○</td></tr> <tr><td>非常用ガス処理系</td><td>非常用ガス処理系フィルタ装置 (T22-D002)</td><td>*B.1</td></tr> <tr><td>非常用ガス処理系</td><td>非常用ガス処理系弁 (T22-MO-F002A)</td><td>○</td></tr> <tr><td>非常用ガス処理系</td><td>非常用ガス処理系弁 (T22-MO-F002B)</td><td>○</td></tr> <tr><td>非常用ガス処理系</td><td>非常用ガス処理系弁 (T22-MO-F004A)</td><td>○</td></tr> <tr><td>非常用ガス処理系</td><td>非常用ガス処理系弁 (T22-MO-F004B)</td><td>○</td></tr> <tr><td>不活性ガス系</td><td>サブプレッションプール水位 (T31-LT020)</td><td>○</td></tr> <tr><td>不活性ガス系</td><td>サブプレッションプール水位 (T31-LT021)</td><td>○</td></tr> <tr><td>不活性ガス系</td><td>原子炉格納容器圧力 (T31-PT015)</td><td>○</td></tr> <tr><td>不活性ガス系</td><td>原子炉格納容器圧力 (T31-PT016)</td><td>○</td></tr> <tr><td>不活性ガス系</td><td>原子炉格納容器圧力 (T31-PT017)</td><td>○</td></tr> <tr><td>不活性ガス系</td><td>不活性ガス系弁 (T31-SO-F712)</td><td>○</td></tr> <tr><td>不活性ガス系</td><td>不活性ガス系弁 (T31-SO-F714)</td><td>○</td></tr> <tr><td>不活性ガス系</td><td>不活性ガス系弁 (T31-SO-F733)</td><td>○</td></tr> <tr><td>不活性ガス系</td><td>不活性ガス系弁 (T31-SO-F735)</td><td>○</td></tr> <tr><td>不活性ガス系</td><td>不活性ガス系弁 (T31-SO-F736)</td><td>○</td></tr> <tr><td>不活性ガス系</td><td>不活性ガス系弁 (T31-SO-F738)</td><td>○</td></tr> <tr><td>不活性ガス系</td><td>不活性ガス系弁 (T31-SO-F741)</td><td>○</td></tr> <tr><td>不活性ガス系</td><td>不活性ガス系弁 (T31-SO-F743)</td><td>○</td></tr> <tr><td>不活性ガス系</td><td>不活性ガス系弁 (T31-SO-F744)</td><td>○</td></tr> <tr><td>不活性ガス系</td><td>不活性ガス系弁 (T31-SO-F746)</td><td>○</td></tr> <tr><td>不活性ガス系</td><td>不活性ガス系弁 (T31-SO-F748)</td><td>○</td></tr> <tr><td>不活性ガス系</td><td>不活性ガス系弁 (T31-SO-F750)</td><td>○</td></tr> <tr><td>可燃性ガス濃度制御系</td><td>可燃性ガス濃度制御系可搬式再結合装置再結合器 (T49-A001A)</td><td>○</td></tr> <tr><td>可燃性ガス濃度制御系</td><td>可燃性ガス濃度制御系可搬式再結合装置再結合器 (T49-A001B)</td><td>○</td></tr> <tr><td>可燃性ガス濃度制御系</td><td>可燃性ガス濃度制御系可搬式再結合装置加熱器/冷却器 (T49-B001A)</td><td>○</td></tr> <tr><td>可燃性ガス濃度制御系</td><td>可燃性ガス濃度制御系可搬式再結合装置加熱器/冷却器 (T49-B001B)</td><td>○</td></tr> <tr><td>可燃性ガス濃度制御系</td><td>可燃性ガス濃度制御系可搬式再結合装置ブロワ (T49-C001A)</td><td>○</td></tr> <tr><td>可燃性ガス濃度制御系</td><td>可燃性ガス濃度制御系可搬式再結合装置ブロワ (T49-C001B)</td><td>○</td></tr> <tr><td>可燃性ガス濃度制御系</td><td>可燃性ガス濃度制御系可搬式再結合装置気水分離器 (T49-D001A)</td><td>○</td></tr> <tr><td>可燃性ガス濃度制御系</td><td>可燃性ガス濃度制御系可搬式再結合装置気水分離器 (T49-D001B)</td><td>○</td></tr> </tbody> </table>	系統	設備	蒸気評価	非常用ガス処理系	非常用ガス処理系排風機 (T22-C001B)	○	非常用ガス処理系	非常用ガス処理系乾燥装置 (T22-D001A)	○	非常用ガス処理系	非常用ガス処理系乾燥装置 (T22-D001B)	○	非常用ガス処理系	非常用ガス処理系フィルタ装置 (T22-D002)	*B.1	非常用ガス処理系	非常用ガス処理系弁 (T22-MO-F002A)	○	非常用ガス処理系	非常用ガス処理系弁 (T22-MO-F002B)	○	非常用ガス処理系	非常用ガス処理系弁 (T22-MO-F004A)	○	非常用ガス処理系	非常用ガス処理系弁 (T22-MO-F004B)	○	不活性ガス系	サブプレッションプール水位 (T31-LT020)	○	不活性ガス系	サブプレッションプール水位 (T31-LT021)	○	不活性ガス系	原子炉格納容器圧力 (T31-PT015)	○	不活性ガス系	原子炉格納容器圧力 (T31-PT016)	○	不活性ガス系	原子炉格納容器圧力 (T31-PT017)	○	不活性ガス系	不活性ガス系弁 (T31-SO-F712)	○	不活性ガス系	不活性ガス系弁 (T31-SO-F714)	○	不活性ガス系	不活性ガス系弁 (T31-SO-F733)	○	不活性ガス系	不活性ガス系弁 (T31-SO-F735)	○	不活性ガス系	不活性ガス系弁 (T31-SO-F736)	○	不活性ガス系	不活性ガス系弁 (T31-SO-F738)	○	不活性ガス系	不活性ガス系弁 (T31-SO-F741)	○	不活性ガス系	不活性ガス系弁 (T31-SO-F743)	○	不活性ガス系	不活性ガス系弁 (T31-SO-F744)	○	不活性ガス系	不活性ガス系弁 (T31-SO-F746)	○	不活性ガス系	不活性ガス系弁 (T31-SO-F748)	○	不活性ガス系	不活性ガス系弁 (T31-SO-F750)	○	可燃性ガス濃度制御系	可燃性ガス濃度制御系可搬式再結合装置再結合器 (T49-A001A)	○	可燃性ガス濃度制御系	可燃性ガス濃度制御系可搬式再結合装置再結合器 (T49-A001B)	○	可燃性ガス濃度制御系	可燃性ガス濃度制御系可搬式再結合装置加熱器/冷却器 (T49-B001A)	○	可燃性ガス濃度制御系	可燃性ガス濃度制御系可搬式再結合装置加熱器/冷却器 (T49-B001B)	○	可燃性ガス濃度制御系	可燃性ガス濃度制御系可搬式再結合装置ブロワ (T49-C001A)	○	可燃性ガス濃度制御系	可燃性ガス濃度制御系可搬式再結合装置ブロワ (T49-C001B)	○	可燃性ガス濃度制御系	可燃性ガス濃度制御系可搬式再結合装置気水分離器 (T49-D001A)	○	可燃性ガス濃度制御系	可燃性ガス濃度制御系可搬式再結合装置気水分離器 (T49-D001B)	○			
系統	設備	蒸気評価																																																																																																							
非常用ガス処理系	非常用ガス処理系排風機 (T22-C001B)	○																																																																																																							
非常用ガス処理系	非常用ガス処理系乾燥装置 (T22-D001A)	○																																																																																																							
非常用ガス処理系	非常用ガス処理系乾燥装置 (T22-D001B)	○																																																																																																							
非常用ガス処理系	非常用ガス処理系フィルタ装置 (T22-D002)	*B.1																																																																																																							
非常用ガス処理系	非常用ガス処理系弁 (T22-MO-F002A)	○																																																																																																							
非常用ガス処理系	非常用ガス処理系弁 (T22-MO-F002B)	○																																																																																																							
非常用ガス処理系	非常用ガス処理系弁 (T22-MO-F004A)	○																																																																																																							
非常用ガス処理系	非常用ガス処理系弁 (T22-MO-F004B)	○																																																																																																							
不活性ガス系	サブプレッションプール水位 (T31-LT020)	○																																																																																																							
不活性ガス系	サブプレッションプール水位 (T31-LT021)	○																																																																																																							
不活性ガス系	原子炉格納容器圧力 (T31-PT015)	○																																																																																																							
不活性ガス系	原子炉格納容器圧力 (T31-PT016)	○																																																																																																							
不活性ガス系	原子炉格納容器圧力 (T31-PT017)	○																																																																																																							
不活性ガス系	不活性ガス系弁 (T31-SO-F712)	○																																																																																																							
不活性ガス系	不活性ガス系弁 (T31-SO-F714)	○																																																																																																							
不活性ガス系	不活性ガス系弁 (T31-SO-F733)	○																																																																																																							
不活性ガス系	不活性ガス系弁 (T31-SO-F735)	○																																																																																																							
不活性ガス系	不活性ガス系弁 (T31-SO-F736)	○																																																																																																							
不活性ガス系	不活性ガス系弁 (T31-SO-F738)	○																																																																																																							
不活性ガス系	不活性ガス系弁 (T31-SO-F741)	○																																																																																																							
不活性ガス系	不活性ガス系弁 (T31-SO-F743)	○																																																																																																							
不活性ガス系	不活性ガス系弁 (T31-SO-F744)	○																																																																																																							
不活性ガス系	不活性ガス系弁 (T31-SO-F746)	○																																																																																																							
不活性ガス系	不活性ガス系弁 (T31-SO-F748)	○																																																																																																							
不活性ガス系	不活性ガス系弁 (T31-SO-F750)	○																																																																																																							
可燃性ガス濃度制御系	可燃性ガス濃度制御系可搬式再結合装置再結合器 (T49-A001A)	○																																																																																																							
可燃性ガス濃度制御系	可燃性ガス濃度制御系可搬式再結合装置再結合器 (T49-A001B)	○																																																																																																							
可燃性ガス濃度制御系	可燃性ガス濃度制御系可搬式再結合装置加熱器/冷却器 (T49-B001A)	○																																																																																																							
可燃性ガス濃度制御系	可燃性ガス濃度制御系可搬式再結合装置加熱器/冷却器 (T49-B001B)	○																																																																																																							
可燃性ガス濃度制御系	可燃性ガス濃度制御系可搬式再結合装置ブロワ (T49-C001A)	○																																																																																																							
可燃性ガス濃度制御系	可燃性ガス濃度制御系可搬式再結合装置ブロワ (T49-C001B)	○																																																																																																							
可燃性ガス濃度制御系	可燃性ガス濃度制御系可搬式再結合装置気水分離器 (T49-D001A)	○																																																																																																							
可燃性ガス濃度制御系	可燃性ガス濃度制御系可搬式再結合装置気水分離器 (T49-D001B)	○																																																																																																							

柏崎刈羽原子力発電所 6 / 7号炉 (2017. 12. 20 版)	東海第二発電所 (2018. 9. 18 版)	島根原子力発電所 2号炉	備考																																																																																																
添付第 5.3-2 表 6 号炉原子炉二次格納施設内防護対象設備の蒸気影響確認結果																																																																																																			
<table border="1"> <thead> <tr> <th>系統</th> <th>設備</th> <th>蒸気評価</th> </tr> </thead> <tbody> <tr><td>可燃性ガス濃度制御系</td><td>可燃性ガス濃度制御系 (T49-MO-F001A)</td><td>○</td></tr> <tr><td>可燃性ガス濃度制御系</td><td>可燃性ガス濃度制御系 (T49-MO-F001B)</td><td>○</td></tr> <tr><td>可燃性ガス濃度制御系</td><td>可燃性ガス濃度制御系 (T49-MO-F002A)</td><td>○</td></tr> <tr><td>可燃性ガス濃度制御系</td><td>可燃性ガス濃度制御系 (T49-MO-F002B)</td><td>○</td></tr> <tr><td>可燃性ガス濃度制御系</td><td>可燃性ガス濃度制御系 (T49-MO-F003A)</td><td>○</td></tr> <tr><td>可燃性ガス濃度制御系</td><td>可燃性ガス濃度制御系 (T49-MO-F003B)</td><td>○</td></tr> <tr><td>可燃性ガス濃度制御系</td><td>可燃性ガス濃度制御系 (T49-MO-F004A)</td><td>○</td></tr> <tr><td>可燃性ガス濃度制御系</td><td>可燃性ガス濃度制御系 (T49-MO-F004B)</td><td>○</td></tr> <tr><td>可燃性ガス濃度制御系</td><td>可燃性ガス濃度制御系 (T49-MO-F006A)</td><td>○</td></tr> <tr><td>可燃性ガス濃度制御系</td><td>可燃性ガス濃度制御系 (T49-MO-F006B)</td><td>○</td></tr> <tr><td>可燃性ガス濃度制御系</td><td>可燃性ガス濃度制御系 (T49-MO-F007A)</td><td>○</td></tr> <tr><td>可燃性ガス濃度制御系</td><td>可燃性ガス濃度制御系 (T49-MO-F007B)</td><td>○</td></tr> <tr><td>可燃性ガス濃度制御系</td><td>可燃性ガス濃度制御系 (T49-MO-F008A)</td><td>○</td></tr> <tr><td>可燃性ガス濃度制御系</td><td>可燃性ガス濃度制御系 (T49-MO-F008B)</td><td>○</td></tr> <tr><td>可燃性ガス濃度制御系</td><td>可燃性ガス濃度制御系 (T49-MO-F010A)</td><td>○</td></tr> <tr><td>可燃性ガス濃度制御系</td><td>可燃性ガス濃度制御系 (T49-MO-F010B)</td><td>○</td></tr> <tr><td>換気空調系</td><td>原子炉隔離時冷却系ポンプ室空調機 (U41-D101)</td><td>○</td></tr> <tr><td>換気空調系</td><td>高圧炉心注水系ポンプ室空調機 (U41-D102)</td><td>○</td></tr> <tr><td>換気空調系</td><td>残留熱除去系ポンプ室空調機 (U41-D103)</td><td>○</td></tr> <tr><td>換気空調系</td><td>残留熱除去系ポンプ室空調機 (U41-D104)</td><td>○</td></tr> <tr><td>換気空調系</td><td>残留熱除去系ポンプ室空調機 (U41-D105)</td><td>○</td></tr> <tr><td>換気空調系</td><td>高圧炉心注水系ポンプ室空調機 (U41-D106)</td><td>○</td></tr> <tr><td>換気空調系</td><td>可燃性ガス濃度制御系設備室空調機 (U41-D107A)</td><td>○</td></tr> <tr><td>換気空調系</td><td>可燃性ガス濃度制御系設備室空調機 (U41-D107B)</td><td>○</td></tr> <tr><td>換気空調系</td><td>燃料プール冷却浄化系ポンプ室空調機 (U41-D109A)</td><td>○</td></tr> <tr><td>換気空調系</td><td>燃料プール冷却浄化系ポンプ室空調機 (U41-D109B)</td><td>○</td></tr> <tr><td>換気空調系</td><td>非常用ガス処理系設備室空調機 (U41-D111A)</td><td>○</td></tr> <tr><td>換気空調系</td><td>非常用ガス処理系設備室空調機 (U41-D111B)</td><td>○</td></tr> <tr><td>換気空調系</td><td>格納容器内雰囲気モニタ系設備室空調機 (U41-D113)</td><td>○</td></tr> <tr><td>換気空調系</td><td>格納容器内雰囲気モニタ系設備室空調機 (U41-D114)</td><td>○</td></tr> <tr><td>換気空調系</td><td>サブプレッションプール浄化系ポンプ室空調機 (U41-D116)</td><td>○</td></tr> </tbody> </table>	系統	設備	蒸気評価	可燃性ガス濃度制御系	可燃性ガス濃度制御系 (T49-MO-F001A)	○	可燃性ガス濃度制御系	可燃性ガス濃度制御系 (T49-MO-F001B)	○	可燃性ガス濃度制御系	可燃性ガス濃度制御系 (T49-MO-F002A)	○	可燃性ガス濃度制御系	可燃性ガス濃度制御系 (T49-MO-F002B)	○	可燃性ガス濃度制御系	可燃性ガス濃度制御系 (T49-MO-F003A)	○	可燃性ガス濃度制御系	可燃性ガス濃度制御系 (T49-MO-F003B)	○	可燃性ガス濃度制御系	可燃性ガス濃度制御系 (T49-MO-F004A)	○	可燃性ガス濃度制御系	可燃性ガス濃度制御系 (T49-MO-F004B)	○	可燃性ガス濃度制御系	可燃性ガス濃度制御系 (T49-MO-F006A)	○	可燃性ガス濃度制御系	可燃性ガス濃度制御系 (T49-MO-F006B)	○	可燃性ガス濃度制御系	可燃性ガス濃度制御系 (T49-MO-F007A)	○	可燃性ガス濃度制御系	可燃性ガス濃度制御系 (T49-MO-F007B)	○	可燃性ガス濃度制御系	可燃性ガス濃度制御系 (T49-MO-F008A)	○	可燃性ガス濃度制御系	可燃性ガス濃度制御系 (T49-MO-F008B)	○	可燃性ガス濃度制御系	可燃性ガス濃度制御系 (T49-MO-F010A)	○	可燃性ガス濃度制御系	可燃性ガス濃度制御系 (T49-MO-F010B)	○	換気空調系	原子炉隔離時冷却系ポンプ室空調機 (U41-D101)	○	換気空調系	高圧炉心注水系ポンプ室空調機 (U41-D102)	○	換気空調系	残留熱除去系ポンプ室空調機 (U41-D103)	○	換気空調系	残留熱除去系ポンプ室空調機 (U41-D104)	○	換気空調系	残留熱除去系ポンプ室空調機 (U41-D105)	○	換気空調系	高圧炉心注水系ポンプ室空調機 (U41-D106)	○	換気空調系	可燃性ガス濃度制御系設備室空調機 (U41-D107A)	○	換気空調系	可燃性ガス濃度制御系設備室空調機 (U41-D107B)	○	換気空調系	燃料プール冷却浄化系ポンプ室空調機 (U41-D109A)	○	換気空調系	燃料プール冷却浄化系ポンプ室空調機 (U41-D109B)	○	換気空調系	非常用ガス処理系設備室空調機 (U41-D111A)	○	換気空調系	非常用ガス処理系設備室空調機 (U41-D111B)	○	換気空調系	格納容器内雰囲気モニタ系設備室空調機 (U41-D113)	○	換気空調系	格納容器内雰囲気モニタ系設備室空調機 (U41-D114)	○	換気空調系	サブプレッションプール浄化系ポンプ室空調機 (U41-D116)	○			
系統	設備	蒸気評価																																																																																																	
可燃性ガス濃度制御系	可燃性ガス濃度制御系 (T49-MO-F001A)	○																																																																																																	
可燃性ガス濃度制御系	可燃性ガス濃度制御系 (T49-MO-F001B)	○																																																																																																	
可燃性ガス濃度制御系	可燃性ガス濃度制御系 (T49-MO-F002A)	○																																																																																																	
可燃性ガス濃度制御系	可燃性ガス濃度制御系 (T49-MO-F002B)	○																																																																																																	
可燃性ガス濃度制御系	可燃性ガス濃度制御系 (T49-MO-F003A)	○																																																																																																	
可燃性ガス濃度制御系	可燃性ガス濃度制御系 (T49-MO-F003B)	○																																																																																																	
可燃性ガス濃度制御系	可燃性ガス濃度制御系 (T49-MO-F004A)	○																																																																																																	
可燃性ガス濃度制御系	可燃性ガス濃度制御系 (T49-MO-F004B)	○																																																																																																	
可燃性ガス濃度制御系	可燃性ガス濃度制御系 (T49-MO-F006A)	○																																																																																																	
可燃性ガス濃度制御系	可燃性ガス濃度制御系 (T49-MO-F006B)	○																																																																																																	
可燃性ガス濃度制御系	可燃性ガス濃度制御系 (T49-MO-F007A)	○																																																																																																	
可燃性ガス濃度制御系	可燃性ガス濃度制御系 (T49-MO-F007B)	○																																																																																																	
可燃性ガス濃度制御系	可燃性ガス濃度制御系 (T49-MO-F008A)	○																																																																																																	
可燃性ガス濃度制御系	可燃性ガス濃度制御系 (T49-MO-F008B)	○																																																																																																	
可燃性ガス濃度制御系	可燃性ガス濃度制御系 (T49-MO-F010A)	○																																																																																																	
可燃性ガス濃度制御系	可燃性ガス濃度制御系 (T49-MO-F010B)	○																																																																																																	
換気空調系	原子炉隔離時冷却系ポンプ室空調機 (U41-D101)	○																																																																																																	
換気空調系	高圧炉心注水系ポンプ室空調機 (U41-D102)	○																																																																																																	
換気空調系	残留熱除去系ポンプ室空調機 (U41-D103)	○																																																																																																	
換気空調系	残留熱除去系ポンプ室空調機 (U41-D104)	○																																																																																																	
換気空調系	残留熱除去系ポンプ室空調機 (U41-D105)	○																																																																																																	
換気空調系	高圧炉心注水系ポンプ室空調機 (U41-D106)	○																																																																																																	
換気空調系	可燃性ガス濃度制御系設備室空調機 (U41-D107A)	○																																																																																																	
換気空調系	可燃性ガス濃度制御系設備室空調機 (U41-D107B)	○																																																																																																	
換気空調系	燃料プール冷却浄化系ポンプ室空調機 (U41-D109A)	○																																																																																																	
換気空調系	燃料プール冷却浄化系ポンプ室空調機 (U41-D109B)	○																																																																																																	
換気空調系	非常用ガス処理系設備室空調機 (U41-D111A)	○																																																																																																	
換気空調系	非常用ガス処理系設備室空調機 (U41-D111B)	○																																																																																																	
換気空調系	格納容器内雰囲気モニタ系設備室空調機 (U41-D113)	○																																																																																																	
換気空調系	格納容器内雰囲気モニタ系設備室空調機 (U41-D114)	○																																																																																																	
換気空調系	サブプレッションプール浄化系ポンプ室空調機 (U41-D116)	○																																																																																																	
<p>注 1 : 蒸気漏洩時に監視および動作が必要な機器ではなく、蒸気漏洩によって機能喪失しても安全機能に影響はない。</p>																																																																																																			

柏崎刈羽原子力発電所 6 / 7号炉 (2017. 12. 20 版)	東海第二発電所 (2018. 9. 18 版)	島根原子力発電所 2号炉	備考																																																																																																				
添付第 5.3-3 表 7号炉原子炉二次格納施設内防護対象設備の蒸気影響確認結果																																																																																																							
<table border="1"> <thead> <tr> <th>系統</th> <th>設備</th> <th>蒸気評価</th> </tr> </thead> <tbody> <tr><td>原子炉系</td><td>原子炉水位 (B21-LT-003A)</td><td>○</td></tr> <tr><td>原子炉系</td><td>原子炉水位 (B21-LT-003B)</td><td>○</td></tr> <tr><td>原子炉系</td><td>原子炉水位 (B21-LT-003C)</td><td>○</td></tr> <tr><td>原子炉系</td><td>原子炉水位 (B21-LT-003D)</td><td>○</td></tr> <tr><td>原子炉系</td><td>原子炉水位 (B21-LT-003E)</td><td>○</td></tr> <tr><td>原子炉系</td><td>原子炉水位 (B21-LT-003F)</td><td>○</td></tr> <tr><td>原子炉系</td><td>原子炉水位 (B21-LT-003G)</td><td>○</td></tr> <tr><td>原子炉系</td><td>原子炉水位 (B21-LT-003H)</td><td>○</td></tr> <tr><td>原子炉系</td><td>原子炉水位 (B21-LT-006A)</td><td>○</td></tr> <tr><td>原子炉系</td><td>原子炉水位 (B21-LT-006B)</td><td>○</td></tr> <tr><td>原子炉系</td><td>原子炉圧力 (B21-PT-007A)</td><td>○</td></tr> <tr><td>原子炉系</td><td>原子炉圧力 (B21-PT-007B)</td><td>○</td></tr> <tr><td>原子炉系</td><td>原子炉圧力 (B21-PT-007C)</td><td>○</td></tr> <tr><td>原子炉系</td><td>原子炉圧力 (B21-PT-007D)</td><td>○</td></tr> <tr><td>制御棒駆動系</td><td>水圧制御ユニット (C12-D004) (北側)</td><td>○</td></tr> <tr><td>制御棒駆動系</td><td>水圧制御ユニット (C12-D004) (南側)</td><td>○</td></tr> <tr><td>ほう酸水注入系</td><td>ほう酸水注入系ポンプ (C41-C001A)</td><td>*注1</td></tr> <tr><td>ほう酸水注入系</td><td>ほう酸水注入系ポンプ (C41-C001B)</td><td>*注1</td></tr> <tr><td>ほう酸水注入系</td><td>ほう酸水注入系ポンプ用潤滑油ポンプ (C41-C002A)</td><td>*注1</td></tr> <tr><td>ほう酸水注入系</td><td>ほう酸水注入系ポンプ用潤滑油ポンプ (C41-C002B)</td><td>*注1</td></tr> <tr><td>ほう酸水注入系</td><td>ほう酸水注入系弁 (C41-MO-F001A)</td><td>○</td></tr> <tr><td>ほう酸水注入系</td><td>ほう酸水注入系弁 (C41-MO-F001B)</td><td>○</td></tr> <tr><td>ほう酸水注入系</td><td>ほう酸水注入系弁 (C41-MO-F006A)</td><td>○</td></tr> <tr><td>ほう酸水注入系</td><td>ほう酸水注入系弁 (C41-MO-F006B)</td><td>○</td></tr> <tr><td>格納容器内雰囲気モニタ系</td><td>原子炉格納容器水素濃度 (D23-H2E-001A)</td><td>○</td></tr> <tr><td>格納容器内雰囲気モニタ系</td><td>原子炉格納容器水素濃度 (D23-H2E-001B)</td><td>○</td></tr> <tr><td>格納容器内雰囲気モニタ系</td><td>格納容器内雰囲気モニタ系弁 (D23-MO-F004A)</td><td>○</td></tr> <tr><td>格納容器内雰囲気モニタ系</td><td>格納容器内雰囲気モニタ系弁 (D23-MO-F004B)</td><td>○</td></tr> <tr><td>格納容器内雰囲気モニタ系</td><td>格納容器内雰囲気モニタ系弁 (D23-MO-F005A)</td><td>○</td></tr> <tr><td>格納容器内雰囲気モニタ系</td><td>格納容器内雰囲気モニタ系弁 (D23-MO-F005B)</td><td>○</td></tr> <tr><td>格納容器内雰囲気モニタ系</td><td>格納容器内雰囲気モニタ系弁 (D23-MO-F006A)</td><td>○</td></tr> <tr><td>格納容器内雰囲気モニタ系</td><td>格納容器内雰囲気モニタ系弁 (D23-MO-F006B)</td><td>○</td></tr> </tbody> </table>	系統	設備	蒸気評価	原子炉系	原子炉水位 (B21-LT-003A)	○	原子炉系	原子炉水位 (B21-LT-003B)	○	原子炉系	原子炉水位 (B21-LT-003C)	○	原子炉系	原子炉水位 (B21-LT-003D)	○	原子炉系	原子炉水位 (B21-LT-003E)	○	原子炉系	原子炉水位 (B21-LT-003F)	○	原子炉系	原子炉水位 (B21-LT-003G)	○	原子炉系	原子炉水位 (B21-LT-003H)	○	原子炉系	原子炉水位 (B21-LT-006A)	○	原子炉系	原子炉水位 (B21-LT-006B)	○	原子炉系	原子炉圧力 (B21-PT-007A)	○	原子炉系	原子炉圧力 (B21-PT-007B)	○	原子炉系	原子炉圧力 (B21-PT-007C)	○	原子炉系	原子炉圧力 (B21-PT-007D)	○	制御棒駆動系	水圧制御ユニット (C12-D004) (北側)	○	制御棒駆動系	水圧制御ユニット (C12-D004) (南側)	○	ほう酸水注入系	ほう酸水注入系ポンプ (C41-C001A)	*注1	ほう酸水注入系	ほう酸水注入系ポンプ (C41-C001B)	*注1	ほう酸水注入系	ほう酸水注入系ポンプ用潤滑油ポンプ (C41-C002A)	*注1	ほう酸水注入系	ほう酸水注入系ポンプ用潤滑油ポンプ (C41-C002B)	*注1	ほう酸水注入系	ほう酸水注入系弁 (C41-MO-F001A)	○	ほう酸水注入系	ほう酸水注入系弁 (C41-MO-F001B)	○	ほう酸水注入系	ほう酸水注入系弁 (C41-MO-F006A)	○	ほう酸水注入系	ほう酸水注入系弁 (C41-MO-F006B)	○	格納容器内雰囲気モニタ系	原子炉格納容器水素濃度 (D23-H2E-001A)	○	格納容器内雰囲気モニタ系	原子炉格納容器水素濃度 (D23-H2E-001B)	○	格納容器内雰囲気モニタ系	格納容器内雰囲気モニタ系弁 (D23-MO-F004A)	○	格納容器内雰囲気モニタ系	格納容器内雰囲気モニタ系弁 (D23-MO-F004B)	○	格納容器内雰囲気モニタ系	格納容器内雰囲気モニタ系弁 (D23-MO-F005A)	○	格納容器内雰囲気モニタ系	格納容器内雰囲気モニタ系弁 (D23-MO-F005B)	○	格納容器内雰囲気モニタ系	格納容器内雰囲気モニタ系弁 (D23-MO-F006A)	○	格納容器内雰囲気モニタ系	格納容器内雰囲気モニタ系弁 (D23-MO-F006B)	○				
系統	設備	蒸気評価																																																																																																					
原子炉系	原子炉水位 (B21-LT-003A)	○																																																																																																					
原子炉系	原子炉水位 (B21-LT-003B)	○																																																																																																					
原子炉系	原子炉水位 (B21-LT-003C)	○																																																																																																					
原子炉系	原子炉水位 (B21-LT-003D)	○																																																																																																					
原子炉系	原子炉水位 (B21-LT-003E)	○																																																																																																					
原子炉系	原子炉水位 (B21-LT-003F)	○																																																																																																					
原子炉系	原子炉水位 (B21-LT-003G)	○																																																																																																					
原子炉系	原子炉水位 (B21-LT-003H)	○																																																																																																					
原子炉系	原子炉水位 (B21-LT-006A)	○																																																																																																					
原子炉系	原子炉水位 (B21-LT-006B)	○																																																																																																					
原子炉系	原子炉圧力 (B21-PT-007A)	○																																																																																																					
原子炉系	原子炉圧力 (B21-PT-007B)	○																																																																																																					
原子炉系	原子炉圧力 (B21-PT-007C)	○																																																																																																					
原子炉系	原子炉圧力 (B21-PT-007D)	○																																																																																																					
制御棒駆動系	水圧制御ユニット (C12-D004) (北側)	○																																																																																																					
制御棒駆動系	水圧制御ユニット (C12-D004) (南側)	○																																																																																																					
ほう酸水注入系	ほう酸水注入系ポンプ (C41-C001A)	*注1																																																																																																					
ほう酸水注入系	ほう酸水注入系ポンプ (C41-C001B)	*注1																																																																																																					
ほう酸水注入系	ほう酸水注入系ポンプ用潤滑油ポンプ (C41-C002A)	*注1																																																																																																					
ほう酸水注入系	ほう酸水注入系ポンプ用潤滑油ポンプ (C41-C002B)	*注1																																																																																																					
ほう酸水注入系	ほう酸水注入系弁 (C41-MO-F001A)	○																																																																																																					
ほう酸水注入系	ほう酸水注入系弁 (C41-MO-F001B)	○																																																																																																					
ほう酸水注入系	ほう酸水注入系弁 (C41-MO-F006A)	○																																																																																																					
ほう酸水注入系	ほう酸水注入系弁 (C41-MO-F006B)	○																																																																																																					
格納容器内雰囲気モニタ系	原子炉格納容器水素濃度 (D23-H2E-001A)	○																																																																																																					
格納容器内雰囲気モニタ系	原子炉格納容器水素濃度 (D23-H2E-001B)	○																																																																																																					
格納容器内雰囲気モニタ系	格納容器内雰囲気モニタ系弁 (D23-MO-F004A)	○																																																																																																					
格納容器内雰囲気モニタ系	格納容器内雰囲気モニタ系弁 (D23-MO-F004B)	○																																																																																																					
格納容器内雰囲気モニタ系	格納容器内雰囲気モニタ系弁 (D23-MO-F005A)	○																																																																																																					
格納容器内雰囲気モニタ系	格納容器内雰囲気モニタ系弁 (D23-MO-F005B)	○																																																																																																					
格納容器内雰囲気モニタ系	格納容器内雰囲気モニタ系弁 (D23-MO-F006A)	○																																																																																																					
格納容器内雰囲気モニタ系	格納容器内雰囲気モニタ系弁 (D23-MO-F006B)	○																																																																																																					

柏崎刈羽原子力発電所 6 / 7号炉 (2017.12.20版)	東海第二発電所 (2018.9.18版)	島根原子力発電所 2号炉	備考
----------------------------------	----------------------	--------------	----

添付第 5.3-3 表 7号炉原子炉二次格納施設内防護対象設備の蒸気影響確認結果

系統	設備	蒸気評価
格納容器内雰囲気モニタ系	格納容器内雰囲気モニタ系弁 (D23-MO-F007A)	○
格納容器内雰囲気モニタ系	格納容器内雰囲気モニタ系弁 (D23-MO-F007B)	○
格納容器内雰囲気モニタ系	格納容器内雰囲気モニタ系弁 (D23-MO-F008A)	○
格納容器内雰囲気モニタ系	格納容器内雰囲気モニタ系弁 (D23-MO-F008B)	○
格納容器内雰囲気モニタ系	原子炉格納容器酸素濃度 (D23-O2E-003A)	○
格納容器内雰囲気モニタ系	原子炉格納容器酸素濃度 (D23-O2E-003B)	○
格納容器内雰囲気モニタ系	原子炉格納容器エリア放射線量率 (高レンジ) (D23-RE-005A)	○
格納容器内雰囲気モニタ系	原子炉格納容器エリア放射線量率 (高レンジ) (D23-RE-005B)	○
格納容器内雰囲気モニタ系	原子炉格納容器エリア放射線量率 (高レンジ) (D23-RE-006A)	○
格納容器内雰囲気モニタ系	原子炉格納容器エリア放射線量率 (高レンジ) (D23-RE-006B)	○
格納容器内雰囲気モニタ系	格納容器内雰囲気モニタ系弁 (D23-SO-F001A)	○
格納容器内雰囲気モニタ系	格納容器内雰囲気モニタ系弁 (D23-SO-F001B)	○
残留熱除去系	残留熱除去系ポンプ (E11-C001A)	○
残留熱除去系	残留熱除去系ポンプ (E11-C001B)	○
残留熱除去系	残留熱除去系ポンプ (E11-C001C)	○
残留熱除去系	残留熱除去系弁 (E11-F016A)	○
残留熱除去系	残留熱除去系弁 (E11-F016B)	○
残留熱除去系	残留熱除去系弁 (E11-F016C)	○
残留熱除去系	残留熱除去系系統流量 (E11-FT-008A-2)	○
残留熱除去系	残留熱除去系系統流量 (E11-FT-008B-2)	○
残留熱除去系	残留熱除去系系統流量 (E11-FT-008C-2)	○
残留熱除去系	残留熱除去系弁 (E11-MO-F001A)	○
残留熱除去系	残留熱除去系弁 (E11-MO-F001B)	○
残留熱除去系	残留熱除去系弁 (E11-MO-F001C)	○
残留熱除去系	残留熱除去系弁 (E11-MO-F004A)	○
残留熱除去系	残留熱除去系弁 (E11-MO-F004B)	○
残留熱除去系	残留熱除去系弁 (E11-MO-F004C)	○
残留熱除去系	残留熱除去系弁 (E11-MO-F005A)	○
残留熱除去系	残留熱除去系弁 (E11-MO-F005B)	○
残留熱除去系	残留熱除去系弁 (E11-MO-F005C)	○
残留熱除去系	残留熱除去系弁 (E11-MO-F008A)	○
残留熱除去系	残留熱除去系弁 (E11-MO-F008B)	○
残留熱除去系	残留熱除去系弁 (E11-MO-F008C)	○

柏崎刈羽原子力発電所 6 / 7号炉 (2017. 12. 20 版)	東海第二発電所 (2018. 9. 18 版)	島根原子力発電所 2号炉	備考																																																																																																						
添付第 5.3-3 表 7号炉原子炉二次格納施設内防護対象設備の蒸気影響確認結果																																																																																																									
<table border="1"> <thead> <tr> <th>系統</th> <th>設備</th> <th>蒸気評価</th> </tr> </thead> <tbody> <tr><td>残留熱除去系</td><td>残留熱除去系弁 (E11-MO-F011A)</td><td>○</td></tr> <tr><td>残留熱除去系</td><td>残留熱除去系弁 (E11-MO-F011B)</td><td>○</td></tr> <tr><td>残留熱除去系</td><td>残留熱除去系弁 (E11-MO-F011C)</td><td>○</td></tr> <tr><td>残留熱除去系</td><td>残留熱除去系弁 (E11-MO-F012A)</td><td>○</td></tr> <tr><td>残留熱除去系</td><td>残留熱除去系弁 (E11-MO-F012B)</td><td>○</td></tr> <tr><td>残留熱除去系</td><td>残留熱除去系弁 (E11-MO-F012C)</td><td>○</td></tr> <tr><td>残留熱除去系</td><td>残留熱除去系弁 (E11-MO-F013A)</td><td>○</td></tr> <tr><td>残留熱除去系</td><td>残留熱除去系弁 (E11-MO-F013B)</td><td>○</td></tr> <tr><td>残留熱除去系</td><td>残留熱除去系弁 (E11-MO-F013C)</td><td>○</td></tr> <tr><td>残留熱除去系</td><td>残留熱除去系弁 (E11-MO-F014A)</td><td>○</td></tr> <tr><td>残留熱除去系</td><td>残留熱除去系弁 (E11-MO-F014B)</td><td>○</td></tr> <tr><td>残留熱除去系</td><td>残留熱除去系弁 (E11-MO-F014C)</td><td>○</td></tr> <tr><td>残留熱除去系</td><td>残留熱除去系弁 (E11-MO-F015)</td><td>○</td></tr> <tr><td>残留熱除去系</td><td>残留熱除去系弁 (E11-MO-F017B)</td><td>○</td></tr> <tr><td>残留熱除去系</td><td>残留熱除去系弁 (E11-MO-F017C)</td><td>○</td></tr> <tr><td>残留熱除去系</td><td>残留熱除去系弁 (E11-MO-F018B)</td><td>○</td></tr> <tr><td>残留熱除去系</td><td>残留熱除去系弁 (E11-MO-F018C)</td><td>○</td></tr> <tr><td>残留熱除去系</td><td>残留熱除去系弁 (E11-MO-F019B)</td><td>○</td></tr> <tr><td>残留熱除去系</td><td>残留熱除去系弁 (E11-MO-F019C)</td><td>○</td></tr> <tr><td>残留熱除去系</td><td>残留熱除去系弁 (E11-MO-F021A)</td><td>○</td></tr> <tr><td>残留熱除去系</td><td>残留熱除去系弁 (E11-MO-F021B)</td><td>○</td></tr> <tr><td>残留熱除去系</td><td>残留熱除去系弁 (E11-MO-F021C)</td><td>○</td></tr> <tr><td>高圧炉心注水系</td><td>高圧炉心注水系ポンプ (E22-C001B)</td><td>○</td></tr> <tr><td>高圧炉心注水系</td><td>高圧炉心注水系ポンプ (E22-C001C)</td><td>○</td></tr> <tr><td>高圧炉心注水系</td><td>高圧炉心注水系系統流量 (E22-FT-007B-2)</td><td>○</td></tr> <tr><td>高圧炉心注水系</td><td>高圧炉心注水系系統流量 (E22-FT-007C-2)</td><td>○</td></tr> <tr><td>高圧炉心注水系</td><td>サブプレッションプール水位 (E22-LT-010A)</td><td>○</td></tr> <tr><td>高圧炉心注水系</td><td>サブプレッションプール水位 (E22-LT-010B)</td><td>○</td></tr> <tr><td>高圧炉心注水系</td><td>サブプレッションプール水位 (E22-LT-010C)</td><td>○</td></tr> <tr><td>高圧炉心注水系</td><td>サブプレッションプール水位 (E22-LT-010D)</td><td>○</td></tr> <tr><td>高圧炉心注水系</td><td>高圧炉心注水系弁 (E22-MO-F001B)</td><td>○</td></tr> <tr><td>高圧炉心注水系</td><td>高圧炉心注水系弁 (E22-MO-F001C)</td><td>○</td></tr> <tr><td>高圧炉心注水系</td><td>高圧炉心注水系弁 (E22-MO-F003B)</td><td>○</td></tr> </tbody> </table>	系統	設備	蒸気評価	残留熱除去系	残留熱除去系弁 (E11-MO-F011A)	○	残留熱除去系	残留熱除去系弁 (E11-MO-F011B)	○	残留熱除去系	残留熱除去系弁 (E11-MO-F011C)	○	残留熱除去系	残留熱除去系弁 (E11-MO-F012A)	○	残留熱除去系	残留熱除去系弁 (E11-MO-F012B)	○	残留熱除去系	残留熱除去系弁 (E11-MO-F012C)	○	残留熱除去系	残留熱除去系弁 (E11-MO-F013A)	○	残留熱除去系	残留熱除去系弁 (E11-MO-F013B)	○	残留熱除去系	残留熱除去系弁 (E11-MO-F013C)	○	残留熱除去系	残留熱除去系弁 (E11-MO-F014A)	○	残留熱除去系	残留熱除去系弁 (E11-MO-F014B)	○	残留熱除去系	残留熱除去系弁 (E11-MO-F014C)	○	残留熱除去系	残留熱除去系弁 (E11-MO-F015)	○	残留熱除去系	残留熱除去系弁 (E11-MO-F017B)	○	残留熱除去系	残留熱除去系弁 (E11-MO-F017C)	○	残留熱除去系	残留熱除去系弁 (E11-MO-F018B)	○	残留熱除去系	残留熱除去系弁 (E11-MO-F018C)	○	残留熱除去系	残留熱除去系弁 (E11-MO-F019B)	○	残留熱除去系	残留熱除去系弁 (E11-MO-F019C)	○	残留熱除去系	残留熱除去系弁 (E11-MO-F021A)	○	残留熱除去系	残留熱除去系弁 (E11-MO-F021B)	○	残留熱除去系	残留熱除去系弁 (E11-MO-F021C)	○	高圧炉心注水系	高圧炉心注水系ポンプ (E22-C001B)	○	高圧炉心注水系	高圧炉心注水系ポンプ (E22-C001C)	○	高圧炉心注水系	高圧炉心注水系系統流量 (E22-FT-007B-2)	○	高圧炉心注水系	高圧炉心注水系系統流量 (E22-FT-007C-2)	○	高圧炉心注水系	サブプレッションプール水位 (E22-LT-010A)	○	高圧炉心注水系	サブプレッションプール水位 (E22-LT-010B)	○	高圧炉心注水系	サブプレッションプール水位 (E22-LT-010C)	○	高圧炉心注水系	サブプレッションプール水位 (E22-LT-010D)	○	高圧炉心注水系	高圧炉心注水系弁 (E22-MO-F001B)	○	高圧炉心注水系	高圧炉心注水系弁 (E22-MO-F001C)	○	高圧炉心注水系	高圧炉心注水系弁 (E22-MO-F003B)	○			
系統	設備	蒸気評価																																																																																																							
残留熱除去系	残留熱除去系弁 (E11-MO-F011A)	○																																																																																																							
残留熱除去系	残留熱除去系弁 (E11-MO-F011B)	○																																																																																																							
残留熱除去系	残留熱除去系弁 (E11-MO-F011C)	○																																																																																																							
残留熱除去系	残留熱除去系弁 (E11-MO-F012A)	○																																																																																																							
残留熱除去系	残留熱除去系弁 (E11-MO-F012B)	○																																																																																																							
残留熱除去系	残留熱除去系弁 (E11-MO-F012C)	○																																																																																																							
残留熱除去系	残留熱除去系弁 (E11-MO-F013A)	○																																																																																																							
残留熱除去系	残留熱除去系弁 (E11-MO-F013B)	○																																																																																																							
残留熱除去系	残留熱除去系弁 (E11-MO-F013C)	○																																																																																																							
残留熱除去系	残留熱除去系弁 (E11-MO-F014A)	○																																																																																																							
残留熱除去系	残留熱除去系弁 (E11-MO-F014B)	○																																																																																																							
残留熱除去系	残留熱除去系弁 (E11-MO-F014C)	○																																																																																																							
残留熱除去系	残留熱除去系弁 (E11-MO-F015)	○																																																																																																							
残留熱除去系	残留熱除去系弁 (E11-MO-F017B)	○																																																																																																							
残留熱除去系	残留熱除去系弁 (E11-MO-F017C)	○																																																																																																							
残留熱除去系	残留熱除去系弁 (E11-MO-F018B)	○																																																																																																							
残留熱除去系	残留熱除去系弁 (E11-MO-F018C)	○																																																																																																							
残留熱除去系	残留熱除去系弁 (E11-MO-F019B)	○																																																																																																							
残留熱除去系	残留熱除去系弁 (E11-MO-F019C)	○																																																																																																							
残留熱除去系	残留熱除去系弁 (E11-MO-F021A)	○																																																																																																							
残留熱除去系	残留熱除去系弁 (E11-MO-F021B)	○																																																																																																							
残留熱除去系	残留熱除去系弁 (E11-MO-F021C)	○																																																																																																							
高圧炉心注水系	高圧炉心注水系ポンプ (E22-C001B)	○																																																																																																							
高圧炉心注水系	高圧炉心注水系ポンプ (E22-C001C)	○																																																																																																							
高圧炉心注水系	高圧炉心注水系系統流量 (E22-FT-007B-2)	○																																																																																																							
高圧炉心注水系	高圧炉心注水系系統流量 (E22-FT-007C-2)	○																																																																																																							
高圧炉心注水系	サブプレッションプール水位 (E22-LT-010A)	○																																																																																																							
高圧炉心注水系	サブプレッションプール水位 (E22-LT-010B)	○																																																																																																							
高圧炉心注水系	サブプレッションプール水位 (E22-LT-010C)	○																																																																																																							
高圧炉心注水系	サブプレッションプール水位 (E22-LT-010D)	○																																																																																																							
高圧炉心注水系	高圧炉心注水系弁 (E22-MO-F001B)	○																																																																																																							
高圧炉心注水系	高圧炉心注水系弁 (E22-MO-F001C)	○																																																																																																							
高圧炉心注水系	高圧炉心注水系弁 (E22-MO-F003B)	○																																																																																																							

柏崎刈羽原子力発電所 6 / 7号炉 (2017.12.20版)	東海第二発電所 (2018.9.18版)	島根原子力発電所 2号炉	備考																																																																																																						
添付第 5.3-3 表 7号炉原子炉二次格納施設内防護対象設備の蒸気影響確認結果																																																																																																									
<table border="1"> <thead> <tr> <th>系統</th> <th>設備</th> <th>蒸気評価</th> </tr> </thead> <tbody> <tr><td>高压炉心注水系</td><td>高压炉心注水系弁 (E22-MO-F003C)</td><td>○</td></tr> <tr><td>高压炉心注水系</td><td>高压炉心注水系弁 (E22-MO-F006B)</td><td>○</td></tr> <tr><td>高压炉心注水系</td><td>高压炉心注水系弁 (E22-MO-F006C)</td><td>○</td></tr> <tr><td>高压炉心注水系</td><td>高压炉心注水系弁 (E22-MO-F010B)</td><td>○</td></tr> <tr><td>高压炉心注水系</td><td>高压炉心注水系弁 (E22-MO-F010C)</td><td>○</td></tr> <tr><td>原子炉隔離時冷却系</td><td>原子炉隔離時冷却系ポンプ (E51-C001)</td><td>○</td></tr> <tr><td>原子炉隔離時冷却系</td><td>原子炉隔離時冷却系ポンプ駆動用蒸気タービン (E51-C002)</td><td>○</td></tr> <tr><td>原子炉隔離時冷却系</td><td>原子炉隔離時冷却系復水ポンプ (E51-C003)</td><td>○</td></tr> <tr><td>原子炉隔離時冷却系</td><td>原子炉隔離時冷却系真空ポンプ (E51-C004)</td><td>○</td></tr> <tr><td>原子炉隔離時冷却系</td><td>原子炉隔離時冷却系蒸気タービン用主油ポンプ (E51-C005)</td><td>○</td></tr> <tr><td>原子炉隔離時冷却系</td><td>原子炉隔離時冷却系ポンプ吐出流量 (E51-FT-006)</td><td>○</td></tr> <tr><td>原子炉隔離時冷却系</td><td>原子炉隔離時冷却系弁 (E51-HO-F401)</td><td>○</td></tr> <tr><td>原子炉隔離時冷却系</td><td>原子炉隔離時冷却系弁 (E51-MO-F001)</td><td>○</td></tr> <tr><td>原子炉隔離時冷却系</td><td>原子炉隔離時冷却系弁 (E51-MO-F004)</td><td>○</td></tr> <tr><td>原子炉隔離時冷却系</td><td>原子炉隔離時冷却系弁 (E51-MO-F006)</td><td>○</td></tr> <tr><td>原子炉隔離時冷却系</td><td>原子炉隔離時冷却系弁 (E51-MO-F011)</td><td>○</td></tr> <tr><td>原子炉隔離時冷却系</td><td>原子炉隔離時冷却系弁 (E51-MO-F012)</td><td>○</td></tr> <tr><td>原子炉隔離時冷却系</td><td>原子炉隔離時冷却系弁 (E51-MO-F036)</td><td>○</td></tr> <tr><td>原子炉隔離時冷却系</td><td>原子炉隔離時冷却系弁 (E51-MO-F037)</td><td>○</td></tr> <tr><td>原子炉隔離時冷却系</td><td>原子炉隔離時冷却系弁 (E51-MO-F400)</td><td>○</td></tr> <tr><td>原子炉冷却材浄化系</td><td>原子炉冷却材浄化系弁 (G31-MO-F003)</td><td>○</td></tr> <tr><td>燃料プール冷却浄化系</td><td>燃料プール冷却浄化系ポンプ (G41-C001A)</td><td>○</td></tr> <tr><td>燃料プール冷却浄化系</td><td>燃料プール冷却浄化系ポンプ (G41-C001B)</td><td>○</td></tr> <tr><td>燃料プール冷却浄化系</td><td>燃料プール冷却浄化系弁 (G41-F030)</td><td>○</td></tr> <tr><td>燃料プール冷却浄化系</td><td>燃料プール冷却浄化系弁 (G41-F032)</td><td>○</td></tr> <tr><td>燃料プール冷却浄化系</td><td>燃料プール冷却浄化系弁 (G41-MO-F005A)</td><td>○</td></tr> <tr><td>燃料プール冷却浄化系</td><td>燃料プール冷却浄化系弁 (G41-MO-F013)</td><td>○</td></tr> <tr><td>燃料プール冷却浄化系</td><td>燃料プール冷却浄化系弁 (G41-MO-F021A)</td><td>○</td></tr> <tr><td>燃料プール冷却浄化系</td><td>燃料プール冷却浄化系弁 (G41-MO-F021B)</td><td>○</td></tr> <tr><td>サブプレッションプール浄化系</td><td>サブプレッションプール浄化用ポンプ (G51-C001)</td><td>○</td></tr> <tr><td>サブプレッションプール浄化系</td><td>サブプレッションプール浄化系弁 (G51-MO-F015)</td><td>○</td></tr> <tr><td>盤類</td><td>ほう酸水注入系操作盤 (H21-P027A)</td><td>※注1</td></tr> <tr><td>盤類</td><td>ほう酸水注入系操作盤 (H21-P027B)</td><td>※注1</td></tr> </tbody> </table>	系統	設備	蒸気評価	高压炉心注水系	高压炉心注水系弁 (E22-MO-F003C)	○	高压炉心注水系	高压炉心注水系弁 (E22-MO-F006B)	○	高压炉心注水系	高压炉心注水系弁 (E22-MO-F006C)	○	高压炉心注水系	高压炉心注水系弁 (E22-MO-F010B)	○	高压炉心注水系	高压炉心注水系弁 (E22-MO-F010C)	○	原子炉隔離時冷却系	原子炉隔離時冷却系ポンプ (E51-C001)	○	原子炉隔離時冷却系	原子炉隔離時冷却系ポンプ駆動用蒸気タービン (E51-C002)	○	原子炉隔離時冷却系	原子炉隔離時冷却系復水ポンプ (E51-C003)	○	原子炉隔離時冷却系	原子炉隔離時冷却系真空ポンプ (E51-C004)	○	原子炉隔離時冷却系	原子炉隔離時冷却系蒸気タービン用主油ポンプ (E51-C005)	○	原子炉隔離時冷却系	原子炉隔離時冷却系ポンプ吐出流量 (E51-FT-006)	○	原子炉隔離時冷却系	原子炉隔離時冷却系弁 (E51-HO-F401)	○	原子炉隔離時冷却系	原子炉隔離時冷却系弁 (E51-MO-F001)	○	原子炉隔離時冷却系	原子炉隔離時冷却系弁 (E51-MO-F004)	○	原子炉隔離時冷却系	原子炉隔離時冷却系弁 (E51-MO-F006)	○	原子炉隔離時冷却系	原子炉隔離時冷却系弁 (E51-MO-F011)	○	原子炉隔離時冷却系	原子炉隔離時冷却系弁 (E51-MO-F012)	○	原子炉隔離時冷却系	原子炉隔離時冷却系弁 (E51-MO-F036)	○	原子炉隔離時冷却系	原子炉隔離時冷却系弁 (E51-MO-F037)	○	原子炉隔離時冷却系	原子炉隔離時冷却系弁 (E51-MO-F400)	○	原子炉冷却材浄化系	原子炉冷却材浄化系弁 (G31-MO-F003)	○	燃料プール冷却浄化系	燃料プール冷却浄化系ポンプ (G41-C001A)	○	燃料プール冷却浄化系	燃料プール冷却浄化系ポンプ (G41-C001B)	○	燃料プール冷却浄化系	燃料プール冷却浄化系弁 (G41-F030)	○	燃料プール冷却浄化系	燃料プール冷却浄化系弁 (G41-F032)	○	燃料プール冷却浄化系	燃料プール冷却浄化系弁 (G41-MO-F005A)	○	燃料プール冷却浄化系	燃料プール冷却浄化系弁 (G41-MO-F013)	○	燃料プール冷却浄化系	燃料プール冷却浄化系弁 (G41-MO-F021A)	○	燃料プール冷却浄化系	燃料プール冷却浄化系弁 (G41-MO-F021B)	○	サブプレッションプール浄化系	サブプレッションプール浄化用ポンプ (G51-C001)	○	サブプレッションプール浄化系	サブプレッションプール浄化系弁 (G51-MO-F015)	○	盤類	ほう酸水注入系操作盤 (H21-P027A)	※注1	盤類	ほう酸水注入系操作盤 (H21-P027B)	※注1			
系統	設備	蒸気評価																																																																																																							
高压炉心注水系	高压炉心注水系弁 (E22-MO-F003C)	○																																																																																																							
高压炉心注水系	高压炉心注水系弁 (E22-MO-F006B)	○																																																																																																							
高压炉心注水系	高压炉心注水系弁 (E22-MO-F006C)	○																																																																																																							
高压炉心注水系	高压炉心注水系弁 (E22-MO-F010B)	○																																																																																																							
高压炉心注水系	高压炉心注水系弁 (E22-MO-F010C)	○																																																																																																							
原子炉隔離時冷却系	原子炉隔離時冷却系ポンプ (E51-C001)	○																																																																																																							
原子炉隔離時冷却系	原子炉隔離時冷却系ポンプ駆動用蒸気タービン (E51-C002)	○																																																																																																							
原子炉隔離時冷却系	原子炉隔離時冷却系復水ポンプ (E51-C003)	○																																																																																																							
原子炉隔離時冷却系	原子炉隔離時冷却系真空ポンプ (E51-C004)	○																																																																																																							
原子炉隔離時冷却系	原子炉隔離時冷却系蒸気タービン用主油ポンプ (E51-C005)	○																																																																																																							
原子炉隔離時冷却系	原子炉隔離時冷却系ポンプ吐出流量 (E51-FT-006)	○																																																																																																							
原子炉隔離時冷却系	原子炉隔離時冷却系弁 (E51-HO-F401)	○																																																																																																							
原子炉隔離時冷却系	原子炉隔離時冷却系弁 (E51-MO-F001)	○																																																																																																							
原子炉隔離時冷却系	原子炉隔離時冷却系弁 (E51-MO-F004)	○																																																																																																							
原子炉隔離時冷却系	原子炉隔離時冷却系弁 (E51-MO-F006)	○																																																																																																							
原子炉隔離時冷却系	原子炉隔離時冷却系弁 (E51-MO-F011)	○																																																																																																							
原子炉隔離時冷却系	原子炉隔離時冷却系弁 (E51-MO-F012)	○																																																																																																							
原子炉隔離時冷却系	原子炉隔離時冷却系弁 (E51-MO-F036)	○																																																																																																							
原子炉隔離時冷却系	原子炉隔離時冷却系弁 (E51-MO-F037)	○																																																																																																							
原子炉隔離時冷却系	原子炉隔離時冷却系弁 (E51-MO-F400)	○																																																																																																							
原子炉冷却材浄化系	原子炉冷却材浄化系弁 (G31-MO-F003)	○																																																																																																							
燃料プール冷却浄化系	燃料プール冷却浄化系ポンプ (G41-C001A)	○																																																																																																							
燃料プール冷却浄化系	燃料プール冷却浄化系ポンプ (G41-C001B)	○																																																																																																							
燃料プール冷却浄化系	燃料プール冷却浄化系弁 (G41-F030)	○																																																																																																							
燃料プール冷却浄化系	燃料プール冷却浄化系弁 (G41-F032)	○																																																																																																							
燃料プール冷却浄化系	燃料プール冷却浄化系弁 (G41-MO-F005A)	○																																																																																																							
燃料プール冷却浄化系	燃料プール冷却浄化系弁 (G41-MO-F013)	○																																																																																																							
燃料プール冷却浄化系	燃料プール冷却浄化系弁 (G41-MO-F021A)	○																																																																																																							
燃料プール冷却浄化系	燃料プール冷却浄化系弁 (G41-MO-F021B)	○																																																																																																							
サブプレッションプール浄化系	サブプレッションプール浄化用ポンプ (G51-C001)	○																																																																																																							
サブプレッションプール浄化系	サブプレッションプール浄化系弁 (G51-MO-F015)	○																																																																																																							
盤類	ほう酸水注入系操作盤 (H21-P027A)	※注1																																																																																																							
盤類	ほう酸水注入系操作盤 (H21-P027B)	※注1																																																																																																							

柏崎刈羽原子力発電所 6 / 7号炉 (2017.12.20版)	東海第二発電所 (2018.9.18版)	島根原子力発電所 2号炉	備考																																																																																																						
添付第 5.3-3 表 7号炉原子炉二次格納施設内防護対象設備の蒸気影響確認結果																																																																																																									
<table border="1"> <thead> <tr> <th>系統</th> <th>設備</th> <th>蒸気評価</th> </tr> </thead> <tbody> <tr><td>原子炉補機冷却水系</td><td>原子炉補機冷却系弁 (P21-MO-F016A)</td><td>○</td></tr> <tr><td>原子炉補機冷却水系</td><td>原子炉補機冷却系弁 (P21-MO-F016B)</td><td>○</td></tr> <tr><td>原子炉補機冷却水系</td><td>原子炉補機冷却系弁 (P21-MO-F016C)</td><td>○</td></tr> <tr><td>原子炉補機冷却水系</td><td>原子炉補機冷却系弁 (P21-MO-F037A)</td><td>○</td></tr> <tr><td>原子炉補機冷却水系</td><td>原子炉補機冷却系弁 (P21-MO-F037B)</td><td>○</td></tr> <tr><td>原子炉補機冷却水系</td><td>原子炉補機冷却系弁 (P21-MO-F037C)</td><td>○</td></tr> <tr><td>原子炉補機冷却水系</td><td>原子炉補機冷却系弁 (P21-MO-F042A)</td><td>○</td></tr> <tr><td>原子炉補機冷却水系</td><td>原子炉補機冷却系弁 (P21-MO-F042B)</td><td>○</td></tr> <tr><td>原子炉補機冷却水系</td><td>原子炉補機冷却系弁 (P21-MO-F042C)</td><td>○</td></tr> <tr><td>原子炉補機冷却水系</td><td>原子炉補機冷却系弁 (P21-MO-F048A)</td><td>○</td></tr> <tr><td>原子炉補機冷却水系</td><td>原子炉補機冷却系弁 (P21-MO-F048B)</td><td>○</td></tr> <tr><td>原子炉補機冷却水系</td><td>原子炉補機冷却系弁 (P21-MO-F048C)</td><td>○</td></tr> <tr><td>原子炉補機冷却水系</td><td>原子炉補機冷却系弁 (P21-MO-F048D)</td><td>○</td></tr> <tr><td>原子炉補機冷却水系</td><td>原子炉補機冷却系弁 (P21-MO-F048E)</td><td>○</td></tr> <tr><td>原子炉補機冷却水系</td><td>原子炉補機冷却系弁 (P21-MO-F048F)</td><td>○</td></tr> <tr><td>高圧窒素ガス供給系</td><td>高圧窒素ガス供給系弁 (P54-MO-F003A)</td><td>○</td></tr> <tr><td>高圧窒素ガス供給系</td><td>高圧窒素ガス供給系弁 (P54-MO-F003B)</td><td>○</td></tr> <tr><td>高圧窒素ガス供給系</td><td>高圧窒素ガス供給系弁 (P54-MO-F012A)</td><td>○</td></tr> <tr><td>高圧窒素ガス供給系</td><td>高圧窒素ガス供給系弁 (P54-MO-F012B)</td><td>○</td></tr> <tr><td>非常用ガス処理系</td><td>非常用ガス処理系弁 (T22-AO-F001A)</td><td>*H 2</td></tr> <tr><td>非常用ガス処理系</td><td>非常用ガス処理系弁 (T22-AO-F001B)</td><td>*H 2</td></tr> <tr><td>非常用ガス処理系</td><td>非常用ガス処理系排風機 (T22-C001A)</td><td>○</td></tr> <tr><td>非常用ガス処理系</td><td>非常用ガス処理系排風機 (T22-C001B)</td><td>○</td></tr> <tr><td>非常用ガス処理系</td><td>非常用ガス処理系乾燥装置 (T22-D001A)</td><td>○</td></tr> <tr><td>非常用ガス処理系</td><td>非常用ガス処理系乾燥装置 (T22-D001B)</td><td>○</td></tr> <tr><td>非常用ガス処理系</td><td>非常用ガス処理系フィルタ装置 (T22-D002)</td><td>*H 3</td></tr> <tr><td>非常用ガス処理系</td><td>非常用ガス処理系弁 (T22-MO-F002A)</td><td>○</td></tr> <tr><td>非常用ガス処理系</td><td>非常用ガス処理系弁 (T22-MO-F002B)</td><td>○</td></tr> <tr><td>非常用ガス処理系</td><td>非常用ガス処理系弁 (T22-MO-F004A)</td><td>○</td></tr> <tr><td>非常用ガス処理系</td><td>非常用ガス処理系弁 (T22-MO-F004B)</td><td>○</td></tr> <tr><td>不活性ガス系</td><td>原子炉格納容器圧力 (T31-PT-026A)</td><td>○</td></tr> <tr><td>不活性ガス系</td><td>原子炉格納容器圧力 (T31-PT-026B)</td><td>○</td></tr> <tr><td>可燃性ガス濃度制御系</td><td>可燃性ガス濃度制御系可搬式再結合装置再結合器 (T49-A001A)</td><td>○</td></tr> </tbody> </table>	系統	設備	蒸気評価	原子炉補機冷却水系	原子炉補機冷却系弁 (P21-MO-F016A)	○	原子炉補機冷却水系	原子炉補機冷却系弁 (P21-MO-F016B)	○	原子炉補機冷却水系	原子炉補機冷却系弁 (P21-MO-F016C)	○	原子炉補機冷却水系	原子炉補機冷却系弁 (P21-MO-F037A)	○	原子炉補機冷却水系	原子炉補機冷却系弁 (P21-MO-F037B)	○	原子炉補機冷却水系	原子炉補機冷却系弁 (P21-MO-F037C)	○	原子炉補機冷却水系	原子炉補機冷却系弁 (P21-MO-F042A)	○	原子炉補機冷却水系	原子炉補機冷却系弁 (P21-MO-F042B)	○	原子炉補機冷却水系	原子炉補機冷却系弁 (P21-MO-F042C)	○	原子炉補機冷却水系	原子炉補機冷却系弁 (P21-MO-F048A)	○	原子炉補機冷却水系	原子炉補機冷却系弁 (P21-MO-F048B)	○	原子炉補機冷却水系	原子炉補機冷却系弁 (P21-MO-F048C)	○	原子炉補機冷却水系	原子炉補機冷却系弁 (P21-MO-F048D)	○	原子炉補機冷却水系	原子炉補機冷却系弁 (P21-MO-F048E)	○	原子炉補機冷却水系	原子炉補機冷却系弁 (P21-MO-F048F)	○	高圧窒素ガス供給系	高圧窒素ガス供給系弁 (P54-MO-F003A)	○	高圧窒素ガス供給系	高圧窒素ガス供給系弁 (P54-MO-F003B)	○	高圧窒素ガス供給系	高圧窒素ガス供給系弁 (P54-MO-F012A)	○	高圧窒素ガス供給系	高圧窒素ガス供給系弁 (P54-MO-F012B)	○	非常用ガス処理系	非常用ガス処理系弁 (T22-AO-F001A)	*H 2	非常用ガス処理系	非常用ガス処理系弁 (T22-AO-F001B)	*H 2	非常用ガス処理系	非常用ガス処理系排風機 (T22-C001A)	○	非常用ガス処理系	非常用ガス処理系排風機 (T22-C001B)	○	非常用ガス処理系	非常用ガス処理系乾燥装置 (T22-D001A)	○	非常用ガス処理系	非常用ガス処理系乾燥装置 (T22-D001B)	○	非常用ガス処理系	非常用ガス処理系フィルタ装置 (T22-D002)	*H 3	非常用ガス処理系	非常用ガス処理系弁 (T22-MO-F002A)	○	非常用ガス処理系	非常用ガス処理系弁 (T22-MO-F002B)	○	非常用ガス処理系	非常用ガス処理系弁 (T22-MO-F004A)	○	非常用ガス処理系	非常用ガス処理系弁 (T22-MO-F004B)	○	不活性ガス系	原子炉格納容器圧力 (T31-PT-026A)	○	不活性ガス系	原子炉格納容器圧力 (T31-PT-026B)	○	可燃性ガス濃度制御系	可燃性ガス濃度制御系可搬式再結合装置再結合器 (T49-A001A)	○			
系統	設備	蒸気評価																																																																																																							
原子炉補機冷却水系	原子炉補機冷却系弁 (P21-MO-F016A)	○																																																																																																							
原子炉補機冷却水系	原子炉補機冷却系弁 (P21-MO-F016B)	○																																																																																																							
原子炉補機冷却水系	原子炉補機冷却系弁 (P21-MO-F016C)	○																																																																																																							
原子炉補機冷却水系	原子炉補機冷却系弁 (P21-MO-F037A)	○																																																																																																							
原子炉補機冷却水系	原子炉補機冷却系弁 (P21-MO-F037B)	○																																																																																																							
原子炉補機冷却水系	原子炉補機冷却系弁 (P21-MO-F037C)	○																																																																																																							
原子炉補機冷却水系	原子炉補機冷却系弁 (P21-MO-F042A)	○																																																																																																							
原子炉補機冷却水系	原子炉補機冷却系弁 (P21-MO-F042B)	○																																																																																																							
原子炉補機冷却水系	原子炉補機冷却系弁 (P21-MO-F042C)	○																																																																																																							
原子炉補機冷却水系	原子炉補機冷却系弁 (P21-MO-F048A)	○																																																																																																							
原子炉補機冷却水系	原子炉補機冷却系弁 (P21-MO-F048B)	○																																																																																																							
原子炉補機冷却水系	原子炉補機冷却系弁 (P21-MO-F048C)	○																																																																																																							
原子炉補機冷却水系	原子炉補機冷却系弁 (P21-MO-F048D)	○																																																																																																							
原子炉補機冷却水系	原子炉補機冷却系弁 (P21-MO-F048E)	○																																																																																																							
原子炉補機冷却水系	原子炉補機冷却系弁 (P21-MO-F048F)	○																																																																																																							
高圧窒素ガス供給系	高圧窒素ガス供給系弁 (P54-MO-F003A)	○																																																																																																							
高圧窒素ガス供給系	高圧窒素ガス供給系弁 (P54-MO-F003B)	○																																																																																																							
高圧窒素ガス供給系	高圧窒素ガス供給系弁 (P54-MO-F012A)	○																																																																																																							
高圧窒素ガス供給系	高圧窒素ガス供給系弁 (P54-MO-F012B)	○																																																																																																							
非常用ガス処理系	非常用ガス処理系弁 (T22-AO-F001A)	*H 2																																																																																																							
非常用ガス処理系	非常用ガス処理系弁 (T22-AO-F001B)	*H 2																																																																																																							
非常用ガス処理系	非常用ガス処理系排風機 (T22-C001A)	○																																																																																																							
非常用ガス処理系	非常用ガス処理系排風機 (T22-C001B)	○																																																																																																							
非常用ガス処理系	非常用ガス処理系乾燥装置 (T22-D001A)	○																																																																																																							
非常用ガス処理系	非常用ガス処理系乾燥装置 (T22-D001B)	○																																																																																																							
非常用ガス処理系	非常用ガス処理系フィルタ装置 (T22-D002)	*H 3																																																																																																							
非常用ガス処理系	非常用ガス処理系弁 (T22-MO-F002A)	○																																																																																																							
非常用ガス処理系	非常用ガス処理系弁 (T22-MO-F002B)	○																																																																																																							
非常用ガス処理系	非常用ガス処理系弁 (T22-MO-F004A)	○																																																																																																							
非常用ガス処理系	非常用ガス処理系弁 (T22-MO-F004B)	○																																																																																																							
不活性ガス系	原子炉格納容器圧力 (T31-PT-026A)	○																																																																																																							
不活性ガス系	原子炉格納容器圧力 (T31-PT-026B)	○																																																																																																							
可燃性ガス濃度制御系	可燃性ガス濃度制御系可搬式再結合装置再結合器 (T49-A001A)	○																																																																																																							

柏崎刈羽原子力発電所 6 / 7号炉 (2017. 12. 20 版)	東海第二発電所 (2018. 9. 18 版)	島根原子力発電所 2号炉	備考																																																																																																							
添付第 5.3-3 表 7号炉原子炉二次格納施設内防護対象設備の蒸気影響確認結果																																																																																																										
<table border="1"> <thead> <tr> <th>系統</th> <th>設備</th> <th>蒸気評価</th> </tr> </thead> <tbody> <tr><td>可燃性ガス濃度制御系</td><td>可燃性ガス濃度制御系可搬式再結合装置再結合器 (T49-A001B)</td><td>○</td></tr> <tr><td>可燃性ガス濃度制御系</td><td>可燃性ガス濃度制御系可搬式再結合装置加熱器 (T49-B001A)</td><td>○</td></tr> <tr><td>可燃性ガス濃度制御系</td><td>可燃性ガス濃度制御系可搬式再結合装置加熱器 (T49-B001B)</td><td>○</td></tr> <tr><td>可燃性ガス濃度制御系</td><td>可燃性ガス濃度制御系可搬式再結合装置冷却器 (T49-B002A)</td><td>○</td></tr> <tr><td>可燃性ガス濃度制御系</td><td>可燃性ガス濃度制御系可搬式再結合装置冷却器 (T49-B002B)</td><td>○</td></tr> <tr><td>可燃性ガス濃度制御系</td><td>可燃性ガス濃度制御系可搬式再結合装置ブロワ (T49-C001A)</td><td>○</td></tr> <tr><td>可燃性ガス濃度制御系</td><td>可燃性ガス濃度制御系可搬式再結合装置ブロワ (T49-C001B)</td><td>○</td></tr> <tr><td>可燃性ガス濃度制御系</td><td>可燃性ガス濃度制御系可搬式再結合装置気水分離器 (T49-D001A)</td><td>○</td></tr> <tr><td>可燃性ガス濃度制御系</td><td>可燃性ガス濃度制御系可搬式再結合装置気水分離器 (T49-D001B)</td><td>○</td></tr> <tr><td>可燃性ガス濃度制御系</td><td>可燃性ガス濃度制御系弁 (T49-MO-F001A)</td><td>○</td></tr> <tr><td>可燃性ガス濃度制御系</td><td>可燃性ガス濃度制御系弁 (T49-MO-F001B)</td><td>○</td></tr> <tr><td>可燃性ガス濃度制御系</td><td>可燃性ガス濃度制御系弁 (T49-MO-F002A)</td><td>○</td></tr> <tr><td>可燃性ガス濃度制御系</td><td>可燃性ガス濃度制御系弁 (T49-MO-F002B)</td><td>○</td></tr> <tr><td>可燃性ガス濃度制御系</td><td>可燃性ガス濃度制御系弁 (T49-MO-F003A)</td><td>○</td></tr> <tr><td>可燃性ガス濃度制御系</td><td>可燃性ガス濃度制御系弁 (T49-MO-F003B)</td><td>○</td></tr> <tr><td>可燃性ガス濃度制御系</td><td>可燃性ガス濃度制御系弁 (T49-MO-F004A)</td><td>○</td></tr> <tr><td>可燃性ガス濃度制御系</td><td>可燃性ガス濃度制御系弁 (T49-MO-F004B)</td><td>○</td></tr> <tr><td>可燃性ガス濃度制御系</td><td>可燃性ガス濃度制御系弁 (T49-MO-F006A)</td><td>○</td></tr> <tr><td>可燃性ガス濃度制御系</td><td>可燃性ガス濃度制御系弁 (T49-MO-F006B)</td><td>○</td></tr> <tr><td>可燃性ガス濃度制御系</td><td>可燃性ガス濃度制御系弁 (T49-MO-F007A)</td><td>○</td></tr> <tr><td>可燃性ガス濃度制御系</td><td>可燃性ガス濃度制御系弁 (T49-MO-F007B)</td><td>○</td></tr> <tr><td>可燃性ガス濃度制御系</td><td>可燃性ガス濃度制御系弁 (T49-MO-F008A)</td><td>○</td></tr> <tr><td>可燃性ガス濃度制御系</td><td>可燃性ガス濃度制御系弁 (T49-MO-F008B)</td><td>○</td></tr> <tr><td>可燃性ガス濃度制御系</td><td>可燃性ガス濃度制御系弁 (T49-MO-F010A)</td><td>○</td></tr> <tr><td>可燃性ガス濃度制御系</td><td>可燃性ガス濃度制御系弁 (T49-MO-F010B)</td><td>○</td></tr> <tr><td>換気空調系</td><td>残留熱除去系ポンプ室空調機 (U41-B103)</td><td>○</td></tr> <tr><td>換気空調系</td><td>残留熱除去系ポンプ室空調機 (U41-B104)</td><td>○</td></tr> <tr><td>換気空調系</td><td>残留熱除去系ポンプ室空調機 (U41-B105)</td><td>○</td></tr> <tr><td>換気空調系</td><td>高圧炉心注水系ポンプ室空調機 (U41-B106)</td><td>○</td></tr> <tr><td>換気空調系</td><td>高圧炉心注水系ポンプ室空調機 (U41-B107)</td><td>○</td></tr> <tr><td>換気空調系</td><td>非常用ガス処理系室空調機 (U41-B109)</td><td>○</td></tr> <tr><td>換気空調系</td><td>非常用ガス処理系室空調機 (U41-B110)</td><td>○</td></tr> <tr><td>換気空調系</td><td>可燃性ガス濃度制御系可搬式再結合装置室空調機 (U41-B111)</td><td>○</td></tr> </tbody> </table>	系統	設備	蒸気評価	可燃性ガス濃度制御系	可燃性ガス濃度制御系可搬式再結合装置再結合器 (T49-A001B)	○	可燃性ガス濃度制御系	可燃性ガス濃度制御系可搬式再結合装置加熱器 (T49-B001A)	○	可燃性ガス濃度制御系	可燃性ガス濃度制御系可搬式再結合装置加熱器 (T49-B001B)	○	可燃性ガス濃度制御系	可燃性ガス濃度制御系可搬式再結合装置冷却器 (T49-B002A)	○	可燃性ガス濃度制御系	可燃性ガス濃度制御系可搬式再結合装置冷却器 (T49-B002B)	○	可燃性ガス濃度制御系	可燃性ガス濃度制御系可搬式再結合装置ブロワ (T49-C001A)	○	可燃性ガス濃度制御系	可燃性ガス濃度制御系可搬式再結合装置ブロワ (T49-C001B)	○	可燃性ガス濃度制御系	可燃性ガス濃度制御系可搬式再結合装置気水分離器 (T49-D001A)	○	可燃性ガス濃度制御系	可燃性ガス濃度制御系可搬式再結合装置気水分離器 (T49-D001B)	○	可燃性ガス濃度制御系	可燃性ガス濃度制御系弁 (T49-MO-F001A)	○	可燃性ガス濃度制御系	可燃性ガス濃度制御系弁 (T49-MO-F001B)	○	可燃性ガス濃度制御系	可燃性ガス濃度制御系弁 (T49-MO-F002A)	○	可燃性ガス濃度制御系	可燃性ガス濃度制御系弁 (T49-MO-F002B)	○	可燃性ガス濃度制御系	可燃性ガス濃度制御系弁 (T49-MO-F003A)	○	可燃性ガス濃度制御系	可燃性ガス濃度制御系弁 (T49-MO-F003B)	○	可燃性ガス濃度制御系	可燃性ガス濃度制御系弁 (T49-MO-F004A)	○	可燃性ガス濃度制御系	可燃性ガス濃度制御系弁 (T49-MO-F004B)	○	可燃性ガス濃度制御系	可燃性ガス濃度制御系弁 (T49-MO-F006A)	○	可燃性ガス濃度制御系	可燃性ガス濃度制御系弁 (T49-MO-F006B)	○	可燃性ガス濃度制御系	可燃性ガス濃度制御系弁 (T49-MO-F007A)	○	可燃性ガス濃度制御系	可燃性ガス濃度制御系弁 (T49-MO-F007B)	○	可燃性ガス濃度制御系	可燃性ガス濃度制御系弁 (T49-MO-F008A)	○	可燃性ガス濃度制御系	可燃性ガス濃度制御系弁 (T49-MO-F008B)	○	可燃性ガス濃度制御系	可燃性ガス濃度制御系弁 (T49-MO-F010A)	○	可燃性ガス濃度制御系	可燃性ガス濃度制御系弁 (T49-MO-F010B)	○	換気空調系	残留熱除去系ポンプ室空調機 (U41-B103)	○	換気空調系	残留熱除去系ポンプ室空調機 (U41-B104)	○	換気空調系	残留熱除去系ポンプ室空調機 (U41-B105)	○	換気空調系	高圧炉心注水系ポンプ室空調機 (U41-B106)	○	換気空調系	高圧炉心注水系ポンプ室空調機 (U41-B107)	○	換気空調系	非常用ガス処理系室空調機 (U41-B109)	○	換気空調系	非常用ガス処理系室空調機 (U41-B110)	○	換気空調系	可燃性ガス濃度制御系可搬式再結合装置室空調機 (U41-B111)	○				
系統	設備	蒸気評価																																																																																																								
可燃性ガス濃度制御系	可燃性ガス濃度制御系可搬式再結合装置再結合器 (T49-A001B)	○																																																																																																								
可燃性ガス濃度制御系	可燃性ガス濃度制御系可搬式再結合装置加熱器 (T49-B001A)	○																																																																																																								
可燃性ガス濃度制御系	可燃性ガス濃度制御系可搬式再結合装置加熱器 (T49-B001B)	○																																																																																																								
可燃性ガス濃度制御系	可燃性ガス濃度制御系可搬式再結合装置冷却器 (T49-B002A)	○																																																																																																								
可燃性ガス濃度制御系	可燃性ガス濃度制御系可搬式再結合装置冷却器 (T49-B002B)	○																																																																																																								
可燃性ガス濃度制御系	可燃性ガス濃度制御系可搬式再結合装置ブロワ (T49-C001A)	○																																																																																																								
可燃性ガス濃度制御系	可燃性ガス濃度制御系可搬式再結合装置ブロワ (T49-C001B)	○																																																																																																								
可燃性ガス濃度制御系	可燃性ガス濃度制御系可搬式再結合装置気水分離器 (T49-D001A)	○																																																																																																								
可燃性ガス濃度制御系	可燃性ガス濃度制御系可搬式再結合装置気水分離器 (T49-D001B)	○																																																																																																								
可燃性ガス濃度制御系	可燃性ガス濃度制御系弁 (T49-MO-F001A)	○																																																																																																								
可燃性ガス濃度制御系	可燃性ガス濃度制御系弁 (T49-MO-F001B)	○																																																																																																								
可燃性ガス濃度制御系	可燃性ガス濃度制御系弁 (T49-MO-F002A)	○																																																																																																								
可燃性ガス濃度制御系	可燃性ガス濃度制御系弁 (T49-MO-F002B)	○																																																																																																								
可燃性ガス濃度制御系	可燃性ガス濃度制御系弁 (T49-MO-F003A)	○																																																																																																								
可燃性ガス濃度制御系	可燃性ガス濃度制御系弁 (T49-MO-F003B)	○																																																																																																								
可燃性ガス濃度制御系	可燃性ガス濃度制御系弁 (T49-MO-F004A)	○																																																																																																								
可燃性ガス濃度制御系	可燃性ガス濃度制御系弁 (T49-MO-F004B)	○																																																																																																								
可燃性ガス濃度制御系	可燃性ガス濃度制御系弁 (T49-MO-F006A)	○																																																																																																								
可燃性ガス濃度制御系	可燃性ガス濃度制御系弁 (T49-MO-F006B)	○																																																																																																								
可燃性ガス濃度制御系	可燃性ガス濃度制御系弁 (T49-MO-F007A)	○																																																																																																								
可燃性ガス濃度制御系	可燃性ガス濃度制御系弁 (T49-MO-F007B)	○																																																																																																								
可燃性ガス濃度制御系	可燃性ガス濃度制御系弁 (T49-MO-F008A)	○																																																																																																								
可燃性ガス濃度制御系	可燃性ガス濃度制御系弁 (T49-MO-F008B)	○																																																																																																								
可燃性ガス濃度制御系	可燃性ガス濃度制御系弁 (T49-MO-F010A)	○																																																																																																								
可燃性ガス濃度制御系	可燃性ガス濃度制御系弁 (T49-MO-F010B)	○																																																																																																								
換気空調系	残留熱除去系ポンプ室空調機 (U41-B103)	○																																																																																																								
換気空調系	残留熱除去系ポンプ室空調機 (U41-B104)	○																																																																																																								
換気空調系	残留熱除去系ポンプ室空調機 (U41-B105)	○																																																																																																								
換気空調系	高圧炉心注水系ポンプ室空調機 (U41-B106)	○																																																																																																								
換気空調系	高圧炉心注水系ポンプ室空調機 (U41-B107)	○																																																																																																								
換気空調系	非常用ガス処理系室空調機 (U41-B109)	○																																																																																																								
換気空調系	非常用ガス処理系室空調機 (U41-B110)	○																																																																																																								
換気空調系	可燃性ガス濃度制御系可搬式再結合装置室空調機 (U41-B111)	○																																																																																																								

柏崎刈羽原子力発電所 6 / 7号炉 (2017.12.20版)	東海第二発電所 (2018.9.18版)	島根原子力発電所 2号炉	備考															
<p>添付第 5.3-3 表 7 号炉原子炉二次格納施設内防護対象設備の蒸気影響確認結果</p> <table border="1" data-bbox="142 342 893 504"> <thead> <tr> <th>系統</th> <th>設備</th> <th>蒸気評価</th> </tr> </thead> <tbody> <tr> <td>換気空調系</td> <td>可燃性ガス濃度制御系可搬式再結合装置室空調機 (U41-B112)</td> <td>○</td> </tr> <tr> <td>換気空調系</td> <td>燃料プール冷却浄化系ポンプ室空調機 (U41-B113)</td> <td>○</td> </tr> <tr> <td>換気空調系</td> <td>燃料プール冷却浄化系ポンプ室空調機 (U41-B114)</td> <td>○</td> </tr> <tr> <td>換気空調系</td> <td>サブプレッションプール浄化系ポンプ室空調機 (U41-B115)</td> <td>○</td> </tr> </tbody> </table> <p>注 1 : 同種の機能を有する水圧制御ユニットが耐蒸気仕様であることから, 多重性又は多様性を有する系統が同時機能喪失しないと評価。</p> <p>注 2 : フェイルセーフ動作する弁であり, 対象外。</p> <p>注 3 : 蒸気漏洩時に監視および動作が必要な機器ではなく, 蒸気漏洩によって機能喪失しても安全機能に影響はない。</p>	系統	設備	蒸気評価	換気空調系	可燃性ガス濃度制御系可搬式再結合装置室空調機 (U41-B112)	○	換気空調系	燃料プール冷却浄化系ポンプ室空調機 (U41-B113)	○	換気空調系	燃料プール冷却浄化系ポンプ室空調機 (U41-B114)	○	換気空調系	サブプレッションプール浄化系ポンプ室空調機 (U41-B115)	○			
系統	設備	蒸気評価																
換気空調系	可燃性ガス濃度制御系可搬式再結合装置室空調機 (U41-B112)	○																
換気空調系	燃料プール冷却浄化系ポンプ室空調機 (U41-B113)	○																
換気空調系	燃料プール冷却浄化系ポンプ室空調機 (U41-B114)	○																
換気空調系	サブプレッションプール浄化系ポンプ室空調機 (U41-B115)	○																