

島根原子力発電所 2 号炉 審査資料	
資料番号	EP-060(補)改 66(比)
提出年月日	令和 2 年 12 月 17 日

島根原子力発電所 2 号炉

重大事故等対処設備について

補足説明資料

比較表

令和 2 年 12 月

中国電力株式会社

本資料のうち、枠囲みの内容は機密に係る事項のため公開できません。

※：本改訂（改 66）による変更箇所の頁番号に r1 を付しています。

実線・・・設備運用又は体制等の相違（設計方針の相違）
 波線・・・記載表現、設備名称の相違（実質的な相違なし）

まとめ資料比較表 [59条 運転員が原子炉制御室にとどまるための設備]

柏崎刈羽原子力発電所 6 / 7号炉 (2017.12.20 版)	東海第二発電所(2018.9.18 版)	島根原子力発電所 2号炉	備考										
<p>比較表において、相違理由を類型化したものについて以下にまとめて記載する。下記以外の相違については、備考欄に相違理由を記載する。 ただし、59-10については、第26条 原子炉制御室等の別添1を共有しており、類型化相違No.も同資料の相違No.を適用する。</p> <table border="1" data-bbox="264 485 2383 789"> <thead> <tr> <th data-bbox="264 485 439 548">相違No.</th> <th data-bbox="445 485 2383 548">相違理由</th> </tr> </thead> <tbody> <tr> <td data-bbox="264 552 439 611">①</td> <td data-bbox="445 552 2383 611">島根2号炉は、常設空調で中央制御室を正圧化する</td> </tr> <tr> <td data-bbox="264 615 439 674">②</td> <td data-bbox="445 615 2383 674">島根2号炉は、居住性を確保するために必要な容量を有する中央制御室待避室正圧化装置（空気ポンプ）を設置する</td> </tr> <tr> <td data-bbox="264 678 439 737">③</td> <td data-bbox="445 678 2383 737">島根2号炉は、無線通信設備（固定型）を設置</td> </tr> <tr> <td data-bbox="264 741 439 789">④</td> <td data-bbox="445 741 2383 789">島根2号炉の閉止装置はダンパタイプの閉止装置を設置</td> </tr> </tbody> </table>				相違No.	相違理由	①	島根2号炉は、常設空調で中央制御室を正圧化する	②	島根2号炉は、居住性を確保するために必要な容量を有する中央制御室待避室正圧化装置（空気ポンプ）を設置する	③	島根2号炉は、無線通信設備（固定型）を設置	④	島根2号炉の閉止装置はダンパタイプの閉止装置を設置
相違No.	相違理由												
①	島根2号炉は、常設空調で中央制御室を正圧化する												
②	島根2号炉は、居住性を確保するために必要な容量を有する中央制御室待避室正圧化装置（空気ポンプ）を設置する												
③	島根2号炉は、無線通信設備（固定型）を設置												
④	島根2号炉の閉止装置はダンパタイプの閉止装置を設置												

柏崎刈羽原子力発電所 6 / 7号炉 (2017. 12. 20 版)	東海第二発電所 (2018. 9. 18 版)	島根原子力発電所 2号炉	備考
<p style="text-align: center;">59 条 <u>原子炉制御室</u></p> <p style="text-align: center;">目次</p> <p>59-1 SA 設備基準適合性 一覧表</p> <p>59-2 単線結線図</p> <p>59-3 配置図</p> <p>59-4 系統図</p> <p>59-5 試験及び検査</p> <p>59-6 容量設定根拠</p> <p>59-7 保管場所図</p> <p>59-8 アクセスルート図</p> <p>59-9 その他設備</p> <p>59-10 原子炉制御室について (被ばく評価除く)</p> <p>59-11 原子炉制御室の居住性に係る被ばく評価について</p> <p>59-12 非常用ガス処理系に流入する水素濃度について</p> <p>59-13 非常用ガス処理系の系統内における水素の滞留について</p> <p>59-14 <u>各号炉の弁名称及び弁番号</u></p>	<p>59条</p> <p>59-1 SA設備基準適合性 一覧表</p> <p>59-2 単線結線図</p> <p>59-3 配置図</p> <p>59-4 系統図</p> <p>59-5 試験検査</p> <p>59-6 容量設定根拠</p> <p>59-7 保管場所図</p> <p>59-8 アクセスルート</p> <p>59-9 原子炉制御室について (被ばく評価除く)</p> <p>59-10 中央制御室の居住性 (炉心の著しい損傷) に係る被ばく評価について</p> <p>59-11 <u>SAバウンダリ系統図 (参考図)</u></p>	<p>59条 <u>運転員が原子炉制御室にとどまるための設備</u></p> <p style="text-align: center;">目次</p> <p>59-1 SA設備基準適合性 一覧表</p> <p>59-2 単線結線図</p> <p>59-3 配置図</p> <p>59-4 系統図</p> <p>59-5 試験及び検査</p> <p>59-6 容量設定根拠</p> <p>59-7 保管場所図</p> <p>59-8 アクセスルート図</p> <p><u>59-9 その他設備</u></p> <p>59-10 原子炉制御室について (被ばく評価除く)</p> <p>59-11 原子炉制御室の居住性 (炉心の著しい損傷) に係る被ばく評価について</p> <p><u>59-12 非常用ガス処理系に流入する水素濃度について</u></p> <p><u>59-13 非常用ガス処理系の系統内における水素の滞留について</u></p> <p><u>59-14 原子炉建物ブローアウトパネル閉止装置について</u></p>	<p>・自主対策設備の相違</p> <p>【東海第二】</p> <p>島根2号炉は自主対策設備を記載</p> <p>・資料構成の相違</p> <p>【東海第二】</p> <p>島根2号炉は, SGTに流入する水素濃度について評価を実施している</p> <p>・資料構成の相違</p> <p>【東海第二】</p> <p>島根2号炉は, SGT内の水素の滞留について説明している</p> <p>・申請号炉数の相違</p> <p>【柏崎6/7】</p> <p>・資料構成の相違</p> <p>【東海第二】</p> <p>・資料構成の相違</p> <p>【柏崎6/7, 東海第二】</p> <p>島根2号炉は原子炉建物ブローアウトパネル閉止装置について記載</p>

実線・・・設備運用又は体制等の相違（設計方針の相違）
 波線・・・記載表現、設備名称の相違（実質的な相違なし）

まとめ資料比較表 [59条 補足説明資料 59-1 SA設備基準適合性一覧表]

柏崎刈羽原子力発電所 6 / 7号炉 (2017.12.20版)	東海第二発電所 (2018.9.18版)	島根原子力発電所 2号炉	備考
<p style="text-align: center;">59-1</p> <p style="text-align: center;">SA 設備基準適合性 一覧表</p>	<p style="text-align: center;">59-1</p> <p style="text-align: center;">SA 設備基準適合性 一覧表</p>	<p style="text-align: center;">59-1</p> <p style="text-align: center;">SA 設備基準適合性 一覧表</p>	

柏崎刈羽原子力発電所 6 / 7号炉 (2017. 12. 20 版)					東海第二発電所 (2018. 9. 18 版)					島根原子力発電所 2号炉					備考
柏崎刈羽原子力発電所6号及び7号炉 SA設備基準適合性一覧表(常設)					東海第二発電所 SA設備基準適合性 一覧表(常設)					島根原子力発電所2号炉 SA設備基準適合性 一覧表(常設)					
第59条：原子炉制御室					中央制御室遮蔽					中央制御室待避室遮蔽					
環境条件における健全性					環境温度・湿度・圧力/屋外の天候/放射線/荷重					環境温度・湿度・圧力/屋外の天候/放射線/荷重					
第1号					原子炉区域を除く原子炉建屋内及びその他の建屋内(コントロール建屋)					原子炉区域を除く原子炉建屋内及びその他の建屋内(コントロール建屋)					
第2号					(有効に機能を発揮する)					(有効に機能を発揮する)					
第3号					(海水を通過しない)					(海水を通過しない)					
第4号					(周辺機器等からの悪影響を失うおそれがない)					(周辺機器等からの悪影響により機能を失うおそれがない)					
第5号					(電磁波により機能が損なわれない)					(電磁波により機能が損なわれない)					
第6号					【配置図】59-3					【配置図】59-3					
第7号					(操作不要)					(操作不要)					
第8号					—					—					
第9号					試験・検査(検査性、系統構成・外部入力)					遮蔽					
第10号					—					—					
第11号					切り替え性					本来の用途として使用一切替不要					
第12号					—					—					
第13号					系統設計					DB施設と同じ系統構成					
第14号					その他(飛散物)					(考慮対象なし)					
第15号					—					—					
第16号					設置場所					(操作不要)					
第17号					—					—					
第18号					常設SAの容量					DB施設の系統及び機器の容量が十分(D B施設と同仕様の遮蔽能力で設計)					
第19号					—					—					
第20号					共用の禁止					共用する設備					
第21号					—					—					
第22号					共通要因					環境条件、自然現象、外部人為事象、溢水、火災					
第23号					サポート系故障					(サポート系なし)					
第24号					—					—					
第25号					—					—					
第26号					—					—					
第27号					—					—					
第28号					—					—					
第29号					—					—					
第30号					—					—					
第31号					—					—					
第32号					—					—					
第33号					—					—					
第34号					—					—					
第35号					—					—					
第36号					—					—					
第37号					—					—					
第38号					—					—					
第39号					—					—					
第40号					—					—					
第41号					—					—					
第42号					—					—					
第43号					—					—					
第44号					—					—					
第45号					—					—					
第46号					—					—					
第47号					—					—					
第48号					—					—					
第49号					—					—					
第50号					—					—					
第51号					—					—					
第52号					—					—					
第53号					—					—					
第54号					—					—					
第55号					—					—					
第56号					—					—					
第57号					—					—					
第58号					—					—					
第59号					—					—					
第60号					—					—					
第61号					—					—					
第62号					—					—					
第63号					—					—					
第64号					—					—					
第65号					—					—					
第66号					—					—					
第67号					—					—					
第68号					—					—					
第69号					—					—					
第70号					—					—					
第71号					—					—					
第72号					—					—					
第73号					—					—					
第74号					—					—					
第75号					—					—					
第76号					—					—					
第77号					—					—					
第78号					—					—					
第79号					—					—					
第80号					—					—					
第81号					—					—					
第82号					—					—					
第83号					—					—					
第84号					—					—					
第85号					—					—					
第86号					—					—					
第87号					—					—					
第88号					—					—					
第89号					—					—					
第90号					—					—					
第91号					—					—					
第92号					—					—					
第93号					—					—					
第94号					—					—					
第95号					—					—					
第96号					—					—					
第97号					—					—					
第98号					—					—					
第99号					—					—					
第100号					—					—					
第101号					—					—					
第102号					—					—					
第103号					—					—					
第104号					—					—					
第105号					—					—					
第106号					—					—					
第107号					—					—					
第108号					—					—					
第109号					—					—					
第110号					—					—					
第111号					—					—					
第112号					—					—					
第113号					—					—					
第114号					—					—					
第115号					—					—					
第116号					—					—					
第117号					—					—					
第118号					—					—					
第119号					—					—					
第120号					—					—					
第121号					—					—					
第122号					—					—					
第123号					—					—					
第124号					—					—					
第125号					—					—					
第126号					—					—					
第127号					—					—					
第128号					—					—					
第129号					—					—					
第130号					—					—					
第131号					—					—					
第132号					—					—					
第133号					—					—					
第134号					—					—					
第135号					—					—					
第136号					—					—					
第137号					—					—					
第138号					—					—					
第139号					—					—					
第140号					—					—					
第141号					—					—					
第142号					—					—					
第143号					—					—					
第144号					—					—					
第145号					—					—					
第146号					—					—					
第147号					—					—					
第148号					—					—					
第149号					—					—					
第150号					—					—					
第151号					—					—					
第152号					—					—					
第153号					—					—					
第154号					—					—					
第155号					—					—					
第156号					—					—					
第157号					—					—					
第158号					—					—					
第159号					—					—					
第160号					—					—					
第161号					—					—					
第162号					—					—					
第163号					—					—					
第164号					—					—					
第165号					—					—					
第166号					—					—					
第167号					—					—					
第168号					—					—					
第169号					—					—					
第170号					—					—					
第171号					—					—					
第172号					—					—					
第173号					—					—					
第174号					—					—					
第175号					—					—					
第176号					—					—					
第177号					—					—					
第178号					—					—					
第179号					—					—					
第180号					—					—					
第181号					—					—					
第182号					—					—					
第183号					—					—					
第184号					—					—					
第185号					—					—					
第186号					—					—					
第187号					—					—					
第188号					—					—					
第189号					—					—					
第190号					—					—					
第191号					—					—					
第192号					—					—					
第193号					—					—					
第194号					—					—					
第195号					—					—					
第196号					—					—					
第197号					—					—					
第198号					—					—					
第199号					—					—					
第200号					—					—					
第201号					—					—					
第202号					—					—					
第203号					—					—					
第204号					—					—					
第205号					—					—					
第206号					—					—					
第207号					—					—					
第208号					—					—					
第209号					—					—					
第210号					—					—					
第211号					—					—					
第212号					—					—					
第213号					—					—					
第214号					—					—					
第215号					—					—					
第216号					—					—					
第217号					—					—					
第218号					—					—					
第219号					—					—					
第220号					—					—					
第221号					—					—					
第222号					—					—					
第223号					—					—					
第224号					—					—					
第225号					—					—					
第226号					—					—					
第227号					—					—					
第228号					—					—					
第229号					—					—					
第230号					—					—					
第231号					—					—					
第232号					—					—					
第233号					—					—					
第234号					—					—					
第235号					—					—					
第236号					—					—					
第237号					—					—					
第238号					—					—					
第239号					—					—					
第240号					—					—					
第241号					—					—					
第242号					—					—					
第243号					—					—					
第244号					—					—					
第245号					—					—					
第246号					—					—					
第247号					—					—					
第248号					—					—					
第249号					—					—					
第250号					—					—					
第251号					—					—					
第252号					—					—					
第253号					—					—					
第254号					—					—					
第255号					—					—					
第256号					—					—					
第257号					—					—					
第258号					—					—					
第259号					—					—					

柏崎刈羽原子力発電所 6 / 7号炉 (2017. 12. 20 版)					東海第二発電所 (2018. 9. 18 版)					島根原子力発電所 2号炉					備考
柏崎刈羽原子力発電所6号及び7号炉 SA設備基準適合性一覧表(常設)					東海第二発電所 SA設備基準適合性 一覧表(常設)					島根原子力発電所2号炉 SA設備基準適合性 一覧表(常設)					
第59条：原子炉制御室					中央制御室遮蔽					中央制御室待避室遮蔽					
環境条件における健全性					環境温度・湿度・圧力/屋外の天候/放射線					環境温度・湿度・圧力/屋外の天候/放射線					
第1号					原子炉区域を除く原子炉建屋内及びその他の建屋内(コントロール建屋)					原子炉区域を除く原子炉建屋内及びその他の建屋内(コントロール建屋)					
荷重					(有効に機能を発揮する)					(有効に機能を発揮する)					
海水					(海水を通水しない)					(海水を通水しない)					
他設備からの影響					(周辺機器等からの悪影響により機能を失うおそれがない)					(周辺機器等からの悪影響により機能を失うおそれがない)					
電磁波による影響					(電磁波により機能が損なわれない)					(電磁波により機能が損なわれない)					
関連資料					【配置図】59-3					【配置図】59-3					
第2号					操作性					(操作不要)					
関連資料					—					—					
第3号					試験・検査(検査性、系統構成・外部入力)					遮蔽					
関連資料					—					—					
第4号					切り替え性					本来の用途として使用一切替不要					
関連資料					—					—					
第5号					系統設計					D B施設と同じ系統構成					
遮蔽防止					その他(飛散物)					(考慮対象なし)					
関連資料					—					—					
第6号					設置場所					(操作不要)					
関連資料					—					—					
第1項					常設SAの容量					設計基準対象施設及び機器を使用するもの必要な容量等に対して十分であるもの					
関連資料					—					—					
第2項					共用の禁止					共用しない設備					
関連資料					—					—					
第3項					共通要因故障防止					環境条件、自然現象、外部人為事象、溢水、火災					
関連資料					—					—					
第1号					常設SAの容量					D B施設の系統及び機器の容量が1分(D B施設と同仕様の遮蔽能力で設計)					
関連資料					【被ばく評価】59-11					【被ばく評価】59-11					
第2号					共用の禁止					共用する設備					
関連資料					—					—					
第3号					共通要因故障防止					環境条件、自然現象、外部人為事象、溢水、火災					
関連資料					【配置図】59-3					【配置図】59-3					

東海第二発電所 SA 設備基準適合性 一覧表 (常設)

島根原子力発電所 2号炉 SA 設備基準適合性 一覧表 (常設)

・設備及び運用の相違
【柏崎 6/7】
島根 2号炉は、常設空調
で中央制御室を正圧化
する (以下、①の相違)

第59条:運転員が原子炉制御室にとどまるための設備		中央制御室換気系 空調和機ファン	類型化 区分	中央制御室換気系 フィルタ系ファン	類型化 区分	
第1項	環境条件における健全性	環境温度・環境圧力・湿度/屋外の天候/放射線/荷重	原子炉建屋原子炉棟外	原子炉建屋原子炉棟外	C	
		海水	海水を通水しない	対象外	海水を通水しない	対象外
		周辺機器等からの悪影響	(周辺機器等からの悪影響により機能を失うおそれがない)	—	(周辺機器等からの悪影響により機能を失うおそれがない)	—
		電磁的障害	(電磁波の影響を受けない)	—	(電磁波の影響を受けない)	—
		関連資料	59-3 配置図	—	59-3 配置図	—
	第2項	操作性	中央制御室操作	A	中央制御室操作	A
		関連資料	—	—	—	—
		試験・検査 (検査性、系統構成・外部入力)	ファン	A	ファン	A
		関連資料	59-5 試験検査	—	59-5 試験検査	—
		切替性	本来の用途として使用する	対象外	本来の用途として使用する	対象外
第3項	悪影響防止	系統設計	DB施設と同じ系統構成	A d	DB施設と同じ系統構成	A d
		その他 (飛散物)	その他設備	対象外	その他設備	対象外
	関連資料	59-4 系統図	—	59-4 系統図	—	
	設置場所	中央制御室操作	B	中央制御室操作	B	
	関連資料	—	—	—	—	
	共通要因故障防止	環境条件、自然現象、外部人為事象、溢水、火災	位置的分散を考慮すべきDB設備等がない	対象外	位置的分散を考慮すべきDB設備等がない	対象外
第2項	常設 SA の容量	設計基準対象施設の系統及び機器を使用するもの必要な容量等に対して十分であるもの	B	設計基準対象施設の系統及び機器を使用するもの必要な容量等に対して十分であるもの	B	
		関連資料	—	—	—	
	共用の禁止	共用しない設備	対象外	共用しない設備	対象外	
第3項	共通要因故障防止	サポート系による要因	異なる駆動源又は冷却源	B a	異なる駆動源又は冷却源	B a
		関連資料	—	—	—	

第59条:運転員が原子炉制御室にとどまるための設備		再循環用ファン	類型化 区分	
第1項	環境条件における健全性	環境温度・湿度・圧力/屋外の天候/放射線	その他の建物内設備 (廃棄物処理建物)	C
		荷重	(有効に機能を発揮する)	—
		海水	海水を通水しない	対象外
		周辺機器等からの悪影響	(周辺機器等からの悪影響により機能を失うおそれがない)	—
		電磁波による影響	(電磁波により機能が損なわれない)	対象外
	関連資料	[配置図] 59-3	—	
	第2項	操作性	中央制御室操作 (操作スイッチ操作)	A
		関連資料	[配置図] 59-3	—
		試験・検査 (検査性、系統構成・外部入力)	ファン (機能・性能試験) (外観の確認が可能)	A
		関連資料	[試験及び検査]59-5	—
切替性		本来の用途として使用一切替操作が必要	B a	
第3項	悪影響防止	系統設計	弁等の操作で系統構成	A a
		その他 (飛散物)	高速回転機器	B b
	関連資料	[系統図]59-4	—	
	設置場所	中央制御室操作	B	
	関連資料	—	—	
	共通要因故障防止	環境条件、自然現象、外部人為事象、溢水、火災	防止設備-対象 (代替対象DB設備あり) - 屋内	A a
第2項	常設 SA の容量	設計基準対象施設の系統及び機器の容量等が十分	B	
		関連資料	[被ばく評価]59-11	—
	共用の禁止	共用しない設備	対象外	
第3項	共通要因故障防止	サポート系故障	対象 (サポート系あり) - 異なる駆動源又は冷却源	C a
		関連資料	[単線結線図]59-2	—

東海第二発電所 SA 設備基準適合性 一覧表 (常設)

島根原子力発電所 2号炉 SA 設備基準適合性 一覧表 (常設)

・設備の相違
【柏崎 6/7, 東海第二】

第59条:運転員が原子炉制御室にとどまるための設備		中央制御室換気系 空気調和機ファン	類型化 区分	中央制御室換気系 フィルタ系ファン	類型化 区分	
第1項	環境条件における健全性	環境温度・環境圧力・湿度/屋外の天候/放射線/荷重	原子炉建屋原子炉棟外	C	原子炉建屋原子炉棟外	C
		海水	海水を通過しない	対象外	海水を通過しない	対象外
		周辺機器等からの悪影響	(周辺機器等からの悪影響により機能を失うおそれがない)	—	(周辺機器等からの悪影響により機能を失うおそれがない)	—
		電磁的障害	(電磁波の影響を受けない)	—	(電磁波の影響を受けない)	—
		関連資料	59-3 配置図		59-3 配置図	
	第2項	操作性	中央制御室操作	A	中央制御室操作	A
		関連資料	—		—	
		試験・検査 (検査性、系統構成・外部入力)	ファン	A	ファン	A
		関連資料	59-5 試験検査		59-5 試験検査	
		切替性	本来の用途として使用する	対象外	本来の用途として使用する	対象外
第43条	悪影響防止	系統設計	D B施設と同じ系統構成	A d	D B施設と同じ系統構成	A d
		その他(飛散物)	その他設備	対象外	その他設備	対象外
		関連資料	59-4 系統図		59-4 系統図	
		設置場所	中央制御室操作	B	中央制御室操作	B
		関連資料	—		—	
	第2項	常設 SA の容量	設計基準対象施設の系統及び機器を使用するもの必要な容量等に対して十分であるもの	B	設計基準対象施設の系統及び機器を使用するもの必要な容量等に対して十分であるもの	B
		関連資料	—		—	
		共用の禁止	共用しない設備	対象外	共用しない設備	対象外
		関連資料	—		—	
		共通要因故障防止	環境条件、自然現象、外部人為事象、溢水、火災	位置的分散を考慮すべき D B 設備等がない	対象外	位置的分散を考慮すべき D B 設備等がない
第3項	サポート系による要因	異なる駆動源又は冷却源	B a	異なる駆動源又は冷却源	B a	
	関連資料	—		—		

第59条:運転員が原子炉制御室にとどまるための設備		チャコール・フィルタ・ブースタ・ファン	類型化 区分	
第1項	環境条件における健全性	環境温度・湿度・圧力/屋外の天候/放射線	その他の建物内設備 (廃棄物処理建物)	C
		荷重	(有効に機能を発揮する)	—
		海水	海水を通過しない	対象外
		周辺機器等からの悪影響	(周辺機器等からの悪影響により機能を失うおそれがない)	—
		電磁波による影響	(電磁波により機能が損なわれない)	対象外
	関連資料	[配置図] 59-3		
	第2項	操作性	中央制御室操作 (操作スイッチ操作)	A
		関連資料	[配置図] 59-3	
		試験・検査 (検査性、系統構成・外部入力)	ファン	A
		関連資料	[試験及び検査] 59-5	
切り替え性		本来の用途として使用一切替操作が必要	B a	
第43条	悪影響防止	系統設計	弁等の操作で系統構成	A a
		その他(飛散物)	高速回転機器	B b
		関連資料	[系統図] 59-4	
		設置場所	中央制御室操作	B
		関連資料	—	
	第2項	常設 SA の容量	設計基準対象施設の系統及び機器の容量等が十分	B
		関連資料	[被ばく評価] 59-11	
		共用の禁止	共用しない設備	対象外
		関連資料	—	
		共通要因故障防止	環境条件、自然現象、外部人為事象、溢水、火災	防止設備-対象 (代替対象 D B 設備あり) - 屋内
第3項	サポート系故障	対象 (サポート系あり) - 異なる駆動源又は冷却源	C a	
	関連資料	[単線結線図] 59-2		

東海第二発電所 SA 設備基準適合性 一覧表 (常設)

島根原子力発電所 2号炉 SA 設備基準適合性 一覧表 (常設)

・設備の相違
【柏崎 6/7, 東海第二】

第59条:運転員が原子炉制御室にとどまるための設備		中央制御室換気系 フィルタユニット	類型化 区分	ブローアウトパネル閉止装置	類型化 区分		
第1項	環境条件における健全性	環境温度・環境圧力・湿度/屋外の天候/放射線/荷重	原子炉建屋原子炉棟外	C	屋外	D	
		海水	海水を通過しない	対象外	海水を通過しない	対象外	
		周辺機器等からの悪影響	(周辺機器等からの悪影響により機能を失うおそれがない)	—	(周辺機器等からの悪影響により機能を失うおそれがない)	—	
		電磁的障害	(電磁波の影響を受けない)	—	(電磁波の影響を受けない)	—	
		関連資料	59-3 配置図	—	59-3 配置図	—	
	第2項	操作性	操作不要	対象外	中央制御室操作	A	
		関連資料	—	—	59-3 配置図	—	
		試験・検査 (検査性、系統構成・外部入力)	空調ユニット	E	その他	M	
		関連資料	59-5 試験検査	—	—	—	
		切替性	本来の用途として使用する	対象外	本来の用途として使用する	対象外	
第3項	悪影響防止	系統設計	DB施設と同じ系統構成	A d	他設備から独立	A c	
		その他(飛散物)	その他設備	対象外	その他設備	対象外	
	関連資料	59-4 系統図	—	59-4 系統図	—		
	設置場所	操作不要	対象外	中央制御室操作	B		
	関連資料	—	—	—	—		
第4項	第1号	常設 SA の容量	設計基準対象施設の系統及び機器を使用するもの 必要な容量等に対して十分であるもの	B	重大事故等への対処を本来の目的として設置するもの	A	
		関連資料	—	—	—	—	
	第2号	共用の禁止	共用しない設備	対象外	共用しない設備	対象外	
		関連資料	—	—	—	—	
	第3号	共通要因故障防止	環境条件、自然現象、外部人為事象、溢水、火災	位置的分散を考慮すべきDB設備等がない	対象外	位置的分散を考慮すべきDB設備等がない	対象外
		関連資料	—	—	—	—	

第59条:運転員が原子炉制御室にとどまるための設備		非常用チャコール・フィルタ・ユニット	類型化 区分		
第1項	環境条件における健全性	環境温度・湿度・圧力/屋外の天候/放射線	その他の建物内設備 (廃棄物処理建物)	C	
		荷重	(有効に機能を発揮する)	—	
		海水	海水を通過しない	対象外	
		周辺機器等からの悪影響	(周辺機器等からの悪影響により機能を失うおそれがない)	—	
		電磁波による影響	(電磁波により機能が損なわれない)	対象外	
	第2項	操作性	操作不要	—	
		関連資料	[配置図] 59-3	—	
		試験・検査 (検査性、系統構成・外部入力)	空調ユニット	E	
		関連資料	[試験及び検査]59-5	—	
		切替性	本来の用途として使用一切替操作が必要	B a	
第3項	第1号	常設 SA の容量	設計基準対象施設の系統及び機器の容量等 が十分	B	
		関連資料	[被ばく評価]59-11	—	
	第2号	共用の禁止	共用しない設備	対象外	
		関連資料	—	—	
	第3号	共通要因故障防止	環境条件、自然現象、外部人為事象、溢水、火災	防止設備-対象外(共通要因の考慮対象設備なし)	対象外
		関連資料	—	—	

島根原子力発電所2号炉 SA 設備基準適合性 一覧表 (常設)

第59条: 運転員が原子炉制御室にとどまるための設備		差圧計	類型化区分		
第1項	第1号	環境温度・湿度・圧力／ 屋外の天候／放射線	その他の建物内設備 (制御室建物)	C	
		荷重	(有効に機能を発揮する)	—	
		海水	海水を通水しない	対象外	
		周辺機器等からの悪影響	(周辺機器等からの悪影響により機能を失うおそれがない)	—	
		電磁波	(電磁波により機能が損なわれない)	対象外	
		関連資料	[配置図]59-3		
第43条	第2号	操作性	操作不要	—	
		関連資料	—		
	第3号	試験・検査 (検査性、系統構成・外部入力)	計測制御設備	J	
		関連資料	—		
	第4号	切り替え性	本来の用途として使用一切替不要	B b	
		関連資料	—		
第5号	悪影響防止	系統設計	他設備から独立	A c	
		その他 (飛散物)	対象外	対象外	
		関連資料	—		
第6号	設置場所	対象外 (操作不要)	対象外		
	関連資料	[配置図]59-3			
第2項	第1号	常設 SA の容量	重大事故等への対処を本来の目的として使用するもの	A	
		関連資料	—		
	第2号	共用の禁止	共用しない	対象外	
		関連資料	—		
	第3号	共通要因故障防止	環境条件、自然現象、外部人為事象、溢水、火災	緩和設備又は防止でも緩和でもない設備 - 対象 (同一目的の SA 設備なし)	対象外
			サポート系要因	対象外 (サポート系なし)	—
関連資料			—		

・設計方針の相違
【柏崎 6/7】
島根 2号炉は、常設の差圧計を使用
・設備及び運用の相違
【東海第二】
①の相違

柏崎刈羽原子力発電所 6 / 7号炉 (2017. 12. 20 版)		東海第二発電所 (2018. 9. 18 版)		島根原子力発電所 2号炉		備考
柏崎刈羽原子力発電所6号及び7号炉 SA設備基準適合性一覽表 (常設)						
第59条: 原子炉制御室						
無線連絡設備 (常設)		類型化区分	衛星電話設備 (常設)		類型化区分	
第1号	環境温度・湿度・圧力/屋外の天候/放射線	原子炉区域を除く原子炉建屋内及びその他の建屋内 (コントロール建屋)	C	原子炉区域を除く原子炉建屋内及びその他の建屋内 (コントロール建屋)	C	
第1号	荷重	(有効に機能を発揮する)	-	(有効に機能を発揮する)	-	
第1号	海水	(海水を通過しない)	対象外	(海水を通過しない)	対象外	
第1号	他設備からの影響	(周辺機器等からの影響により機能を失うおそれがない)	-	(周辺機器等からの影響により機能を失うおそれがない)	-	
第1号	電磁波による影響	(電磁波により機能が損なわれない)	対象外	(電磁波により機能が損なわれない)	対象外	
第1号	関連資料	[配置図] 59-3		[配置図] 59-3		
第2号	操作性	中央制御室操作	A	中央制御室操作	A	
第2号	関連資料	[配置図] 59-3		[配置図] 59-3		
第3号	試験・検査 (検査性、系統構成・外部入力)	通信連絡設備	L	通信連絡設備	L	
第3号	関連資料	[試験及び検査] 59-5		[試験及び検査] 59-5		
第4号	切り替え性	本来の用途として使用一切替必要	B a	本来の用途として使用一切替必要	B a	
第4号	関連資料	[系統図] 59-4		[系統図] 59-4		
第5号	系統設計	DB施設と同じ系統構成	A d	DB施設と同じ系統構成	A d	
第5号	その他(飛散物)	(考慮対象なし)	対象外	(考慮対象なし)	対象外	
第5号	関連資料	[配置図] 59-3		[配置図] 59-3		
第5号	関連資料	[系統図] 59-4		[系統図] 59-4		
第6号	設置場所	中央制御室操作	B	中央制御室操作	B	
第6号	関連資料	[配置図] 59-3		[配置図] 59-3		
第6号	関連資料	[系統図] 59-4		[系統図] 59-4		
第1号	常設SAの容量	DB施設の系統及び機器の容量が十分 (DB施設と同仕様の通信機器で設計)	B	DB施設の系統及び機器の容量が十分 (DB施設と同仕様の通信機器で設計)	B	
第1号	関連資料	-		-		
第2号	共用の禁止	(共用しない設備)	対象外	(共用しない設備)	対象外	
第2号	関連資料	-		-		
第3号	共通要因 (環境条件、自然現象、外部人為事象、漏水、火災)	防止設備-対象(代替対象DB設備有り)-屋内 (設計基準対象設備の通信連絡設備と位置的分散)	A a	防止設備-対象(代替対象DB設備有り)-屋内 (設計基準対象設備の通信連絡設備と位置的分散)	A a	
第3号	サポート系故障	(サポート系なし)	対象外	(サポート系なし)	対象外	
第3号	関連資料	[配置図] 59-3		[配置図] 59-3		

島根原子力発電所 2号炉 SA設備基準適合性一覽表 (常設)		無線通信設備 (固定型)		類型化区分
第59条: 運転員が原子炉制御室にとどまるための設備				
第1号	健全性	環境温度・湿度・圧力/屋外の天候/放射線	その他の建物内設備 (原子炉建物の二次格納施設外及び廃棄物処理建物)	C
第1号	健全性	荷重	(有効に機能を発揮する)	-
第1号	健全性	海水	海水を通過しない	対象外
第1号	健全性	周辺機器等からの悪影響	(周辺機器等からの悪影響により機能を失うおそれがない)	-
第1号	健全性	電磁波	(電磁波により機能が損なわれない)	対象外
第1号	健全性	関連資料	[配置図] 59-3	
第2号	操作性	操作性	中央制御室操作 (操作スイッチ操作)	A
第2号	関連資料	[配置図] 59-3		
第3号	試験・検査 (検査性、系統構成・外部入力)	通信連絡設備	通信連絡設備 (機能・性能検査が可能) (特性検査が可能)	L
第3号	関連資料	[試験及び検査] 59-5		
第4号	切り替え性	本来の用途として使用一切替不要	本来の用途として使用一切替不要	B b
第4号	関連資料	[系統図] 59-4		
第5号	悪影響防止	系統設計	DB施設と同様の系統構成 (設計基準対象施設として使用する場合と同じ系統構成)	A d
第5号	悪影響防止	その他(飛散物)	(考慮対象なし)	対象外
第5号	悪影響防止	関連資料	[配置図] 59-3, [系統図] 59-4	
第6号	設置場所	設置場所	中央制御室操作	B
第6号	関連資料	[配置図] 59-3, [系統図] 59-4		
第1号	常設SAの容量	常設SAの容量	DB施設の系統及び機器の容量が十分 (DB施設と同仕様の通信機器で設計)	B
第1号	関連資料	-		
第2号	共用の禁止	共用の禁止	共用しない設備	対象外
第2号	関連資料	-		
第3号	共通要因 (環境条件、自然現象、外部人為事象、漏水、火災)	環境条件、自然現象、外部人為事象、漏水、火災	緩和設備又は防止でも緩和でもない設備-対象 (同一目的のSA設備あり)	B
第3号	共通要因 (サポート系故障)	サポート系要因	対象外 (サポート系なし)	-
第3号	共通要因	関連資料	[配置図] 59-3	

柏崎刈羽原子力発電所 6 / 7号炉 (2017. 12. 20 版)					東海第二発電所 (2018. 9. 18 版)					島根原子力発電所 2号炉					備考	
柏崎刈羽原子力発電所6号及び7号炉 SA設備基準適合性一覧表 (常設)					東海第二発電所 SA設備基準適合性 一覧表 (可搬型)					島根原子力発電所2号炉 SA設備基準適合性 一覧表 (常設)					・設備の相違 【東海第二】 島根2号炉の衛星電話 設備は常設	
59条：原子炉制御室		無線連絡設備 (常設)		類型化区分	衛星電話設備 (常設)		類型化区分	第59条：運転員が原子炉制御室にとどまるための設備		衛星電話設備 (固定型)		類型化区分				
第1項	環境条件における健全性	環境温度・湿度・圧力／屋外の天候／放射線	原子炉区域を除く原子炉建屋内及びその他の建屋内 (コントロール建屋)	C	原子炉区域を除く原子炉建屋内及びその他の建屋内 (コントロール建屋)	C	原子炉建屋原子炉棟外	C	健全性 環境条件における健全性	環境温度・湿度・圧力／屋外の天候／放射線	原子炉建物の二次格納施設外及びその他の建物 (廃棄物処理建物)	C	第1項	C		
		荷重	(有効に機能を発揮する)	—	(有効に機能を発揮する)	—	海水	海水を通過しない		対象外	荷重	(有効に機能を発揮する)			—	
		海水	(海水を通過しない)	対象外	(海水を通過しない)	対象外	周辺機器等からの悪影響	(周辺機器等からの悪影響により機能を失うおそれがない)		—	海水	海水を通過しない			対象外	
		他設備からの影響	(周辺機器等からの悪影響により機能を失うおそれがない)	—	(周辺機器等からの悪影響により機能を失うおそれがない)	—	電磁的障害	(電磁波の影響を受けない)		—	電磁波	(電磁波により機能が損なわれない)			—	
		電磁波による影響	(電磁波により機能が損なわれない)	対象外	(電磁波により機能が損なわれない)	対象外	関連資料	59-3 配置図		—	周辺機器等からの悪影響	(周辺機器等からの悪影響により機能を失うおそれがない)			—	
		関連資料	[配置図] 59-3	—	[配置図] 59-3	—	関連資料	59-3 配置図		—	関連資料	[配置図] 59-3			—	
		操作性	中央制御室操作	A	中央制御室操作	A	操作性	中央制御室操作		A	操作性	中央制御室操作 (操作スイッチ操作)			A	
		関連資料	[配置図] 59-3	—	[配置図] 59-3	—	関連資料	59-3 配置図, 59-4 系統図		—	関連資料	[配置図] 59-3			—	
		試験・検査 (検査性、系統構成・外部入力)	通信連絡設備	L	通信連絡設備	L	試験・検査 (検査性、系統構成・外部入力)	通信連絡設備		L	試験・検査 (検査性、系統構成・外部入力)	通信連絡設備 (機能・性能検査が可能) (特性検査が可能)			L	
		関連資料	[試験及び検査] 59-5	—	[試験及び検査] 59-5	—	関連資料	59-5 試験検査		—	関連資料	[試験及び検査] 59-5			—	
第2項	悪影響防止	切り替え性	本来の用途として使用一切必要	B a	本来の用途として使用一切必要	B a	切り替え性	本来の用途として使用する	対象外	切り替え性	本来の用途として使用一切不要	B b	第2項	B b		
		関連資料	[系統図] 59-4	—	[系統図] 59-4	—	悪影響防止	系統設計	通常待機時は隔離又は分離	A b	悪影響防止	系統設計 (設計基準対象施設として使用する場合と同じ系統構成)			A d	
		系統設計	D B施設と同じ系統構成	A d	D B施設と同じ系統構成	A d	悪影響防止	その他 (飛散物)	その他設備	対象外	悪影響防止	その他 (飛散物) (考慮対象なし)			対象外	
		その他 (飛散物)	(考慮対象なし)	対象外	(考慮対象なし)	対象外	悪影響防止	設置場所	中央制御室操作	B	悪影響防止	関連資料			[配置図] 59-3, [系統図] 59-4	
		関連資料	[試験及び検査] 59-5	—	[試験及び検査] 59-5	—	悪影響防止	可搬 S A の容量	その他設備	C	悪影響防止	関連資料			[配置図] 59-3, [系統図] 59-4	
		設置場所	中央制御室操作	B	中央制御室操作	B	悪影響防止	可搬 S A の接続性	簡便な接続規格等による接続	C	悪影響防止	設置場所			現場 (設置場所) で操作可能	A a
		関連資料	[配置図] 59-3 [系統図] 59-4	—	[配置図] 59-3 [系統図] 59-4	—	悪影響防止	異なる複数の接続箇所との確保	(対象外)	対象外	悪影響防止	関連資料			[配置図] 59-3, [系統図] 59-4	
		常設SAの容量	D B施設の系統及び機器の容量が十分 (D B施設と同じ様の通信機器で設計)	B	D B施設の系統及び機器の容量が十分 (D B施設と同じ様の通信機器で設計)	B	悪影響防止	設置場所	(線量の高くなるおそれの少ない場所を選定)	—	悪影響防止	常設 SA の容量			D B施設の系統及び機器の容量が十分 (D B施設と同じ様の通信機器で設計)	B
		関連資料	—	—	—	—	悪影響防止	関連資料	59-3 配置図	—	悪影響防止	関連資料			—	
		共用の禁止	(共用しない設備)	対象外	(共用しない設備)	対象外	悪影響防止	保管場所	屋内	A a	悪影響防止	共用の禁止			共用しない設備	対象外
第3項	共通要因故障防止	共通要因故障防止	防止設備-対象 (代替対象 D B設備有り)-屋内 (設計基準対象設備の通信連絡設備と位置的分散)	A a	防止設備-対象 (代替対象 D B設備有り)-屋内 (設計基準対象設備の通信連絡設備と位置的分散)	A a	共通要因故障防止	環境条件、自然現象、外部人為事象、溢水、火災	屋内	A a	共通要因故障防止	環境条件、自然現象、外部人為事象、溢水、火災	緩和設備でも防止設備でもない設備-対象 (同一目的の常設重大事故等対処設備あり)	B	第3項	B
		共通要因故障防止	(サポート系なし)	対象外	(サポート系なし)	対象外	共通要因故障防止	サポート系による要因	異なる駆動源又は冷却源	B a	共通要因故障防止	サポート系要因	対象外 (サポート系なし)	—		
		関連資料	[配置図] 59-3	—	[配置図] 59-3	—	共通要因故障防止	関連資料	59-3 配置図	—	共通要因故障防止	関連資料	[配置図] 59-3	—		

柏崎刈羽原子力発電所 6/7号炉 (2017.12.20版)		東海第二発電所 (2018.9.18版)		島根原子力発電所 2号炉		備考																																																																																																																																																																																																																																																																																																																																																																																																																							
柏崎刈羽原子力発電所6号及び7号炉 SA設備基準適合性一覽表 (常設)		東海第二発電所 SA設備基準適合性一覽表 (可搬型)		島根原子力発電所2号炉 SA設備基準適合性一覽表 (可搬)		・設計方針の相違 【柏崎6/7】 島根2号炉のプラント パラメータ監視装置は、 可搬型																																																																																																																																																																																																																																																																																																																																																																																																																							
<table border="1"> <tr> <td colspan="2">59条: 原子炉制御室</td> <td colspan="2">データ表示装置 (待避室)</td> <td colspan="2">類型化区分</td> </tr> <tr> <td rowspan="10">第1項</td> <td rowspan="5">環境条件における健全性</td> <td>環境温度・湿度・圧力/屋外の天候/放射線</td> <td>原子炉建屋原子炉棟外</td> <td colspan="2">C</td> </tr> <tr> <td>荷重</td> <td>海水を漏水しない</td> <td colspan="2">対象外</td> </tr> <tr> <td>海水</td> <td>(有効に機能を発揮する)</td> <td colspan="2">—</td> </tr> <tr> <td>他設備からの影響</td> <td>(周辺機器等からの悪影響により機能を失うおそれがない)</td> <td colspan="2">—</td> </tr> <tr> <td>電磁波による影響</td> <td>(電磁波により機能が損なわれない)</td> <td colspan="2">対象外</td> </tr> <tr> <td rowspan="5">第2項</td> <td colspan="2">関連資料</td> <td colspan="2">[配置図] 59-3</td> <td></td> </tr> <tr> <td>操作性</td> <td>中央制御室操作 (操作スイッチ操作)</td> <td colspan="2">A</td> </tr> <tr> <td colspan="2">関連資料</td> <td colspan="2">[配置図] 59-3</td> <td></td> </tr> <tr> <td>試験・検査 (検査性、系統構成・外部入力)</td> <td>通信連絡設備</td> <td colspan="2">L</td> </tr> <tr> <td colspan="2">関連資料</td> <td colspan="2">[試験及び検査] 59-5</td> <td></td> </tr> <tr> <td rowspan="3">第43条</td> <td>切り替え性</td> <td>常時接続-切替不要</td> <td colspan="2">B b</td> </tr> <tr> <td colspan="2">関連資料</td> <td colspan="2">—</td> </tr> <tr> <td rowspan="2">悪影響防止</td> <td>系統設計</td> <td>DB施設と同じ系統構成</td> <td colspan="2">A d</td> </tr> <tr> <td>その他(飛散物)</td> <td>(考慮対象なし)</td> <td colspan="2">対象外</td> </tr> <tr> <td colspan="2">関連資料</td> <td colspan="2">[配置図] 59-3 [系統図] 59-4</td> <td></td> </tr> <tr> <td rowspan="3">第2項</td> <td>設置場所</td> <td>中央制御室操作</td> <td colspan="2">B</td> </tr> <tr> <td colspan="2">関連資料</td> <td colspan="2">[配置図] 59-3</td> </tr> <tr> <td>常設SAの容量</td> <td>DB施設の系統及び機器の容量が1分 (DB施設と同仕様の通信機器で設計)</td> <td colspan="2">B</td> </tr> <tr> <td colspan="2">関連資料</td> <td colspan="2">[容量設定根拠] 59-6</td> <td></td> </tr> <tr> <td>共用の禁止</td> <td>(共用しない設備)</td> <td colspan="2">対象外</td> </tr> <tr> <td colspan="2">関連資料</td> <td colspan="2">—</td> </tr> <tr> <td rowspan="2">共通要因故障防止</td> <td>環境条件、自然現象、外部人為事象、溢水、火災</td> <td>同一機能の設備なし又は代替対象DB設備なし</td> <td colspan="2">対象外</td> </tr> <tr> <td>サポート系故障防止</td> <td>(サポート系なし)</td> <td colspan="2">対象外</td> </tr> <tr> <td colspan="2">関連資料</td> <td colspan="2">[配置図] 59-3</td> <td></td> </tr> </table>		59条: 原子炉制御室		データ表示装置 (待避室)			類型化区分		第1項	環境条件における健全性	環境温度・湿度・圧力/屋外の天候/放射線	原子炉建屋原子炉棟外	C		荷重	海水を漏水しない	対象外		海水	(有効に機能を発揮する)	—		他設備からの影響	(周辺機器等からの悪影響により機能を失うおそれがない)	—		電磁波による影響	(電磁波により機能が損なわれない)	対象外		第2項	関連資料		[配置図] 59-3			操作性	中央制御室操作 (操作スイッチ操作)	A		関連資料		[配置図] 59-3			試験・検査 (検査性、系統構成・外部入力)	通信連絡設備	L		関連資料		[試験及び検査] 59-5			第43条	切り替え性	常時接続-切替不要	B b		関連資料		—		悪影響防止	系統設計	DB施設と同じ系統構成	A d		その他(飛散物)	(考慮対象なし)	対象外		関連資料		[配置図] 59-3 [系統図] 59-4			第2項	設置場所	中央制御室操作	B		関連資料		[配置図] 59-3		常設SAの容量	DB施設の系統及び機器の容量が1分 (DB施設と同仕様の通信機器で設計)	B		関連資料		[容量設定根拠] 59-6			共用の禁止	(共用しない設備)	対象外		関連資料		—		共通要因故障防止	環境条件、自然現象、外部人為事象、溢水、火災	同一機能の設備なし又は代替対象DB設備なし	対象外		サポート系故障防止	(サポート系なし)	対象外		関連資料		[配置図] 59-3			<table border="1"> <tr> <td colspan="2">第59条: 運転員が原子炉制御室にとどまるための設備</td> <td colspan="2">データ表示装置 (待避室)</td> <td colspan="2">類型化区分</td> </tr> <tr> <td rowspan="10">第1項</td> <td rowspan="5">環境条件における健全性</td> <td>環境温度・環境圧力・湿度/屋外の天候/放射線/荷重</td> <td>原子炉建屋原子炉棟外</td> <td colspan="2">C</td> </tr> <tr> <td>海水</td> <td>海水を漏水しない</td> <td colspan="2">対象外</td> </tr> <tr> <td>周辺機器等からの悪影響</td> <td>(周辺機器等からの悪影響により機能を失うおそれがない)</td> <td colspan="2">—</td> </tr> <tr> <td>電磁的障害</td> <td>(電磁波の影響を受けない)</td> <td colspan="2">—</td> </tr> <tr> <td>関連資料</td> <td colspan="2">59-3 配置図</td> <td></td> </tr> <tr> <td rowspan="5">第2項</td> <td colspan="2">操作性</td> <td colspan="2">中央制御室操作</td> <td>A</td> </tr> <tr> <td colspan="2">関連資料</td> <td colspan="2">59-3 配置図</td> <td></td> </tr> <tr> <td>試験・検査 (検査性、系統構成・外部入力)</td> <td>通信連絡設備</td> <td colspan="2">L</td> </tr> <tr> <td colspan="2">関連資料</td> <td colspan="2">59-5 試験検査</td> <td></td> </tr> <tr> <td>切替性</td> <td>本来の用途として使用する</td> <td colspan="2">対象外</td> </tr> <tr> <td colspan="2">関連資料</td> <td colspan="2">—</td> </tr> <tr> <td rowspan="3">第3項</td> <td rowspan="2">悪影響防止</td> <td>系統設計</td> <td>通常待機時は隔離又は分離</td> <td colspan="2">A b</td> </tr> <tr> <td>その他(飛散物)</td> <td>その他設備</td> <td colspan="2">対象外</td> </tr> <tr> <td>関連資料</td> <td colspan="2">59-3 配置図</td> <td></td> </tr> <tr> <td>設置場所</td> <td>中央制御室操作</td> <td colspan="2">B</td> </tr> <tr> <td colspan="2">関連資料</td> <td colspan="2">59-3 配置図</td> <td></td> </tr> <tr> <td rowspan="3">第3項</td> <td>可搬SAの容量</td> <td>その他設備</td> <td colspan="2">C</td> </tr> <tr> <td>関連資料</td> <td colspan="2">59-6 容量設定根拠</td> <td></td> </tr> <tr> <td>可搬SAの接続性</td> <td>簡便な接続規格等による接続</td> <td colspan="2">C</td> </tr> <tr> <td colspan="2">関連資料</td> <td colspan="2">—</td> </tr> <tr> <td rowspan="3">第3項</td> <td rowspan="2">異なる複数の接続箇所の確保</td> <td>(対象外)</td> <td colspan="2">対象外</td> </tr> <tr> <td>関連資料</td> <td colspan="2">—</td> </tr> <tr> <td>設置場所</td> <td>(線量の高くなるおそれの少ない場所を選定)</td> <td colspan="2">—</td> </tr> <tr> <td colspan="2">関連資料</td> <td colspan="2">59-3 配置図</td> <td></td> </tr> <tr> <td rowspan="3">第3項</td> <td>保管場所</td> <td>屋内</td> <td colspan="2">A a</td> </tr> <tr> <td>関連資料</td> <td colspan="2">59-7 保管場所図</td> <td></td> </tr> <tr> <td>アクセスルート</td> <td>対象外 (アクセス不要)</td> <td colspan="2">—</td> </tr> <tr> <td colspan="2">関連資料</td> <td colspan="2">—</td> </tr> <tr> <td rowspan="2">共通要因故障防止</td> <td>環境条件、自然現象、外部人為事象、溢水、火災</td> <td>屋内</td> <td colspan="2">A a</td> </tr> <tr> <td>サポート系による要因</td> <td>異なる駆動源又は冷却源</td> <td colspan="2">B a</td> </tr> <tr> <td colspan="2">関連資料</td> <td colspan="2">59-3 配置図</td> <td></td> </tr> </table>		第59条: 運転員が原子炉制御室にとどまるための設備		データ表示装置 (待避室)		類型化区分		第1項	環境条件における健全性	環境温度・環境圧力・湿度/屋外の天候/放射線/荷重	原子炉建屋原子炉棟外	C		海水	海水を漏水しない	対象外		周辺機器等からの悪影響	(周辺機器等からの悪影響により機能を失うおそれがない)	—		電磁的障害	(電磁波の影響を受けない)	—		関連資料	59-3 配置図			第2項	操作性		中央制御室操作		A	関連資料		59-3 配置図			試験・検査 (検査性、系統構成・外部入力)	通信連絡設備	L		関連資料		59-5 試験検査			切替性	本来の用途として使用する	対象外		関連資料		—		第3項	悪影響防止	系統設計	通常待機時は隔離又は分離	A b		その他(飛散物)	その他設備	対象外		関連資料	59-3 配置図			設置場所	中央制御室操作	B		関連資料		59-3 配置図			第3項	可搬SAの容量	その他設備	C		関連資料	59-6 容量設定根拠			可搬SAの接続性	簡便な接続規格等による接続	C		関連資料		—		第3項	異なる複数の接続箇所の確保	(対象外)	対象外		関連資料	—		設置場所	(線量の高くなるおそれの少ない場所を選定)	—		関連資料		59-3 配置図			第3項	保管場所	屋内	A a		関連資料	59-7 保管場所図			アクセスルート	対象外 (アクセス不要)	—		関連資料		—		共通要因故障防止	環境条件、自然現象、外部人為事象、溢水、火災	屋内	A a		サポート系による要因	異なる駆動源又は冷却源	B a		関連資料		59-3 配置図			<table border="1"> <tr> <td colspan="2">第59条: 運転員が原子炉制御室にとどまるための設備</td> <td colspan="2">プラントパラメータ監視装置 (中央制御室待避室)</td> <td colspan="2">類型化区分</td> </tr> <tr> <td rowspan="10">第1項</td> <td rowspan="5">環境条件における健全性</td> <td>環境温度・湿度・圧力/屋外の天候/放射線</td> <td>その他の建屋内 (中央制御室待避室)</td> <td colspan="2">C</td> </tr> <tr> <td>荷重</td> <td>(有効に機能を発揮する)</td> <td colspan="2">—</td> </tr> <tr> <td>海水</td> <td>海水を漏水しない</td> <td colspan="2">対象外</td> </tr> <tr> <td>周辺機器等からの悪影響</td> <td>(周辺機器等からの悪影響により機能を失うおそれがない)</td> <td colspan="2">—</td> </tr> <tr> <td>電磁波による影響</td> <td>(電磁波により機能が損なわれない)</td> <td colspan="2">対象外</td> </tr> <tr> <td rowspan="5">第2項</td> <td colspan="2">関連資料</td> <td colspan="2">[配置図] 59-3</td> <td></td> </tr> <tr> <td>操作性</td> <td>中央制御室操作 (操作スイッチ操作)</td> <td colspan="2">A</td> </tr> <tr> <td colspan="2">関連資料</td> <td colspan="2">[配置図] 59-3</td> <td></td> </tr> <tr> <td>試験・検査 (検査性、系統構成・外部入力)</td> <td>通信連絡設備</td> <td colspan="2">L</td> </tr> <tr> <td colspan="2">関連資料</td> <td colspan="2">[試験及び検査] 59-5</td> <td></td> </tr> <tr> <td rowspan="3">第43条</td> <td>切り替え性</td> <td>本来の用途として使用一切替操作が必要</td> <td colspan="2">B a</td> </tr> <tr> <td colspan="2">関連資料</td> <td colspan="2">—</td> </tr> <tr> <td rowspan="2">悪影響防止</td> <td>系統設計</td> <td>通常時は隔離又は分離</td> <td colspan="2">A b</td> </tr> <tr> <td>その他(飛散物)</td> <td>(考慮対象なし)</td> <td colspan="2">対象外</td> </tr> <tr> <td colspan="2">関連資料</td> <td colspan="2">[配置図] 59-3 [系統図] 59-4</td> <td></td> </tr> <tr> <td rowspan="3">第3項</td> <td>設置場所</td> <td>中央制御室操作</td> <td colspan="2">B</td> </tr> <tr> <td colspan="2">関連資料</td> <td colspan="2">[配置図] 59-3</td> </tr> <tr> <td>可搬SAの容量</td> <td>その他設備</td> <td colspan="2">C</td> </tr> <tr> <td colspan="2">関連資料</td> <td colspan="2">[容量設定根拠] 59-6</td> <td></td> </tr> <tr> <td rowspan="3">第3項</td> <td rowspan="2">可搬SAの接続性</td> <td>より簡便な接続 (ケーブル)</td> <td colspan="2">C</td> </tr> <tr> <td>関連資料</td> <td colspan="2">—</td> </tr> <tr> <td>異なる複数の接続箇所の確保</td> <td>(考慮対象なし)</td> <td colspan="2">対象外</td> </tr> <tr> <td colspan="2">関連資料</td> <td colspan="2">—</td> </tr> <tr> <td rowspan="3">第3項</td> <td rowspan="2">設置場所</td> <td>(放射線量の高くなるおそれの少ない場所の選定)</td> <td colspan="2">—</td> </tr> <tr> <td>関連資料</td> <td colspan="2">—</td> </tr> <tr> <td>保管場所</td> <td>屋内 (共通要因の考慮対象設備なし)</td> <td colspan="2">A b</td> </tr> <tr> <td colspan="2">関連資料</td> <td colspan="2">[保管場所図] 59-7</td> <td></td> </tr> <tr> <td rowspan="3">第3項</td> <td rowspan="2">アクセスルート</td> <td>中央制御室又は緊急事対策所で保管及び使用する</td> <td colspan="2">対象外</td> </tr> <tr> <td>関連資料</td> <td colspan="2">—</td> </tr> <tr> <td rowspan="2">共通要因故障防止</td> <td>環境条件、自然現象、外部人為事象、溢水、火災</td> <td>緩和設備又は防止でも緩和でもない設備-対象 (同一目的のSA設備、代替対象DB設備なし)</td> <td colspan="2">対象外</td> </tr> <tr> <td>サポート系要因</td> <td>対象 (サポート系あり) -異なる駆動源又は冷却源</td> <td colspan="2">C a</td> </tr> <tr> <td colspan="2">関連資料</td> <td colspan="2">[配置図] 59-3</td> <td></td> </tr> </table>		第59条: 運転員が原子炉制御室にとどまるための設備		プラントパラメータ監視装置 (中央制御室待避室)		類型化区分		第1項	環境条件における健全性	環境温度・湿度・圧力/屋外の天候/放射線	その他の建屋内 (中央制御室待避室)	C		荷重	(有効に機能を発揮する)	—		海水	海水を漏水しない	対象外		周辺機器等からの悪影響	(周辺機器等からの悪影響により機能を失うおそれがない)	—		電磁波による影響	(電磁波により機能が損なわれない)	対象外		第2項	関連資料		[配置図] 59-3			操作性	中央制御室操作 (操作スイッチ操作)	A		関連資料		[配置図] 59-3			試験・検査 (検査性、系統構成・外部入力)	通信連絡設備	L		関連資料		[試験及び検査] 59-5			第43条	切り替え性	本来の用途として使用一切替操作が必要	B a		関連資料		—		悪影響防止	系統設計	通常時は隔離又は分離	A b		その他(飛散物)	(考慮対象なし)	対象外		関連資料		[配置図] 59-3 [系統図] 59-4			第3項	設置場所	中央制御室操作	B		関連資料		[配置図] 59-3		可搬SAの容量	その他設備	C		関連資料		[容量設定根拠] 59-6			第3項	可搬SAの接続性	より簡便な接続 (ケーブル)	C		関連資料	—		異なる複数の接続箇所の確保	(考慮対象なし)	対象外		関連資料		—		第3項	設置場所	(放射線量の高くなるおそれの少ない場所の選定)	—		関連資料	—		保管場所	屋内 (共通要因の考慮対象設備なし)	A b		関連資料		[保管場所図] 59-7			第3項	アクセスルート	中央制御室又は緊急事対策所で保管及び使用する	対象外		関連資料	—		共通要因故障防止	環境条件、自然現象、外部人為事象、溢水、火災	緩和設備又は防止でも緩和でもない設備-対象 (同一目的のSA設備、代替対象DB設備なし)	対象外		サポート系要因	対象 (サポート系あり) -異なる駆動源又は冷却源	C a		関連資料		[配置図] 59-3		
59条: 原子炉制御室		データ表示装置 (待避室)		類型化区分																																																																																																																																																																																																																																																																																																																																																																																																																									
第1項	環境条件における健全性	環境温度・湿度・圧力/屋外の天候/放射線	原子炉建屋原子炉棟外	C																																																																																																																																																																																																																																																																																																																																																																																																																									
		荷重	海水を漏水しない	対象外																																																																																																																																																																																																																																																																																																																																																																																																																									
		海水	(有効に機能を発揮する)	—																																																																																																																																																																																																																																																																																																																																																																																																																									
		他設備からの影響	(周辺機器等からの悪影響により機能を失うおそれがない)	—																																																																																																																																																																																																																																																																																																																																																																																																																									
		電磁波による影響	(電磁波により機能が損なわれない)	対象外																																																																																																																																																																																																																																																																																																																																																																																																																									
	第2項	関連資料		[配置図] 59-3																																																																																																																																																																																																																																																																																																																																																																																																																									
		操作性	中央制御室操作 (操作スイッチ操作)	A																																																																																																																																																																																																																																																																																																																																																																																																																									
		関連資料		[配置図] 59-3																																																																																																																																																																																																																																																																																																																																																																																																																									
		試験・検査 (検査性、系統構成・外部入力)	通信連絡設備	L																																																																																																																																																																																																																																																																																																																																																																																																																									
		関連資料		[試験及び検査] 59-5																																																																																																																																																																																																																																																																																																																																																																																																																									
第43条	切り替え性	常時接続-切替不要	B b																																																																																																																																																																																																																																																																																																																																																																																																																										
	関連資料		—																																																																																																																																																																																																																																																																																																																																																																																																																										
	悪影響防止	系統設計	DB施設と同じ系統構成	A d																																																																																																																																																																																																																																																																																																																																																																																																																									
その他(飛散物)		(考慮対象なし)	対象外																																																																																																																																																																																																																																																																																																																																																																																																																										
関連資料		[配置図] 59-3 [系統図] 59-4																																																																																																																																																																																																																																																																																																																																																																																																																											
第2項	設置場所	中央制御室操作	B																																																																																																																																																																																																																																																																																																																																																																																																																										
	関連資料		[配置図] 59-3																																																																																																																																																																																																																																																																																																																																																																																																																										
	常設SAの容量	DB施設の系統及び機器の容量が1分 (DB施設と同仕様の通信機器で設計)	B																																																																																																																																																																																																																																																																																																																																																																																																																										
関連資料		[容量設定根拠] 59-6																																																																																																																																																																																																																																																																																																																																																																																																																											
共用の禁止	(共用しない設備)	対象外																																																																																																																																																																																																																																																																																																																																																																																																																											
関連資料		—																																																																																																																																																																																																																																																																																																																																																																																																																											
共通要因故障防止	環境条件、自然現象、外部人為事象、溢水、火災	同一機能の設備なし又は代替対象DB設備なし	対象外																																																																																																																																																																																																																																																																																																																																																																																																																										
	サポート系故障防止	(サポート系なし)	対象外																																																																																																																																																																																																																																																																																																																																																																																																																										
関連資料		[配置図] 59-3																																																																																																																																																																																																																																																																																																																																																																																																																											
第59条: 運転員が原子炉制御室にとどまるための設備		データ表示装置 (待避室)		類型化区分																																																																																																																																																																																																																																																																																																																																																																																																																									
第1項	環境条件における健全性	環境温度・環境圧力・湿度/屋外の天候/放射線/荷重	原子炉建屋原子炉棟外	C																																																																																																																																																																																																																																																																																																																																																																																																																									
		海水	海水を漏水しない	対象外																																																																																																																																																																																																																																																																																																																																																																																																																									
		周辺機器等からの悪影響	(周辺機器等からの悪影響により機能を失うおそれがない)	—																																																																																																																																																																																																																																																																																																																																																																																																																									
		電磁的障害	(電磁波の影響を受けない)	—																																																																																																																																																																																																																																																																																																																																																																																																																									
		関連資料	59-3 配置図																																																																																																																																																																																																																																																																																																																																																																																																																										
	第2項	操作性		中央制御室操作		A																																																																																																																																																																																																																																																																																																																																																																																																																							
		関連資料		59-3 配置図																																																																																																																																																																																																																																																																																																																																																																																																																									
		試験・検査 (検査性、系統構成・外部入力)	通信連絡設備	L																																																																																																																																																																																																																																																																																																																																																																																																																									
		関連資料		59-5 試験検査																																																																																																																																																																																																																																																																																																																																																																																																																									
		切替性	本来の用途として使用する	対象外																																																																																																																																																																																																																																																																																																																																																																																																																									
関連資料		—																																																																																																																																																																																																																																																																																																																																																																																																																											
第3項	悪影響防止	系統設計	通常待機時は隔離又は分離	A b																																																																																																																																																																																																																																																																																																																																																																																																																									
		その他(飛散物)	その他設備	対象外																																																																																																																																																																																																																																																																																																																																																																																																																									
	関連資料	59-3 配置図																																																																																																																																																																																																																																																																																																																																																																																																																											
設置場所	中央制御室操作	B																																																																																																																																																																																																																																																																																																																																																																																																																											
関連資料		59-3 配置図																																																																																																																																																																																																																																																																																																																																																																																																																											
第3項	可搬SAの容量	その他設備	C																																																																																																																																																																																																																																																																																																																																																																																																																										
	関連資料	59-6 容量設定根拠																																																																																																																																																																																																																																																																																																																																																																																																																											
	可搬SAの接続性	簡便な接続規格等による接続	C																																																																																																																																																																																																																																																																																																																																																																																																																										
関連資料		—																																																																																																																																																																																																																																																																																																																																																																																																																											
第3項	異なる複数の接続箇所の確保	(対象外)	対象外																																																																																																																																																																																																																																																																																																																																																																																																																										
		関連資料	—																																																																																																																																																																																																																																																																																																																																																																																																																										
	設置場所	(線量の高くなるおそれの少ない場所を選定)	—																																																																																																																																																																																																																																																																																																																																																																																																																										
関連資料		59-3 配置図																																																																																																																																																																																																																																																																																																																																																																																																																											
第3項	保管場所	屋内	A a																																																																																																																																																																																																																																																																																																																																																																																																																										
	関連資料	59-7 保管場所図																																																																																																																																																																																																																																																																																																																																																																																																																											
	アクセスルート	対象外 (アクセス不要)	—																																																																																																																																																																																																																																																																																																																																																																																																																										
関連資料		—																																																																																																																																																																																																																																																																																																																																																																																																																											
共通要因故障防止	環境条件、自然現象、外部人為事象、溢水、火災	屋内	A a																																																																																																																																																																																																																																																																																																																																																																																																																										
	サポート系による要因	異なる駆動源又は冷却源	B a																																																																																																																																																																																																																																																																																																																																																																																																																										
関連資料		59-3 配置図																																																																																																																																																																																																																																																																																																																																																																																																																											
第59条: 運転員が原子炉制御室にとどまるための設備		プラントパラメータ監視装置 (中央制御室待避室)		類型化区分																																																																																																																																																																																																																																																																																																																																																																																																																									
第1項	環境条件における健全性	環境温度・湿度・圧力/屋外の天候/放射線	その他の建屋内 (中央制御室待避室)	C																																																																																																																																																																																																																																																																																																																																																																																																																									
		荷重	(有効に機能を発揮する)	—																																																																																																																																																																																																																																																																																																																																																																																																																									
		海水	海水を漏水しない	対象外																																																																																																																																																																																																																																																																																																																																																																																																																									
		周辺機器等からの悪影響	(周辺機器等からの悪影響により機能を失うおそれがない)	—																																																																																																																																																																																																																																																																																																																																																																																																																									
		電磁波による影響	(電磁波により機能が損なわれない)	対象外																																																																																																																																																																																																																																																																																																																																																																																																																									
	第2項	関連資料		[配置図] 59-3																																																																																																																																																																																																																																																																																																																																																																																																																									
		操作性	中央制御室操作 (操作スイッチ操作)	A																																																																																																																																																																																																																																																																																																																																																																																																																									
		関連資料		[配置図] 59-3																																																																																																																																																																																																																																																																																																																																																																																																																									
		試験・検査 (検査性、系統構成・外部入力)	通信連絡設備	L																																																																																																																																																																																																																																																																																																																																																																																																																									
		関連資料		[試験及び検査] 59-5																																																																																																																																																																																																																																																																																																																																																																																																																									
第43条	切り替え性	本来の用途として使用一切替操作が必要	B a																																																																																																																																																																																																																																																																																																																																																																																																																										
	関連資料		—																																																																																																																																																																																																																																																																																																																																																																																																																										
	悪影響防止	系統設計	通常時は隔離又は分離	A b																																																																																																																																																																																																																																																																																																																																																																																																																									
その他(飛散物)		(考慮対象なし)	対象外																																																																																																																																																																																																																																																																																																																																																																																																																										
関連資料		[配置図] 59-3 [系統図] 59-4																																																																																																																																																																																																																																																																																																																																																																																																																											
第3項	設置場所	中央制御室操作	B																																																																																																																																																																																																																																																																																																																																																																																																																										
	関連資料		[配置図] 59-3																																																																																																																																																																																																																																																																																																																																																																																																																										
	可搬SAの容量	その他設備	C																																																																																																																																																																																																																																																																																																																																																																																																																										
関連資料		[容量設定根拠] 59-6																																																																																																																																																																																																																																																																																																																																																																																																																											
第3項	可搬SAの接続性	より簡便な接続 (ケーブル)	C																																																																																																																																																																																																																																																																																																																																																																																																																										
		関連資料	—																																																																																																																																																																																																																																																																																																																																																																																																																										
	異なる複数の接続箇所の確保	(考慮対象なし)	対象外																																																																																																																																																																																																																																																																																																																																																																																																																										
関連資料		—																																																																																																																																																																																																																																																																																																																																																																																																																											
第3項	設置場所	(放射線量の高くなるおそれの少ない場所の選定)	—																																																																																																																																																																																																																																																																																																																																																																																																																										
		関連資料	—																																																																																																																																																																																																																																																																																																																																																																																																																										
	保管場所	屋内 (共通要因の考慮対象設備なし)	A b																																																																																																																																																																																																																																																																																																																																																																																																																										
関連資料		[保管場所図] 59-7																																																																																																																																																																																																																																																																																																																																																																																																																											
第3項	アクセスルート	中央制御室又は緊急事対策所で保管及び使用する	対象外																																																																																																																																																																																																																																																																																																																																																																																																																										
		関連資料	—																																																																																																																																																																																																																																																																																																																																																																																																																										
	共通要因故障防止	環境条件、自然現象、外部人為事象、溢水、火災	緩和設備又は防止でも緩和でもない設備-対象 (同一目的のSA設備、代替対象DB設備なし)	対象外																																																																																																																																																																																																																																																																																																																																																																																																																									
サポート系要因		対象 (サポート系あり) -異なる駆動源又は冷却源	C a																																																																																																																																																																																																																																																																																																																																																																																																																										
関連資料		[配置図] 59-3																																																																																																																																																																																																																																																																																																																																																																																																																											

柏崎刈羽原子力発電所 6/7号炉 (2017.12.20版)		東海第二発電所 (2018.9.18版)		島根原子力発電所 2号炉		備考
<p>柏崎刈羽原子力発電所6号及び7号炉 SA設備基準適合性一覧表(可搬)</p>						
59条：原子炉制御室		中央制御室 可搬型隔圧化空調機		類型化区分		
第1項	第1号	環境温度・湿度・圧力／屋外の人騒／放射線	原子炉区域を除く原子炉建屋内及びその他の建屋内(コントロール建屋)	C		
		荷重	(有効に機能を発揮する)	-		
		海水	(海水を通水しない)	対象外		
		他設備からの影響	(周辺機器等からの悪影響により機能を失うおそれがない)	-		
		電磁波による影響	(電磁波により機能が損なわれない)	対象外		
		関連資料	[配置図] 59-3			
	第2号	操作性	現場操作(準備、スイッチ操作)	Bc Bd		
		関連資料	[配置図] 59-3 [保管場所図] 59-7			
		試験・検査(検査性、系統構成・外部入力)	空調ユニット	E		
	第3号	関連資料	[試験及び検査] 59-5			
		切り替え性	本来の用途として使用一切不要	A		
	第4号	関連資料	-			
系統設計		他設備から独立	A c			
その他(飛散物)		(考慮対象なし)	対象外			
第5号	関連資料	-				
	設置場所	現場操作	A a			
第6号	関連資料	[配置図] 59-3 [保管場所図] 59-7				
	可搬SAの容量	重大事故等への対応を本来の目的として設置するもの	A			
第2号	関連資料	[容量設定根拠] 59-6				
	可搬SAの接続性	より簡単な接続	C			
第3号	関連資料	-				
	異なる複数の接続箇所の確保	対象外	対象外			
第4号	関連資料	-				
	設置場所	(放射線量の高くなるおそれの少ない場所を選定)	-			
第5号	関連資料	-				
	保管場所	屋内(共通要因の考慮対象設備なし)	A b			
第6号	関連資料	-				
	アクセスルート	屋内アクセスルートの確保	A			
第7号	関連資料	-				
	環境条件、自然現象、外部人為事象、溢水、火災	防止設備-対象(代替対象D B設備有り)-屋内	A a			
第4号	サポート系要因	対象(サポート系有り)-異なる駆動源又は冷却源	C a			
	関連資料	-				
<p>備考</p> <ul style="list-style-type: none"> ・設備及び運用の相違【柏崎 6/7】 ①の相違 						

柏崎刈羽原子力発電所 6/7号炉 (2017.12.20版)

柏崎刈羽原子力発電所6号及び7号炉 SA設備基準適合性一覧表(可搬)

59条：原子炉制御室		中央制御室待避室高圧化装置(空気ポンプ)	類型化区分		
第1項	環境条件における健全性	環境温度・湿度・圧力/屋外の天候/放射線	原子炉区域を除く原子炉建屋内及びその他の建屋内(コントロール建屋及び廃棄物処理建屋)		
		荷重	(有効に機能を発揮する)		
		海水	(海水を通過しない)		
		他設備からの影響	(周辺機器等からの悪影響により機能を失うおそれがない)		
		電磁波による影響	(電磁波により機能が損なわれない)		
		関連資料	[配置図] 59-3		
		第2項	操作性	現場操作(弁操作)	Bf
			関連資料	[配置図] 59-3	
		第3項	試験・検査(検査性、系統構成・外部入力)	容器(タンク類)	C
			関連資料	[試験及び検査] 59-5	
第4項	切り替え性	本来の用途として使用一切不要	A		
	関連資料	-			
第5項	悪影響防止	系統設計	他設備から独立		
		その他(飛散物)	(考慮対象なし)		
		関連資料	-		
第6項	設置場所	現場(設置場所)で操作可能	A		
	関連資料	[配置図] 59-3 [系統図] 59-4			
第7項	可搬SAの容量	重大事故等への対処を本来の目的として設置するもの	A		
	関連資料	[容量設定根拠] 59-6			
第8項	可搬SAの接続性	より簡単な接続	C		
	関連資料	-			
第9項	異なる複数の接続箇所の確保	対象外	対象外		
	関連資料	-			
第10項	設置場所	(放射線量の高くなるおそれの少ない場所を選定)	-		
	関連資料	-			
第11項	保管場所	屋内(共通要因の考慮対象設備なし)	Ab		
	関連資料	-			
第12項	アクセスルート	屋内アクセスルートの確保	A		
	関連資料	-			
第13項	共通要因	環境条件、自然現象、外部人為事象、溢水、火災	防止設備-対象(代替対象DB設備有り)-屋内		
	サポーター系要因	(サポーター系なし)	対象外		
第14項	関連資料	-			

東海第二発電所 (2018.9.18版)

東海第二発電所 SA設備基準適合性一覧表(可搬型)

第59条：運転員が原子炉制御室にとどまるための設備	中央制御室待避室空気ポンプユニット(空気ポンプ)	類型化区分	可搬型照明(SA)	類型化区分			
第1項	環境条件における健全性	環境温度・環境圧力・湿度/屋外の天候/放射線/荷重	原子炉建屋原子炉棟外	C	原子炉建屋原子炉棟外	C	
		海水	海水を通過しない	対象外	海水を通過しない	対象外	
		周辺機器等からの悪影響	(周辺機器等からの悪影響により機能を失うおそれがない)	-	(周辺機器等からの悪影響により機能を失うおそれがない)	-	
		電磁的障害	(電磁波の影響を受けない)	-	(電磁波の影響を受けない)	-	
		関連資料	59-3 配置図		59-3 配置図		
		第2項	操作性	現場操作(弁操作)	Bf	設備の運搬、設置	Bc
			関連資料	59-3 配置図		59-3 配置図	
		第3項	試験・検査(検査性、系統構成・外部入力)	容器(タンク類)	C	その他電源設備	I
			関連資料	59-5 試験検査		59-5 試験検査	
		第4項	切り替え性	本来の用途として使用する	対象外	本来の用途として使用する	対象外
関連資料	-			-			
第5項	悪影響防止	系統設計	他設備から独立	Ac	他設備から独立	Ac	
		その他(飛散物)	その他設備	対象外	その他設備	対象外	
第6項	設置場所	設置場所	中央制御室操作	B	中央制御室操作現場(設置場所)で操作可能	B	
		関連資料	59-3 配置図		59-3 配置図		
第7項	可搬SAの容量	可搬SAの容量	その他設備	C	その他設備	C	
		関連資料	59-6 容量設定根拠		59-9 原子炉制御室について		
第8項	可搬SAの接続性	可搬SAの接続性	(対象外)	対象外	より簡単な接続規格等による接続	C	
		関連資料	-		-		
第9項	異なる複数の接続箇所の確保	異なる複数の接続箇所の確保	(対象外)	対象外	(対象外)	対象外	
		関連資料	-		-		
第10項	設置場所	設置場所	(放射線量の高くなるおそれの少ない場所を選定)	-	(放射線量の高くなるおそれの少ない場所を選定)	-	
		関連資料	59-3 配置図		59-3 配置図		
第11項	保管場所	保管場所	屋内	Aa	屋内	Aa	
		関連資料	59-3 配置図		59-7 保管場所図		
第12項	アクセスルート	アクセスルート	対象外(アクセス不要)	-	対象外(アクセス不要)	-	
		関連資料	-		59-8 アクセスルート図		
第13項	共通要因	環境条件、自然現象、外部人為事象、溢水、火災	屋内	Aa	屋内	Aa	
		サポーター系による要因	(サポーター系なし)	対象外	異なる駆動源又は冷却源	Ba	
第14項	関連資料	59-3 配置図		59-3 配置図			
第15項	関連資料	59-7 保管場所図		59-7 保管場所図			

島根原子力発電所 2号炉

島根原子力発電所2号炉 SA設備基準適合性一覧表(可搬)

第59条：運転員が原子炉制御室にとどまるための設備		中央制御室待避室正圧化装置(空気ポンプ)	類型化区分		
第1項	環境条件における健全性	環境温度・湿度・圧力/屋外の天候/放射線	その他の建物内設備(制御室建物、廃棄物処理建物)		
		荷重	(有効に機能を発揮する)		
		海水	海水を通過しない		
		周辺機器等からの悪影響	(周辺機器等からの悪影響により機能を失うおそれがない)		
		電磁波による影響	(電磁波により機能が損なわれない)		
		関連資料	[配置図] 59-3		
		第2項	操作性	弁操作	Bf
			関連資料	[配置図] 59-3	
		第3項	試験・検査(検査性、系統構成・外部入力)	容器(タンク類)	C
			関連資料	[試験及び検査] 59-5	
第4項	切り替え性	本来の用途として使用一切替操作が必要	Ba		
	関連資料	[系統図] 59-4			
第5項	悪影響防止	系統設計	他設備からの独立		
		その他(飛散物)	(考慮対象なし)		
第6項	設置場所	設置場所	現場操作(設置場所)		
		関連資料	[配置図] 59-3, [系統図] 59-4		
第7項	可搬SAの容量	可搬SAの容量	その他設備		
		関連資料	[容量設定根拠] 59-6		
第8項	可搬SAの接続性	可搬SAの接続性	専用の接続		
		関連資料	-		
第9項	異なる複数の接続箇所の確保	異なる複数の接続箇所の確保	対象外		
		関連資料	-		
第10項	設置場所	設置場所	(放射線量の高くなるおそれの少ない場所を選定)		
		関連資料	[配置図] 59-3		
第11項	保管場所	保管場所	屋内(共通要因の考慮対象設備なし)		
		関連資料	[配置図] 59-3		
第12項	アクセスルート	アクセスルート	屋内アクセスルートの確保		
		関連資料	[アクセスルート図] 59-8		
第13項	共通要因	環境条件、自然現象、外部人為事象、溢水、火災	緩和設備又は防止でも緩和でもない設備-対象(同一目的のSA設備、代替対象DB設備なし)		
		サポーター系要因	対象外(サポーター系なし)		
第14項	関連資料	-			

備考

柏崎刈羽原子力発電所6号及び7号炉 SA設備基準適合性一覧表(可搬)

東海第二発電所 SA設備基準適合性 一覧表(可搬型)

島根原子力発電所2号炉 SA設備基準適合性 一覧表(可搬)

第59条：原子炉制御室		可搬型蓄電池内蔵型照明	類型化区分	
第1項	環境条件における健全性	原子炉区域を除く原子炉建屋内及びその他の建屋内	C	
	第1号	環境温度・湿度・圧力/屋外の天候/放射線		
	第1号	荷重	(有効に機能を発揮する) -	
	第1号	海水	(海水を通水しない) 対象外	
	第1号	他設備からの影響	(周辺機器等からの悪影響により機能を失うおそれがない) -	
	第1号	電磁波による影響	(電磁波により機能が損なわれない) 対象外	
	第1号	関連資料	[配置図] 59-3	
	第2号	操作性	設備の運搬・設置 Bc	
	第2号	関連資料	[配置図] 59-3	
	第3号	試験・検査(検査性、系統構成・外部入力)	その他電源設備 M	
第43条	第3号	関連資料	[試験及び検査] 59-5	
	第4号	切り替え性	当該系統の使用にあたり切替操作が不要 Bb	
	第4号	関連資料	-	
	第5号	悪影響防止	系統設計 他設備から独立 A c	
		悪影響防止	その他(飛散物) その他設備 対象外	
	第5号	悪影響防止	関連資料 59-4 系統図	
	第6号	設置場所	中央制御室操作 B	
	第6号	関連資料	59-3 配置図	
	第3項	第1号	可搬SAの容量	その他設備 C
		第1号	関連資料	59-6 容量設定根拠
第2号		可搬SAの接続性	(対象外) 対象外	
第2号		関連資料	59-9 原子炉制御室について	
第3号		異なる複数の接続箇所の確保	(対象外) 対象外	
第3号		関連資料	-	
第4号		設置場所	(放射線の高くなるおそれの少ない場所を選定) -	
第4号		関連資料	59-3 配置図	
第5号		保管場所	屋内 A a	
第5号		関連資料	59-3 配置図	
第3項	第6号	アクセスルート	対象外(アクセス不要) -	
	第6号	関連資料	59-8 アクセスルート図	
	第7号	共通要因	環境条件、自然現象、外部人為事象、溢水、火災	屋内 A a
		悪影響防止	サポート系による要因	(サポート系なし) 対象外
	第7号	悪影響防止	関連資料	59-3 配置図

第59条：運転員が原子炉制御室にとどまるための設備	中央制御室待避室空気ポンプユニット(空気ポンプ)	類型化区分	可搬型照明(SA)	類型化区分
第1項	環境温度・環境圧力・湿度/屋外の天候/放射線/荷重	原子炉建屋原子炉棟外	原子炉建屋原子炉棟外	C
第1項	海水	海水を通水しない	海水を通水しない	対象外
第1項	周辺機器等からの悪影響	(周辺機器等からの悪影響により機能を失うおそれがない) -	(周辺機器等からの悪影響により機能を失うおそれがない) -	-
第1項	電磁的障害	(電磁波の影響を受けない) -	(電磁波の影響を受けない) -	-
第1項	関連資料	59-3 配置図	59-3 配置図	
第2項	操作性	現場操作(弁操作)	設備の運搬、設置	B f B c
第2項	関連資料	59-3 配置図	59-3 配置図	
第3項	試験・検査(検査性、系統構成・外部入力)	容器(タンク類)	その他電源設備	C I
第3項	関連資料	59-5 試験検査	59-5 試験検査	
第4項	切り替え性	本来の用途として使用する	本来の用途として使用する	対象外
第4項	関連資料	-	-	
第5項	悪影響防止	系統設計 他設備から独立	他設備から独立	A c A c
第5項	悪影響防止	その他(飛散物) その他設備	その他設備	対象外
第5項	悪影響防止	関連資料	59-4 系統図	59-3 配置図
第6項	設置場所	中央制御室操作	中央制御室操作	B B
第6項	関連資料	59-3 配置図	現場(設置場所)で操作可能	A a A a
第7項	可搬SAの容量	その他設備	その他設備	C C
第7項	関連資料	59-6 容量設定根拠	59-9 原子炉制御室について	
第7項	可搬SAの接続性	(対象外)	より簡便な接続規格等による接続	C
第7項	関連資料	-	-	
第7項	異なる複数の接続箇所の確保	(対象外)	(対象外)	対象外
第7項	関連資料	-	-	
第7項	設置場所	(放射線の高くなるおそれの少ない場所を選定)	(放射線の高くなるおそれの少ない場所を選定)	-
第7項	関連資料	59-3 配置図	59-3 配置図	
第7項	保管場所	屋内	屋内	A a A a
第7項	関連資料	59-3 配置図	59-7 保管場所図	
第7項	アクセスルート	対象外(アクセス不要)	対象外(アクセス不要)	- A
第7項	関連資料	-	59-8 アクセスルート図	
第7項	共通要因	環境条件、自然現象、外部人為事象、溢水、火災	屋内	A a
第7項	悪影響防止	サポート系による要因	(サポート系なし)	対象外
第7項	悪影響防止	関連資料	異なる駆動源又は冷却源	B a
第7項	悪影響防止	関連資料	59-3 配置図	59-3 配置図
第7項	悪影響防止	関連資料	59-7 保管場所図	

第59条：運転員が原子炉制御室にとどまるための設備	LEDライト(三脚タイプ)	類型化区分		
第1項	環境温度・湿度・圧力/屋外の天候/放射線	その他の建物内(制御室建物)	C	
	荷重	(有効に機能を発揮する)	-	
	海水	海水を通水しない	対象外	
	周辺機器等からの悪影響	(周辺機器等からの悪影響により機能を失うおそれがない) -	-	
	電磁波	(電磁波により機能が損なわれない) 対象外	対象外	
	関連資料	[配置図] 59-3		
	第2号	操作性	現場操作(設備の運搬、設置) 中央制御室操作(操作スイッチ操作)	B c A
	第2号	関連資料	[配置図] 59-3	
	第3号	試験・検査(検査性、系統構成・外部入力)	その他電源設備	M
	第3号	関連資料	[試験及び検査] 59-5	
第43条	第4号	切り替え性	本来の用途として使用一切不要 B b	
	第4号	関連資料	-	
	第5号	悪影響防止	系統設計 他設備から独立	A e
		悪影響防止	その他(飛散物) その他	対象外
	第5号	悪影響防止	関連資料	[単線結線図] 59-2
	第6号	設置場所	現場操作(設置場所)、中央制御室操作	A a, B
	第6号	関連資料	[配置図] 59-3	
	第3項	第1号	可搬SAの容量	その他設備 C
		第1号	関連資料	-
		第2号	可搬SAの接続性	より簡便な接続規格
第2号		関連資料	-	
第3号		異なる複数の接続箇所の確保	対象外	対象外
第3号		関連資料	-	
第4号		設置場所	(放射線の高くなるおそれの少ない場所を選定)	-
第4号		関連資料	[配置図] 59-3	
第5号		保管場所	屋内(共通要因の考慮対象設備なし)	A b
第5号		関連資料	[保管場所図] 59-7	
第6号	アクセスルート	屋内アクセスルートの確保	A	
第6号	関連資料	-		
第7号	共通要因	環境条件、自然現象、外部人為事象、溢水、火災	緩和設備又は防止でも緩和でもない設備-対象(同一目的のSA設備、代替対象DB設備あり)	B
	悪影響防止	サポート系による要因	対象(サポート系あり)-異なる駆動源又は冷却源	C a
第7号	悪影響防止	関連資料	[単線結線図] 59-2	

柏崎刈羽原子力発電所 6/7号炉 (2017.12.20版)			東海第二発電所 (2018.9.18版)			島根原子力発電所 2号炉			備考					
柏崎刈羽原子力発電所6号及び7号炉 SA設備基準適合性一覧表(可搬)			東海第二発電所 SA設備基準適合性 一覧表(可搬型)			島根原子力発電所2号炉 SA設備基準適合性 一覧表(可搬型)								
第43条	第1項	59条:原子炉制御室	酸素濃度・酸化炭素濃度計 (中央制御室・中央制御室待避室)	類型化区分	第59条:運転員が原子炉制御室にとどまるための設備	酸素濃度計	類型化区分	第59条:運転員が原子炉制御室にとどまるための設備	酸素濃度計 (中央制御室・中央制御室待避室)	類型化区分				
		第1号	環境条件における健全性	環境温度・湿度・圧力/屋外の天候/放射線		原子炉区域を除く原子炉建屋内及びその他の建屋内(コントロール建屋)	C		環境温度・環境圧力・湿度/屋外の天候/放射線/荷重	原子炉建屋原子炉棟外	C	環境温度・湿度・圧力/屋外の天候/放射線	その他の建物内設備	C
			荷重	(有効に機能を発揮する)		-	海水		海水を通過しない	対象外	荷重	(有効に機能を発揮する)	-	
			海水	(海水を通過しない)		対象外	周辺機器等からの悪影響		(周辺機器等からの悪影響により機能を失うおそれがない)	-	海水	海水を通過しない	対象外	
			他設備からの影響	(周辺機器等からの悪影響により機能を失うおそれがない)		-	電磁的障害		(電磁波の影響を受けない)	-	電磁的障害	(電磁波により機能が損なわれない)	-	
			電磁波による影響	(電磁波により機能が損なわれない)		対象外	関連資料		59-7 保管場所図	-	周辺機器等からの悪影響	(周辺機器等からの悪影響により機能を失うおそれがない)	-	
			関連資料	[配置図] 59-3		-	関連資料		59-7 保管場所図	-	関連資料	[配置図] 59-3	-	
			操作性	中央制御室操作		A	操作性		中央制御室操作	A	操作性	中央制御室操作	A	
			関連資料	[保管場所図] 59-7		-	関連資料		59-7 保管場所図	-	関連資料	[保管場所図] 59-7	-	
			試験・検査(検査性、系統構成・外部入力)	計測制御設備		J	試験・検査(検査性、系統構成・外部入力)		計測制御設備	J	試験・検査(検査性、系統構成・外部入力)	計測制御設備	J	
	関連資料	-	-	関連資料	59-5 試験検査	-	関連資料	-	-					
	第4号	切り替え性	本来の用途として使用一切不要	A	切り替え性	本来の用途として使用する	対象外	切り替え性	本来の用途として使用一切不要	B b				
		関連資料	-	-	関連資料	-	-	関連資料	-	-				
		悪影響防止	系統設計	他設備から独立	A c	系統設計	他設備から独立	A c	系統設計	他設備から独立	A c			
			その他(飛散物)	(考慮対象なし)	対象外	その他(飛散物)	その他設備	対象外	その他(飛散物)	対象外	対象外			
			関連資料	[保管場所図] 59-7	-	関連資料	59-7 保管場所図	-	関連資料	[保管場所図] 59-7	-			
		設置場所	中央制御室操作	B	設置場所	中央制御室操作	B	設置場所	中央制御室操作	B				
		関連資料	[保管場所図] 59-7	-	関連資料	59-7 保管場所図	-	関連資料	[保管場所図] 59-7	-				
		第3項	可搬SAの容量	重大事故等への対処を本来の目的として設置するもの	A	可搬SAの容量	その他設備	C	可搬型SAの容量	その他設備	C			
			関連資料	-	-	関連資料	59-6 容量設定根拠	-	関連資料	-	-			
可搬SAの接続性			より簡単な接続	C	可搬SAの接続性	(対象外)	対象外	可搬型SAの接続性	(常設設備と接続しない)	-				
関連資料	-		-	異なる複数の接続箇所の確保	(対象外)	対象外	関連資料	-	-					
異なる複数の接続箇所の確保	対象外		対象外	関連資料	-	-	異なる複数の接続箇所の確保	対象外	対象外					
関連資料	-		-	設置場所	(放射線の高くなるおそれの少ない場所を選定)	-	関連資料	-	-					
設置場所	(放射線の高くなるおそれの少ない場所を選定)		-	関連資料	-	-	設置場所	(放射線の高くなるおそれの少ない場所を選定)	-					
保管場所	屋内(共通要因の考慮対象設備なし)	A b	保管場所	屋内	A a	保管場所	屋内(共通要因の考慮対象設備なし)	A b						
関連資料	-	-	関連資料	59-7 保管場所図	-	関連資料	-	-						
アクセスルート	屋内アクセスルートの確保	A	アクセスルート	対象外(アクセス不要)	-	アクセスルート	中央制御室又は緊急事対策所で保管及び使用する	対象外						
関連資料	-	-	関連資料	-	-	関連資料	-	-						
第7号	共通要因故障防止	環境条件、自然現象、外部人為事象、溢水、火災	防止設備-対象(代替対象D B設備有り)-屋内(中央制御室換気空調系設備と位置的分散)	A a	共通要因故障防止	環境条件、自然現象、外部人為事象、溢水、火災	屋内	A a	共通要因故障防止	環境条件、自然現象、外部人為事象、溢水、火災	緩和設備又は防止でも緩和でもない設備-対象(同一目的のSA設備、代替対象D B設備なし)	対象外		
	サポート系要因	(サポート系なし)	対象外	サポート系要因	(サポート系なし)	対象外	サポート系要因	対象外(サポート系なし)	対象外	サポート系要因	対象外(サポート系なし)	対象外		
関連資料	-	-	関連資料	59-7 保管場所図	-	関連資料	-	-						

柏崎刈羽原子力発電所 6/7号炉 (2017.12.20版)			東海第二発電所 (2018.9.18版)			島根原子力発電所 2号炉			備考			
柏崎刈羽原子力発電所6号及び7号炉 SA設備基準適合性一覧表(可搬)			東海第二発電所 SA設備基準適合性 一覧表(可搬型)			島根原子力発電所2号炉 SA設備基準適合性 一覧表(可搬型)						
第43条	第1項	59条:原子炉制御室	酸素濃度・二酸化炭素濃度計 (中央制御室・中央制御室待避室)	類型化区分	第59条:運転員が原子炉制御室にとどまるための設備	二酸化炭素濃度計	類型化区分	第59条:運転員が原子炉制御室にとどまるための設備	二酸化炭素濃度計 (中央制御室・中央制御室待避室)	類型化区分		
		第1号	環境条件における健全性	原子炉区域を除く原子炉建屋内及びその他の建屋内 (コントロール建屋) (有効に機能を発揮する)		C	原子炉建屋原子炉棟外		C	環境温度・湿度・圧力/ 屋外の天候/放射線	その他の建物内設備	C
			荷重	(有効に機能を発揮する)		-	海水		対象外	荷重	(有効に機能を発揮する)	-
			海水	(海水を通水しない)		対象外	周辺機器等からの悪影響		(周辺機器等からの悪影響により機能を失うおそれがない)	海水	海水を通水しない	対象外
			他設備からの影響	(周辺機器等からの悪影響により機能を失うおそれがない)		-	電磁的障害		(電磁波の影響を受けない)	電磁的障害	(電磁波により機能が損なわれない)	-
			電磁波による影響	(電磁波により機能が損なわれない)		対象外	関連資料		59-7 保管場所図	周辺機器等からの悪影響	(周辺機器等からの悪影響により機能を失うおそれがない)	-
			関連資料	[配置図] 59-3			操作性		中央制御室操作	関連資料	[配置図] 59-3	
			操作性	中央制御室操作		A	関連資料		59-7 保管場所図	操作性	中央制御室操作	A
			関連資料	[保管場所図] 59-7			試験・検査 (検査性、系統構成・外部入力)		計測制御設備	試験・検査 (検査性、系統構成・外部入力)	計測制御設備	J
			試験・検査 (検査性、系統構成・外部入力)	計測制御設備		J	関連資料		59-5 試験検査	関連資料	-	
	関連資料	-		切替性	本来の用途として使用する	切替性	本来の用途として使用する	対象外				
	第3項	第4号	切り替え性	本来の用途として使用一切替不要	A	第5号	悪影響防止	系統設計	他設備から独立	A c		
			関連資料	-			その他(飛散物)	その他設備	対象外			
		第5号	悪影響防止	他設備から独立	A c	第6号	設置場所	中央制御室操作	B			
			関連資料	(考慮対象なし)	対象外		関連資料	59-7 保管場所図				
		第6号	設置場所	中央制御室操作	B	第1号	可搬SAの容量	その他設備	C			
			関連資料	[保管場所図] 59-7			関連資料	59-6 容量設定根拠				
		第1号	可搬SAの容量	重大事故等への対処を本来の目的として設置するもの	A	第2号	可搬SAの接続性	(対象外)	対象外			
			関連資料	-			関連資料	-				
		第2号	可搬SAの接続性	より簡単な接続	C	第3号	異なる複数の接続箇所の確保	(対象外)	対象外			
関連資料			-		関連資料		-					
第3号	異なる複数の接続箇所の確保	対象外	対象外	第4号	設置場所	(放射線の高くなるおそれの少ない場所を選定)	-					
	関連資料	-			関連資料	-						
第4号	設置場所	(放射線量の高くなるおそれの少ない場所を選定)	-	第5号	保管場所	屋内	A a					
	関連資料	-			関連資料	59-7 保管場所図						
第5号	保管場所	屋内(共通要因の考慮対象設備なし)	A b	第6号	アクセスルート	対象外(アクセス不要)	-					
	関連資料	-			関連資料	-						
第6号	アクセスルート	屋内アクセスルートの確保	A	第7号	共通要因故障防止	環境条件、自然現象、外部人為事象、溢水、火災	屋内	A a				
	関連資料	-			サポート系による要因	(サポート系なし)	対象外					
第7号	共通要因故障防止	防止設備-対象(代替対象D B設備有り)-屋内 (中央制御室換気空調系設備と位置的分散)	A a	関連資料	59-7 保管場所図							
	サポート系要因	(サポート系なし)	対象外	関連資料	-							
第3項	第1号	可搬型SAの容量	その他設備	C	第3号	異なる複数の接続箇所の確保	対象外	対象外				
		関連資料	[保管場所図] 59-7			関連資料	-					
第2号	可搬型SAの接続性	(常設設備と接続しない)	-	第4号	設置場所	(放射線量の高くなるおそれの少ない場所を選定)	-					
	関連資料	-			関連資料	-						
第3号	異なる複数の接続箇所の確保	対象外	対象外	第5号	保管場所	屋内(共通要因の考慮対象設備なし)	A b					
	関連資料	-			関連資料	-						
第4号	設置場所	(放射線量の高くなるおそれの少ない場所を選定)	-	第6号	アクセスルート	中央制御室又は緊急事対策所で保管及び使用する	対象外					
	関連資料	-			関連資料	-						
第5号	保管場所	屋内(共通要因の考慮対象設備なし)	A b	第7号	共通要因故障防止	環境条件、自然現象、外部人為事象、溢水、火災	緩和設備又は防止でも緩和でもない設備-対象(同一目的のSA設備、代替対象D B設備なし)	対象外				
	関連資料	-			サポート系要因	(サポート系なし)	対象外					
第6号	アクセスルート	中央制御室又は緊急事対策所で保管及び使用する	対象外	関連資料	-							
	関連資料	-		関連資料	-							

柏崎刈羽原子力発電所 6/7号炉 (2017.12.20版)		東海第二発電所 (2018.9.18版)		島根原子力発電所 2号炉		備考	
<p>柏崎刈羽原子力発電所6号及び7号炉 SA設備基準適合性一覧表(可搬)</p>							
59条：原子炉制御室		中央制御室待避室遮蔽(可搬型)		類型化区分			
第43条	第1項	第1号	環境条件	環境温度・湿度・圧力/屋外の天候/放射線	原子炉区域を除く原子炉建屋内及びその他の建屋内(コントロール建屋)	C	
			荷重	(有効に機能を発揮する)		-	
			海水	(海水を漏水しない)		対象外	
			他設備からの影響	(周辺機器等からの悪影響により機能を失うおそれがない)		-	
			電磁波による影響	(電磁波により機能が損なわれない)		対象外	
		関連資料	[配置図] 59-3				
		第2号	操作性	(操作不要)		対象外	
			関連資料	-			
		第3号	試験・検査(検査性、系統構成・外部入力)	遮蔽		K	
			関連資料	-			
	第4号	切り替え性	本来の用途として使用一切不要		B b		
		関連資料	-				
	第5号	悪影響防止	系統設計	他設備から独立	A c		
			その他(飛散物)	(考慮対象なし)	対象外		
		関連資料	-				
	第6号	設置場所	(操作不要)		対象外		
		関連資料	-				
	第3項	第1号	可搬SAの容量	重大事故等への対処を本来の目的として設置するもの	A		
			関連資料	[被ばく評価]59-11			
		第2号	可搬SAの接続性	(接続不要)		対象外	
			関連資料	-			
第3号		異なる複数の接続箇所の確保	対象外		対象外		
		関連資料	-				
第4号		設置場所	(放射線量の高くなるおそれのない場所を選定)		-		
		関連資料	-				
第5号		保管場所	屋内(共通要因の考慮対象設備なし)		A b		
		関連資料	-				
第6号	アクセスルート	(アクセス不要)		対象外			
	関連資料	[配置図] 59-3					
第7号	共通悪影響防止	環境条件、自然現象、外部人為事象、漏水、火災	同一機能の設備なし又は代替対象D B設備なし	対象外			
		サポート系要因	(サポート系なし)	対象外			
		関連資料	-				
<p>・設備の相違【柏崎6/7】 島根2号炉では、常設の待避室遮蔽を使用</p>							

柏崎刈羽原子力発電所 6/7号炉 (2017.12.20版)			東海第二発電所 (2018.9.18版)			島根原子力発電所 2号炉			備考			
柏崎刈羽原子力発電所6号及び7号炉 SA設備基準適合性一覧表(常設)			東海第二発電所 SA設備基準適合性 一覧表(常設)			島根原子力発電所2号炉 SA設備基準適合性 一覧表(常設)						
第43条	第1項	環境条件における健全性	第59条: 原子炉制御室	非常用ガス処理系排風機	類型化区分	第59条: 運転員が原子炉制御室にとどまるための設備	非常用ガス再循環系排風機	類型化区分	第59条: 運転員が原子炉制御室にとどまるための設備	非常用ガス処理系排気ファン	類型化区分	
			環境温度・湿度・圧力/屋外の天候/放射線	原子炉建屋原子炉棟内	B	環境温度・環境圧力・湿度/屋外の天候/放射線/荷重	原子炉建屋原子炉棟内	B	海水を通過しない	原子炉建屋原子炉棟内	B	
			荷重	(有効に機能を発揮する)	—	海水	海水を通過しない	対象外	海水を通過しない	原子炉建物原子炉棟内設備	B	
			海水	(海水を通過しない)	対象外	周辺機器等からの悪影響	(周辺機器等からの悪影響により機能を失うおそれがない)	—	(周辺機器等からの悪影響により機能を失うおそれがない)	(有効に機能を発揮する)	—	
			他設備からの影響	(周辺機器等からの悪影響により機能を失うおそれがない)	—	電磁的障害	(電磁波の影響を受けない)	—	(電磁波の影響を受けない)	海水を通過しない	対象外	
			電磁的障害	(電磁波により機能が損なわれない)	—	関連資料	59-3 配置図	—	59-3 配置図	周辺機器等からの悪影響	(周辺機器等からの悪影響により機能を失うおそれがない)	—
			関連資料	[配置図]59-3, [系統図]59-4	—	関連資料	59-3 配置図	—	59-3 配置図	電磁波による影響	(電磁波により機能が損なわれない)	—
			操作性	中央制御室操作	A	操作性	中央制御室操作	A	中央制御室操作	関連資料	[配置図]59-3, [系統図]59-4	—
			関連資料	[配置図]59-3	—	試験・検査(検査性、系統構成・外部入力)	ファン	A	ファン	試験・検査(検査性、系統構成・外部入力)	ファン	A, B
			試験・検査(検査性、系統構成・外部入力)	排風機、弁	A, B	関連資料	59-5 試験検査	—	59-5 試験検査	関連資料	[試験及び検査]59-5	—
	関連資料	[試験及び検査]59-5	—	切り替え性	本来の用途として使用一切替必要	Ba	本来の用途として使用一切替必要	切り替え性	本来の用途として使用一切替必要	Ba		
	切り替え性	本来の用途として使用一切替必要	Ba	関連資料	[系統図]59-4	—	[系統図]59-4	関連資料	[系統図]59-4	—		
	関連資料	[系統図]59-4	—	第2項	悪影響防止	系統設計	DB施設と同じ系統構成	Ad	系統設計	DB施設と同様の系統構成	Ad	
	系統設計	DB施設と同じ系統構成	Ad			その他(飛散物)	対象外	対象外	その他(飛散物)	高速回転機器	Bb	
	その他(飛散物)	対象外	対象外			関連資料	[配置図]59-3, [系統図]59-4	—	関連資料	[配置図]59-3, [系統図]59-4	—	
	設置場所	中央制御室操作	B	設置場所	中央制御室操作	B	中央制御室操作	設置場所	中央制御室操作	B		
	関連資料	[配置図]59-3	—	関連資料	[配置図]59-3	—	[配置図]59-3	関連資料	[配置図]59-3	—		
	常設SAの容量	設計基準対処施設の系統及び機器の容量等が十分	B	常設SAの容量	設計基準対処施設の系統及び機器の容量等が十分	B	設計基準対処施設の系統及び機器の容量等が十分	常設SAの容量	設計基準対処施設の系統及び機器の容量等が十分	B		
	関連資料	[容量設定根拠]59-6	—	共用の禁止	(共用しない設備)	対象外	(共用しない設備)	共用の禁止	共用しない設備	対象外		
	共用の禁止	(共用しない設備)	対象外	第3項	共通要因故障防止	環境条件、自然現象、外部人為事象、溢水、火災	緩和設備又は防止でも緩和でもない設備-対象(同一目的のSA設備なし)	対象外	環境条件、自然現象、外部人為事象、溢水、火災	防止設備-対象(代替対象DB設備あり)-屋内	Aa	
環境条件、自然現象、外部人為事象、溢水、火災	緩和設備又は防止でも緩和でもない設備-対象(同一目的のSA設備なし)	対象外	サポート系故障			対象(サポート系有り)-異なる駆動源又は冷却源	Ca	サポート系故障	対象(サポート系有り)-異なる駆動源又は冷却源	Ca		
サポート系故障	対象(サポート系有り)-異なる駆動源又は冷却源	Ca	関連資料			[配置図]59-3, [系統図]59-4	—	関連資料	[単線結線図]59-2, [配置図]59-3, [系統図]59-4	—		

東海第二発電所 SA 設備基準適合性 一覧表 (常設)

第59条:運転員が原子炉制御室にとどまるための設備		中央制御室換気系 フィルタユニット	類型化 区分	ブローアウトパネル閉止装置	類型化 区分	
第1項	環境条件における健全性	原子炉建屋原子炉棟外	C	屋外	D	
		海水	海水を通水しない	対象外	海水を通水しない	対象外
		周辺機器等からの悪影響	(周辺機器等からの悪影響により機能を失うおそれがない)	—	(周辺機器等からの悪影響により機能を失うおそれがない)	—
		電磁的障害	(電磁波の影響を受けない)	—	(電磁波の影響を受けない)	—
		関連資料	59-3 配置図	—	59-3 配置図	—
	第2項	操作性	操作不要	対象外	中央制御室操作	A
		関連資料	—	—	59-3 配置図	—
		試験・検査 (検査性, 系統構成・外部入力)	空調ユニット	E	その他	M
		関連資料	59-5 試験検査	—	—	—
		切替性	本来の用途として使用する	対象外	本来の用途として使用する	対象外
第3項	悪影響防止	系統設計	DB施設と同じ系統構成	A d	他設備から独立	A c
		その他(飛散物)	その他設備	対象外	その他設備	対象外
	関連資料	59-4 系統図	—	59-4 系統図	—	
	設置場所	操作不要	対象外	中央制御室操作	B	
	関連資料	—	—	—	—	
第2項	常設 SA の容量	設計基準対象施設の系統及び機器を使用するもの 必要な容量等に対して十分であるもの	B	重大事故等への対処を本来の目的として設置するもの	A	
		関連資料	—	—	—	
	共用の禁止	共用しない設備	対象外	共用しない設備	対象外	
	関連資料	—	—	—	—	
	共通要因故障防止	環境条件, 自然現象, 外部人為事象, 溢水, 火災 サポート系による要因	位置的分散を考慮すべき DB 設備等がない	対象外	位置的分散を考慮すべき DB 設備等がない	対象外
関連資料	—	—	—	—		

島根原子力発電所 2号炉 SA 設備基準適合性 一覧表 (常設)

第59条:運転員が原子炉制御室にとどまるための設備		原子炉建物燃料取替階ブローアウトパネル閉止装置	類型化 区分	
第1項	環境条件における健全性	原子炉建物原子炉棟内設備	B	
		荷重	(有効に機能を発揮する)	—
		海水	海水を通水しない	対象外
		電磁的障害	(電磁波により機能が損なわれない)	—
		周辺機器等からの悪影響	(周辺機器等からの悪影響により機能を失うおそれがない)	—
	第2項	操作性	中央制御室操作, 弁操作	A, B f
		関連資料	—	—
		試験・検査 (検査性, 系統構成・外部入力)	その他	M
		関連資料	—	—
		切替性	本来の用途以外の用途として使用しない 一切替操作が不要	B b
第3項	悪影響防止	系統設計	他設備から独立	A c
		その他(飛散物)	対象外	対象外
	関連資料	—	—	
	設置場所	中央制御室操作(遠隔), 現場操作(設置場所)	A a, B	
	関連資料	—	—	
第2項	常設 SA の容量	重大事故等への対処を本来の目的として設置するもの	A	
		関連資料	—	—
	共用の禁止	共用しない設備	対象外	
	関連資料	—	—	
	共通要因故障防止	環境条件, 自然現象, 外部人為事象, 溢水, 火災 サポート系要因	緩和設備又は防止でも緩和でもない設備 —対象(同一目的の SA 設備なし)	対象外
関連資料	—	—		

・設備の相違
【柏崎 6/7】
島根 2号炉では, 重大事故等対処設備としてブローアウトパネル閉止装置を設置
【東海第二】
島根 2号炉では, 原子炉建物燃料取替階に閉止装置を設置

実線・・・設備運用又は体制等の相違（設計方針の相違）
 波線・・・記載表現、設備名称の相違（実質的な相違なし）

まとめ資料比較表〔59条 補足説明資料 59-2 単線結線図〕

柏崎刈羽原子力発電所 6 / 7号炉 (2017. 12. 20 版)	東海第二発電所 (2018. 9. 18 版)	島根原子力発電所 2号炉	備考
<p style="text-align: center;">59-2 単線結線図</p>	<p style="text-align: center;">59-2 単線結線図</p>	<p style="text-align: center;">59-2 単線結線図</p>	

柏崎刈羽原子力発電所 6/7号炉 (2017.12.20版)



図 59-2-1 6号炉常設代替交流電源設備系統図 (ガスタービン発電機～緊急用M/C～中央制御室)

東海第二発電所 (2018.9.18版)

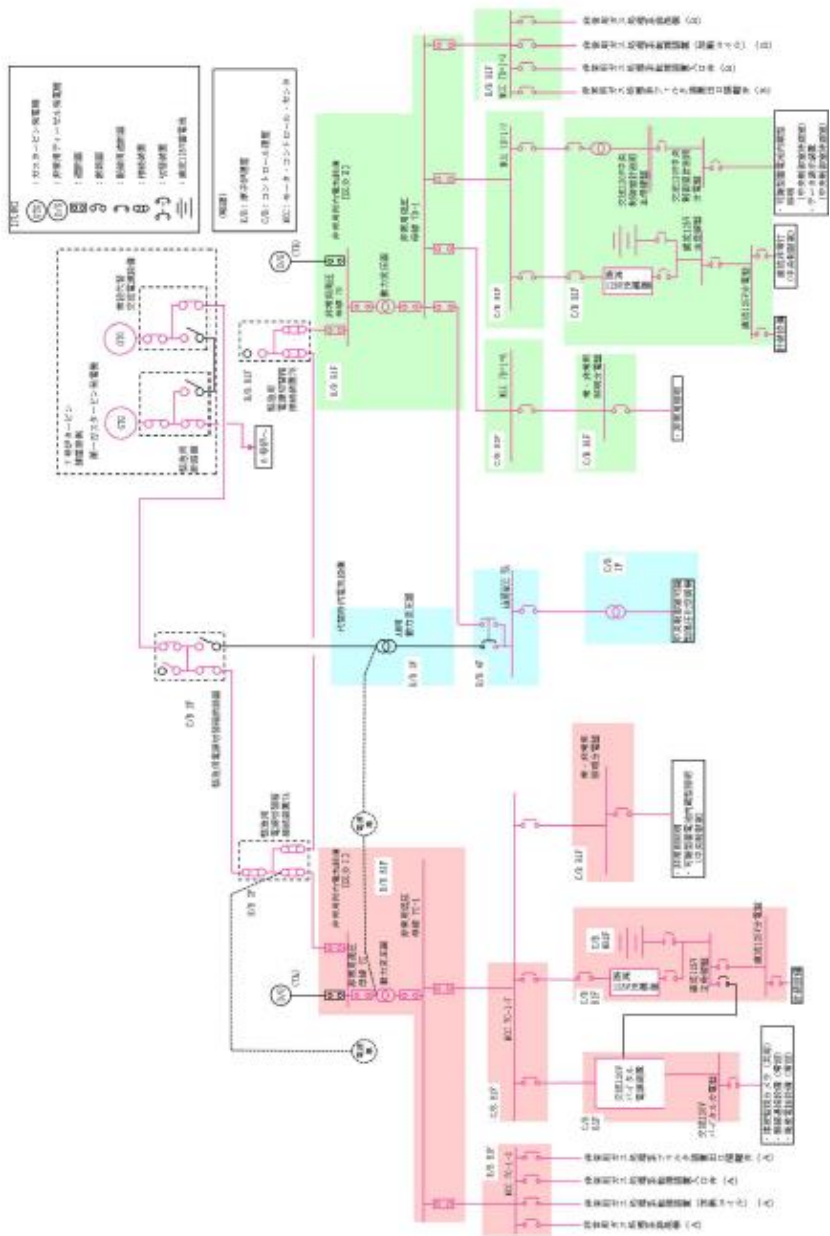
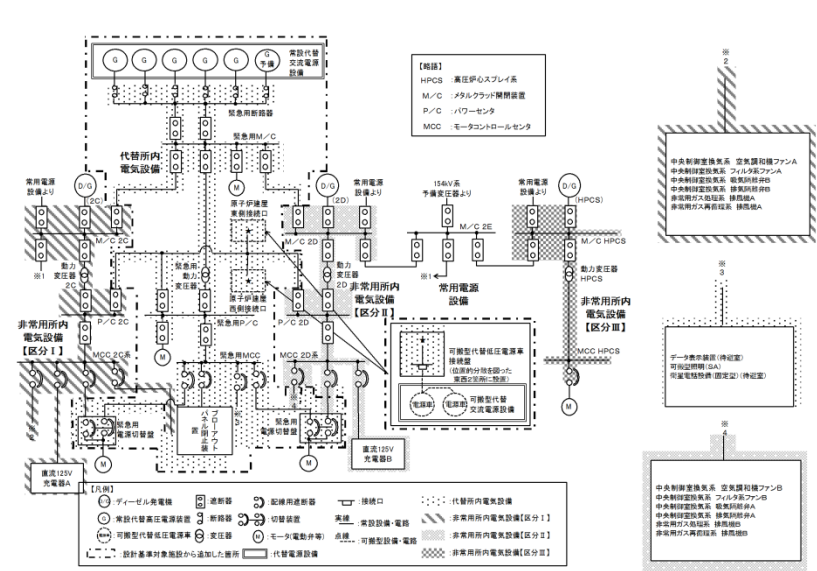

第 59-2-1 図 単線結線図 (交流電源設備) (1/2)

島根原子力発電所 2号炉



図 59-2-1 常設代替交流電源構成図

備考

・設備の相違
 【柏崎6/7, 東海第二】
 使用する設備の相違に伴う電源構成の相違

柏崎刈羽原子力発電所 6 / 7号炉 (2017. 12. 20版)

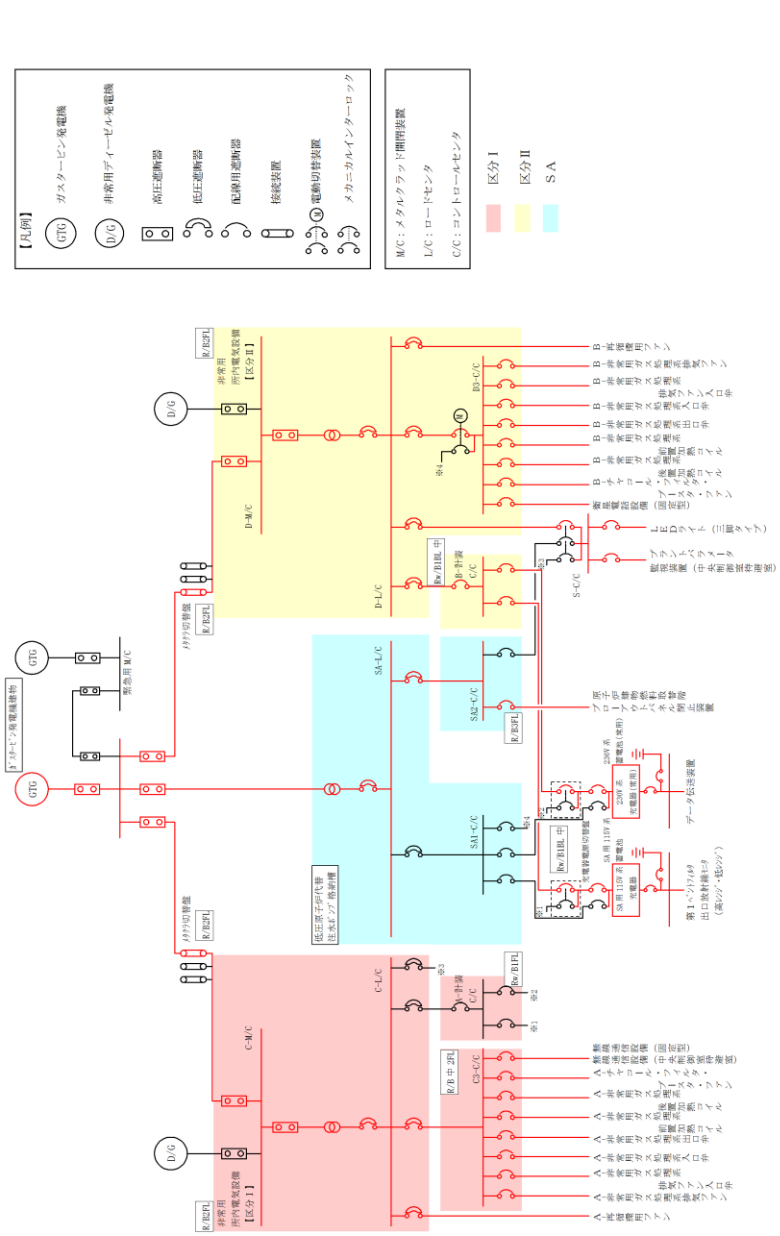
東海第二発電所 (2018. 9. 18版)

島根原子力発電所 2号炉

備考

・設備の相違
【柏崎6/7, 東海第二】
 使用する設備の相違に伴う電源構成の相違

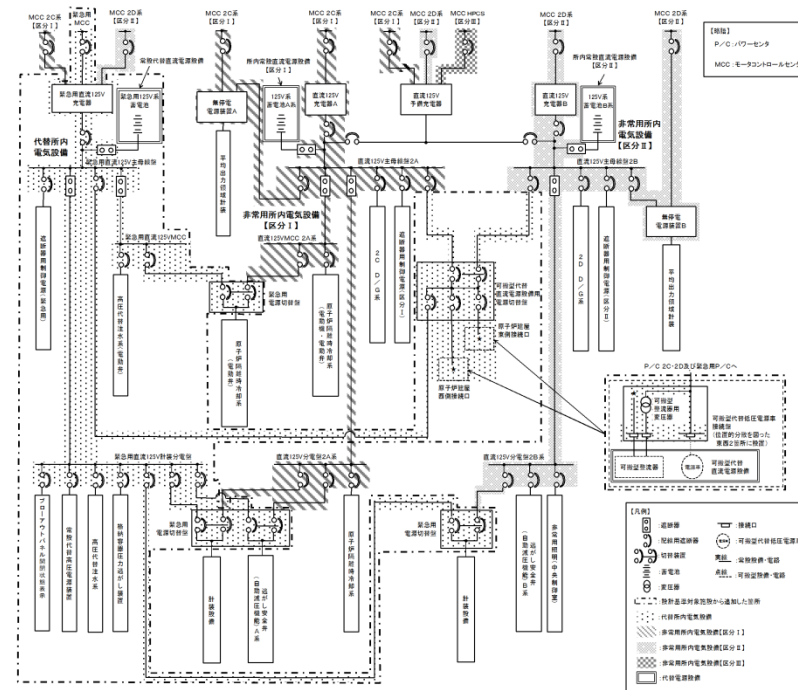

第 59-2-1 図 単線結線図 (交流電源設備) (2/2)



柏崎刈羽原子力発電所 6 / 7号炉 (2017. 12. 20 版)	東海第二発電所 (2018. 9. 18 版)	島根原子力発電所 2号炉	備考
			<ul style="list-style-type: none"> 申請号炉数の相違【柏崎 6/7】

図 59-2-2 7号炉常設代替交流電源設備系統図 (ガスタービン発電機～緊急用M/C～中央制御室)

実線・・設備運用又は体制等の相違（設計方針の相違）
 波線・・記載表現、設備名称の相違（実質的な相違なし）

まとめ資料比較表 [59 条 補足説明資料 59-3 配置図]

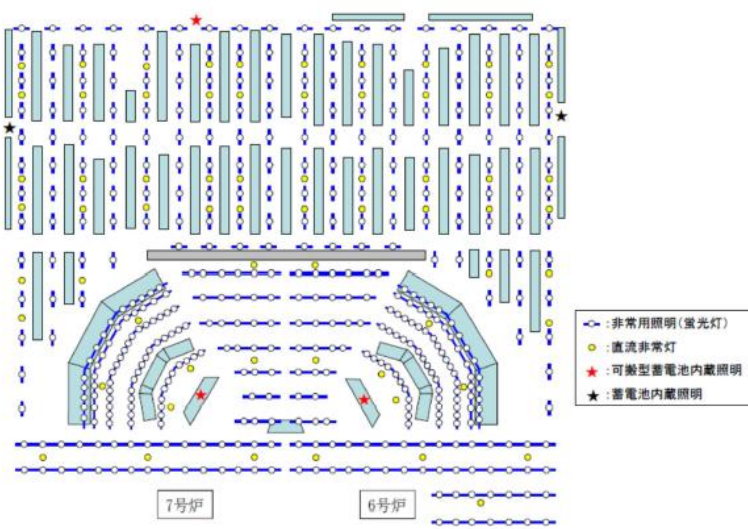
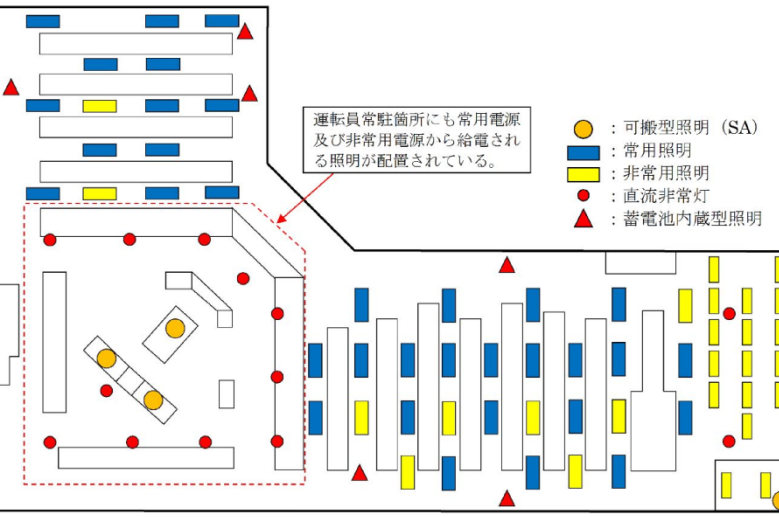
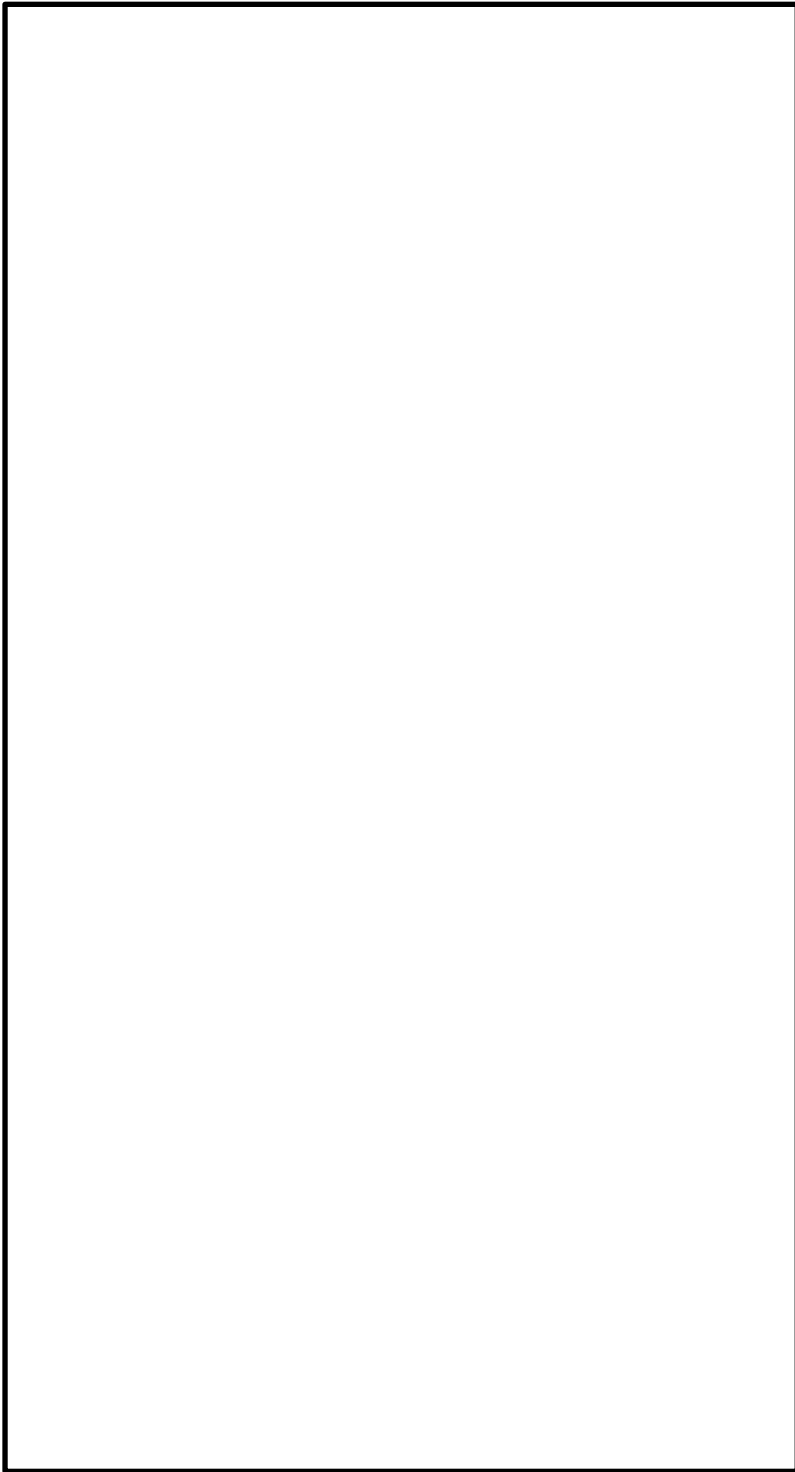
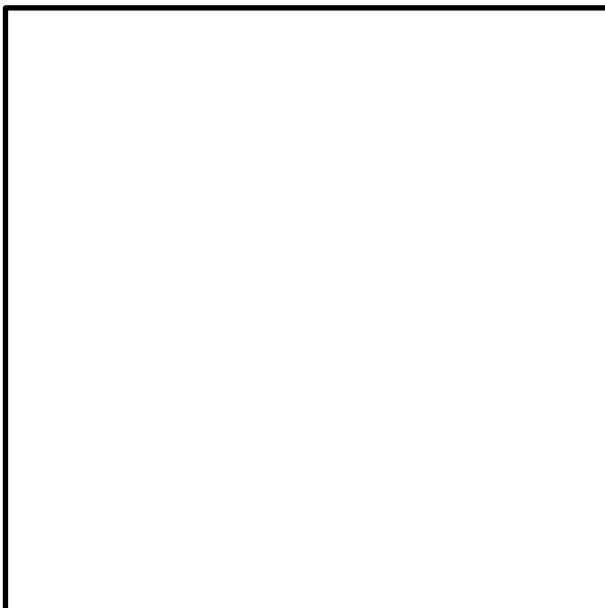
柏崎刈羽原子力発電所 6 / 7 号炉 (2017. 12. 20 版)	東海第二発電所 (2018. 9. 18)	島根原子力発電所 2 号炉	備考
<p style="text-align: center;">59-3</p> <p style="text-align: center;">配置図</p>	<p style="text-align: center;">59-3</p> <p style="text-align: center;">配置図</p>	<p style="text-align: center;">59-3</p> <p style="text-align: center;">配置図</p>	

柏崎刈羽原子力発電所 6 / 7号炉 (2017. 12. 20 版)	東海第二発電所 (2018. 9. 18)	島根原子力発電所 2号炉	備考
			<p>・設備の相違 【柏崎 6/7, 東海第二】 中央制御室レイアウト 相違に伴う配置の相違</p>
<p>図 59-3-1 中央制御室 可搬型蓄電池内蔵型照明 配置図 (使用時)</p>	<p>第 59-3-10 図 中央制御室照明に係る機器配置図</p>		
			
<p>図 59-3-2 中央制御室待避室 可搬型蓄電池内蔵型照明 配置図 (使用時)</p>	<p>第 59-3-11 図 可搬型照明 (SA) 配置図</p>	<p>図 59-3-1 中央制御室 LEDライト (三脚タイプ) 配置図 (中央制御室における使用時)</p>	

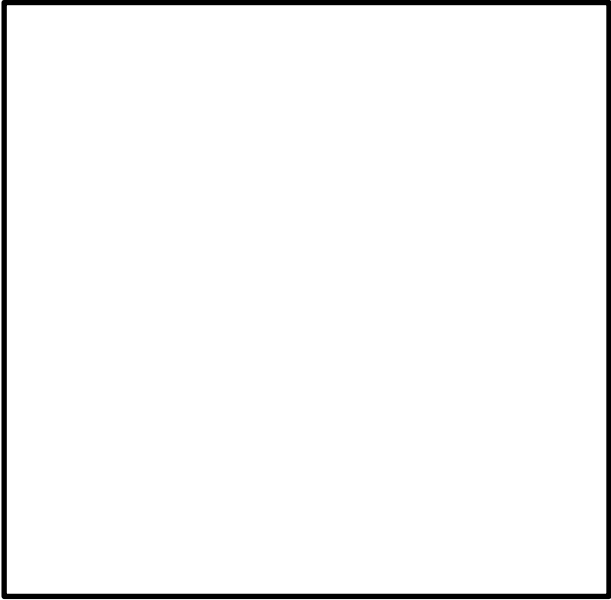
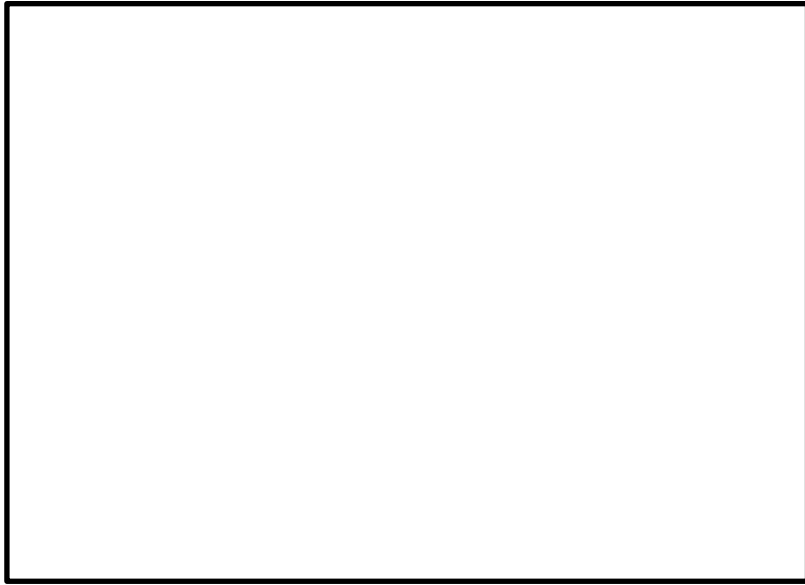
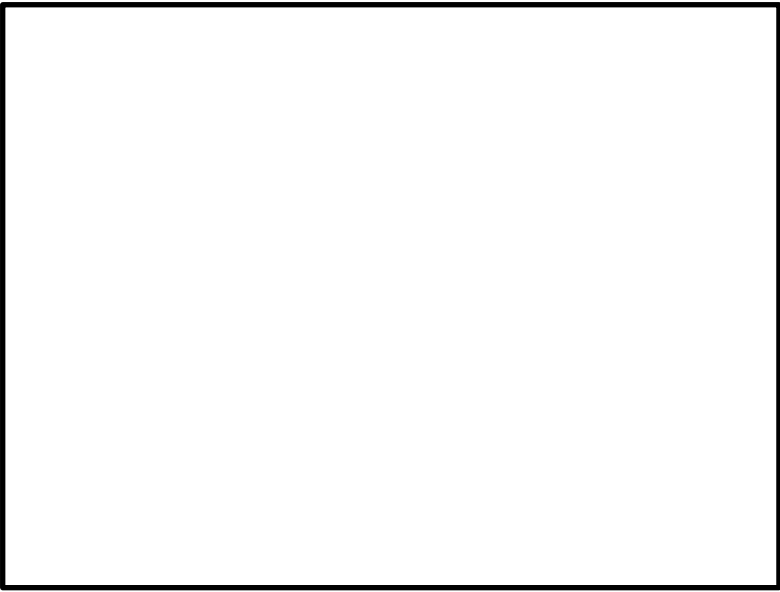
柏崎刈羽原子力発電所 6 / 7号炉 (2017. 12. 20 版)	東海第二発電所 (2018. 9. 18)	島根原子力発電所 2号炉	備考
 <p data-bbox="154 840 923 961">図 59-3-3 中央制御室及び中央制御室待避室の陽圧化バウンダリ配置図 (コントロール建屋地上1階及び2階)</p>	 <p data-bbox="1020 840 1641 871">第 59-3-7 図 中央制御室待避室に係る機器配置図</p>	 <p data-bbox="1742 840 2502 915">図59-3-2 中央制御室, 中央制御室待避室の正圧化バウンダリ構成図</p>	

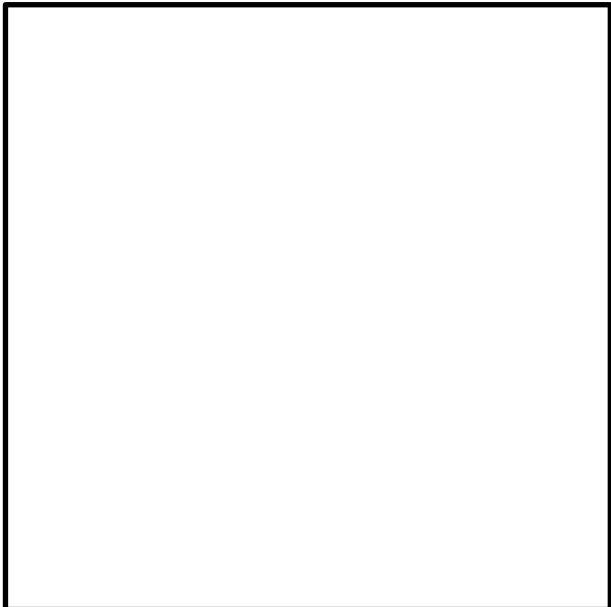
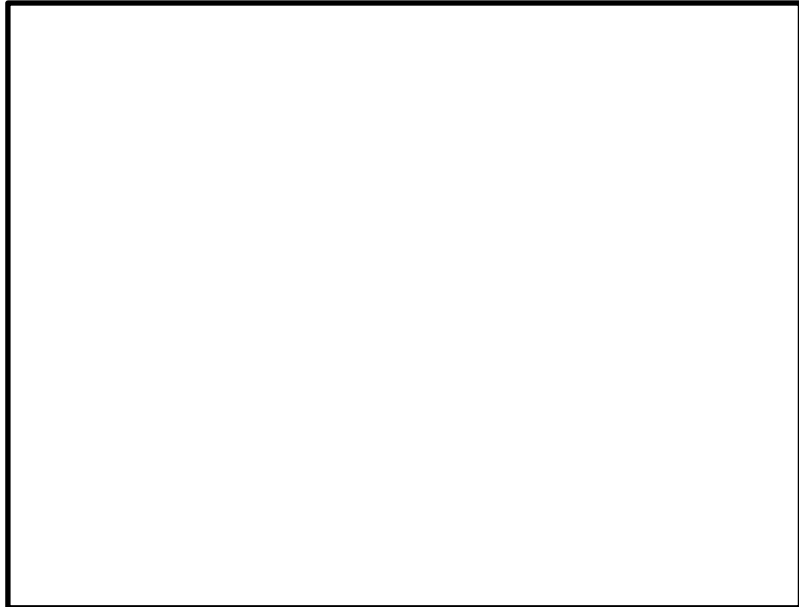
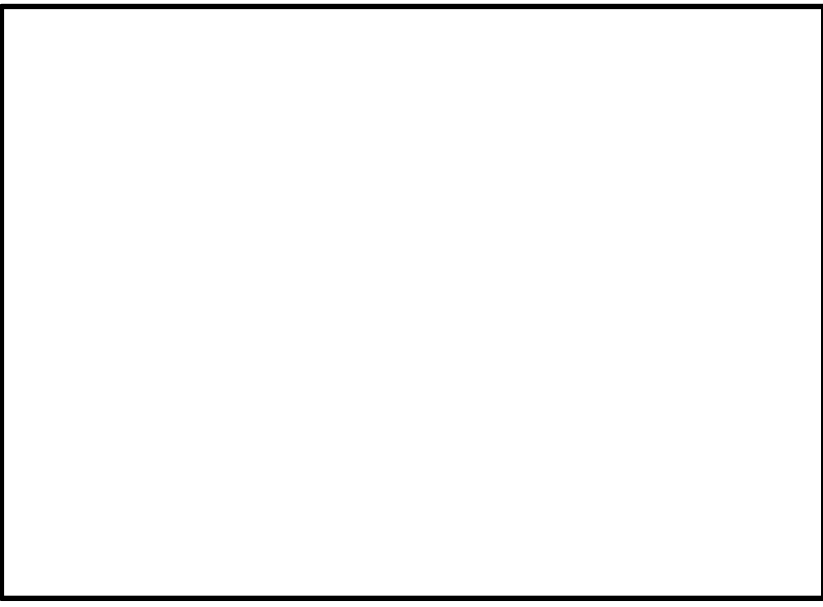
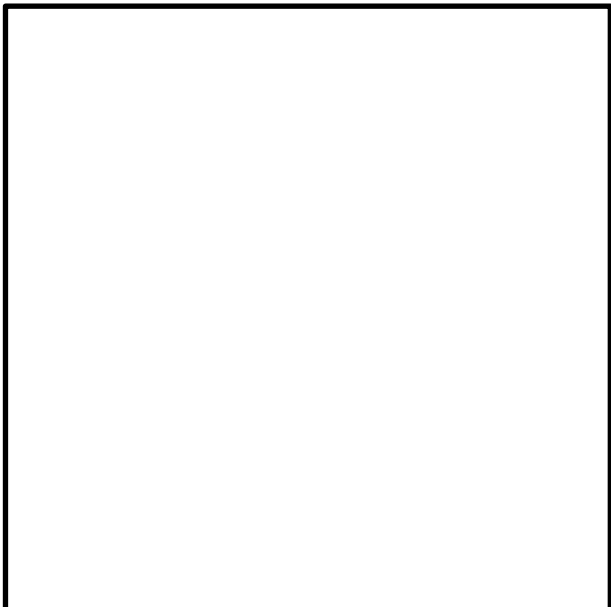

柏崎刈羽原子力発電所 6 / 7号炉 (2017. 12. 20 版)	東海第二発電所 (2018. 9. 18)	島根原子力発電所 2号炉	備考
<div data-bbox="252 226 822 800" data-label="Image"> </div> <div data-bbox="148 877 926 1008" data-label="Caption"> <p>図 59-3-4 中央制御室換気空調系給気及び排気隔離ダンパ 配置 <u>図 (7号炉)</u> <u>(コントロール建屋地上2階)</u></p> </div>			<ul style="list-style-type: none"> 申請号炉数の相違 【柏崎 6/7】

柏崎刈羽原子力発電所 6 / 7号炉 (2017. 12. 20 版)	東海第二発電所 (2018. 9. 18)	島根原子力発電所 2号炉	備考
			
<p>図 59-3-5 中央制御室換気空調系給気及び排気隔離ダンパ 配置図 (6号炉) (コントロール建屋地上2階)</p>	<p>第59-3-2図 中央制御室換気系に係る機器配置図</p>	<p>図59-3-3 中央制御室換気系給排気隔離弁 配置図 (原子炉建物地上2階)</p>	
 <p>図 59-3-6 中央制御室可搬型陽圧化空調機 配置図 (コントロール建屋地上1階及び2階)</p>			

柏崎刈羽原子力発電所 6 / 7号炉 (2017. 12. 20 版)	東海第二発電所 (2018. 9. 18)	島根原子力発電所 2号炉	備考
	<div data-bbox="1050 239 1614 936" data-label="Image"> </div> <div data-bbox="1003 968 1653 1008" data-label="Caption"> <p>第59-3-4図 ブローアウトパネル閉止装置 配置図</p> </div> <div data-bbox="1050 1115 1614 1799" data-label="Image"> </div> <div data-bbox="1003 1820 1653 1860" data-label="Caption"> <p>第59-3-5図 ブローアウトパネル閉止装置 配置図</p> </div>	<div data-bbox="1783 275 2457 982" data-label="Image"> </div> <div data-bbox="1727 1014 2516 1096" data-label="Caption"> <p>図59-3-4 原子炉建物燃料取替階ブローアウトパネル閉止装置 配置図 (原子炉建物地上4階)</p> </div>	

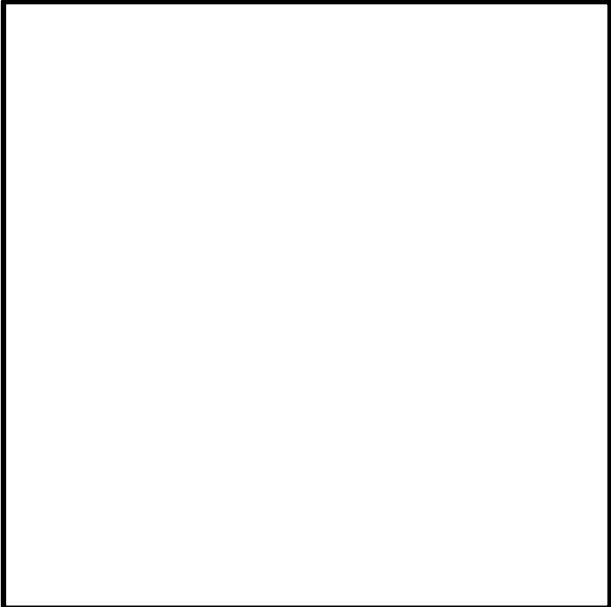
柏崎刈羽原子力発電所 6 / 7号炉 (2017. 12. 20 版)	東海第二発電所 (2018. 9. 18)	島根原子力発電所 2号炉	備考
			
<p>図 59-3-7 中央制御室待避室 陽圧化装置(空気ポンペ) 配置図</p>	<p>第 59-3-6 図 中央制御室待避室空気ポンベユニット (空気ポンベ) 配置図</p>	<p>図 59-3-5 中央制御室待避室及び中央制御室待避室正圧化装置 (空気ポンベ) 配置図 (制御室建物地上 4 階及び廃棄物処理建物地上 1 階及び 2 階)</p>	
			
<p>図 59-3-8 中央制御室待避室 陽圧化装置(空気ポンペ) 配置図 (廃棄物処理建屋地上 1 階)</p>			

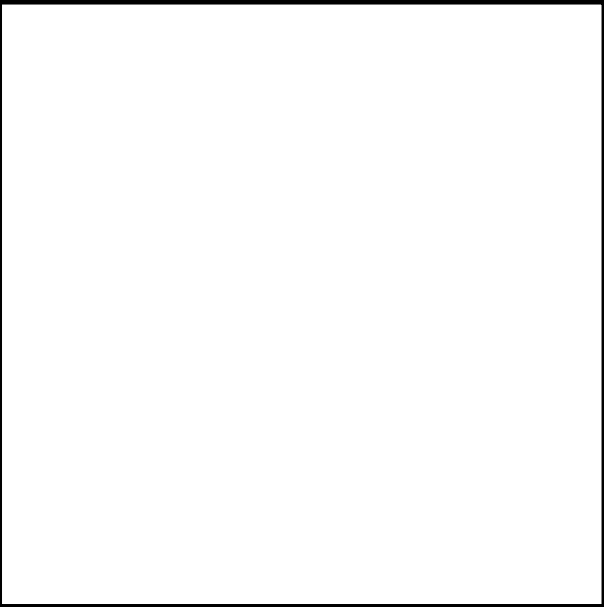

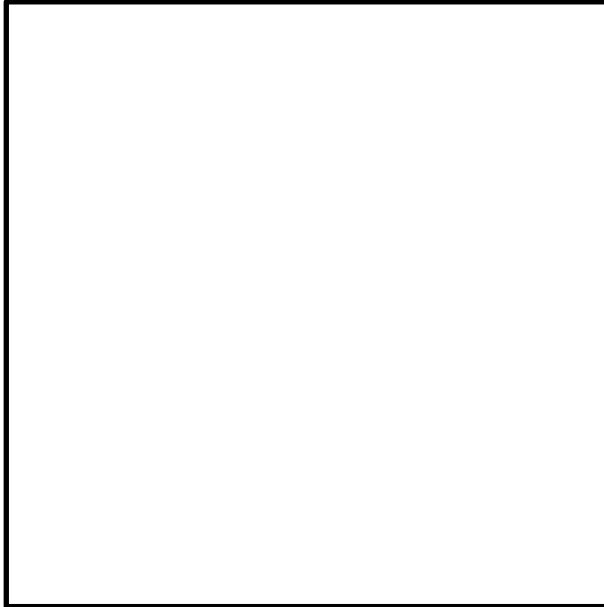
柏崎刈羽原子力発電所 6 / 7号炉 (2017. 12. 20 版)	東海第二発電所 (2018. 9. 18)	島根原子力発電所 2号炉	備考
 <p data-bbox="281 840 792 871">図 59-3-9 中央制御室待避室遮蔽 配置図</p>	 <p data-bbox="1083 840 1573 871">第 59-3-1 図 中央制御室遮蔽 配置図</p>	 <p data-bbox="1789 840 2457 913">図 59-3-6 中央制御室遮蔽及び中央制御室待避室遮蔽 (制御室建物地上 4 階)</p>	

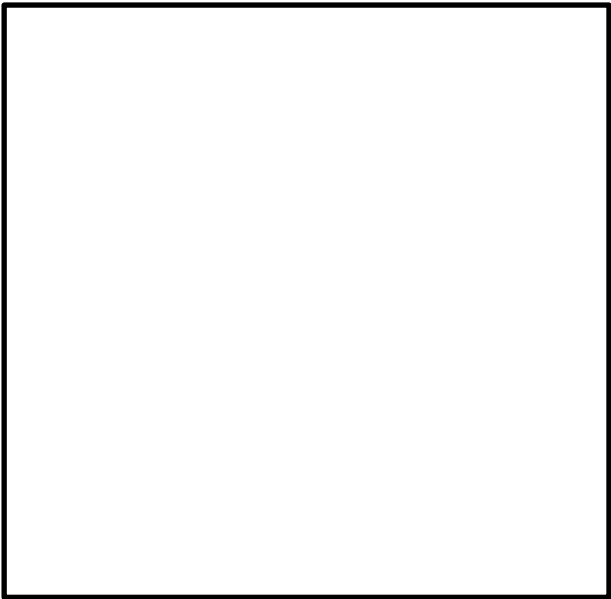
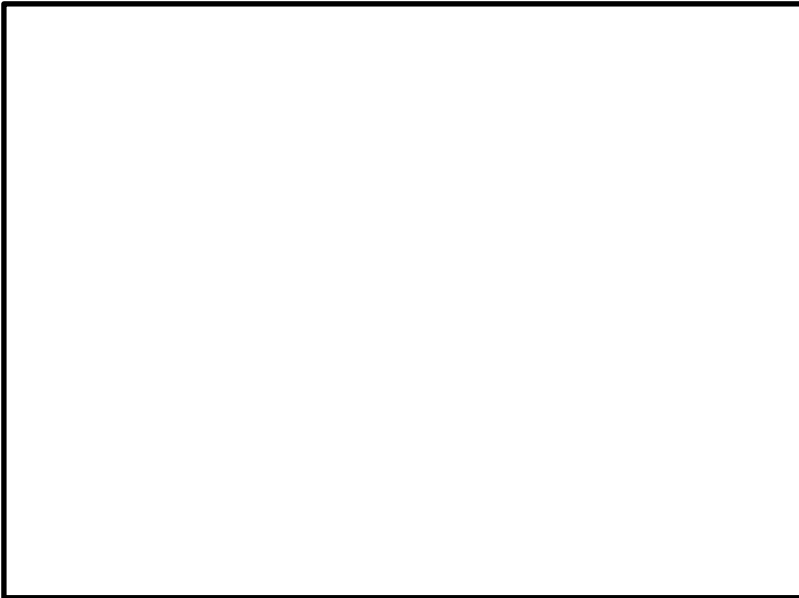
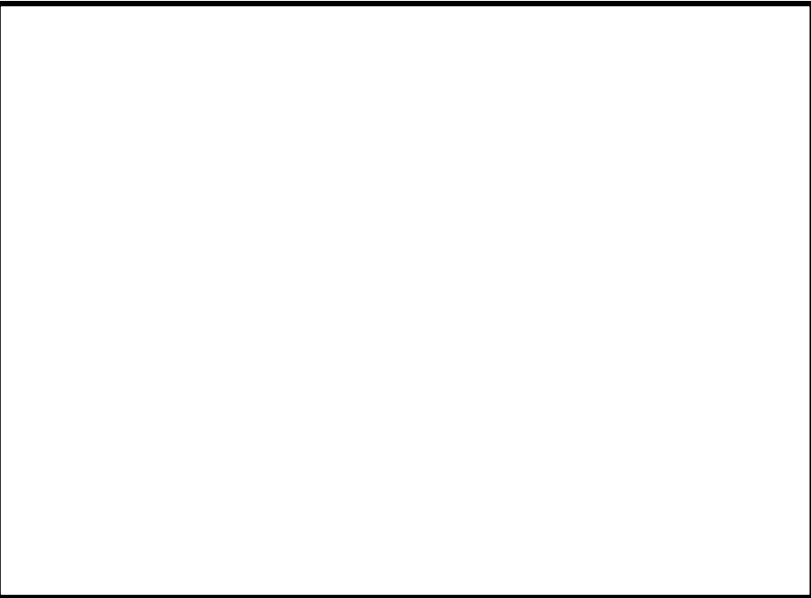
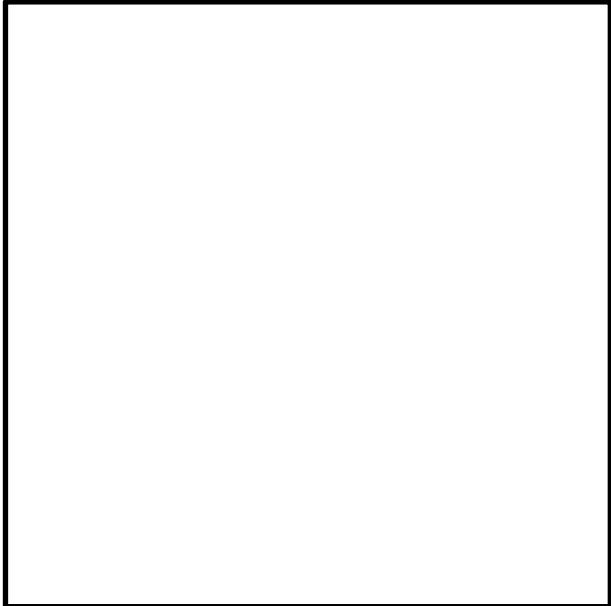
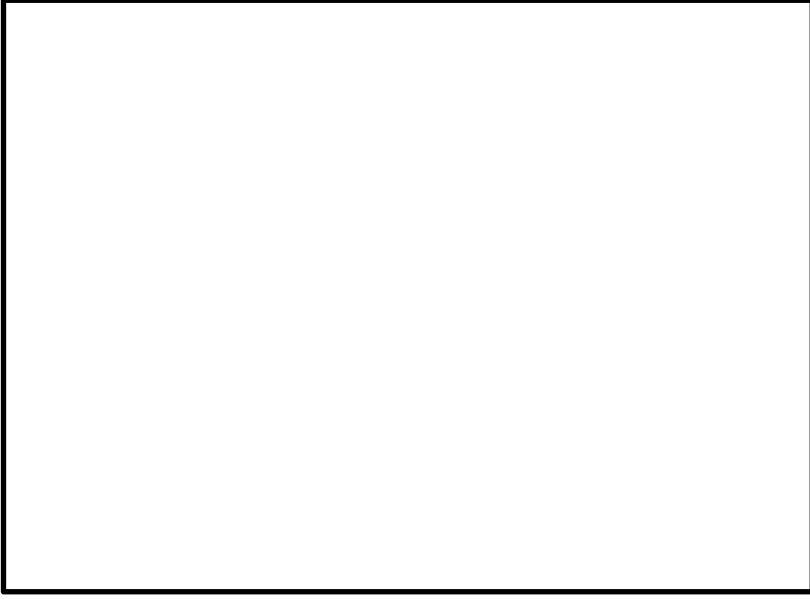
柏崎刈羽原子力発電所 6 / 7号炉 (2017. 12. 20 版)	東海第二発電所 (2018. 9. 18)	島根原子力発電所 2号炉	備考
 <p data-bbox="186 842 875 957">図 59-3-10 無線連絡設備 (常設), 衛星電話設備 (常設) 配置図 (コントロール建屋地上 2 階)</p>		 <p data-bbox="1739 842 2502 957">図 59-3-7 無線通信設備 (固定型), 衛星電話設備 (固定型), 有線式通信設備 配置図 (制御室建物地上 4 階)</p>	
 <p data-bbox="278 1692 804 1766">図 59-3-11 送受話器 (制御装置) 配置図 (コントロール建屋地下 2 階)</p>	 <p data-bbox="1041 1692 1614 1724">第 59-3-8 図 送受話器 (制御装置) 配置図</p>	 <p data-bbox="1804 1692 2445 1766">図 59-3-8 所内通信連絡設備 (制御装置) 配置図 (廃棄物処理建物地上 1 階)</p>	

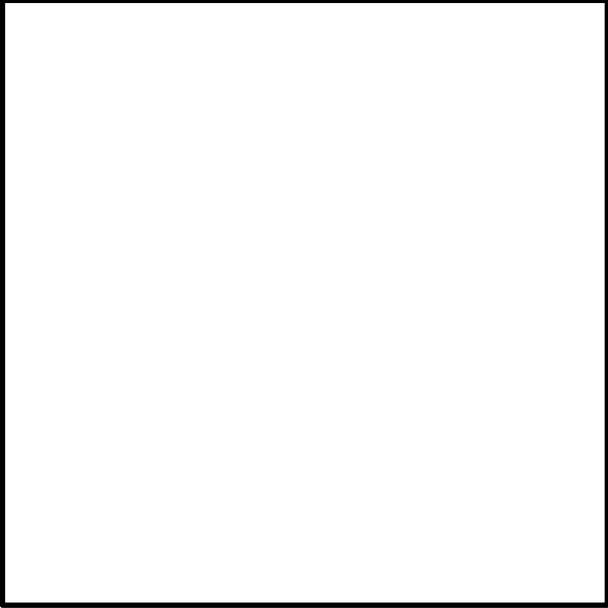
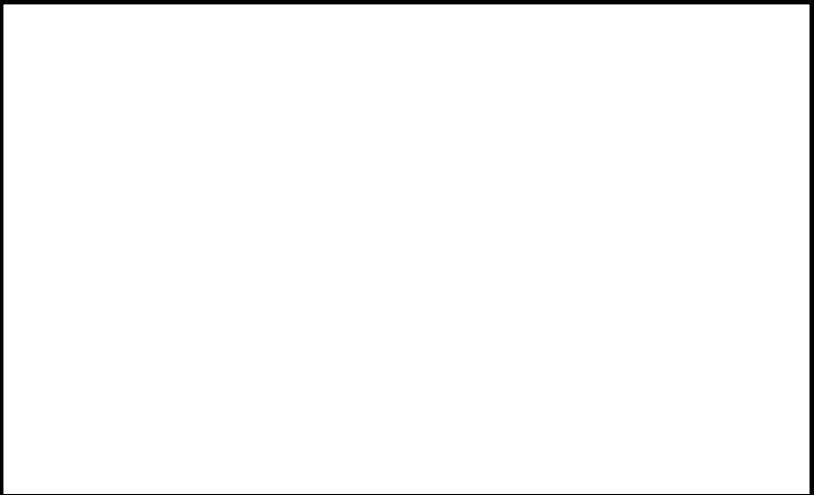
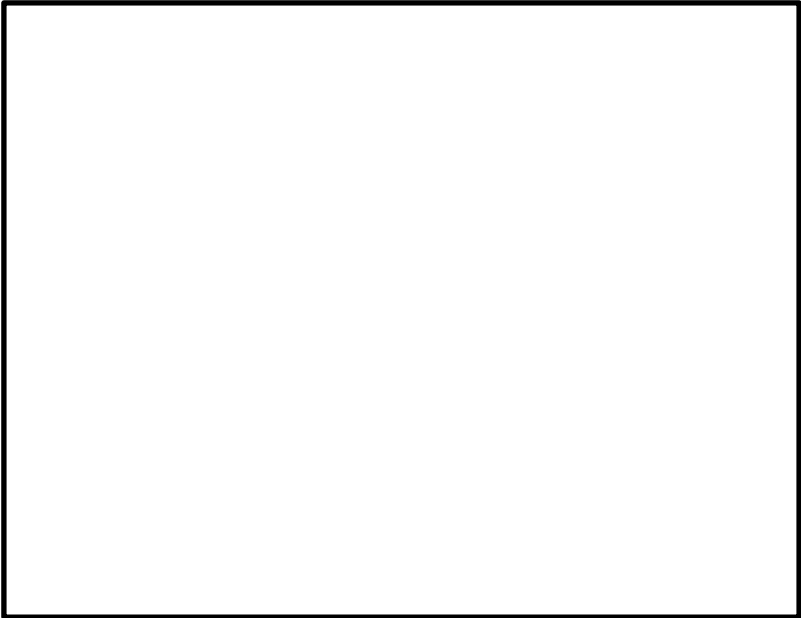
柏崎刈羽原子力発電所 6 / 7号炉 (2017. 12. 20 版)	東海第二発電所 (2018. 9. 18)	島根原子力発電所 2号炉	備考
 <p data-bbox="201 842 878 915">図 59-3-12 電力保安通信用電話設備 (交換機) 配置図 (廃棄物処理建屋建屋地下 1 階及び地上 1 階)</p>	 <p data-bbox="967 842 1694 869">第 59-3-9 図 電力保安通信用電話設備 (交換機) 配置図</p>	 <p data-bbox="1777 842 2466 915">図 59-3-9 電力保安通信用電話設備 (交換機) 配置図 (制御室建物地上 3 階)</p>	
 <p data-bbox="246 1650 834 1724">図 59-3-13 データ表示装置 (待避室) 配置図 (コントロール建屋地上 2 階)</p>		 <p data-bbox="1739 1650 2504 1770">図 59-3-10 プラントパラメータ監視装置 (中央制御室待避室) 配置図 (制御室建物地上 4 階)</p>	

柏崎刈羽原子力発電所 6 / 7号炉 (2017. 12. 20 版)	東海第二発電所 (2018. 9. 18)	島根原子力発電所 2号炉	備考
			
<p>図 59-3-14 酸素濃度・二酸化炭素濃度計及び乾電池内蔵型照明 配置図 (コントロール建屋地上2階)</p>		<p>図 59-3-11 酸素濃度計, 二酸化炭素濃度計及びLEDライト (ランタンタイプ) 配置図 (制御室建物地上4階)</p>	
			
<p>図 59-3-15 非常用ガス処理系に係る機器 (排風機, フィルタ装置, 乾燥装置) の配置図 (6号炉 原子炉建屋地上3階)</p>	<p>第 59-3-3 図 原子炉建屋ガス処理系に係る機器配置図</p>	<p>図 59-3-12 非常用ガス処理系に係る機器 (排気ファン, 前置ガス処理装置, 後置ガス処理装置) の配置図 (原子炉建物地上3階)</p>	

柏崎刈羽原子力発電所 6 / 7号炉 (2017. 12. 20 版)	東海第二発電所 (2018. 9. 18)	島根原子力発電所 2号炉	備考
<div data-bbox="252 220 822 787" data-label="Image"> </div> <div data-bbox="184 926 884 1010" data-label="Caption"> <p>図 59-3-16 非常用ガス処理系に係る機器（弁）の配置図 (6号炉 原子炉建屋地上3階)</p> </div>		<div data-bbox="1745 220 2496 903" data-label="Image"> </div> <div data-bbox="1754 926 2484 1010" data-label="Caption"> <p>図 59-3-13 非常用ガス処理系に係る機器（弁）の配置図 (原子炉建物地上3階)</p> </div> <div data-bbox="1745 1024 2496 1690" data-label="Image"> </div> <div data-bbox="1754 1732 2484 1816" data-label="Caption"> <p>図 59-3-14 非常用ガス処理系に係る機器（弁）の配置図 (原子炉建物地上2階)</p> </div>	

柏崎刈羽原子力発電所 6 / 7号炉 (2017. 12. 20 版)	東海第二発電所 (2018. 9. 18)	島根原子力発電所 2号炉	備考
 <p data-bbox="160 974 917 1050">図 59-3-17 非常用ガス処理系に係る中央制御室操作盤の配置図 (コントロール建屋地上2階)</p>		 <p data-bbox="1745 974 2502 1096">図 59-3-15 非常用ガス処理系に係る中央制御室操作盤の配置 図 (制御室建物地上4階)</p>	

柏崎刈羽原子力発電所 6 / 7号炉 (2017. 12. 20 版)	東海第二発電所 (2018. 9. 18)	島根原子力発電所 2号炉	備考
<div data-bbox="290 233 863 806" data-label="Image"> </div> <div data-bbox="151 835 923 961" data-label="Caption"> <p>図 59-3-18 非常用ガス処理系に係る機器（排風機，フィルタ装置，乾燥装置）の配置図 (7号炉 原子炉建屋地上3階)</p> </div> <div data-bbox="278 1085 851 1656" data-label="Image"> </div> <div data-bbox="186 1686 881 1770" data-label="Caption"> <p>図 59-3-19 非常用ガス処理系に係る機器（弁）の配置図 (7号炉 原子炉建屋地上3階)</p> </div>			<p data-bbox="2534 835 2772 919">・申請号炉数の相違 【柏崎 6/7】</p> <p data-bbox="2534 1644 2772 1728">・申請号炉数の相違 【柏崎 6/7】</p>

柏崎刈羽原子力発電所 6 / 7 号炉 (2017. 12. 20 版)	東海第二発電所 (2018. 9. 18)	島根原子力発電所 2 号炉	備考
<div data-bbox="204 233 866 795" data-label="Image"> </div> <div data-bbox="151 835 920 919" data-label="Caption"> <p>図 59-3-20 非常用ガス処理系に係る中央制御室操作盤の配置図 (コントロール建屋地上 2 階)</p> </div>			<ul style="list-style-type: none"> ・ 申請号炉数の相違 【柏崎 6/7】

実線・・・設備運用又は体制等の相違（設計方針の相違）
 波線・・・記載表現、設備名称の相違（実質的な相違なし）

まとめ資料比較表 [59 条 補足説明資料 59-4 系統図]

柏崎刈羽原子力発電所 6 / 7 号炉 (2017. 12. 20 版)	東海第二発電所 (2018. 9. 18 版)	島根原子力発電所 2 号炉	備考
<p style="text-align: center;">59-4</p> <p style="text-align: center;">系統図</p>	<p style="text-align: center;">59-4 系統図</p>	<p style="text-align: center;">59-4</p> <p style="text-align: center;">系統図</p>	



図 59-4-1 中央制御室換気空調系外気取入及び排気隔離ダンパ
系統概要図



第 59-4-1 図 (1/4) 中央制御室換気系 系統概要図

・設備及び運用の相違
【柏崎 6/7】
①の相違

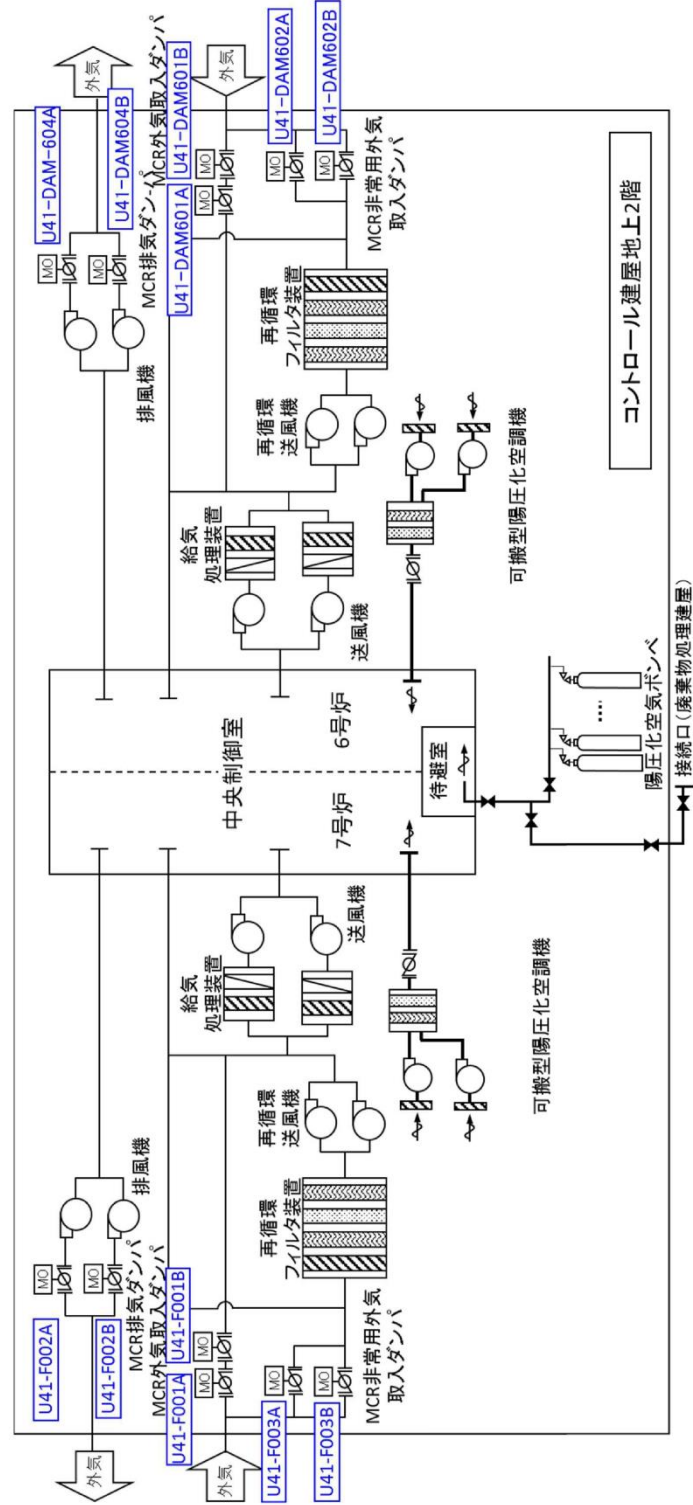
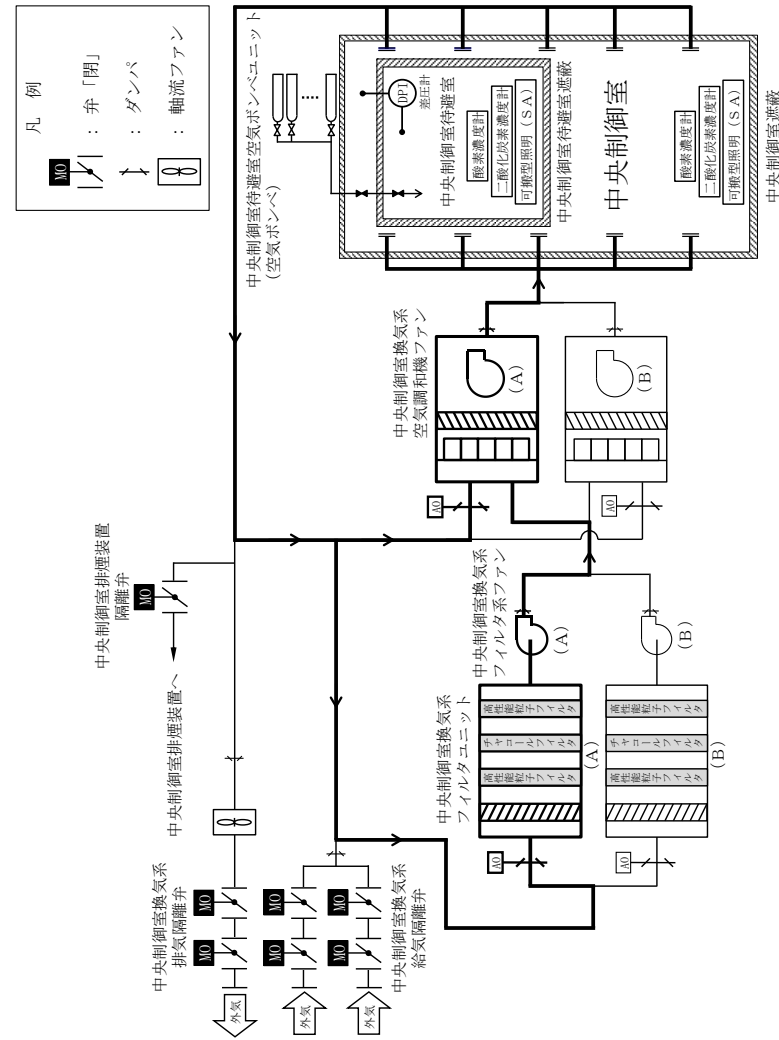
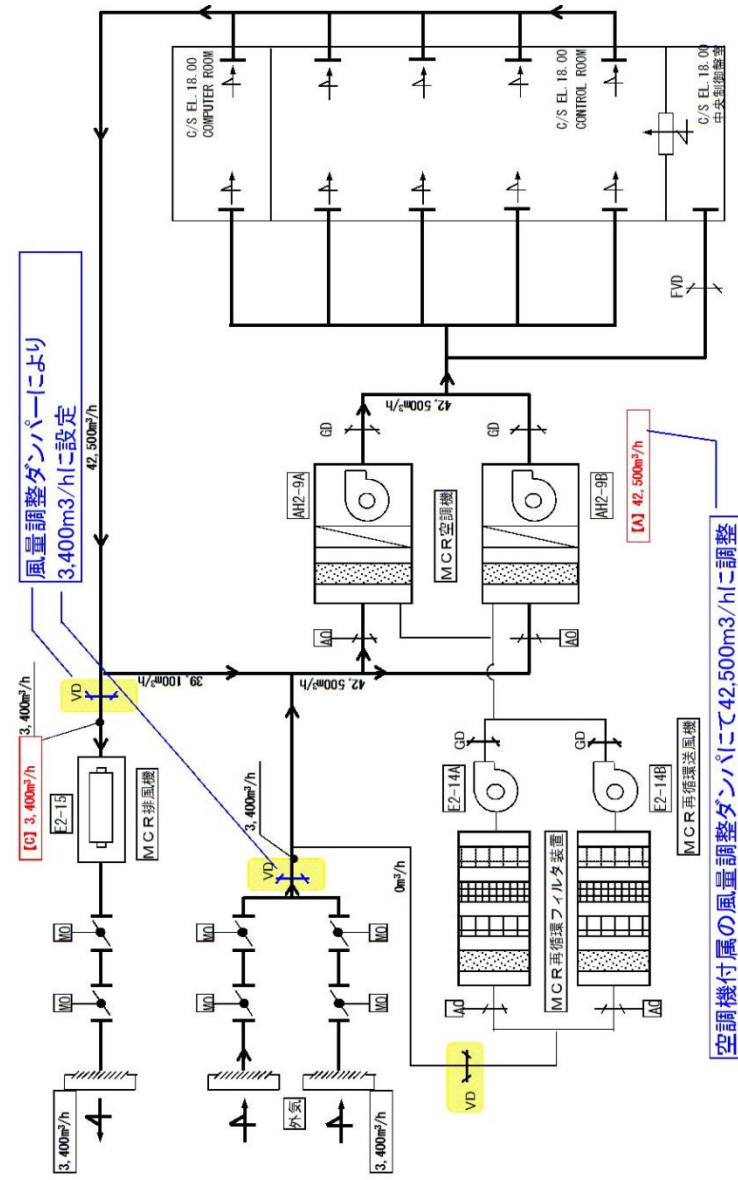

第59-4-1図 (2/4) 中央制御室換気系 系統概要図

① 通常運転モード



図59-4-1 中央制御室換気系及び中央制御室待避室正圧化装置 (空気ポンプ) 概略系統図 (通常時)



第 59-4-1 図 (3/4) 中央制御室換気系 系統概要図

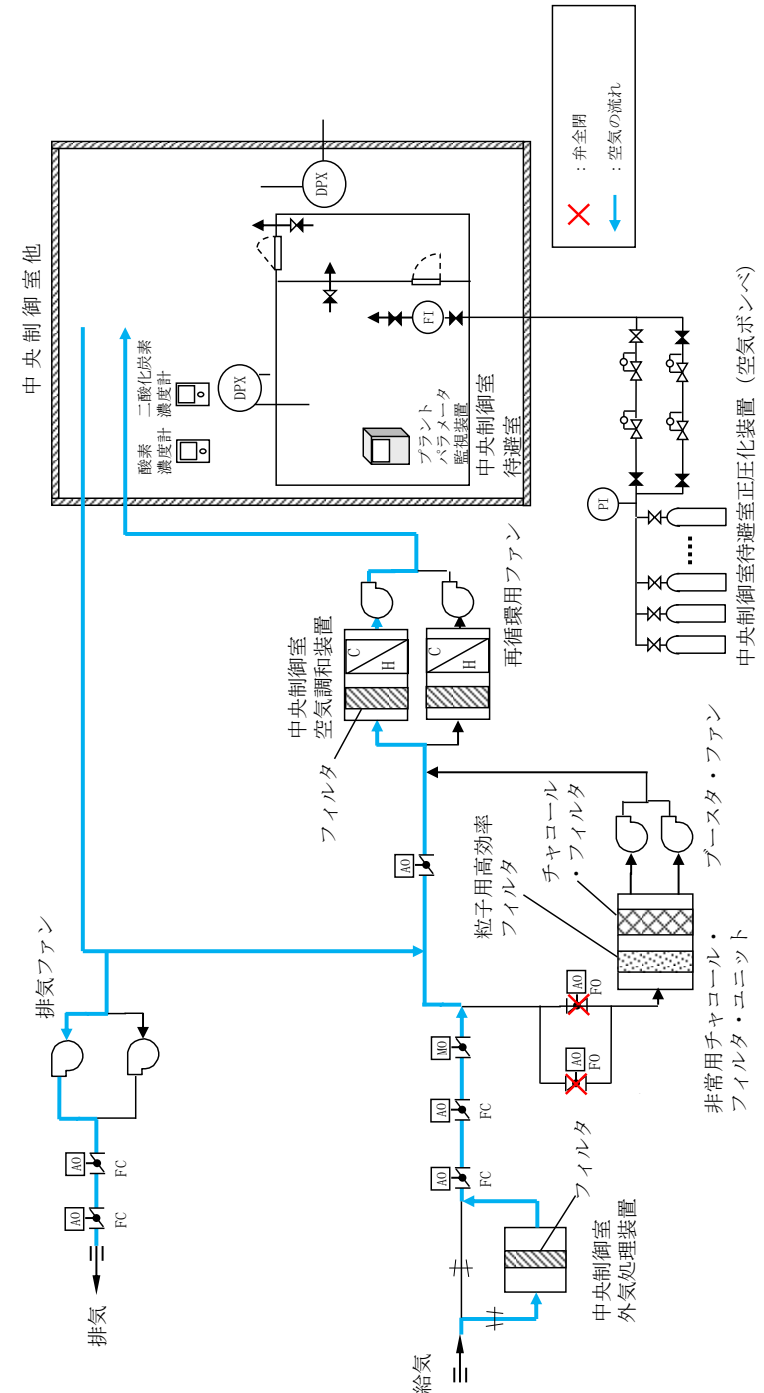
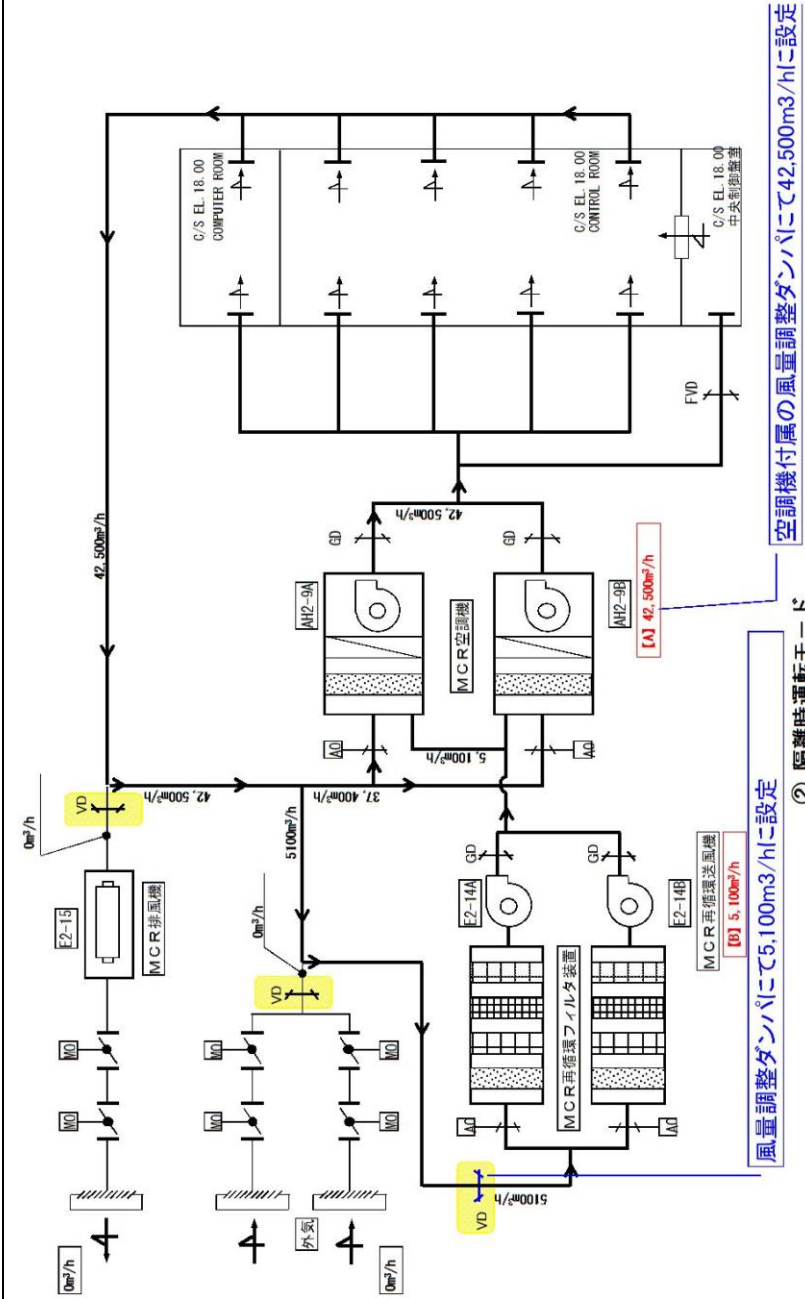

図 59-4-2 中央制御室換気系及び中央制御室待避室正圧化装置 (空気ポンプ) 概略系統図 (非常時運転モード (系統隔離運転))



図 59-4-2 中央制御室可搬型陽圧化空調機及び中央制御室待避室陽圧化装置 系統概要図 (中央制御室を陽圧化時)

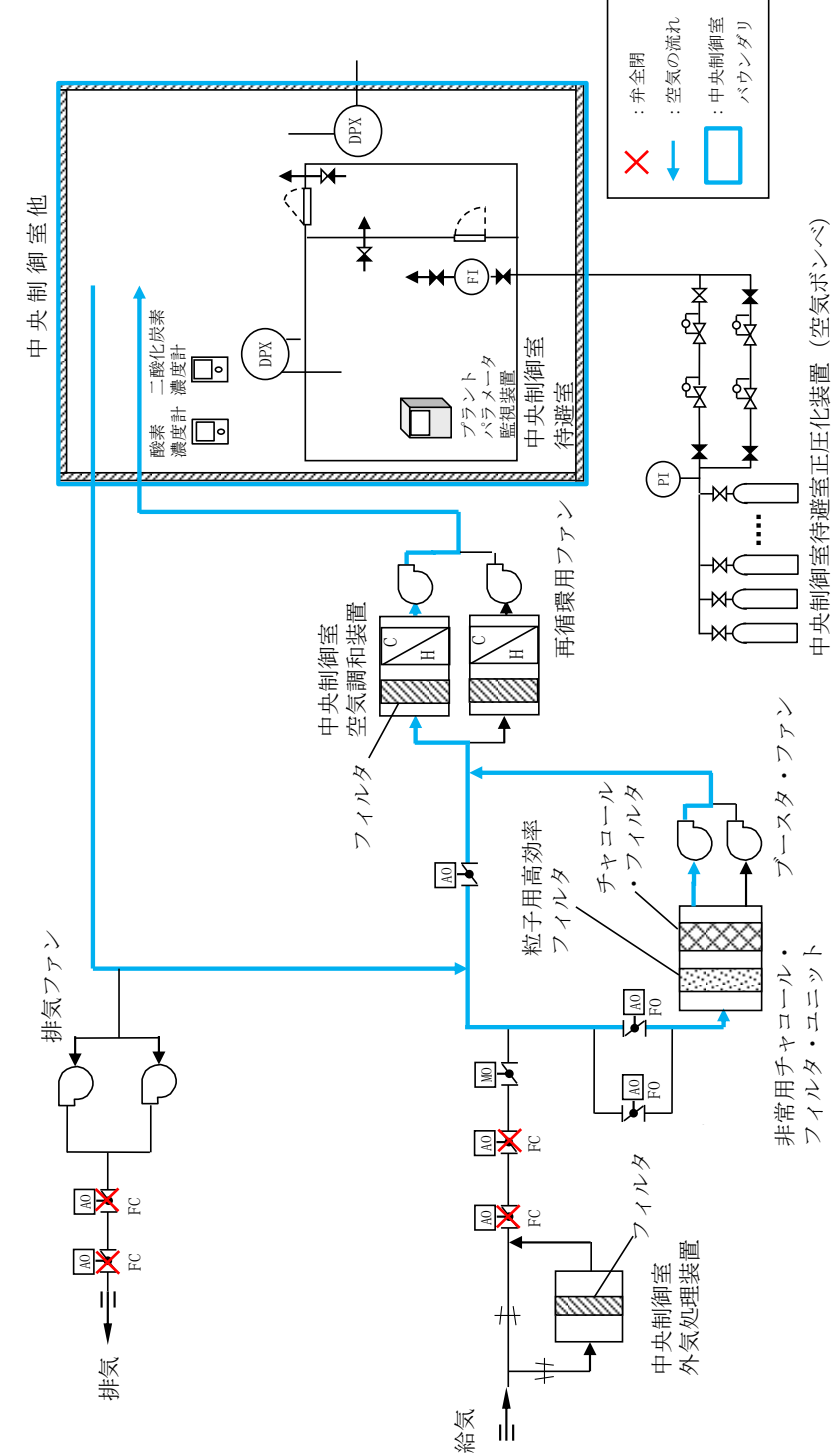

図 59-4-4 中央制御室換気系及び中央制御室待避室制圧化装置 (空気ポンペ) 概略系統図 (非常時運転モード (加圧運転 (プルーム通過前及びプルーム通過後)))

・設備の相違
【東海第二】
 島根2号炉は、加圧運転を行うため、フィルタを通らない空気の流入は無い

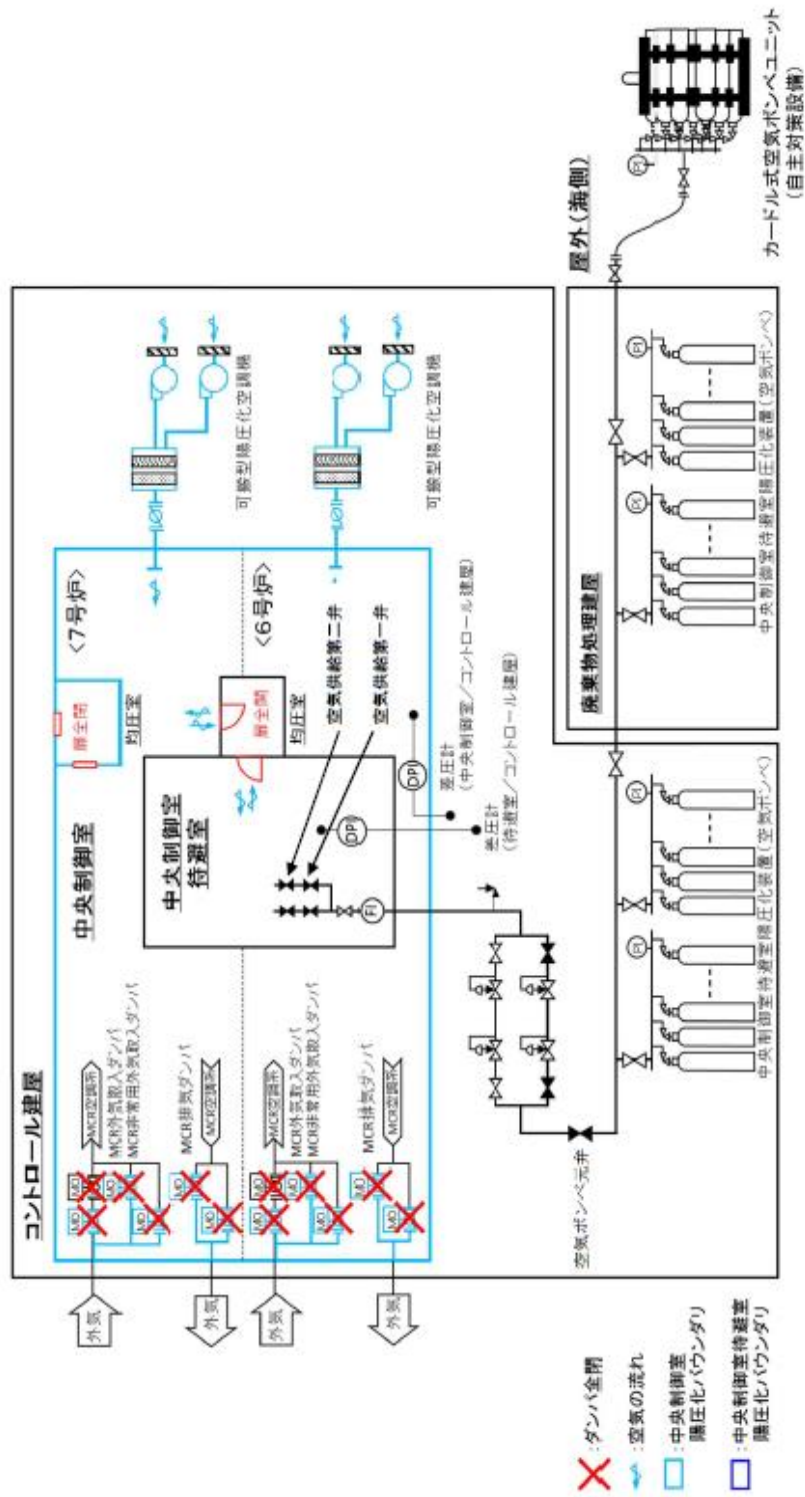

・自主対策設備の相違
【柏崎 6/7】
島根 2号炉は、居住性を確保するために必要な容量を有する中央制御室待避室正圧化装置 (空気ポンペ) を設置する (以下、②の相違)

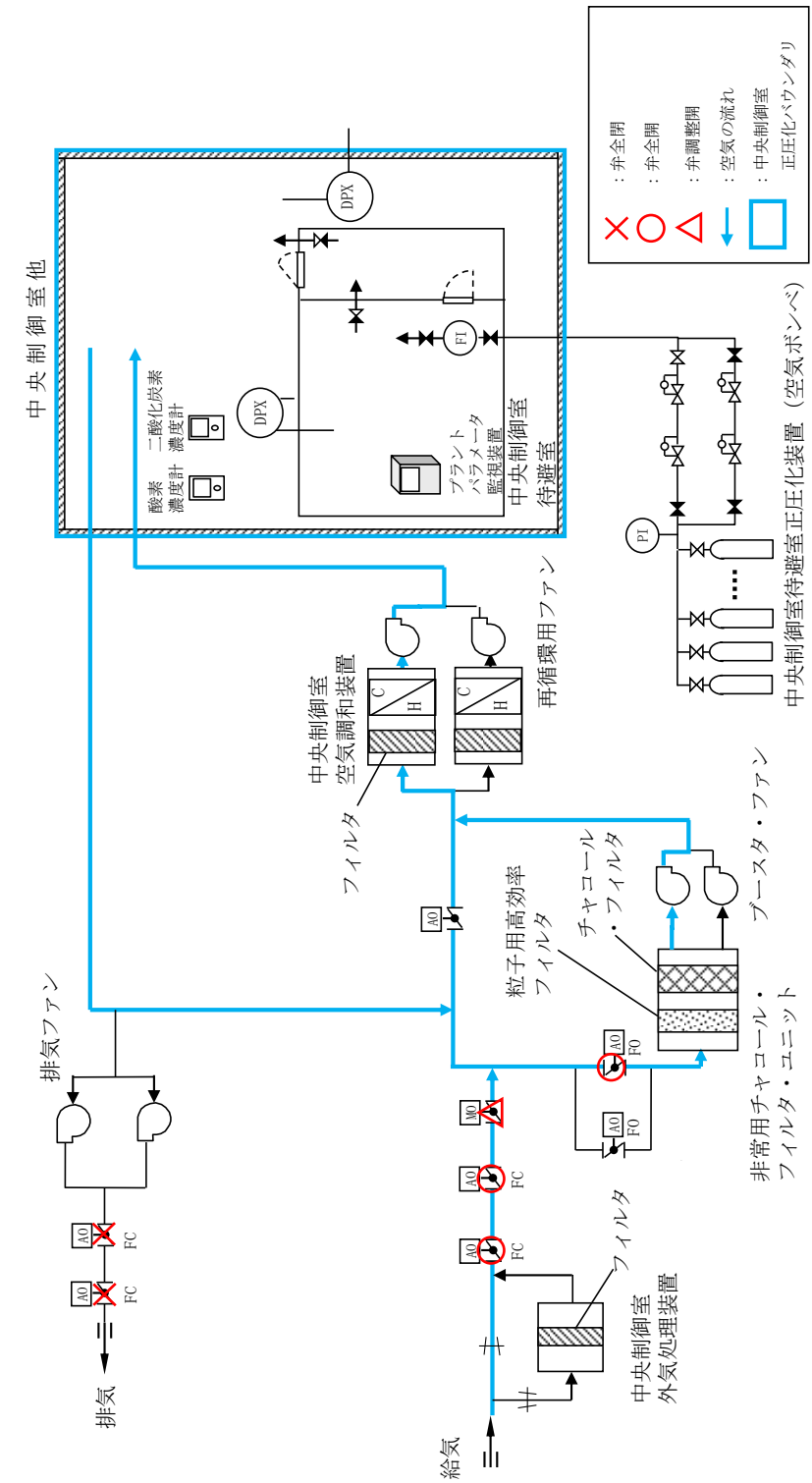
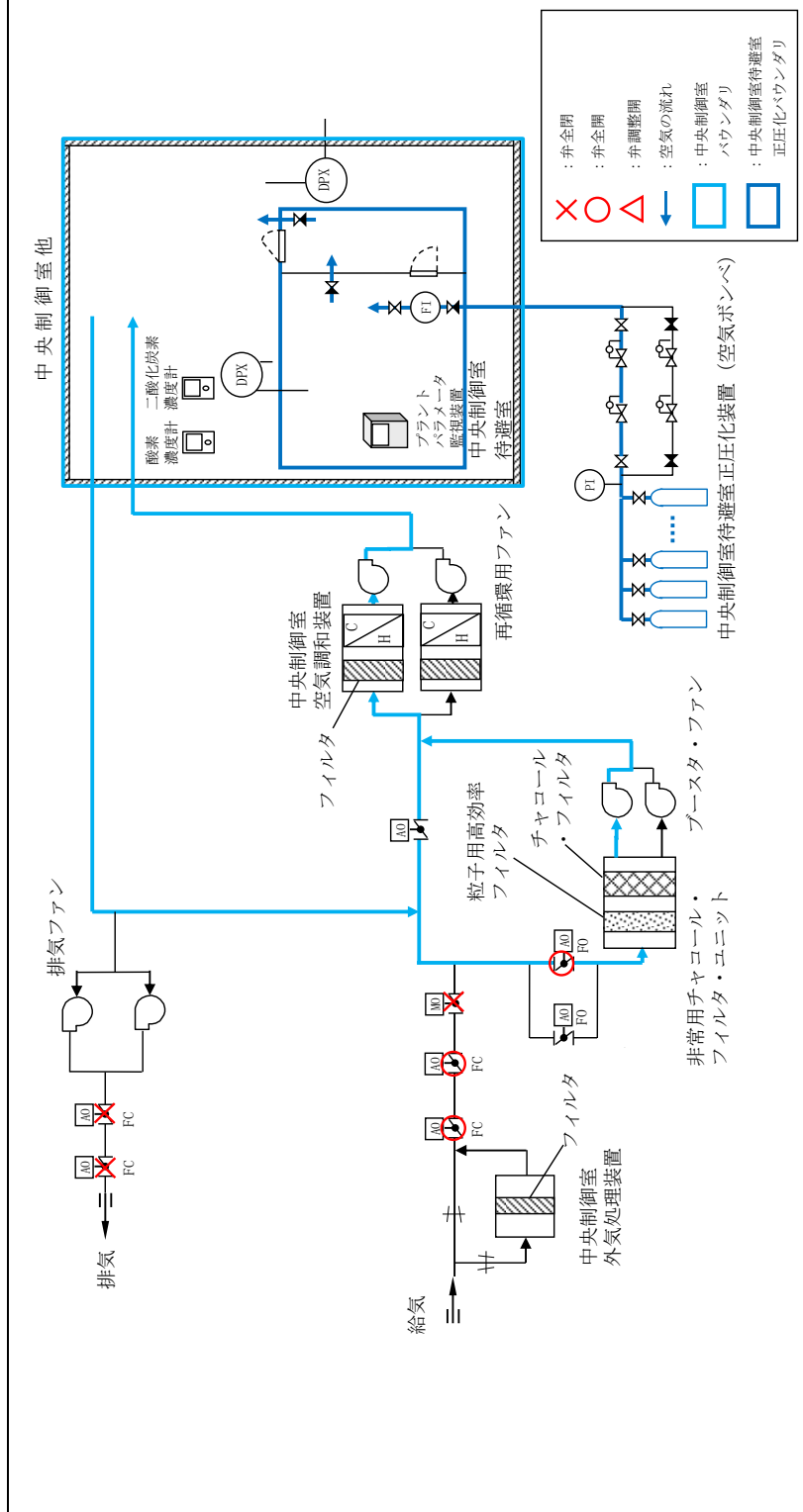
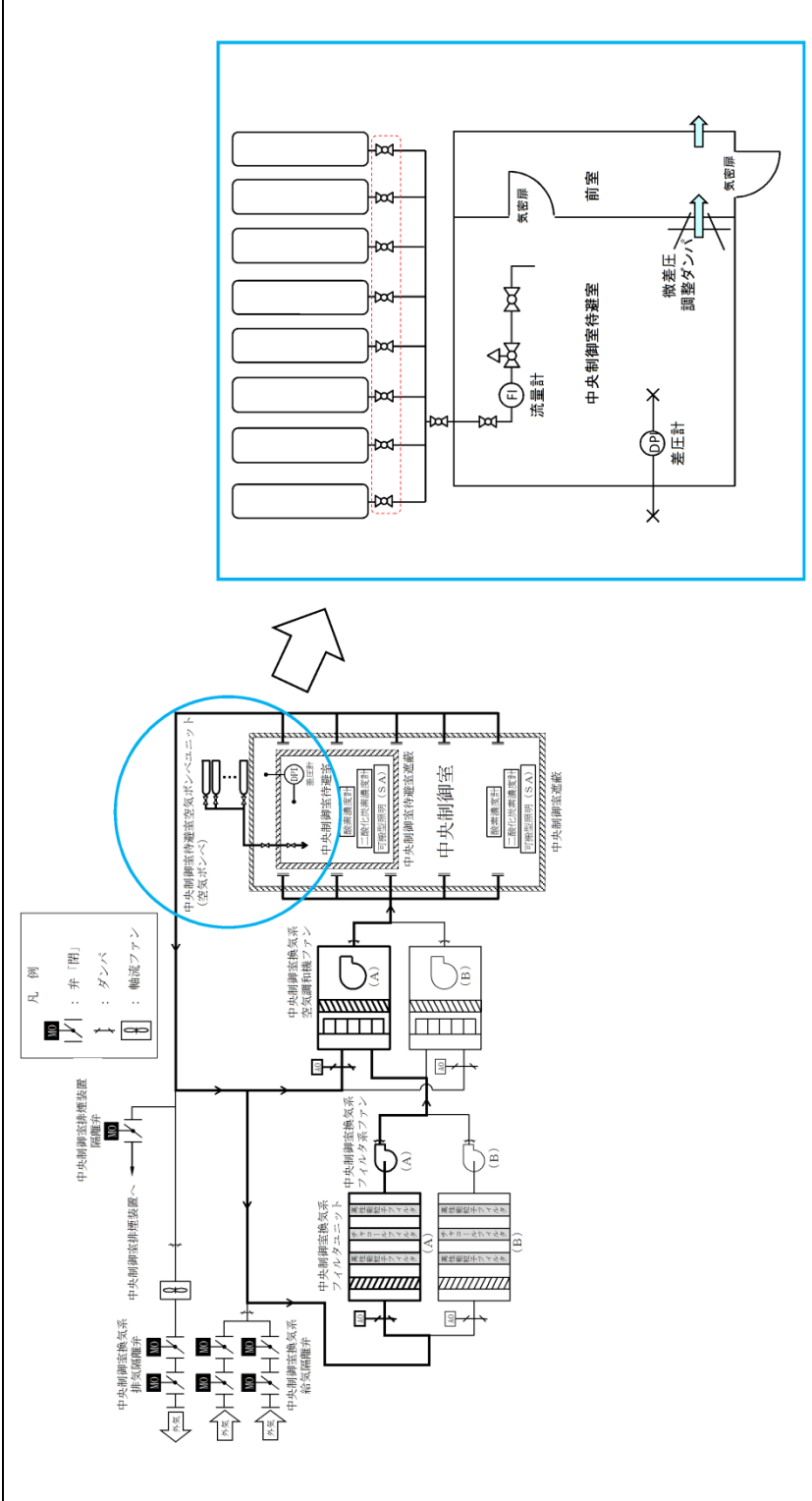
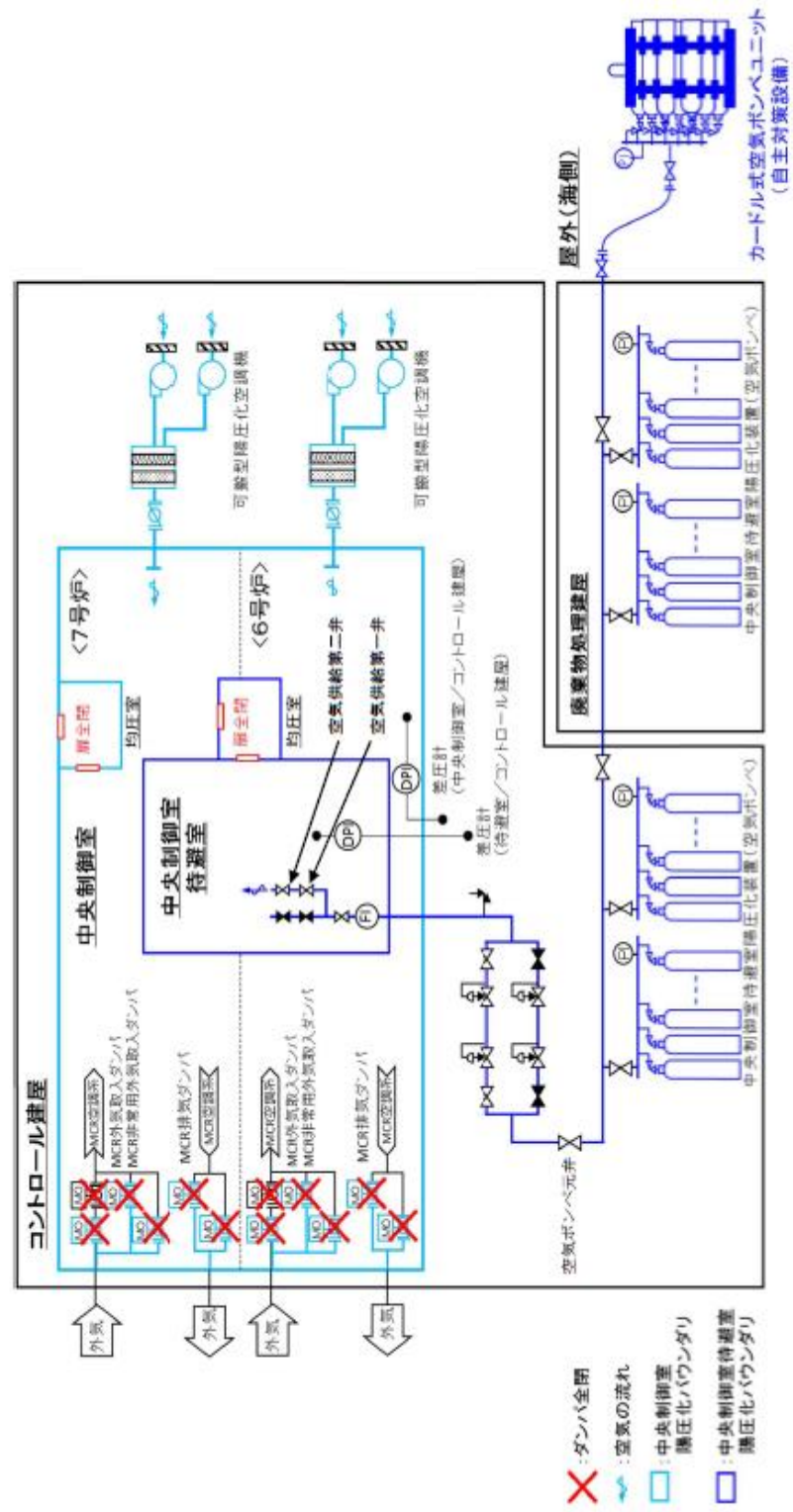

図 59-4-4 無線連絡設備(常設)及び衛星電話設備(常設)系統概要図



第 59-4-4 図 衛星電話設備(可搬型)(待機室)系統概要図

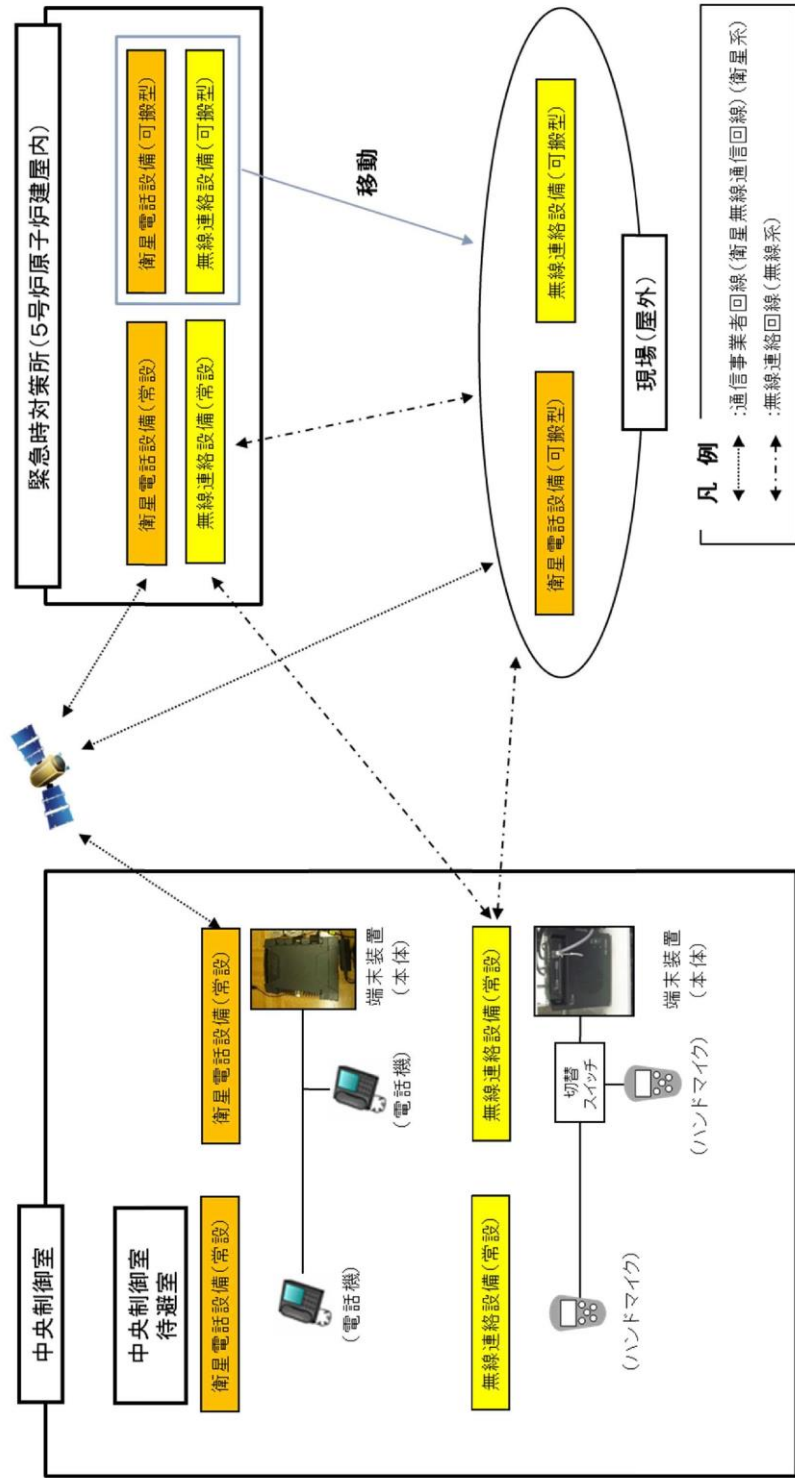
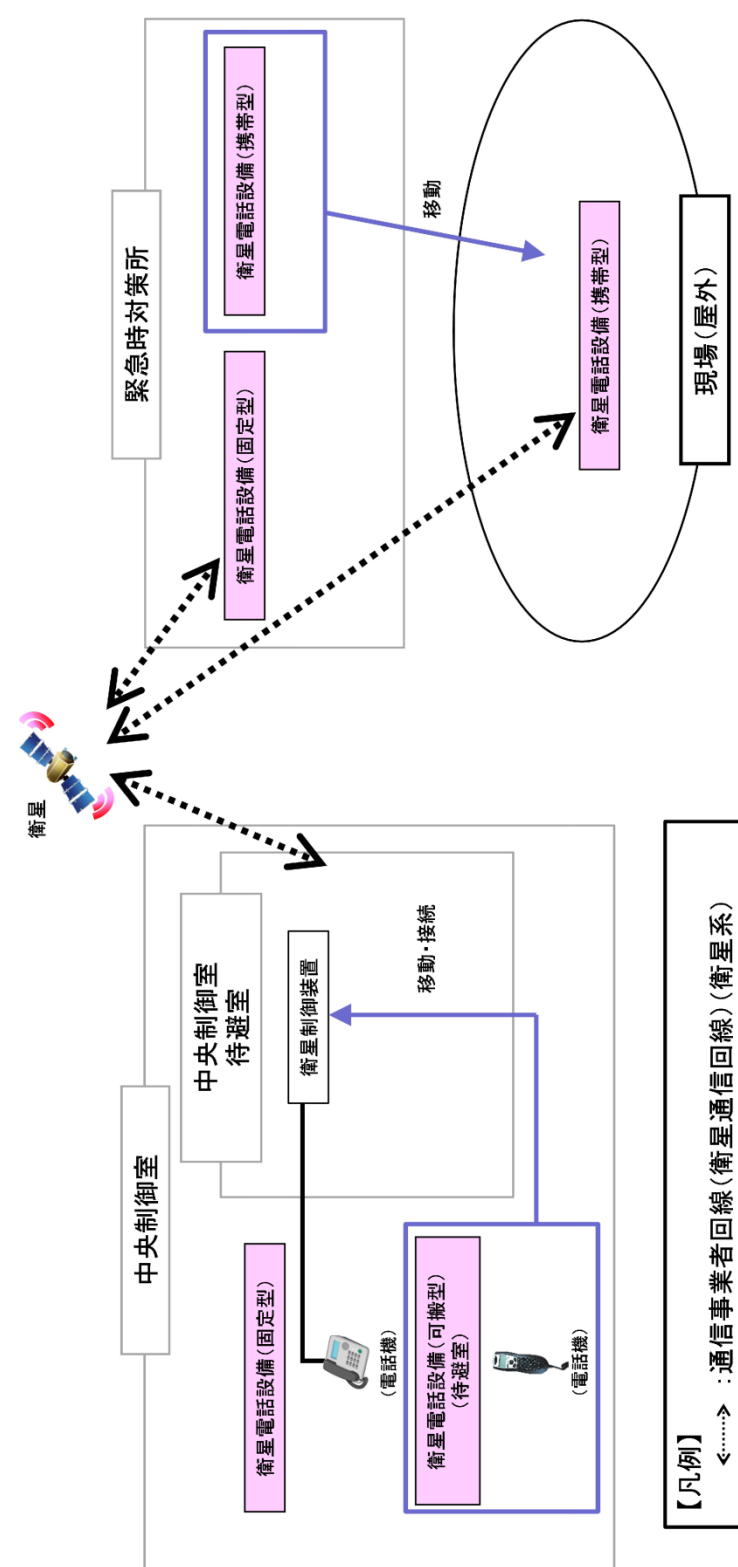

図 59-4-6 無線通信設備(固定型)及び衛星電話設備(固定型)系統概要図

・設備の相違
 【東海第二】
 島根2号炉は、無線通信設備(固定型)を設置(以下、③の相違)



図 59-4-5 データ表示装置(待避室)系統概要図

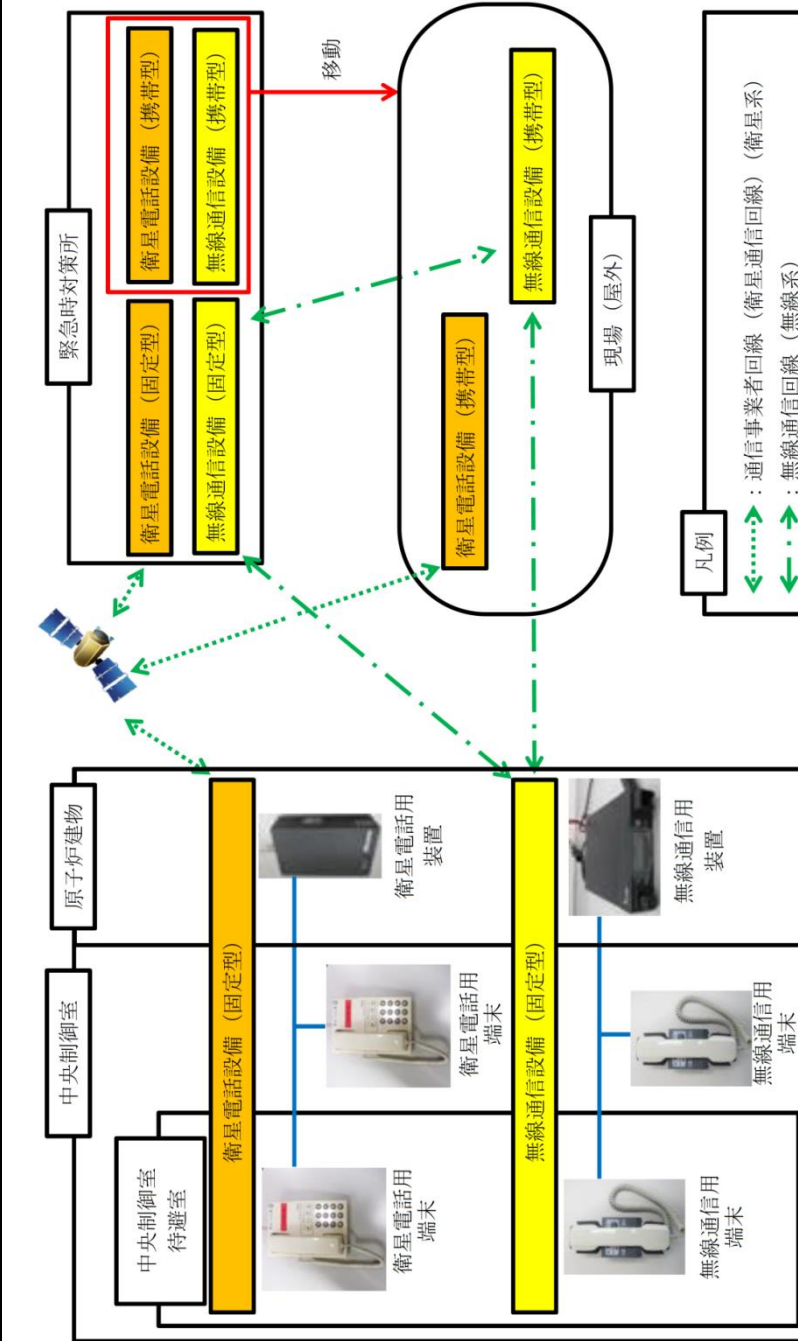

第 59-4-5 図 データ表示装置(待避室)系統概要図



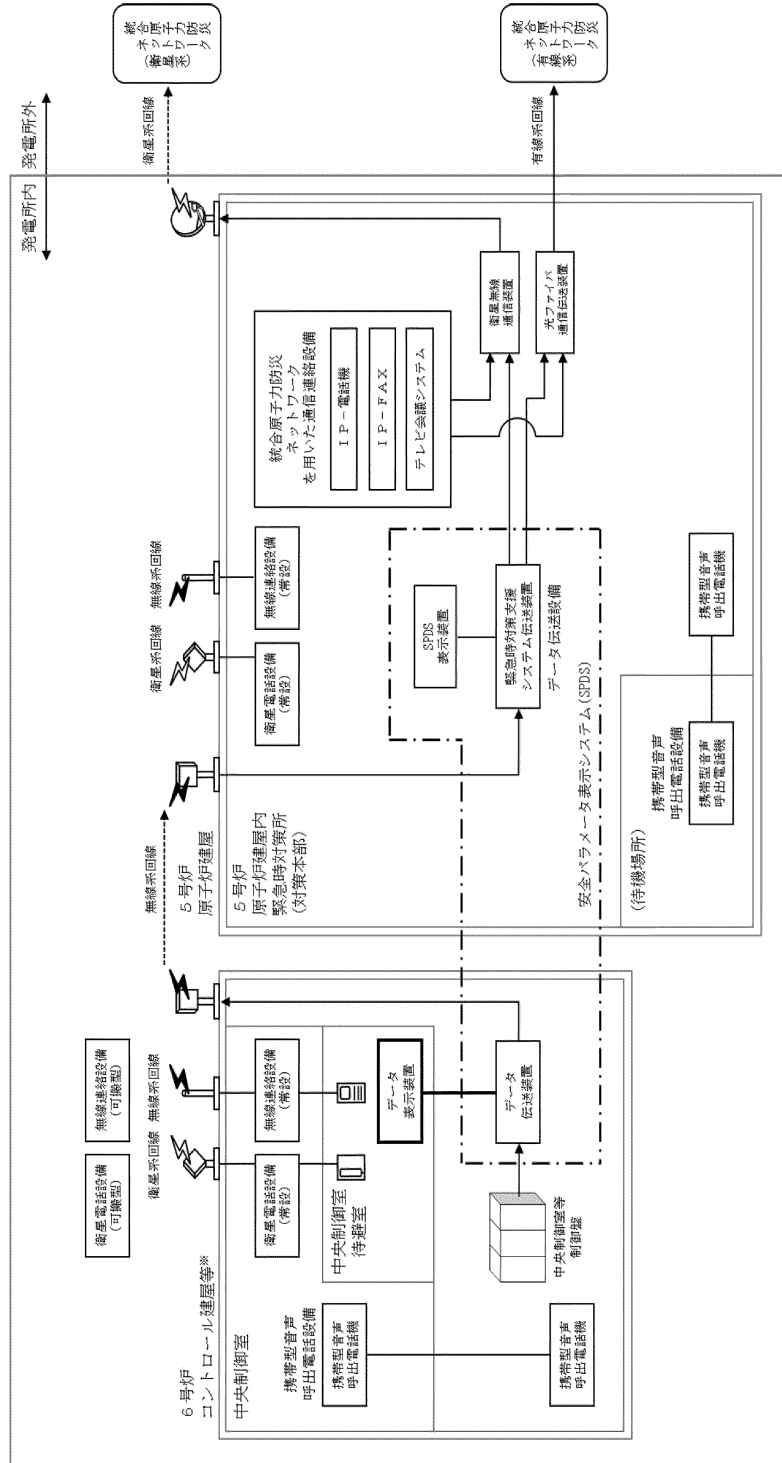
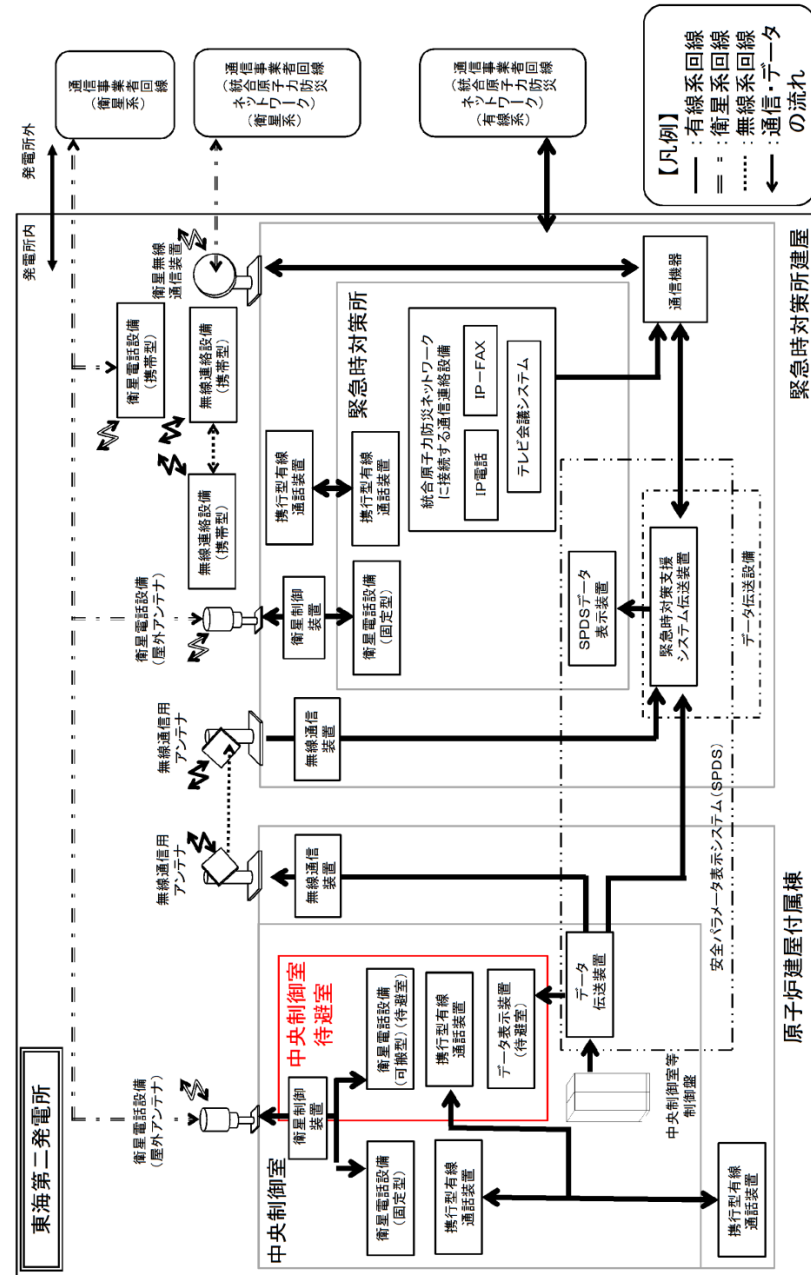

図 59-4-7 プラントパラメータ監視装置(中央制御室待避室)

系統概要図

柏崎刈羽原子力発電所 6 / 7号炉 (2017. 12. 20 版)	東海第二発電所 (2018. 9. 18 版)	島根原子力発電所 2号炉	備考
 <p data-bbox="151 1062 923 1184"> <u>図59-4-6 操作概要図 無線連絡設備(常設)及び衛星電話設備(常設)</u> <u>(コントロール建屋地上2階)</u> </p>	 <p data-bbox="943 1062 1715 1096"> <u>第 59-4-6 図 衛星電話設備 (可搬型) (待避室) 操作概要図</u> </p>	 <p data-bbox="1736 1062 2507 1184"> <u>図59-4-8 操作概要図 無線通信設備 (固定型) 及び衛星電話設備 (固定型)</u> <u>(制御室建物地上4階)</u> </p>	

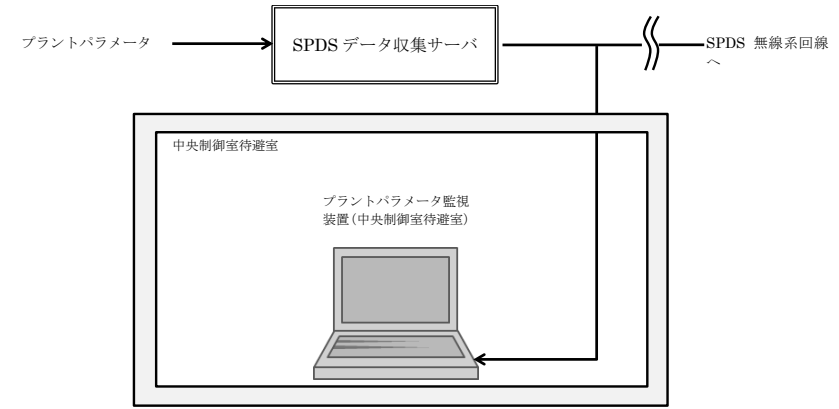
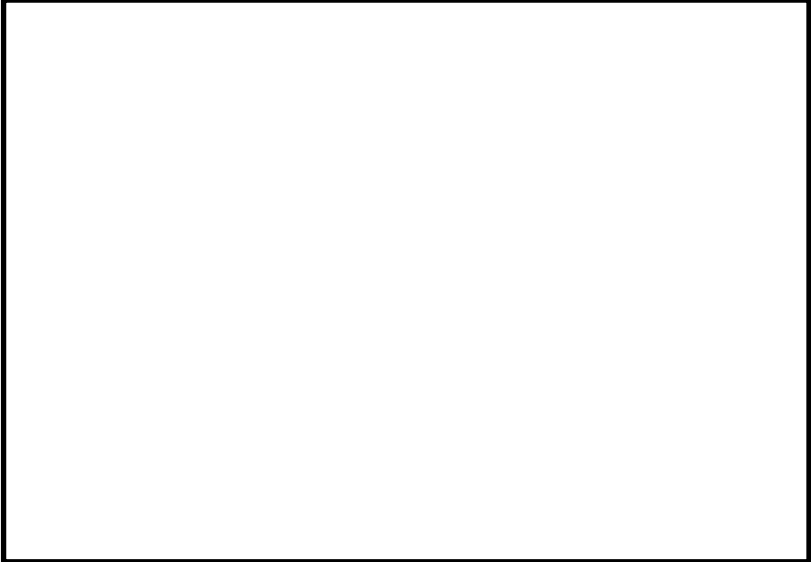
柏崎刈羽原子力発電所 6 / 7 号炉 (2017. 12. 20 版)	東海第二発電所 (2018. 9. 18 版)	島根原子力発電所 2 号炉	備考
<div data-bbox="172 279 914 638" data-label="Image"> </div> <div data-bbox="142 699 934 829" data-label="Caption"> <p>図59-4-7 切替操作概要図 無線連絡設備 (常設) 及び衛星電話設備 (常設) (コントロール建屋地上2階)</p> </div>			



図 59-4-8 非常用ガス処理系 系統概要図 (6号炉)



図 59-4-3 原子炉建屋ガス処理系 系統概要図

No	機器名称	No	機器名称
1	前置ガス処理装置 (A)	9	非常用ガス処理系出口弁 (A)
2	前置ガス処理装置 (B)	10	非常用ガス処理系出口弁 (B)
3	後置ガス処理装置 (A)	11	非常用ガス処理系排気ファン入口弁 (A)
4	後置ガス処理装置 (B)	12	非常用ガス処理系排気ファン入口弁 (B)
5	非常用ガス処理系排気ファン (A)	13	R/B連絡弁 (A)
6	非常用ガス処理系排気ファン (B)	14	R/B連絡弁 (B)
7	非常用ガス処理系入口弁 (A)	15	R/B給排気隔離弁
8	非常用ガス処理系 (B)		

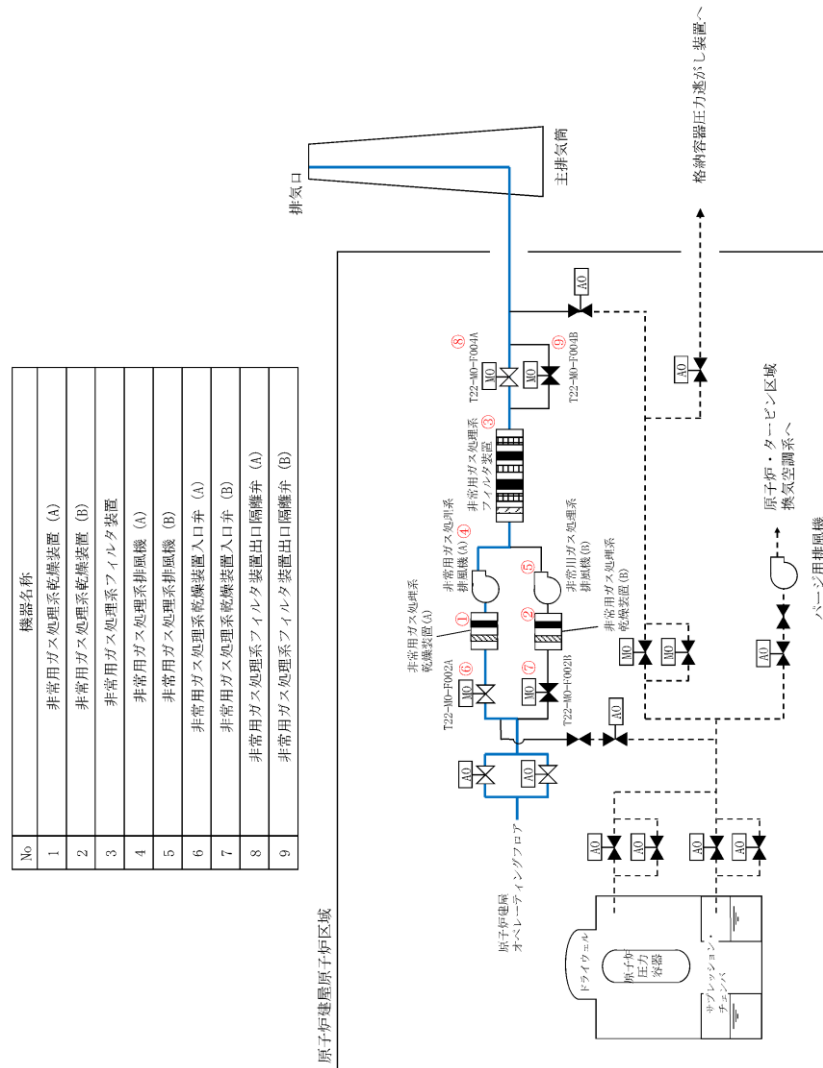

図 59-4-9 非常用ガス処理系 系統概要図

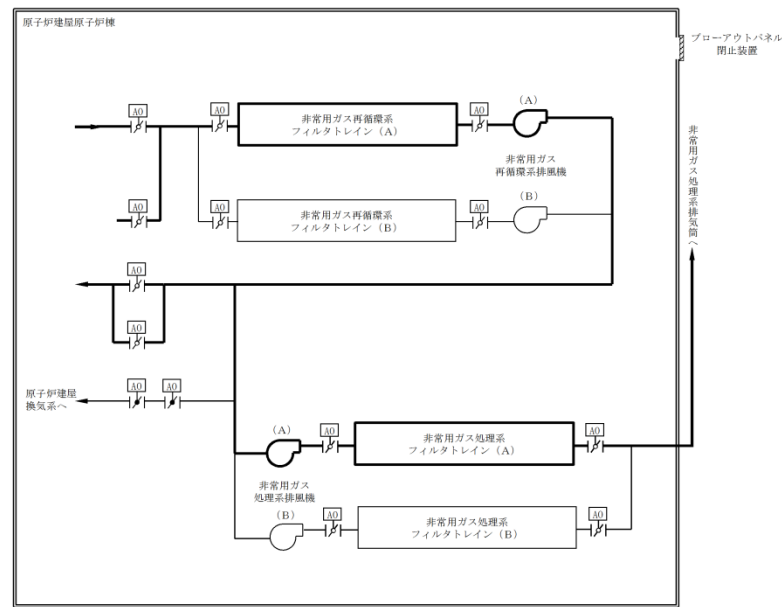
・設備の相違
【東海第二】
 島根2号炉には非常用
 ガス再循環系はない

No	機器名称
1	非常用ガス処理系乾燥装置 (A)
2	非常用ガス処理系乾燥装置 (B)
3	非常用ガス処理系フィルタ装置
4	非常用ガス処理系排風機 (A)
5	非常用ガス処理系排風機 (B)
6	非常用ガス処理系乾燥装置入口弁 (A)
7	非常用ガス処理系乾燥装置入口弁 (B)
8	非常用ガス処理系フィルタ装置出口隔離弁 (A)
9	非常用ガス処理系フィルタ装置出口隔離弁 (B)

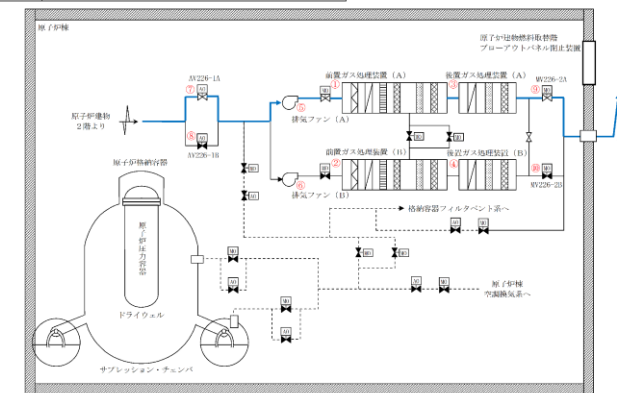

図 59-4-9 非常用ガス処理系 系統概要図 (7号炉)

・申請号炉数の相違
【柏崎 6/7】

実線・・設備運用又は体制等の相違（設計方針の相違）
 波線・・記載表現、設備名称の相違（実質的な相違なし）

まとめ資料比較表 [59 条 補足説明資料 59-5 試験及び検査]

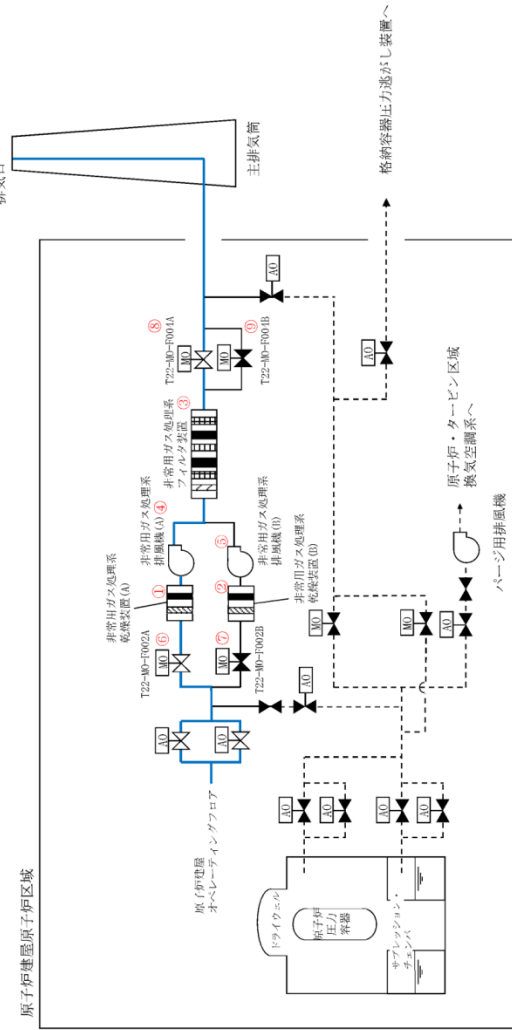
柏崎刈羽原子力発電所 6 / 7 号炉 (2017. 12. 20 版)	東海第二発電所 (2018. 9. 18 版)	島根原子力発電所 2 号炉	備考
<p>59-5 試験及び検査</p>	<p>59-5 試験検査</p>	<p>59-5 試験及び検査</p>	

○可搬型蓄電池内蔵型照明の試験及び検査について

可搬型蓄電池内蔵型照明は、運転中及び停止中においても蓄電池電圧の確認、照明の点灯確認が可能な構造とする。概略構造図を図59-5-1に示す。



図 59-5-1 可搬型蓄電池内蔵型照明の概略構造図

○可搬型照明 (SA) の試験検査について

可搬型照明 (SA) は、原子炉の運転中又は停止中に第59-5-9表に示す試験検査が可能な設計とする。
可搬型照明 (SA) の概略構造図を第59-5-7図に示す。

第59-5-9表 可搬型照明 (SA) の試験検査

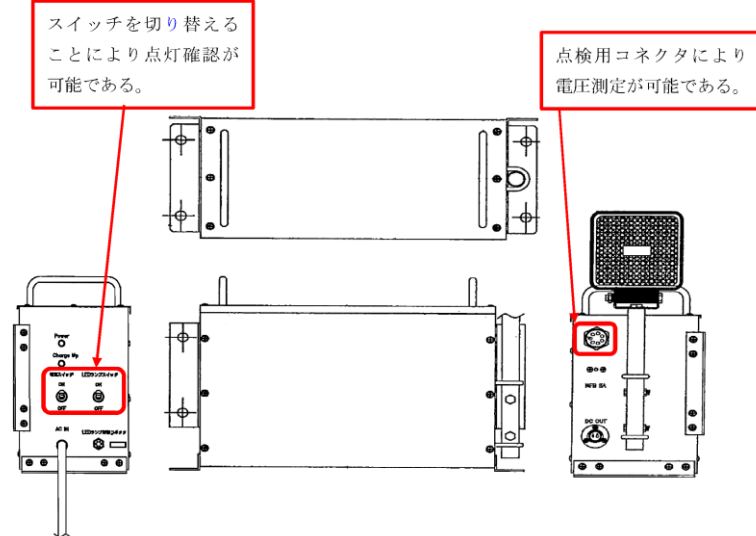
原子炉の状態	項目	内容
運転中又は停止中	外観検査	外観の確認
	機能・性能検査	点灯確認

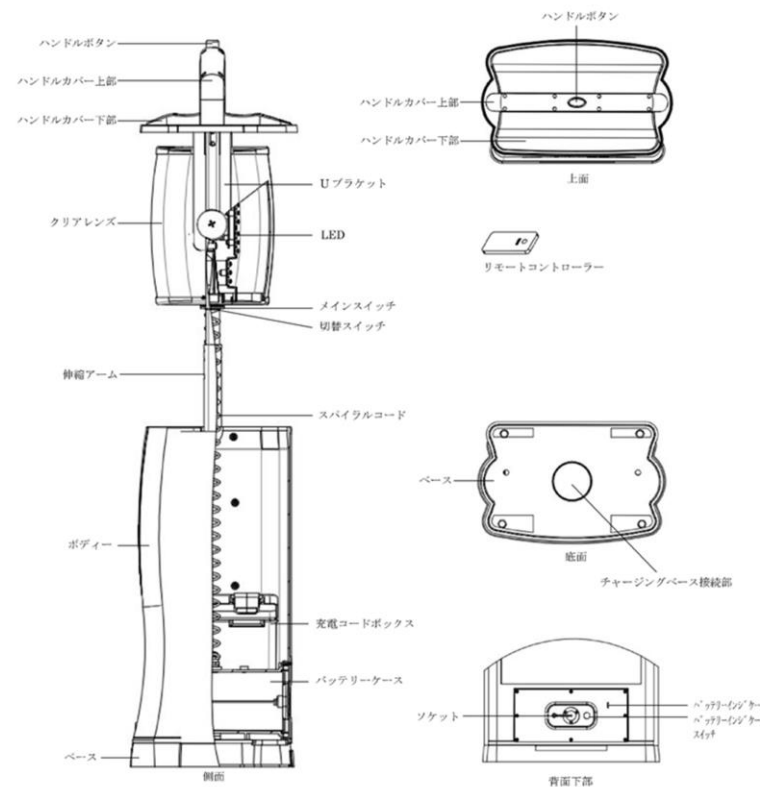

第 59-5-7 図 可搬型照明 (SA) の概略構造図

○LEDライト (三脚タイプ) の試験及び検査について

LEDライト (三脚タイプ) は、原子炉の運転中又は停止中に表59-5-1に示す試験検査が可能な構造とする。
LEDライト (三脚タイプ) の概略構造図を図59-5-1に示す。

表 59-5-1 LEDライト (三脚タイプ) の試験検査

発電用原子炉の状態	項目	内容
運転中又は停止中	機能・性能試験	蓄電池電圧の確認 点灯確認
	外観検査	外観の確認



図 59-5-1 LEDライト (三脚タイプ) の外観図

・設備の相違
【柏崎6/7, 東海第二】
島根2号炉のLEDライト (三脚タイプ) は、スイッチ及びコネクタにより点灯及び電圧確認が可能

柏崎刈羽原子力発電所 6 / 7号炉 (2017. 12. 20 版)	東海第二発電所 (2018. 9. 18 版)	島根原子力発電所 2号炉	備考																																				
	<p>○ 中央制御室待避室遮蔽の試験検査について 中央制御室待避室遮蔽は、原子炉の運転中又は停止中に第59-5-1表に示す試験検査が可能な設計とする。</p> <p style="text-align: center;">第59-5-1表 中央制御室待避室遮蔽の試験検査</p> <table border="1" data-bbox="955 485 1715 625"> <thead> <tr> <th>原子炉の状態</th> <th>項目</th> <th>内容</th> </tr> </thead> <tbody> <tr> <td>運転中又は停止中</td> <td>外観検査</td> <td>遮蔽のひび割れ 表面劣化状態の外観確認</td> </tr> </tbody> </table> <p>○ 中央制御室待避室空気ポンベユニット (空気ポンベ) の試験検査について 中央制御室待避室空気ポンベユニット (空気ポンベ) は、原子炉の運転中又は停止中に第59-5-5表に示す試験検査が可能な設計とする。</p> <p style="text-align: center;">第59-5-5表 中央制御室待避室空気ポンベユニット (空気ポンベ) の試験検査</p> <table border="1" data-bbox="955 1171 1697 1371"> <thead> <tr> <th>原子炉の状態</th> <th>項目</th> <th>内容</th> </tr> </thead> <tbody> <tr> <td rowspan="2">運転中又は停止中</td> <td>外観検査</td> <td>表面状態を目視により確認</td> </tr> <tr> <td>機能・性能検査</td> <td>空気ポンベ残圧の確認</td> </tr> <tr> <td>停止中</td> <td>機能・性能検査</td> <td>中央制御室待避室の正圧化試験</td> </tr> </tbody> </table>	原子炉の状態	項目	内容	運転中又は停止中	外観検査	遮蔽のひび割れ 表面劣化状態の外観確認	原子炉の状態	項目	内容	運転中又は停止中	外観検査	表面状態を目視により確認	機能・性能検査	空気ポンベ残圧の確認	停止中	機能・性能検査	中央制御室待避室の正圧化試験	<p>○中央制御室待避室遮蔽の試験検査について 中央制御室待避室遮蔽は、原子炉の運転中又は停止中に表 59-5-2に示す試験検査が可能な設計とする。</p> <p style="text-align: center;">表59-5-2 中央制御室待避室遮蔽の試験検査</p> <table border="1" data-bbox="1745 485 2496 590"> <thead> <tr> <th>原子炉の状態</th> <th>項目</th> <th>内容</th> </tr> </thead> <tbody> <tr> <td>運転中又は停止中</td> <td>外観検査</td> <td>傷、割れ等の外観の確認</td> </tr> </tbody> </table> <p>○中央制御室待避室正圧化装置 (空気ポンベ) の試験検査について 中央制御室待避室正圧化装置 (空気ポンベ) は、原子炉の運転中又は停止中に表 59-5-3 に示す試験検査が可能な設計とする。</p> <p style="text-align: center;">表 59-5-3 中央制御室待避室正圧化装置 (空気ポンベ) の試験検査</p> <table border="1" data-bbox="1745 1155 2504 1446"> <thead> <tr> <th>原子炉の状態</th> <th>項目</th> <th>内容</th> </tr> </thead> <tbody> <tr> <td rowspan="2">運転中</td> <td>機能・性能試験</td> <td>空気ポンベ残圧の確認</td> </tr> <tr> <td>外観確認</td> <td>中央制御室待避室正圧化装置 (空気ポンベ) の表面状態の外観の確認</td> </tr> <tr> <td rowspan="2">停止中</td> <td>機能・性能試験</td> <td>空気ポンベ残圧の確認 中央制御室待避室の正圧化試験</td> </tr> <tr> <td>外観確認</td> <td>中央制御室待避室正圧化装置 (空気ポンベ) の表面状態の外観の確認</td> </tr> </tbody> </table>	原子炉の状態	項目	内容	運転中又は停止中	外観検査	傷、割れ等の外観の確認	原子炉の状態	項目	内容	運転中	機能・性能試験	空気ポンベ残圧の確認	外観確認	中央制御室待避室正圧化装置 (空気ポンベ) の表面状態の外観の確認	停止中	機能・性能試験	空気ポンベ残圧の確認 中央制御室待避室の正圧化試験	外観確認	中央制御室待避室正圧化装置 (空気ポンベ) の表面状態の外観の確認	<p>・構成の相違 【柏崎 6/7】 島根 2号炉は、中央制御室待避室遮蔽の試験検査について記載</p> <p>・構成の相違 【柏崎 6/7】 島根 2号炉は、中央制御室待避室空気ポンベの試験検査について記載</p>
原子炉の状態	項目	内容																																					
運転中又は停止中	外観検査	遮蔽のひび割れ 表面劣化状態の外観確認																																					
原子炉の状態	項目	内容																																					
運転中又は停止中	外観検査	表面状態を目視により確認																																					
	機能・性能検査	空気ポンベ残圧の確認																																					
停止中	機能・性能検査	中央制御室待避室の正圧化試験																																					
原子炉の状態	項目	内容																																					
運転中又は停止中	外観検査	傷、割れ等の外観の確認																																					
原子炉の状態	項目	内容																																					
運転中	機能・性能試験	空気ポンベ残圧の確認																																					
	外観確認	中央制御室待避室正圧化装置 (空気ポンベ) の表面状態の外観の確認																																					
停止中	機能・性能試験	空気ポンベ残圧の確認 中央制御室待避室の正圧化試験																																					
	外観確認	中央制御室待避室正圧化装置 (空気ポンベ) の表面状態の外観の確認																																					

柏崎刈羽原子力発電所 6/7号炉 (2017.12.20版)	東海第二発電所 (2018.9.18版)	島根原子力発電所 2号炉	備考
<p>○中央制御室及び中央制御室待避室の気密性に関する試験及び検査について</p> <p>1. 概要 中央制御室及び中央制御室待避室の気密性に関する試験・検査として、プラント停止中において、陽圧化試験を実施する。</p> <p>2. 試験内容 (1) 中央制御室の気密性能確認</p> <p>中央制御室の気密性能確認として、中央制御室の陽圧化試験を実施する。中央制御室の陽圧化試験として、中央制御室換気空調系排気及び外気取入隔離ダンパの動作確認、及び中央制御室可搬型陽圧化空調機を用いた中央制御室と隣接区画が陽圧化に必要な差圧が確保可能であることの確認を実施する。(陽圧化に必要な差圧については、(P.59-6-2)を参照)</p> <p>中央制御室の陽圧化試験のバウンダリ構成図を図 59-5-2 に示す。</p> <p>(2) 中央制御室待避室の気密性能確認 中央制御室待避室の気密性能確認として、中央制御室待避室の陽圧化試験を実施する。中央制御室待避室の陽圧化試験として、中央制御室待避室空気ポンベ陽圧化装置を用いた中央制御室待避室と隣接区画が陽圧化に必要な差圧が確保可能であることの確認を実施する。(陽圧化に必要な差圧については、(P.59-6-2)を参照)</p> <p>中央制御室待避室の陽圧化試験のバウンダリ構成図を図 59-5-3 に示す。</p>	<p>【中央制御室待避室の正圧化試験】</p> <p>(1) 概要 中央制御室待避室の気密性に関する試験検査として原子炉停止中において、正圧化試験を実施する。</p> <p>(2) 試験内容</p> <p>中央制御室待避室空気ポンベユニットの操作弁を開として中央制御室待避室を加圧し、中央制御室待避室及び中央制御室で正圧化に必要な差圧の確保が可能なことを確認する。(必要な差圧は、59-6-2に示す。)</p> <p>中央制御室待避室の正圧化試験におけるバウンダリ構成図を第59-5-2図に示す。</p>	<p>○中央制御室及び中央制御室待避室の気密性に関する試験検査について</p> <p>1. 概要 中央制御室及び中央制御室待避室の気密性に関する試験検査として、プラント停止中において、正圧化試験を実施する。</p> <p>2. 試験内容 (1) 中央制御室の気密性能確認 中央制御室の気密性能確認として、中央制御室の正圧化試験を実施する。 中央制御室の正圧化試験として、中央制御室給排気隔離弁及び中央制御室外気取入調節弁の動作確認、並びに再循環用ファン及びチャコール・フィルタ・ブースタ・ファンを用いて中央制御室と隣接区画が正圧化に必要な差圧を確保可能であることの確認を実施する。(正圧化に必要な差圧については、(59-6)を参照) 中央制御室の正圧化試験のバウンダリ構成図を図 59-5-2 に示す。</p> <p>(2) 中央制御室待避室の気密性能確認 中央制御室待避室の気密性能確認として、中央制御室待避室の正圧化試験を実施する。中央制御室待避室の正圧化試験として、中央制御室待避室正圧化装置(空気ポンベ)を用いた中央制御室待避室と隣接区画の正圧化に必要な差圧が確保可能であることの確認を実施する。(正圧化に必要な差圧については、(59-6)を参照) 中央制御室待避室の正圧化試験のバウンダリ構成図を図 59-5-3 に示す。</p>	<p>・設備及び運用の相違 【東海第二】 ①の相違</p>

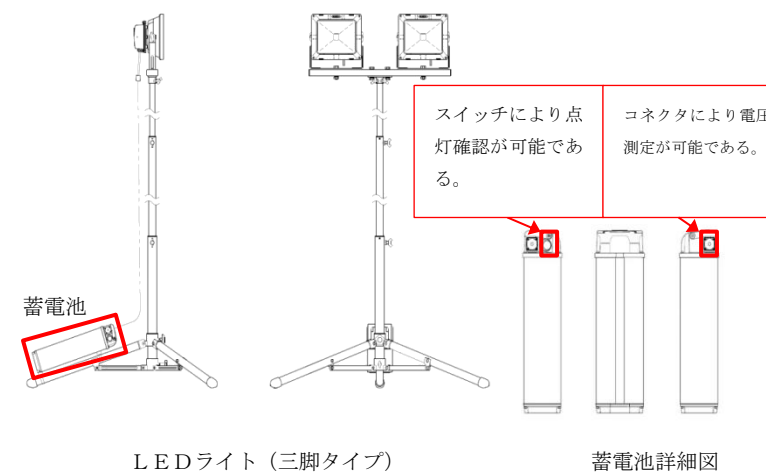

図 59-5-2 中央制御室の陽圧化試験におけるバウンダリ構成図



図 59-5-2 中央制御室の正圧化試験におけるバウンダリ構成図

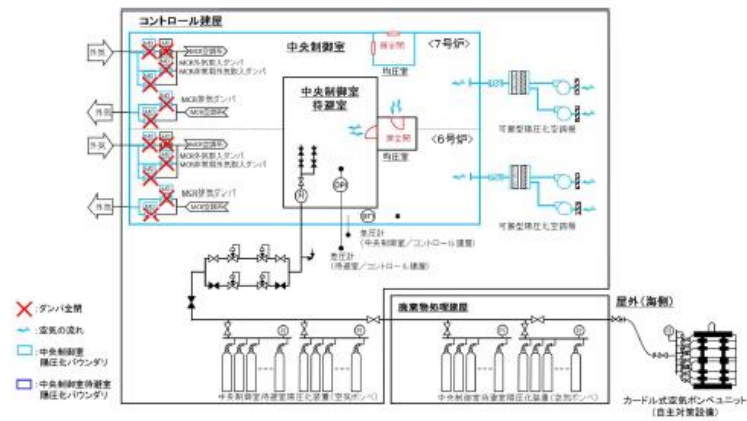

図 59-5-3 中央制御室待避室の陽圧化試験におけるバウンダリ構成図

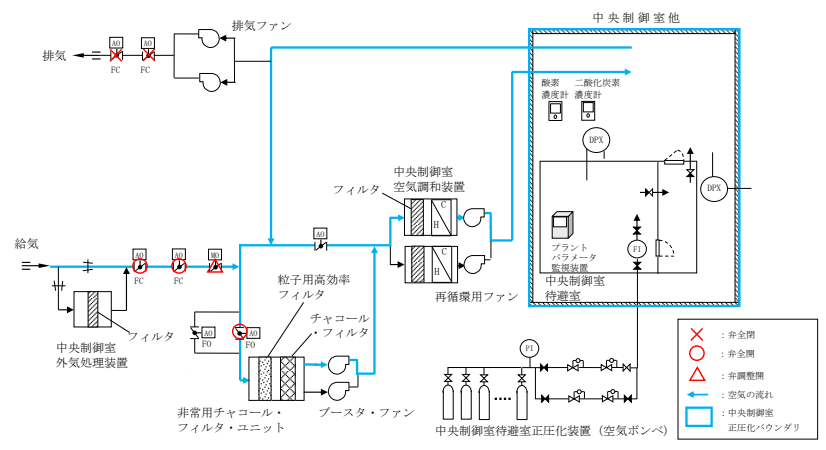

第59-5-2図 中央制御室待避室の正圧化試験におけるバウンダリ構成図

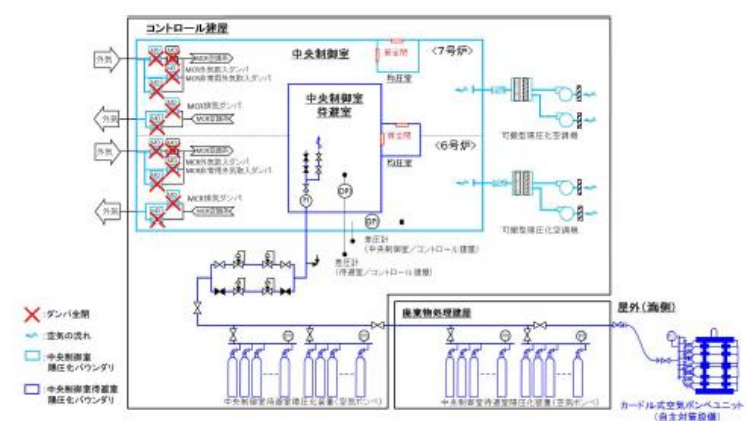
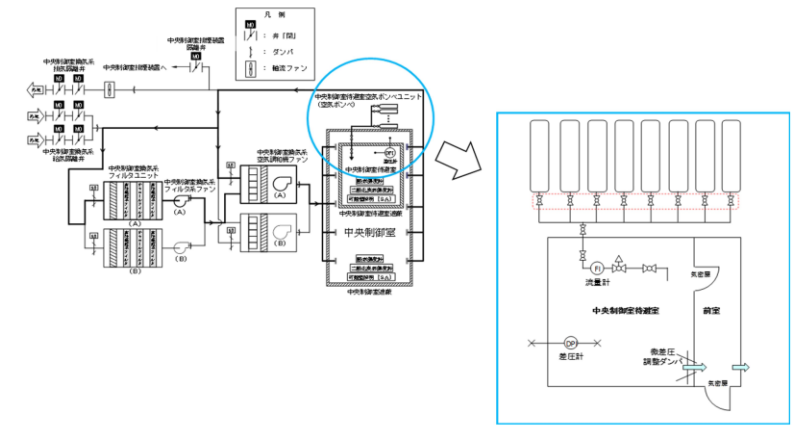

図 59-5-3 中央制御室待避室の正圧化試験におけるバウンダリ構成図

・設備及び運用の相違
【東海第二】
 ①の相違
 ・自主対策設備の相違
【柏崎6/7】
 ②の相違

○無線連絡設備(常設)及び衛星電話設備(常設)の試験・検査について

無線連絡設備(常設)及び衛星電話設備(常設)における試験及び検査は表59-5-1のとおりである。

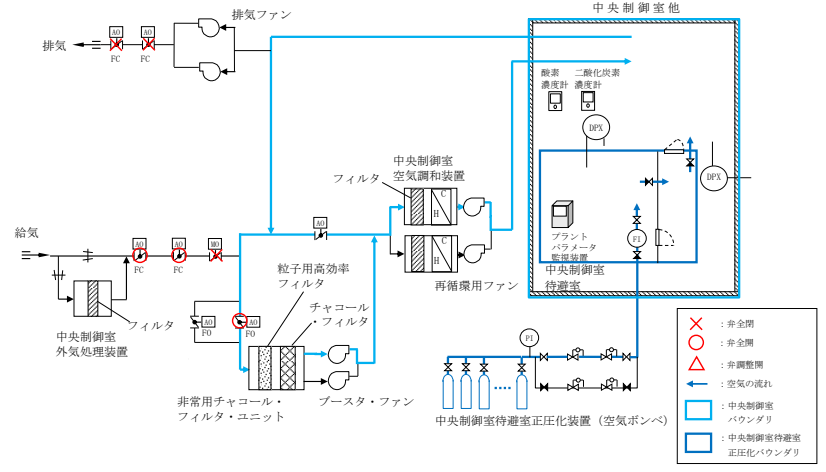
無線連絡設備(常設)及び衛星電話設備(常設)の概要を図59-5-4に示す。

表 59-5-1 無線連絡設備(常設)及び衛星電話設備(常設)の試験・検査

状態	項目	試験・検査項目
運転中 又は 停止中	外観検査機能・ 性能試験	通話通信の確認
	外観検査	外観の確認



図 59-5-4 無線連絡設備(常設)及び衛星電話設備(常設)の概要

○衛星電話設備(可搬型)(待避室)の試験検査について

衛星電話設備(可搬型)(待避室)は、原子炉の運転中又は停止中に第59-5-7表に示す試験検査が可能な設計とする。

衛星電話設備(可搬型)(待避室)の概要を第59-5-3図に、試験検査構成を第59-5-4図に示す。

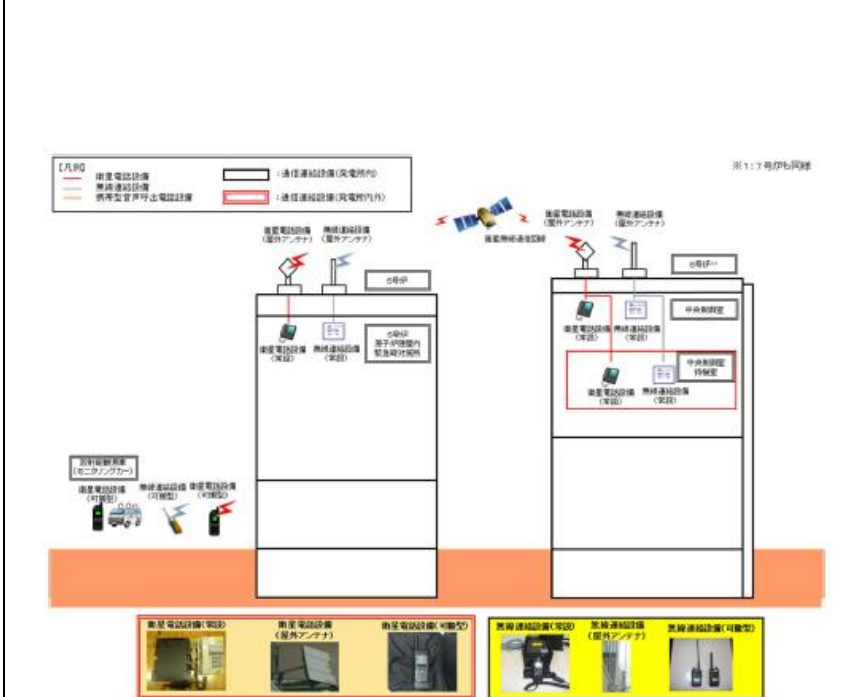
第59-5-7表 衛星電話設備(可搬型)(待避室)の試験検査

原子炉の状態	項目	内容
運転中又は停止中	外観検査	外観の確認
	機能・性能検査	通話通信の確認

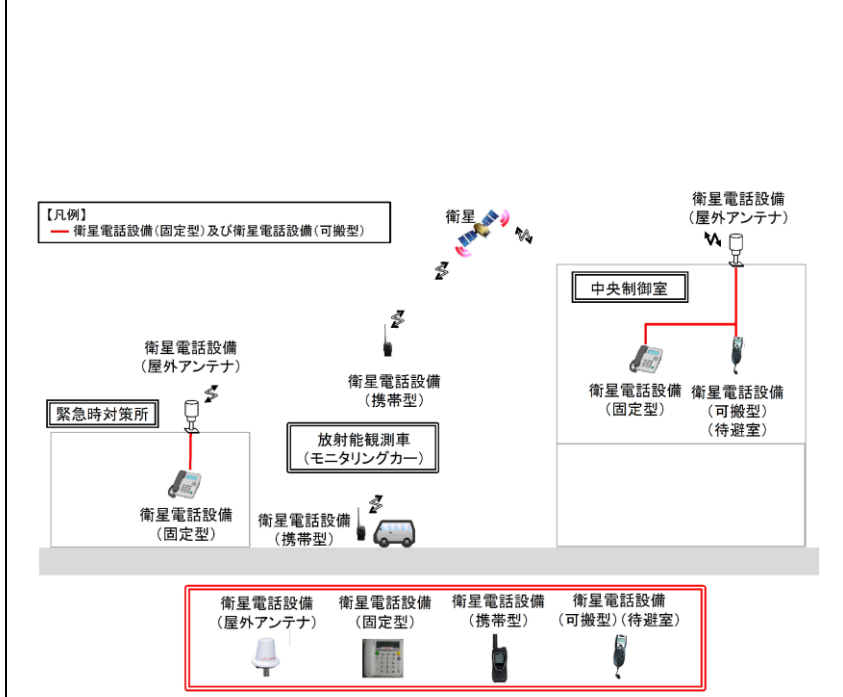

第 59-5-3 図 衛星電話設備(可搬型)(待避室)の概要

○無線通信設備(固定型)及び衛星電話設備(固定型)の試験・検査について

無線通信設備(固定型)及び衛星電話設備(固定型)における試験及び検査は表59-5-4のとおりである。

無線通信設備(固定型)及び衛星電話設備(固定型)の概要を図59-5-4に、無線通信設備(固定型)試験・検査構成を図59-5-5及び図59-5-6に、衛星電話設備(固定型)試験・検査構成を図59-5-7に示す。

表 59-5-4 無線通信設備(固定型)及び衛星電話設備(固定型)の試験・検査

原子炉の状態	項目	試験・検査項目
運転中 又は 停止中	外観検査機能・ 性能試験	通話通信の確認
	外観検査	外観の確認



図 59-5-4 無線通信設備(固定型)及び衛星電話設備(固定型)の概要

・設備の相違
【東海第二】
③の相違

柏崎刈羽原子力発電所 6 / 7号炉 (2017. 12. 20 版)	東海第二発電所 (2018. 9. 18 版)	島根原子力発電所 2号炉	備考
<p>無線連絡設備 (常設) 試験・検査内容</p> <p>【試験構成】</p>  <p>※ 試験区間 : 6号及び7号炉中央制御室待避室～5号炉原子炉建屋内緊急時対策所</p> <p>図 59-5-5 無線連絡設備 (常設) 試験・検査構成</p>		<p>○無線通信設備 (固定型) 試験・検査内容</p> <p>【試験構成】</p>  <p>※ 試験区間 : 中央制御室 (中央制御室待避室を含む。) ～ 緊急時対策所</p> <p>図 59-5-5 無線通信設備 (固定型) 試験・検査構成 (1 / 2)</p>	<p>・設備の相違 【東海第二】 ③の相違</p>

柏崎刈羽原子力発電所 6 / 7号炉 (2017. 12. 20 版)	東海第二発電所 (2018. 9. 18 版)	島根原子力発電所 2号炉	備考
<p>無線連絡設備 (可搬型 / 常設) 試験・検査内容</p> <p>【試験構成】</p>  <p>※ 試験区間：現場 (可搬型) ～6号及び7号炉中央制御室待避室</p> <p>図 59-5-6 無線連絡設備 (可搬型 / 常設) 試験・検査構成</p>		<p>○無線通信設備 (固定型) 試験・検査内容</p> <p>【試験構成】</p>  <p>※ 試験区間：屋外 (携帯型) ～ 中央制御室 (固定型)</p> <p>図 59-5-6 無線通信設備 (固定型) 試験・検査構成 (2 / 2)</p>	<p>備考</p> <p>・設備の相違 【東海第二】 ③の相違</p>

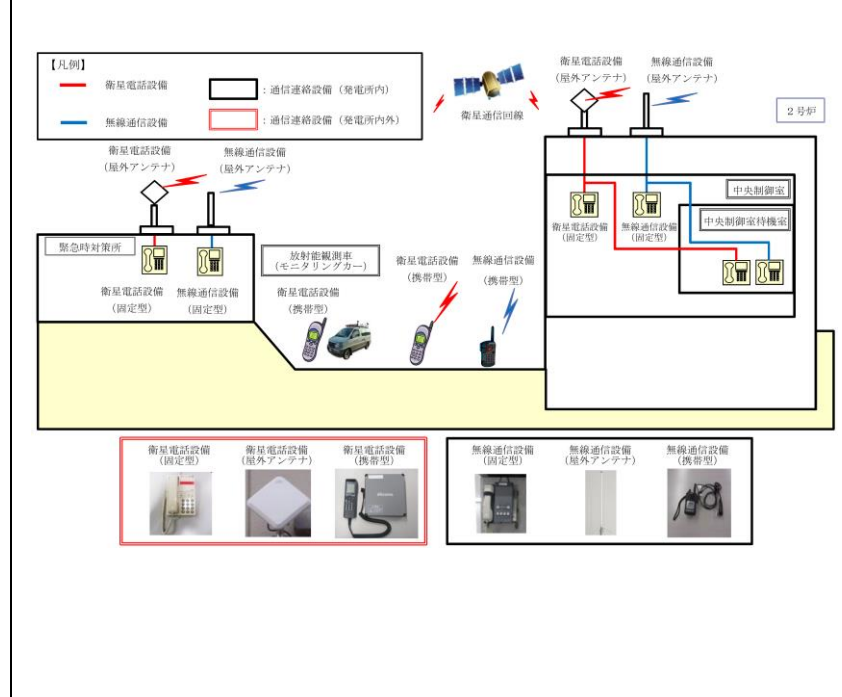
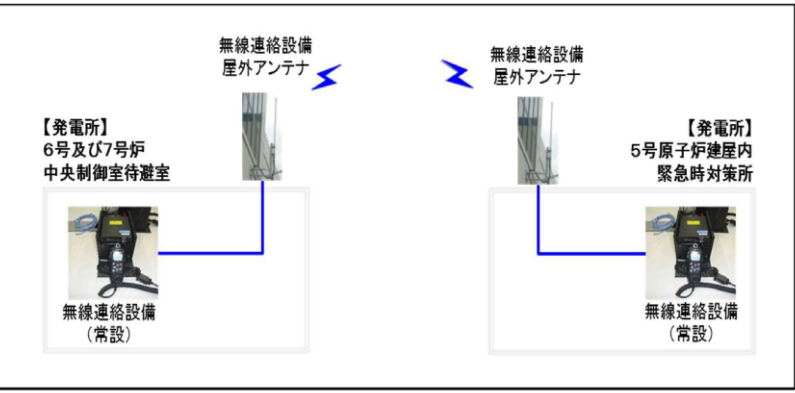
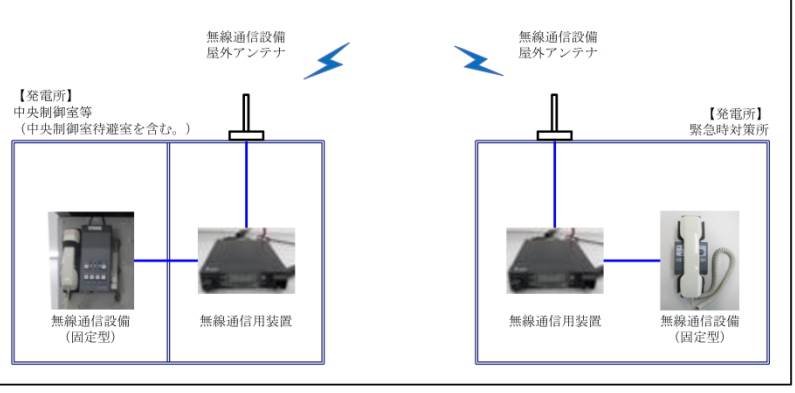
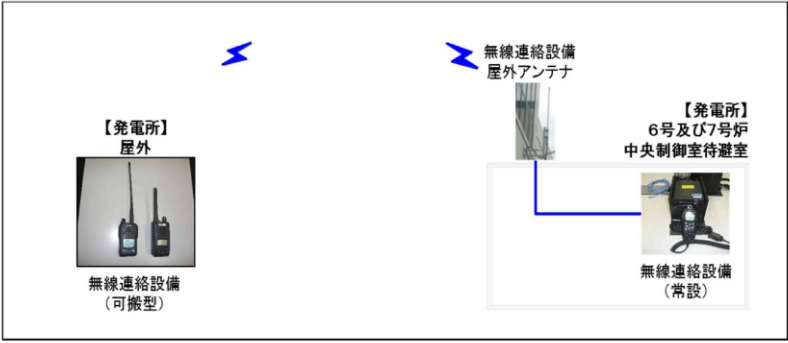
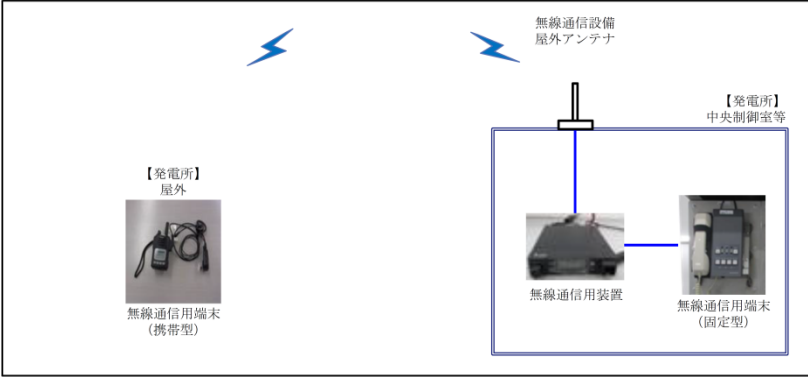
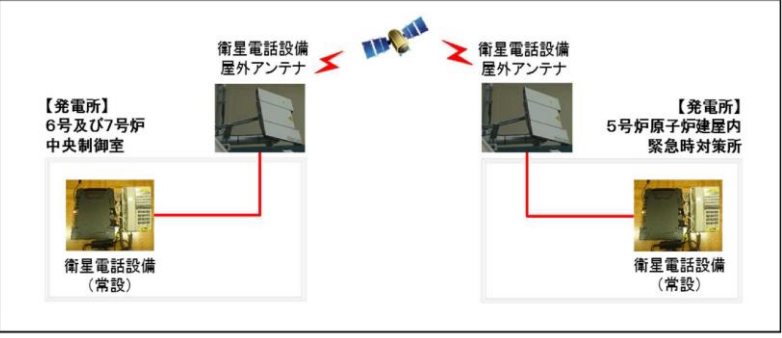
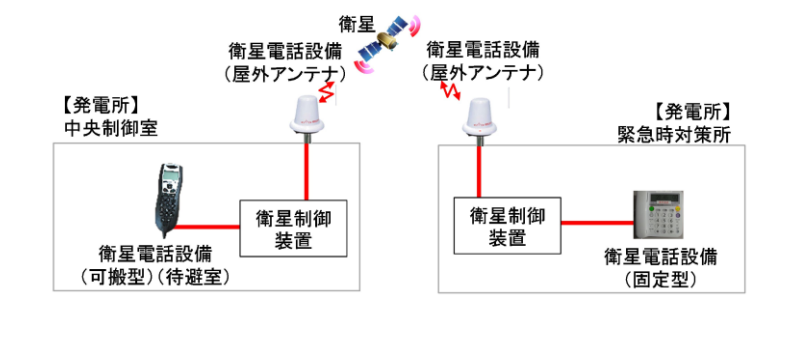
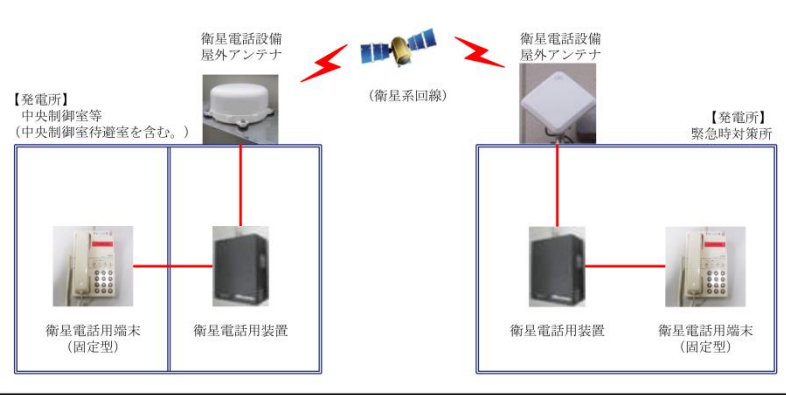
柏崎刈羽原子力発電所 6 / 7号炉 (2017. 12. 20 版)	東海第二発電所 (2018. 9. 18 版)	島根原子力発電所 2号炉	備考
<p>衛星電話設備(常設) 試験・検査内容</p> <p>【試験構成】</p>  <p>※ 試験区間：6号及び7号炉中央制御室待避室～5号炉原子炉建屋内緊急時対策所</p> <p>図 59-5-7 衛星電話設備(常設) 試験・検査構成</p>	<p>【試験構成】</p>  <p>※ 試験区間：中央制御室(待避室)～緊急時対策所建屋</p> <p>第 59-5-4 図 衛星電話設備(可搬型)(待避室) 試験検査構成</p>	<p>○衛星電話設備(固定型) 試験・検査内容</p> <p>【試験構成】</p>  <p>※ 試験区間：中央制御室(中央制御室待避室を含む)～緊急時対策所</p> <p>図 59-5-7 衛星電話設備(固定型) 試験・検査構成</p>	

○データ表示装置(待避室)の試験及び検査について

データ表示装置(待避室)における試験及び検査は表59-5-2のとおりである。

データ表示装置(待避室)の概要を図59-5-8に示す。

表59-5-2 データ表示装置(待避室)の試験・検査

状態	項目	試験・検査項目
運転中	機能・性能試験	機能の確認
又は 停止中	外観検査	外観の確認



図59-5-8 データ表示装置(待避室)の概要

○データ表示装置(待避室)の試験検査について

データ表示装置(待避室)は、原子炉の運転中又は停止中に第59-5-8表に示す試験検査が可能な設計とする。

データ表示装置(待避室)の概要を第59-5-5図に、試験検査構成を第59-5-6図に示す。

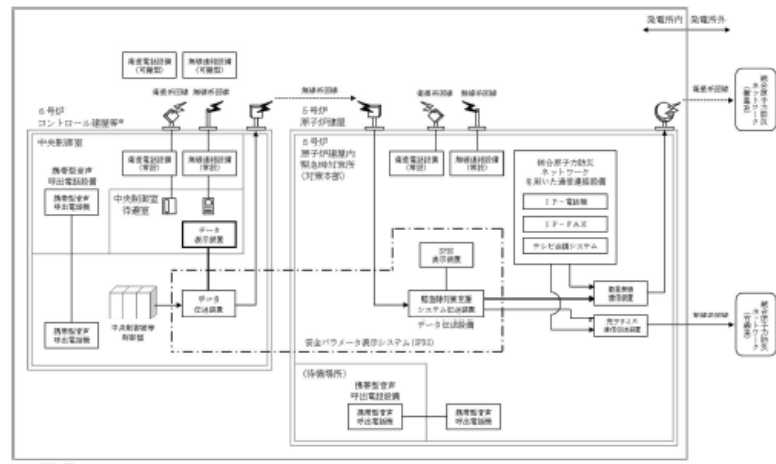
第59-5-8表 データ表示装置(待避室)の試験検査

原子炉の状態	項目	内容
運転中又は停止中	外観検査	外観の確認
	機能・性能検査	機能(データの表示)の確認

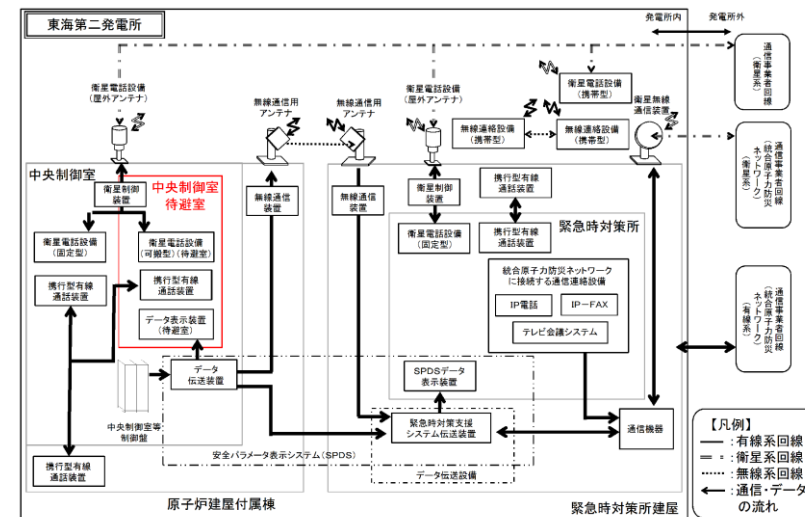

第59-5-5図 データ表示装置(待避室)の概要

○プラントパラメータ監視装置(中央制御室待避室)の試験及び検査について

プラントパラメータ監視装置(中央制御室待避室)における試験及び検査は表59-5-5のとおりである。

プラントパラメータ監視装置(中央制御室待避室)の概要を図59-5-8に、試験・検査構成を図59-5-9に示す。

表59-5-5 プラントパラメータ監視装置(中央制御室待避室)の試験・検査

原子炉の状態	項目	試験・検査項目
運転中 又は 停止中	機能・性能試験	機能(データの表示及び伝送)の確認
	外観検査	外観の確認



図59-5-8 プラントパラメータ監視装置(中央制御室待避室)の概要

柏崎刈羽原子力発電所 6/7号炉 (2017.12.20版)	東海第二発電所 (2018.9.18版)	島根原子力発電所 2号炉	備考
<p>データ表示装置 (待避室) 試験・検査内容</p> <p>【試験構成】</p>  <p>※写真についてはイメージ。</p> <p>図 59-5-9 データ表示装置 (待避室) 試験・検査構成</p>	<p>【試験構成】</p>  <p>第59-5-6図 データ表示装置 (待避室) 試験検査構成</p>	<p>○プラントパラメータ監視装置 (中央制御室待避室) 試験・検査内容</p> <p>【試験構成】</p>  <p>図 59-5-9 プラントパラメータ監視装置 (中央制御室待避室) 試験・検査構成</p>	

柏崎刈羽原子力発電所 6 / 7号炉 (2017. 12. 20版)	東海第二発電所 (2018. 9. 18版)	島根原子力発電所 2号炉	備考																																												
	<p>○ 中央制御室換気系及び原子炉建屋ガス処理系の試験検査について</p> <p>中央制御室換気系及び原子炉建屋ガス処理系は、原子炉の運転中又は停止中に第59-5-2表に示す試験検査が可能な設計とする。</p> <p>第59-5-2表 <u>中央制御室換気系及び原子炉建屋ガス処理系の試験検査</u></p> <table border="1" data-bbox="952 625 1706 852"> <thead> <tr> <th>原子炉の状態</th> <th>項目</th> <th>内容</th> </tr> </thead> <tbody> <tr> <td rowspan="2">運転中又は停止中</td> <td>外観検査</td> <td>各機器^{※1}の表面状態を目視により確認</td> </tr> <tr> <td>機能・性能検査</td> <td>ファンの運転状態の確認 フィルタ差圧の確認</td> </tr> <tr> <td>停止中</td> <td>分解検査</td> <td>ファンの分解点検</td> </tr> </tbody> </table> <p>※1 <u>各機器とは、以下のとおり：</u> <u>中央制御室換気系空気調和機ファン、中央制御室換気系フィルタ系ファン、中央制御室換気系フィルタユニット並びに原子炉建屋ガス処理系の非常用ガス処理系排風機及び非常用ガス再循環系排風機</u></p>	原子炉の状態	項目	内容	運転中又は停止中	外観検査	各機器 ^{※1} の表面状態を目視により確認	機能・性能検査	ファンの運転状態の確認 フィルタ差圧の確認	停止中	分解検査	ファンの分解点検	<p>○中央制御室換気系及び非常用ガス処理系の試験検査について</p> <p>中央制御室換気系及び非常用ガス処理系は、原子炉の運転中又は停止中に表59-5-6及び表59-5-7に示す試験検査が可能な設計とする。</p> <p>表59-5-6 <u>中央制御室換気系の試験検査</u></p> <table border="1" data-bbox="1742 583 2499 989"> <thead> <tr> <th>原子炉の状態</th> <th>項目</th> <th>内容</th> </tr> </thead> <tbody> <tr> <td rowspan="2">運転中</td> <td>機能・性能試験</td> <td>再循環用ファン及びチャコール・フィルタ・ブースタ・ファンの運転性能の確認</td> </tr> <tr> <td>外観検査</td> <td>中央制御室換気系の表面状態の外観確認</td> </tr> <tr> <td rowspan="3">停止中</td> <td>機能・性能試験</td> <td>再循環用ファン及びチャコール・フィルタ・ブースタ・ファンの運転性能の確認 中央制御室の正圧化試験</td> </tr> <tr> <td>分解検査</td> <td>再循環用ファン、チャコール・フィルタ・ブースタ・ファン及び非常用チャコール・フィルタ・ユニット部品の表面状態を試験及び目視により確認</td> </tr> <tr> <td>外観確認</td> <td>中央制御室換気系の表面状態の外観確認</td> </tr> </tbody> </table> <p>表59-5-7 <u>非常用ガス処理系の試験検査</u></p> <table border="1" data-bbox="1742 1163 2499 1528"> <thead> <tr> <th>原子炉の状態</th> <th>項目</th> <th>内容</th> </tr> </thead> <tbody> <tr> <td rowspan="2">運転中</td> <td>機能・性能試験</td> <td>運転性能、漏えいの確認</td> </tr> <tr> <td>弁動作試験</td> <td>弁開閉動作の確認</td> </tr> <tr> <td rowspan="3">停止中</td> <td>機能・性能試験</td> <td>運転性能、漏えいの確認</td> </tr> <tr> <td>弁動作試験</td> <td>弁開閉動作の確認</td> </tr> <tr> <td>分解検査</td> <td>非常用ガス処理系排気ファン部品の表面状態を試験及び目視により確認</td> </tr> <tr> <td></td> <td>外観検査</td> <td>非常用ガス処理系排気ファンの外観の確認</td> </tr> </tbody> </table>	原子炉の状態	項目	内容	運転中	機能・性能試験	再循環用ファン及びチャコール・フィルタ・ブースタ・ファンの運転性能の確認	外観検査	中央制御室換気系の表面状態の外観確認	停止中	機能・性能試験	再循環用ファン及びチャコール・フィルタ・ブースタ・ファンの運転性能の確認 中央制御室の正圧化試験	分解検査	再循環用ファン、チャコール・フィルタ・ブースタ・ファン及び非常用チャコール・フィルタ・ユニット部品の表面状態を試験及び目視により確認	外観確認	中央制御室換気系の表面状態の外観確認	原子炉の状態	項目	内容	運転中	機能・性能試験	運転性能、漏えいの確認	弁動作試験	弁開閉動作の確認	停止中	機能・性能試験	運転性能、漏えいの確認	弁動作試験	弁開閉動作の確認	分解検査	非常用ガス処理系排気ファン部品の表面状態を試験及び目視により確認		外観検査	非常用ガス処理系排気ファンの外観の確認	<p>備考</p> <p>・設備の相違 【東海第二】 島根2号炉には非常用ガス再循環系はない</p>
原子炉の状態	項目	内容																																													
運転中又は停止中	外観検査	各機器 ^{※1} の表面状態を目視により確認																																													
	機能・性能検査	ファンの運転状態の確認 フィルタ差圧の確認																																													
停止中	分解検査	ファンの分解点検																																													
原子炉の状態	項目	内容																																													
運転中	機能・性能試験	再循環用ファン及びチャコール・フィルタ・ブースタ・ファンの運転性能の確認																																													
	外観検査	中央制御室換気系の表面状態の外観確認																																													
停止中	機能・性能試験	再循環用ファン及びチャコール・フィルタ・ブースタ・ファンの運転性能の確認 中央制御室の正圧化試験																																													
	分解検査	再循環用ファン、チャコール・フィルタ・ブースタ・ファン及び非常用チャコール・フィルタ・ユニット部品の表面状態を試験及び目視により確認																																													
	外観確認	中央制御室換気系の表面状態の外観確認																																													
原子炉の状態	項目	内容																																													
運転中	機能・性能試験	運転性能、漏えいの確認																																													
	弁動作試験	弁開閉動作の確認																																													
停止中	機能・性能試験	運転性能、漏えいの確認																																													
	弁動作試験	弁開閉動作の確認																																													
	分解検査	非常用ガス処理系排気ファン部品の表面状態を試験及び目視により確認																																													
	外観検査	非常用ガス処理系排気ファンの外観の確認																																													

柏崎刈羽原子力発電所 6 / 7号炉 (2017. 12. 20 版)	東海第二発電所 (2018. 9. 18 版)	島根原子力発電所 2号炉	備考
	<p>○ <u>中央制御室換気系及び原子炉建屋ガス処理系の点検計画について</u></p> <p>中央制御室換気系及び原子炉建屋ガス処理系は設計基準事故対処設備であるとともに、重大事故等時においても使用する既設設備であるため、これまでに点検計画に基づく試験検査を実施している。</p> <p>中央制御室換気系及び原子炉建屋ガス処理系の点検計画を第59-5-3表に示す。</p>	<p>○ <u>中央制御室換気系及び非常用ガス処理系の点検計画について</u></p> <p>中央制御室換気系及び非常用ガス処理系は設計基準事故対処設備であるとともに、重大事故等時においても使用する既設設備であるため、これまでに点検計画に基づく試験検査を実施している。</p> <p>中央制御室換気系及び非常用ガス処理系の点検計画を表59-5-8に示す。</p>	

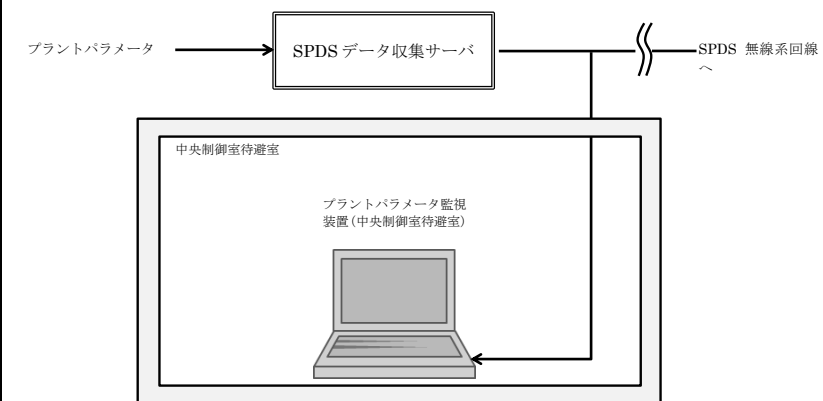
表 59-5-3 柏崎刈羽原子力発電所 6号炉 点検計画

第 59-5-3 表 中央制御室換気系及び原子炉建屋ガス処理系
点検計画 (1/6)

表 59-5-8 中央制御室換気系及び非常用ガス処理系点検計画
(1/4)

機種又は系統名	実数(種別名)	保全の 要度	点検及び試験・検査 の項目	保全方式 または頻度	検査名	備 考 () 内は適用する設備診断改善
燃料プールの汚濁浄化系	燃料プールの汚濁浄化系交換器 (B)	3	運転点検 非運転点検	19.5M B	—	プールの運転中 プールの運転中
	燃料プールの汚濁浄化系 ろ過機 (A) 出口ストレーナ	2	運転点検	6.5M	—	プールの運転中
	燃料プールの汚濁浄化系 ろ過機 (B) 出口ストレーナ	2	運転点検	6.5M	—	プールの運転中
	燃料プールの汚濁浄化系ろ過機 (A)	3	運転点検	10.4M	—	プールの運転中
	燃料プールの汚濁浄化系ろ過機 (B)	3	運転点検	10.4M	—	プールの運転中
プロセスモニタ	プロセスモニタ 37台 格納容器内空気モニタ 4台	B, C, I, 3	機能・性能試験 特性試験	1.0C 1.0C	プロセスモニタ機能検査 プロセスモニタ機能検査	定検等中止 定検等中止
	プロセスモニタ 2台	I, 3	機能・性能試験 特性試験	1.0C 1.0C	— —	定検等中止 定検等中止
	プロセスモニタ 2台	I, 3	機能・性能試験 特性試験	1.0C 1.0C	— —	定検等中止 定検等中止
非常用ガス処理系	非常用ガス処理系 (A) (B) 2系別	1	機能・性能試験	1.0C	非常用ガス処理系機能検査	定検等中止
	非常用ガス処理系 (A) (B) 2系別	1	分解点検	13.0M	—	プロセスモニタ [運転診断 3M] [非外線診断 1.0C]
	非常用ガス処理系 (A) (B) 2系別	1	分解点検	13.0M	—	定検等中止 [運転診断 3M] [非外線診断 1.0C]
	非常用ガス処理系 (A) (B) 2系別	1	分解点検	7.8M	—	定検等中止 [運転診断 3M] [非外線診断 1.0C]
	非常用ガス処理系 (A) (B) 2系別	1	分解点検	7.8M	—	定検等中止 [運転診断 3M] [非外線診断 1.0C]
	非常用ガス処理系 (A) (B) 2系別	1	機能・性能試験	1.0C	非常用ガス処理系設備検査 (その1)	定検等中止
	非常用ガス処理系 (A) (B) 2系別	1	機能・性能試験	1.0C	非常用ガス処理系設備検査 (その1)	定検等中止
	非常用ガス処理系 (A) (B) 2系別	1	機能・性能試験	1.0C	非常用ガス処理系設備検査 (その1)	定検等中止
	非常用ガス処理系 (A) (B) 2系別	1	機能・性能試験	1.0C	非常用ガス処理系設備検査 (その1)	定検等中止
	非常用ガス処理系 (A) (B) 2系別	1	機能・性能試験	1.0C	非常用ガス処理系設備検査 (その1)	定検等中止
	非常用ガス処理系 (A) (B) 2系別	1	機能・性能試験	1.0C	非常用ガス処理系設備検査 (その1)	定検等中止
	非常用ガス処理系 (A) (B) 2系別	1	機能・性能試験	1.0C	非常用ガス処理系設備検査 (その1)	定検等中止
換気空調系	原子炉区域・タービン区域送風機 (A)	3	機能・性能試験	1.0C	換気空調系機能検査 (その1)	定検等中止 [運転診断 3M] [非外線診断 6M]
	原子炉区域・タービン区域送風機 (A)	3	分解点検	4FY	—	—
	原子炉区域・タービン区域送風機 (A)	3	運転点検	1FY	—	—
	原子炉区域・タービン区域送風機 (B)	3	機能・性能試験	1.0C	換気空調系機能検査 (その1)	定検等中止 [運転診断 3M] [非外線診断 6M]
	原子炉区域・タービン区域送風機 (B)	3	分解点検	4FY	—	—
	原子炉区域・タービン区域送風機 (B)	3	運転点検	1FY	—	—
	原子炉区域・タービン区域送風機 (C)	3	機能・性能試験	1.0C	換気空調系機能検査 (その1)	定検等中止 [運転診断 3M] [非外線診断 6M]
	原子炉区域・タービン区域送風機 (C)	3	分解点検	4FY	—	—
	原子炉区域・タービン区域送風機 (C)	3	運転点検	1FY	—	—
	原子炉区域・タービン区域送風機 (D)	3	機能・性能試験	1.0C	換気空調系機能検査 (その1)	定検等中止 [運転診断 3M] [非外線診断 6M]
	原子炉区域・タービン区域送風機 (D)	3	分解点検	4FY	—	—
	原子炉区域・タービン区域送風機 (D)	3	運転点検	1FY	—	—
原子炉区域・タービン区域送風機 (E)	3	機能・性能試験	1.0C	換気空調系機能検査 (その1)	定検等中止 [運転診断 3M] [非外線診断 6M]	
原子炉区域・タービン区域送風機 (E)	3	分解点検	4FY	—	—	
原子炉区域・タービン区域送風機 (E)	3	運転点検	1FY	—	—	



柏崎刈羽原子力発電所 6 / 7 号炉 (2017. 12. 20 版)	東海第二発電所 (2018. 9. 18 版)	島根原子力発電所 2号炉	備考
	<p data-bbox="982 212 1706 289">第 59-5-3 表 中央制御室換気系及び原子炉建屋ガス処理系 点検計画 (2/6)</p> <div data-bbox="955 338 1709 1860" style="border: 1px solid black; height: 725px;"></div>	<p data-bbox="1742 212 2487 289">表 59-5-8 中央制御室換気系及び非常用ガス処理系点検計画 (2 / 4)</p> <div data-bbox="1754 338 2484 1860" style="border: 1px solid black; height: 725px;"></div>	

柏崎刈羽原子力発電所 6 / 7 号炉 (2017. 12. 20 版)	東海第二発電所 (2018. 9. 18 版)	島根原子力発電所 2号炉	備考
	<p data-bbox="964 210 1697 289">第 59-5-3 表 中央制御室換気系及び原子炉建屋ガス処理系 点検計画 (3/6)</p> 	<p data-bbox="1757 210 2490 289">表 59-5-8 中央制御室換気系及び非常用ガス処理系点検計画 (3 / 4)</p> 	

柏崎刈羽原子力発電所 6 / 7 号炉 (2017. 12. 20 版)	東海第二発電所 (2018. 9. 18 版)	島根原子力発電所 2号炉	備考
	<p data-bbox="964 212 1694 289">第 59-5-3 表 中央制御室換気系及び原子炉建屋ガス処理系 点検計画 (4/6)</p> <div data-bbox="946 310 1694 1780" style="border: 1px solid black; height: 700px; width: 100%;"></div>	<p data-bbox="1754 212 2484 289">表 59-5-8 中央制御室換気系及び非常用ガス処理系点検計画 (4 / 4)</p> <div data-bbox="1736 310 2484 1780" style="border: 1px solid black; height: 700px; width: 100%;"></div>	

柏崎刈羽原子力発電所 6 / 7 号炉 (2017. 12. 20 版)	東海第二発電所 (2018. 9. 18 版)	島根原子力発電所 2号炉	備考
	<p data-bbox="964 210 1706 283">第 59-5-3 表 中央制御室換気系及び原子炉建屋ガス処理系 点検計画 (5/6)</p> <div data-bbox="955 315 1706 1806" style="border: 2px solid black; height: 710px; width: 100%;"></div>		

柏崎刈羽原子力発電所 6 / 7 号炉 (2017. 12. 20 版)	東海第二発電所 (2018. 9. 18 版)	島根原子力発電所 2 号炉	備考
	<p data-bbox="964 210 1697 289">第 59-5-3 表 中央制御室換気系及び原子炉建屋ガス処理系 点検計画 (6/6)</p> <div data-bbox="955 310 1685 1732" style="border: 1px solid black; height: 677px; width: 246px; margin: 0 auto;"></div>		

柏崎刈羽原子力発電所 6 / 7 号炉 (2017. 12. 20 版)	東海第二発電所 (2018. 9. 18 版)	島根原子力発電所 2 号炉	備考
<p style="text-align: center;"> <u>東京電力株式会社</u> <u>柏崎刈羽原子力発電所第 6 号機</u> <u>第 1 0 保全サイクル定期事業者検査要領書</u> </p> <p> 設 備 名 : 放射線管理設備 検 査 名 : 非常用ガス処理系機能検査 要領書番号 : K 6 - 1 0 - 4 2 - B - 運 </p>		<p style="text-align: center;"> <u>中国電力株式会社</u> <u>島根原子力発電所第 2 号機</u> <u>第 1 7 保全サイクル定期事業者検査要領書</u> <u>(第 2 次改正)</u> </p> <p style="text-align: center;"> <u>プラント長期停止に伴う再検査</u> </p> <p> 施 設 名 : 原子炉格納施設 検 査 名 : 非常用ガス処理系機能検査 要領書番号 : S 2 - 1 7 - II - 2 7 </p>	<p>・設備の相違</p> <p>【柏崎 6/7, 東海第二】 島根 2 号炉は, 至近の検査要領書を抜粋して記載</p>



図 59-5-11 非常用ガス処理系 (6号炉) 機能検査系統図



図 59-5-11 非常用ガス処理系 機能検査系統図

・設備の相違
【柏崎6/7, 東海第二】
島根2号炉は, 至近の検査要領書を抜粋して記載

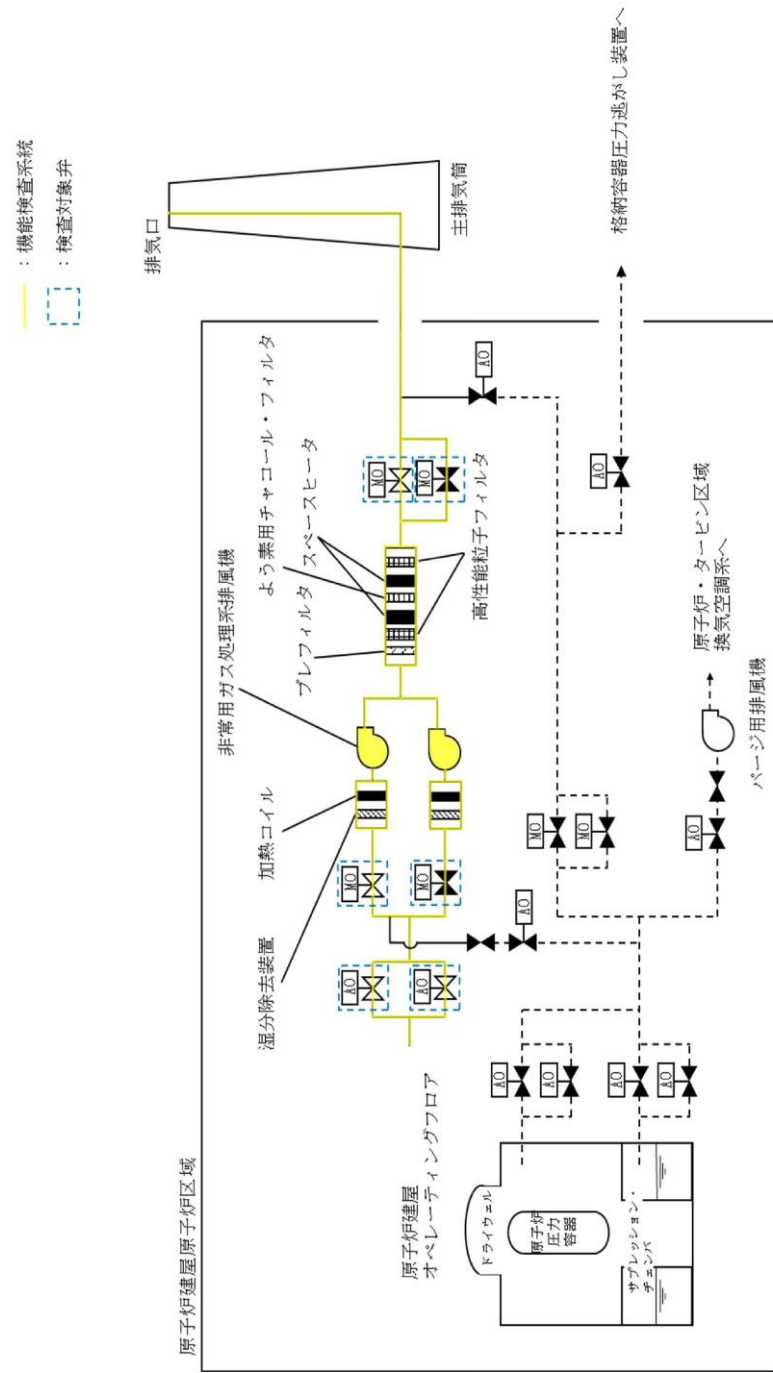

図 59-5-12 非常用ガス処理系排風機 (6号炉) 構造図

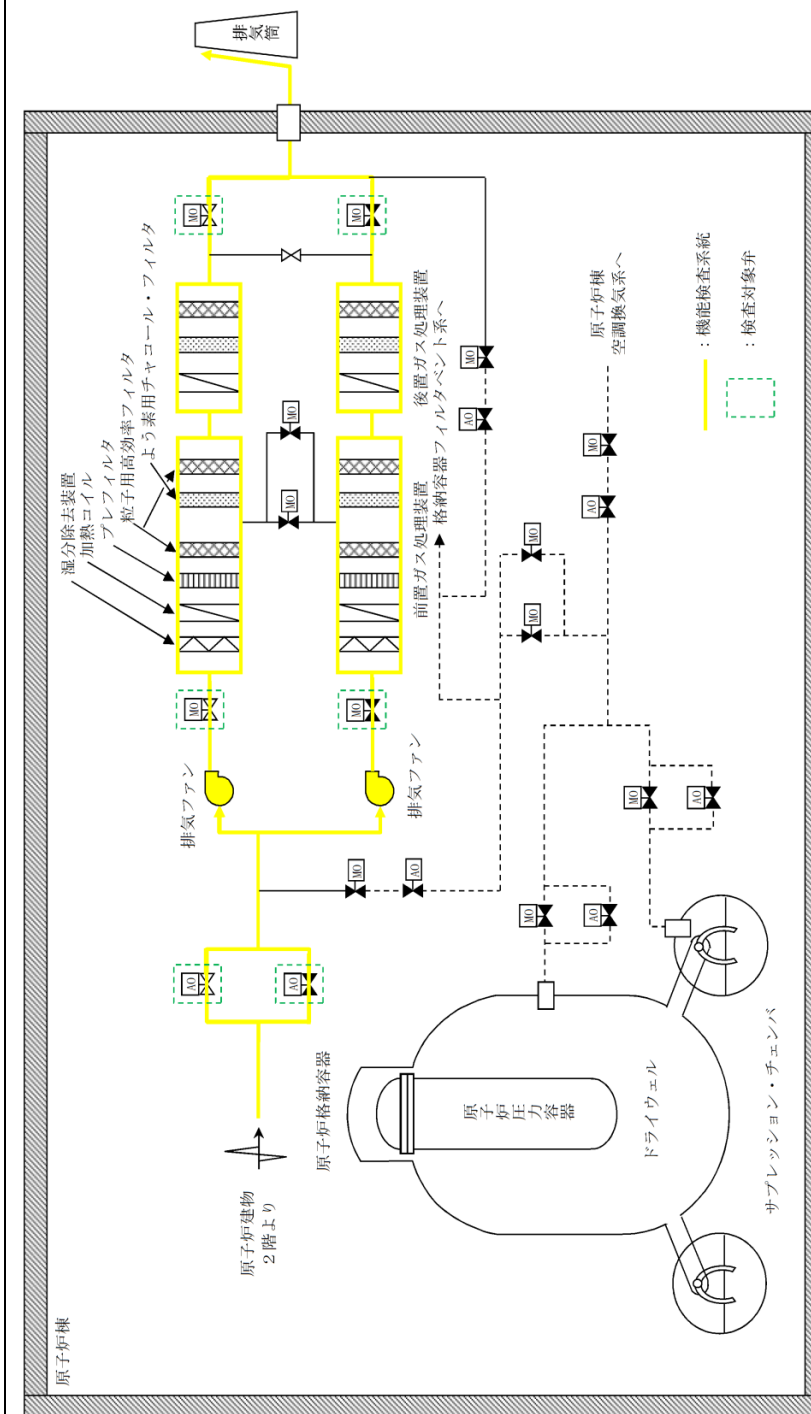

図 59-5-12 非常用ガス処理系排気ファン 構造図

・設備の相違
 【柏崎 6/7, 東海第二】
 島根 2号炉は, 至近の検査要領書を抜粋して記載

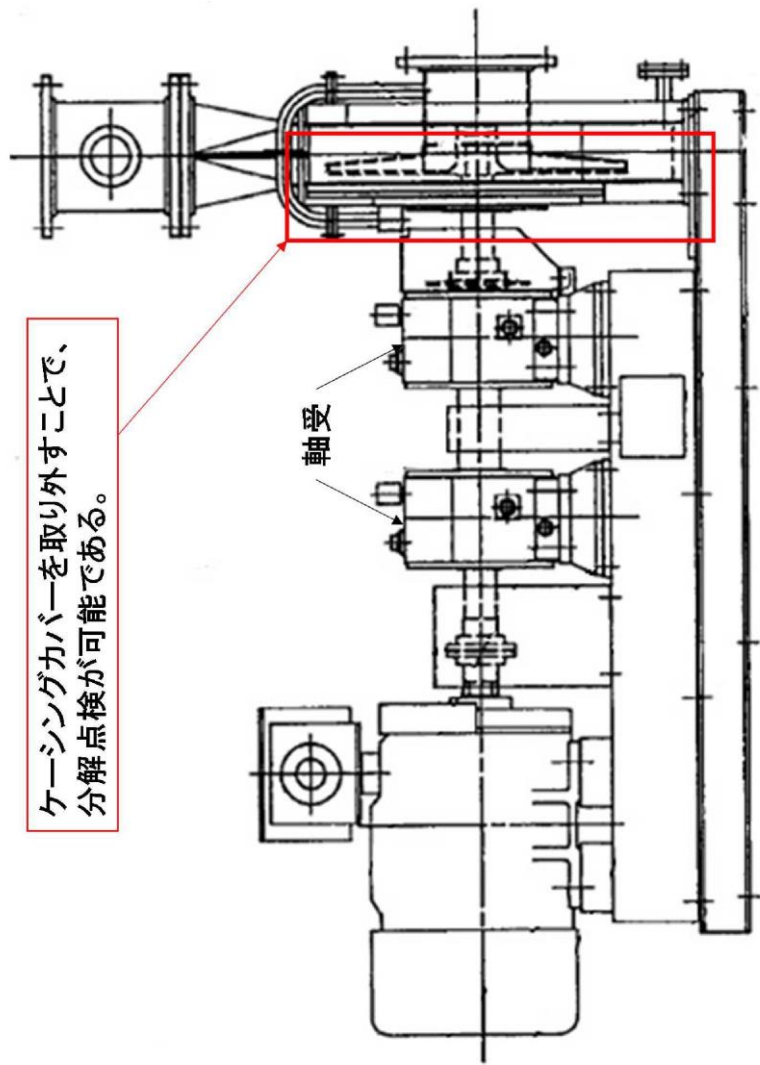
柏崎刈羽原子力発電所 6 / 7 号炉 (2017. 12. 20 版)	東海第二発電所 (2018. 9. 18 版)	島根原子力発電所 2 号炉	備考
<p style="text-align: center;">東京電力株式会社 <u>柏崎刈羽原子力発電所第7号機</u> <u>第10保全サイクル定期事業者検査要領書</u></p> <p>設 備 名 : 放射線管理設備 検 査 名 : 非常用ガス処理系機能検査 要領書番号 : K 7 - 1 0 - 4 2 - B - 運</p>			<p>・申請号炉数の相違 【柏崎 6/7】</p>

・申請号炉数の相違
【柏崎 6/7】

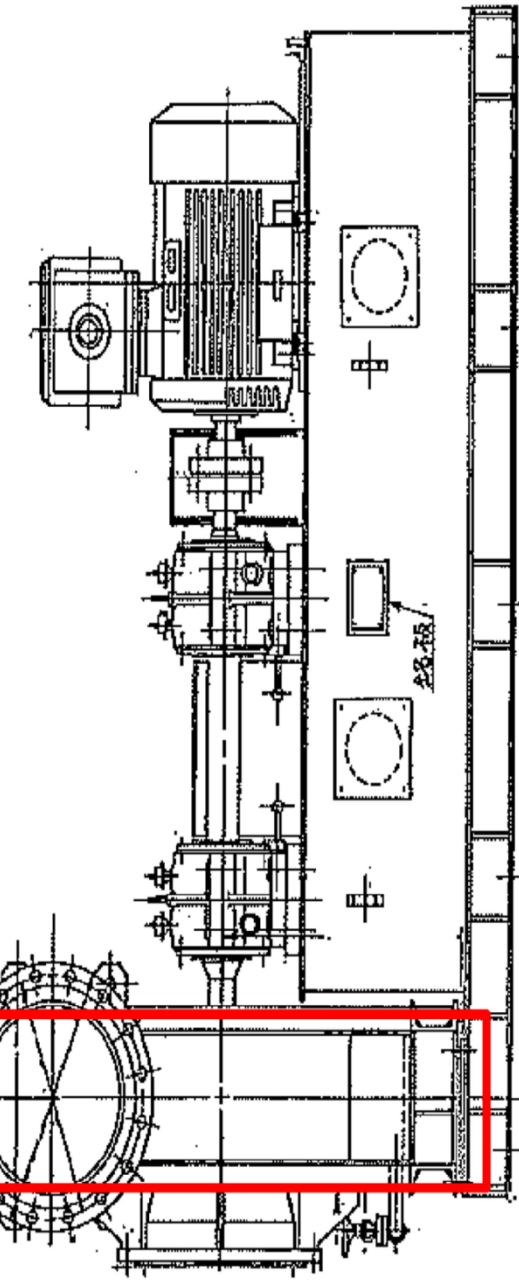

図 59-5-13 非常用ガス処理系 (7号炉) 機能検査系統図

柏崎刈羽原子力発電所 6 / 7号炉 (2017. 12. 20 版)	東海第二発電所 (2018. 9. 18 版)	島根原子力発電所 2号炉	備考
 <p data-bbox="192 588 281 1155">ケーシングカバーを取り外すことで、分解点検が可能である。</p> <p data-bbox="415 1092 474 1176">軸受</p> <p data-bbox="207 1596 875 1638">図 59-5-14 非常用ガス処理系排風機 (7号炉) 構造図</p>			<p data-bbox="2537 168 2804 294">備考 ・申請号炉数の相違 【柏崎 6/7】</p>

柏崎刈羽原子力発電所 6 / 7号炉 (2017. 12. 20 版)	東海第二発電所 (2018. 9. 18 版)	島根原子力発電所 2号炉	備考																		
	<p>○ <u>ブローアウトパネル閉止装置の試験検査について</u></p> <p>ブローアウトパネル閉止装置は、原子炉の運転中又は停止中に第59-5-4表に示す試験検査が可能な設計とする。</p> <p>ブローアウトパネル閉止装置の動作概要を第59-5-1図に示す。</p> <p><u>第59-5-4表 ブローアウトパネル閉止装置の試験検査</u></p> <table border="1" data-bbox="952 667 1706 814"> <thead> <tr> <th>原子炉の状態</th> <th>項目</th> <th>内容</th> </tr> </thead> <tbody> <tr> <td>運転中又は停止中</td> <td>外観検査</td> <td>表面劣化状態の外観確認</td> </tr> <tr> <td>停止中</td> <td>機能・性能検査</td> <td>スライド扉の動作状態の確認</td> </tr> </tbody> </table> <p style="text-align: center;">スライド扉の動作</p>  <p><u>第59-5-1図 ブローアウトパネル閉止装置の動作概要</u></p>	原子炉の状態	項目	内容	運転中又は停止中	外観検査	表面劣化状態の外観確認	停止中	機能・性能検査	スライド扉の動作状態の確認	<p>○ <u>原子炉建物燃料取替階ブローアウトパネル閉止装置の試験検査について</u></p> <p>原子炉建物燃料取替階ブローアウトパネル閉止装置は、原子炉の運転中又は停止中に表 59-5-9 に示す試験検査が可能な設計とする。</p> <p>表 59-5-9 <u>原子炉建物燃料取替階ブローアウトパネル閉止装置の試験検査</u></p> <table border="1" data-bbox="1745 625 2475 804"> <thead> <tr> <th>発電用原子炉の状態</th> <th>項目</th> <th>内容</th> </tr> </thead> <tbody> <tr> <td>運転中又は停止中</td> <td>外観検査</td> <td>原子炉建物燃料取替階ブローアウトパネル閉止装置の外観の確認</td> </tr> <tr> <td>停止中</td> <td>機能・性能試験</td> <td>原子炉建物燃料取替階ブローアウトパネル閉止装置の動作状態の確認</td> </tr> </tbody> </table>	発電用原子炉の状態	項目	内容	運転中又は停止中	外観検査	原子炉建物燃料取替階ブローアウトパネル閉止装置の外観の確認	停止中	機能・性能試験	原子炉建物燃料取替階ブローアウトパネル閉止装置の動作状態の確認	<p>・設備の相違</p> <p>【柏崎6/7】</p> <p>島根2号炉は、試験検査について記載</p>
原子炉の状態	項目	内容																			
運転中又は停止中	外観検査	表面劣化状態の外観確認																			
停止中	機能・性能検査	スライド扉の動作状態の確認																			
発電用原子炉の状態	項目	内容																			
運転中又は停止中	外観検査	原子炉建物燃料取替階ブローアウトパネル閉止装置の外観の確認																			
停止中	機能・性能試験	原子炉建物燃料取替階ブローアウトパネル閉止装置の動作状態の確認																			

柏崎刈羽原子力発電所 6 / 7号炉 (2017. 12. 20 版)	東海第二発電所 (2018. 9. 18 版)	島根原子力発電所 2号炉	備考																
	<p>○ <u>中央制御室待避室差圧計の試験検査</u>について <u>中央制御室待避室差圧計</u>は、原子炉の運転中又は停止中に第59-5-6表に示す試験検査が可能な設計とする。</p> <p>第3.16-6表 <u>中央制御室待避室差圧計の試験検査</u></p> <table border="1" data-bbox="952 436 1715 594"> <thead> <tr> <th>原子炉の状態</th> <th>項目</th> <th>内容</th> </tr> </thead> <tbody> <tr> <td rowspan="2">運転中又は停止中</td> <td>外観検査</td> <td>外観の確認</td> </tr> <tr> <td>機能・性能検査</td> <td>計器校正</td> </tr> </tbody> </table>	原子炉の状態	項目	内容	運転中又は停止中	外観検査	外観の確認	機能・性能検査	計器校正	<p>○ <u>差圧計の試験検査</u>について <u>差圧計</u>は、原子炉の運転中又は停止中に表59-5-10に示す試験検査が可能な設計とする。</p> <p>表3.16-10 <u>差圧計の試験検査</u></p> <table border="1" data-bbox="1745 436 2496 594"> <thead> <tr> <th>発電用原子炉の状態</th> <th>項目</th> <th>内容</th> </tr> </thead> <tbody> <tr> <td rowspan="2">運転中又は停止中</td> <td>機能・性能試験</td> <td>差圧計単体の点検・校正 正圧化機能確認時の性能検査</td> </tr> <tr> <td>外観確認</td> <td>機器表面状態の外観の確認</td> </tr> </tbody> </table>	発電用原子炉の状態	項目	内容	運転中又は停止中	機能・性能試験	差圧計単体の点検・校正 正圧化機能確認時の性能検査	外観確認	機器表面状態の外観の確認	<p>・設備の相違 【柏崎 6/7】 島根 2号炉は、試験検査について記載</p>
原子炉の状態	項目	内容																	
運転中又は停止中	外観検査	外観の確認																	
	機能・性能検査	計器校正																	
発電用原子炉の状態	項目	内容																	
運転中又は停止中	機能・性能試験	差圧計単体の点検・校正 正圧化機能確認時の性能検査																	
	外観確認	機器表面状態の外観の確認																	

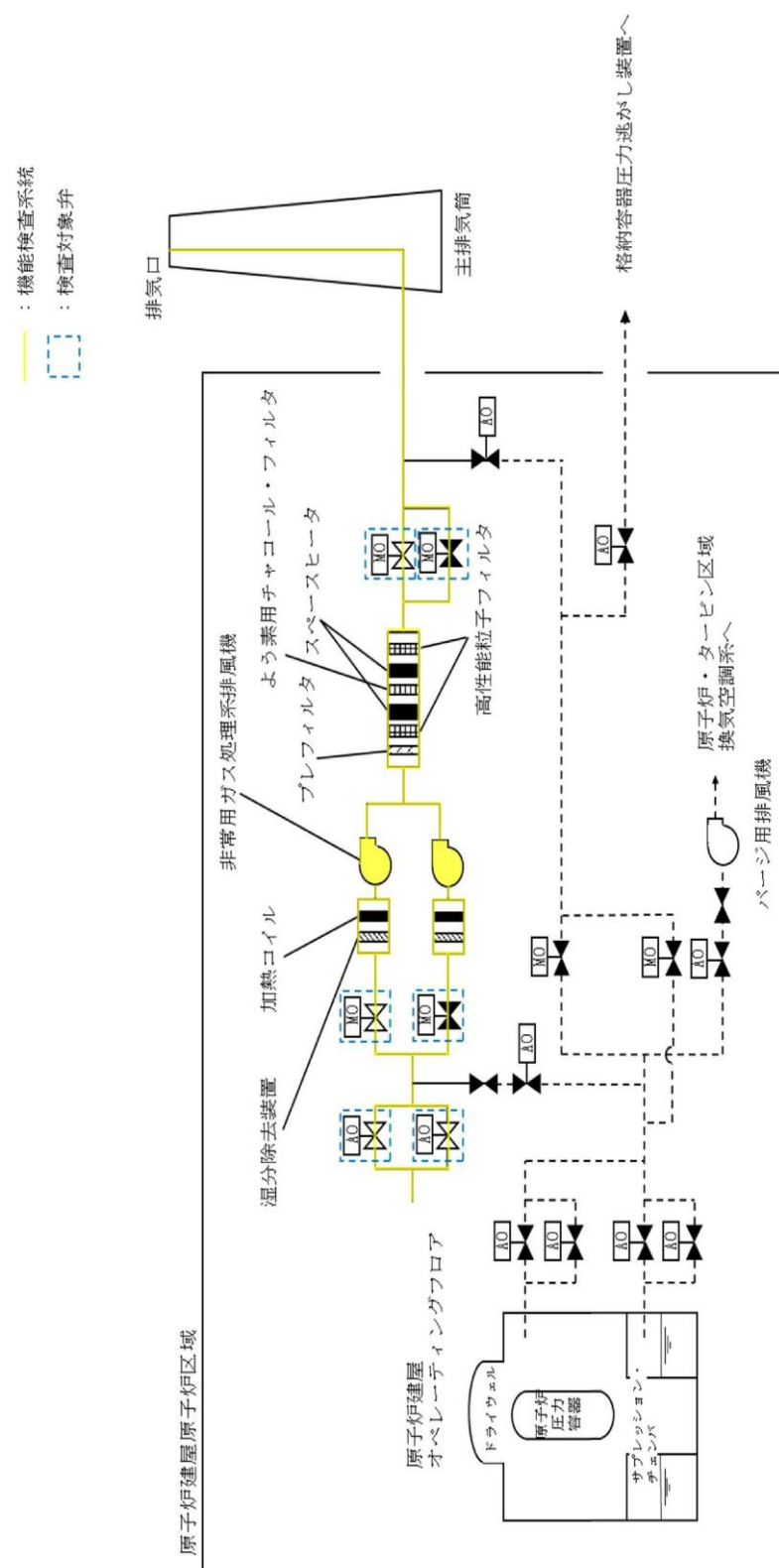
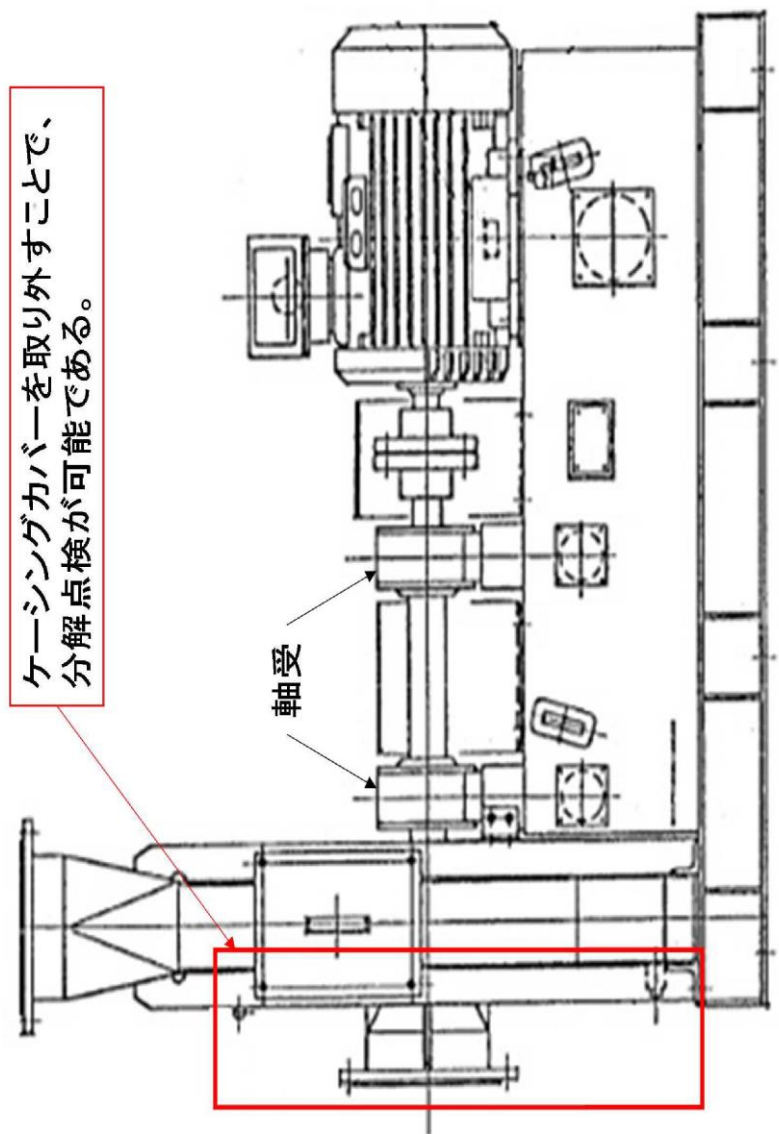
実線・・設備運用又は体制等の相違 (設計方針の相違)
 波線・・記載表現、設備名称の相違 (実質的な相違なし)

まとめ資料比較表 [59 条 補足説明資料 59-6 容量設定根拠]

柏崎刈羽原子力発電所 6 / 7 号炉 (2017. 12. 20 版)	東海第二発電所 (2018. 9. 18 版)	島根原子力発電所 2 号炉	備考
<p style="text-align: center;">59-6 容量設定根拠</p>	<p style="text-align: center;">59-6 容量設定根拠</p>	<p style="text-align: center;">59-6 容量設定根拠</p>	

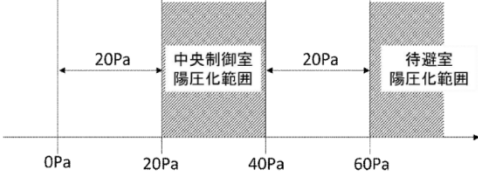
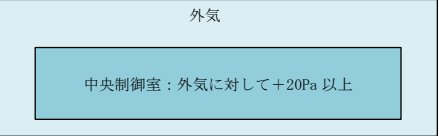
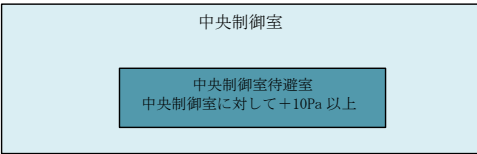
柏崎刈羽原子力発電所 6 / 7号炉 (2017. 12. 20版)	東海第二発電所 (2018. 9. 18版)	島根原子力発電所 2号炉	備考																											
<table border="1" data-bbox="160 254 914 457"> <thead> <tr> <th colspan="2">名称</th> <th>中央制御室及び中央制御室待避室の陽圧化差圧</th> </tr> </thead> <tbody> <tr> <td>中央制御室／隣接区画の陽圧化差圧</td> <td>Pa</td> <td>20～40</td> </tr> <tr> <td>中央制御室待避室／隣接区画の陽圧化差圧</td> <td>Pa</td> <td>60以上</td> </tr> <tr> <td colspan="2">機器仕様に関する注記</td> <td>—</td> </tr> </tbody> </table> <p data-bbox="189 478 902 590">【設定根拠】 中央制御室及び中央制御室待避室陽圧化バウンダリは、配置上、動圧の影響を直接受けない屋内に設置されているため、室内へのインリークは隣接区画との温度差によるものと考えられる。</p> <p data-bbox="189 596 902 716">低温及び高温の設計基準については、観測記録（気象庁アメダス）年超過確率評価を踏まえ最低気温が最も小さく、及び最高気温が最も大きくなる値を設計基準として定めた。評価の結果、統計的な処理による年超過確率 10^{-4} の値として最低気温は -15.2°C、及び最高気温は 38.8°C となった。</p> <p data-bbox="189 722 902 869">中央制御室及び中央制御室待避室陽圧化バウンダリの設計に際しては、重大事故等時の室内の温度を中央制御室のあるコントロール建屋の設計最高温度 40°C、隣接区画を年超過確率 10^{-4} の値よりも厳しい最低温度 -17.0°C と仮定すると、中央制御室及び中央制御室待避室の階層高さは最大 6m であるため、以下のとおり約 15Pa の圧力差があれば、温度の影響を無視できると考えられる。</p> $\Delta P = \{(-17^{\circ}\text{Cの乾き空気密度}) - (+40^{\circ}\text{Cの乾き空気密度})\} \times \text{階層高さ}$ $= (1.378 - 1.127) \times 6$ $= 1.506 \text{ kg/m}^3 (\approx 15\text{Pa})$ <p data-bbox="189 968 902 1024">このため、陽圧化バウンダリの必要差圧は設計裕度を考慮して隣接区画 $+20\text{Pa}$ とする。</p> <p data-bbox="189 1031 902 1150">また、中央制御室は隣接区画からのインリークを防止し、中央制御室待避室は中央制御室及び隣接区画からのインリークを防止する設計とし、中央制御室及び中央制御室待避室の陽圧化バウンダリの設計差圧は図 59-6-1 のように、中央制御室を 20Pa 以上 40Pa 未満、中央制御室待避室を 60Pa 以上とする。</p>  <p data-bbox="284 1331 783 1356">図 59-6-1 中央制御室及び中央制御室待避室 陽圧化圧力</p>	名称		中央制御室及び中央制御室待避室の陽圧化差圧	中央制御室／隣接区画の陽圧化差圧	Pa	20～40	中央制御室待避室／隣接区画の陽圧化差圧	Pa	60以上	機器仕様に関する注記		—	<table border="1" data-bbox="949 254 1703 352"> <thead> <tr> <th colspan="2">名称</th> <th>中央制御室待避室</th> </tr> </thead> <tbody> <tr> <td>正圧化差圧</td> <td>Pa [gage]</td> <td>10</td> </tr> </tbody> </table> <p data-bbox="967 365 1703 390">【設定根拠】</p> <p data-bbox="967 417 1703 537">中央制御室待避室は、配置上、風の影響を受けない屋内に設置されるため、中央制御室待避室へのインリークは、隣接区画（中央制御室）との温度差で生じる圧力差によるものと考えられる。</p> <p data-bbox="967 564 1703 831">重大事故等時の中央制御室待避室内温度を 48.9°C（中央制御室の設計最高温度）、隣接区画（中央制御室）の温度を -12.7°C（外気の設計最低温度）とする。中央制御室待避室の天井高さは約 2m であるため、以下のとおり、5.1Pa [gage] の圧力差があれば、温度の影響を無視できると考えられる。したがって、中央制御室待避室の加圧目標は、余裕を考慮して隣接区画より $+10\text{Pa}$ [gage] とする。</p> $\Delta P = \{(-12.7^{\circ}\text{Cの乾き空気密度}) [\text{kg/m}^3]$ $- (48.9^{\circ}\text{Cの乾き空気密度}) [\text{kg/m}^3]\} \times (\text{天井高さ}) [\text{m}]$ $= \{1.3555 [\text{kg/m}^3] - 1.0963 [\text{kg/m}^3]\} \times 2 [\text{m}]$ $= 0.5184 [\text{kg/m}^2]$ $\rightarrow 0.5184 [\text{kg/m}^2] \times 9.80665 [\text{m/s}^2]$ $\approx 5.1 [\text{Pa [gage]]}$	名称		中央制御室待避室	正圧化差圧	Pa [gage]	10	<table border="1" data-bbox="1742 254 2502 457"> <thead> <tr> <th colspan="2">名称</th> <th>中央制御室及び中央制御室待避室の正圧化差圧</th> </tr> </thead> <tbody> <tr> <td>中央制御室／隣接区画の正圧化差圧</td> <td>Pa</td> <td>20</td> </tr> <tr> <td>中央制御室待避室／隣接区画の正圧化差圧</td> <td>Pa</td> <td>10</td> </tr> </tbody> </table> <p data-bbox="1760 464 2490 554">【設定根拠】 中央制御室及び中央制御室待避室正圧化バウンダリは、配置上、動圧の影響を直接受けない屋内に設置されているため、室内へのインリークは隣接区画との温度差によるものと考えられる。</p> <p data-bbox="1760 569 2490 701">1. 中央制御室 重大事故等時の室内の温度を中央制御室のある制御室建物の設計最高温度 40°C、中央制御室バウンダリ外である隣接区画の外気の設計最低温度 -8.7°C と仮定すると、中央制御室の階層高さは最大 5.2m であるため、以下のとおり約 11Pa の圧力差があれば、温度の影響を無視できると考えられる。</p> $\Delta P = \{(-8.7^{\circ}\text{Cの乾き空気密度}) - (+40^{\circ}\text{Cの乾き空気密度})\} \times \text{階層高さ}$ $= (1.335 - 1.127) \times 5.2$ $= 1.082 \text{ kg/m}^3 (\approx 11\text{Pa})$ <p data-bbox="1760 831 2490 888">このため、中央制御室正圧化バウンダリの設計差圧は設計裕度を考慮して図 59-6-1 のように、外気に対して $+20\text{Pa}$ 以上とする。</p>  <p data-bbox="2012 1052 2273 1077">図 59-6-1 中央制御室 正圧化圧力</p> <p data-bbox="1760 1094 2490 1226">2. 中央制御室待避室 重大事故等時の中央制御室待避室内の温度を中央制御室のある制御室建物の設計最高温度 40°C、隣接区画を外気の外気の設計最低温度 -8.7°C と仮定すると、中央制御室待避室の階層高さは最大約 2.5m であるため、以下のとおり約 6Pa の圧力差があれば、温度の影響を無視できると考えられる。</p> $\Delta P = \{(-8.7^{\circ}\text{Cの乾き空気密度}) - (+40^{\circ}\text{Cの乾き空気密度})\} \times \text{階層高さ}$ $= (1.335 - 1.127) \times 2.5$ $= 0.52 \text{ kg/m}^3 (\approx 6\text{Pa})$ <p data-bbox="1760 1356 2490 1413">このため、中央制御室待避室の正圧化バウンダリの設計差圧は設計裕度を考慮して図 59-6-2 のように、中央制御室に対して $+10\text{Pa}$ 以上とする。</p>  <p data-bbox="1967 1612 2288 1638">図 59-6-2 中央制御室待避室 正圧化圧力</p>	名称		中央制御室及び中央制御室待避室の正圧化差圧	中央制御室／隣接区画の正圧化差圧	Pa	20	中央制御室待避室／隣接区画の正圧化差圧	Pa	10	<p data-bbox="2534 254 2807 373">・設備及び運用の相違 【東海第二】 ①の相違</p>
名称		中央制御室及び中央制御室待避室の陽圧化差圧																												
中央制御室／隣接区画の陽圧化差圧	Pa	20～40																												
中央制御室待避室／隣接区画の陽圧化差圧	Pa	60以上																												
機器仕様に関する注記		—																												
名称		中央制御室待避室																												
正圧化差圧	Pa [gage]	10																												
名称		中央制御室及び中央制御室待避室の正圧化差圧																												
中央制御室／隣接区画の正圧化差圧	Pa	20																												
中央制御室待避室／隣接区画の正圧化差圧	Pa	10																												

柏崎刈羽原子力発電所 6 / 7号炉 (2017. 12. 20 版)	東海第二発電所 (2018. 9. 18 版)	島根原子力発電所 2号炉	備考																																	
<table border="1" data-bbox="160 256 914 499"> <tr> <td colspan="2">名称</td> <td>可搬型陽圧化空調機 (プロフユニット)</td> </tr> <tr> <td>台数</td> <td>台</td> <td>4 (予備2) (6号炉及び7号炉共用)</td> </tr> <tr> <td>容量</td> <td>m³/h/台</td> <td>1,125~1,500 (注1), (1,500 (注2))</td> </tr> <tr> <td colspan="2">機器仕様に関する注記</td> <td>注1: 要求値を示す 注2: 公称値を示す</td> </tr> </table> <p data-bbox="189 520 296 546">【設定根拠】</p> <p data-bbox="189 550 296 575">必要換気量</p> <p data-bbox="219 579 593 604">①二酸化炭素濃度基準に基づく必要換気量</p> <ul data-bbox="249 609 914 911" style="list-style-type: none"> ・収容人数: n=20名 ・許容二酸化炭素濃度: C=0.5% (労働安全衛生規則) ・大気二酸化炭素濃度: C₀=0.039% (標準大気二酸化炭素濃度) ・呼吸による二酸化炭素発生量: M=0.022m³/h/人 (空気調和・衛生工学便覧の極軽作業の作業程度の吐出し量) ・必要換気量: Q₁=100×M×n / (C-C₀) m³/h (空気調和・衛生工学便覧の二酸化炭素基準の必要換気量) $Q_1 = 100 \times 0.022 \times 20 \div (0.5 - 0.039) = 95.45 \approx 95.5 \text{ m}^3/\text{h}$ <p data-bbox="219 919 534 945">②酸素濃度基準に基づく必要換気量</p> <ul data-bbox="249 949 914 1251" style="list-style-type: none"> ・収容人数: n=20名 ・吸気酸素濃度: a=20.95% (標準大気酸素濃度) ・許容酸素濃度: b=18% (労働安全衛生規則) ・成人の呼吸量: c=0.48m³/h/人 (空気調和・衛生工学便覧) ・乾燥空気換算酸素濃度: d=16.4% (空気調和・衛生工学便覧) ・必要換気量: Q₁=c×(a-d)×n / (a-b) m³/h (空気調和・衛生工学便覧の酸素基準の必要換気量) $Q_1 = 0.48 \times (20.95 - 16.4) \times 20 \div (20.95 - 18.0) = 14.81 \approx 14.9 \text{ m}^3/\text{h}$	名称		可搬型陽圧化空調機 (プロフユニット)	台数	台	4 (予備2) (6号炉及び7号炉共用)	容量	m ³ /h/台	1,125~1,500 (注1), (1,500 (注2))	機器仕様に関する注記		注1: 要求値を示す 注2: 公称値を示す	<table border="1" data-bbox="961 264 1694 453"> <tr> <td colspan="2">名称</td> <td>フィルタ系ファン</td> </tr> <tr> <td>容量</td> <td>m³/h/個</td> <td>5,100 以上</td> </tr> <tr> <td>原動機出力</td> <td>kW/個</td> <td>7.5</td> </tr> <tr> <td>個数</td> <td>-</td> <td>2</td> </tr> </table> <p data-bbox="991 470 1098 495">【設定根拠】</p> <p data-bbox="991 512 1068 537">(概要)</p> <ul data-bbox="991 562 1694 1423" style="list-style-type: none"> ・設計基準対象施設 <p data-bbox="991 604 1694 772">中央制御室換気系フィルタ系ファンは、設計基準対象施設として中央制御室内空気を高性能粒子フィルタ及びチャコールフィルタを内蔵した中央制御室換気系フィルタユニットに通し、空気中の微粒子及び放射性ヨウ素を除去低減するために設置する。</p> ・重大事故等対処設備 <p data-bbox="991 890 1694 957">重大事故等時に、放射線管理施設のうち換気設備として使用する中央制御室換気系フィルタ系ファンは、以下の機能を有する。</p> <p data-bbox="991 982 1694 1050">中央制御室換気系フィルタ系ファンは、重大事故が発生した場合においても運転員が中央制御室にとどまるために設置する。</p> <p data-bbox="991 1075 1694 1285">系統構成は、高性能粒子フィルタ及びチャコールフィルタを内蔵した中央制御室換気系フィルタユニット並びに中央制御室換気系フィルタ系ファンからなる非常用ラインを設け、外気との連絡口を遮断し、中央制御室換気系フィルタユニットを通る閉回路循環方式とし、運転員を過度の放射線被ばくから防護する設計とする。</p> <p data-bbox="991 1310 1694 1423">また、外部との遮断が長期にわたり、室内の雰囲気が悪くなった場合には、外気を中央制御室換気系フィルタユニットで浄化しながら取り入れることも可能な設計とする。</p> 	名称		フィルタ系ファン	容量	m ³ /h/個	5,100 以上	原動機出力	kW/個	7.5	個数	-	2	<table border="1" data-bbox="1742 264 2499 558"> <tr> <td colspan="2">名称</td> <td>中央制御室換気系 (再循環用ファン、チャコール・フィルタ・プースタ・ファン)</td> </tr> <tr> <td>台数</td> <td>台</td> <td>1 (予備1)</td> </tr> <tr> <td>容量</td> <td>m³/h/台</td> <td>17,500 以上 (再循環用ファン: 120,000, チャコール・フィルタ・プースタ・ファン: 32,000)</td> </tr> </table> <p data-bbox="1771 575 1908 600">【設定根拠】</p> <p data-bbox="1771 617 1878 642">1. 必要換気量</p> <p data-bbox="1801 659 2116 684">①二酸化炭素濃度基準に基づく必要換気量</p> <ul data-bbox="1831 688 2499 1041" style="list-style-type: none"> ・収容人数: n=10名 ・許容二酸化炭素濃度: C=0.5% (JEAC4622-2009) ・大気二酸化炭素濃度: C₀=0.03% (空気調和・衛生工学便覧) ・呼吸による二酸化炭素発生量: M=0.022m³/h/人 (空気調和・衛生工学便覧の極軽作業の作業程度の吐出し量) ・必要換気量: Q₁=100×M×n / (C-C₀) m³/h (空気調和・衛生工学便覧の二酸化炭素基準の必要換気量) $Q_1 = 100 \times 0.022 \times 10 \div (0.5 - 0.03) = 46.81 \approx 46.9 \text{ m}^3/\text{h}$ <p data-bbox="1801 1100 2086 1125">②酸素濃度基準に基づく必要換気量</p> <ul data-bbox="1831 1142 2499 1495" style="list-style-type: none"> ・収容人数: n=10名 ・吸気酸素濃度: a=20.95% (空気調和・衛生工学便覧) ・許容酸素濃度: b=18% (労働安全衛生法酸素欠乏症等防止規則) ・成人の呼吸量: c=0.48m³/h/人 (空気調和・衛生工学便覧) ・乾燥空気換算酸素濃度: d=16.4% (空気調和・衛生工学便覧) ・必要換気量: Q₁=c×(a-d)×n / (a-b) m³/h (空気調和・衛生工学便覧の酸素基準の必要換気量) $Q_1 = 0.48 \times (20.95 - 16.4) \times 10 \div (20.95 - 18.0) = 7.40 \approx 7.5 \text{ m}^3/\text{h}$	名称		中央制御室換気系 (再循環用ファン、チャコール・フィルタ・プースタ・ファン)	台数	台	1 (予備1)	容量	m ³ /h/台	17,500 以上 (再循環用ファン: 120,000, チャコール・フィルタ・プースタ・ファン: 32,000)	<p data-bbox="2546 260 2801 378">・設備及び運用の相違 【東海第二】 ①の相違</p>
名称		可搬型陽圧化空調機 (プロフユニット)																																		
台数	台	4 (予備2) (6号炉及び7号炉共用)																																		
容量	m ³ /h/台	1,125~1,500 (注1), (1,500 (注2))																																		
機器仕様に関する注記		注1: 要求値を示す 注2: 公称値を示す																																		
名称		フィルタ系ファン																																		
容量	m ³ /h/個	5,100 以上																																		
原動機出力	kW/個	7.5																																		
個数	-	2																																		
名称		中央制御室換気系 (再循環用ファン、チャコール・フィルタ・プースタ・ファン)																																		
台数	台	1 (予備1)																																		
容量	m ³ /h/台	17,500 以上 (再循環用ファン: 120,000, チャコール・フィルタ・プースタ・ファン: 32,000)																																		

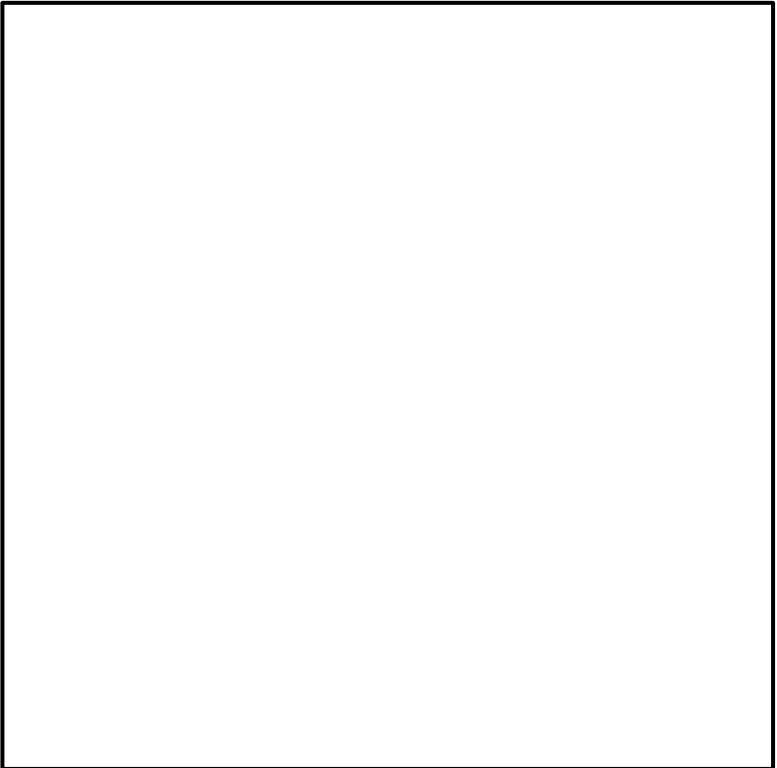
柏崎刈羽原子力発電所 6 / 7号炉 (2017. 12. 20版)	東海第二発電所 (2018. 9. 18版)	島根原子力発電所 2号炉	備考
<p>【設定根拠】 (続)</p> <p>③正圧化に必要な空気供給量 中央制御室を陽圧化するために必要な空気供給量は、JIS A 2201 に基づく気密性能試験から測定し決定する。 試験結果を図 59-6-2 に示す。3 台の測定結果から求まる回帰曲線（通気特性式）より、中央制御室内を隣接区画（20Pa 以上 140Pa 未満）の範囲内で陽圧化する必要風量は <input type="text"/> 未満となる。よって、必要な空気供給量は上記風量に設計裕度をもった 4,500～6,000m³/h（6 号炉側から 1,125～1,500m³/h/台×2 台、7 号炉側から 1,125～1,500m³/h/台×2 台）とする。</p>  <p>図 59-6-2 中央制御室の気密性能試験結果</p> <p>以上より、「③正圧化に必要な空気供給量」を確保することで、「①二酸化炭素濃度基準に基づく必要換気量」「酸素濃度基準に基づく必要換気量」を満足することから、必要換気量は 4,500～6,000m³/h（6 号炉側から 1,125～1,500m³/h/台×2 台、7 号炉側から 1,125～1,500m³/h/台×2 台）とする。</p>	<p>1. 容量の設定根拠</p> <p>設計基準対象施設として使用する中央制御室換気系フィルタ系ファンの容量は、必要に応じてチャコールフィルタを通して外気を取り入、再循環した場合でも、中央制御室にとどまる放射線業務従事者が受ける線量が線量限度 100 nSv を下回ることができる容量とする。</p> <p>中央制御室換気系フィルタ系ファンは容量 5,100 m³/h において、放射線業務従事者が受ける線量限度 100nSv を下回ることが可能となるため、中央制御室換気系フィルタ系ファンの容量は、5,100 m³/h/個以上とする。</p> <p>中央制御室換気系フィルタ系ファンを重大事故等時において使用する場合は、設計基準対象施設と同様の使用方法であるため、設計基準対象施設と同仕様で設計し、5,100 m³/h/個以上とする。</p> <p>公称値については要求される容量と同仕様として5,100 m³/h/個とする。</p> <p>2. 原動機出力の設定根拠</p> <p>設計基準対象施設として使用する中央制御室換気系フィルタ系ファンの原動機出力は、風量は 5,100 m³/h 時の軸動力を基に設定する。</p> <p>定格風量点における中央制御室換気系フィルタ系ファンの風量は 5,100 m³/h であり、その時の同ファンの必要軸動力は、以下のとおり <input type="text"/> kW となる。</p>	<p>【設定根拠】(続き)</p> <p>③正圧化に必要な空気供給量 中央制御室を正圧化するために必要な空気供給量は、中央制御室空調換気系差圧試験から測定し決定する。また、大気間差圧は、大気圧基準点と中央制御室バウンダリ内各測定点での気圧を気圧計にて同時測定を行った。計測値は、大気圧基準点高さに補正算出した。 試験結果を図 59-6-3 に示す。中央制御室内を外気より+20Pa 以上で正圧化する必要風量は <input type="text"/> m³/h 以上となる。よって、必要な空気供給量は上記風量に設計裕度をもった 17,500m³/h とする。</p>  <p>図 59-6-3 中央制御室の気密性能試験結果</p> <p>以上より、「③正圧化に必要な空気供給量」を確保することで、「①二酸化炭素濃度基準に基づく必要換気量」「酸素濃度基準に基づく必要換気量」を満足することから、必要換気量は 17,500 m³/h とする。</p>	<p>・設備及び運用の相違 【東海第二】 ①の相違</p>

柏崎刈羽原子力発電所 6 / 7号炉 (2017. 12. 20 版)	東海第二発電所 (2018. 9. 18 版)	島根原子力発電所 2号炉	備考
	$L = \frac{L_T}{\eta_T / 100} = \frac{\frac{\kappa}{\kappa - 1} \cdot \frac{P_{T1}}{6 \times 10^4} \cdot Q_1 \cdot \left\{ \left(\frac{P_{T2}}{P_{T1}} \right)^{\frac{\kappa - 1}{\kappa}} - 1 \right\}}{\eta_T / 100} \dots \dots \frac{P_{S2}}{P_{S1}} > 1.03 \text{ のとき}$ $= \frac{Q_1}{6 \times 10^4} \cdot \{(P_{S2} - P_{S1}) + (p_{d2} - p_{d1})\} \dots \dots \frac{P_{S2}}{P_{S1}} \leq 1.03 \text{ のとき}$ <p>(引用文献：日本工業規格 J I S B 8 3 3 0 (2000)「送風機の試験及び検査方法」)</p> <p>L : 軸動力 (kW) L_T : 全圧空気動力 (kW) κ : 比熱比 Q₁ : 吸込空気量 (m³/min) P_{T2} : 吐出し口送風機絶対全圧 (Pa[abs]) P_{T1} : 吸込口送風機絶対全圧 (Pa[abs]) P_{S2} : 吐出し口送風機絶対静圧 (Pa[abs]) P_{S1} : 吸込口送風機絶対静圧 (Pa[abs]) p_{d2} : 吐出し口動圧 (Pa) p_{d1} : 吸込口動圧 (Pa) η_T : 全圧効率 (%)</p> $\frac{P_{S2}}{P_{S1}} = \frac{\square}{\square} = 1.020 \leq \square \text{ 上り}$ $L = \frac{\left(\frac{5100}{60} \right) \times \left(\frac{\square}{\square} - \frac{\square}{\square} \right) + \frac{\square}{\square}}{\square \cdot 100} = \square = \square \text{ kW}$ <p>以上より，中央制御室換気系フィルタ系ファンの原動機出力は，必要軸動力 \square kWを上回る7.5kW個とする。</p>		<p>・設備及び運用の相違 【東海第二】 ①の相違</p>

柏崎刈羽原子力発電所 6 / 7号炉 (2017. 12. 20 版)	東海第二発電所 (2018. 9. 18 版)	島根原子力発電所 2号炉	備考
	<p>3. 個数の設定根拠</p> <p>中央制御室換気系フィルタ系ファンは、設計基準対象施設として中央制御室内空気を高性能粒子フィルタ及びチャコールフィルタを内蔵した中央制御室換気系フィルタに通し、空気中の微粒子及び放射性よう素を除去低減するために各系列に1個設置し、合計2個設置する。</p> <p>中央制御室換気系フィルタ系ファンは、重大事故が発生した場合においても運転員が中央制御室にとどまるため、設計基準対象施設として各系列に1個設置し、合計2個設置しているものを重大事故等対処設備として使用する。</p>		<p>・設備及び運用の相違</p> <p>【東海第二】</p> <p>①の相違</p>

柏崎刈羽原子力発電所 6/7号炉 (2017.12.20版)	東海第二発電所 (2018.9.18版)	島根原子力発電所 2号炉	備考																																										
<table border="1" data-bbox="154 268 920 472"> <tr> <td colspan="2">名称</td> <td>中央制御室待避室揚圧化装置 (空気ポンプ)</td> </tr> <tr> <td>本数</td> <td>本</td> <td>174以上 (注1), (194 (注2))</td> </tr> <tr> <td>容量</td> <td>L/本</td> <td>47 (6号炉及び7号炉共用)</td> </tr> <tr> <td>充填圧力</td> <td>MPa</td> <td>約15 (35℃)</td> </tr> <tr> <td colspan="2">機器仕様に関する注記</td> <td>注1: 要求値を示す 注2: 公称値を示す</td> </tr> </table> <p data-bbox="192 493 911 1344"> 【設定根拠】 (1) 必要換気量 ① 二酸化炭素濃度基準に基づく必要換気量 ・収容人数: n=20名 ・許容二酸化炭素濃度: C=0.5% (労働安全衛生規則) ・大気二酸化炭素濃度: C₀=0.039% (標準大気二酸化炭素濃度) ・呼吸による二酸化炭素発生量: M=0.022m³/h/人 (空気調和・衛生工学便覧の極軽作業の作業程度の吐出量) ・必要換気量: Q₁=100×M×n / (C-C₀) m³/h (空気調和・衛生工学便覧の二酸化炭素基準の必要換気量) Q₁=100×0.022×20 / (0.5-0.039) =95.45 ≒95.5m³/h ② 酸素濃度基準に基づく必要換気量 ・収容人数: n=20名 ・吸気酸素濃度: a=20.95% (標準大気酸素濃度) ・許容酸素濃度: b=18% (労働安全衛生規則) ・成人の呼吸量: c=0.48m³/h/人 (空気調和・衛生工学便覧) ・乾燥空気換算酸素濃度: d=16.4% (空気調和・衛生工学便覧) ・必要換気量: Q₁=c / (a-d) × n / (a-b) m³/h (空気調和・衛生工学便覧の酸素基準の必要換気量) Q₁=0.48 / (20.95-16.4) × 20 / (20.95-18.0) =14.81 ≒14.9m³/h 以上より、空気ポンペ陽圧化時に、窒息を防止するために必要な換気量は二酸化炭素濃度基準の95.5m³/h以上とする。 </p>	名称		中央制御室待避室揚圧化装置 (空気ポンプ)	本数	本	174以上 (注1), (194 (注2))	容量	L/本	47 (6号炉及び7号炉共用)	充填圧力	MPa	約15 (35℃)	機器仕様に関する注記		注1: 要求値を示す 注2: 公称値を示す	<table border="1" data-bbox="949 268 1715 514"> <tr> <td colspan="2">名称</td> <td>中央制御室待避室空気ポンプユニット (空気ポンプ)</td> </tr> <tr> <td>本数</td> <td>本</td> <td>13以上</td> </tr> <tr> <td>容量</td> <td>L</td> <td>約47 (1本当たり)</td> </tr> <tr> <td>充填圧力</td> <td>MPa [gage]</td> <td>約15 (35℃)</td> </tr> </table> <p data-bbox="964 525 1700 1344"> 【設定根拠】 1. 中央制御室待避室の必要空気供給量 (1) 二酸化炭素濃度基準に基づく必要換気量 a. 収容人数: n=3名 b. 許容二酸化炭素濃度: C=0.5% (J E A C 4622-2009) c. 大気二酸化炭素濃度: C₀=0.0336% (空気ポンプの二酸化炭素濃度) d. 呼吸による二酸化炭素発生量: M=0.022m³/h/人 (「空気調和・衛生工学便覧」の極軽作業の作業程度の吐出量) e. 必要換気量: Q₁=100×M×n / (C-C₀) m³/h (「空気調和・衛生工学便覧」の二酸化炭素基準の必要換気量) Q₁=100×0.022×3 / (0.5-0.0336) =14.15 ≒14.2m³/h (2) 酸素濃度基準に基づく必要換気量 a. 収容人数: n=3名 b. 吸気酸素濃度: a=20.95% (標準大気酸素濃度) c. 許容酸素濃度: b=19% (「鉱山保安法施行規則」) d. 成人の呼吸量: c=0.48m³/h/人 (「空気調和・衛生工学便覧」) e. 乾燥空気換算酸素濃度: d=16.4% (「空気調和・衛生工学便覧」) </p>	名称		中央制御室待避室空気ポンプユニット (空気ポンプ)	本数	本	13以上	容量	L	約47 (1本当たり)	充填圧力	MPa [gage]	約15 (35℃)	<table border="1" data-bbox="1745 268 2504 535"> <tr> <td colspan="2">名称</td> <td>中央制御室待避室正圧化装置 (空気ポンプ)</td> </tr> <tr> <td>本数</td> <td>本</td> <td>15以上 (注1), (50 (注2))</td> </tr> <tr> <td>容量</td> <td>L/本</td> <td>50.0</td> </tr> <tr> <td>充填圧力</td> <td>MPa</td> <td>約20 (35℃)</td> </tr> <tr> <td colspan="2">機器仕様に関する注意</td> <td>注1: 要求値を示す 注2: 公称値を示す</td> </tr> </table> <p data-bbox="1760 546 2502 1686"> 【設定根拠】 (1) 必要換気量 ① 二酸化炭素濃度基準に基づく必要換気量 ・収容人数: n=5名 ・許容二酸化炭素濃度: C=1.0%* (鉱山保安法施行規則) ・大気二酸化炭素濃度 (空気ポンプの二酸化炭素濃度): C₀=0.03% (空気調和・衛生工学便覧) ・呼吸による二酸化炭素発生量: M=0.022m³/h/人 (空気調和・衛生工学便覧の極軽作業の作業程度の吐出量) ・必要換気量: Q₁=100×M×n / (C-C₀) m³/h (空気調和・衛生工学便覧の二酸化炭素基準の必要換気量) Q₁=100×0.022×5 / (1.0-0.03) =11.35 ≒11.4m³/h ② 酸素濃度基準に基づく必要換気量 ・収容人数: n=5名 ・吸気酸素濃度: a=20.95% (空気調和・衛生工学便覧) ・許容酸素濃度: b=19%* (鉱山保安法施行規則) ・成人の呼吸量: c=0.48m³/h/人 (空気調和・衛生工学便覧) ・乾燥空気換算酸素濃度: d=16.4% (空気調和・衛生工学便覧) ・必要換気量: Q₁=c / (a-d) × n / (a-b) m³/h (空気調和・衛生工学便覧の酸素基準の必要換気量) Q₁=0.48 / (20.95-16.4) × 5 / (20.95-19.0) =5.6 ≒5.6m³/h 以上より、空気ポンペ正圧化時に、窒息を防止するために必要な換気量は二酸化炭素濃度基準の11.4m³/h以上とする。 </p>	名称		中央制御室待避室正圧化装置 (空気ポンプ)	本数	本	15以上 (注1), (50 (注2))	容量	L/本	50.0	充填圧力	MPa	約20 (35℃)	機器仕様に関する注意		注1: 要求値を示す 注2: 公称値を示す	<p data-bbox="2537 304 2804 514"> ・設備の相違 【柏崎6/7, 東海第二】 島根2号炉は居住性を確保できる圧力・容量・本数のポンペを配備 </p> <p data-bbox="2537 703 2804 955"> ・設計方針の相違 【柏崎6/7, 東海第二】 島根2号炉は、鉱山保安法施行規則に定める許容二酸化炭素濃度1.0%を用いて設計 </p>
名称		中央制御室待避室揚圧化装置 (空気ポンプ)																																											
本数	本	174以上 (注1), (194 (注2))																																											
容量	L/本	47 (6号炉及び7号炉共用)																																											
充填圧力	MPa	約15 (35℃)																																											
機器仕様に関する注記		注1: 要求値を示す 注2: 公称値を示す																																											
名称		中央制御室待避室空気ポンプユニット (空気ポンプ)																																											
本数	本	13以上																																											
容量	L	約47 (1本当たり)																																											
充填圧力	MPa [gage]	約15 (35℃)																																											
名称		中央制御室待避室正圧化装置 (空気ポンプ)																																											
本数	本	15以上 (注1), (50 (注2))																																											
容量	L/本	50.0																																											
充填圧力	MPa	約20 (35℃)																																											
機器仕様に関する注意		注1: 要求値を示す 注2: 公称値を示す																																											

柏崎刈羽原子力発電所 6/7号炉 (2017.12.20版)	東海第二発電所 (2018.9.18版)	島根原子力発電所 2号炉	備考
<p>【設定根拠】 (続)</p> <p>(2) 必要ポンペ本数</p> <p>中央制御室待避室を10時間正圧化する必要最低限のポンペ本数は二酸化炭素濃度基準換気量の95.5m³/h及びポンペ供給可能空気量5.50m³/本から下記の通り174本となる。</p> <ul style="list-style-type: none"> ・ポンペ初期充填圧力：14.7MPa (at 35℃) ・ポンペ内容積：46.7L ・圧力調整弁最低制御圧力：0.89MPa ・ポンペ供給可能空気量：5.50m³/本 (at -4℃) <p>以上より、必要ポンペ本数は下記の通り174本以上となる。</p> $95.5\text{m}^3/\text{h} \div 5.50\text{m}^3/\text{本} \times 10\text{時間} = 173.6$ $\approx 174\text{本}$ <p>設備の公称値としては予備を含めて合計で194本を設置する。</p> <p>また、中央制御室待避室においては、上記の95.5m³/hで必要差圧が60Pa以上確保可能な気密性を有する設計とする。</p>	<p>f. 必要換気量：$Q_1 = c \times (a - d) \times n / (a - b) \text{ m}^3/\text{h}$ (「空気調和・衛生工学便覧」の酸素基準の必要換気量)</p> $Q_1 = 0.48 \times (20.95 - 16.4) \times 3 \div (20.95 - 19.0)$ $= 3.36$ $\approx 3.4\text{m}^3/\text{h}$ <p>以上により、中央制御室待避室の使用に必要な空気供給量は、二酸化炭素濃度基準の14.2m³/hとする。また、この流量にて空気を供給し続けることにより、中央制御室待避室を中央制御室に対して正圧に保つことが可能である。</p> <p>2. 中央制御室待避室の必要ポンペ本数</p> <p>中央制御室待避室を5時間正圧化するために必要な最低限のポンペ本数は、二酸化炭素濃度基準換気量の14.2m³/h及びポンペ供給可能空気量5.5m³/本から、下記の通り13本となる。なお、中央制御室待避室の設置後に試験を実施し、必要ポンペ本数が正圧化を5時間維持するのに十分であることを確認し、予備のポンペ容量について決定する。</p> <p>(1) ポンペ初期充填圧力：14.7MPa [gage] (at35℃)</p> <p>(2) ポンペ容器容積：5.5m³ (空気ポンペは、標準圧力14.7MPa [gage]で6.8m³/本であるが、残圧及び使用温度補正により安全側に考慮し、5.5m³/本とした。)</p> $\text{必要ポンペ本数} = 14.2\text{m}^3/\text{h} \div 5.5\text{m}^3/\text{本} \times 5\text{時間}$ $= 12.9\text{本}$ $\approx 13\text{本}$	<p>【設定根拠】 (続き)</p> <p>※ 許容二酸化炭素濃度, 許容酸素濃度</p> <p><u>空気ポンペを使用する場合は、希ガス等の放射性物質を含む外気が侵入しないようにするための防護措置であり、中央制御室待避室が密閉された限られた環境であるため、同様に限られた環境下における労働環境を規定している「鉱山保安法施行規則」に定める許容二酸化炭素濃度1.0%以下、許容酸素濃度19%以上とする。</u></p> <p>(2) 必要ポンペ本数</p> <p>中央制御室待避室を10時間正圧化する必要最低限のポンペ本数は二酸化炭素濃度基準換気量の11.4m³/h及びポンペ供給可能空気量8.0m³/本から下記のとおり15本となる。</p> <ul style="list-style-type: none"> ・ポンペ初期充填圧力：19.6MPa (at 35℃) ・ポンペ内容積：50.0L ・圧力調整弁最低制御圧力：1.0MPa ・ポンペ供給可能空気量：8.0m³/本 (at 0℃) ・待避中ポンペ使用時間：10時間 ・待避前ポンペ使用時間：20分※ <p>※格納容器ベント実施予測時刻の20分前にポンペ使用を開始する。</p> <p>以上より、必要ポンペ本数は下記のとおり15本以上となる。</p> $11.4\text{m}^3/\text{h} \div 8.0\text{m}^3/\text{本} \times 10\text{時間} \times 20\text{分}$ $= 14.7$ $\approx 15\text{本}$ <p>設備の公称値としては予備を含めて合計で50本を設置する。</p> <p>また、中央制御室待避室においては、上記の11.4m³/hで必要差圧が10Pa以上確保可能な気密性を有する設計とする。</p>	<p>・設計方針の相違</p> <p>【柏崎6/7, 東海第二】島根2号炉は、鉱山保安法施行規則に定める許容二酸化炭素濃度1.0%を用いて設計</p>

名称		無線連絡設備 (常設)	
台数	台	6号炉	1
		7号炉	1

【設定根拠】
中央制御室待避室には、炉心の著しい損傷の発生時に陽圧化した中央制御室待避室に待避した場合においても、無線連絡設備 (常設) を設置することで、発電所内の通信連絡をする必要のある場所と通信連絡を行うことができる設計とする。

機能	使用する通信連絡設備									
発電所内 退避の指示	<table border="1" style="width: 100%; border-collapse: collapse;"> <tr> <td style="width: 33%;"> 5号炉原子炉建屋内緊急時対策所 ・送受話器 (ページング) : 2台 ・電力保安通信用電話設備 (固定電話機 : 15台、PHS端末 : 30台) ・衛星電話設備 (常設) : 9台 ・無線連絡設備 (常設) : 4台 </td> <td style="width: 33%;"> 中央制御室 (6号炉)※1 ・送受話器 (ページング) : 21台 ・電力保安通信用電話設備 (固定電話機 : 14台、PHS端末 : 17台) ・衛星電話設備 (常設) : 1台 ・無線連絡設備 (常設) : 1台 </td> <td style="width: 33%;"> 現場 (屋内)※1 ・送受話器 (ページング) ・電力保安通信用電話設備 (固定電話機、PHS端末) ・衛星電話設備 (可搬型) ・無線連絡設備 (可搬型) </td> </tr> <tr> <td colspan="3"> 現場 (屋外) ・送受話器 (ページング) ・電力保安通信用電話設備 (PHS端末) ・衛星電話設備 (可搬型) ・無線連絡設備 (可搬型) </td> </tr> <tr> <td colspan="3"> ○発電所構内設置台数 ・送受話器 : 約346台 ・固定電話機 : 約747台 ・PHS端末 : 約1177台 ・衛星電話設備 (可搬型) : 56台 ・無線連絡設備 (可搬型) : 180台 </td> </tr> </table>	5号炉原子炉建屋内緊急時対策所 ・送受話器 (ページング) : 2台 ・電力保安通信用電話設備 (固定電話機 : 15台、PHS端末 : 30台) ・衛星電話設備 (常設) : 9台 ・無線連絡設備 (常設) : 4台	中央制御室 (6号炉)※1 ・送受話器 (ページング) : 21台 ・電力保安通信用電話設備 (固定電話機 : 14台、PHS端末 : 17台) ・衛星電話設備 (常設) : 1台 ・無線連絡設備 (常設) : 1台	現場 (屋内)※1 ・送受話器 (ページング) ・電力保安通信用電話設備 (固定電話機、PHS端末) ・衛星電話設備 (可搬型) ・無線連絡設備 (可搬型)	現場 (屋外) ・送受話器 (ページング) ・電力保安通信用電話設備 (PHS端末) ・衛星電話設備 (可搬型) ・無線連絡設備 (可搬型)			○発電所構内設置台数 ・送受話器 : 約346台 ・固定電話機 : 約747台 ・PHS端末 : 約1177台 ・衛星電話設備 (可搬型) : 56台 ・無線連絡設備 (可搬型) : 180台		
	5号炉原子炉建屋内緊急時対策所 ・送受話器 (ページング) : 2台 ・電力保安通信用電話設備 (固定電話機 : 15台、PHS端末 : 30台) ・衛星電話設備 (常設) : 9台 ・無線連絡設備 (常設) : 4台	中央制御室 (6号炉)※1 ・送受話器 (ページング) : 21台 ・電力保安通信用電話設備 (固定電話機 : 14台、PHS端末 : 17台) ・衛星電話設備 (常設) : 1台 ・無線連絡設備 (常設) : 1台	現場 (屋内)※1 ・送受話器 (ページング) ・電力保安通信用電話設備 (固定電話機、PHS端末) ・衛星電話設備 (可搬型) ・無線連絡設備 (可搬型)							
	現場 (屋外) ・送受話器 (ページング) ・電力保安通信用電話設備 (PHS端末) ・衛星電話設備 (可搬型) ・無線連絡設備 (可搬型)									
○発電所構内設置台数 ・送受話器 : 約346台 ・固定電話機 : 約747台 ・PHS端末 : 約1177台 ・衛星電話設備 (可搬型) : 56台 ・無線連絡設備 (可搬型) : 180台										
<small>※1 : 原子力発電所、原子炉建屋、タービン建屋等 ※2 : 燃料貯蔵庫、2号炉等、共同設備あり</small>										

*台数については、配備台数を示し、そのうち、詳細は通じて見直しを行う。

図59-6-3 機能毎に必要な通信連絡設備 (発電所内)

名称		無線通信設備 (固定型)	
台数	台	1	

【設定根拠】
中央制御室待避室には、炉心の著しい損傷の発生時に正圧化した中央制御室待避室に待避した場合においても、無線通信設備 (固定型) を設置することで、発電所内の通信連絡をする必要のある場所と通信連絡を行うことができる設計とする。

機能	使用する通信連絡設備				
発電所内 退避の指示	<table border="1" style="width: 100%; border-collapse: collapse;"> <tr> <td style="width: 33%;"> 緊急時対策所 ・所内通信連絡設備 (警報装置を含む。) : 1台 ・電力保安通信用電話設備 (固定電話機 : 10台、PHS端末 : 32台) ・衛星電話設備 (固定型) : 5台 ・無線通信設備 (固定型) : 5台 </td> <td style="width: 33%;"> 現場 (屋外) ・所内通信連絡設備 (警報装置を含む。) : 1台 ・電力保安通信用電話設備 (PHS端末) ・衛星電話設備 (携帯型) ・無線通信設備 (携帯型) </td> </tr> <tr> <td style="width: 33%;"> 中央制御室 ・所内通信連絡設備 (警報装置を含む。) : 14台 ・電力保安通信用電話設備 (固定電話機 : 7台、PHS端末 : 10台) ・衛星電話設備 (固定型) : 2台 ・無線通信設備 (固定型) : 2台 </td> <td style="width: 33%;"> 現場 (屋内)※1 ・所内通信連絡設備 (警報装置を含む。) : 1台 ・電力保安通信用電話設備 (固定電話機、PHS端末) </td> </tr> </table>	緊急時対策所 ・所内通信連絡設備 (警報装置を含む。) : 1台 ・電力保安通信用電話設備 (固定電話機 : 10台、PHS端末 : 32台) ・衛星電話設備 (固定型) : 5台 ・無線通信設備 (固定型) : 5台	現場 (屋外) ・所内通信連絡設備 (警報装置を含む。) : 1台 ・電力保安通信用電話設備 (PHS端末) ・衛星電話設備 (携帯型) ・無線通信設備 (携帯型)	中央制御室 ・所内通信連絡設備 (警報装置を含む。) : 14台 ・電力保安通信用電話設備 (固定電話機 : 7台、PHS端末 : 10台) ・衛星電話設備 (固定型) : 2台 ・無線通信設備 (固定型) : 2台	現場 (屋内)※1 ・所内通信連絡設備 (警報装置を含む。) : 1台 ・電力保安通信用電話設備 (固定電話機、PHS端末)
	緊急時対策所 ・所内通信連絡設備 (警報装置を含む。) : 1台 ・電力保安通信用電話設備 (固定電話機 : 10台、PHS端末 : 32台) ・衛星電話設備 (固定型) : 5台 ・無線通信設備 (固定型) : 5台	現場 (屋外) ・所内通信連絡設備 (警報装置を含む。) : 1台 ・電力保安通信用電話設備 (PHS端末) ・衛星電話設備 (携帯型) ・無線通信設備 (携帯型)			
	中央制御室 ・所内通信連絡設備 (警報装置を含む。) : 14台 ・電力保安通信用電話設備 (固定電話機 : 7台、PHS端末 : 10台) ・衛星電話設備 (固定型) : 2台 ・無線通信設備 (固定型) : 2台	現場 (屋内)※1 ・所内通信連絡設備 (警報装置を含む。) : 1台 ・電力保安通信用電話設備 (固定電話機、PHS端末)			
○発電所構内設置台数 ・所内通信連絡設備 (警報装置を含む。) : 約180台 ・電力保安通信用電話設備 ・固定電話機 : 約220台 ・PHS端末 : 約540台 ・衛星電話設備 (携帯型) : 10台 ・無線通信設備 (携帯型) : 62台					
<small>※1 : 制御室建物、原子炉建物、タービン建物等</small>					

図59-6-4 機能毎に必要な通信連絡設備 (発電所内)

- ・申請号炉数の相違
- 【柏崎 6/7】
- ・設備の相違
- 【東海第二】
- ③の相違

名称	衛星電話設備 (常設)	
台数	台	6号炉 1 7号炉 1

【設定根拠】

中央制御室待避室には、炉心の著しい損傷の発生時に正圧化した中央制御室待避室に待避した場合においても、衛星電話設備 (常設) を設置することで、発電所内の通信連絡をする必要のある場所と通信連絡を行うことができる設計とする。



図 59-6-4 機能毎に必要な通信連絡設備 (発電所内)

名称	衛星電話設備 (可搬型) (待避室)	
式数	式	1

【設定根拠】

重大事故等時に正圧化した中央制御室待避室に運転員が待避した場合においても、中央制御室待避室に衛星電話設備 (可搬型) (待避室) を設置することで、発電所内の通信連絡をする必要のある場所との通信連絡が可能な設計とする。

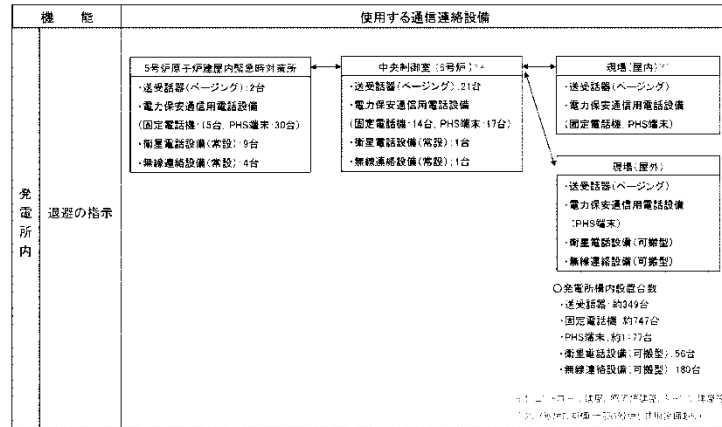
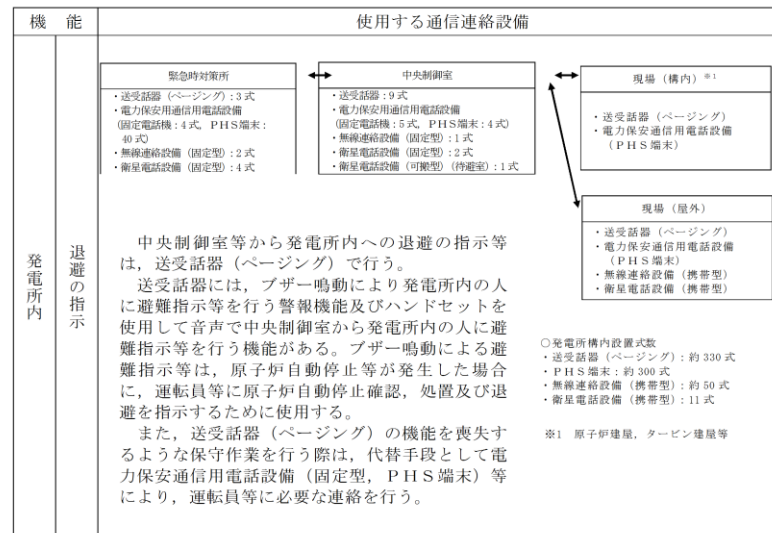

・台数については、今後、訓練等を通して見直しを行う可能性がある。

第 59-6-1 図 機能ごとに必要な通信連絡設備 (発電所内)

名称	衛星電話設備 (固定型)	
台数	台	1

【設定根拠】

中央制御室待避室には、炉心の著しい損傷の発生時に正圧化した中央制御室待避室に待避した場合においても、衛星電話設備 (固定型) を設置することで、発電所内の通信連絡をする必要のある場所と通信連絡を行うことができる設計とする。



図 59-6-5 機能毎に必要な通信連絡設備 (発電所内)

・申請号炉数の相違
 【柏崎 6/7】

柏崎刈羽原子力発電所 6/7号炉 (2017.12.20版)

東海第二発電所 (2018.9.18版)

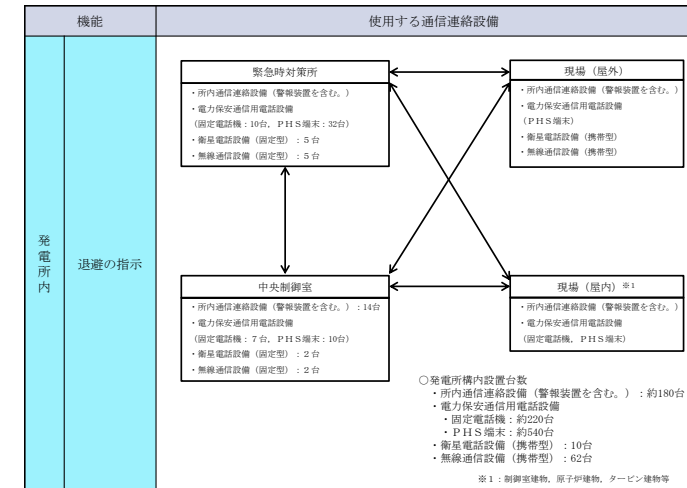
島根原子力発電所 2号炉

備考

名称	データ表示装置(待避室)	
台数	台	6号炉 1, 7号炉 1
【設定根拠】		
データ表示装置(待避室)は、炉心の著しい損傷の発生した場合において、中央制御室待避室に待避中に継続的にプラントパラメータを監視するために必要なデータ量を伝送及び表示が可能な設計とする。		
表 59-6-1 データ表示装置(待避室)で確認できるパラメータ 6号炉(1/7)		
目的	対象パラメータ	
炉心反応度の状態確認	APRM平均値	
	APRM(A)	
	APRM(B)	
	APRM(C)	
	APRM(D)	
	SRNM(A) 対数計数率出力	
	SRNM(B) 対数計数率出力	
	SRNM(C) 対数計数率出力	
	SRNM(D) 対数計数率出力	
	SRNM(E) 対数計数率出力	
	SRNM(F) 対数計数率出力	
	SRNM(G) 対数計数率出力	
	SRNM(H) 対数計数率出力	
	SRNM(I) 対数計数率出力	
	SRNM(J) 対数計数率出力	
	SRNM(K) 対数計数率出力	
	SRNM(L) 対数計数率出力	
	SRNM(M) 対数計数率出力	
	SRNM(N) 対数計数率出力	
	炉心冷却の状態確認	原子炉圧力(広帯域)(BV)
原子炉圧力(A)		
原子炉圧力(B)		
原子炉圧力(C)		
原子炉圧力(SA)		
原子炉水位(広帯域)PBV		
原子炉水位(燃料域)(A)		
原子炉水位(燃料域)(C)		
原子炉水位(燃料域)(F)		
原子炉水位(燃料域)PBV		
原子炉水位(燃料域)(A)		
原子炉水位(燃料域)(B)		
原子炉水位(SA)(ワイド)		
原子炉水位(SA)(ナロー)		
炉水温度 PBV		
漏し安全弁 開		

名称	データ表示装置(待避室)	
式数	式	1
【設定根拠】		
データ表示装置(待避室)は、重大事故等時において、運転員が中央制御室待避室に待避中に継続的にプラントパラメータを監視するために必要なデータ量を伝送及び表示が可能な設計とする。		

第 59-6-1 表 データ表示装置(待避室)で確認できるパラメータ (1/6)

目的	対象パラメータ	SPDSパラメータ	ERSS伝送パラメータ(※1)	バックアップ対象パラメータ
炉心反応度の状態確認	平均出力領域計装 平均	○	○	-
	平均出力領域計装 A	○	○	○
	平均出力領域計装 B	○	○	○
	平均出力領域計装 C	○	○	-
	平均出力領域計装 D	○	○	-
	平均出力領域計装 E	○	○	-
	平均出力領域計装 F	○	○	-
	起動領域計装 A	○	○	○
	起動領域計装 B	○	○	○
	起動領域計装 C	○	○	○
	起動領域計装 D	○	○	○
	起動領域計装 E	○	○	○
	起動領域計装 F	○	○	○
	起動領域計装 G	○	○	○
	起動領域計装 H	○	○	○
	直流±24V中性子モニタ用分電盤電圧	○	○	○
	ほう酸水注入ポンプ吐出圧力	○	○	○
	炉心冷却の状態確認	原子炉水位(狭帯域)	○	○
原子炉水位(広帯域)		○	○	○
原子炉水位(燃料域)		○	○	○
原子炉水位(SA広帯域)		○	○	○
原子炉水位(SA燃料域)		○	○	○
原子炉圧力		○	○	○
原子炉圧力(SA)		○	○	○
高圧炉心スプレイ系系統流量		○	○	○
低圧炉心スプレイ系系統流量		○	○	○
原子炉隔離時冷却系系統流量		○	○	○
残留熱除去系系統流量A		○	○	○
残留熱除去系系統流量B		○	○	○
残留熱除去系系統流量C		○	○	○
逃がし安全弁出口温度		○	○	-
原子炉再循環ポンプ入口温度		○	○	-
原子炉給水流量	○	○	-	

※1: ERSS伝送パラメータは既設SPDSのERSS伝送パラメータ及び既設SPDSから追加したパラメータのうち、プラント状態を把握する主要なパラメータをERSSへ伝送する。
原子力事業者防災業務計画の改定に合わせ、必要に応じ適宜見直していく。

名称	プラントパラメータ監視装置(中央制御室待避室)
台	1(予備1)
【設定根拠】	
プラントパラメータ監視装置(中央制御室待避室)は、炉心の著しい損傷が発生した場合において、中央制御室待避室に待避中に継続的にプラントパラメータを監視するために必要なデータの表示が可能な設計とする。	
表 59-6-1 プラントパラメータ監視装置(中央制御室待避室)で確認できるパラメータ (1/6)	
目的	対象パラメータ
炉心反応度の状態確認	APRM(平均値)
	平均出力領域計装 CH1
	平均出力領域計装 CH2
	平均出力領域計装 CH3
	平均出力領域計装 CH4
	平均出力領域計装 CH5
	平均出力領域計装 CH6
	中性子源領域計装 CH21
	中性子源領域計装 CH22
	中性子源領域計装 CH23
	中性子源領域計装 CH24
	IRMレベル CH11
	IRMレベル CH12
	IRMレベル CH13
	IRMレベル CH14
	IRMレベル CH15
	IRMレベル CH16
	IRMレベル CH17
IRMレベル CH18	
炉心冷却の状態確認	原子炉圧力
	A-原子炉圧力
	B-原子炉圧力
	原子炉圧力(SA)
	原子炉水位(広帯域)
	A-原子炉水位(広帯域)
	B-原子炉水位(広帯域)
	原子炉水位(燃料域)
	A-原子炉水位(燃料域)
	B-原子炉水位(燃料域)
	原子炉水位(狭帯域)
	原子炉水位(SA)
	A SR弁 開
B SR弁 開	
C SR弁 開	
D SR弁 開	
E SR弁 開	
F SR弁 開	
G SR弁 開	
H SR弁 開	
J SR弁 開	
K SR弁 開	
L SR弁 開	
M SR弁 開	

・設備の相違
【柏崎6/7, 東海第二】
島根2号炉は、中央制御室待避室に待避中に継続的にプラントパラメータを監視するために必要なデータの表示が可能な設計とする

柏崎刈羽原子力発電所 6 / 7号炉 (2017. 12. 20 版)	東海第二発電所 (2018. 9. 18 版)	島根原子力発電所 2号炉	備考																																																																																																																																																																																																																																							
<p>【設定根拠】 (続)</p> <p style="text-align: right;">6号炉 (2 / 7)</p> <table border="1"> <thead> <tr> <th>目的</th> <th>対象パラメータ</th> </tr> </thead> <tbody> <tr><td rowspan="33">炉心冷却の状態確認</td><td>HPCF (B) 系統流量</td></tr> <tr><td>HPCF (C) 系統流量</td></tr> <tr><td>RCIC 系統流量</td></tr> <tr><td>高压代替注水系系統流量</td></tr> <tr><td>RHR (A) 系統流量</td></tr> <tr><td>RHR (B) 系統流量</td></tr> <tr><td>RHR (C) 系統流量</td></tr> <tr><td>残留熱除去系熱交換器 (A) 入口温度</td></tr> <tr><td>残留熱除去系熱交換器 (B) 入口温度</td></tr> <tr><td>残留熱除去系熱交換器 (C) 入口温度</td></tr> <tr><td>残留熱除去系熱交換器 (A) 出口温度</td></tr> <tr><td>残留熱除去系熱交換器 (B) 出口温度</td></tr> <tr><td>残留熱除去系熱交換器 (C) 出口温度</td></tr> <tr><td>残留熱除去系熱交換器 (A) 入口冷却水流量</td></tr> <tr><td>残留熱除去系熱交換器 (B) 入口冷却水流量</td></tr> <tr><td>残留熱除去系熱交換器 (C) 入口冷却水流量</td></tr> <tr><td>原子炉補機冷却水系 (A) 系統流量</td></tr> <tr><td>原子炉補機冷却水系 (B) 系統流量</td></tr> <tr><td>原子炉補機冷却水系 (C) 系統流量</td></tr> <tr><td>6. 9 kV 6A 1 母線電圧</td></tr> <tr><td>6. 9 kV 6A 2 母線電圧</td></tr> <tr><td>6. 9 kV 6B 1 母線電圧</td></tr> <tr><td>6. 9 kV 6B 2 母線電圧</td></tr> <tr><td>6. 9 kV 6SA 1 母線電圧</td></tr> <tr><td>6. 9 kV 6SA 2 母線電圧</td></tr> <tr><td>6. 9 kV 6SB 1 母線電圧</td></tr> <tr><td>6. 9 kV 6SB 2 母線電圧</td></tr> <tr><td>6. 9 kV 6C 母線電圧</td></tr> <tr><td>6. 9 kV 6D 母線電圧</td></tr> <tr><td>6. 9 kV 6E 母線電圧</td></tr> <tr><td>D/G 6A 遮断器 投入</td></tr> <tr><td>D/G 6B 遮断器 投入</td></tr> <tr><td>D/G 6C 遮断器 投入</td></tr> <tr><td>原子炉圧力容器温度 (原子炉圧力容器下鏡上部温度)</td></tr> <tr><td>復水補給水系流量 (原子炉圧力容器) (RPV注水流量)</td></tr> <tr><td>復水貯蔵槽水位 (SA)</td></tr> </tbody> </table>	目的	対象パラメータ	炉心冷却の状態確認	HPCF (B) 系統流量	HPCF (C) 系統流量	RCIC 系統流量	高压代替注水系系統流量	RHR (A) 系統流量	RHR (B) 系統流量	RHR (C) 系統流量	残留熱除去系熱交換器 (A) 入口温度	残留熱除去系熱交換器 (B) 入口温度	残留熱除去系熱交換器 (C) 入口温度	残留熱除去系熱交換器 (A) 出口温度	残留熱除去系熱交換器 (B) 出口温度	残留熱除去系熱交換器 (C) 出口温度	残留熱除去系熱交換器 (A) 入口冷却水流量	残留熱除去系熱交換器 (B) 入口冷却水流量	残留熱除去系熱交換器 (C) 入口冷却水流量	原子炉補機冷却水系 (A) 系統流量	原子炉補機冷却水系 (B) 系統流量	原子炉補機冷却水系 (C) 系統流量	6. 9 kV 6A 1 母線電圧	6. 9 kV 6A 2 母線電圧	6. 9 kV 6B 1 母線電圧	6. 9 kV 6B 2 母線電圧	6. 9 kV 6SA 1 母線電圧	6. 9 kV 6SA 2 母線電圧	6. 9 kV 6SB 1 母線電圧	6. 9 kV 6SB 2 母線電圧	6. 9 kV 6C 母線電圧	6. 9 kV 6D 母線電圧	6. 9 kV 6E 母線電圧	D/G 6A 遮断器 投入	D/G 6B 遮断器 投入	D/G 6C 遮断器 投入	原子炉圧力容器温度 (原子炉圧力容器下鏡上部温度)	復水補給水系流量 (原子炉圧力容器) (RPV注水流量)	復水貯蔵槽水位 (SA)	<p>第59-6-1表 データ表示装置 (待避室) で確認できるパラメータ (2/6)</p> <table border="1"> <thead> <tr> <th>目的</th> <th>対象パラメータ</th> <th>SPDS パラメータ</th> <th>ERSS伝 送パラメータ (※1)</th> <th>バックアップ 対象パラメータ</th> </tr> </thead> <tbody> <tr><td rowspan="24">炉心冷却の状態確認</td><td>原子炉圧力容器温度</td><td>○</td><td>○</td><td>○</td></tr> <tr><td>残留熱除去系熱交換器入口温度</td><td>○</td><td>○</td><td>○</td></tr> <tr><td>高压代替注水系系統流量</td><td>○</td><td>○</td><td>○</td></tr> <tr><td>低压代替注水系原子炉注水流量 (常設ライン用)</td><td>○</td><td>○</td><td>○</td></tr> <tr><td>低压代替注水系原子炉注水流量 (常設ライン狭帯域用)</td><td>○</td><td>○</td><td>○</td></tr> <tr><td>低压代替注水系原子炉注水流量 (可搬ライン用)</td><td>○</td><td>○</td><td>○</td></tr> <tr><td>低压代替注水系原子炉注水流量 (可搬ライン狭帯域用)</td><td>○</td><td>○</td><td>○</td></tr> <tr><td>代替循環冷却系原子炉注水流量</td><td>○</td><td>○</td><td>○</td></tr> <tr><td>代替淡水貯槽水位</td><td>○</td><td>○</td><td>○</td></tr> <tr><td>西側淡水貯水設備水位</td><td>○</td><td>○</td><td>○</td></tr> <tr><td>M/C 2A-1 電圧</td><td>○</td><td>○</td><td>-</td></tr> <tr><td>M/C 2A-2 電圧</td><td>○</td><td>○</td><td>-</td></tr> <tr><td>M/C 2B-1 電圧</td><td>○</td><td>○</td><td>-</td></tr> <tr><td>M/C 2B-2 電圧</td><td>○</td><td>○</td><td>-</td></tr> <tr><td>M/C 2C 電圧</td><td>○</td><td>○</td><td>○</td></tr> <tr><td>M/C 2D 電圧</td><td>○</td><td>○</td><td>○</td></tr> <tr><td>M/C HPCS 電圧</td><td>○</td><td>○</td><td>○</td></tr> <tr><td>D/G 2C 遮断器 (660) 閉</td><td>○</td><td>○</td><td>-</td></tr> <tr><td>D/G 2D 遮断器 (670) 閉</td><td>○</td><td>○</td><td>-</td></tr> <tr><td>HPCS D/G 遮断器 (680) 閉</td><td>○</td><td>○</td><td>-</td></tr> <tr><td>圧力容器フランジ温度</td><td>○</td><td>○</td><td>-</td></tr> <tr><td>125V 系蓄電池A系電圧</td><td>○</td><td>○</td><td>○</td></tr> <tr><td>125V 系蓄電池B系電圧</td><td>○</td><td>○</td><td>○</td></tr> <tr><td>125V 系蓄電池HPCS系電圧</td><td>○</td><td>○</td><td>○</td></tr> <tr><td>緊急用直流 125V 主母線盤電圧</td><td>○</td><td>○</td><td>○</td></tr> <tr><td>緊急用M/C電圧</td><td>○</td><td>○</td><td>○</td></tr> <tr><td>緊急用P/C電圧</td><td>○</td><td>○</td><td>○</td></tr> <tr><td rowspan="6">原子炉格納容器内の状態確認</td><td>格納容器雰囲気放射線モニタ (D/W) (A)</td><td>○</td><td>○</td><td>○</td></tr> <tr><td>格納容器雰囲気放射線モニタ (D/W) (B)</td><td>○</td><td>○</td><td>○</td></tr> <tr><td>格納容器雰囲気放射線モニタ (S/C) (A)</td><td>○</td><td>○</td><td>○</td></tr> <tr><td>格納容器雰囲気放射線モニタ (S/C) (B)</td><td>○</td><td>○</td><td>○</td></tr> <tr><td>ドライウエル圧力 (広帯域)</td><td>○</td><td>○</td><td>○</td></tr> <tr><td>ドライウエル圧力 (狭帯域)</td><td>○</td><td>○</td><td>○</td></tr> <tr><td>ドライウエル圧力</td><td>○</td><td>○</td><td>○</td></tr> </tbody> </table> <p>※1: ERSS 伝送パラメータは既設 SPDS の ERSS 伝送パラメータ及び既設 SPDS から追加したパラメータのうち、プラント状態を把握する主要なパラメータを ERSS へ伝送する。 原子力事業者防災業務計画の改定に合わせて、必要に応じ適宜見直ししていく。</p>	目的	対象パラメータ	SPDS パラメータ	ERSS伝 送パラメータ (※1)	バックアップ 対象パラメータ	炉心冷却の状態確認	原子炉圧力容器温度	○	○	○	残留熱除去系熱交換器入口温度	○	○	○	高压代替注水系系統流量	○	○	○	低压代替注水系原子炉注水流量 (常設ライン用)	○	○	○	低压代替注水系原子炉注水流量 (常設ライン狭帯域用)	○	○	○	低压代替注水系原子炉注水流量 (可搬ライン用)	○	○	○	低压代替注水系原子炉注水流量 (可搬ライン狭帯域用)	○	○	○	代替循環冷却系原子炉注水流量	○	○	○	代替淡水貯槽水位	○	○	○	西側淡水貯水設備水位	○	○	○	M/C 2A-1 電圧	○	○	-	M/C 2A-2 電圧	○	○	-	M/C 2B-1 電圧	○	○	-	M/C 2B-2 電圧	○	○	-	M/C 2C 電圧	○	○	○	M/C 2D 電圧	○	○	○	M/C HPCS 電圧	○	○	○	D/G 2C 遮断器 (660) 閉	○	○	-	D/G 2D 遮断器 (670) 閉	○	○	-	HPCS D/G 遮断器 (680) 閉	○	○	-	圧力容器フランジ温度	○	○	-	125V 系蓄電池A系電圧	○	○	○	125V 系蓄電池B系電圧	○	○	○	125V 系蓄電池HPCS系電圧	○	○	○	緊急用直流 125V 主母線盤電圧	○	○	○	緊急用M/C電圧	○	○	○	緊急用P/C電圧	○	○	○	原子炉格納容器内の状態確認	格納容器雰囲気放射線モニタ (D/W) (A)	○	○	○	格納容器雰囲気放射線モニタ (D/W) (B)	○	○	○	格納容器雰囲気放射線モニタ (S/C) (A)	○	○	○	格納容器雰囲気放射線モニタ (S/C) (B)	○	○	○	ドライウエル圧力 (広帯域)	○	○	○	ドライウエル圧力 (狭帯域)	○	○	○	ドライウエル圧力	○	○	○	<p>【設定根拠】 (続き)</p> <p style="text-align: right;">(2 / 6)</p> <table border="1"> <thead> <tr> <th>目的</th> <th>対象パラメータ</th> </tr> </thead> <tbody> <tr><td rowspan="42">炉心冷却の状態確認</td><td>高压炉心スプレイポンプ出口流量</td></tr> <tr><td>高压炉心スプレイポンプ出口圧力</td></tr> <tr><td>低压炉心スプレイポンプ出口流量</td></tr> <tr><td>低压炉心スプレイポンプ出口圧力</td></tr> <tr><td>原子炉隔離時冷却ポンプ出口流量</td></tr> <tr><td>原子炉隔離時冷却ポンプ出口圧力</td></tr> <tr><td>高压原子炉代替注水流量</td></tr> <tr><td>A-残留熱除去ポンプ出口流量</td></tr> <tr><td>B-残留熱除去ポンプ出口流量</td></tr> <tr><td>C-残留熱除去ポンプ出口流量</td></tr> <tr><td>A-残留熱除去ポンプ出口圧力</td></tr> <tr><td>B-残留熱除去ポンプ出口圧力</td></tr> <tr><td>C-残留熱除去ポンプ出口圧力</td></tr> <tr><td>残留熱代替除去系原子炉注水流量</td></tr> <tr><td>A-残留熱除去系熱交換器入口温度</td></tr> <tr><td>B-残留熱除去系熱交換器入口温度</td></tr> <tr><td>A-残留熱除去系熱交換器出口温度</td></tr> <tr><td>B-残留熱除去系熱交換器出口温度</td></tr> <tr><td>A-残留熱除去系熱交換器冷却水流量</td></tr> <tr><td>B-残留熱除去系熱交換器冷却水流量</td></tr> <tr><td>6.9KV 系統電圧 (A)</td></tr> <tr><td>6.9KV 系統電圧 (B)</td></tr> <tr><td>6.9KV 系統電圧 (C)</td></tr> <tr><td>6.9KV 系統電圧 (D)</td></tr> <tr><td>6.9KV 系統電圧 (HPCS)</td></tr> <tr><td>A-D/G 受電しゃ断器閉</td></tr> <tr><td>B-D/G 受電しゃ断器閉</td></tr> <tr><td>A-原子炉圧力容器温度 (SA)</td></tr> <tr><td>B-原子炉圧力容器温度 (SA)</td></tr> <tr><td>A-低压原子炉代替注水ポンプ出口圧力</td></tr> <tr><td>B-低压原子炉代替注水ポンプ出口圧力</td></tr> <tr><td>A-低压原子炉代替注水流量</td></tr> <tr><td>B-低压原子炉代替注水流量</td></tr> <tr><td>A-低压原子炉代替注水流量 (狭帯域用)</td></tr> <tr><td>B-低压原子炉代替注水流量 (狭帯域用)</td></tr> <tr><td>低压原子炉代替注水槽水位</td></tr> <tr><td>HPCS-D/G 受電しゃ断器閉</td></tr> <tr><td>緊急用M/C電圧</td></tr> <tr><td>SA-L/C電圧</td></tr> <tr><td>A-再循環ポンプ入口温度</td></tr> <tr><td>B-再循環ポンプ入口温度</td></tr> <tr><td rowspan="4">原子炉格納容器内の状態確認</td><td>A-格納容器雰囲気放射線モニタ (ドライウエル)</td></tr> <tr><td>B-格納容器雰囲気放射線モニタ (ドライウエル)</td></tr> <tr><td>A-格納容器雰囲気放射線モニタ (サブプレッション・チェンバ)</td></tr> <tr><td>B-格納容器雰囲気放射線モニタ (サブプレッション・チェンバ)</td></tr> </tbody> </table>	目的	対象パラメータ	炉心冷却の状態確認	高压炉心スプレイポンプ出口流量	高压炉心スプレイポンプ出口圧力	低压炉心スプレイポンプ出口流量	低压炉心スプレイポンプ出口圧力	原子炉隔離時冷却ポンプ出口流量	原子炉隔離時冷却ポンプ出口圧力	高压原子炉代替注水流量	A-残留熱除去ポンプ出口流量	B-残留熱除去ポンプ出口流量	C-残留熱除去ポンプ出口流量	A-残留熱除去ポンプ出口圧力	B-残留熱除去ポンプ出口圧力	C-残留熱除去ポンプ出口圧力	残留熱代替除去系原子炉注水流量	A-残留熱除去系熱交換器入口温度	B-残留熱除去系熱交換器入口温度	A-残留熱除去系熱交換器出口温度	B-残留熱除去系熱交換器出口温度	A-残留熱除去系熱交換器冷却水流量	B-残留熱除去系熱交換器冷却水流量	6.9KV 系統電圧 (A)	6.9KV 系統電圧 (B)	6.9KV 系統電圧 (C)	6.9KV 系統電圧 (D)	6.9KV 系統電圧 (HPCS)	A-D/G 受電しゃ断器閉	B-D/G 受電しゃ断器閉	A-原子炉圧力容器温度 (SA)	B-原子炉圧力容器温度 (SA)	A-低压原子炉代替注水ポンプ出口圧力	B-低压原子炉代替注水ポンプ出口圧力	A-低压原子炉代替注水流量	B-低压原子炉代替注水流量	A-低压原子炉代替注水流量 (狭帯域用)	B-低压原子炉代替注水流量 (狭帯域用)	低压原子炉代替注水槽水位	HPCS-D/G 受電しゃ断器閉	緊急用M/C電圧	SA-L/C電圧	A-再循環ポンプ入口温度	B-再循環ポンプ入口温度	原子炉格納容器内の状態確認	A-格納容器雰囲気放射線モニタ (ドライウエル)	B-格納容器雰囲気放射線モニタ (ドライウエル)	A-格納容器雰囲気放射線モニタ (サブプレッション・チェンバ)	B-格納容器雰囲気放射線モニタ (サブプレッション・チェンバ)	<p>・設備の相違</p> <p>【柏崎 6/7, 東海第二】 島根 2号炉は、中央制御室待避室に待避中に継続的にプラントパラメータを監視するために必要なデータの表示が可能な設計とする</p>
目的	対象パラメータ																																																																																																																																																																																																																																									
炉心冷却の状態確認	HPCF (B) 系統流量																																																																																																																																																																																																																																									
	HPCF (C) 系統流量																																																																																																																																																																																																																																									
	RCIC 系統流量																																																																																																																																																																																																																																									
	高压代替注水系系統流量																																																																																																																																																																																																																																									
	RHR (A) 系統流量																																																																																																																																																																																																																																									
	RHR (B) 系統流量																																																																																																																																																																																																																																									
	RHR (C) 系統流量																																																																																																																																																																																																																																									
	残留熱除去系熱交換器 (A) 入口温度																																																																																																																																																																																																																																									
	残留熱除去系熱交換器 (B) 入口温度																																																																																																																																																																																																																																									
	残留熱除去系熱交換器 (C) 入口温度																																																																																																																																																																																																																																									
	残留熱除去系熱交換器 (A) 出口温度																																																																																																																																																																																																																																									
	残留熱除去系熱交換器 (B) 出口温度																																																																																																																																																																																																																																									
	残留熱除去系熱交換器 (C) 出口温度																																																																																																																																																																																																																																									
	残留熱除去系熱交換器 (A) 入口冷却水流量																																																																																																																																																																																																																																									
	残留熱除去系熱交換器 (B) 入口冷却水流量																																																																																																																																																																																																																																									
	残留熱除去系熱交換器 (C) 入口冷却水流量																																																																																																																																																																																																																																									
	原子炉補機冷却水系 (A) 系統流量																																																																																																																																																																																																																																									
	原子炉補機冷却水系 (B) 系統流量																																																																																																																																																																																																																																									
	原子炉補機冷却水系 (C) 系統流量																																																																																																																																																																																																																																									
	6. 9 kV 6A 1 母線電圧																																																																																																																																																																																																																																									
	6. 9 kV 6A 2 母線電圧																																																																																																																																																																																																																																									
	6. 9 kV 6B 1 母線電圧																																																																																																																																																																																																																																									
	6. 9 kV 6B 2 母線電圧																																																																																																																																																																																																																																									
	6. 9 kV 6SA 1 母線電圧																																																																																																																																																																																																																																									
	6. 9 kV 6SA 2 母線電圧																																																																																																																																																																																																																																									
	6. 9 kV 6SB 1 母線電圧																																																																																																																																																																																																																																									
	6. 9 kV 6SB 2 母線電圧																																																																																																																																																																																																																																									
	6. 9 kV 6C 母線電圧																																																																																																																																																																																																																																									
	6. 9 kV 6D 母線電圧																																																																																																																																																																																																																																									
	6. 9 kV 6E 母線電圧																																																																																																																																																																																																																																									
	D/G 6A 遮断器 投入																																																																																																																																																																																																																																									
	D/G 6B 遮断器 投入																																																																																																																																																																																																																																									
	D/G 6C 遮断器 投入																																																																																																																																																																																																																																									
原子炉圧力容器温度 (原子炉圧力容器下鏡上部温度)																																																																																																																																																																																																																																										
復水補給水系流量 (原子炉圧力容器) (RPV注水流量)																																																																																																																																																																																																																																										
復水貯蔵槽水位 (SA)																																																																																																																																																																																																																																										
目的	対象パラメータ	SPDS パラメータ	ERSS伝 送パラメータ (※1)	バックアップ 対象パラメータ																																																																																																																																																																																																																																						
炉心冷却の状態確認	原子炉圧力容器温度	○	○	○																																																																																																																																																																																																																																						
	残留熱除去系熱交換器入口温度	○	○	○																																																																																																																																																																																																																																						
	高压代替注水系系統流量	○	○	○																																																																																																																																																																																																																																						
	低压代替注水系原子炉注水流量 (常設ライン用)	○	○	○																																																																																																																																																																																																																																						
	低压代替注水系原子炉注水流量 (常設ライン狭帯域用)	○	○	○																																																																																																																																																																																																																																						
	低压代替注水系原子炉注水流量 (可搬ライン用)	○	○	○																																																																																																																																																																																																																																						
	低压代替注水系原子炉注水流量 (可搬ライン狭帯域用)	○	○	○																																																																																																																																																																																																																																						
	代替循環冷却系原子炉注水流量	○	○	○																																																																																																																																																																																																																																						
	代替淡水貯槽水位	○	○	○																																																																																																																																																																																																																																						
	西側淡水貯水設備水位	○	○	○																																																																																																																																																																																																																																						
	M/C 2A-1 電圧	○	○	-																																																																																																																																																																																																																																						
	M/C 2A-2 電圧	○	○	-																																																																																																																																																																																																																																						
	M/C 2B-1 電圧	○	○	-																																																																																																																																																																																																																																						
	M/C 2B-2 電圧	○	○	-																																																																																																																																																																																																																																						
	M/C 2C 電圧	○	○	○																																																																																																																																																																																																																																						
	M/C 2D 電圧	○	○	○																																																																																																																																																																																																																																						
	M/C HPCS 電圧	○	○	○																																																																																																																																																																																																																																						
	D/G 2C 遮断器 (660) 閉	○	○	-																																																																																																																																																																																																																																						
	D/G 2D 遮断器 (670) 閉	○	○	-																																																																																																																																																																																																																																						
	HPCS D/G 遮断器 (680) 閉	○	○	-																																																																																																																																																																																																																																						
	圧力容器フランジ温度	○	○	-																																																																																																																																																																																																																																						
	125V 系蓄電池A系電圧	○	○	○																																																																																																																																																																																																																																						
	125V 系蓄電池B系電圧	○	○	○																																																																																																																																																																																																																																						
	125V 系蓄電池HPCS系電圧	○	○	○																																																																																																																																																																																																																																						
緊急用直流 125V 主母線盤電圧	○	○	○																																																																																																																																																																																																																																							
緊急用M/C電圧	○	○	○																																																																																																																																																																																																																																							
緊急用P/C電圧	○	○	○																																																																																																																																																																																																																																							
原子炉格納容器内の状態確認	格納容器雰囲気放射線モニタ (D/W) (A)	○	○	○																																																																																																																																																																																																																																						
	格納容器雰囲気放射線モニタ (D/W) (B)	○	○	○																																																																																																																																																																																																																																						
	格納容器雰囲気放射線モニタ (S/C) (A)	○	○	○																																																																																																																																																																																																																																						
	格納容器雰囲気放射線モニタ (S/C) (B)	○	○	○																																																																																																																																																																																																																																						
	ドライウエル圧力 (広帯域)	○	○	○																																																																																																																																																																																																																																						
	ドライウエル圧力 (狭帯域)	○	○	○																																																																																																																																																																																																																																						
ドライウエル圧力	○	○	○																																																																																																																																																																																																																																							
目的	対象パラメータ																																																																																																																																																																																																																																									
炉心冷却の状態確認	高压炉心スプレイポンプ出口流量																																																																																																																																																																																																																																									
	高压炉心スプレイポンプ出口圧力																																																																																																																																																																																																																																									
	低压炉心スプレイポンプ出口流量																																																																																																																																																																																																																																									
	低压炉心スプレイポンプ出口圧力																																																																																																																																																																																																																																									
	原子炉隔離時冷却ポンプ出口流量																																																																																																																																																																																																																																									
	原子炉隔離時冷却ポンプ出口圧力																																																																																																																																																																																																																																									
	高压原子炉代替注水流量																																																																																																																																																																																																																																									
	A-残留熱除去ポンプ出口流量																																																																																																																																																																																																																																									
	B-残留熱除去ポンプ出口流量																																																																																																																																																																																																																																									
	C-残留熱除去ポンプ出口流量																																																																																																																																																																																																																																									
	A-残留熱除去ポンプ出口圧力																																																																																																																																																																																																																																									
	B-残留熱除去ポンプ出口圧力																																																																																																																																																																																																																																									
	C-残留熱除去ポンプ出口圧力																																																																																																																																																																																																																																									
	残留熱代替除去系原子炉注水流量																																																																																																																																																																																																																																									
	A-残留熱除去系熱交換器入口温度																																																																																																																																																																																																																																									
	B-残留熱除去系熱交換器入口温度																																																																																																																																																																																																																																									
	A-残留熱除去系熱交換器出口温度																																																																																																																																																																																																																																									
	B-残留熱除去系熱交換器出口温度																																																																																																																																																																																																																																									
	A-残留熱除去系熱交換器冷却水流量																																																																																																																																																																																																																																									
	B-残留熱除去系熱交換器冷却水流量																																																																																																																																																																																																																																									
	6.9KV 系統電圧 (A)																																																																																																																																																																																																																																									
	6.9KV 系統電圧 (B)																																																																																																																																																																																																																																									
	6.9KV 系統電圧 (C)																																																																																																																																																																																																																																									
	6.9KV 系統電圧 (D)																																																																																																																																																																																																																																									
	6.9KV 系統電圧 (HPCS)																																																																																																																																																																																																																																									
	A-D/G 受電しゃ断器閉																																																																																																																																																																																																																																									
	B-D/G 受電しゃ断器閉																																																																																																																																																																																																																																									
	A-原子炉圧力容器温度 (SA)																																																																																																																																																																																																																																									
	B-原子炉圧力容器温度 (SA)																																																																																																																																																																																																																																									
	A-低压原子炉代替注水ポンプ出口圧力																																																																																																																																																																																																																																									
	B-低压原子炉代替注水ポンプ出口圧力																																																																																																																																																																																																																																									
	A-低压原子炉代替注水流量																																																																																																																																																																																																																																									
	B-低压原子炉代替注水流量																																																																																																																																																																																																																																									
	A-低压原子炉代替注水流量 (狭帯域用)																																																																																																																																																																																																																																									
	B-低压原子炉代替注水流量 (狭帯域用)																																																																																																																																																																																																																																									
	低压原子炉代替注水槽水位																																																																																																																																																																																																																																									
	HPCS-D/G 受電しゃ断器閉																																																																																																																																																																																																																																									
	緊急用M/C電圧																																																																																																																																																																																																																																									
	SA-L/C電圧																																																																																																																																																																																																																																									
	A-再循環ポンプ入口温度																																																																																																																																																																																																																																									
	B-再循環ポンプ入口温度																																																																																																																																																																																																																																									
	原子炉格納容器内の状態確認	A-格納容器雰囲気放射線モニタ (ドライウエル)																																																																																																																																																																																																																																								
B-格納容器雰囲気放射線モニタ (ドライウエル)																																																																																																																																																																																																																																										
A-格納容器雰囲気放射線モニタ (サブプレッション・チェンバ)																																																																																																																																																																																																																																										
B-格納容器雰囲気放射線モニタ (サブプレッション・チェンバ)																																																																																																																																																																																																																																										

【設定根拠】 (続)

6号炉 (4 / 7)

目的	対象パラメータ
格納容器内の状態確認	復水移送ポンプ (A) 吐出圧力
	復水移送ポンプ (B) 吐出圧力
	復水移送ポンプ (C) 吐出圧力
	復水補給水系温度 (代替循環冷却)
	格納容器下部水位 (ベデスタル水位高 (3m))
	格納容器下部水位 (ベデスタル水位高 (2m))
放射能隔離の状態確認	格納容器下部水位 (ベデスタル水位高 (1m))
	復水補給水系流量 (原子炉格納容器) (ベデスタル注水流量)
	排気筒排気放射能 (IC) (最大)
	排気筒排気 (SCIN) 放射能 (A)
	排気筒排気 (SCIN) 放射能 (B)
	主蒸気管放射能高 (スクラム) 区分 (1)
	主蒸気管放射能高 (スクラム) 区分 (2)
	主蒸気管放射能高 (スクラム) 区分 (3)
	主蒸気管放射能高 (スクラム) 区分 (4)
	PCIS隔離 内側
	PCIS隔離 外側
	MSIV (内側) 閉
	主蒸気内側隔離弁 (A) 全閉以外
	主蒸気内側隔離弁 (B) 全閉以外
	主蒸気内側隔離弁 (C) 全閉以外
	主蒸気内側隔離弁 (D) 全閉以外
	MSIV (外側) 閉
	主蒸気外側隔離弁 (A) 全閉以外
	主蒸気外側隔離弁 (B) 全閉以外
	主蒸気外側隔離弁 (C) 全閉以外
	主蒸気外側隔離弁 (D) 全閉以外
環境の情報確認	SGTS (A) 作動 (1系)
	SGTS (B) 作動 (1系)
	SGTS排ガス放射能 (IC) (最大)
	SGTS排ガス (SCIN) 放射能 (A)
	SGTS排ガス (SCIN) 放射能 (B)

第59-6-1表 データ表示装置 (待避室) で確認できるパラメータ (4/6)

目的	対象パラメータ	SPDSパラメータ	ERSS伝送パラメータ (※1)	バックアップ対象パラメータ	
原子炉格納容器内の状態確認	残留熱除去系 A注入弁全開	○	○	-	
	残留熱除去系 B注入弁全開	○	○	-	
	残留熱除去系 C注入弁全開	○	○	-	
	格納容器内スプレイ弁A (全開)	○	○	-	
	格納容器内スプレイ弁B (全開)	○	○	-	
	主排気筒放射線モニタA	○	○	-	
放射能隔離の状態確認	主排気筒放射線モニタB	○	○	-	
	主排気筒モニタ (高レンジ)	○	○	-	
	主蒸気管放射線モニタ (A)	○	○	○	
	主蒸気管放射線モニタ (B)	○	○	○	
	主蒸気管放射線モニタ (C)	○	○	○	
	主蒸気管放射線モニタ (D)	○	○	○	
	排ガス放射能 (プレホールドアップ) A	○	○	-	
	排ガス放射能 (プレホールドアップ) B	○	○	-	
	NS4内側隔離	○	○	-	
	NS4外側隔離	○	○	-	
	主蒸気内側隔離弁A全閉	○	○	-	
	主蒸気内側隔離弁B全閉	○	○	-	
	主蒸気内側隔離弁C全閉	○	○	-	
	主蒸気内側隔離弁D全閉	○	○	-	
	主蒸気外側隔離弁A全閉	○	○	-	
	主蒸気外側隔離弁B全閉	○	○	-	
	主蒸気外側隔離弁C全閉	○	○	-	
	主蒸気外側隔離弁D全閉	○	○	-	
	環境の情報確認	SGTS A作動	○	○	-
		SGTS B作動	○	○	-
		SGTSMONIT (高レンジ) A	○	○	-
SGTSMONIT (高レンジ) B		○	○	-	
SGTSMONIT (低レンジ) A		○	○	-	

※1: ERSS伝送パラメータは既設SPDSのERSS伝送パラメータ及び既設SPDSから追加したパラメータのうち、プラント状態を把握する主要なパラメータをERSSへ伝送する。

原子力事業者防災業務計画の改定に合わせ、必要に応じ適宜見直ししていく。

【設定根拠】 (続き)

(4 / 6)

目的	対象パラメータ
放射能隔離の状態確認	排気筒高レンジモニタ
	排気筒低レンジモニタ (A c h)
	排気筒低レンジモニタ (B c h)
	主蒸気管放射線異常高トリップA1
	主蒸気管放射線異常高トリップB1
	主蒸気管放射線異常高トリップA2
	主蒸気管放射線異常高トリップB2
	格納容器内側隔離
	格納容器外側隔離
	A-主蒸気内側隔離弁全閉
	B-主蒸気内側隔離弁全閉
	C-主蒸気内側隔離弁全閉
	D-主蒸気内側隔離弁全閉
	A-主蒸気外側隔離弁全閉
	B-主蒸気外側隔離弁全閉
	C-主蒸気外側隔離弁全閉
	D-主蒸気外側隔離弁全閉
環境の状態確認	A-SGT自動起動
	B-SGT自動起動
	SGTS高レンジモニタ
	SGTS低レンジモニタ (A c h)
	SGTS低レンジモニタ (B c h)
	A-原子炉建物外気差圧
	B-原子炉建物外気差圧
	C-原子炉建物外気差圧
	D-原子炉建物外気差圧
	中央制御室外気差圧
	放水路水モニタ
	モニタリング・ポスト# 1 H
	モニタリング・ポスト# 2 H
	モニタリング・ポスト# 3 H
	モニタリング・ポスト# 4 H
	モニタリング・ポスト# 5 H
	モニタリング・ポスト# 6 H
	モニタリング・ポスト# 1 L (10分間平均)
	モニタリング・ポスト# 2 L (10分間平均)
	モニタリング・ポスト# 3 L (10分間平均)
	モニタリング・ポスト# 4 L (10分間平均)
	モニタリング・ポスト# 5 L (10分間平均)
	モニタリング・ポスト# 6 L (10分間平均)
風向 (28.5m-U)	
風向 (130M-D, 10分間平均風向)	
風速 (28.5m-U)	
風速 (130M-D, 10分間平均風速)	
大気安定度 (10分間平均)	

・設備の相違

【柏崎6/7, 東海第二】
島根2号炉は、中央制御室待避室に待避中に継続的にプラントパラメータを監視するために必要なデータの表示が可能な設計とする

柏崎刈羽原子力発電所 6 / 7号炉 (2017. 12. 20 版)	東海第二発電所 (2018. 9. 18 版)	島根原子力発電所 2号炉	備考																																																																																																																																																				
<p>【設定根拠】 (続)</p> <p style="text-align: right;">6号炉 (5 / 7)</p> <table border="1"> <thead> <tr> <th>目的</th> <th>対象パラメータ</th> </tr> </thead> <tbody> <tr><td rowspan="17">非常用炉心冷却系 (ECCS) の状態等</td> <td>ADS A 作動</td> </tr> <tr><td>ADS B 作動</td> </tr> <tr><td>R C I C 作動</td> </tr> <tr><td>H P C Fポンプ (B) 起動</td> </tr> <tr><td>H P C Fポンプ (C) 起動</td> </tr> <tr><td>R H Rポンプ (A) 起動</td> </tr> <tr><td>R H Rポンプ (B) 起動</td> </tr> <tr><td>R H Rポンプ (C) 起動</td> </tr> <tr><td>R H R注入弁 (A) 全閉以外</td> </tr> <tr><td>R H R注入弁 (B) 全閉以外</td> </tr> <tr><td>R H R注入弁 (C) 全閉以外</td> </tr> <tr><td>全制御棒全挿入</td> </tr> <tr><td>総給水流量</td> </tr> <tr><td>使用済燃料貯蔵プール水位・温度 (SA) (使用済燃料貯蔵プールエリア雰囲気温度)</td> </tr> <tr><td>使用済燃料貯蔵プール水位・温度 (SA) (使用済燃料貯蔵プール温度(燃料ラック上端+600mm))</td> </tr> <tr><td>使用済燃料貯蔵プール水位・温度 (SA) (使用済燃料貯蔵プール温度(燃料ラック上端+500mm))</td> </tr> <tr><td>使用済燃料貯蔵プール水位・温度 (SA) (使用済燃料貯蔵プール温度(燃料ラック上端+400mm))</td> </tr> <tr><td>使用済燃料貯蔵プール水位・温度 (SA) (使用済燃料貯蔵プール温度(燃料ラック上端+300mm))</td> </tr> <tr><td>使用済燃料貯蔵プール水位・温度 (SA) (使用済燃料貯蔵プール温度(燃料ラック上端+200mm))</td> </tr> <tr><td>使用済燃料貯蔵プール水位・温度 (SA) (使用済燃料貯蔵プール温度(燃料ラック上端+100mm))</td> </tr> <tr><td>使用済燃料貯蔵プール水位・温度 (SA) (使用済燃料貯蔵プール温度(燃料ラック上端))</td> </tr> <tr><td>使用済燃料貯蔵プール水位・温度 (SA) (使用済燃料貯蔵プール温度(燃料ラック上端-100mm))</td> </tr> <tr><td>使用済燃料貯蔵プール放射線モニタ (低レンジ)</td> </tr> <tr><td>使用済燃料貯蔵プール放射線モニタ (高レンジ)</td> </tr> </tbody> </table>	目的	対象パラメータ	非常用炉心冷却系 (ECCS) の状態等	ADS A 作動	ADS B 作動	R C I C 作動	H P C Fポンプ (B) 起動	H P C Fポンプ (C) 起動	R H Rポンプ (A) 起動	R H Rポンプ (B) 起動	R H Rポンプ (C) 起動	R H R注入弁 (A) 全閉以外	R H R注入弁 (B) 全閉以外	R H R注入弁 (C) 全閉以外	全制御棒全挿入	総給水流量	使用済燃料貯蔵プール水位・温度 (SA) (使用済燃料貯蔵プールエリア雰囲気温度)	使用済燃料貯蔵プール水位・温度 (SA) (使用済燃料貯蔵プール温度(燃料ラック上端+600mm))	使用済燃料貯蔵プール水位・温度 (SA) (使用済燃料貯蔵プール温度(燃料ラック上端+500mm))	使用済燃料貯蔵プール水位・温度 (SA) (使用済燃料貯蔵プール温度(燃料ラック上端+400mm))	使用済燃料貯蔵プール水位・温度 (SA) (使用済燃料貯蔵プール温度(燃料ラック上端+300mm))	使用済燃料貯蔵プール水位・温度 (SA) (使用済燃料貯蔵プール温度(燃料ラック上端+200mm))	使用済燃料貯蔵プール水位・温度 (SA) (使用済燃料貯蔵プール温度(燃料ラック上端+100mm))	使用済燃料貯蔵プール水位・温度 (SA) (使用済燃料貯蔵プール温度(燃料ラック上端))	使用済燃料貯蔵プール水位・温度 (SA) (使用済燃料貯蔵プール温度(燃料ラック上端-100mm))	使用済燃料貯蔵プール放射線モニタ (低レンジ)	使用済燃料貯蔵プール放射線モニタ (高レンジ)	<p>第59-6-1表 データ表示装置(待避室)で確認できるパラメータ (5/6)</p> <table border="1"> <thead> <tr> <th>目的</th> <th>対象パラメータ</th> <th>SPDSパラメータ</th> <th>ERSS伝送パラメータ(※1)</th> <th>バックアップ対象パラメータ</th> </tr> </thead> <tbody> <tr><td rowspan="17">環境の情報確認</td> <td>耐圧強化ベント系放射線モニタ</td> <td>○</td> <td>○</td> <td>○</td> </tr> <tr><td>放水口モニタ(T-2)</td> <td>○</td> <td>○</td> <td>-</td> </tr> <tr><td>モニタリング・ポスト(A)</td> <td>○</td> <td>○</td> <td>-</td> </tr> <tr><td>モニタリング・ポスト(B)</td> <td>○</td> <td>○</td> <td>-</td> </tr> <tr><td>モニタリング・ポスト(C)</td> <td>○</td> <td>○</td> <td>-</td> </tr> <tr><td>モニタリング・ポスト(D)</td> <td>○</td> <td>○</td> <td>-</td> </tr> <tr><td>モニタリング・ポスト(A)広域レンジ</td> <td>○</td> <td>○</td> <td>-</td> </tr> <tr><td>モニタリング・ポスト(B)広域レンジ</td> <td>○</td> <td>○</td> <td>-</td> </tr> <tr><td>モニタリング・ポスト(C)広域レンジ</td> <td>○</td> <td>○</td> <td>-</td> </tr> <tr><td>モニタリング・ポスト(D)広域レンジ</td> <td>○</td> <td>○</td> <td>-</td> </tr> <tr><td>大気安定度 10分値</td> <td>○</td> <td>○</td> <td>-</td> </tr> <tr><td>18m ベクトル平均風向 10分値</td> <td>○</td> <td>○</td> <td>-</td> </tr> <tr><td>71m ベクトル平均風向 10分値</td> <td>○</td> <td>○</td> <td>-</td> </tr> <tr><td>140m ベクトル平均風向 10分値</td> <td>○</td> <td>○</td> <td>-</td> </tr> <tr><td>18m ベクトル平均風速 10分値</td> <td>○</td> <td>○</td> <td>-</td> </tr> <tr><td>71m ベクトル平均風速 10分値</td> <td>○</td> <td>○</td> <td>-</td> </tr> <tr><td>140m ベクトル平均風速 10分値</td> <td>○</td> <td>○</td> <td>-</td> </tr> </tbody> </table> <p>※1: ERSS伝送パラメータは既設SPDSのERSS伝送パラメータ及び既設SPDSから追加したパラメータのうち、プラント状態を把握する主要なパラメータをERSSへ伝送する。</p> <p>原子力事業者防災業務計画の改定に合わせ、必要に応じ適宜見直していく。</p>	目的	対象パラメータ	SPDSパラメータ	ERSS伝送パラメータ(※1)	バックアップ対象パラメータ	環境の情報確認	耐圧強化ベント系放射線モニタ	○	○	○	放水口モニタ(T-2)	○	○	-	モニタリング・ポスト(A)	○	○	-	モニタリング・ポスト(B)	○	○	-	モニタリング・ポスト(C)	○	○	-	モニタリング・ポスト(D)	○	○	-	モニタリング・ポスト(A)広域レンジ	○	○	-	モニタリング・ポスト(B)広域レンジ	○	○	-	モニタリング・ポスト(C)広域レンジ	○	○	-	モニタリング・ポスト(D)広域レンジ	○	○	-	大気安定度 10分値	○	○	-	18m ベクトル平均風向 10分値	○	○	-	71m ベクトル平均風向 10分値	○	○	-	140m ベクトル平均風向 10分値	○	○	-	18m ベクトル平均風速 10分値	○	○	-	71m ベクトル平均風速 10分値	○	○	-	140m ベクトル平均風速 10分値	○	○	-	<p>【設定根拠】 (続き)</p> <p style="text-align: right;">(5 / 6)</p> <table border="1"> <thead> <tr> <th>目的</th> <th>対象パラメータ</th> </tr> </thead> <tbody> <tr><td rowspan="12">環境の状態確認</td> <td>可搬式モニタリング・ポストNo.1</td> </tr> <tr><td>可搬式モニタリング・ポストNo.2</td> </tr> <tr><td>可搬型モニタリング・ポストNo.3</td> </tr> <tr><td>可搬式モニタリング・ポストNo.4</td> </tr> <tr><td>可搬式モニタリング・ポストNo.5</td> </tr> <tr><td>可搬式モニタリング・ポストNo.6</td> </tr> <tr><td>可搬式モニタリング・ポストNo.7</td> </tr> <tr><td>可搬式モニタリング・ポストNo.8</td> </tr> <tr><td>可搬式モニタリング・ポストNo.9</td> </tr> <tr><td>可搬式モニタリング・ポストNo.10</td> </tr> <tr><td>可搬式モニタリング・ポストNo.11</td> </tr> <tr><td>可搬式モニタリング・ポストNo.12</td> </tr> <tr><td>風向(可搬)</td> </tr> <tr><td>風速(可搬)</td> </tr> <tr><td>大気安定度(可搬)</td> </tr> <tr><td rowspan="12">非常用炉心冷却系(ECCS)の状態等確認</td> <td>A-ADS作動</td> </tr> <tr><td>B-ADS作動</td> </tr> <tr><td>R C I Cポンプ作動</td> </tr> <tr><td>H P C Sポンプ作動</td> </tr> <tr><td>A-RHRポンプ作動</td> </tr> <tr><td>B-RHRポンプ作動</td> </tr> <tr><td>C-RHRポンプ作動</td> </tr> <tr><td>RHR MV222-4A 全閉</td> </tr> <tr><td>RHR MV222-4B 全閉</td> </tr> <tr><td>RHR MV222-5A 全閉</td> </tr> <tr><td>RHR MV222-5B 全閉</td> </tr> <tr><td>RHR MV222-5C 全閉</td> </tr> <tr><td>全制御棒全挿入</td> </tr> <tr><td>A-給水流量</td> </tr> <tr><td>B-給水流量</td> </tr> <tr><td>L P C Sポンプ作動</td> </tr> <tr><td>モードSW運転</td> </tr> <tr><td rowspan="10">燃料プールの状態確認</td> <td>燃料プール水位・温度(SA) (使用済燃料貯蔵ラック上端+6710mm)</td> </tr> <tr><td>燃料プール水位・温度(SA) (使用済燃料貯蔵ラック上端+5800mm)</td> </tr> <tr><td>燃料プール水位・温度(SA) (使用済燃料貯蔵ラック上端+4500mm)</td> </tr> <tr><td>燃料プール水位・温度(SA) (使用済燃料貯蔵ラック上端+2000mm)</td> </tr> <tr><td>燃料プール水位・温度(SA) (使用済燃料貯蔵ラック上端レベル)</td> </tr> <tr><td>燃料プール水位・温度(SA) (使用済燃料貯蔵ラック上端-1000mm)</td> </tr> <tr><td>燃料プール水位・温度(SA)(燃料プール温度)</td> </tr> <tr><td>燃料プール水位(SA)</td> </tr> <tr><td>燃料プールエリア放射線モニタ(低レンジ)(SA)</td> </tr> <tr><td>燃料プールエリア放射線モニタ(高レンジ)(SA)</td> </tr> </tbody> </table>	目的	対象パラメータ	環境の状態確認	可搬式モニタリング・ポストNo.1	可搬式モニタリング・ポストNo.2	可搬型モニタリング・ポストNo.3	可搬式モニタリング・ポストNo.4	可搬式モニタリング・ポストNo.5	可搬式モニタリング・ポストNo.6	可搬式モニタリング・ポストNo.7	可搬式モニタリング・ポストNo.8	可搬式モニタリング・ポストNo.9	可搬式モニタリング・ポストNo.10	可搬式モニタリング・ポストNo.11	可搬式モニタリング・ポストNo.12	風向(可搬)	風速(可搬)	大気安定度(可搬)	非常用炉心冷却系(ECCS)の状態等確認	A-ADS作動	B-ADS作動	R C I Cポンプ作動	H P C Sポンプ作動	A-RHRポンプ作動	B-RHRポンプ作動	C-RHRポンプ作動	RHR MV222-4A 全閉	RHR MV222-4B 全閉	RHR MV222-5A 全閉	RHR MV222-5B 全閉	RHR MV222-5C 全閉	全制御棒全挿入	A-給水流量	B-給水流量	L P C Sポンプ作動	モードSW運転	燃料プールの状態確認	燃料プール水位・温度(SA) (使用済燃料貯蔵ラック上端+6710mm)	燃料プール水位・温度(SA) (使用済燃料貯蔵ラック上端+5800mm)	燃料プール水位・温度(SA) (使用済燃料貯蔵ラック上端+4500mm)	燃料プール水位・温度(SA) (使用済燃料貯蔵ラック上端+2000mm)	燃料プール水位・温度(SA) (使用済燃料貯蔵ラック上端レベル)	燃料プール水位・温度(SA) (使用済燃料貯蔵ラック上端-1000mm)	燃料プール水位・温度(SA)(燃料プール温度)	燃料プール水位(SA)	燃料プールエリア放射線モニタ(低レンジ)(SA)	燃料プールエリア放射線モニタ(高レンジ)(SA)	<p>・設備の相違</p> <p>【柏崎6/7, 東海第二】 島根2号炉は、中央制御室待避室に待避中に継続的にプラントパラメータを監視するために必要なデータの表示が可能な設計とする</p>
目的	対象パラメータ																																																																																																																																																						
非常用炉心冷却系 (ECCS) の状態等	ADS A 作動																																																																																																																																																						
	ADS B 作動																																																																																																																																																						
	R C I C 作動																																																																																																																																																						
	H P C Fポンプ (B) 起動																																																																																																																																																						
	H P C Fポンプ (C) 起動																																																																																																																																																						
	R H Rポンプ (A) 起動																																																																																																																																																						
	R H Rポンプ (B) 起動																																																																																																																																																						
	R H Rポンプ (C) 起動																																																																																																																																																						
	R H R注入弁 (A) 全閉以外																																																																																																																																																						
	R H R注入弁 (B) 全閉以外																																																																																																																																																						
	R H R注入弁 (C) 全閉以外																																																																																																																																																						
	全制御棒全挿入																																																																																																																																																						
	総給水流量																																																																																																																																																						
	使用済燃料貯蔵プール水位・温度 (SA) (使用済燃料貯蔵プールエリア雰囲気温度)																																																																																																																																																						
	使用済燃料貯蔵プール水位・温度 (SA) (使用済燃料貯蔵プール温度(燃料ラック上端+600mm))																																																																																																																																																						
	使用済燃料貯蔵プール水位・温度 (SA) (使用済燃料貯蔵プール温度(燃料ラック上端+500mm))																																																																																																																																																						
	使用済燃料貯蔵プール水位・温度 (SA) (使用済燃料貯蔵プール温度(燃料ラック上端+400mm))																																																																																																																																																						
使用済燃料貯蔵プール水位・温度 (SA) (使用済燃料貯蔵プール温度(燃料ラック上端+300mm))																																																																																																																																																							
使用済燃料貯蔵プール水位・温度 (SA) (使用済燃料貯蔵プール温度(燃料ラック上端+200mm))																																																																																																																																																							
使用済燃料貯蔵プール水位・温度 (SA) (使用済燃料貯蔵プール温度(燃料ラック上端+100mm))																																																																																																																																																							
使用済燃料貯蔵プール水位・温度 (SA) (使用済燃料貯蔵プール温度(燃料ラック上端))																																																																																																																																																							
使用済燃料貯蔵プール水位・温度 (SA) (使用済燃料貯蔵プール温度(燃料ラック上端-100mm))																																																																																																																																																							
使用済燃料貯蔵プール放射線モニタ (低レンジ)																																																																																																																																																							
使用済燃料貯蔵プール放射線モニタ (高レンジ)																																																																																																																																																							
目的	対象パラメータ	SPDSパラメータ	ERSS伝送パラメータ(※1)	バックアップ対象パラメータ																																																																																																																																																			
環境の情報確認	耐圧強化ベント系放射線モニタ	○	○	○																																																																																																																																																			
	放水口モニタ(T-2)	○	○	-																																																																																																																																																			
	モニタリング・ポスト(A)	○	○	-																																																																																																																																																			
	モニタリング・ポスト(B)	○	○	-																																																																																																																																																			
	モニタリング・ポスト(C)	○	○	-																																																																																																																																																			
	モニタリング・ポスト(D)	○	○	-																																																																																																																																																			
	モニタリング・ポスト(A)広域レンジ	○	○	-																																																																																																																																																			
	モニタリング・ポスト(B)広域レンジ	○	○	-																																																																																																																																																			
	モニタリング・ポスト(C)広域レンジ	○	○	-																																																																																																																																																			
	モニタリング・ポスト(D)広域レンジ	○	○	-																																																																																																																																																			
	大気安定度 10分値	○	○	-																																																																																																																																																			
	18m ベクトル平均風向 10分値	○	○	-																																																																																																																																																			
	71m ベクトル平均風向 10分値	○	○	-																																																																																																																																																			
	140m ベクトル平均風向 10分値	○	○	-																																																																																																																																																			
	18m ベクトル平均風速 10分値	○	○	-																																																																																																																																																			
	71m ベクトル平均風速 10分値	○	○	-																																																																																																																																																			
	140m ベクトル平均風速 10分値	○	○	-																																																																																																																																																			
目的	対象パラメータ																																																																																																																																																						
環境の状態確認	可搬式モニタリング・ポストNo.1																																																																																																																																																						
	可搬式モニタリング・ポストNo.2																																																																																																																																																						
	可搬型モニタリング・ポストNo.3																																																																																																																																																						
	可搬式モニタリング・ポストNo.4																																																																																																																																																						
	可搬式モニタリング・ポストNo.5																																																																																																																																																						
	可搬式モニタリング・ポストNo.6																																																																																																																																																						
	可搬式モニタリング・ポストNo.7																																																																																																																																																						
	可搬式モニタリング・ポストNo.8																																																																																																																																																						
	可搬式モニタリング・ポストNo.9																																																																																																																																																						
	可搬式モニタリング・ポストNo.10																																																																																																																																																						
	可搬式モニタリング・ポストNo.11																																																																																																																																																						
	可搬式モニタリング・ポストNo.12																																																																																																																																																						
風向(可搬)																																																																																																																																																							
風速(可搬)																																																																																																																																																							
大気安定度(可搬)																																																																																																																																																							
非常用炉心冷却系(ECCS)の状態等確認	A-ADS作動																																																																																																																																																						
	B-ADS作動																																																																																																																																																						
	R C I Cポンプ作動																																																																																																																																																						
	H P C Sポンプ作動																																																																																																																																																						
	A-RHRポンプ作動																																																																																																																																																						
	B-RHRポンプ作動																																																																																																																																																						
	C-RHRポンプ作動																																																																																																																																																						
	RHR MV222-4A 全閉																																																																																																																																																						
	RHR MV222-4B 全閉																																																																																																																																																						
	RHR MV222-5A 全閉																																																																																																																																																						
	RHR MV222-5B 全閉																																																																																																																																																						
	RHR MV222-5C 全閉																																																																																																																																																						
全制御棒全挿入																																																																																																																																																							
A-給水流量																																																																																																																																																							
B-給水流量																																																																																																																																																							
L P C Sポンプ作動																																																																																																																																																							
モードSW運転																																																																																																																																																							
燃料プールの状態確認	燃料プール水位・温度(SA) (使用済燃料貯蔵ラック上端+6710mm)																																																																																																																																																						
	燃料プール水位・温度(SA) (使用済燃料貯蔵ラック上端+5800mm)																																																																																																																																																						
	燃料プール水位・温度(SA) (使用済燃料貯蔵ラック上端+4500mm)																																																																																																																																																						
	燃料プール水位・温度(SA) (使用済燃料貯蔵ラック上端+2000mm)																																																																																																																																																						
	燃料プール水位・温度(SA) (使用済燃料貯蔵ラック上端レベル)																																																																																																																																																						
	燃料プール水位・温度(SA) (使用済燃料貯蔵ラック上端-1000mm)																																																																																																																																																						
	燃料プール水位・温度(SA)(燃料プール温度)																																																																																																																																																						
	燃料プール水位(SA)																																																																																																																																																						
	燃料プールエリア放射線モニタ(低レンジ)(SA)																																																																																																																																																						
	燃料プールエリア放射線モニタ(高レンジ)(SA)																																																																																																																																																						

【設定根拠】 (続)

6号炉 (6/7)

目的	対象パラメータ
使用済燃料プールの状態確認	使用済燃料貯蔵プール水位・温度 (S A広域) (使用済燃料貯蔵プールエリア雰囲気温度)
	使用済燃料貯蔵プール水位・温度 (S A広域)
	使用済燃料貯蔵プール温度(燃料ラック上層 +6750mm)
	使用済燃料貯蔵プール水位・温度 (S A広域)
	使用済燃料貯蔵プール温度(燃料ラック上層 +6500mm)
	使用済燃料貯蔵プール水位・温度 (S A広域)
	使用済燃料貯蔵プール温度(燃料ラック上層 +6000mm)
	使用済燃料貯蔵プール水位・温度 (S A広域)
	使用済燃料貯蔵プール温度(燃料ラック上層 +5500mm)
	使用済燃料貯蔵プール水位・温度 (S A広域)
	使用済燃料貯蔵プール温度(燃料ラック上層 +5000mm)
	使用済燃料貯蔵プール水位・温度 (S A広域)
	使用済燃料貯蔵プール温度(燃料ラック上層 +3900mm)
	使用済燃料貯蔵プール水位・温度 (S A広域)
	使用済燃料貯蔵プール温度(燃料ラック上層 +2000mm)
	使用済燃料貯蔵プール水位・温度 (S A広域)
使用済燃料貯蔵プール温度(燃料ラック上層 +1000mm)	
使用済燃料貯蔵プール水位・温度 (S A広域)	
使用済燃料貯蔵プール温度(燃料ラック上層 +3000mm)	
使用済燃料貯蔵プール水位・温度 (S A広域)	
使用済燃料貯蔵プール温度(燃料ラック上層)	

第59-6-1表 データ表示装置(待避室)で確認できるパラメータ (6/6)

目的	対象パラメータ	SPDSパラメータ	ERSS伝送パラメータ(※1)	バックアップ対象パラメータ
使用済燃料プールの状態確認	使用済燃料プール水位・温度 (S A広域)	○	○	○
	使用済燃料プール温度 (S A)	○	○	○
	使用済燃料プール温度	○	○	○
水素爆発による格納容器の破損防止確認	使用済燃料プールエリア放射線モニタ (高レンジ・低レンジ)	○	○	○
	フィルタ装置出口放射線モニタ (高レンジ・低レンジ)	○	○	○
	フィルタ装置入口水素濃度	○	○	○
	フィルタ装置圧力	○	○	○
水素爆発による原子炉建屋の損傷防止確認	フィルタ装置水位	○	○	○
	フィルタ装置スクラビング水温度	○	○	○
	原子炉建屋水素濃度	○	○	○
非常用炉心冷却系(ECCS)の状態等	静的触媒式水素再結合器動作監視装置	○	○	○
	自動減圧系 A作動	○	○	-
	自動減圧系 B作動	○	○	-
	非常用窒素供給系供給圧力	○	○	○
	非常用窒素供給系高圧窒素ポンベ圧力	○	○	○
	非常用逃がし安全弁駆動系供給圧力	○	○	○
	非常用逃がし安全弁駆動系高圧窒素ポンベ圧力	○	○	○
	原子炉隔離時冷却系ポンプ起動	○	○	-
	高圧炉心スプレイ系ポンプ起動	○	○	-
	高圧炉心スプレイ系注入弁全開	○	○	-
	低圧炉心スプレイ系ポンプ起動	○	○	-
	低圧炉心スプレイ系注入弁全開	○	○	-
	残留熱除去系ポンプA起動	○	○	-
	残留熱除去系ポンプB起動	○	○	-
	残留熱除去系ポンプC起動	○	○	-
	残留熱除去系A注入弁全開	○	○	-
残留熱除去系B注入弁全開	○	○	-	
残留熱除去系C注入弁全開	○	○	-	
全制御棒全挿入	○	○	-	
津波監視	取水ビット水位計	○	○	○
	潮位計	○	○	○

※1: ERSS伝送パラメータは既設SPDSのERSS伝送パラメータ及び既設SPDSから追加したパラメータのうち、プラント状態を把握する主要なパラメータをERSSへ伝送する。

原子力事業者防災業務計画の改定に合わせ、必要に応じ適宜見直していく。

【設定根拠】 (続き)

(6/6)

目的	対象パラメータ
水素爆発による原子炉格納容器の破損防止確認	A-第1ペントフィルタ出口水素濃度
	B-第1ペントフィルタ出口水素濃度
	A-第1ペントフィルタ出口放射線モニタ (高レンジ)
	B-第1ペントフィルタ出口放射線モニタ (高レンジ)
	第1ペントフィルタ出口放射線モニタ (低レンジ)
	A-スクラバ容器圧力
	B-スクラバ容器圧力
	C-スクラバ容器圧力
	D-スクラバ容器圧力
	A1-スクラバ容器水位
	A2-スクラバ容器水位
	B1-スクラバ容器水位
	B2-スクラバ容器水位
	C1-スクラバ容器水位
	C2-スクラバ容器水位
	D1-スクラバ容器水位
D2-スクラバ容器水位	
水素爆発による原子炉建物の損傷防止確認	A-スクラバ容器温度
	B-スクラバ容器温度
	C-スクラバ容器温度
	D-スクラバ容器温度
	A-原子炉建物水素濃度 (燃料取替階)
	B-原子炉建物水素濃度 (燃料取替階)
	原子炉建物水素濃度 (非常用ガス処理系吸込口)
	原子炉建物水素濃度 (所員用エアロック室)
	原子炉建物水素濃度 (SRV補修室)
	原子炉建物水素濃度 (CRD補修室)
原子炉建物水素濃度 (トラス室)	
D-静的触媒式水素処理装置入口温度	
D-静的触媒式水素処理装置出口温度	
S-静的触媒式水素処理装置入口温度	
S-静的触媒式水素処理装置出口温度	

・設備の相違
【柏崎6/7, 東海第二】
島根2号炉は、中央制御室待避室に待避中に継続的にプラントパラメータを監視するために必要なデータの表示が可能な設計とする

【設定根拠】 (続) 6号炉 (7/7)

目的	対象パラメータ
水素発生による格納容器の取壊防止確認	ライオン装置水素濃度 (格納容器出口及び装置水素濃度)
	ライオン装置水素濃度 (ライオン装置出口装置水素濃度)
	ライオン装置出口放射線モニタ (A)
	ライオン装置出口放射線モニタ (B)
	ライオン装置入口圧力
	ライオン装置水位 (A)
	ライオン装置水位 (B)
	ライオン装置スリッパ水位
	ライオン装置冷却システム電圧
	高圧禁止バント系統監視モニタ (A)
水素発生による格納容器の取壊防止確認	高圧禁止バント系統監視モニタ (B)
	原子炉建屋水素濃度 (R/Bボトム水素濃度A)
	原子炉建屋水素濃度 (R/Bボトム水素濃度B)
	原子炉建屋水素濃度 (上部ドライウエル上部層モニタボックス)
	原子炉建屋水素濃度 (上部ドライウエル下部層モニタボックス)
	原子炉建屋水素濃度 (下部ドライウエル上部層モニタボックス)
	原子炉建屋水素濃度 (下部ドライウエル下部層モニタボックス)
	静的乾燥式水素再結合器 動作監視装置 (北側P.A.R.排気温度)
	静的乾燥式水素再結合器 動作監視装置 (北側P.A.R.排気温度)
	静的乾燥式水素再結合器 動作監視装置 (南側P.A.R.排気温度)

・設備の相違
【柏崎 6/7, 東海第二】
 島根 2号炉は、中央制御室待避室に待避中に継続的にプラントパラメータを監視するために必要なデータの表示が可能な設計とする

柏崎刈羽原子力発電所 6 / 7号炉 (2017. 12. 20 版)	東海第二発電所 (2018. 9. 18 版)	島根原子力発電所 2号炉	備考																																													
<p>【設定根拠】 (続) 7号炉 (1 / 7)</p> <table border="1" style="width: 100%; border-collapse: collapse;"> <thead> <tr> <th style="width: 10%;">目的</th> <th>対象パラメータ</th> </tr> </thead> <tbody> <tr><td rowspan="24" style="vertical-align: middle;">炉心反応度の状態確認</td><td>A P R M (平均値)</td></tr> <tr><td>A P R M (A)</td></tr> <tr><td>A P R M (B)</td></tr> <tr><td>A P R M (C)</td></tr> <tr><td>A P R M (D)</td></tr> <tr><td>S R N M (A) 計数率</td></tr> <tr><td>S R N M (B) 計数率</td></tr> <tr><td>S R N M (C) 計数率</td></tr> <tr><td>S R N M (D) 計数率</td></tr> <tr><td>S R N M (E) 計数率</td></tr> <tr><td>S R N M (F) 計数率</td></tr> <tr><td>S R N M (G) 計数率</td></tr> <tr><td>S R N M (H) 計数率</td></tr> <tr><td>S R N M (J) 計数率</td></tr> <tr><td>S R N M (L) 計数率</td></tr> <tr><td>S R N M A 計数率高高</td></tr> <tr><td>S R N M B 計数率高高</td></tr> <tr><td>S R N M C 計数率高高</td></tr> <tr><td>S R N M D 計数率高高</td></tr> <tr><td>S R N M E 計数率高高</td></tr> <tr><td>S R N M F 計数率高高</td></tr> <tr><td>S R N M G 計数率高高</td></tr> <tr><td>S R N M H 計数率高高</td></tr> <tr><td>S R N M J 計数率高高</td></tr> <tr><td>S R N M L 計数率高高</td></tr> <tr><td rowspan="14" style="vertical-align: middle;">炉心冷却の状態確認</td><td>原子炉圧力 A</td></tr> <tr><td>原子炉圧力 (A)</td></tr> <tr><td>原子炉圧力 (B)</td></tr> <tr><td>原子炉圧力 (C)</td></tr> <tr><td>原子炉圧力 (S A)</td></tr> <tr><td>原子炉水位 (W) A</td></tr> <tr><td>原子炉水位 (広帯域) (A)</td></tr> <tr><td>原子炉水位 (広帯域) (C)</td></tr> <tr><td>原子炉水位 (広帯域) (F)</td></tr> <tr><td>原子炉水位 (F)</td></tr> <tr><td>原子炉水位 (燃料域) (A)</td></tr> <tr><td>原子炉水位 (燃料域) (B)</td></tr> <tr><td>原子炉水位 (S A) (ワイド)</td></tr> <tr><td>原子炉水位 (S A) (ナロー)</td></tr> <tr><td>C U W再生熱交換器入口温度</td></tr> <tr><td>S R V開 (C R T)</td></tr> </tbody> </table>	目的	対象パラメータ	炉心反応度の状態確認	A P R M (平均値)	A P R M (A)	A P R M (B)	A P R M (C)	A P R M (D)	S R N M (A) 計数率	S R N M (B) 計数率	S R N M (C) 計数率	S R N M (D) 計数率	S R N M (E) 計数率	S R N M (F) 計数率	S R N M (G) 計数率	S R N M (H) 計数率	S R N M (J) 計数率	S R N M (L) 計数率	S R N M A 計数率高高	S R N M B 計数率高高	S R N M C 計数率高高	S R N M D 計数率高高	S R N M E 計数率高高	S R N M F 計数率高高	S R N M G 計数率高高	S R N M H 計数率高高	S R N M J 計数率高高	S R N M L 計数率高高	炉心冷却の状態確認	原子炉圧力 A	原子炉圧力 (A)	原子炉圧力 (B)	原子炉圧力 (C)	原子炉圧力 (S A)	原子炉水位 (W) A	原子炉水位 (広帯域) (A)	原子炉水位 (広帯域) (C)	原子炉水位 (広帯域) (F)	原子炉水位 (F)	原子炉水位 (燃料域) (A)	原子炉水位 (燃料域) (B)	原子炉水位 (S A) (ワイド)	原子炉水位 (S A) (ナロー)	C U W再生熱交換器入口温度	S R V開 (C R T)			<p>・申請号炉数の相違 【柏崎 6/7】</p>
目的	対象パラメータ																																															
炉心反応度の状態確認	A P R M (平均値)																																															
	A P R M (A)																																															
	A P R M (B)																																															
	A P R M (C)																																															
	A P R M (D)																																															
	S R N M (A) 計数率																																															
	S R N M (B) 計数率																																															
	S R N M (C) 計数率																																															
	S R N M (D) 計数率																																															
	S R N M (E) 計数率																																															
	S R N M (F) 計数率																																															
	S R N M (G) 計数率																																															
	S R N M (H) 計数率																																															
	S R N M (J) 計数率																																															
	S R N M (L) 計数率																																															
	S R N M A 計数率高高																																															
	S R N M B 計数率高高																																															
	S R N M C 計数率高高																																															
	S R N M D 計数率高高																																															
	S R N M E 計数率高高																																															
	S R N M F 計数率高高																																															
	S R N M G 計数率高高																																															
	S R N M H 計数率高高																																															
	S R N M J 計数率高高																																															
S R N M L 計数率高高																																																
炉心冷却の状態確認	原子炉圧力 A																																															
	原子炉圧力 (A)																																															
	原子炉圧力 (B)																																															
	原子炉圧力 (C)																																															
	原子炉圧力 (S A)																																															
	原子炉水位 (W) A																																															
	原子炉水位 (広帯域) (A)																																															
	原子炉水位 (広帯域) (C)																																															
	原子炉水位 (広帯域) (F)																																															
	原子炉水位 (F)																																															
	原子炉水位 (燃料域) (A)																																															
	原子炉水位 (燃料域) (B)																																															
	原子炉水位 (S A) (ワイド)																																															
	原子炉水位 (S A) (ナロー)																																															
C U W再生熱交換器入口温度																																																
S R V開 (C R T)																																																

柏崎刈羽原子力発電所 6 / 7号炉 (2017. 12. 20 版)	東海第二発電所 (2018. 9. 18 版)	島根原子力発電所 2号炉	備考																																																																										
<p>【設定根拠】 (続) 7号炉 (2 / 7)</p> <table border="1" style="width: 100%; border-collapse: collapse;"> <thead> <tr> <th style="width: 10%;">目的</th> <th style="width: 90%;">対象パラメータ</th> </tr> </thead> <tbody> <tr><td></td><td>HPCF (B) 系統流量</td></tr> <tr><td></td><td>HPCF (C) 系統流量</td></tr> <tr><td></td><td>RCIC 系統流量</td></tr> <tr><td></td><td>高圧代替注水系系統流量</td></tr> <tr><td></td><td>RHR (A) 系統流量</td></tr> <tr><td></td><td>RHR (B) 系統流量</td></tr> <tr><td></td><td>RHR (C) 系統流量</td></tr> <tr><td></td><td>残留熱除去系熱交換器 (A) 入口温度</td></tr> <tr><td></td><td>残留熱除去系熱交換器 (B) 入口温度</td></tr> <tr><td></td><td>残留熱除去系熱交換器 (C) 入口温度</td></tr> <tr><td></td><td>残留熱除去系熱交換器 (A) 出口温度</td></tr> <tr><td></td><td>残留熱除去系熱交換器 (B) 出口温度</td></tr> <tr><td></td><td>残留熱除去系熱交換器 (C) 出口温度</td></tr> <tr><td></td><td>残留熱除去系熱交換器 (A) 入口冷却水流量</td></tr> <tr><td></td><td>残留熱除去系熱交換器 (B) 入口冷却水流量</td></tr> <tr><td></td><td>残留熱除去系熱交換器 (C) 入口冷却水流量</td></tr> <tr><td>炉心冷却の状態確認</td><td>原子炉補機冷却水系 (A) 系統流量</td></tr> <tr><td></td><td>原子炉補機冷却水系 (B) 系統流量</td></tr> <tr><td></td><td>原子炉補機冷却水系 (C) 系統流量</td></tr> <tr><td></td><td>6. 9 kV 7A1 母線電圧</td></tr> <tr><td></td><td>6. 9 kV 7A2 母線電圧</td></tr> <tr><td></td><td>6. 9 kV 7B1 母線電圧</td></tr> <tr><td></td><td>6. 9 kV 7B2 母線電圧</td></tr> <tr><td></td><td>6. 9 kV 6SA1 母線電圧</td></tr> <tr><td></td><td>6. 9 kV 6SA2 母線電圧</td></tr> <tr><td></td><td>6. 9 kV 6SB1 母線電圧</td></tr> <tr><td></td><td>6. 9 kV 6SB2 母線電圧</td></tr> <tr><td></td><td>6. 9 kV 7C 母線電圧</td></tr> <tr><td></td><td>6. 9 kV 7D 母線電圧</td></tr> <tr><td></td><td>6. 9 kV 7E 母線電圧</td></tr> <tr><td></td><td>M/C 7C D/G受電遮断器閉</td></tr> <tr><td></td><td>M/C 7D D/G受電遮断器閉</td></tr> <tr><td></td><td>M/C 7E D/G受電遮断器閉</td></tr> <tr><td></td><td>原子炉圧力容器温度 (RPV下鏡上部温度)</td></tr> <tr><td></td><td>復水補給水系流量 (原子炉圧力容器) (RHR (A) 注入配管流量)</td></tr> <tr><td></td><td>復水貯蔵槽水位 (SA)</td></tr> </tbody> </table>	目的	対象パラメータ		HPCF (B) 系統流量		HPCF (C) 系統流量		RCIC 系統流量		高圧代替注水系系統流量		RHR (A) 系統流量		RHR (B) 系統流量		RHR (C) 系統流量		残留熱除去系熱交換器 (A) 入口温度		残留熱除去系熱交換器 (B) 入口温度		残留熱除去系熱交換器 (C) 入口温度		残留熱除去系熱交換器 (A) 出口温度		残留熱除去系熱交換器 (B) 出口温度		残留熱除去系熱交換器 (C) 出口温度		残留熱除去系熱交換器 (A) 入口冷却水流量		残留熱除去系熱交換器 (B) 入口冷却水流量		残留熱除去系熱交換器 (C) 入口冷却水流量	炉心冷却の状態確認	原子炉補機冷却水系 (A) 系統流量		原子炉補機冷却水系 (B) 系統流量		原子炉補機冷却水系 (C) 系統流量		6. 9 kV 7A1 母線電圧		6. 9 kV 7A2 母線電圧		6. 9 kV 7B1 母線電圧		6. 9 kV 7B2 母線電圧		6. 9 kV 6SA1 母線電圧		6. 9 kV 6SA2 母線電圧		6. 9 kV 6SB1 母線電圧		6. 9 kV 6SB2 母線電圧		6. 9 kV 7C 母線電圧		6. 9 kV 7D 母線電圧		6. 9 kV 7E 母線電圧		M/C 7C D/G受電遮断器閉		M/C 7D D/G受電遮断器閉		M/C 7E D/G受電遮断器閉		原子炉圧力容器温度 (RPV下鏡上部温度)		復水補給水系流量 (原子炉圧力容器) (RHR (A) 注入配管流量)		復水貯蔵槽水位 (SA)			<p>・申請号炉数の相違 【柏崎 6/7】</p>
目的	対象パラメータ																																																																												
	HPCF (B) 系統流量																																																																												
	HPCF (C) 系統流量																																																																												
	RCIC 系統流量																																																																												
	高圧代替注水系系統流量																																																																												
	RHR (A) 系統流量																																																																												
	RHR (B) 系統流量																																																																												
	RHR (C) 系統流量																																																																												
	残留熱除去系熱交換器 (A) 入口温度																																																																												
	残留熱除去系熱交換器 (B) 入口温度																																																																												
	残留熱除去系熱交換器 (C) 入口温度																																																																												
	残留熱除去系熱交換器 (A) 出口温度																																																																												
	残留熱除去系熱交換器 (B) 出口温度																																																																												
	残留熱除去系熱交換器 (C) 出口温度																																																																												
	残留熱除去系熱交換器 (A) 入口冷却水流量																																																																												
	残留熱除去系熱交換器 (B) 入口冷却水流量																																																																												
	残留熱除去系熱交換器 (C) 入口冷却水流量																																																																												
炉心冷却の状態確認	原子炉補機冷却水系 (A) 系統流量																																																																												
	原子炉補機冷却水系 (B) 系統流量																																																																												
	原子炉補機冷却水系 (C) 系統流量																																																																												
	6. 9 kV 7A1 母線電圧																																																																												
	6. 9 kV 7A2 母線電圧																																																																												
	6. 9 kV 7B1 母線電圧																																																																												
	6. 9 kV 7B2 母線電圧																																																																												
	6. 9 kV 6SA1 母線電圧																																																																												
	6. 9 kV 6SA2 母線電圧																																																																												
	6. 9 kV 6SB1 母線電圧																																																																												
	6. 9 kV 6SB2 母線電圧																																																																												
	6. 9 kV 7C 母線電圧																																																																												
	6. 9 kV 7D 母線電圧																																																																												
	6. 9 kV 7E 母線電圧																																																																												
	M/C 7C D/G受電遮断器閉																																																																												
	M/C 7D D/G受電遮断器閉																																																																												
	M/C 7E D/G受電遮断器閉																																																																												
	原子炉圧力容器温度 (RPV下鏡上部温度)																																																																												
	復水補給水系流量 (原子炉圧力容器) (RHR (A) 注入配管流量)																																																																												
	復水貯蔵槽水位 (SA)																																																																												

柏崎刈羽原子力発電所 6 / 7号炉 (2017. 12. 20 版)	東海第二発電所 (2018. 9. 18 版)	島根原子力発電所 2号炉	備考																																																							
<p>【設定根拠】 (給)</p> <p style="text-align: right;">7号炉 (3 / 7)</p> <table border="1" data-bbox="172 254 905 1255"> <thead> <tr> <th data-bbox="172 317 270 380">目的</th> <th data-bbox="270 317 905 380">対象パラメータ</th> </tr> </thead> <tbody> <tr><td></td><td>格納容器内蒸気放射線モニタ (A) D / W</td></tr> <tr><td></td><td>格納容器内蒸気放射線モニタ (B) D / W</td></tr> <tr><td></td><td>格納容器内蒸気放射線モニタ (A) S / C</td></tr> <tr><td></td><td>格納容器内蒸気放射線モニタ (B) S / C</td></tr> <tr><td></td><td>ドライウェル圧力 (W)</td></tr> <tr><td></td><td>格納容器内圧力 (D / W)</td></tr> <tr><td></td><td>S / C圧力 (最大値)</td></tr> <tr><td></td><td>格納容器内圧力 (S / C)</td></tr> <tr><td></td><td>D / W温度 (最大値)</td></tr> <tr><td></td><td>S / P水温度最大値</td></tr> <tr><td></td><td>S / P水位 (W) (最大値)</td></tr> <tr><td></td><td>サブコヒーレンス・チェンバ・プール水位</td></tr> <tr><td></td><td>サブコヒーレンス・チェンバ気体温度</td></tr> <tr><td></td><td>サブコヒーレンス・チェンバ・プール水温度 (中間上部)</td></tr> <tr><td></td><td>サブコヒーレンス・チェンバ・プール水温度 (中間下部)</td></tr> <tr><td></td><td>サブコヒーレンス・チェンバ・プール水温度 (下部)</td></tr> <tr><td rowspan="18">格納容器内の 状態確認</td><td>格納容器内水温度 (A)</td></tr> <tr><td>格納容器内水温度 (B)</td></tr> <tr><td>格納容器内水温度 (S A) (D / W)</td></tr> <tr><td>格納容器内水温度 (S A) (S / C)</td></tr> <tr><td>格納容器内酸素濃度 (A)</td></tr> <tr><td>格納容器内酸素濃度 (B)</td></tr> <tr><td>CAMS (A) D / W測定中</td></tr> <tr><td>CAMS (D) D / W測定中</td></tr> <tr><td>CAMS (A) S / C測定中</td></tr> <tr><td>CAMS (B) S / C測定中</td></tr> <tr><td>RHR (A) 系統流量</td></tr> <tr><td>RHR (B) 系統流量</td></tr> <tr><td>RHR (C) 系統流量</td></tr> <tr><td>PCVスプレイ弁 (B) 全閉</td></tr> <tr><td>PCVスプレイ弁 (C) 全閉</td></tr> <tr><td>残留熱除去ポンプ (A) 吐出圧力</td></tr> <tr><td>残留熱除去ポンプ (B) 吐出圧力</td></tr> <tr><td>残留熱除去ポンプ (C) 吐出圧力</td></tr> <tr><td>ドライウェル蒸気温度 (上部D / W内蒸気温度)</td></tr> <tr><td>ドライウェル蒸気温度 (下部D / W内蒸気温度)</td></tr> </tbody> </table>	目的	対象パラメータ		格納容器内蒸気放射線モニタ (A) D / W		格納容器内蒸気放射線モニタ (B) D / W		格納容器内蒸気放射線モニタ (A) S / C		格納容器内蒸気放射線モニタ (B) S / C		ドライウェル圧力 (W)		格納容器内圧力 (D / W)		S / C圧力 (最大値)		格納容器内圧力 (S / C)		D / W温度 (最大値)		S / P水温度最大値		S / P水位 (W) (最大値)		サブコヒーレンス・チェンバ・プール水位		サブコヒーレンス・チェンバ気体温度		サブコヒーレンス・チェンバ・プール水温度 (中間上部)		サブコヒーレンス・チェンバ・プール水温度 (中間下部)		サブコヒーレンス・チェンバ・プール水温度 (下部)	格納容器内の 状態確認	格納容器内水温度 (A)	格納容器内水温度 (B)	格納容器内水温度 (S A) (D / W)	格納容器内水温度 (S A) (S / C)	格納容器内酸素濃度 (A)	格納容器内酸素濃度 (B)	CAMS (A) D / W測定中	CAMS (D) D / W測定中	CAMS (A) S / C測定中	CAMS (B) S / C測定中	RHR (A) 系統流量	RHR (B) 系統流量	RHR (C) 系統流量	PCVスプレイ弁 (B) 全閉	PCVスプレイ弁 (C) 全閉	残留熱除去ポンプ (A) 吐出圧力	残留熱除去ポンプ (B) 吐出圧力	残留熱除去ポンプ (C) 吐出圧力	ドライウェル蒸気温度 (上部D / W内蒸気温度)	ドライウェル蒸気温度 (下部D / W内蒸気温度)			<p>・申請号炉数の相違 【柏崎 6/7】</p>
目的	対象パラメータ																																																									
	格納容器内蒸気放射線モニタ (A) D / W																																																									
	格納容器内蒸気放射線モニタ (B) D / W																																																									
	格納容器内蒸気放射線モニタ (A) S / C																																																									
	格納容器内蒸気放射線モニタ (B) S / C																																																									
	ドライウェル圧力 (W)																																																									
	格納容器内圧力 (D / W)																																																									
	S / C圧力 (最大値)																																																									
	格納容器内圧力 (S / C)																																																									
	D / W温度 (最大値)																																																									
	S / P水温度最大値																																																									
	S / P水位 (W) (最大値)																																																									
	サブコヒーレンス・チェンバ・プール水位																																																									
	サブコヒーレンス・チェンバ気体温度																																																									
	サブコヒーレンス・チェンバ・プール水温度 (中間上部)																																																									
	サブコヒーレンス・チェンバ・プール水温度 (中間下部)																																																									
	サブコヒーレンス・チェンバ・プール水温度 (下部)																																																									
格納容器内の 状態確認	格納容器内水温度 (A)																																																									
	格納容器内水温度 (B)																																																									
	格納容器内水温度 (S A) (D / W)																																																									
	格納容器内水温度 (S A) (S / C)																																																									
	格納容器内酸素濃度 (A)																																																									
	格納容器内酸素濃度 (B)																																																									
	CAMS (A) D / W測定中																																																									
	CAMS (D) D / W測定中																																																									
	CAMS (A) S / C測定中																																																									
	CAMS (B) S / C測定中																																																									
	RHR (A) 系統流量																																																									
	RHR (B) 系統流量																																																									
	RHR (C) 系統流量																																																									
	PCVスプレイ弁 (B) 全閉																																																									
	PCVスプレイ弁 (C) 全閉																																																									
	残留熱除去ポンプ (A) 吐出圧力																																																									
	残留熱除去ポンプ (B) 吐出圧力																																																									
	残留熱除去ポンプ (C) 吐出圧力																																																									
ドライウェル蒸気温度 (上部D / W内蒸気温度)																																																										
ドライウェル蒸気温度 (下部D / W内蒸気温度)																																																										

柏崎刈羽原子力発電所 6 / 7号炉 (2017. 12. 20 版)	東海第二発電所 (2018. 9. 18 版)	島根原子力発電所 2号炉	備考																																							
<p>【設定根拠】 (続) 7号炉 (4 / 7)</p> <table border="1" style="width: 100%; border-collapse: collapse;"> <thead> <tr> <th style="width: 10%;">目的</th> <th>対象パラメータ</th> </tr> </thead> <tbody> <tr> <td rowspan="10">格納容器内の 状態確認</td> <td>復水補給水系流量 (原子炉格納容器) (RHR (B) 注入配管流量)</td> </tr> <tr> <td>復水移送ポンプ (A) 吐出圧力</td> </tr> <tr> <td>復水移送ポンプ (B) 吐出圧力</td> </tr> <tr> <td>復水移送ポンプ (C) 吐出圧力</td> </tr> <tr> <td>復水補給水系温度 (代替循環冷却)</td> </tr> <tr> <td>格納容器下部水位 (D/W下部水位 (3m))</td> </tr> <tr> <td>格納容器下部水位 (D/W下部水位 (2m))</td> </tr> <tr> <td>格納容器下部水位 (D/W下部水位 (1m))</td> </tr> <tr> <td>復水補給水系流量 (原子炉格納容器) (下部D/W注水流量)</td> </tr> <tr> <td>排気筒放射線モニタ (IC) 最大値</td> </tr> <tr> <td rowspan="18">放射能隔離の 状態確認</td> <td>排気筒放射線モニタ (SCIN) A</td> </tr> <tr> <td>排気筒放射線モニタ (SCIN) B</td> </tr> <tr> <td>区分I主蒸気管放射能高高</td> </tr> <tr> <td>区分II主蒸気管放射能高高</td> </tr> <tr> <td>区分III主蒸気管放射能高高</td> </tr> <tr> <td>区分IV主蒸気管放射能高高</td> </tr> <tr> <td>P C I S 隔離 内側</td> </tr> <tr> <td>P C I S 隔離 外側</td> </tr> <tr> <td>主蒸気内側隔離弁 全弁全閉</td> </tr> <tr> <td>主蒸気内側隔離弁 (A) 全閉</td> </tr> <tr> <td>主蒸気内側隔離弁 (B) 全閉</td> </tr> <tr> <td>主蒸気内側隔離弁 (C) 全閉</td> </tr> <tr> <td>主蒸気内側隔離弁 (D) 全閉</td> </tr> <tr> <td>主蒸気外側隔離弁 全弁全閉</td> </tr> <tr> <td>主蒸気外側隔離弁 (A) 全閉</td> </tr> <tr> <td>主蒸気外側隔離弁 (B) 全閉</td> </tr> <tr> <td>主蒸気外側隔離弁 (C) 全閉</td> </tr> <tr> <td>主蒸気外側隔離弁 (D) 全閉</td> </tr> <tr> <td rowspan="4">環境の情報確 認</td> <td>S G T S (A) 作動</td> </tr> <tr> <td>S G T S (B) 作動</td> </tr> <tr> <td>S G T S 放射線モニタ (IC) 最大値</td> </tr> <tr> <td>S G T S 排ガス放射線モニタ (SCIN) A</td> </tr> <tr> <td></td> <td>S G T S 排ガス放射線モニタ (SCIN) B</td> </tr> </tbody> </table>	目的	対象パラメータ	格納容器内の 状態確認	復水補給水系流量 (原子炉格納容器) (RHR (B) 注入配管流量)	復水移送ポンプ (A) 吐出圧力	復水移送ポンプ (B) 吐出圧力	復水移送ポンプ (C) 吐出圧力	復水補給水系温度 (代替循環冷却)	格納容器下部水位 (D/W下部水位 (3m))	格納容器下部水位 (D/W下部水位 (2m))	格納容器下部水位 (D/W下部水位 (1m))	復水補給水系流量 (原子炉格納容器) (下部D/W注水流量)	排気筒放射線モニタ (IC) 最大値	放射能隔離の 状態確認	排気筒放射線モニタ (SCIN) A	排気筒放射線モニタ (SCIN) B	区分I主蒸気管放射能高高	区分II主蒸気管放射能高高	区分III主蒸気管放射能高高	区分IV主蒸気管放射能高高	P C I S 隔離 内側	P C I S 隔離 外側	主蒸気内側隔離弁 全弁全閉	主蒸気内側隔離弁 (A) 全閉	主蒸気内側隔離弁 (B) 全閉	主蒸気内側隔離弁 (C) 全閉	主蒸気内側隔離弁 (D) 全閉	主蒸気外側隔離弁 全弁全閉	主蒸気外側隔離弁 (A) 全閉	主蒸気外側隔離弁 (B) 全閉	主蒸気外側隔離弁 (C) 全閉	主蒸気外側隔離弁 (D) 全閉	環境の情報確 認	S G T S (A) 作動	S G T S (B) 作動	S G T S 放射線モニタ (IC) 最大値	S G T S 排ガス放射線モニタ (SCIN) A		S G T S 排ガス放射線モニタ (SCIN) B			<p>・申請号炉数の相違 【柏崎 6/7】</p>
目的	対象パラメータ																																									
格納容器内の 状態確認	復水補給水系流量 (原子炉格納容器) (RHR (B) 注入配管流量)																																									
	復水移送ポンプ (A) 吐出圧力																																									
	復水移送ポンプ (B) 吐出圧力																																									
	復水移送ポンプ (C) 吐出圧力																																									
	復水補給水系温度 (代替循環冷却)																																									
	格納容器下部水位 (D/W下部水位 (3m))																																									
	格納容器下部水位 (D/W下部水位 (2m))																																									
	格納容器下部水位 (D/W下部水位 (1m))																																									
	復水補給水系流量 (原子炉格納容器) (下部D/W注水流量)																																									
	排気筒放射線モニタ (IC) 最大値																																									
放射能隔離の 状態確認	排気筒放射線モニタ (SCIN) A																																									
	排気筒放射線モニタ (SCIN) B																																									
	区分I主蒸気管放射能高高																																									
	区分II主蒸気管放射能高高																																									
	区分III主蒸気管放射能高高																																									
	区分IV主蒸気管放射能高高																																									
	P C I S 隔離 内側																																									
	P C I S 隔離 外側																																									
	主蒸気内側隔離弁 全弁全閉																																									
	主蒸気内側隔離弁 (A) 全閉																																									
	主蒸気内側隔離弁 (B) 全閉																																									
	主蒸気内側隔離弁 (C) 全閉																																									
	主蒸気内側隔離弁 (D) 全閉																																									
	主蒸気外側隔離弁 全弁全閉																																									
	主蒸気外側隔離弁 (A) 全閉																																									
	主蒸気外側隔離弁 (B) 全閉																																									
	主蒸気外側隔離弁 (C) 全閉																																									
	主蒸気外側隔離弁 (D) 全閉																																									
環境の情報確 認	S G T S (A) 作動																																									
	S G T S (B) 作動																																									
	S G T S 放射線モニタ (IC) 最大値																																									
	S G T S 排ガス放射線モニタ (SCIN) A																																									
	S G T S 排ガス放射線モニタ (SCIN) B																																									

柏崎刈羽原子力発電所 6 / 7号炉 (2017. 12. 20 版)	東海第二発電所 (2018. 9. 18 版)	島根原子力発電所 2号炉	備考																																					
<p>【設定根拠】 (続)</p> <p style="text-align: right;">7号炉 (3 / 7)</p> <table border="1" data-bbox="184 323 899 1140"> <thead> <tr> <th data-bbox="189 327 290 386">目的</th> <th data-bbox="290 327 893 386">対象パラメータ</th> </tr> </thead> <tbody> <tr> <td data-bbox="189 386 290 680" rowspan="14">非常用炉心冷却系 (RCCS) の状態等</td> <td data-bbox="290 386 893 415">ADS-A 作動</td> </tr> <tr> <td data-bbox="290 415 893 445">ADS-B 作動</td> </tr> <tr> <td data-bbox="290 445 893 474">RCCS移動機器 (CRT)</td> </tr> <tr> <td data-bbox="290 474 893 504">HPCFポンプ (B) 起動</td> </tr> <tr> <td data-bbox="290 504 893 533">HPCFポンプ (C) 起動</td> </tr> <tr> <td data-bbox="290 533 893 562">RHRポンプ (A) 起動</td> </tr> <tr> <td data-bbox="290 562 893 592">RHRポンプ (B) 起動</td> </tr> <tr> <td data-bbox="290 592 893 621">RHRポンプ (C) 起動</td> </tr> <tr> <td data-bbox="290 621 893 651">RHR注入弁 (A) 全開</td> </tr> <tr> <td data-bbox="290 651 893 680">RHR注入弁 (D) 全開</td> </tr> <tr> <td data-bbox="290 680 893 709">RHR注入弁 (C) 全開</td> </tr> <tr> <td data-bbox="290 709 893 739">全減圧弁挿入</td> </tr> <tr> <td data-bbox="290 739 893 768">全減圧弁</td> </tr> <tr> <td data-bbox="189 768 290 1140" rowspan="14">使用済燃料プールの状態確認</td> <td data-bbox="290 768 893 798">使用済燃料貯蔵プール水位・温度 (S/A)</td> </tr> <tr> <td data-bbox="290 798 893 827">(使用済燃料貯蔵プールコア雰囲気温度)</td> </tr> <tr> <td data-bbox="290 827 893 856">使用済燃料貯蔵プール水位・温度 (S/A)</td> </tr> <tr> <td data-bbox="290 856 893 886">(使用済燃料貯蔵プール温度 (燃料ラック上層+600mm))</td> </tr> <tr> <td data-bbox="290 886 893 915">使用済燃料貯蔵プール水位・温度 (S/A)</td> </tr> <tr> <td data-bbox="290 915 893 945">(使用済燃料貯蔵プール温度 (燃料ラック上層+500mm))</td> </tr> <tr> <td data-bbox="290 945 893 974">使用済燃料貯蔵プール水位・温度 (S/A)</td> </tr> <tr> <td data-bbox="290 974 893 1003">(使用済燃料貯蔵プール温度 (燃料ラック上層+100mm))</td> </tr> <tr> <td data-bbox="290 1003 893 1033">使用済燃料貯蔵プール水位・温度 (S/A)</td> </tr> <tr> <td data-bbox="290 1033 893 1062">(使用済燃料貯蔵プール温度 (燃料ラック上層+200mm))</td> </tr> <tr> <td data-bbox="290 1062 893 1092">使用済燃料貯蔵プール水位・温度 (S/A)</td> </tr> <tr> <td data-bbox="290 1092 893 1121">(使用済燃料貯蔵プール温度 (燃料ラック上層+200mm))</td> </tr> <tr> <td data-bbox="290 1121 893 1150">使用済燃料貯蔵プール水位・温度 (S/A)</td> </tr> <tr> <td data-bbox="290 1150 893 1180">(使用済燃料貯蔵プール温度 (燃料ラック上層+100mm))</td> </tr> <tr> <td data-bbox="290 1180 893 1209">使用済燃料貯蔵プール水位・温度 (S/A)</td> </tr> <tr> <td data-bbox="290 1209 893 1239">(使用済燃料貯蔵プール温度 (燃料ラック上層))</td> </tr> <tr> <td data-bbox="290 1239 893 1268">使用済燃料貯蔵プール水位・温度 (S/A)</td> </tr> <tr> <td data-bbox="290 1268 893 1297">(使用済燃料貯蔵プール温度 (燃料ラック上層+100mm))</td> </tr> <tr> <td data-bbox="290 1297 893 1327">使用済燃料貯蔵プールの放射線モニタ (低レンジ)</td> </tr> <tr> <td data-bbox="290 1327 893 1356">使用済燃料貯蔵プールの放射線モニタ (高レンジ)</td> </tr> </tbody> </table>	目的	対象パラメータ	非常用炉心冷却系 (RCCS) の状態等	ADS-A 作動	ADS-B 作動	RCCS移動機器 (CRT)	HPCFポンプ (B) 起動	HPCFポンプ (C) 起動	RHRポンプ (A) 起動	RHRポンプ (B) 起動	RHRポンプ (C) 起動	RHR注入弁 (A) 全開	RHR注入弁 (D) 全開	RHR注入弁 (C) 全開	全減圧弁挿入	全減圧弁	使用済燃料プールの状態確認	使用済燃料貯蔵プール水位・温度 (S/A)	(使用済燃料貯蔵プールコア雰囲気温度)	使用済燃料貯蔵プール水位・温度 (S/A)	(使用済燃料貯蔵プール温度 (燃料ラック上層+600mm))	使用済燃料貯蔵プール水位・温度 (S/A)	(使用済燃料貯蔵プール温度 (燃料ラック上層+500mm))	使用済燃料貯蔵プール水位・温度 (S/A)	(使用済燃料貯蔵プール温度 (燃料ラック上層+100mm))	使用済燃料貯蔵プール水位・温度 (S/A)	(使用済燃料貯蔵プール温度 (燃料ラック上層+200mm))	使用済燃料貯蔵プール水位・温度 (S/A)	(使用済燃料貯蔵プール温度 (燃料ラック上層+200mm))	使用済燃料貯蔵プール水位・温度 (S/A)	(使用済燃料貯蔵プール温度 (燃料ラック上層+100mm))	使用済燃料貯蔵プール水位・温度 (S/A)	(使用済燃料貯蔵プール温度 (燃料ラック上層))	使用済燃料貯蔵プール水位・温度 (S/A)	(使用済燃料貯蔵プール温度 (燃料ラック上層+100mm))	使用済燃料貯蔵プールの放射線モニタ (低レンジ)	使用済燃料貯蔵プールの放射線モニタ (高レンジ)			<p>・申請号炉数の相違 【柏崎 6/7】</p>
目的	対象パラメータ																																							
非常用炉心冷却系 (RCCS) の状態等	ADS-A 作動																																							
	ADS-B 作動																																							
	RCCS移動機器 (CRT)																																							
	HPCFポンプ (B) 起動																																							
	HPCFポンプ (C) 起動																																							
	RHRポンプ (A) 起動																																							
	RHRポンプ (B) 起動																																							
	RHRポンプ (C) 起動																																							
	RHR注入弁 (A) 全開																																							
	RHR注入弁 (D) 全開																																							
	RHR注入弁 (C) 全開																																							
	全減圧弁挿入																																							
	全減圧弁																																							
	使用済燃料プールの状態確認	使用済燃料貯蔵プール水位・温度 (S/A)																																						
(使用済燃料貯蔵プールコア雰囲気温度)																																								
使用済燃料貯蔵プール水位・温度 (S/A)																																								
(使用済燃料貯蔵プール温度 (燃料ラック上層+600mm))																																								
使用済燃料貯蔵プール水位・温度 (S/A)																																								
(使用済燃料貯蔵プール温度 (燃料ラック上層+500mm))																																								
使用済燃料貯蔵プール水位・温度 (S/A)																																								
(使用済燃料貯蔵プール温度 (燃料ラック上層+100mm))																																								
使用済燃料貯蔵プール水位・温度 (S/A)																																								
(使用済燃料貯蔵プール温度 (燃料ラック上層+200mm))																																								
使用済燃料貯蔵プール水位・温度 (S/A)																																								
(使用済燃料貯蔵プール温度 (燃料ラック上層+200mm))																																								
使用済燃料貯蔵プール水位・温度 (S/A)																																								
(使用済燃料貯蔵プール温度 (燃料ラック上層+100mm))																																								
使用済燃料貯蔵プール水位・温度 (S/A)																																								
(使用済燃料貯蔵プール温度 (燃料ラック上層))																																								
使用済燃料貯蔵プール水位・温度 (S/A)																																								
(使用済燃料貯蔵プール温度 (燃料ラック上層+100mm))																																								
使用済燃料貯蔵プールの放射線モニタ (低レンジ)																																								
使用済燃料貯蔵プールの放射線モニタ (高レンジ)																																								

柏崎刈羽原子力発電所 6 / 7号炉 (2017. 12. 20 版)	東海第二発電所 (2018. 9. 18 版)	島根原子力発電所 2号炉	備考																	
<p>【設定根拠】 (純) 7号炉 (6 / 7)</p> <table border="1" data-bbox="166 331 896 1083"> <thead> <tr> <th data-bbox="166 331 270 401">目的</th> <th data-bbox="270 331 896 401">対象パラメータ</th> </tr> </thead> <tbody> <tr> <td data-bbox="166 401 270 1083" rowspan="16">使用済燃料プールの状態確認</td> <td data-bbox="270 401 896 453">使用済燃料貯蔵プール水位・温度 (S A 広域) (使用済燃料貯蔵プールエリア雰囲気温度)</td> </tr> <tr> <td data-bbox="270 453 896 506">使用済燃料貯蔵プール水位・温度 (S A 広域) (使用済燃料貯蔵プール温度(燃料ラック上端 +6750mm))</td> </tr> <tr> <td data-bbox="270 506 896 558">使用済燃料貯蔵プール水位・温度 (S A 広域) (使用済燃料貯蔵プール温度(燃料ラック上端 +6500mm))</td> </tr> <tr> <td data-bbox="270 558 896 611">使用済燃料貯蔵プール水位・温度 (S A 広域) (使用済燃料貯蔵プール温度(燃料ラック上端 +6000mm))</td> </tr> <tr> <td data-bbox="270 611 896 663">使用済燃料貯蔵プール水位・温度 (S A 広域) (使用済燃料貯蔵プール温度(燃料ラック上端 +5500mm))</td> </tr> <tr> <td data-bbox="270 663 896 716">使用済燃料貯蔵プール水位・温度 (S A 広域) (使用済燃料貯蔵プール温度(燃料ラック上端 +5000mm))</td> </tr> <tr> <td data-bbox="270 716 896 768">使用済燃料貯蔵プール水位・温度 (S A 広域) (使用済燃料貯蔵プール温度(燃料ラック上端 +4000mm))</td> </tr> <tr> <td data-bbox="270 768 896 821">使用済燃料貯蔵プール水位・温度 (S A 広域) (使用済燃料貯蔵プール温度(燃料ラック上端 +3000mm))</td> </tr> <tr> <td data-bbox="270 821 896 873">使用済燃料貯蔵プール水位・温度 (S A 広域) (使用済燃料貯蔵プール温度(燃料ラック上端 +2000mm))</td> </tr> <tr> <td data-bbox="270 873 896 926">使用済燃料貯蔵プール水位・温度 (S A 広域) (使用済燃料貯蔵プール温度(燃料ラック上端 +1000mm))</td> </tr> <tr> <td data-bbox="270 926 896 978">使用済燃料貯蔵プール水位・温度 (S A 広域) (使用済燃料貯蔵プール温度(燃料ラック上端))</td> </tr> <tr> <td data-bbox="270 978 896 1031">使用済燃料貯蔵プール水位・温度 (S A 広域) (使用済燃料貯蔵プール温度(燃料ラック上端 -1000mm))</td> </tr> <tr> <td data-bbox="270 1031 896 1083">使用済燃料貯蔵プール水位・温度 (S A 広域) (使用済燃料貯蔵プール温度(燃料ラック上端 -3000mm))</td> </tr> <tr> <td data-bbox="270 1083 896 1136">使用済燃料貯蔵プール水位・温度 (S A 広域) (使用済燃料貯蔵プール温度(プール底部付近))</td> </tr> </tbody> </table>	目的	対象パラメータ	使用済燃料プールの状態確認	使用済燃料貯蔵プール水位・温度 (S A 広域) (使用済燃料貯蔵プールエリア雰囲気温度)	使用済燃料貯蔵プール水位・温度 (S A 広域) (使用済燃料貯蔵プール温度(燃料ラック上端 +6750mm))	使用済燃料貯蔵プール水位・温度 (S A 広域) (使用済燃料貯蔵プール温度(燃料ラック上端 +6500mm))	使用済燃料貯蔵プール水位・温度 (S A 広域) (使用済燃料貯蔵プール温度(燃料ラック上端 +6000mm))	使用済燃料貯蔵プール水位・温度 (S A 広域) (使用済燃料貯蔵プール温度(燃料ラック上端 +5500mm))	使用済燃料貯蔵プール水位・温度 (S A 広域) (使用済燃料貯蔵プール温度(燃料ラック上端 +5000mm))	使用済燃料貯蔵プール水位・温度 (S A 広域) (使用済燃料貯蔵プール温度(燃料ラック上端 +4000mm))	使用済燃料貯蔵プール水位・温度 (S A 広域) (使用済燃料貯蔵プール温度(燃料ラック上端 +3000mm))	使用済燃料貯蔵プール水位・温度 (S A 広域) (使用済燃料貯蔵プール温度(燃料ラック上端 +2000mm))	使用済燃料貯蔵プール水位・温度 (S A 広域) (使用済燃料貯蔵プール温度(燃料ラック上端 +1000mm))	使用済燃料貯蔵プール水位・温度 (S A 広域) (使用済燃料貯蔵プール温度(燃料ラック上端))	使用済燃料貯蔵プール水位・温度 (S A 広域) (使用済燃料貯蔵プール温度(燃料ラック上端 -1000mm))	使用済燃料貯蔵プール水位・温度 (S A 広域) (使用済燃料貯蔵プール温度(燃料ラック上端 -3000mm))	使用済燃料貯蔵プール水位・温度 (S A 広域) (使用済燃料貯蔵プール温度(プール底部付近))			<p>・申請号炉数の相違 【柏崎 6/7】</p>
目的	対象パラメータ																			
使用済燃料プールの状態確認	使用済燃料貯蔵プール水位・温度 (S A 広域) (使用済燃料貯蔵プールエリア雰囲気温度)																			
	使用済燃料貯蔵プール水位・温度 (S A 広域) (使用済燃料貯蔵プール温度(燃料ラック上端 +6750mm))																			
	使用済燃料貯蔵プール水位・温度 (S A 広域) (使用済燃料貯蔵プール温度(燃料ラック上端 +6500mm))																			
	使用済燃料貯蔵プール水位・温度 (S A 広域) (使用済燃料貯蔵プール温度(燃料ラック上端 +6000mm))																			
	使用済燃料貯蔵プール水位・温度 (S A 広域) (使用済燃料貯蔵プール温度(燃料ラック上端 +5500mm))																			
	使用済燃料貯蔵プール水位・温度 (S A 広域) (使用済燃料貯蔵プール温度(燃料ラック上端 +5000mm))																			
	使用済燃料貯蔵プール水位・温度 (S A 広域) (使用済燃料貯蔵プール温度(燃料ラック上端 +4000mm))																			
	使用済燃料貯蔵プール水位・温度 (S A 広域) (使用済燃料貯蔵プール温度(燃料ラック上端 +3000mm))																			
	使用済燃料貯蔵プール水位・温度 (S A 広域) (使用済燃料貯蔵プール温度(燃料ラック上端 +2000mm))																			
	使用済燃料貯蔵プール水位・温度 (S A 広域) (使用済燃料貯蔵プール温度(燃料ラック上端 +1000mm))																			
	使用済燃料貯蔵プール水位・温度 (S A 広域) (使用済燃料貯蔵プール温度(燃料ラック上端))																			
	使用済燃料貯蔵プール水位・温度 (S A 広域) (使用済燃料貯蔵プール温度(燃料ラック上端 -1000mm))																			
	使用済燃料貯蔵プール水位・温度 (S A 広域) (使用済燃料貯蔵プール温度(燃料ラック上端 -3000mm))																			
	使用済燃料貯蔵プール水位・温度 (S A 広域) (使用済燃料貯蔵プール温度(プール底部付近))																			

柏崎刈羽原子力発電所 6 / 7号炉 (2017. 12. 20 版)	東海第二発電所 (2018. 9. 18 版)	島根原子力発電所 2号炉	備考																										
<p>【設定根拠】 (続) 7号炉 (7 / 7)</p> <table border="1" style="width: 100%; border-collapse: collapse;"> <thead> <tr> <th style="width: 10%;">目的</th> <th>対象パラメータ</th> </tr> </thead> <tbody> <tr> <td rowspan="14">水素爆発による格納容器の破損防止確認</td> <td>フィルタ装置水素濃度 (格納容器圧力逃がし装置水素濃度)</td> </tr> <tr> <td>フィルタ装置水素濃度 (フィルタベント装置出口水素濃度)</td> </tr> <tr> <td>フィルタ装置出口放射線モニタ (A)</td> </tr> <tr> <td>フィルタ装置出口放射線モニタ (B)</td> </tr> <tr> <td>フィルタ装置入口圧力</td> </tr> <tr> <td>フィルタ装置水位 (A)</td> </tr> <tr> <td>フィルタ装置水位 (B)</td> </tr> <tr> <td>フィルタ装置スクラバ水 pH</td> </tr> <tr> <td>フィルタ装置金属フィルタ差圧</td> </tr> <tr> <td>耐圧強化ベント系放射線モニタ (A)</td> </tr> <tr> <td>耐圧強化ベント系放射線モニタ (B)</td> </tr> <tr> <td rowspan="10">水素爆発による原子炉建屋の損傷防止確認</td> <td>原子炉建屋水素濃度 (R / B オペフロ水素濃度 A)</td> </tr> <tr> <td>原子炉建屋水素濃度 (R / B オペフロ水素濃度 B)</td> </tr> <tr> <td>原子炉建屋水素濃度 (上部ドライウエル所員用エアロック)</td> </tr> <tr> <td>原子炉建屋水素濃度 (上部ドライウエル機器搬入用ハッチ)</td> </tr> <tr> <td>原子炉建屋水素濃度 (サブプレッション・チェンバ出入口)</td> </tr> <tr> <td>原子炉建屋水素濃度 (下部ドライウエル所員用エアロック)</td> </tr> <tr> <td>原子炉建屋水素濃度 (下部ドライウエル機器搬入用ハッチ)</td> </tr> <tr> <td>静的触媒式水素再結合器 動作監視装置 (北側 P A R 吸気温度)</td> </tr> <tr> <td>静的触媒式水素再結合器 動作監視装置 (北側 P A R 排気温度)</td> </tr> <tr> <td>静的触媒式水素再結合器 動作監視装置 (南側 P A R 吸気温度)</td> </tr> <tr> <td>静的触媒式水素再結合器 動作監視装置 (南側 P A R 排気温度)</td> </tr> </tbody> </table>	目的	対象パラメータ	水素爆発による格納容器の破損防止確認	フィルタ装置水素濃度 (格納容器圧力逃がし装置水素濃度)	フィルタ装置水素濃度 (フィルタベント装置出口水素濃度)	フィルタ装置出口放射線モニタ (A)	フィルタ装置出口放射線モニタ (B)	フィルタ装置入口圧力	フィルタ装置水位 (A)	フィルタ装置水位 (B)	フィルタ装置スクラバ水 pH	フィルタ装置金属フィルタ差圧	耐圧強化ベント系放射線モニタ (A)	耐圧強化ベント系放射線モニタ (B)	水素爆発による原子炉建屋の損傷防止確認	原子炉建屋水素濃度 (R / B オペフロ水素濃度 A)	原子炉建屋水素濃度 (R / B オペフロ水素濃度 B)	原子炉建屋水素濃度 (上部ドライウエル所員用エアロック)	原子炉建屋水素濃度 (上部ドライウエル機器搬入用ハッチ)	原子炉建屋水素濃度 (サブプレッション・チェンバ出入口)	原子炉建屋水素濃度 (下部ドライウエル所員用エアロック)	原子炉建屋水素濃度 (下部ドライウエル機器搬入用ハッチ)	静的触媒式水素再結合器 動作監視装置 (北側 P A R 吸気温度)	静的触媒式水素再結合器 動作監視装置 (北側 P A R 排気温度)	静的触媒式水素再結合器 動作監視装置 (南側 P A R 吸気温度)	静的触媒式水素再結合器 動作監視装置 (南側 P A R 排気温度)			<p>・申請号炉数の相違 【柏崎 6/7】</p>
目的	対象パラメータ																												
水素爆発による格納容器の破損防止確認	フィルタ装置水素濃度 (格納容器圧力逃がし装置水素濃度)																												
	フィルタ装置水素濃度 (フィルタベント装置出口水素濃度)																												
	フィルタ装置出口放射線モニタ (A)																												
	フィルタ装置出口放射線モニタ (B)																												
	フィルタ装置入口圧力																												
	フィルタ装置水位 (A)																												
	フィルタ装置水位 (B)																												
	フィルタ装置スクラバ水 pH																												
	フィルタ装置金属フィルタ差圧																												
	耐圧強化ベント系放射線モニタ (A)																												
	耐圧強化ベント系放射線モニタ (B)																												
	水素爆発による原子炉建屋の損傷防止確認	原子炉建屋水素濃度 (R / B オペフロ水素濃度 A)																											
		原子炉建屋水素濃度 (R / B オペフロ水素濃度 B)																											
		原子炉建屋水素濃度 (上部ドライウエル所員用エアロック)																											
原子炉建屋水素濃度 (上部ドライウエル機器搬入用ハッチ)																													
原子炉建屋水素濃度 (サブプレッション・チェンバ出入口)																													
原子炉建屋水素濃度 (下部ドライウエル所員用エアロック)																													
原子炉建屋水素濃度 (下部ドライウエル機器搬入用ハッチ)																													
静的触媒式水素再結合器 動作監視装置 (北側 P A R 吸気温度)																													
静的触媒式水素再結合器 動作監視装置 (北側 P A R 排気温度)																													
静的触媒式水素再結合器 動作監視装置 (南側 P A R 吸気温度)																													
静的触媒式水素再結合器 動作監視装置 (南側 P A R 排気温度)																													

柏崎刈羽原子力発電所 6 / 7号炉 (2017. 12. 20 版)	東海第二発電所 (2018. 9. 18 版)	島根原子力発電所 2号炉	備考																																																
<table border="1" data-bbox="166 268 908 407"> <thead> <tr> <th colspan="2">名 称</th> <th colspan="2">酸素濃度・二酸化炭素濃度計</th> </tr> </thead> <tbody> <tr> <td>検知</td> <td>酸素</td> <td>%</td> <td>5.0 ~ 30.0</td> </tr> <tr> <td>範囲</td> <td>二酸化炭素</td> <td>%</td> <td>0.04 ~ 5.00</td> </tr> <tr> <td colspan="4">機器仕様に関する注記</td> </tr> <tr> <td colspan="4">—</td> </tr> </tbody> </table> <p data-bbox="195 424 902 474">【設定根拠】 酸素濃度・二酸化炭素濃度計は、可搬型重大事故等対処設備として配置するものである。</p> <p data-bbox="195 508 902 592">酸素濃度・二酸化炭素濃度計は、外気から中央制御室及び中央制御室待避室への空気を取り込みを停止した場合に、酸素濃度、二酸化炭素が事故対策のための活動に支障がない範囲にあることを正確に把握するためのものである。</p> <p data-bbox="195 625 902 709">なお、酸素濃度・二酸化炭素濃度計は、6号炉中央制御室、7号炉中央制御室及び中央制御室待避室に設置するための3台に、予備1台を含めた合計4台を中央制御室内に保管する。</p> <p data-bbox="195 743 902 1029">1. 検知範囲 1.1 酸素濃度 労働安全衛生法の酸素欠乏症等防止規則に基づき、空気中の酸素濃度18%を十分に満足する範囲を検知できる設計とする。また、表示精度としては、3%FSの精度を有する設計とする。 1.2 二酸化炭素濃度 JEAC4622-2009「原子力発電所中央制御室運転員の事故時被ばくに関する規程」に基づき、空気中の二酸化炭素濃度0.5%を十分に満足する範囲を検知できる設計とする。また、表示精度としては、±10%Rdgの精度を有する設計とする。</p>	名 称		酸素濃度・二酸化炭素濃度計		検知	酸素	%	5.0 ~ 30.0	範囲	二酸化炭素	%	0.04 ~ 5.00	機器仕様に関する注記				—				<table border="1" data-bbox="961 268 1703 407"> <thead> <tr> <th colspan="3">名 称</th> <th colspan="2">酸素濃度計、二酸化炭素濃度計</th> </tr> </thead> <tbody> <tr> <td rowspan="2">検知範囲</td> <td>酸素</td> <td>vol%</td> <td colspan="2">0.0~40.0</td> </tr> <tr> <td>二酸化炭素</td> <td>vol%</td> <td colspan="2">0.0~5.0</td> </tr> </tbody> </table> <p data-bbox="961 424 1697 550">【設定根拠】 酸素濃度計及び二酸化炭素濃度計は、可搬型重大事故等対処設備として配置するものである。 酸素濃度計及び二酸化炭素濃度計は、外気から中央制御室及び中央制御室待避室への空気を取り込みを停止した場合に、酸素濃度及び二酸化炭素濃度が事故対策のための活動に支障がない範囲にあることを正確に把握するためのものである。</p> <p data-bbox="961 583 1697 835">なお、酸素濃度計及び二酸化炭素濃度計は、中央制御室に設置するための1個に予備1個を加えて、合計2個を中央制御室内に保管する。</p> <p data-bbox="961 911 1697 1465">1. 検知範囲 1.1 酸素濃度 酸素濃度計は、「労働安全衛生法」の「酸素欠乏症等防止規則」に基づき、空気中の酸素濃度18vol%を十分に満足する範囲の検知が可能な設計とする。また、酸素濃度計は、±0.1vol%の表示精度を有する設計とする。 1.2 二酸化炭素濃度 二酸化炭素濃度計は、JEAC4622-2009「原子力発電所中央制御室運転員の事故時被ばくに関する規定」に基づき、空気中の二酸化炭素濃度0.5vol%を十分に満足する範囲の検知が可能な設計とする。また、二酸化炭素濃度計は、±3.0%F.S.の表示精度を有する設計とする。</p>	名 称			酸素濃度計、二酸化炭素濃度計		検知範囲	酸素	vol%	0.0~40.0		二酸化炭素	vol%	0.0~5.0		<table border="1" data-bbox="1754 268 2496 386"> <thead> <tr> <th colspan="3">名 称</th> <th colspan="2">酸素濃度計、二酸化炭素濃度計</th> </tr> </thead> <tbody> <tr> <td rowspan="2">検知範囲</td> <td>酸素</td> <td>vol%</td> <td colspan="2">0.0~25.0</td> </tr> <tr> <td>二酸化炭素</td> <td>ppm</td> <td colspan="2">0~10,000</td> </tr> </tbody> </table> <p data-bbox="1754 403 2490 508">【設定根拠】 酸素濃度計及び二酸化炭素濃度計は、可搬型重大事故等対処設備として配置するものである。 酸素濃度計及び二酸化炭素濃度計は、外気から中央制御室及び中央制御室待避室への空気を取り込みを停止した場合に、酸素濃度及び二酸化炭素濃度が事故対策のための活動に支障がない範囲にあることを正確に把握するためのものである。</p> <p data-bbox="1754 583 2490 919">なお、酸素濃度計及び二酸化炭素濃度計は、中央制御室及び中央制御室待避室に設置するための各2個に、予備各1個を含めた合計各3個を中央制御室内に保管する。</p> <p data-bbox="1754 974 2490 1369">1. 検知範囲 1.1 酸素濃度 鉱山保安法施行規則に基づき、空気中の酸素濃度19%を十分に満足する範囲を検知できる設計とする。また、表示精度としては、±0.5vol%の精度を有する設計とする。 1.2 二酸化炭素濃度 鉱山保安法施行規則に基づき、空気中の二酸化炭素濃度1.0%を十分に満足する範囲を検知できる設計とする。また、表示精度としては、±500ppmの精度を有する設計とする。</p>	名 称			酸素濃度計、二酸化炭素濃度計		検知範囲	酸素	vol%	0.0~25.0		二酸化炭素	ppm	0~10,000		<p data-bbox="2522 256 2807 600">・設備の相違 【柏崎6/7，東海第二】 島根2号炉は、酸素濃度、二酸化炭素濃度が事故対策のための活動に支障がない範囲にあることを正確に把握できるものを配備している</p>
名 称		酸素濃度・二酸化炭素濃度計																																																	
検知	酸素	%	5.0 ~ 30.0																																																
範囲	二酸化炭素	%	0.04 ~ 5.00																																																
機器仕様に関する注記																																																			
—																																																			
名 称			酸素濃度計、二酸化炭素濃度計																																																
検知範囲	酸素	vol%	0.0~40.0																																																
	二酸化炭素	vol%	0.0~5.0																																																
名 称			酸素濃度計、二酸化炭素濃度計																																																
検知範囲	酸素	vol%	0.0~25.0																																																
	二酸化炭素	ppm	0~10,000																																																

柏崎刈羽原子力発電所 6 / 7号炉 (2017. 12. 20 版)	東海第二発電所 (2018. 9. 18 版)	島根原子力発電所 2号炉	備考																																																	
<table border="1" data-bbox="166 262 911 451"> <thead> <tr> <th colspan="2">名 称</th> <th colspan="2">非常用ガス処理系排風機</th> </tr> </thead> <tbody> <tr> <td>容量</td> <td>m³/h/個</td> <td colspan="2">1,844 以上 (注1) (2,000 (注2))</td> </tr> <tr> <td rowspan="2">原動機出力</td> <td rowspan="2">kW/個</td> <td><input type="checkbox"/> 以上 (注1) (22 (注2)) (6号炉)</td> <td rowspan="2"><input type="checkbox"/> 以上 (注1) (15 (注2)) (7号炉)</td> </tr> <tr> <td><input type="checkbox"/> 以上 (注1) (15 (注2)) (7号炉)</td> </tr> <tr> <td colspan="2">機器仕様に関する注記</td> <td colspan="2">注1: 要求値を示す 注2: 公称値を示す</td> </tr> </tbody> </table> <p data-bbox="166 472 911 1081"> 【設定根拠】 非常用ガス処理系排風機は、設計基準事故対処設備として使用する場合、放射性よう素・粒子状放射性物質が直接大気へ放出されることを防止し、原子炉建屋原子炉区域内を負圧に維持することを目的とし、事故時に原子炉建屋原子炉区域内の気体を吸引し非常用ガス処理系フィルタを介して排気する。また、非常用ガス処理系排風機は、工学的安全施設作動回路からの信号により、自動的に常用の換気空調系が閉止されるとともに起動し、原子炉建屋原子炉区域を水柱約6mmの負圧に保ち、原子炉建屋原子炉区域内空気の50%を1日で処理する能力を有する。 非常用ガス処理系排風機を重大事故等対処設備として使用する場合、炉心の著しい損傷の発生時に原子炉格納容器から原子炉建屋内に放射性物質を含む気体が漏えいした場合において、原子炉建屋原子炉区域内を負圧に維持するとともに、主排気筒（内筒）を通して原子炉建屋外に排気することで、運転員の被ばくを低減することができる。ただし、非常用ガス処理系を重大事故等対処設備として使用する場合は、非常用ガス処理系フィルタの性能には期待しないものとする。 なお、炉心の著しい損傷の発生時における中央制御室の居住性に係る被ばく評価については、運転員の7日間の実効線量が6号及び7号炉で代替循環冷却系を用いて事象収束に成功した場合で最大約66mSv、6号炉が格納容器ベントを実施し、7号炉が代替循環冷却系を用いて事象収束に成功した場合で最大約78mSv、7号炉が格納容器ベントを実施し、6号炉が代替循環冷却系を用いて事象収束に成功した場合で最大約86mSvとなり、判断基準である「運転員の実効線量が7日間で100mSvを超えないこと」を満足することを確認している。（詳細は「59-11 原子炉制御室の居住性に係る被ばく評価について」による） </p> <p data-bbox="166 1144 911 1249"> 1. 容量の設定根拠 重大事故等対処設備としての非常用ガス処理系排風機の容量は、「(1) 原子炉建屋原子炉区域空間容積を50%/dayで処理できる量」に、「(2) 原子炉格納容器からの漏えい量」を加えたものとする。 </p>	名 称		非常用ガス処理系排風機		容量	m ³ /h/個	1,844 以上 (注1) (2,000 (注2))		原動機出力	kW/個	<input type="checkbox"/> 以上 (注1) (22 (注2)) (6号炉)	<input type="checkbox"/> 以上 (注1) (15 (注2)) (7号炉)	<input type="checkbox"/> 以上 (注1) (15 (注2)) (7号炉)	機器仕様に関する注記		注1: 要求値を示す 注2: 公称値を示す		<table border="1" data-bbox="958 262 1703 472"> <thead> <tr> <th colspan="2">名 称</th> <th colspan="2">非常用ガス処理系排風機</th> </tr> </thead> <tbody> <tr> <td>容量</td> <td>m³/h/個</td> <td colspan="2">3,570 以上</td> </tr> <tr> <td>原動機出力</td> <td>kW/個</td> <td colspan="2">7.5</td> </tr> <tr> <td>個数</td> <td>—</td> <td colspan="2">2</td> </tr> </tbody> </table> <p data-bbox="958 483 1703 1081"> 【設定根拠】 (概要) ・設計基準対象施設 非常用ガス処理系排風機は、放射性よう素・粒子状核分裂生成物が直接大気へ放出されることを防止し、原子炉建屋内を負圧に維持することを目的とし、事故時に非常用ガス再循環系で処理されたガスの一部を吸引し非常用ガス処理系フィルタトレインを介して排気するために設置する。また、非常用ガス処理系排風機は、工学的安全施設作動回路からの信号により、自動的に常用の換気空調系が閉止されるとともに起動し、原子炉建屋を約60 Pa [dif] の負圧に保ち、原子炉建物内空気の100 %を1日で処理する能力を持っている。 また、非常用ガス処理系排風機は、非常用所内電源に接続しており、外部電源喪失時でも運転制御が可能である。 </p> <p data-bbox="958 1144 1703 1491"> ・重大事故等対処設備 重大事故等時に、原子炉格納施設のうち圧力低減設備その他の安全設備として使用する非常用ガス処理系排風機は、以下の機能を有する。 非常用ガス処理系排風機は、炉心の著しい損傷が発生した場合において原子炉建屋その他の原子炉格納容器から漏えいする気体状の放射性物質を格納するための施設（以下「原子炉建屋等」という。）の水素爆発による損傷を防止する必要がある場合には、水素爆発による当該原子炉建屋等の損傷を防止するために設置する。 </p>	名 称		非常用ガス処理系排風機		容量	m ³ /h/個	3,570 以上		原動機出力	kW/個	7.5		個数	—	2		<table border="1" data-bbox="1751 241 2496 451"> <thead> <tr> <th colspan="2">名 称</th> <th colspan="2">非常用ガス処理系排気ファン</th> </tr> </thead> <tbody> <tr> <td>容量</td> <td>m³/h/台</td> <td colspan="2">4,400 以上 (注1) (4,400 (注2))</td> </tr> <tr> <td>原動機出力</td> <td>kW/台</td> <td colspan="2"><input type="checkbox"/> 以上 (注1) (22 (注2))</td> </tr> <tr> <td colspan="2">機器仕様に関する注記</td> <td colspan="2">注1: 要求値を示す 注2: 公称値を示す</td> </tr> </tbody> </table> <p data-bbox="1751 483 2496 1186"> 【設定根拠】 非常用ガス処理系排気ファンは、設計基準事故対処設備として使用する場合、放射性よう素・粒子状放射性物質が直接大気へ放出されることを防止し、原子炉建屋内を負圧に維持することを目的とし、事故時に原子炉建物原子炉棟内の気体を吸引し前置ガス処理装置及び後置ガス処理装置を介して排気する。また、非常用ガス処理系排気ファンは、工学的安全施設作動回路からの信号により、自動的に常用の換気空調系が閉止されるとともに起動し、<u>原子炉建物</u>原子炉棟を水柱約6mmの負圧に保ち、<u>原子炉建物</u>原子炉棟内空気の100%を1日で処理する能力を有する。 非常用ガス処理系排気ファンを重大事故等対処設備として使用する場合、炉心の著しい損傷の発生時に原子炉格納容器から原子炉建物内に放射性物質を含む気体が漏えいした場合において、<u>原子炉建物</u>原子炉棟内を負圧に維持するとともに、主排気筒に沿って設ける排気管を通して原子炉建物外に排気することで、運転員の被ばくを低減することができる。ただし、非常用ガス処理系を重大事故等対処設備として使用する場合は、前置ガス処理装置及び後置ガス処理装置の性能には期待しないものとする。 なお、炉心の著しい損傷の発生時における中央制御室の居住性に係る被ばく評価については、運転員の7日間の実効線量が、「運転員の実効線量が7日間で100mSvを超えないこと」を満足することを確認している。（詳細は「59-11 原子炉制御室の居住性（炉心の著しい損傷）に係る被ばく評価について」による） </p> <p data-bbox="1751 1428 2496 1732"> 1. 容量の設定根拠 設計基準対象施設として使用する非常用ガス処理系排気ファンの容量は、<u>原子炉建物</u>原子炉棟空間容積（機器・配管の容積を除いた値）を100%/dayで処理できる容量として、4,400m³/h/台以上とする。 非常用ガス処理系排気ファンを重大事故等時において使用する場合は、設計基準対象施設と同様の使用方法であるため、4,400m³/h/台以上とする。 公称値については要求される容量と同仕様として4,400m³/h/台とする。 </p>	名 称		非常用ガス処理系排気ファン		容量	m ³ /h/台	4,400 以上 (注1) (4,400 (注2))		原動機出力	kW/台	<input type="checkbox"/> 以上 (注1) (22 (注2))		機器仕様に関する注記		注1: 要求値を示す 注2: 公称値を示す		<p data-bbox="2537 252 2804 556"> ・設備の相違 【柏崎6/7，東海第二】 島根2号炉は、原子炉建物原子炉棟内を負圧に維持するために必要な容量をもつ設計として いる </p>
名 称		非常用ガス処理系排風機																																																		
容量	m ³ /h/個	1,844 以上 (注1) (2,000 (注2))																																																		
原動機出力	kW/個	<input type="checkbox"/> 以上 (注1) (22 (注2)) (6号炉)	<input type="checkbox"/> 以上 (注1) (15 (注2)) (7号炉)																																																	
		<input type="checkbox"/> 以上 (注1) (15 (注2)) (7号炉)																																																		
機器仕様に関する注記		注1: 要求値を示す 注2: 公称値を示す																																																		
名 称		非常用ガス処理系排風機																																																		
容量	m ³ /h/個	3,570 以上																																																		
原動機出力	kW/個	7.5																																																		
個数	—	2																																																		
名 称		非常用ガス処理系排気ファン																																																		
容量	m ³ /h/台	4,400 以上 (注1) (4,400 (注2))																																																		
原動機出力	kW/台	<input type="checkbox"/> 以上 (注1) (22 (注2))																																																		
機器仕様に関する注記		注1: 要求値を示す 注2: 公称値を示す																																																		

柏崎刈羽原子力発電所 6 / 7号炉 (2017. 12. 20 版)	東海第二発電所 (2018. 9. 18 版)	島根原子力発電所 2号炉	備考
<p>(1) 原子炉建屋原子炉区域空間容積を 50%/day で処理する量 ・原子炉建屋原子炉区域空間容積：86,000m³</p> $86,000 \times \frac{50}{100} \times \frac{1}{24} = 1,791.6 \approx 1,792 \text{ m}^3/\text{h}$ <p>(2) 原子炉格納容器からの漏えい量 ・原子炉格納容器自由空間容積：13310 m³ ・原子炉格納容器漏えい率：1.3 %/d (原子炉格納容器限界圧力 0.62MPa[gage]時における想定漏えい率) ・原子炉格納容器限界圧力である 0.62MPa[gage]の気体が大気圧(0.101325MPa[abs])に開放された時の容積比：7.2 ((0.62+0.101325) / 0.101325 = 7.12 ≈ 7.2)</p> $13,310 \times \frac{1.3}{100} \times 7.2 \times \frac{1}{24} = 51.9 \approx 52 \text{ m}^3/\text{h}$ <p>以上より、非常用ガス処理系排風機の容量は、1,792+52=1,844 m³/h 以上とし、設計基準事故対処設備としての容量と同じ 2,000m³/h/個とする。</p> <p>2. 原動機出力の設定根拠 非常用ガス処理系排風機の原動機出力は、非常用ガス処理系排風機の定格風量点における軸動力をもとに設定する。</p> <p><6号炉> 定格風量点における非常用ガス処理系排風機の風量は 2,000 m³/h、静圧は <input type="text"/> kPa であり、そのときの非常用ガス処理系排風機の必要軸動力は、<input type="text"/> kW となる。 上記から、非常用ガス処理系排風機の原動機出力は、必要軸動力を上回る原動機のメーカー標準出力とし、22kW/個とする。</p> <p><7号炉> 定格風量点における非常用ガス処理系排風機の風量は 2,000 m³/h、静圧は <input type="text"/> kPa であり、そのときの非常用ガス処理系排風機の必要軸動力は、<input type="text"/> kW となる。 上記から、非常用ガス処理系排風機の原動機出力は、必要軸動力を上回る原動機のメーカー標準出力とし、15kW/個とする。</p>	<p>系統構成は、非常用ガス再循環系で処理したガスの一部を吸引し、粒子用高効率フィルタ及びびよう素用チャコールフィルタで構成される非常用ガス処理系フィルタトレインを通じて放射性物質を低減させ、非常用ガス処理系排風機を介して排気筒に隣接する非常用ガス処理系排気筒から排出することにより原子炉建屋原子炉棟内に水素が滞留しない設計とする。</p> <p>1. 容量の設定根拠 設計基準対象施設として使用する非常用ガス処理系排風機の容量は、原子炉建屋空間容積（間仕切壁、機器、配管の容積を除いた値）を 100 % /d で処理できる容量として、3,570 m³/h 個以上とする。</p> <p>非常用ガス処理系排風機を重大事故等時において使用する場合は、設計基準対象施設と同様の使用方法であるため、設計基準対象施設と同仕様で設計し、3,570 m³/h 個以上とする。</p> <p>公称値については要求される容量と同仕様として 3,570 m³/h 個とする。</p> <p>2. 原動機出力の設定根拠 設計基準対象施設として使用する非常用ガス処理系排風機の原動機出力は、風量は 3,570 m³/h 時の軸動力を基に設定する。 定格風量点における非常用ガス処理系排風機の風量は 3,570 m³/h であり、その時の同ファンの必要軸動力は、以下のとおり <input type="text"/> kW となる。</p>	<p>2. 原動機出力の設定根拠 非常用ガス処理系排気ファンの原動機出力は、非常用ガス処理系排気ファンの定格風量点における軸動力をもとに設定する。</p> <p>定格風量点における非常用ガス処理系排気ファンの風量は 4,400 m³/h/台、静圧は <input type="text"/> kPa であり、そのときの非常用ガス処理系排気ファンの必要軸動力は、約 <input type="text"/> kW となる。 上記から、非常用ガス処理系排気ファンの原動機出力は、必要軸動力を上回る原動機のメーカー標準出力とし、22kW/台とする。</p>	<p>・設備の相違 【柏崎 6/7，東海第二】 島根 2号炉は、原子炉建物原子炉棟内を負圧に維持するために必要な容量をもつ設計としている</p>

柏崎刈羽原子力発電所 6 / 7号炉 (2017. 12. 20 版)	東海第二発電所 (2018. 9. 18 版)	島根原子力発電所 2号炉	備考
	<div style="text-align: center;"> $L = \frac{L_T}{\eta_T / 100} = \frac{\frac{\kappa}{\kappa - 1} \cdot \frac{P_{T1}}{6 \times 10^4} \cdot Q_1 \cdot \left\{ \left(\frac{P_{T2}}{P_{T1}} \right)^{\frac{\kappa - 1}{\kappa}} - 1 \right\}}{\eta_T / 100} \dots \frac{P_{S2}}{P_{S1}} > 1.03 \text{ のとき}$ $= \frac{Q_1}{6 \times 10^4} \cdot \{ (P_{S2} - P_{S1}) + (p_{d2} - p_{d1}) \} \dots \frac{P_{S2}}{P_{S1}} \leq 1.03 \text{ のとき}$ </div> <p>(引用文献：日本工業規格 J I S B 8 3 3 0 (2000) 「送風機の試験及び検査方法」)</p> <p>L : 軸動力 (kW) L_T : 全圧空気動力 (kW) κ : 比熱比 Q₁ : 吸込空気量 (m³/min) P_{T2} : 吸い出し口送風機絶対全圧 (Pa [abs]) P_{T1} : 吸込口送風機絶対全圧 (Pa [abs]) P_{S2} : 吐き出し口送風機絶対静圧 (Pa [abs]) P_{S1} : 吸込口送風機絶対静圧 (Pa [abs]) p_{d2} : 吸い出し口動圧 (Pa) p_{d1} : 吸込口動圧 (Pa) η_T : 全圧効率 (%) (設計計画値)</p> <div style="border: 1px solid black; width: 100px; height: 100px; margin: 10px auto;"></div> <p>$\frac{P_{S2}}{P_{S1}} = \frac{\text{[]}}{\text{[]}} = \text{[]} < 1.03 \text{ より}$</p> <p>$L = \frac{\left(\frac{3570}{60} \right) \times \{ \text{[]} + \text{[]} + \text{[]} + \text{[]} \}}{6 \times 10^4} \times \frac{37}{100} = \text{[]} \text{ kW}$</p>		<p>・設備の相違</p> <p>【柏崎 6/7, 東海第二】 島根 2号炉は, 原子炉建物原子炉棟内を負圧に維持するために必要な容量をもつ設計としている</p>

柏崎刈羽原子力発電所 6 / 7号炉 (2017. 12. 20 版)	東海第二発電所 (2018. 9. 18 版)	島根原子力発電所 2号炉	備考
	<p>上記から、非常用ガス処理系排風機の原動機出力は、必要軸動力□ kWを上回る原動機のメーカー標準出力とし、7.5 kWとする。</p> <p>以上より、非常用ガス処理系排風機の原動機出力は、必要軸動力□ kWを上回る7.5 kW個とする。</p> <p>3. 個数の設定根拠</p> <p>非常用ガス処理系排風機は、設計基準対象施設として放射性よう素・粒子状核分裂生成物が直接大気へ放出されることを防止し、原子炉建屋内を負圧に維持することを目的とし、事故時に非常用ガス再循環系で処理されたガスの一部を吸引し非常用ガス処理系フィルタトレインを介して排気するために各系列に1個ずつ、計2個設置する。</p> <p>非常用ガス処理系排風機は、炉心の著しい損傷が発生した場合において原子炉建屋等の水素爆発による損傷を防止する必要がある場合には、水素爆発による当該原子炉建屋等の損傷を防止するために、設計基準対象施設として各系列に1個ずつ、計2個設置しているものを重大事故等対処設備として使用する。</p>		<p>・設備の相違</p> <p>【柏崎 6/7, 東海第二】</p> <p>島根 2号炉は、原子炉建物原子炉棟内を負圧に維持するために必要な容量をもつ設計としている</p>

実線・・・設備運用又は体制等の相違（設計方針の相違）
 波線・・・記載表現、設備名称の相違（実質的な相違なし）

まとめ資料比較表〔59条 補足説明資料 59-7 保管場所図〕

柏崎刈羽原子力発電所 6 / 7号炉 (2017. 12. 20 版)	東海第二発電所 (2018. 9. 18 版)	島根原子力発電所 2号炉	備考
<p style="text-align: center;">59-7 保管場所図</p>	<p style="text-align: center;">59-7 保管場所図</p>	<p style="text-align: center;">59-7 保管場所図</p>	

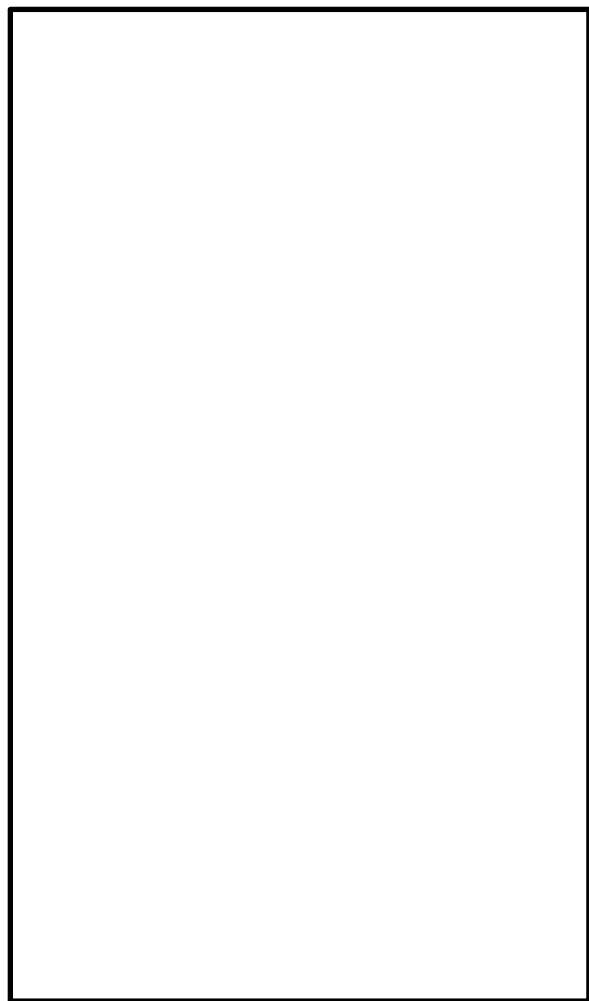
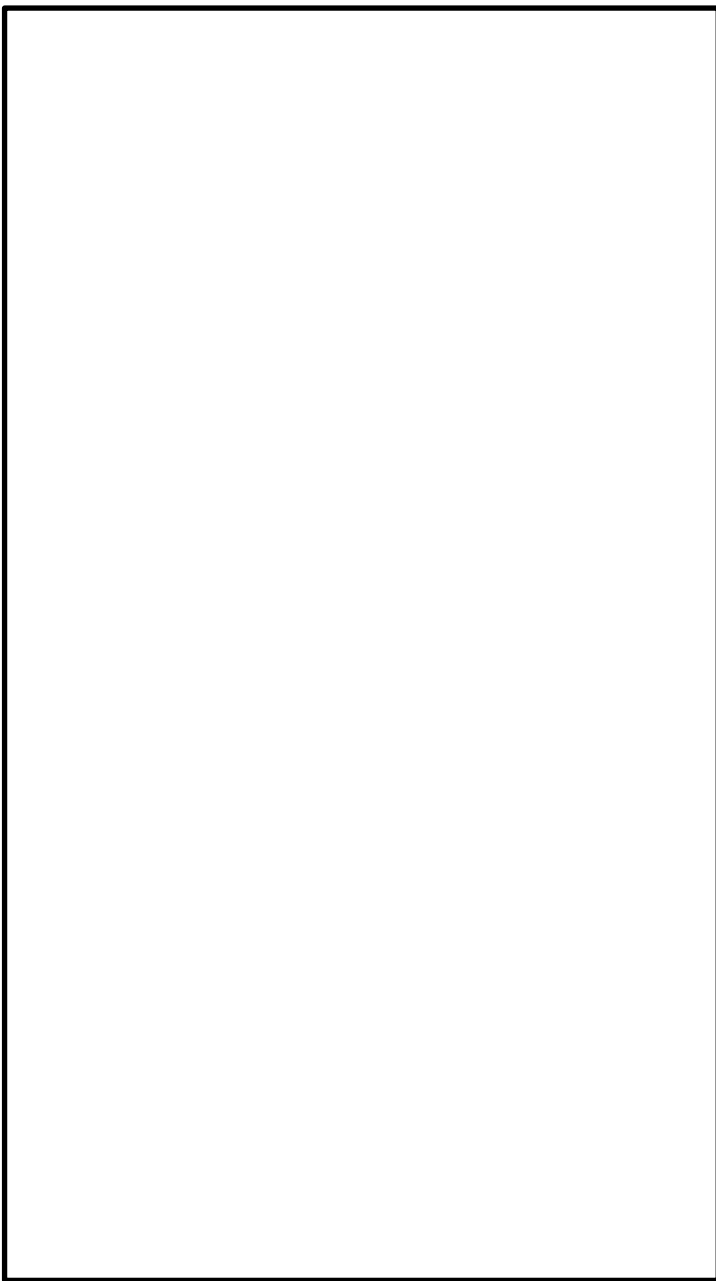
柏崎刈羽原子力発電所 6 / 7号炉 (2017. 12. 20 版)	東海第二発電所 (2018. 9. 18 版)	島根原子力発電所 2号炉	備考
 <p data-bbox="178 1596 890 1638">図 59-7-1 中央制御室 可搬型蓄電池内蔵型照明 保管場所</p>	 <p data-bbox="943 1596 1712 1722">第59-7-1図 衛星電話設備（可搬型）（待避室），データ表示装置（待避室），可搬型照明（S A），酸素濃度計及び二酸化炭素濃度計保管場所図</p>	 <p data-bbox="1795 1596 2448 1638">図 59-7-1 LEDライト（三脚タイプ） 保管場所</p>	<p data-bbox="2522 1596 2819 1774">・設備の相違 【柏崎 6/7】 中央制御室レイアウト相違に伴う配置の相違</p>

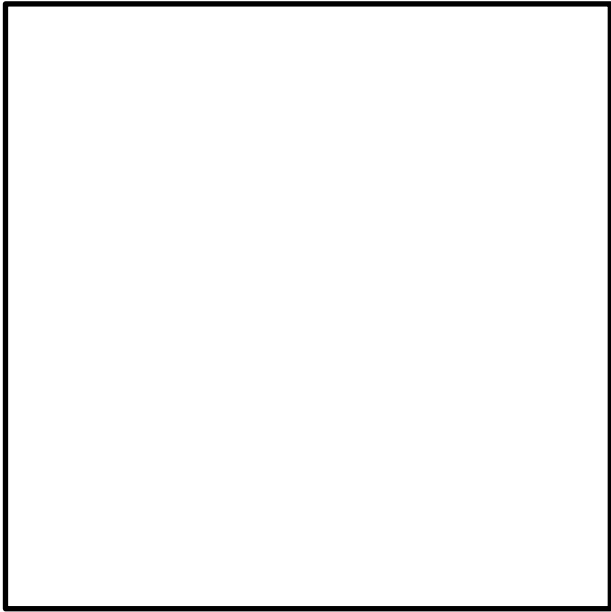
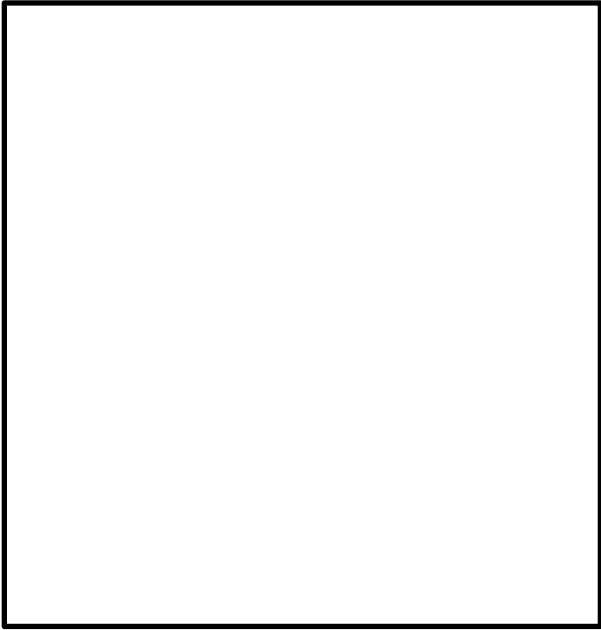
柏崎刈羽原子力発電所 6 / 7 号炉 (2017. 12. 20 版)	東海第二発電所 (2018. 9. 18 版)	島根原子力発電所 2 号炉	備考
 <p data-bbox="151 1780 926 1812"><u>図 59-7-2 中央制御室可搬型陽圧化空調機 (予備機) の保管場所</u></p>	 <p data-bbox="1044 974 1614 1005"><u>第 59-7-2 図 可搬型照明 (S A) 保管場所図</u></p>		<p data-bbox="2534 974 2816 1182"> ・構成の相違 【東海第二】 島根 2 号炉の可搬型照明保管場所は図 59-7-1 に示す </p> <p data-bbox="2534 1738 2816 1856"> ・設備及び運用の相違 【柏崎 6/7】 ①の相違 </p>

柏崎刈羽原子力発電所 6 / 7号炉 (2017. 12. 20 版)	東海第二発電所 (2018. 9. 18 版)	島根原子力発電所 2号炉	備考
<div data-bbox="231 260 804 831" data-label="Image"> </div> <div data-bbox="148 926 926 1003" data-label="Caption"> <p>図 59-7-3 酸素濃度・二酸化炭素濃度計及び乾電池内蔵型照明の保管場所</p> </div>		<div data-bbox="1745 281 2504 1461" data-label="Image"> </div> <div data-bbox="1730 1598 2507 1675" data-label="Caption"> <p>図 59-7-2 酸素濃度計, 二酸化炭素濃度計, LEDライト (ランタンタイプ) 及びプラントパラメータ監視装置 保管場所</p> </div>	

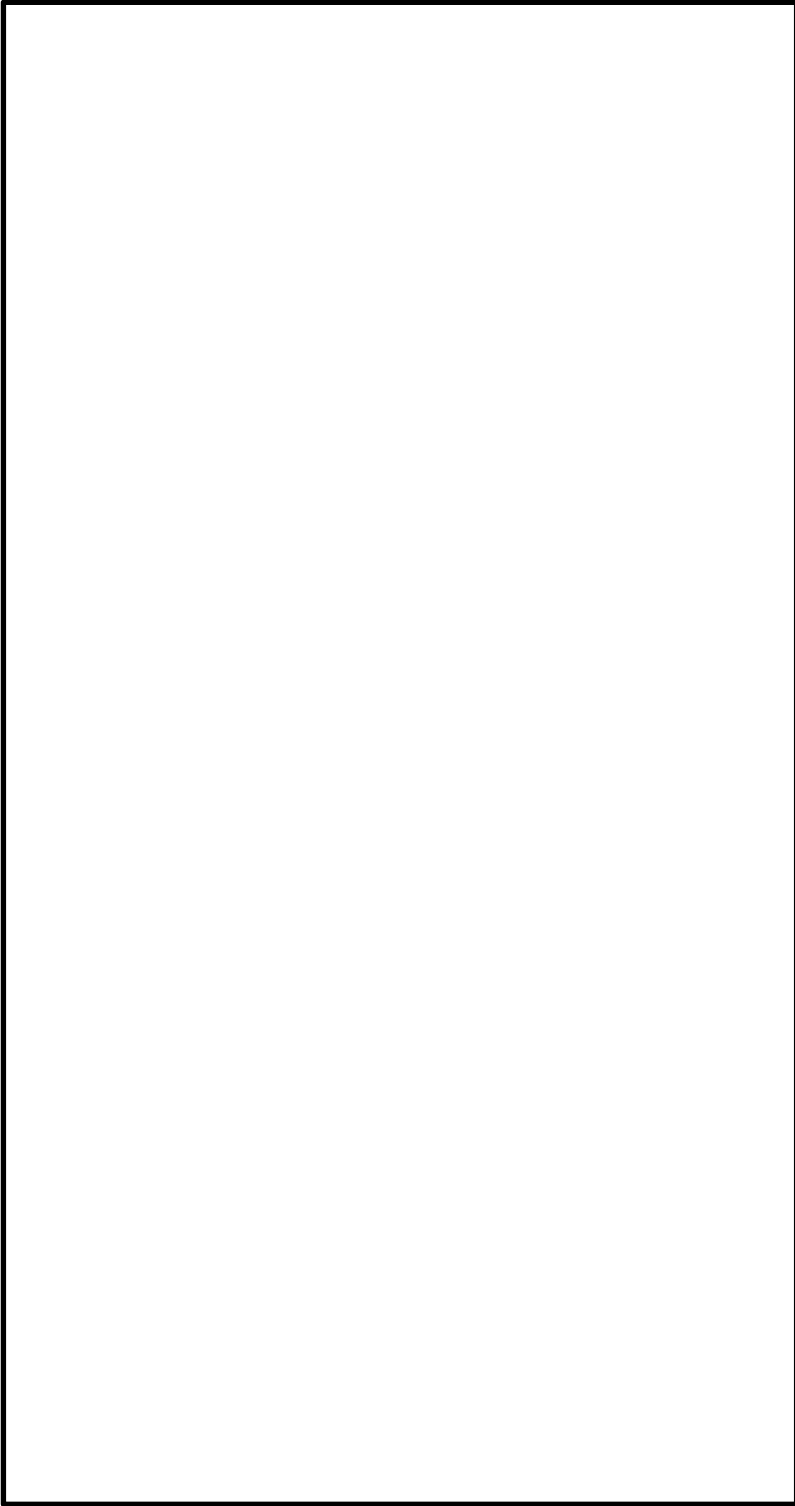
柏崎刈羽原子力発電所 6 / 7 号炉 (2017. 12. 20 版)	東海第二発電所 (2018. 9. 18 版)	島根原子力発電所 2 号炉	備考
		 <p data-bbox="1736 1648 2507 1722">図 59-7-3 中央制御室待避室正圧化装置 (空気ポンペ) 保管場所</p>	



実線・・・設備運用又は体制等の相違（設計方針の相違）
 波線・・・記載表現、設備名称の相違（実質的な相違なし）

まとめ資料比較表〔59条 補足説明資料 59-8 アクセスルート図〕

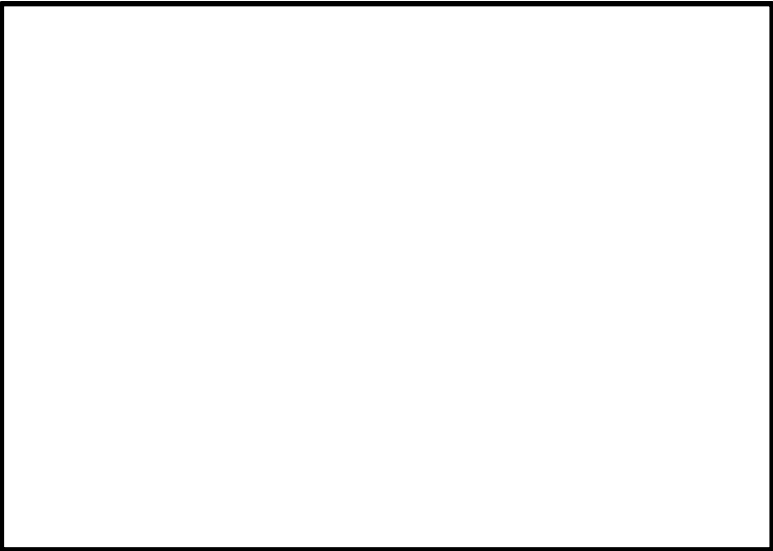
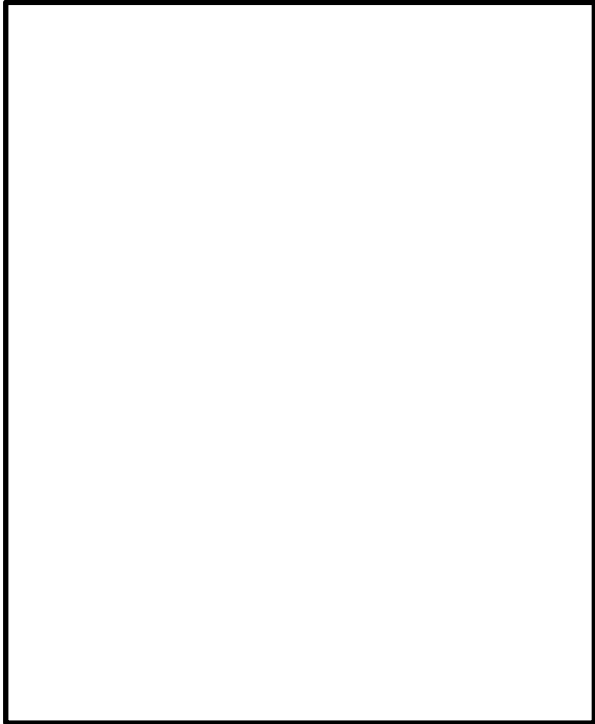
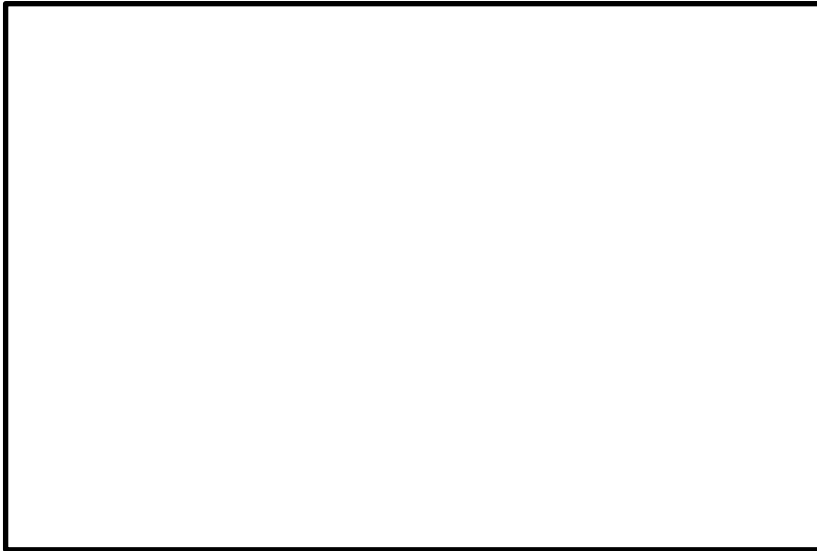

柏崎刈羽原子力発電所 6 / 7号炉 (2017. 12. 20 版)	東海第二発電所 (2018. 9. 18 版)	島根原子力発電所 2号炉	備考
<p style="text-align: center;">59-8 アクセスルート図</p>	<p style="text-align: center;">59-8 アクセスルート</p>	<p style="text-align: center;">59-8 アクセスルート図</p>	

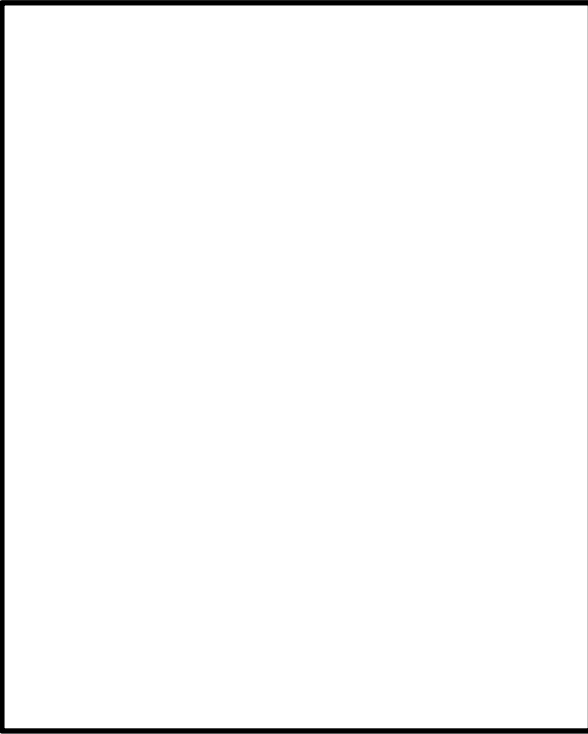
柏崎刈羽原子力発電所 6 / 7号炉 (2017. 12. 20 版)	東海第二発電所 (2018. 9. 18 版)	島根原子力発電所 2号炉	備考
 <p data-bbox="201 926 863 957">第 59-8-1 図 現場操作アクセスルート (建屋地上 2 階)</p>	 <p data-bbox="946 926 1715 1003">第 59-8-1 図 中央制御室アクセスルート (原子炉建屋付属棟 1 階)</p>	<p data-bbox="1754 254 2332 285">[制御室建物地上 4 階・廃棄物処理建物地上 1 階]</p>  <p data-bbox="1745 926 2502 1003">図 59-8-1 現場操作アクセスルート (中央制御室換気系隔離運転及び加圧運転) (1/2)</p>	

柏崎刈羽原子力発電所 6 / 7 号炉 (2017. 12. 20 版)	東海第二発電所 (2018. 9. 18 版)	島根原子力発電所 2 号炉	備考
		<p data-bbox="1745 254 2065 289">[廃棄物処理建物地上 2 階]</p>  <p data-bbox="1745 884 2502 961">図 59-8-1 現場操作アクセスルート (中央制御室換気系隔離運転及び加圧運転) (2/2)</p>	

柏崎刈羽原子力発電所 6 / 7号炉 (2017. 12. 20 版)	東海第二発電所 (2018. 9. 18 版)	島根原子力発電所 2号炉	備考
 <p data-bbox="201 926 860 961">第 59-8-2 図 現場操作アクセスルート (建屋地上1階)</p>	 <p data-bbox="943 926 1712 1003">第 59-8-2 図 中央制御室アクセスルート (原子炉建屋付属棟中 2階)</p>	<p data-bbox="1783 243 2356 279">[廃棄物処理建物地上1階・制御室建物地上4階]</p>  <p data-bbox="1742 926 2510 1003">図 59-8-2 現場操作アクセスルート (中央制御室待避室加圧準備 操作)</p>	備考

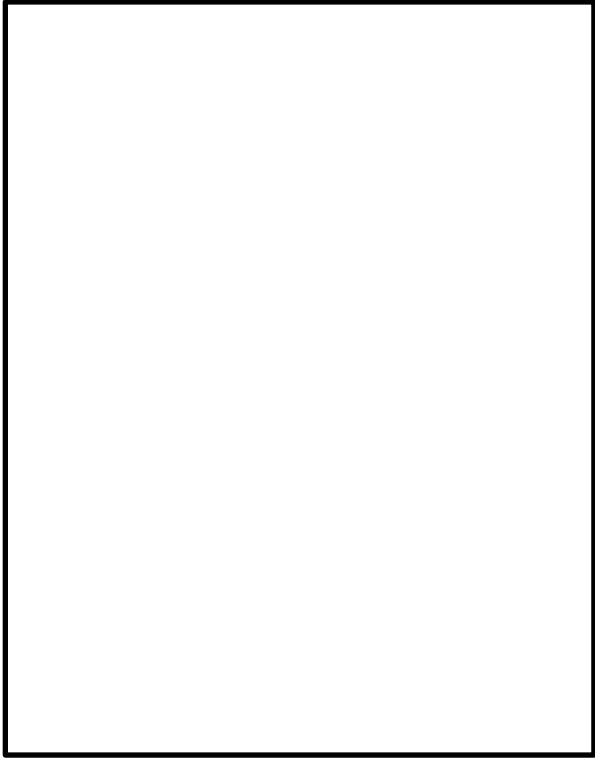
柏崎刈羽原子力発電所 6 / 7号炉 (2017. 12. 20 版)	東海第二発電所 (2018. 9. 18 版)	島根原子力発電所 2号炉	備考
<div data-bbox="166 302 914 793" data-label="Image"> </div> <div data-bbox="201 884 863 915" data-label="Caption"> <p>第 59-8-3 図 現場操作アクセスルート (建屋地下1階)</p> </div>	<div data-bbox="1092 218 1584 869" data-label="Image"> </div> <div data-bbox="943 884 1715 957" data-label="Caption"> <p>第 59-8-3 図 中央制御室アクセスルート (原子炉建屋付属棟3階)</p> </div>	<div data-bbox="1745 254 2504 793" data-label="Image"> <p data-bbox="1754 254 2012 285">[制御室建物地上2階]</p> </div> <div data-bbox="1733 884 2504 915" data-label="Caption"> <p>図 59-8-3 現場操作アクセスルート (チェンジングエリア) (1/3)</p> </div>	

柏崎刈羽原子力発電所 6 / 7 号炉 (2017. 12. 20 版)	東海第二発電所 (2018. 9. 18 版)	島根原子力発電所 2号炉	備考
	 <p data-bbox="943 974 1718 1052">第 59-8-4 図 中央制御室アクセスルート (原子炉建屋付属棟 4 階)</p>	<p data-bbox="1754 254 2012 285">[制御室建物地上 3 階]</p>  <p data-bbox="1739 974 2502 1005">図 59-8-3 現場操作アクセスルート (チェンジングエリア) (2/3)</p>	

柏崎刈羽原子力発電所 6 / 7 号炉 (2017. 12. 20 版)	東海第二発電所 (2018. 9. 18 版)	島根原子力発電所 2 号炉	備考
		<p data-bbox="1745 254 2012 285">[制御室建物地上 4 階]</p>  <p data-bbox="1745 837 2496 869">図 59-8-3 現場操作アクセスルート (チェンジングエリア) (3/3)</p>	

柏崎刈羽原子力発電所 6 / 7号炉 (2017. 12. 20 版)	東海第二発電所 (2018. 9. 18 版)	島根原子力発電所 2号炉	備考
		<p data-bbox="1745 254 2012 285">[原子炉建物地上1階]</p>  <p data-bbox="1733 835 2504 915">図 59-8-4 現場操作アクセスルート（原子炉建物ブローアウトパネル閉止装置（現場操作））（1/5）</p>	

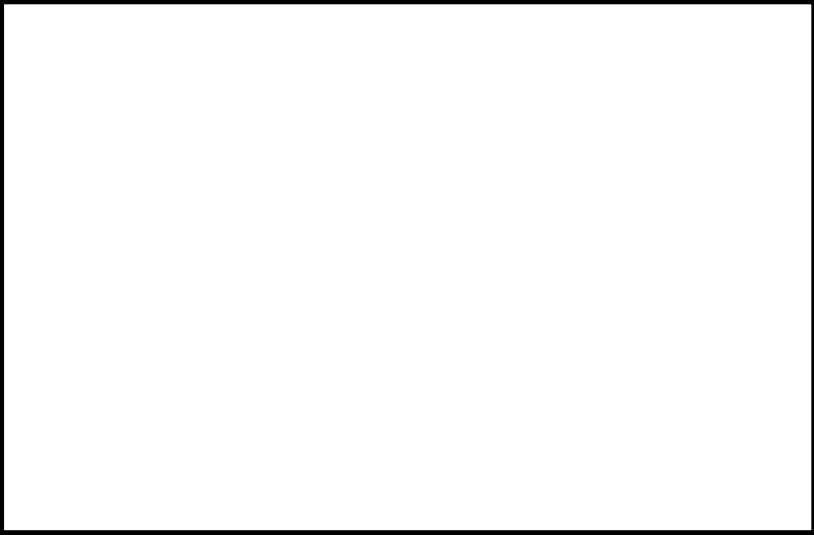
柏崎刈羽原子力発電所 6 / 7号炉 (2017. 12. 20 版)	東海第二発電所 (2018. 9. 18 版)	島根原子力発電所 2号炉	備考
		<p data-bbox="1745 254 2012 285">[原子炉建物地上2階]</p>  <p data-bbox="1745 793 2504 869">図 59-8-4 現場操作アクセスルート（原子炉建物ブローアウトパネル閉止装置（現場操作））（2/5）</p>	

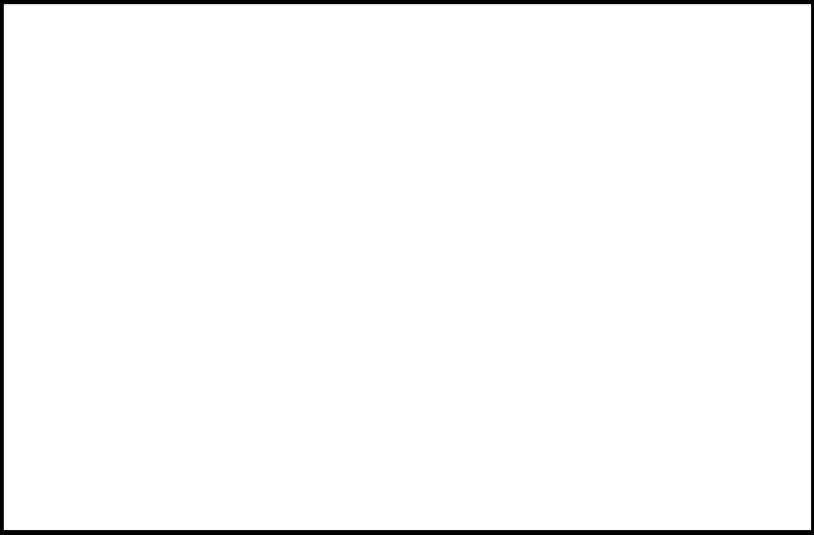
柏崎刈羽原子力発電所 6 / 7号炉 (2017. 12. 20 版)	東海第二発電所 (2018. 9. 18 版)	島根原子力発電所 2号炉	備考
		<p data-bbox="1745 254 2041 285">[原子炉建物地上中2階]</p>  <p data-bbox="1745 842 2504 915">図 59-8-4 現場操作アクセスルート（原子炉建物ブローアウトパネル閉止装置（現場操作））（3/5）</p>	

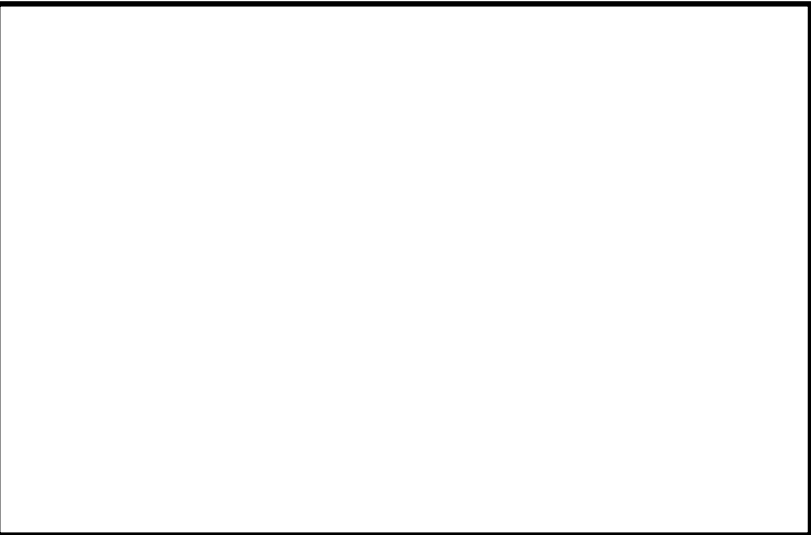
柏崎刈羽原子力発電所 6 / 7号炉 (2017. 12. 20 版)	東海第二発電所 (2018. 9. 18 版)	島根原子力発電所 2号炉	備考
		<p data-bbox="1745 254 2012 285">[原子炉建物地上3階]</p>  <p data-bbox="1745 842 2502 915">図 59-8-4 現場操作アクセスルート（原子炉建物ブローアウトパネル閉止装置（現場操作））（4/5）</p>	

柏崎刈羽原子力発電所 6 / 7 号炉 (2017. 12. 20 版)	東海第二発電所 (2018. 9. 18 版)	島根原子力発電所 2 号炉	備考
		<p data-bbox="1745 254 2012 285">[原子炉建物地上 4 階]</p>  <p data-bbox="1745 842 2504 915">図 59-8-4 現場操作アクセスルート（原子炉建物ブローアウトパネル閉止装置（現場操作））(5/5)</p>	

実線・・・設備運用又は体制等の相違（設計方針の相違）
 波線・・・記載表現、設備名称の相違（実質的な相違なし）

まとめ資料比較表〔59条 補足説明資料 59-9 その他設備〕

柏崎刈羽原子力発電所 6 / 7号炉 (2017. 12. 20 版)	東海第二発電所 (2018. 9. 18 版)	島根原子力発電所 2号炉	備考
<p style="text-align: center;">59-9 その他設備</p>		<p style="text-align: center;">59-9 その他設備</p>	

柏崎刈羽原子力発電所 6/7号炉 (2017. 12. 20 版)	東海第二発電所 (2018. 9. 18 版)	島根原子力発電所 2号炉	備考
<p>その他設備</p> <p>1.1 <u>カードル式空気ポンベユニット</u></p> <p><u>6号及び7号炉において炉心の著しい損傷が発生し、仮に両号炉にて格納容器ベントを実施することを想定した場合、ベントタイミングのずれを考慮すると最大で20 時間中央制御室待避室内に待避する必要がある。このため、運転員の被ばく量を100mSv/7 日間以下に抑えるためには、中央制御室待避室の陽圧化を最大で20時間維持する必要がある。</u></p> <p><u>カードル式空気ポンベユニットは、中央制御室待避室陽圧化装置と同程度の空気容量を有しているため、本設備を中央制御室待避室陽圧化装置に接続することにより、陽圧化を20時間以上維持することができる。なお、本設備は事業者の自主的な取り組みで設置するものである。</u></p> <p><u>6号及び7号炉において炉心の著しい損傷が発生し、両号炉にて格納容器ベントの実施が想定される場合には、本設備を中央制御室待避室陽圧化装置に接続し、20時間以上の陽圧化を可能とする。</u></p> <div data-bbox="261 1045 801 1312"> </div> <p>図 59-9-1 カードル式空気ポンベユニット接続概要図</p> <div data-bbox="290 1417 786 1774"> </div> <p>配置については、今後、訓練等を通じて見直していく。</p> <p>図 59-9-2 カードル式空気ポンベユニット接続時の配置図</p>		<p>その他設備</p>	<p>・自主対策設備の相違 【柏崎 6/7】 ②の相違</p>

柏崎刈羽原子力発電所 6 / 7号炉 (2017. 12. 20 版)	東海第二発電所 (2018. 9. 18 版)	島根原子力発電所 2号炉	備考
		<p>1.1 <u>非常用照明</u></p> <p><u>2号炉において炉心の著しい損傷が発生した場合に運転員が中央制御室にとどまり監視操作を行うことができるために必要な照度を確保する設計とする。</u></p> <p><u>なお、本設備は事業者の自主的な取り組みで設置するものである。</u></p> <p><u>非常用照明は、耐震性は確保されていないが、全交流動力電源喪失時に常設代替交流電源設備から給電が可能であるため、照明を確保する手段として有効である。</u></p> <div data-bbox="1822 638 2421 1734" style="border: 1px solid black; height: 500px; margin: 10px auto;"></div> <p style="text-align: center;"><u>図 59-9-1 非常用照明 配置図</u></p>	<p>・資料構成の相違</p> <p>【柏崎 6/7, 東海第二】 柏崎 6/7, 東海第二においても非常用照明を自主対策設備と位置付けている。</p>

実線・・・設備運用又は体制等の相違（設計方針の相違）
 波線・・・記載表現、設備名称の相違（実質的な相違なし）

まとめ資料比較表 [59条 補足説明資料 59-10 原子炉制御室について（被ばく評価除く）]

柏崎刈羽原子力発電所 6 / 7号炉 (2017. 12. 20 版)	東海第二発電所(2018. 9. 18 版)	島根原子力発電所 2号炉	備考																
<p>比較表において、相違理由を類型化したものについて以下にまとめて記載する。下記以外の相違については、備考欄に相違理由を記載する。 ただし、本表相違No. は59-10にのみ適用する。</p> <table border="1" data-bbox="249 491 2392 1125"> <thead> <tr> <th data-bbox="255 495 430 571">相違No.</th> <th data-bbox="436 495 2386 571">相違理由</th> </tr> </thead> <tbody> <tr> <td data-bbox="255 575 430 651">①</td> <td data-bbox="436 575 2386 651">島根2号炉は、酸素濃度計及び二酸化炭素濃度計を個別に配備している</td> </tr> <tr> <td data-bbox="255 655 430 730">②</td> <td data-bbox="436 655 2386 730">島根2号炉は常設の中央制御室換気系を用いて居住性を確保する</td> </tr> <tr> <td data-bbox="255 735 430 810">③</td> <td data-bbox="436 735 2386 810">島根2号炉は、ブローアウトパネル部を閉止する必要がある場合にはブローアウトパネル閉止装置を閉止する</td> </tr> <tr> <td data-bbox="255 814 430 890">④</td> <td data-bbox="436 814 2386 890">島根2号炉の対応要員数は「3.6 中央制御室待避室の収容性」に示す5名とする</td> </tr> <tr> <td data-bbox="255 894 430 970">⑤</td> <td data-bbox="436 894 2386 970">島根2号炉は鉛等により十分な遮蔽を確保する</td> </tr> <tr> <td data-bbox="255 974 430 1050">⑥</td> <td data-bbox="436 974 2386 1050">島根2号炉はS A設備である中央制御室待避室空気ポンペで十分なポンペ容量を確保</td> </tr> <tr> <td data-bbox="255 1054 430 1129">⑦</td> <td data-bbox="436 1054 2386 1129">待避室は密閉された限られた環境であることから同様に限られた環境下における労働環境を規定している「鉱山保安法施行規則」に定める酸素濃度19%以上及び二酸化炭素濃度1%以下を適用</td> </tr> </tbody> </table>				相違No.	相違理由	①	島根2号炉は、酸素濃度計及び二酸化炭素濃度計を個別に配備している	②	島根2号炉は常設の中央制御室換気系を用いて居住性を確保する	③	島根2号炉は、ブローアウトパネル部を閉止する必要がある場合にはブローアウトパネル閉止装置を閉止する	④	島根2号炉の対応要員数は「3.6 中央制御室待避室の収容性」に示す5名とする	⑤	島根2号炉は鉛等により十分な遮蔽を確保する	⑥	島根2号炉はS A設備である中央制御室待避室空気ポンペで十分なポンペ容量を確保	⑦	待避室は密閉された限られた環境であることから同様に限られた環境下における労働環境を規定している「鉱山保安法施行規則」に定める酸素濃度19%以上及び二酸化炭素濃度1%以下を適用
相違No.	相違理由																		
①	島根2号炉は、酸素濃度計及び二酸化炭素濃度計を個別に配備している																		
②	島根2号炉は常設の中央制御室換気系を用いて居住性を確保する																		
③	島根2号炉は、ブローアウトパネル部を閉止する必要がある場合にはブローアウトパネル閉止装置を閉止する																		
④	島根2号炉の対応要員数は「3.6 中央制御室待避室の収容性」に示す5名とする																		
⑤	島根2号炉は鉛等により十分な遮蔽を確保する																		
⑥	島根2号炉はS A設備である中央制御室待避室空気ポンペで十分なポンペ容量を確保																		
⑦	待避室は密閉された限られた環境であることから同様に限られた環境下における労働環境を規定している「鉱山保安法施行規則」に定める酸素濃度19%以上及び二酸化炭素濃度1%以下を適用																		

柏崎刈羽原子力発電所 6 / 7号炉 (2017. 12. 20)	東海第二発電所 (2018. 9. 18 版)	島根原子力発電所 2号炉	備考
<p style="text-align: center;">59-10</p> <p style="text-align: center;">原子炉制御室について (被ばく評価除く)</p>	<p style="text-align: center;">59-9 原子炉制御室について (被ばく評価除く)</p>	<p style="text-align: center;">59-10</p> <p style="text-align: center;">原子炉制御室について (被ばく評価除く)</p>	

柏崎刈羽原子力発電所 6/7号炉 (2017.12.20)	東海第二発電所 (2018.9.18版)	島根原子力発電所 2号炉	備考
<p>目次</p> <p>1. 概要</p> <p>1.1 新規制基準への適合方針</p> <p>1.2 設計における想定シナリオ</p> <p>2. 設計方針</p> <p>2.1 中央制御室から外の状況を把握する設備について</p> <p>2.1.1 中央制御室から外の状況を把握する設備の概要</p> <p>2.1.2 監視カメラについて</p> <p>2.1.3 監視カメラ映像サンプル</p> <p>2.1.4 監視カメラにより把握可能な自然現象等</p> <p>2.1.5 中央制御室にて把握可能なパラメータ</p> <p>2.2 酸素濃度計等について</p> <p>2.2.1 <u>酸素濃度 二酸化炭素濃度計</u>の設備概要</p> <p>2.2.2 酸素濃度、二酸化炭素濃度の管理</p> <p>2.3 汚染の持ち込み防止について</p> <p>2.4 炉心の著しい損傷が発生した場合に運転員がとどまるための設備について</p> <p>2.4.1 概要</p> <p>2.4.2 中央制御室及び中央制御室待避室<u>陽圧化</u>バウンダリの設計差圧</p> <p>2.4.3 中央制御室の居住性確保</p> <p>2.4.4 中央制御室待避室の居住性確保</p> <p>2.5 重大事故等時の電源設備について</p> <p>3. 添付資料</p> <p>3.1 中央制御室内待避室の運用について</p> <p>3.2 配備する資機材の数量について</p> <p>3.3 チェンジングエリアについて</p> <p>3.4 中央制御室への地震及び火災等の影響</p> <p>3.5 中央制御室待避室の<u>データ表示装置</u>で確認できるパラメータ</p> <p>3.6 <u>事故シーケンスの組み合わせと待避室の収容性</u></p> <p>3.7 <u>申請前号炉の中央制御室の居住性評価</u>について</p>	<p>目次</p> <p>1. 概要</p> <p>1.1 新規制基準への適合方針</p> <p>1.2 設計における想定シナリオ</p> <p>2. 設計方針</p> <p>2.1 中央制御室から外の状況を把握する設備について</p> <p>2.1.1 中央制御室から外の状況を把握する設備の概要</p> <p>2.1.2 <u>津波・構内監視カメラ</u>について</p> <p>2.1.3 <u>津波・構内監視カメラ映像</u>サンプル</p> <p>2.1.4 <u>津波・構内監視カメラ</u>により把握可能な自然現象等</p> <p>2.1.5 中央制御室にて把握可能なパラメータ</p> <p>2.2 酸素濃度計及び二酸化炭素濃度計について</p> <p>2.2.1 酸素濃度計及び二酸化炭素濃度計の設備概要</p> <p>2.2.2 酸素濃度及び二酸化炭素濃度の管理</p> <p>2.3 汚染の持ち込み防止について</p> <p>2.4 <u>重大事故</u>が発生した場合に運転員がとどまるための設備について</p> <p>2.4.1 概要</p> <p>2.4.2 中央制御室待避室正圧化バウンダリの設計差圧</p> <p>2.4.3 中央制御室の居住性確保</p> <p>2.4.4 中央制御室待避室の居住性確保</p> <p>2.5 重大事故等時の電源設備について</p> <p>3. 添付資料</p> <p>3.1 中央制御室待避室の運用について</p> <p>3.2 配備する資機材の数量について</p> <p>3.3 チェンジングエリアについて</p> <p>3.4 中央制御室への地震及び火災等の影響</p> <p>3.5 中央制御室待避室の<u>データ表示装置</u>で確認できるパラメータ</p> <p>3.6 <u>中央制御室待避室の内部寸法</u>について</p> <p>3.7 <u>ブローアウトパネルに係る設計方針</u></p>	<p>目次</p> <p>1. 概要</p> <p>1.1 新規制基準への適合方針</p> <p>1.2 設計における想定シナリオ</p> <p>2. 設計方針</p> <p>2.1 中央制御室から外の状況を把握する設備について</p> <p>2.1.1 中央制御室から外の状況を把握する設備の概要</p> <p>2.1.2 監視カメラについて</p> <p>2.1.3 監視カメラ映像サンプル</p> <p>2.1.4 監視カメラにより把握可能な自然現象等</p> <p>2.1.5 中央制御室にて把握可能なパラメータ</p> <p>2.2 <u>酸素濃度計及び二酸化炭素濃度計</u>について</p> <p>2.2.1 <u>酸素濃度計及び二酸化炭素濃度計</u>の設備概要</p> <p>2.2.2 酸素濃度及び二酸化炭素濃度の管理</p> <p>2.3 汚染の持ち込み防止について</p> <p>2.4 炉心の著しい損傷が発生した場合に運転員がとどまるための設備について</p> <p>2.4.1 概要</p> <p>2.4.2 中央制御室及び中央制御室待避室<u>正圧化</u>バウンダリの設計差圧</p> <p>2.4.3 中央制御室の居住性確保</p> <p>2.4.4 中央制御室待避室の居住性確保</p> <p>2.5 重大事故等時の電源設備について</p> <p>3. 添付資料</p> <p>3.1 中央制御室待避室の運用について</p> <p>3.2 配備する資機材の数量について</p> <p>3.3 チェンジングエリアについて</p> <p>3.4 中央制御室への地震及び火災等の影響</p> <p>3.5 中央制御室待避室の<u>プラントパラメータ監視装置</u> (中央制御室待避室)で確認できるパラメータ</p> <p>3.6 <u>中央制御室待避室の収容性</u></p> <p>3.7 <u>申請前号炉の中央制御室の居住性評価</u>について</p>	<p>備考</p> <p>・設備の相違</p> <p>【柏崎6/7】</p> <p>島根2号炉は、酸素濃度計及び二酸化炭素濃度計を個別に配備している(以下、①の相違)</p> <p>・記載内容の相違</p> <p>【東海第二】</p> <p>運転終了の島根1号炉は居住性評価対象外としている</p>

柏崎刈羽原子力発電所 6/7号炉 (2017.12.20)	東海第二発電所 (2018.9.18版)	島根原子力発電所 2号炉	備考																		
<p>1. 概要</p> <p>1.1 新規制基準への適合方針</p> <p>(1) 設計基準事象への対処</p> <p>原子炉制御室に関する設計基準事象への対処のための追加要求事項と、その適合方針は以下、表1.1-1, 表1.1-2 のとおりである。</p>	<p>1. 概要</p> <p>1.1 新規制基準への適合方針</p> <p>(1) 設計基準事象への対処</p> <p>原子炉制御室について、「<u>「実用発電用原子炉及びその附属施設の位置、構造及び設備の基準に関する規則」第26条及び「実用発電用原子炉及びその附属施設の技術基準に関する規則」第38条における追加要求事項を明確化する。</u>原子炉制御室に関する設計基準事象への対処のための追加要求事項及びその適合方針は、以下の第1.1-1表及び第1.1-2表のとおりである。</p>	<p>1. 概要</p> <p>1.1 新規制基準への適合方針</p> <p>(1) 設計基準事象への対処</p> <p>原子炉制御室に関する設計基準事象への対処のための追加要求事項と、その適合方針は以下、表1.1-1, 表1.1-2 のとおりである。</p>																			
<p>表1.1-1 「実用発電用原子炉及びその附属施設の位置、構造及び設備の基準に関する規則」第二十六条(原子炉制御室)</p>	<p>第1.1-1表 「実用発電用原子炉及びその附属施設の位置、構造及び設備の基準に関する規則」第26条(原子炉制御室等)</p>	<p>表1.1-1 「実用発電用原子炉及びその附属施設の位置、構造及び設備の基準に関する規則」第二十六条(原子炉制御室等)</p>																			
<table border="1"> <thead> <tr> <th data-bbox="124 877 394 1003">実用発電用原子炉及びその附属施設の位置、構造及び設備の基準に関する規則</th> <th data-bbox="403 877 652 1003">実用発電用原子炉及びその附属施設の位置、構造及び設備の基準に関する規則の解釈</th> <th data-bbox="661 877 914 1003">適合方針</th> </tr> </thead> <tbody> <tr> <td data-bbox="124 1010 394 1528">(原子炉制御室等) 第二十六条 発電用原子炉施設には、次に掲げるところにより、原子炉制御室(安全施設に属するものに限る。以下この条において同じ。)を設けなければならない。 一 設計基準対象施設の健全性を確保するために必要なパラメータを監視できるものとする。</td> <td data-bbox="403 1010 652 1528">第26条(原子炉制御室等) 1 第1項第1号に規定する「必要なパラメータを監視できる」とは、発電用原子炉及び主要な関連施設の運転状況並びに主要パラメータについて、計測制御システム施設で監視が要求されるパラメータのうち、連続的に監視する必要のあるものを原子炉制御室において監視できることをいう。</td> <td data-bbox="661 1010 914 1528">(追加要求事項への適合方針は以下の通り)</td> </tr> </tbody> </table>	実用発電用原子炉及びその附属施設の位置、構造及び設備の基準に関する規則	実用発電用原子炉及びその附属施設の位置、構造及び設備の基準に関する規則の解釈	適合方針	(原子炉制御室等) 第二十六条 発電用原子炉施設には、次に掲げるところにより、原子炉制御室(安全施設に属するものに限る。以下この条において同じ。)を設けなければならない。 一 設計基準対象施設の健全性を確保するために必要なパラメータを監視できるものとする。	第26条(原子炉制御室等) 1 第1項第1号に規定する「必要なパラメータを監視できる」とは、発電用原子炉及び主要な関連施設の運転状況並びに主要パラメータについて、計測制御システム施設で監視が要求されるパラメータのうち、連続的に監視する必要のあるものを原子炉制御室において監視できることをいう。	(追加要求事項への適合方針は以下の通り)	<table border="1"> <thead> <tr> <th data-bbox="923 877 1190 1003">実用発電用原子炉及びその附属施設の位置、構造及び設備の基準に関する規則</th> <th data-bbox="1199 877 1448 1003">実用発電用原子炉及びその附属施設の位置、構造及び設備の基準に関する規則の解釈</th> <th data-bbox="1457 877 1703 1003">適合方針</th> </tr> </thead> <tbody> <tr> <td data-bbox="923 1010 1190 1528">(原子炉制御室等) 第二十六条 発電用原子炉施設には、次に掲げるところにより、原子炉制御室(安全施設に属するものに限る。以下この条において同じ。)を設けなければならない。 一 設計基準対象施設の健全性を確保するために必要なパラメータを監視できるものとする。</td> <td data-bbox="1199 1010 1448 1528">第26条(原子炉制御室等) 1 第1項第1号に規定する「必要なパラメータを監視できる」とは、発電用原子炉及び主要な関連施設の運転状況並びに主要パラメータについて、計測制御システム施設で監視が要求されるパラメータのうち、連続的に監視する必要のあるものを原子炉制御室において監視できることをいう。</td> <td data-bbox="1457 1010 1703 1528">(追加要求事項への適合方針は以下のとおり)</td> </tr> </tbody> </table>	実用発電用原子炉及びその附属施設の位置、構造及び設備の基準に関する規則	実用発電用原子炉及びその附属施設の位置、構造及び設備の基準に関する規則の解釈	適合方針	(原子炉制御室等) 第二十六条 発電用原子炉施設には、次に掲げるところにより、原子炉制御室(安全施設に属するものに限る。以下この条において同じ。)を設けなければならない。 一 設計基準対象施設の健全性を確保するために必要なパラメータを監視できるものとする。	第26条(原子炉制御室等) 1 第1項第1号に規定する「必要なパラメータを監視できる」とは、発電用原子炉及び主要な関連施設の運転状況並びに主要パラメータについて、計測制御システム施設で監視が要求されるパラメータのうち、連続的に監視する必要のあるものを原子炉制御室において監視できることをいう。	(追加要求事項への適合方針は以下のとおり)	<table border="1"> <thead> <tr> <th data-bbox="1712 877 1979 1003">実用発電用原子炉及びその附属施設の位置、構造及び設備の基準に関する規則</th> <th data-bbox="1988 877 2237 1003">実用発電用原子炉及びその附属施設の位置、構造及び設備の基準に関する規則の解釈</th> <th data-bbox="2246 877 2496 1003">適合方針</th> </tr> </thead> <tbody> <tr> <td data-bbox="1712 1010 1979 1528">(原子炉制御室等) 第二十六条 発電用原子炉施設には、次に掲げるところにより、原子炉制御室(安全施設に属するものに限る。以下この条において同じ。)を設けなければならない。 一 設計基準対象施設の健全性を確保するために必要なパラメータを監視できるものとする。</td> <td data-bbox="1988 1010 2237 1528">第26条(原子炉制御室等) 1 第1項第1号に規定する「必要なパラメータを監視できる」とは、発電用原子炉及び主要な関連施設の運転状況並びに主要パラメータについて、計測制御システム施設で監視が要求されるパラメータのうち、連続的に監視する必要のあるものを原子炉制御室において監視できることをいう。</td> <td data-bbox="2246 1010 2496 1528">(追加要求事項への適合方針は以下のとおり)</td> </tr> </tbody> </table>	実用発電用原子炉及びその附属施設の位置、構造及び設備の基準に関する規則	実用発電用原子炉及びその附属施設の位置、構造及び設備の基準に関する規則の解釈	適合方針	(原子炉制御室等) 第二十六条 発電用原子炉施設には、次に掲げるところにより、原子炉制御室(安全施設に属するものに限る。以下この条において同じ。)を設けなければならない。 一 設計基準対象施設の健全性を確保するために必要なパラメータを監視できるものとする。	第26条(原子炉制御室等) 1 第1項第1号に規定する「必要なパラメータを監視できる」とは、発電用原子炉及び主要な関連施設の運転状況並びに主要パラメータについて、計測制御システム施設で監視が要求されるパラメータのうち、連続的に監視する必要のあるものを原子炉制御室において監視できることをいう。	(追加要求事項への適合方針は以下のとおり)	
実用発電用原子炉及びその附属施設の位置、構造及び設備の基準に関する規則	実用発電用原子炉及びその附属施設の位置、構造及び設備の基準に関する規則の解釈	適合方針																			
(原子炉制御室等) 第二十六条 発電用原子炉施設には、次に掲げるところにより、原子炉制御室(安全施設に属するものに限る。以下この条において同じ。)を設けなければならない。 一 設計基準対象施設の健全性を確保するために必要なパラメータを監視できるものとする。	第26条(原子炉制御室等) 1 第1項第1号に規定する「必要なパラメータを監視できる」とは、発電用原子炉及び主要な関連施設の運転状況並びに主要パラメータについて、計測制御システム施設で監視が要求されるパラメータのうち、連続的に監視する必要のあるものを原子炉制御室において監視できることをいう。	(追加要求事項への適合方針は以下の通り)																			
実用発電用原子炉及びその附属施設の位置、構造及び設備の基準に関する規則	実用発電用原子炉及びその附属施設の位置、構造及び設備の基準に関する規則の解釈	適合方針																			
(原子炉制御室等) 第二十六条 発電用原子炉施設には、次に掲げるところにより、原子炉制御室(安全施設に属するものに限る。以下この条において同じ。)を設けなければならない。 一 設計基準対象施設の健全性を確保するために必要なパラメータを監視できるものとする。	第26条(原子炉制御室等) 1 第1項第1号に規定する「必要なパラメータを監視できる」とは、発電用原子炉及び主要な関連施設の運転状況並びに主要パラメータについて、計測制御システム施設で監視が要求されるパラメータのうち、連続的に監視する必要のあるものを原子炉制御室において監視できることをいう。	(追加要求事項への適合方針は以下のとおり)																			
実用発電用原子炉及びその附属施設の位置、構造及び設備の基準に関する規則	実用発電用原子炉及びその附属施設の位置、構造及び設備の基準に関する規則の解釈	適合方針																			
(原子炉制御室等) 第二十六条 発電用原子炉施設には、次に掲げるところにより、原子炉制御室(安全施設に属するものに限る。以下この条において同じ。)を設けなければならない。 一 設計基準対象施設の健全性を確保するために必要なパラメータを監視できるものとする。	第26条(原子炉制御室等) 1 第1項第1号に規定する「必要なパラメータを監視できる」とは、発電用原子炉及び主要な関連施設の運転状況並びに主要パラメータについて、計測制御システム施設で監視が要求されるパラメータのうち、連続的に監視する必要のあるものを原子炉制御室において監視できることをいう。	(追加要求事項への適合方針は以下のとおり)																			

柏崎刈羽原子力発電所 6 / 7号炉 (2017.12.20)			東海第二発電所 (2018.9.18版)			島根原子力発電所 2号炉			備考
実用発電用原子炉及びその附属施設の位置、構造及び設備の基準に関する規則	実用発電用原子炉及びその附属施設の位置、構造及び設備の基準に関する規則の解釈	適合方針	実用発電用原子炉及びその附属施設の位置、構造及び設備の基準に関する規則	実用発電用原子炉及びその附属施設の位置、構造及び設備の基準に関する規則の解釈	適合方針	実用発電用原子炉及びその附属施設の位置、構造及び設備の基準に関する規則	実用発電用原子炉及びその附属施設の位置、構造及び設備の基準に関する規則の解釈	適合方針	
<p>二 発電用原子炉施設の外の状況を把握する設備を有するものとする。</p> <p>三 発電用原子炉施設の安全性を確保するために必要な操作を手動により行うことができるものとする。</p> <p>2 発電用原子炉施設には、火災その他の異常な事態により原子炉制御室が使用できない場合において、原子炉制御室以外の場所から発電用原子炉を高温停止の状態に直ちに移行させ、及び必要なパラメータを想定される範囲内に制御し、その後、発電用原子炉を安全な低温停止の状態に移行させ、及び低温停止の状態を維持させるために必要な機能を有する装置を設けなければならない。</p>	<p>2 第1項第2号に規定する「発電用原子炉施設の外の状況を把握する」とは、原子炉制御室から、発電用原子炉施設に影響を及ぼす可能性のある自然現象等を把握できることをいう。</p> <p>3 第1項第3号において「必要な操作を手動により行う」とは、急速な手動による発電用原子炉の停止及び停止後の発電用原子炉の冷却の確保のための操作をいう。</p> <p>4 第2項に規定する「発電用原子炉を高温停止の状態に直ちに移行」とは、直ちに発電用原子炉を停止し、残留熱を除去し及び高温停止状態を安全に維持することをいう。</p>	<p>・中央制御室には、発電用原子炉施設の外の状況を把握するために、7号炉原子炉建屋屋上他に設置した監視カメラの映像により、津波等の外部状況を昼夜にわたり監視できる設計とする。また、気象観測設備等の情報を中央制御室で把握可能な設計とする。そのほかにも、気象庁の警報情報（地震情報、大津波警報等）を中央制御室内のテレビ等にて受信可能な設計とする。</p>	<p>二 発電用原子炉施設の外の状況を把握する設備を有するものとする。</p> <p>三 発電用原子炉施設の安全性を確保するために必要な操作を手動により行うことができるものとする。</p> <p>2 発電用原子炉施設には、火災その他の異常な事態により原子炉制御室が使用できない場合において、原子炉制御室以外の場所から発電用原子炉を高温停止の状態に直ちに移行させ、及び必要なパラメータを想定される範囲内に制御し、その後、発電用原子炉を安全な低温停止の状態に移行させ、及び低温停止の状態を維持させるために必要な機能を有する装置を設けなければならない。</p>	<p>2 第1項第2号に規定する「発電用原子炉施設の外の状況を把握する」とは、原子炉制御室から、発電用原子炉施設に影響を及ぼす可能性のある自然現象等を把握できることをいう。</p> <p>3 第1項第3号において「必要な操作を手動により行う」とは、急速な手動による発電用原子炉の停止及び停止後の発電用原子炉の冷却の確保のための操作をいう。</p> <p>4 第2項に規定する「発電用原子炉を高温停止の状態に直ちに移行」とは、直ちに発電用原子炉を停止し、残留熱を除去し及び高温停止状態を安全に維持することをいう。</p>	<p>・中央制御室は、発電用原子炉施設の外の状況を把握するために、原子炉建屋屋上及び防潮堤上部に設置する津波・構内監視カメラの映像により、自然現象等の外部事象を昼夜にわたり監視できる設計とする。 ・気象観測設備等の情報を中央制御室で把握可能とする。 ・公的機関の警報（地震情報、大津波警報等）を中央制御室内のFAX等にて受信可能とする。</p>	<p>二 発電用原子炉施設の外の状況を把握する設備を有するものとする。</p> <p>三 発電用原子炉施設の安全性を確保するために必要な操作を手動により行うことができるものとする。</p> <p>2 発電用原子炉施設には、火災その他の異常な事態により原子炉制御室が使用できない場合において、原子炉制御室以外の場所から発電用原子炉を高温停止の状態に直ちに移行させ、及び必要なパラメータを想定される範囲内に制御し、その後、発電用原子炉を安全な低温停止の状態に移行させ、及び低温停止の状態を維持させるために必要な機能を有する装置を設けなければならない。</p>	<p>2 第1項第2号に規定する「発電用原子炉施設の外の状況を把握する」とは、原子炉制御室から、発電用原子炉施設に影響を及ぼす可能性のある自然現象等を把握できることをいう。</p> <p>3 第1項第3号において「必要な操作を手動により行う」とは、急速な手動による発電用原子炉の停止及び停止後の発電用原子炉の冷却の確保のための操作をいう。</p> <p>4 第2項に規定する「発電用原子炉を高温停止の状態に直ちに移行」とは、直ちに発電用原子炉を停止し、残留熱を除去し及び高温停止状態を安全に維持することをいう。</p>	<p>・中央制御室は、発電用原子炉施設の外の状況を把握するために、2号炉排気筒他に設置した監視カメラの映像により、津波等の外部状況を昼夜にわたり監視できる設計とする。また、気象観測設備等の情報を中央制御室で把握可能な設計とする。そのほか、公的機関の警報情報（地震情報、大津波警報等）を中央制御室内のテレビ等にて受信可能な設計とする。</p>	

柏崎刈羽原子力発電所 6 / 7号炉 (2017.12.20)			東海第二発電所 (2018.9.18版)			島根原子力発電所 2号炉			備考
実用発電用原子炉及びその附属施設の位置、構造及び設備の基準に関する規則	実用発電用原子炉及びその附属施設の位置、構造及び設備の基準に関する規則の解釈	適合方針	実用発電用原子炉及びその附属施設の位置、構造及び設備の基準に関する規則	実用発電用原子炉及びその附属施設の位置、構造及び設備の基準に関する規則の解釈	適合方針	実用発電用原子炉及びその附属施設の位置、構造及び設備の基準に関する規則	実用発電用原子炉及びその附属施設の位置、構造及び設備の基準に関する規則の解釈	適合方針	
<p>3 原子炉制御室及びこれに連絡する通路並びに運転員その他の従事者が原子炉制御室に出入りするための区域は、一次冷却系統に係る発電用原子炉施設の損壊又は故障その他の異常が発生した場合に発電用原子炉の運転の停止その他の発電用原子炉施設の安全性を確保するための措置をとるため、従事者が支障なく原子炉制御室に入り、又は一定期間とどまり、かつ、当該措置をとるための操作を行うことができるよう、遮蔽その他の適切な放射線防護措置、気体状の放射性物質及び原子炉制御室外の火災により発生する燃焼ガスに対する換気設備の隔離その他の適切に防護するための設備を設けなければならない。</p>	<p>5 第3項に規定する「従事者が支障なく原子炉制御室に入り、又は一定期間とどまり」とは、事故発生後、事故対策操作をすべき従事者が原子炉制御室に接近できるよう通路が確保されていること、及び従事者が原子炉制御室に適切な期間滞在できること、並びに従事者の交替等のため接近する場合においては、放射線レベルの減衰及び時間経過とともに可能となる被ばく防護策が採り得ることをいう。</p>		<p>3 一次冷却系統に係る発電用原子炉施設の損壊又は故障その他の異常が発生した場合に発電用原子炉の運転の停止その他の発電用原子炉施設の安全性を確保するための措置をとるため、従事者が支障なく原子炉制御室に入り、又は一定期間とどまり、かつ、当該措置をとるための操作を行うことができるよう、次の各号に掲げる場所の区分に応じ、当該各号に定める設備を設けなければならない。</p>	<p>5 第3項に規定する「従事者が支障なく原子炉制御室に入り、又は一定期間とどまり」とは、事故発生後、事故対策操作をすべき従事者が原子炉制御室に接近できるよう通路が確保されていること、及び従事者が原子炉制御室に適切な期間滞在できること、並びに従事者の交替等のため接近する場合においては、放射線レベルの減衰及び時間経過とともに可能となる被ばく防護策が採り得ることをいう。「当該措置をとるための操作を行うことができる」には、有毒ガスの発生に関して、有毒ガスが原子炉制御室の運転員に及ぼす影響により、運転員の対処能力が著しく低下し、安全施設の安全機能が損なわれることがないことを含む。</p>		<p>3 一次冷却系統に係る発電用原子炉施設の損壊又は故障その他の異常が発生した場合に発電用原子炉の運転の停止その他の発電用原子炉施設の安全性を確保するための措置をとるため、従事者が支障なく原子炉制御室に入り、又は一定期間とどまり、かつ、当該措置をとるための操作を行うことができるよう、次の各号に掲げる場所の区分に応じ、当該各号に定める設備を設けなければならない。</p>	<p>5 第3項に規定する「従事者が支障なく原子炉制御室に入り、又は一定期間とどまり」とは、事故発生後、事故対策操作をすべき従事者が原子炉制御室に接近できるよう通路が確保されていること、及び従事者が原子炉制御室に適切な期間滞在できること、並びに従事者の交替等のため接近する場合においては、放射線レベルの減衰及び時間経過とともに可能となる被ばく防護策が採り得ることをいう。「<u>当該措置をとるための操作を行うことができる</u>」には、<u>有毒ガスの発生に関して、有毒ガスが原子炉制御室の運転員に及ぼす影響により、運転員の対処能力が著しく低下し、安全施設の安全機能が損なわれることがないことを含む。</u></p>		

柏崎刈羽原子力発電所 6 / 7号炉 (2017.12.20)	東海第二発電所 (2018.9.18版)			島根原子力発電所 2号炉			備考
	<p>実用発電用原子炉及びその附属施設の位置、構造及び設備の基準に関する規則</p>	<p>実用発電用原子炉及びその附属施設の位置、構造及び設備の基準に関する規則の解釈</p>	<p>適合方針</p>	<p>実用発電用原子炉及びその附属施設の位置、構造及び設備の基準に関する規則</p>	<p>実用発電用原子炉及びその附属施設の位置、構造及び設備の基準に関する規則の解釈</p>	<p>適合方針</p>	
	<p>一 原子炉制御室及びその近傍並びに有毒ガスの発生源の近傍工場等内における有毒ガスの発生を検出するための装置及び当該装置が有毒ガスの発生を検出した場合に原子炉制御室において自動的に警報するための装置</p> <p>二 原子炉制御室及びこれに連絡する通路並びに運転員その他の従事者が原子炉制御室に出入りするための区域遮蔽壁その他の適切に放射線から防護するための設備、気体状の放射性物質及び原子炉制御室外の火災により発生する燃焼ガスに対し換気設備を隔離するための設備その他の適切に防護するための設備</p>	<p>6 第3項第1号に規定する「有毒ガスの発生源」とは、有毒ガスの発生時において、運転員の対処能力が損なわれるおそれがあるものをいう。「工場等内における有毒ガスの発生」とは、有毒ガスの発生源から有毒ガスが発生することをいう。</p>	<p>・「有毒ガス防護に係る影響評価ガイド」に基づく対応を経過措置期間※内に実施することとし、今回申請とは別に必要な許認可手続き(設置変更許可申請)を行う。 ※ 経過措置：平成32年5月1日以後の最初の施設定期検査終了の日まで</p>	<p>一 原子炉制御室及びその近傍並びに有毒ガスの発生源の近傍工場等内における有毒ガスの発生を検出するための装置及び当該装置が有毒ガスの発生を検出した場合に原子炉制御室において自動的に警報するための装置</p> <p>二 原子炉制御室及びこれに連絡する通路並びに運転員その他の従事者が原子炉制御室に出入りするための区域遮蔽壁その他の適切に放射線から防護するための設備、気体状の放射性物質及び原子炉制御室外の火災により発生する燃焼ガスに対し換気設備を隔離するための設備その他の適切に防護するための設備</p>	<p>6 第3項第1号に規定する「有毒ガスの発生源」とは、有毒ガスの発生時において、運転員の対処能力が損なわれるおそれがあるものをいう。「工場等内における有毒ガスの発生源から有毒ガスが発生することをいう。</p>	<p>・万一事故が発生した際には、中央制御室内の運転員に対し、有毒ガスによる影響により対処能力が著しく低下しないよう、運転員が中央制御室内にとどまり、事故対策に必要な各種の操作を行うことができる設計とする。</p> <p>・想定される有毒ガスの発生において、有毒ガスが運転員に及ぼす影響により、運転員の対処能力が著しく低下し、安全施設の安全機能が損なわれることがない設計とする。そのために、固定源及び可動源それぞれに対して有毒ガス防護に係る影響評価を実施する。固定源に対しては、運転員の吸気中の有毒ガス濃度の評価結果が有毒ガス防護のための判断基準値を下回ることににより、運転員を防護できる設計とする。可動源に対しては、中央制御室換気空調設備の隔離等の対策により、運転員を防護できる設計とする。</p>	

柏崎刈羽原子力発電所 6/7号炉 (2017.12.20)			東海第二発電所 (2018.9.18版)			島根原子力発電所 2号炉			備考
表1.1-2 「実用発電用原子炉及びその附属施設の技術基準に関する規則」第三十八条 (原子炉制御室)			第1.1-2表 「実用発電用原子炉及びその附属施設の技術基準に関する規則」第38条 (原子炉制御室等)			表1.1-2 「実用発電用原子炉及びその附属施設の技術基準に関する規則」第三十八条 (原子炉制御室等)			
実用発電用原子炉及びその附属施設の技術基準に関する規則	実用発電用原子炉及びその附属施設の技術基準に関する規則の解釈	適合方針	実用発電用原子炉及びその附属施設の技術基準に関する規則	実用発電用原子炉及びその附属施設の技術基準に関する規則の解釈	適合方針	実用発電用原子炉及びその附属施設の技術基準に関する規則	実用発電用原子炉及びその附属施設の技術基準に関する規則の解釈	適合方針	
<p>(原子炉制御室等) 第三十八条 発電用原子炉施設には、原子炉制御室を施設しなければならない。</p> <p>2 原子炉制御室には、反応度制御系統及び原子炉停止系統に係る設備を操作する装置、非常用炉心冷却設備その他の非常時に発電用原子炉の安全を確保するための設備を操作する装置、発電用原子炉及び一次冷却系統に係る主要な機械又は器具の動作状態を表示する装置、主要計測装置の計測結果を表示する装置その他の発電用原子炉を安全に運転するための主要な装置 (第四十七条第一項に規定する装置を含む。)を集中し、かつ、誤操作することなく適切に運転操作することができるよう施設しなければならない。</p> <p>3 原子炉制御室には、発電用原子炉施設の外部の状況を把握するための装置を施設しなければならない。</p>	<p>第38条 (原子炉制御室等)</p>	<p>・設置許可基準規則第二十六条第1項第2号に同じ。</p>	<p>(原子炉制御室等) 第三十八条 発電用原子炉施設には、原子炉制御室を施設しなければならない。</p> <p>2 原子炉制御室には、反応度制御系統及び原子炉停止系統に係る設備を操作する装置、非常用炉心冷却設備その他の非常時に発電用原子炉の安全を確保するための設備を操作する装置、発電用原子炉及び一次冷却系統に係る主要な機械又は器具の動作状態を表示する装置、主要計測装置の計測結果を表示する装置その他の発電用原子炉を安全に運転するための主要な装置 (第四十七条第一項に規定する装置を含む。)を集中し、かつ、誤操作することなく適切に運転操作することができるよう施設しなければならない。</p> <p>3 原子炉制御室には、発電用原子炉施設の外部の状況を把握するための装置を施設しなければならない。</p>	<p>第38条 (原子炉制御室等)</p>	<p>・「実用発電用原子炉及びその附属施設の位置、構造及び設備の基準に関する規則」第26条第1項第2号に同じ。</p>	<p>(原子炉制御室等) 第三十八条 発電用原子炉施設には、原子炉制御室を施設しなければならない。</p> <p>2 原子炉制御室には、反応度制御系統及び原子炉停止系統に係る設備を操作する装置、非常用炉心冷却設備その他の非常時に発電用原子炉の安全を確保するための設備を操作する装置、発電用原子炉及び一次冷却系統に係る主要な機械又は器具の動作状態を表示する装置、主要計測装置の計測結果を表示する装置その他の発電用原子炉を安全に運転するための主要な装置 (第四十七条第一項に規定する装置を含む。)を集中し、かつ、誤操作することなく適切に運転操作することができるよう施設しなければならない。</p> <p>3 原子炉制御室には、発電用原子炉施設の外部の状況を把握するための装置を施設しなければならない。</p>	<p>第38条 (原子炉制御室等)</p>	<p>・設置許可基準規則第二十六条第1項第2号に同じ。</p>	

柏崎刈羽原子力発電所 6 / 7号炉 (2017.12.20)			東海第二発電所 (2018.9.18版)			島根原子力発電所 2号炉			備考
実用発電用原子炉及びその附属施設の技術基準に関する規則	実用発電用原子炉及びその附属施設の技術基準に関する規則の解釈	適合方針	実用発電用原子炉及びその附属施設の技術基準に関する規則	実用発電用原子炉及びその附属施設の技術基準に関する規則の解釈	適合方針	実用発電用原子炉及びその附属施設の技術基準に関する規則	実用発電用原子炉及びその附属施設の技術基準に関する規則の解釈	適合方針	
<p>4 発電用原子炉施設には、火災その他の異常な事態により原子炉制御室が使用できない場合に、原子炉制御室以外の場所から発電用原子炉の運転を停止し、かつ、安全な状態に維持することができる装置を施設しなければならない。</p> <p>5 原子炉制御室及びこれに連絡する通路並びに運転員その他の従事者が原子炉制御室に出入りする区域には、一次冷却系統に係る発電用原子炉施設の損壊又は故障その他の異常が発生した場合に発電用原子炉の運転の停止その他の発電用原子炉施設の安全性を確保するための措置をとるため、従事者が支障なく原子炉制御室に入り、又は一定期間とどまり、かつ、当該措置をとることができるよう、遮蔽その他の適切な放射線防護措置、気体状の放射性物質及び原子炉制御室外の火災により発生する燃焼ガスに対する換気設備の隔離その他の適切な防護措置を講じなければならない。</p>	<p>9 第4項に規定する「原子炉制御室以外の場所」とは、原子炉制御室を構成する区画壁の外であって、原子炉制御室退避の原因となった居住性の悪化の影響が及ぶおそれがない程度に隔離された場所をいい、「安全な状態に維持することができる装置」とは、原子炉制御室以外の場所から発電用原子炉を高温停止でき、引き続き低温停止できる機能を有した装置であること。</p> <p>10 第5項に規定する「これに連絡する通路並びに運転員その他の従事者が原子炉制御室に出入りする区域」とは、一次冷却系統に係る施設の故障、損壊等が生じた場合に原子炉制御室に直交替等のため入退域する通路及び区域をいう。</p> <p>11 第5項においては、原子炉制御室等には事故・異常時においても従事者が原子炉制御室に立ち入り、一定期間滞在できるように放射線に係る遮蔽壁、放射線量率の計測装置の設置等の「適切な放射線防護措置」が施されていること。この「放射線防護措置」としては必ずしも設備面の対策のみではなく防護具の配備、着用等運用面の対策も含まれる。「一定期間」とは、運転員が必要な交替も含め、一次冷却材喪失等の設計基準事故時に過度の被ばくなしにとどまり、必要な操作を行う期間をいう。</p>		<p>4 発電用原子炉施設には、火災その他の異常な事態により原子炉制御室が使用できない場合に、原子炉制御室以外の場所から発電用原子炉の運転を停止し、かつ、安全な状態に維持することができる装置を施設しなければならない。</p> <p>5 一次冷却系統に係る発電用原子炉施設の損壊又は故障その他の異常が発生した場合に発電用原子炉の運転の停止その他の発電用原子炉施設の安全性を確保するための措置をとるため、従事者が支障なく原子炉制御室に入り、又は一定期間とどまり、かつ、当該措置をとることができるよう、次の各号に掲げる場所の区分に応じ、当該各号に定める防護措置を講じなければならない。</p>	<p>9 第4項に規定する「原子炉制御室以外の場所」とは、原子炉制御室を構成する区画壁の外であって、原子炉制御室退避の原因となった居住性の悪化の影響が及ぶおそれがない程度に隔離された場所をいい、「安全な状態に維持することができる装置」とは、原子炉制御室以外の場所から発電用原子炉を高温停止でき、引き続き低温停止できる機能を有した装置であること。</p> <p>10 第5項に規定する「これに連絡する通路並びに運転員その他の従事者が原子炉制御室に出入りする区域」とは、一次冷却系統に係る施設の故障、損壊等が生じた場合に原子炉制御室に直交替等のため入退域する通路及び区域をいう。</p> <p>11 第5項においては、原子炉制御室等には事故・異常時においても従事者が原子炉制御室に立ち入り、一定期間滞在できるように放射線に係る遮蔽壁、放射線量率の計測装置の設置等の「適切な放射線防護措置」が施されていること。この「放射線防護措置」としては必ずしも設備面の対策のみではなく防護具の配備、着用等運用面の対策も含まれる。「一定期間」とは、運転員が必要な交替も含め、一次冷却材喪失等の設計基準事故時に過度の被ばくなしにとどまり、必要な操作を行う期間をいう。</p>		<p>4 発電用原子炉施設には、火災その他の異常な事態により原子炉制御室が使用できない場合に、原子炉制御室以外の場所から発電用原子炉の運転を停止し、かつ、安全な状態に維持することができる装置を施設しなければならない。</p> <p>5 一次冷却系統に係る発電用原子炉施設の損壊又は故障その他の異常が発生した場合に発電用原子炉の運転の停止その他の発電用原子炉施設の安全性を確保するための措置をとるため、従事者が支障なく原子炉制御室に入り、又は一定期間とどまり、かつ、当該措置をとることができるよう、次の各号に掲げる場所の区分に応じ、当該各号に定める防護措置を講じなければならない。</p> <p>10 第5項に規定する「これに連絡する通路並びに運転員その他の従事者が原子炉制御室に出入りする区域」とは、一次冷却系統に係る施設の故障、損壊等が生じた場合に原子炉制御室に直交替等のため入退域する通路及び区域をいう。</p> <p>11 第5項においては、原子炉制御室等には事故・異常時においても従事者が原子炉制御室に立ち入り、一定期間滞在できるように放射線に係る遮蔽壁、放射線量率の計測装置の設置等の「適切な放射線防護措置」が施されていること。この「放射線防護措置」としては必ずしも設備面の対策のみではなく防護具の配備、着用等運用面の対策も含まれる。「一定期間」とは、運転員が必要な交替も含め、一次冷却材喪失等の設計基準事故時に過度の被ばくなしにとどまり、必要な操作を行う期間をいう。</p>			

柏崎刈羽原子力発電所 6 / 7号炉 (2017.12.20)			東海第二発電所 (2018.9.18版)			島根原子力発電所 2号炉			備考	
実用発電用原子炉及びその附属施設の技術基準に関する規則	実用発電用原子炉及びその附属施設の技術基準に関する規則の解釈	適合方針	実用発電用原子炉及びその附属施設の技術基準に関する規則	実用発電用原子炉及びその附属施設の技術基準に関する規則の解釈	適合方針	実用発電用原子炉及びその附属施設の技術基準に関する規則	実用発電用原子炉及びその附属施設の技術基準に関する規則の解釈	適合方針		
	<p>1 2 第5項に規定する「遮蔽その他の適切な放射線防護措置」とは、一次冷却材喪失等の設計基準事故時に、原子炉制御室内にとどまり必要な操作、措置を行う運転員が過度の被ばくを受けないよう施設し、運転員が原子炉制御室に入り、とどまる間の被ばくを「実用発電用原子炉の設置、運転等に関する規則の規定に基づく線量限度等を定める告示」の第8条における緊急時作業に係る線量限度100mSv以下にできるものであることをいう。</p> <p><u>この場合における運転員の被ばく評価は、判断基準の線量限度内であることを確認すること。被ばく評価手法は、「原子力発電所中央制御室の居住性に係る被ばく評価手法について(内規)」(平成21・07・27原院第1号(平成21年8月12日原子力安全・保安院制定)) (以下「被ばく評価手法(内規)」という。)に基づくこと。</u></p> <p><u>チャコールフィルターを通らない空気の原子炉制御室への流入量については、被ばく評価手法(内規)に基づき、原子炉制御室換気設備の新設の際、原子炉制御室換気設備再循環モード時における再循環対象範囲境界部での空気の流入に影響を与える改造の際、及び、定期的に測定を行い、運転員の被ばく評価に用いている想定した空気量を下回っていることを確認すること。</u></p>	<p>・遮蔽その他の適切な放射線防護措置は、運転員の被ばく評価を「原子力発電所中央制御室の居住性に係る被ばく評価手法について(内規)」に基づき実施し、実効線量が100mSv以下となる設計とする。</p> <p>また、チャコールフィルターを通らない空気の原子炉制御室への流入量については、被ばく評価により想定した空気量を下回る設計とする。</p>		<p>1 2 第5項に規定する「遮蔽その他の適切な放射線防護措置」とは、一次冷却材喪失等の設計基準事故時に、原子炉制御室内にとどまり必要な操作、措置を行う運転員が過度の被ばくを受けないよう施設し、運転員が原子炉制御室に入り、とどまる間の被ばくを「実用発電用原子炉の設置、運転等に関する規則の規定に基づく線量限度等を定める告示」の第8条における緊急時作業に係る線量限度100mSv以下にできるものであることをいう。</p> <p><u>この場合における運転員の被ばく評価は、判断基準の線量限度内であることを確認すること。被ばく評価手法は、「原子力発電所中央制御室の居住性に係る被ばく評価手法について(内規)」(平成21・07・27原院第1号(平成21年8月12日原子力安全・保安院制定)) (以下「被ばく評価手法(内規)」という。)に基づくこと。</u></p> <p><u>チャコールフィルターを通らない空気の原子炉制御室への流入量については、被ばく評価手法(内規)に基づき、原子炉制御室換気設備の新設の際、原子炉制御室換気設備再循環モード時における再循環対象範囲境界部での空気の流入に影響を与える改造の際、及び、定期的に測定を行い、運転員の被ばく評価に用いている想定した空気量を下回っていることを確認すること。</u></p>	<p>・遮蔽その他の適切な放射線防護措置に関し、運転員の被ばく評価を「原子力発電所中央制御室の居住性に係る被ばく評価手法について(内規)」に基づき実施し、実効線量が100mSv以下であることを確認している。</p> <p>・フィルタを通らない空気の原子炉制御室への流入量については、被ばく評価により想定した空気量を下回っていることを確認している。</p>			<p>1 2 第5項に規定する「遮蔽その他の適切な放射線防護措置」とは、一次冷却材喪失等の設計基準事故時に、原子炉制御室内にとどまり必要な操作、措置を行う運転員が過度の被ばくを受けないよう施設し、運転員が原子炉制御室に入り、とどまる間の被ばくを「実用発電用原子炉の設置、運転等に関する規則の規定に基づく線量限度等を定める告示」の第8条における緊急時作業に係る線量限度100mSv以下にできるものであることをいう。</p> <p><u>この場合における運転員の被ばく評価は、判断基準の線量限度内であることを確認すること。被ばく評価手法は、「原子力発電所中央制御室の居住性に係る被ばく評価手法について(内規)」(平成21・07・27原院第1号(平成21年8月12日原子力安全・保安院制定)) (以下「被ばく評価手法(内規)」という。)に基づくこと。</u></p> <p><u>チャコールフィルターを通らない空気の原子炉制御室への流入量については、被ばく評価手法(内規)に基づき、原子炉制御室換気設備の新設の際、原子炉制御室換気設備再循環モード時における再循環対象範囲境界部での空気の流入に影響を与える改造の際、及び、定期的に測定を行い、運転員の被ばく評価に用いている想定した空気量を下回っていることを確認すること。</u></p>	<p>・遮蔽その他の適切な放射線防護措置に関し、運転員の被ばく評価を「原子力発電所中央制御室の居住性に係る被ばく評価手法について(内規)」に基づき実施し、実効線量が100mSv以下であることを確認している。</p> <p>また、チャコール・フィルターを通らない空気の中央制御室への流入量については、被ばく評価により想定した空気量を下回る設計とする。</p>	

柏崎刈羽原子力発電所 6 / 7号炉 (2017.12.20)			東海第二発電所 (2018.9.18版)			島根原子力発電所 2号炉			備考
実用発電用原子炉及びその附属施設の技術基準に関する規則	実用発電用原子炉及びその附属施設の技術基準に関する規則の解釈	適合方針	実用発電用原子炉及びその附属施設の技術基準に関する規則	実用発電用原子炉及びその附属施設の技術基準に関する規則の解釈	適合方針	実用発電用原子炉及びその附属施設の技術基準に関する規則	実用発電用原子炉及びその附属施設の技術基準に関する規則の解釈	適合方針	
	13 第5項に規定する「換気設備の隔離その他の適切な防護措置」とは、原子炉制御室外の火災等により発生した有毒ガスを原子炉制御室換気設備によって取り入れないように外気との連絡口は遮断可能であること、また、隔離時の酸欠防止を考慮して外気取入れ等の再開が可能であること。その他適切な防護措置とは、必ずしも設備面の対策のみではなく防護具の配備、着用等運用面の対策も含まれる。		<p>一 原子炉制御室及びその近傍並びに有毒ガスの発生源の近傍工場等内における有毒ガスの発生を検出するための装置及び当該装置が有毒ガスの発生を検出した場合に原子炉制御室において自動的に警報するための装置の設置</p> <p>二 原子炉制御室及びこれに連絡する通路並びに運転員その他の従事者が原子炉制御室に出入りするための区域遮蔽その他の適切な放射線防護措置、気体状の放射性物質及び原子炉制御室外の火災により発生する燃焼ガスに対する換気設備の隔離その他の適切な防護措置</p>	<p>13 第5項に規定する「当該措置をとるための操作を行うことができる」には、有毒ガスの発生時において、原子炉制御室の運転員の吸気中の有毒ガス濃度を有毒ガス防護のための判断基準値以下とすることを含む。「防護措置」には、必ずしも設備面の対策のみではなく防護具の配備、着用等運用面の対策を含む。</p> <p>14 第5項第1号に規定する「工場等内における有毒ガスの発生を検出するための装置及び当該装置が有毒ガスの発生を検出した場合に原子炉制御室において自動的に警報するための装置の設置」については「有毒ガスの発生を検出し警報するための装置に関する要求事項（別記-9）」によること。</p> <p>15 第5項第2号に規定する「換気設備の隔離」とは、原子炉制御室外の火災により発生した燃焼ガスを原子炉制御室換気設備によって取り入れないように外気との連絡口を遮断することをいい、「換気設備」とは、隔離時の酸欠防止を考慮して外気取入れ等の再開が可能であるものをいう。</p>	<p>・「実用発電用原子炉及びその附属施設の位置、構造及び設備の基準に関する規則」第26条第3項第1号に同じ。</p>	<p>13 第5項に規定する「当該措置をとるための操作を行うことができる」には、有毒ガスの発生時において、原子炉制御室の運転員の吸気中の有毒ガス濃度を有毒ガス防護のための判断基準値以下とすることを含む。「防護措置」には、必ずしも設備面の対策のみではなく防護具の配備、着用等運用面の対策を含む。</p> <p>14 第5項第1号に規定する「工場等内における有毒ガスの発生を検出するための装置及び当該装置が有毒ガスの発生を検出した場合に原子炉制御室において自動的に警報するための装置の設置」については「有毒ガスの発生を検出し警報するための装置に関する要求事項（別記-9）」によること。</p> <p>15 第5項第2号に規定する「換気設備の隔離」とは、原子炉制御室外の火災により発生した燃焼ガスを原子炉制御室換気設備によって取り入れないように外気との連絡口を遮断することをいい、「換気設備」とは、隔離時の酸欠防止を考慮して外気取入れ等の再開が可能であるものをいう。</p>			

柏崎刈羽原子力発電所 6 / 7号炉 (2017.12.20)			東海第二発電所 (2018.9.18版)			島根原子力発電所 2号炉			備考
実用発電用原子炉及びその附属施設の技術基準に関する規則	実用発電用原子炉及びその附属施設の技術基準に関する規則の解釈	適合方針	実用発電用原子炉及びその附属施設の技術基準に関する規則	実用発電用原子炉及びその附属施設の技術基準に関する規則の解釈	適合方針	実用発電用原子炉及びその附属施設の技術基準に関する規則	実用発電用原子炉及びその附属施設の技術基準に関する規則の解釈	適合方針	
6 原子炉制御室には、酸素濃度計を施設しなければならない。	1 6 第6項に規定する「酸素濃度計」は、設計基準事故時において、外気から原子炉制御室への空気の取り込みを、一時的に停止した場合に、事故対策のための活動に支障のない酸素濃度の範囲にあることが正確に把握できるものであること。また、所定の精度を保証するものであれば、常設設備、可搬型を問わない。	・中央制御室には、酸素濃度・二酸化炭素濃度計を配備する設計とする。	6 原子炉制御室には、酸素濃度計を施設しなければならない。	1 4 第6項に規定する「酸素濃度計」は、設計基準事故時において、外気から原子炉制御室への空気の取り込みを、一時的に停止した場合に、事故対策のための活動に支障のない酸素濃度の範囲にあることが正確に把握できるものであること。また、所定の精度を保証するものであれば、常設設備、可搬型を問わない。	中央制御室には、酸素濃度計及び二酸化炭素濃度計を配備する。	6 原子炉制御室には、酸素濃度計を施設しなければならない。	1 6 第6項に規定する「酸素濃度計」は、設計基準事故時において、外気から原子炉制御室への空気の取り込みを、一時的に停止した場合に、事故対策のための活動に支障のない酸素濃度の範囲にあることが正確に把握できるものであること。また、所定の精度を保証するものであれば、常設設備、可搬型を問わない。	・中央制御室には、酸素濃度計、二酸化炭素濃度計を配備する設計とする。	

柏崎刈羽原子力発電所 6 / 7号炉 (2017.12.20)	東海第二発電所 (2018.9.18版)	島根原子力発電所 2号炉	備考																		
<p>(2) 重大事故等への対処</p> <p>原子炉制御室に関する重大事故等への対処のための追加要求事項と、その適合方針は以下、表1.1-3 のとおりである。</p>	<p>(2) 重大事故等への対処</p> <p>原子炉制御室について、「<u>「実用発電用原子炉及びその附属施設の位置、構造及び設備の基準に関する規則」第59条及び「実用発電用原子炉及びその附属施設の技術基準に関する規則」第74条における追加要求事項を明確化する。</u>原子炉制御室に関する重大事故等への対処のための追加要求事項及びその適合方針は、以下の第1.1-3表のとおりである。</p>	<p>(2) 重大事故等への対処</p> <p>原子炉制御室に関する重大事故等への対処のための追加要求事項と、その適合方針は以下、表1.1-3のとおりである。</p>																			
<p>表1.1-3 「<u>「実用発電用原子炉及びその附属施設の位置、構造及び設備の基準に関する規則」第五十九条（運転員が原子炉制御室にとどまるための設備）</u></p>	<p>第1.1-3表 「<u>「実用発電用原子炉及びその附属施設の位置、構造及び設備の基準に関する規則」第59条（運転員が原子炉制御室にとどまるための設備）</u></p>	<p>表1.1-3 「<u>「実用発電用原子炉及びその附属施設の位置、構造及び設備の基準に関する規則」第五十九条（運転員が原子炉制御室にとどまるための設備）</u></p>																			
<table border="1"> <thead> <tr> <th data-bbox="124 688 394 808">実用発電用原子炉及びその附属施設の位置、構造及び設備の基準に関する規則</th> <th data-bbox="403 688 652 808">実用発電用原子炉及びその附属施設の位置、構造及び設備の基準に関する規則の解釈</th> <th data-bbox="661 688 914 808">適合方針</th> </tr> </thead> <tbody> <tr> <td data-bbox="124 814 394 1495"> <p>（運転員が原子炉制御室にとどまるための設備） 第五十九条 発電用原子炉施設には、炉心の著しい損傷が発生した場合（重大事故等対処施設を構成するものを除く。）が有する原子炉格納容器の破損を防止するための機能が損なわれた場合を除く。）においても運転員が第二十六条第一項の規定により設置される原子炉制御室にとどまるために必要な設備を設けなければならない。</p> </td> <td data-bbox="403 814 652 1495"> <p>（運転員が原子炉制御室にとどまるための設備） 1 第59条に規定する「重大事故等対処施設（特定重大事故等対処施設を構成するものを除く。）が有する原子炉格納容器の破損を防止するための機能が損なわれた場合」とは、第49条、第50条、第51条又は第52条の規定により設置されるいずれかの設備の原子炉格納容器の破損を防止するための機能が喪失した場合をいう。</p> </td> <td data-bbox="661 814 914 1495"> <p>（重大事故等に対処するために必要なパラメータについても監視できる設計とする。）</p> </td> </tr> </tbody> </table>	実用発電用原子炉及びその附属施設の位置、構造及び設備の基準に関する規則	実用発電用原子炉及びその附属施設の位置、構造及び設備の基準に関する規則の解釈	適合方針	<p>（運転員が原子炉制御室にとどまるための設備） 第五十九条 発電用原子炉施設には、炉心の著しい損傷が発生した場合（重大事故等対処施設を構成するものを除く。）が有する原子炉格納容器の破損を防止するための機能が損なわれた場合を除く。）においても運転員が第二十六条第一項の規定により設置される原子炉制御室にとどまるために必要な設備を設けなければならない。</p>	<p>（運転員が原子炉制御室にとどまるための設備） 1 第59条に規定する「重大事故等対処施設（特定重大事故等対処施設を構成するものを除く。）が有する原子炉格納容器の破損を防止するための機能が損なわれた場合」とは、第49条、第50条、第51条又は第52条の規定により設置されるいずれかの設備の原子炉格納容器の破損を防止するための機能が喪失した場合をいう。</p>	<p>（重大事故等に対処するために必要なパラメータについても監視できる設計とする。）</p>	<table border="1"> <thead> <tr> <th data-bbox="923 688 1193 808">実用発電用原子炉及びその附属施設の位置、構造及び設備の基準に関する規則</th> <th data-bbox="1202 688 1451 808">実用発電用原子炉及びその附属施設の位置、構造及び設備の基準に関する規則の解釈</th> <th data-bbox="1460 688 1703 808">適合方針</th> </tr> </thead> <tbody> <tr> <td data-bbox="923 814 1193 1495"> <p>（運転員が原子炉制御室にとどまるための設備） 第五十九条 発電用原子炉施設には、炉心の著しい損傷が発生した場合（重大事故等対処施設を構成するものを除く。）が有する原子炉格納容器の破損を防止するための機能が損なわれた場合を除く。）においても運転員が第二十六条第一項の規定により設置される原子炉制御室にとどまるために必要な設備を設けなければならない。</p> </td> <td data-bbox="1202 814 1451 1495"> <p>第59条（運転員が原子炉制御室にとどまるための設備） 1 第59条に規定する「重大事故等対処施設（特定重大事故等対処施設を構成するものを除く。）が有する原子炉格納容器の破損を防止するための機能が損なわれた場合」とは、第49条、第50条、第51条又は第52条の規定により設置されるいずれかの設備の原子炉格納容器の破損を防止するための機能が喪失した場合をいう。</p> </td> <td data-bbox="1460 814 1703 1495"></td> </tr> </tbody> </table>	実用発電用原子炉及びその附属施設の位置、構造及び設備の基準に関する規則	実用発電用原子炉及びその附属施設の位置、構造及び設備の基準に関する規則の解釈	適合方針	<p>（運転員が原子炉制御室にとどまるための設備） 第五十九条 発電用原子炉施設には、炉心の著しい損傷が発生した場合（重大事故等対処施設を構成するものを除く。）が有する原子炉格納容器の破損を防止するための機能が損なわれた場合を除く。）においても運転員が第二十六条第一項の規定により設置される原子炉制御室にとどまるために必要な設備を設けなければならない。</p>	<p>第59条（運転員が原子炉制御室にとどまるための設備） 1 第59条に規定する「重大事故等対処施設（特定重大事故等対処施設を構成するものを除く。）が有する原子炉格納容器の破損を防止するための機能が損なわれた場合」とは、第49条、第50条、第51条又は第52条の規定により設置されるいずれかの設備の原子炉格納容器の破損を防止するための機能が喪失した場合をいう。</p>		<table border="1"> <thead> <tr> <th data-bbox="1712 688 1982 808">実用発電用原子炉及びその附属施設の位置、構造及び設備の基準に関する規則</th> <th data-bbox="1991 688 2240 808">実用発電用原子炉及びその附属施設の位置、構造及び設備の基準に関する規則の解釈</th> <th data-bbox="2249 688 2493 808">適合方針</th> </tr> </thead> <tbody> <tr> <td data-bbox="1712 814 1982 1495"> <p>（運転員が原子炉制御室にとどまるための設備） 第五十九条 発電用原子炉施設には、炉心の著しい損傷が発生した場合（重大事故等対処施設を構成するものを除く。）が有する原子炉格納容器の破損を防止するための機能が損なわれた場合を除く。）においても運転員が第二十六条第一項の規定により設置される原子炉制御室にとどまるために必要な設備を設けなければならない。</p> </td> <td data-bbox="1991 814 2240 1495"> <p>（運転員が原子炉制御室にとどまるための設備） 1 第59条に規定する「重大事故等対処施設（特定重大事故等対処施設を構成するものを除く。）が有する原子炉格納容器の破損を防止するための機能が損なわれた場合」とは、第49条、第50条、第51条又は第52条の規定により設置されるいずれかの設備の原子炉格納容器の破損を防止するための機能が喪失した場合をいう。</p> </td> <td data-bbox="2249 814 2493 1495"> <p>（重大事故等に対処するために必要なパラメータについても監視できる設計とする。）</p> </td> </tr> </tbody> </table>	実用発電用原子炉及びその附属施設の位置、構造及び設備の基準に関する規則	実用発電用原子炉及びその附属施設の位置、構造及び設備の基準に関する規則の解釈	適合方針	<p>（運転員が原子炉制御室にとどまるための設備） 第五十九条 発電用原子炉施設には、炉心の著しい損傷が発生した場合（重大事故等対処施設を構成するものを除く。）が有する原子炉格納容器の破損を防止するための機能が損なわれた場合を除く。）においても運転員が第二十六条第一項の規定により設置される原子炉制御室にとどまるために必要な設備を設けなければならない。</p>	<p>（運転員が原子炉制御室にとどまるための設備） 1 第59条に規定する「重大事故等対処施設（特定重大事故等対処施設を構成するものを除く。）が有する原子炉格納容器の破損を防止するための機能が損なわれた場合」とは、第49条、第50条、第51条又は第52条の規定により設置されるいずれかの設備の原子炉格納容器の破損を防止するための機能が喪失した場合をいう。</p>	<p>（重大事故等に対処するために必要なパラメータについても監視できる設計とする。）</p>	
実用発電用原子炉及びその附属施設の位置、構造及び設備の基準に関する規則	実用発電用原子炉及びその附属施設の位置、構造及び設備の基準に関する規則の解釈	適合方針																			
<p>（運転員が原子炉制御室にとどまるための設備） 第五十九条 発電用原子炉施設には、炉心の著しい損傷が発生した場合（重大事故等対処施設を構成するものを除く。）が有する原子炉格納容器の破損を防止するための機能が損なわれた場合を除く。）においても運転員が第二十六条第一項の規定により設置される原子炉制御室にとどまるために必要な設備を設けなければならない。</p>	<p>（運転員が原子炉制御室にとどまるための設備） 1 第59条に規定する「重大事故等対処施設（特定重大事故等対処施設を構成するものを除く。）が有する原子炉格納容器の破損を防止するための機能が損なわれた場合」とは、第49条、第50条、第51条又は第52条の規定により設置されるいずれかの設備の原子炉格納容器の破損を防止するための機能が喪失した場合をいう。</p>	<p>（重大事故等に対処するために必要なパラメータについても監視できる設計とする。）</p>																			
実用発電用原子炉及びその附属施設の位置、構造及び設備の基準に関する規則	実用発電用原子炉及びその附属施設の位置、構造及び設備の基準に関する規則の解釈	適合方針																			
<p>（運転員が原子炉制御室にとどまるための設備） 第五十九条 発電用原子炉施設には、炉心の著しい損傷が発生した場合（重大事故等対処施設を構成するものを除く。）が有する原子炉格納容器の破損を防止するための機能が損なわれた場合を除く。）においても運転員が第二十六条第一項の規定により設置される原子炉制御室にとどまるために必要な設備を設けなければならない。</p>	<p>第59条（運転員が原子炉制御室にとどまるための設備） 1 第59条に規定する「重大事故等対処施設（特定重大事故等対処施設を構成するものを除く。）が有する原子炉格納容器の破損を防止するための機能が損なわれた場合」とは、第49条、第50条、第51条又は第52条の規定により設置されるいずれかの設備の原子炉格納容器の破損を防止するための機能が喪失した場合をいう。</p>																				
実用発電用原子炉及びその附属施設の位置、構造及び設備の基準に関する規則	実用発電用原子炉及びその附属施設の位置、構造及び設備の基準に関する規則の解釈	適合方針																			
<p>（運転員が原子炉制御室にとどまるための設備） 第五十九条 発電用原子炉施設には、炉心の著しい損傷が発生した場合（重大事故等対処施設を構成するものを除く。）が有する原子炉格納容器の破損を防止するための機能が損なわれた場合を除く。）においても運転員が第二十六条第一項の規定により設置される原子炉制御室にとどまるために必要な設備を設けなければならない。</p>	<p>（運転員が原子炉制御室にとどまるための設備） 1 第59条に規定する「重大事故等対処施設（特定重大事故等対処施設を構成するものを除く。）が有する原子炉格納容器の破損を防止するための機能が損なわれた場合」とは、第49条、第50条、第51条又は第52条の規定により設置されるいずれかの設備の原子炉格納容器の破損を防止するための機能が喪失した場合をいう。</p>	<p>（重大事故等に対処するために必要なパラメータについても監視できる設計とする。）</p>																			

柏崎刈羽原子力発電所 6 / 7号炉 (2017.12.20)			東海第二発電所 (2018.9.18版)			島根原子力発電所 2号炉			備考	
実用発電用原子炉及びその附属施設の位置、構造及び設備の基準に関する規則	実用発電用原子炉及びその附属施設の位置、構造及び設備の基準に関する規則の解釈	適合方針	実用発電用原子炉及びその附属施設の位置、構造及び設備の基準に関する規則	実用発電用原子炉及びその附属施設の位置、構造及び設備の基準に関する規則の解釈	適合方針	実用発電用原子炉及びその附属施設の位置、構造及び設備の基準に関する規則	実用発電用原子炉及びその附属施設の位置、構造及び設備の基準に関する規則の解釈	適合方針		
	<p>2 第59条に規定する「運転員が第26条第1項の規定により設置される原子炉制御室にとどまるために必要な設備」とは、以下に掲げる措置又はこれらと同等以上の効果を有する措置を行うための設備をいう。</p> <p>a) 原子炉制御室用の電源(空調及び照明等)は、代替交流電源設備からの給電を可能とすること。</p> <p>b) 炉心の著しい損傷が発生した場合の原子炉制御室の居住性について、次の要件を満たすものであること。</p> <p>①本規程第37条の想定する格納容器破損モードのうち、原子炉制御室の運転員の被ばくの観点から結果が最も厳しくなる事故収束に成功した事故シーケンス(例えば、炉心の著しい損傷の後、格納容器圧力逃がし装置等の格納容器破損防止対策が有効に機能した場合)を想定すること。</p>	<p>・中央制御室には、炉心の著しい損傷が発生した場合においても運転員がとどまるために必要な設備(可搬型陽圧化空調機及び非常用照明)を設置する設計とする。</p> <p>重大事故発生時において運転員がとどまるために必要な設備(可搬型陽圧化空調機及び非常用照明)は、代替交流電源設備から給電可能となる設計とする。</p> <p>・炉心の著しい損傷が発生した場合においても、中央制御室にとどまる運転員の実効線量が7日間で100mSvを超えない設計とする。</p> <p>・中央制御室の運転員の被ばくの観点から結果が最も厳しくなる事故収束に成功した事故シーケンスとして、格納容器過圧の破損モードを想定した設計とする。また、大破断LOCA時に非常用炉心冷却系の機能及び全交流動力電源が喪失したシーケンスを選定し設計する。</p>		<p>2 第59条に規定する「運転員が第26条第1項の規定により設置される原子炉制御室にとどまるために必要な設備」とは、以下に掲げる措置又はこれらと同等以上の効果を有する措置を行うための設備をいう。</p> <p>a) 原子炉制御室用の電源(空調及び照明等)は、代替交流電源設備からの給電を可能とすること。</p> <p>b) 炉心の著しい損傷が発生した場合の原子炉制御室の居住性について、次の要件を満たすものであること。</p> <p>① 本規程第37条の想定する格納容器破損モードのうち、原子炉制御室の運転員の被ばくの観点から結果が最も厳しくなる事故収束に成功した事故シーケンス(例えば、炉心の著しい損傷の後、格納容器圧力逃がし装置等の格納容器破損防止対策が有効に機能した場合)を想定すること。</p>	<p>・中央制御室には、重大事故が発生した場合においても運転員がとどまるために必要な設備(中央制御室換気系、原子炉建屋ガス処理系及び可搬型照明(SA)等)を設置する設計とする。</p> <p>・重大事故発生時において、運転員がとどまるために必要な設備(中央制御室換気系、原子炉建屋ガス処理系及び可搬型照明(SA)等)は、常設代替交流電源設備から給電可能な設計とする。</p> <p>・炉心の著しい損傷が発生した場合においても、中央制御室にとどまる運転員の実効線量が7日間で100mSvを超えない設計とする。</p> <p>・原子炉制御室の運転員の被ばくの観点から結果が最も厳しくなる事故収束に成功した事故シーケンスとして、格納容器破損モードにおいて想定している、大破断LOCA時に高圧炉心冷却及び低圧炉心冷却に失敗するシーケンス(代替循環冷却系を使用しない場合)を選定する。</p>		<p>2 第59条に規定する「運転員が第26条第1項の規定により設置される原子炉制御室にとどまるために必要な設備」とは、以下に掲げる措置又はこれらと同等以上の効果を有する措置を行うための設備をいう。</p> <p>a) 原子炉制御室用の電源(空調及び照明等)は、代替交流電源設備からの給電を可能とすること。</p> <p>b) 炉心の著しい損傷が発生した場合の原子炉制御室の居住性について、次の要件を満たすものであること。</p> <p>①本規程第37条の想定する格納容器破損モードのうち、原子炉制御室の運転員の被ばくの観点から結果が最も厳しくなる事故収束に成功した事故シーケンス(例えば、炉心の著しい損傷の後、格納容器圧力逃がし装置等の格納容器破損防止対策が有効に機能した場合)を想定すること。</p>	<p>・中央制御室には、炉心の著しい損傷が発生した場合においても運転員がとどまるために必要な設備(中央制御室換気系及びLEDライト(三脚タイプ))を設置する設計とする。</p> <p>重大事故発生時において運転員がとどまるために必要な設備(中央制御室換気系及びLEDライト(三脚タイプ))は、代替交流電源設備から給電可能となる設計とする。</p> <p>・炉心の著しい損傷が発生した場合においても、中央制御室にとどまる運転員の実効線量が7日間で100mSvを超えない設計とする。</p> <p>・中央制御室の運転員の被ばくの観点から結果が最も厳しくなる事故収束に成功した事故シーケンスとして、格納容器過圧の破損モードにおいて想定している、「冷却材喪失(大破断LOCA)+ECS注水機能喪失+全交流動力電源喪失」シーケンスを選定する。</p>		<p>・設備の相違</p> <p>【柏崎6/7,東海第二】</p> <p>島根2号炉は常設の中央制御室換気系を用いて居住性を確保する(以下,②の相違)</p>

柏崎刈羽原子力発電所 6 / 7号炉 (2017.12.20)			東海第二発電所 (2018.9.18版)			島根原子力発電所 2号炉			備考
実用発電用原子炉及びその附属施設の位置、構造及び設備の基準に関する規則	実用発電用原子炉及びその附属施設の位置、構造及び設備の基準に関する規則の解釈	適合方針	実用発電用原子炉及びその附属施設の位置、構造及び設備の基準に関する規則	実用発電用原子炉及びその附属施設の位置、構造及び設備の基準に関する規則の解釈	適合方針	実用発電用原子炉及びその附属施設の位置、構造及び設備の基準に関する規則	実用発電用原子炉及びその附属施設の位置、構造及び設備の基準に関する規則の解釈	適合方針	
	<p>②運転員はマスクの着用を考慮してもよい。ただしその場合は、実施のための体制を整備すること。</p> <p>③交代要員体制を考慮してもよい。ただしその場合は、実施のための体制を整備すること。</p> <p>④判断基準は、運転員の実効線量が7日間で100mSvを超えないこと。</p> <p>c) 原子炉制御室の外側が放射性物質により汚染したような状況下において、原子炉制御室への汚染の持ち込みを防止するため、モニタリング及び作業服の着替え等を行うための区画を設けること。</p>	<p>・運転員は、中央制御室滞在時及び交替のための入退域時ともにマスクの着用を考慮する設計とする。</p> <p>・運転員は5直2交代勤務を前提に評価を行うが、積算の被ばく線量が最も厳しくなる格納容器ベント実施時に中央制御室に滞在する運転員の勤務形態を考慮のうえ設計する。</p> <p>・中央制御室の外側が放射性物質により汚染した状況下で、モニタリング、作業服の着替え等により中央制御室への汚染の持ち込みを防止するための区画を、中央制御室出入口近傍に設ける設計とする。</p>		<p>② 運転員はマスクの着用を考慮してもよい。ただしその場合は、実施のための体制を整備すること。</p> <p>③ 交代要員体制を考慮してもよい。ただしその場合は、実施のための体制を整備すること。</p> <p>④ 判断基準は、運転員の実効線量が7日間で100mSvを超えないこと。</p> <p>c) 原子炉制御室の外側が放射性物質により汚染したような状況下において、原子炉制御室への汚染の持ち込みを防止するため、モニタリング及び作業服の着替え等を行うための区画を設けること。</p>	<p>・マスクの着用を考慮し、その実施のための体制を整備する。</p> <p>・運転員は5直2交代勤務を前提に評価を行うが、積算の被ばく線量が最も厳しくなる格納容器ベント実施時に中央制御室に滞在する運転員の勤務形態を考慮する。</p> <p>・中央制御室への汚染の持ち込みを防止するため、身体への汚染検査(モニタリング)を行うためのサーベイエリア、脱衣(作業服の着替え)を行うための脱衣エリア、身体に付着した放射性物質を除去するための除染エリア及びサーベイエリア等から中央制御室への放射性物質の持ち込みを防止するためのクリーンエリアを設ける設計とする。</p> <p>・テントハウス及び扉付シート壁並びにチェンジングエリアと中央制御室の間の気密扉により中央制御室への汚染の持ち込みを防止する設計とする。</p>		<p>②運転員はマスクの着用を考慮してもよい。ただしその場合は、実施のための体制を整備すること。</p> <p>③交代要員体制を考慮してもよい。ただしその場合は、実施のための体制を整備すること。</p> <p>④判断基準は、運転員の実効線量が7日間で100mSvを超えないこと。</p> <p>c) 原子炉制御室の外側が放射性物質により汚染したような状況下において、原子炉制御室への汚染の持ち込みを防止するため、モニタリング及び作業服の着替え等を行うための区画を設けること。</p>	<p>・運転員は、中央制御室滞在時及び交替のための入退域時ともにマスクの着用を考慮する設計とする。</p> <p>・運転員は、4直2交代勤務を前提に評価を行うが、積算被ばく線量が最も厳しくなる格納容器ベント実施時に中央制御室に滞在する運転員の勤務形態を考慮する。</p> <p>・中央制御室の外側が放射性物質により汚染した状況下で、モニタリング、作業服の着替え等により中央制御室への汚染の持ち込みを防止するための区画を、中央制御室出入口近傍に設ける設計とする。</p>	<p>・運用の相違</p> <p>【柏崎6/7,東海第二】 島根2号炉は、日勤班に期待しない4直2交代による通常交替勤務を前提に評価を行う。</p>

柏崎刈羽原子力発電所 6 / 7号炉 (2017.12.20)			東海第二発電所 (2018.9.18版)			島根原子力発電所 2号炉			備考
実用発電用原子炉及びその附属施設の位置、構造及び設備の基準に関する規則	実用発電用原子炉及びその附属施設の位置、構造及び設備の基準に関する規則の解釈	適合方針	実用発電用原子炉及びその附属施設の位置、構造及び設備の基準に関する規則	実用発電用原子炉及びその附属施設の位置、構造及び設備の基準に関する規則の解釈	適合方針	実用発電用原子炉及びその附属施設の位置、構造及び設備の基準に関する規則	実用発電用原子炉及びその附属施設の位置、構造及び設備の基準に関する規則の解釈	適合方針	
	<p>d) 上記b)の原子炉制御室の居住性を確保するために原子炉格納容器から漏えいする空気中の放射性物質の濃度を低減する必要がある場合は、非常用ガス処理系等(BWRの場合)又はアニュラス空気再循環設備等(PWRの場合)を設置すること。</p> <p>e) BWRにあっては、上記b)の原子炉制御室の居住性を確保するために原子炉建屋に設置されたブローアウトパネルを閉止する必要がある場合は、現場において、人力により容易かつ確実に閉止操作ができること。</p>	<p>・中央制御室の居住性を確保するために原子炉格納容器から漏えいする空気中の放射性物質の濃度を低減するため、非常用ガス処理系を設置する設計とする。</p> <p>・原子炉建屋原子炉区域の気密バウンダリの一部として原子炉建屋に設置する原子炉建屋ブローアウトパネルは、閉状態の維持又は解放時に遠隔で閉止可能な設計とするとともに、近接可能な場合は、現場において、人力により容易かつ確実に閉止可能な設計とする。</p>		<p>d) 上記b)の原子炉制御室の居住性を確保するために原子炉格納容器から漏えいした空気中の放射性物質の濃度を低減する必要がある場合は、非常用ガス処理系等(BWRの場合)又はアニュラス空気再循環設備等(PWRの場合)を設置すること。</p> <p>e) BWRにあっては、上記b)の原子炉制御室の居住性を確保するために原子炉建屋に設置されたブローアウトパネルを閉止する必要がある場合は、容易かつ確実に閉止操作ができること。また、ブローアウトパネルは、現場において人力による操作が可能なものとする。</p>		<p>d) 上記b)の原子炉制御室の居住性を確保するために原子炉格納容器から漏えいする空気中の放射性物質の濃度を低減する必要がある場合は、非常用ガス処理系等(BWRの場合)又はアニュラス空気再循環設備等(PWRの場合)を設置すること。</p> <p>e) BWRにあっては、上記b)の原子炉制御室の居住性を確保するために原子炉建屋に設置されたブローアウトパネルを閉止する必要がある場合は、容易かつ確実に閉止操作ができること。また、ブローアウトパネルは、現場において、人力による操作が可能なものとする。</p>	<p>・中央制御室の居住性を確保するために原子炉格納容器から漏えいする空気中の放射性物質の濃度を低減するため、非常用ガス処理系を設置する設計とする。</p> <p>・中央制御室の居住性を確保するために原子炉建屋原子炉棟の気密バウンダリを形成する必要がある場合において、原子炉建物燃料取替階ブローアウトパネル閉止装置は容易かつ確実に閉止できる設計とする。また、原子炉建物燃料取替階ブローアウトパネル閉止装置は、中央制御室から遠隔操作又は現場において人力により操作可能な設計とする。</p>		<p>・設備及び運用の相違 【柏崎6/7,東海第二】 島根2号炉は、ブローアウトパネル部を閉止する必要がある場合にはブローアウトパネル閉止装置を閉止する。(以下,③の相違)</p>
<p>※「実用発電用原子炉及びその附属施設の技術基準に関する規則」第七十四条(運転員が原子炉制御室にとどまるための設備)も同様の記載のため、省略する。</p> <p>原子炉制御室に設置する設備のうち、重大事故対処設備に関する概要を表1.1-4に示す。</p>			<p>※ なお、「実用発電用原子炉及びその附属施設の技術基準に関する規則」第74条(運転員が原子炉制御室にとどまるための設備)も同様の記載のため、省略する。</p>			<p>※「実用発電用原子炉及びその附属施設の技術基準に関する規則」第七十四条(運転員が原子炉制御室にとどまるための設備)も同様の記載のため、省略する。</p> <p>原子炉制御室に設置する設備のうち、重大事故対処設備に関する概要を表1.1-4に示す。</p>			

表 1.1-4 重大事故対処設備に関する概要 (59条 運転員が原子炉制御室にとどまるための設備) (1/2)

系統機能	設備	代替する機能を有する設計基準対象施設		設備種別	設備分類	
		設備	重要度分類		分類	機器クラス
居住性の確保	中央制御室	(中央制御室)	(S)	常設	(重大事故等対処施設)	-
	中央制御室待避室	-	-	常設	(重大事故等対処施設)	-
	中央制御室遮蔽	(中央制御室遮蔽)	(S)	常設	常設耐震重要重大事故防止設備 常設重大事故緩和設備 ^{※1}	-
	中央制御室待避室遮蔽	-	-	常設	常設重大事故緩和設備	-
	中央制御室可搬型備置空調機 (空調機)	中央制御室可搬型備置空調機	S	可搬	可搬型重大事故防止設備 可搬型重大事故緩和設備	-
	衛星電話設備 (常設)	-	-	可搬	可搬型重大事故緩和設備	SA-3
	データ表示装置 (待避室)	-	-	常設	常設重大事故等対処設備 (防止でも緩和でもない設備)	-
	遮音計 ^{※2}	-	-	可搬	可搬型重大事故等対処設備 (防止でも緩和でもない設備)	-
	酸濃度・二酸化炭素濃度計 ^{※2}	-	-	可搬	可搬型重大事故等対処設備 (防止でも緩和でもない設備)	-
	中央制御室可搬型備置空調機 (空調機)	中央制御室可搬型備置空調機	S	可搬	可搬型重大事故防止設備 可搬型重大事故緩和設備	SA-3
	用信機 ^{※2}	中央制御室用信機	-	可搬	可搬型重大事故防止設備 可搬型重大事故緩和設備	SA-2
	中央制御室待避室備置空調機 (配管・弁) (待避室)	中央制御室待避室備置空調機 (配管・弁) (待避室)	-	常設	常設重大事故緩和設備	SA-2
	中央制御室待避室換気装置 (配管・弁) (待避室)	中央制御室待避室換気装置 (配管・弁) (待避室)	-	常設	常設耐震重要重大事故防止設備 常設重大事故緩和設備 ^{※1}	SA-2
中央制御室換気装置 (配管・弁) (待避室)	中央制御室換気装置 (配管・弁) (待避室)	-	常設	常設耐震重要重大事故防止設備 常設重大事故緩和設備 ^{※1}	SA-2	

※1 常設耐震重要重大事故防止設備・常設重大事故緩和設備等を操作する人が健全であることを担保する常設設備であるため、本分類とする。
 ※2 計測器本体を示すための計器名を記載
 ※3 可搬型備置空調機による備置化においてパワングリを構成し、空気の入れ替えを確保する常設設備であるため、本文類とする。

表 1.1-4 重大事故対処設備に関する概要 (59条 運転員が原子炉制御室にとどまるための設備) (1 / 2)

系統機能	設備	代替する機能を有する設計基準対象施設		設備種別	設備分類	機器クラス
		設備	重要度分類			
居住性の確保	中央制御室	(中央制御室)	(S)	常設	(重大事故等対処施設)	-
	中央制御室待避室	-	-	常設	(重大事故等対処施設)	-
	中央制御室遮蔽	(中央制御室遮蔽)	(S)	常設	常設耐震重要重大事故防止設備 常設重大事故緩和設備 ^{※1}	-
	中央制御室待避室遮蔽	-	-	常設	常設重大事故緩和設備	-
	再循環用ファン	-	-	常設	常設耐震重要重大事故防止設備 常設重大事故緩和設備 ^{※1}	-
	チャコール・フィルタ・ブースタ・ファン	(中央制御室換気系)	(S)	常設	常設耐震重要重大事故防止設備 常設重大事故緩和設備 ^{※1}	-
	非常用チャコール・フィルタ・ユニット	-	-	常設	常設耐震重要重大事故防止設備 常設重大事故緩和設備 ^{※1}	-
	中央制御室待避室正圧化装置 (空気ポンプ)	-	-	可搬型	可搬型重大事故緩和設備	SA-3
	無線通信設備 (固定型)	62条に記載				
	衛星電話設備 (固定型)	62条に記載				
	プラントパラメータ監視装置 (中央制御室待避室)	-	-	可搬型	可搬型重大事故等対処設備 (防止でも緩和でもない設備)	-
	差圧計 ^{※2}	-	-	常設	常設重大事故等対処設備 (防止でも緩和でもない設備)	-
	酸濃度計 ^{※2}	-	-	可搬型	可搬型重大事故等対処設備 (防止でも緩和でもない設備)	-
二酸化炭素濃度計 ^{※2}	-	-	可搬型	可搬型重大事故等対処設備 (防止でも緩和でもない設備)	-	

※1 : 常設耐震重要重大事故防止設備・常設重大事故緩和設備等を操作する人が健全であることを担保する常設設備であるため、本分類とする
 ※2 : 計測器本体を示すため計器名を記載

・記載内容の相違
 【東海第二】
 島根2号炉は重大事故対処設備の概要を記載
 ・設備の相違
 【柏崎6,7】
 ②の相違

表 1.1-4 重大事故対処設備に関する概要 (59条 運転員が原子炉制御室にとどまるための設備) (2/2)

系統機能	設備	代替する機能を有する設計基準対象施設		設備分類	機器クラス
		設備	耐震重要度分類		
居住性の確保 (つづき)	無線連絡設備 (常設) (屋外アンテナ) [伝送路]	中央制御室照明	-	可搬型	-
	衛星電話設備 (常設) (屋外アンテナ) [伝送路]				
照明の確保	可搬型蓄電池内蔵型照明				
狭ばく線量の低減	非常用ガス処理系排風機			可搬型	可搬型重大事故等対処設備 (防止でも緩和でもない設備)
	非常用ガス処理系フィルタ装置 [流路]			常設	常設重大事故緩和設備
	非常用ガス処理系漏れ除去装置 [流路]			常設	常設重大事故緩和設備 SA-2
	非常用ガス処理系配管・弁 [流路]			常設	常設重大事故緩和設備 SA-2
	主排気筒 (内筒) [流路]			常設	常設重大事故緩和設備 SA-2
原子炉建屋原子炉区域 [流路]					
その他の設備に記載 (うち、常設重大事故緩和設備)					

表 1.1-4 重大事故対処設備に関する概要 (59条 運転員が原子炉制御室にとどまるための設備) (2/2)

系統機能	設備	代替する機能を有する設計基準対象施設		設備種類	設備分類		
		設備	耐震重要度分類		分類	機器クラス	
居住性の確保	中央制御室換気系ダクト [流路]	(中央制御室換気系)	(S)	常設	常設耐震重要重大事故防止設備	SA-2	
	中央制御室待避室 [流路]			常設	常設重大事故緩和設備	SA-2	
照明の確保	中央制御室換気系弁 [流路]	(中央制御室換気系)	(S)	常設	常設耐震重要重大事故防止設備	SA-2	
	無線通信設備 (屋外アンテナ) [伝送路]			62条に記載			
	衛星電話設備 (屋外アンテナ) [伝送路]			62条に記載			
	LEDライト (三脚タイプ)			非常用照明	可搬型	可搬型重大事故等対処設備 (防止でも緩和でもない設備)	-
	非常用ガス処理系排気ファン				常設	常設重大事故緩和設備	-
	前置ガス処理装置 [流路]				常設	常設重大事故緩和設備	SA-2
	後置ガス処理装置 [流路]				常設	常設重大事故緩和設備	SA-2
	非常用ガス処理系配管・弁 [流路]				常設	常設重大事故緩和設備	SA-2
	排気管 [流路]				常設	常設重大事故緩和設備	-
	原子炉建屋原子炉棟 [流路]			その他の設備に記載			
原子炉建物燃料取扱廊下ローアウットパネル 閉止装置		常設	常設重大事故緩和設備	-			

※1：常設耐震重要重大事故防止設備・常設重大事故緩和設備等を操作する人が健全であることを担保する常設設備であるため、本分類とする。

- ・記載内容の相違
- 【東海第二】
- 島根2号炉は重大事故対処設備の概要を記載
- ・設備の相違
- 【柏崎6/7】
- ③の相違

柏崎刈羽原子力発電所 6/7号炉 (2017.12.20)	東海第二発電所 (2018.9.18版)	島根原子力発電所 2号炉	備考
<p>1.2 設計における想定シナリオ</p> <p>原子炉制御室の設計において想定するシナリオについて、以下に記す。</p> <p>(1) <u>単独プラント設計基準事故時の想定シナリオ</u></p> <p>「実用発電用原子炉及びその附属施設の技術基準に関する規則」(以下、「技術基準」)の解釈第38条12に記載の通り、「原子力発電所中央制御室の居住性に係る被ばく評価手法について(内規)」(平成21・07・27原院第1号(平成21年8月12日原子力安全・保安院制定))に基づき、仮想事故相当の原子炉冷却材喪失及び主蒸気管破断を想定する。</p> <p>(2) <u>重大事故時の想定シナリオ</u></p> <p><u>柏崎刈羽原子力発電所6号及び7号炉</u>においては、「実用発電用原子炉及びその附属施設の位置、構造及び設備の基準に関する規則」(以下、「設置許可基準規則」)の解釈第59条1b)及び技術基準の解釈第74条1b)、並びに「実用発電用原子炉に係る重大事故時の制御室及び緊急時対策所の居住性に係る被ばく評価に関する審査ガイド」(以下、「審査ガイド」)に基づき想定する「設置許可基準規則解釈第37条の想定する格納容器破損モードのうち、原子炉制御室の運転員の被ばくの観点から結果が最も厳しくなる事故収束に成功した事故シーケンス(例えば、炉心の著しい損傷の後、格納容器圧力逃がし装置等の格納容器破損防止対策が有効に機能した場合)」である「大破断LOCA時に非常用炉心冷却系の機能及び全交流動力電源が喪失するシーケンス」(以下、「大LOCA+ECCS 全喪失+SBOシナリオ」)においても、格納容器ベントを実施することなく事象を収束することのできる代替循環冷却系を整備している。従って、<u>審査ガイド4.2(3)h.被ばく線量の重ね合わせ</u>に基づき、6号及び7号炉において同時に炉心の著しい損傷が発生したと想定する場合、<u>第一に両号炉において代替循環冷却系を用いて事象を収束することとなる。</u></p> <div data-bbox="178 1696 845 1837" data-label="Diagram"> </div> <p>図 1.1-1 基本シナリオ</p>	<p>1.2 設計における想定シナリオ</p> <p>原子炉制御室の設計において想定するシナリオについて、以下に示す。</p> <p>(1) <u>設計基準事故時の想定シナリオ</u></p> <p>「実用発電用原子炉及びその附属施設の技術基準に関する規則」第38条12に記載のとおり、「原子力発電所中央制御室の居住性に係る被ばく評価手法について(内規)」(平成21・07・27原院第1号(平成21年8月12日原子力安全・保安院制定))に基づき、仮想事故相当の原子炉冷却材喪失及び主蒸気管破断を想定する。</p> <p>(2) <u>重大事故時の想定シナリオ</u></p> <p><u>重大事故等時の中央制御室の居住性に係る被ばく線量は、中央制御室内に取り込まれた放射性物質による被ばく及び地表面に沈着した放射性物質による被ばくが支配的であることから、放射性物質の放出量が多くなる事象が被ばく評価の観点から厳しくなる。</u></p> <p><u>炉心損傷を前提とした重大事故では、大規模な放射性物質の放出が想定されるため、中央制御室の被ばく評価は厳しくなる。さらに、格納容器圧力が高く維持される事象や炉心損傷時間が早い事象は、中央制御室の被ばく評価の観点から厳しくなる。</u></p> <p><u>重大事故時における対応として、代替循環冷却系を使用できず、格納容器ベントを実施する場合は、格納容器圧力の抑制のため格納容器ベント実施までは代替格納容器スプレイ冷却系(常設)による格納容器スプレイを実施する。格納容器スプレイによる圧力抑制効果を高くする観点で、格納容器圧力を比較的高い領域で維持するため、代替循環冷却系を使用する場合と比較して格納容器貫通部等からの漏えい率が大きくなり、大気への放射性物質の放出量が多くなる。さらに、サプレッション・プール水位が通常水位+6.5mに到達した時点で、格納容器ベントを実施するため、放射性物質の放出量が多くなる。</u></p> <p><u>また、原子炉建屋ガス処理系の起動により、原子炉建屋から大気への放射性物質の放出率低減効果に期待できることから、事象進展が早く原子炉建屋ガス処理系の起動前の格納容器貫通部等からの漏えい量が多いほど、大気への放出量が多くなる。さらに、炉心損傷時間が早いほど、早期に格納容器内に放出される放射性物質は多くなるため、格納容器貫通部からの漏えい量も多くなる。</u></p>	<p>1.2 設計における想定シナリオ</p> <p>原子炉制御室の設計において想定するシナリオについて、以下に記す。</p> <p>(1) <u>設計基準事故時の想定シナリオ</u></p> <p>「実用発電用原子炉及びその附属施設の技術基準に関する規則」(以下、「技術基準規則」)の解釈第38条12に記載のとおり、「原子力発電所中央制御室の居住性に係る被ばく手法について(内規)」(平成21・07・27原院第1号(平成21年8月12日原子力安全・保安院制定))に基づき、仮想事故相当の原子炉冷却材喪失及び主蒸気管破断を想定する。</p> <p>(2) <u>重大事故時の想定シナリオ</u></p> <p><u>島根原子力発電所2号炉</u>においては、「実用発電用原子炉及びその附属施設の位置、構造及び設備の基準に関する規則」(以下、「設置許可基準規則」)の解釈第59条1b)及び技術基準規則の解釈第74条1b)、並びに「実用発電用原子炉に係る重大事故時の制御室及び緊急時対策所の居住性に係る被ばく評価に関する審査ガイド」(以下、「審査ガイド」)に基づき想定する「設置許可基準規則の解釈第37条の想定する格納容器破損モードのうち、原子炉制御室の運転員の被ばくの観点から結果が最も厳しくなる事故収束に成功した事故シーケンス(例えば、炉心の著しい損傷の後、格納容器圧力逃がし装置等の格納容器破損防止対策が有効に機能した場合)」である『<u>冷却材喪失(大破断LOCA)+ECCS注水機能喪失+全交流動力電源喪失</u>』シーケンスにおいても、<u>格納容器ベントを実施することなく事象を収束することのできる残留熱代替除去系を整備している。従って、重大事故等が発生した場合、第一に残留熱代替除去系を用いて事象を収束することとなる。</u></p>	<p>備考</p> <p>・申請号炉数の相違【柏崎6/7】</p> <p>・申請号炉数の相違【柏崎6/7】</p> <p>・申請号炉数の相違【柏崎6/7】</p>

柏崎刈羽原子力発電所 6/7号炉 (2017.12.20)	東海第二発電所 (2018.9.18版)	島根原子力発電所 2号炉	備考
<p>2. 設計方針</p> <p>2.1 中央制御室から外の状況を把握する設備について</p> <p>2.1.1 中央制御室から外の状況を把握する設備の概要</p> <p>以下の設備等を用いることで、中央制御室内にて発電用原子炉施設の外の状況の把握が可能な設計としている。概略を図2.1-1に、配置を図2.1-2に示す。</p> <p>(1) 監視カメラ</p> <p>発電用原子炉施設に影響を及ぼす可能性のある自然現象等(洪水, 風(台風), 竜巻, 低温(凍結), 降水, 積雪, 落雷, 地滑り, 火山の影響, 生物学的事象, 森林・近隣工場等の火災, 飛来物(航空機落下等), 船舶の衝突, 及び地震, 津波)及び発電所構内の状況を, 7号炉原子炉建屋屋上主排気筒に設置する津波監視カメラ, 6号炉, 7号炉スクリーン海側等に設置する構内監視カメラの映像により, 昼夜にわたり監視できる設計とする。</p> <p>(2) 取水槽水位計</p> <p>津波の襲来及び津波挙動の把握が可能な設計とする。</p> <p>(3) 気象観測設備</p> <p>発電所構内に設置している気象観測設備により, 風向・風速等の気象状況を常時監視できる設計とする。</p> <p>また周辺モニタリング設備により, 発電所周辺監視区域境界付近の外部放射線量率を把握できる設計とする。</p> <p>(4) 公的機関等の情報を入手するための設備</p> <p>公的機関からの地震, 津波, 竜巻, 雷, 降雨予報, 天気図, 台風情報等を入手するために, 中央制御室にテレビ, 電話, FAX等を設置している。また, 社内ネットワークに接続されたパソコンを使用することで, 台風情報, 竜巻注意情報のほか雷・降雨予報, 天気図等の公的機関からの情報(うち雷については社内システムによる落雷位置情報を含む)を入手することが可能な設計とする。</p>	<p>2. 設計方針</p> <p>2.1 中央制御室から外の状況を把握する設備について</p> <p>2.1.1 中央制御室から外の状況を把握する設備の概要</p> <p>以下の設備等を用いることで、中央制御室内にて発電用原子炉施設(以下「原子炉施設」という。)の外の状況の把握が可能な設計とする。概略を第2.1-1図に、配置を第2.1-2図に示す。</p> <p>(1) 津波・構内監視カメラ</p> <p>原子炉施設に影響を及ぼす可能性のある自然現象等(風(台風), 竜巻, 降水, 積雪, 落雷, 火山の影響, 森林火災, 近隣工場等の火災, 船舶の衝突, 高潮, 地震及び津波)並びに自然現象等による発電所構内及び原子炉施設への影響の概況を原子炉建屋屋上及び防潮堤上部に設置する津波・構内監視カメラの映像により, 昼夜にわたり監視できる設計とする。</p> <p>(2) 取水ピット水位計/潮位計</p> <p>津波来襲時の海水面水位変動を監視できる設計とする。</p> <p>(3) 気象観測設備</p> <p>発電所構内に設置している気象観測設備により, 風向・風速等の気象状況を常時監視できる設計とする。</p> <p>また, 周辺モニタリング設備により, 発電所周辺監視区域境界付近の外部放射線量率を把握できる設計とする。</p> <p>(4) 公的機関等の情報を入手するための設備</p> <p>公的機関等からの地震, 津波, 竜巻情報等を入手するために, 中央制御室に電話, FAX等を設置する。また, 社内ネットワークに接続されたパソコンを使用することで, 雷・降雨予報, 天気図等の公的機関からの情報を入手することが可能な設計とする。</p>	<p>2. 設計方針</p> <p>2.1 中央制御室から外の状況を把握する設備について</p> <p>2.1.1 中央制御室から外の状況を把握する設備の概要</p> <p>以下の設備等を用いることで、中央制御室内にて発電用原子炉施設の外の状況の把握が可能な設計としている。概略を図2.1-1に、配置を図2.1-2に示す。</p> <p>(1) 監視カメラ</p> <p>発電用原子炉施設に影響を及ぼす可能性のある自然現象等(風(台風), 竜巻, 降水, 積雪, 落雷, 地滑り, 火山の影響, 生物学的事象, 森林・近隣工場等の火災, 飛来物(航空機落下等), 船舶の衝突, 地震及び津波)及び発電所構内の状況を, 2号炉排気筒に設置する津波監視カメラ並びに2号炉原子炉建物屋上, 3号炉原子炉建物屋上, 通信用無線鉄塔, 固体廃棄物貯蔵所C棟屋上及び一矢谷に設置する構内監視カメラの映像により, 昼夜にわたり監視できる設計とする。</p> <p>(2) 取水槽水位計</p> <p>津波の襲来及び津波挙動の把握が可能な設計とする。</p> <p>(3) 気象観測設備</p> <p>発電所構内に設置している気象観測設備により, 風向・風速等の気象状況を常時監視できる設計としている。</p> <p>(4) 周辺モニタリング設備</p> <p>周辺モニタリング設備により, 発電所周辺監視区域境界付近の外部放射線量率を把握できる設計としている。</p> <p>(5) 公的機関等の情報を入手するための設備</p> <p>公的機関からの地震, 津波, 竜巻, 雷, 降雨予報, 天気図, 台風情報等を入手するために, 中央制御室にテレビ, 電話, FAX等を設置している。また, 社内ネットワークに接続されたパソコンを使用することで, 気象庁発信電文と連携したメールシステムにより, 地震, 津波, 竜巻, 大雨, 大雪, 噴火情報等の公的機関からの情報を入手することが可能な設計としている。</p>	<p>備考</p> <ul style="list-style-type: none"> ・想定する外部事象の相違【柏崎6/7】 ・島根2号炉は個別評価により洪水影響がないことを確認している ・申請号炉数の相違【柏崎6/7】
<p style="text-align: right;">□ : DB範囲</p>	<p style="text-align: right;">□ : DB範囲</p>	<p style="text-align: right;">□ : DB範囲</p>	



図 2.1-1 中央制御室における外部状況把握のイメージ

□ : DB 範囲

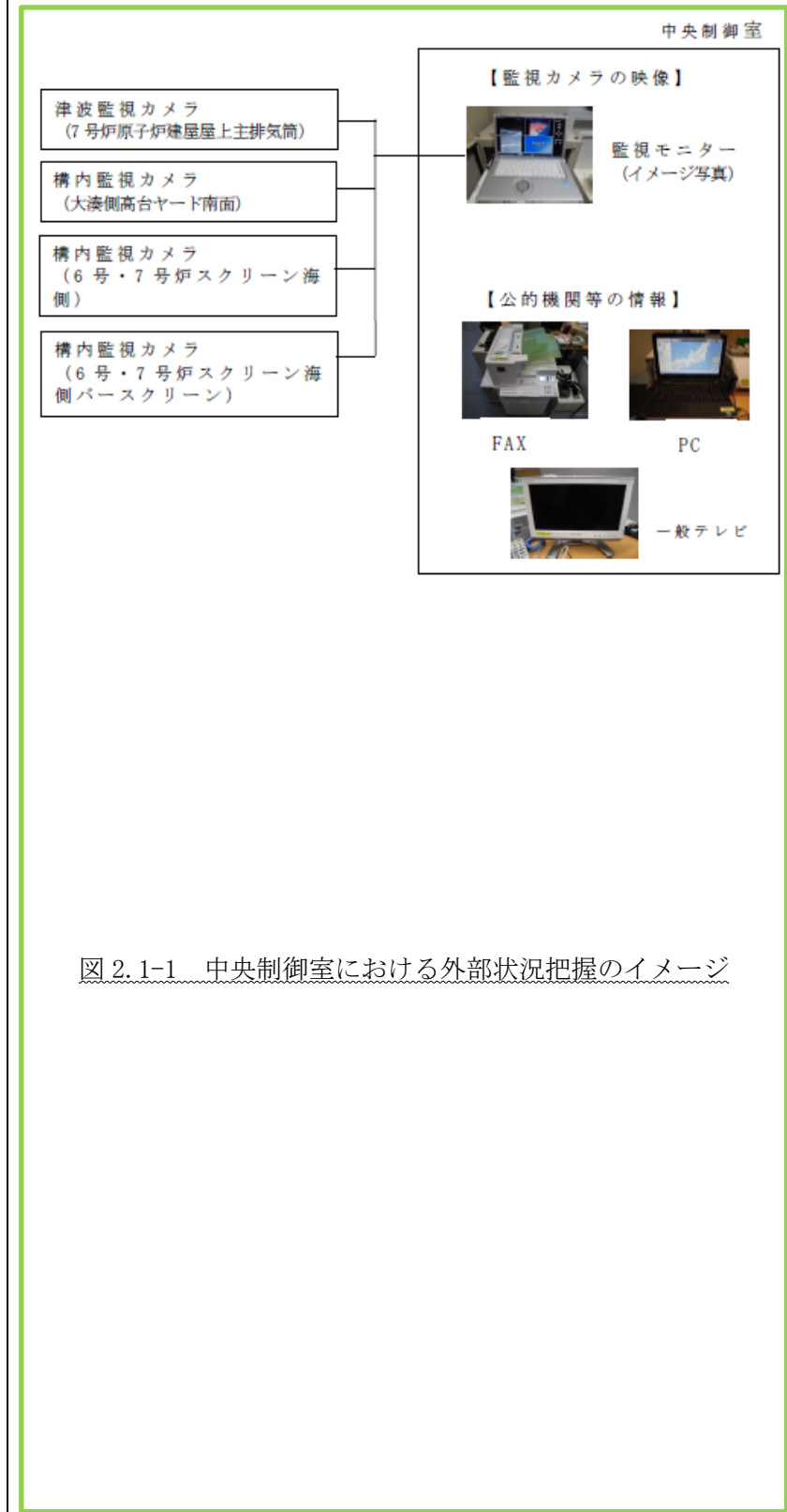
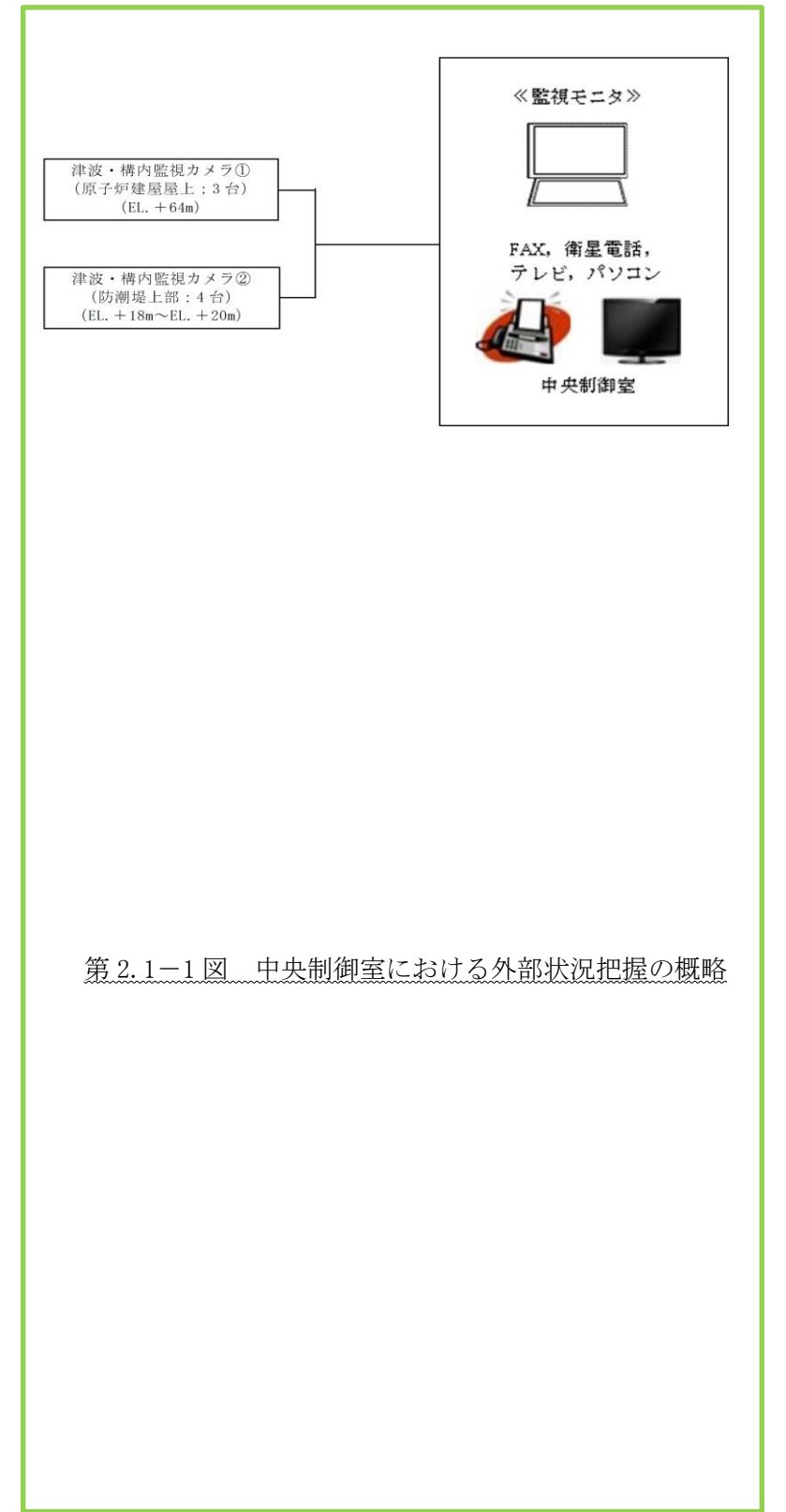

第 2.1-1 図 中央制御室における外部状況把握の概略

□ : DB 範囲









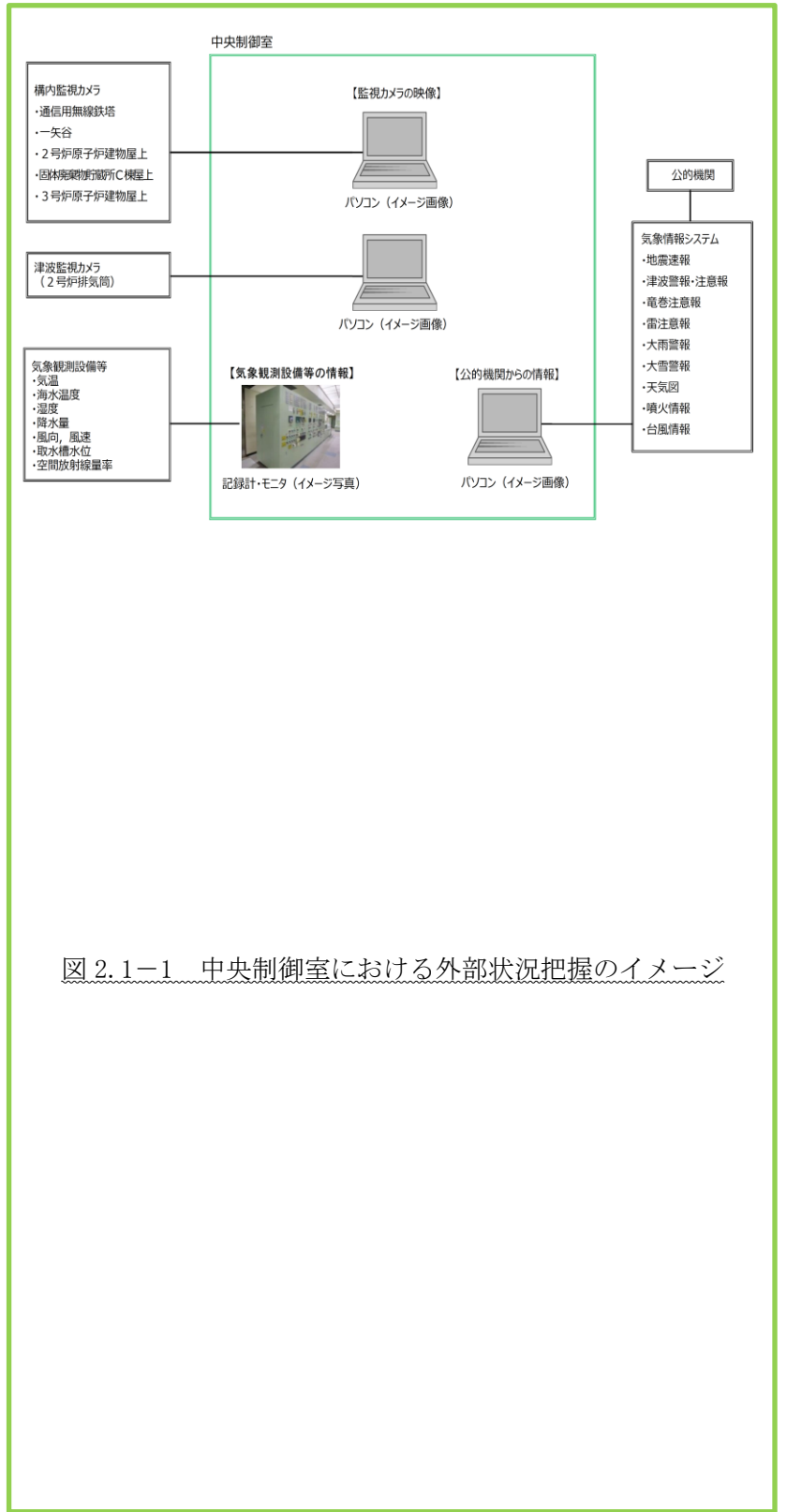

図 2.1-1 中央制御室における外部状況把握のイメージ

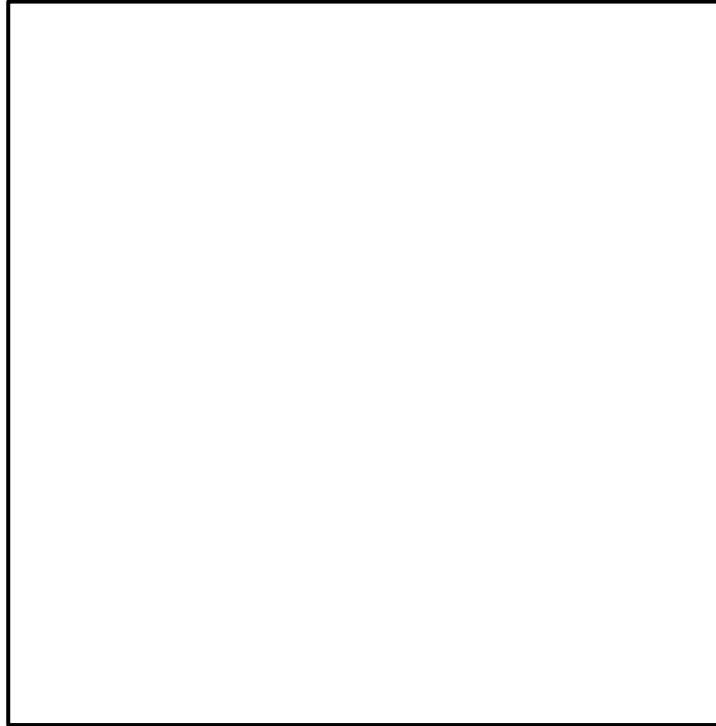
□ : DB 範囲

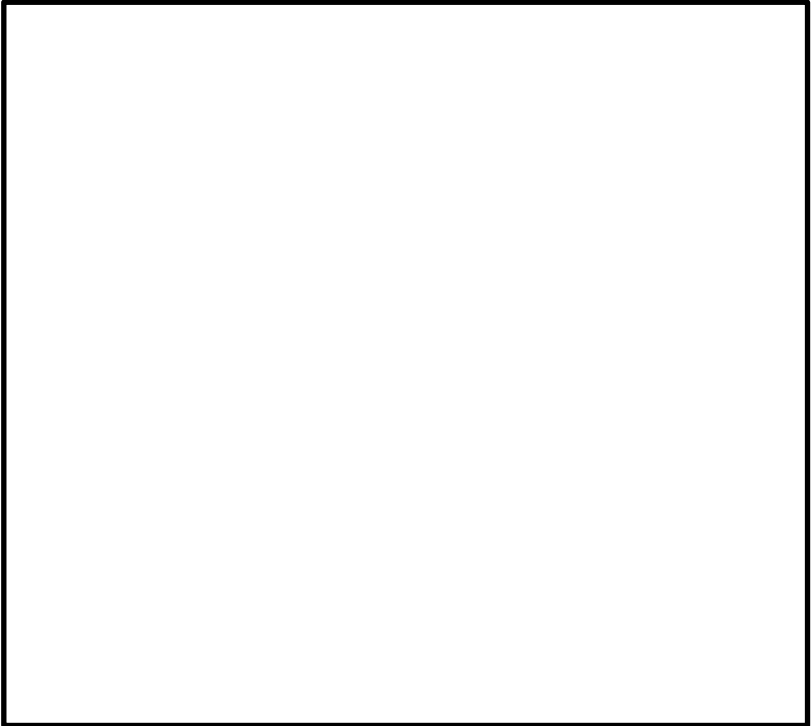
柏崎刈羽原子力発電所 6 / 7号炉 (2017.12.20)	東海第二発電所 (2018.9.18版)	島根原子力発電所 2号炉	備考
 <p data-bbox="163 1138 875 1171">図 2.1-2 中央制御室から外の状況を把握する設備の配置図</p> <p data-bbox="682 1801 905 1852"> : DB 範囲</p>	 <p data-bbox="934 1138 1676 1171">第 2.1-2 図 中央制御室から外の状況を把握する設備の配置図</p> <p data-bbox="1469 1801 1691 1852"> : DB 範囲</p>	 <p data-bbox="1736 1138 2463 1171">図 2.1-2 中央制御室から外の状況を把握する設備の配置図</p> <p data-bbox="2255 1801 2478 1852"> : DB 範囲</p>	

柏崎刈羽原子力発電所 6 / 7号炉 (2017.12.20)	東海第二発電所 (2018.9.18版)	島根原子力発電所 2号炉	備考
<div data-bbox="172 331 863 1323" data-label="Image"> </div> <p data-bbox="151 1360 664 1398">(* T.M.S.L. : 東京湾平均海面)</p> <p data-bbox="136 1453 842 1530">図 2.1-3 中央制御室から外の状況を把握する設備の配置図 (6号炉, 7号炉周辺拡大図)</p> <div data-bbox="685 1801 908 1852" data-label="Text">  : DB 範囲 </div>			

柏崎刈羽原子力発電所 6/7号炉 (2017.12.20)	東海第二発電所 (2018.9.18版)	島根原子力発電所 2号炉	備考
<p>2.1.2 監視カメラについて</p> <p>監視カメラは、津波監視カメラ及び構内監視カメラにて構成する。</p> <p>津波監視カメラは、7号炉原子炉建屋屋上に設置された排気筒 T.M.S.L. +76mの位置に2台設置し、水平360°、垂直90°の旋回が可能な設備とすることで、津波の襲来及び津波挙動の察知と、その影響の俯瞰的な把握が可能な設計とする。また、赤外線撮像機能を有したカメラを用い、かつ中央制御室から監視可能な設備とすることで、昼夜を問わない継続した監視を可能とする。</p> <p>監視に必要な要件を満足する仕様としており、隣接する6号及び7号炉発電用原子炉施設に迫る自然現象を共通要因として把握するものであるため、6号及び7号炉で共用とすることによって安全性を損なうことはないことから、6号及び7号炉共用としている。表2.1-1に津波監視カメラの概要を示す。</p> <p>また構内監視カメラは、自然現象等の監視強化のため原子炉施設周辺高台、及び海側に設置し、津波監視カメラの監視可能範囲を補足する。構内監視カメラの配置を図2.1-3に、表2.1-2に構内監視カメラの概要を示す。</p> <p>津波監視カメラ及び構内監視カメラは、取付け部材、周辺の建物、設備等で死角となるエリアをカバーすることが出来るよう配慮し配置している。各々のカメラにて監視可能な6号炉、7号炉原子炉施設及び周辺の構内範囲について、図2.1-4～6に示す。また、構内監視カメラは底を有した積雪等影響を受けにくい構造を有したものを設置するとともに、また津波監視カメラ取付けは7号炉主排気筒の支持鋼材への懸垂構造とすることで積雪の影響を受けにくい設計とする。取付け詳細を図2.1-7,8に示す。</p>	<p>2.1.2 津波・構内監視カメラについて</p> <p>津波・構内監視カメラは、原子炉施設に影響を及ぼす可能性のある自然現象等(風(台風)、竜巻、降水、積雪、落雷、火山の影響、森林火災、近隣工場等の火災、船舶の衝突、高潮、地震及び津波)並びに自然現象等による発電所構内及び原子炉施設への影響の概況を適切に監視できる位置・方向で基準津波(T.P. +17.1m)の影響を受けることがない高所に設置する。</p> <p>第2.1-1表に津波・構内監視カメラの概要を示す。</p> <p>津波・構内監視カメラは、取付け部材、周辺の建物、設備等で死角となるエリアをカバーすることが出来るように配慮して配置する。ただし、一部死角となるエリアがあるが、発電所構内のタービン建屋付近等のごく限られた場所であり、その他の監視可能な領域の監視により、原子炉施設に影響を及ぼす可能性のある自然現象等を十分把握可能である。また、一部死角となるタービン建屋付近に設置する主変圧器及び起動変圧器については、津波・構内監視カメラにて全体像のうち上半分程度が監視可能であるため、自然現象等による影響を十分把握可能である。なお、中央制御室にて警報による監視も可能である。</p> <p>同エリアにあるアクセスルートについては、目視監視を行う時間が確保できることから、問題はない。津波・構内監視カメラが監視可能な原子炉施設及び周辺の発電所構内範囲を第2.1-3図に示す。</p>	<p>2.1.2 監視カメラについて</p> <p>監視カメラは、津波監視カメラ及び構内監視カメラにて構成する。</p> <p>津波監視カメラは、遠方からの津波の接近を適切に監視できる位置・方向に設置するとともに、取水口を設置する輪谷湾における津波の襲来状況を適切に監視できる位置・方向に設置している。また、津波監視カメラは基準津波の影響を受けない高所(2号炉排気筒)に1台設置しており、監視に必要な要件を満足する仕様としている。表2.1-1に津波監視カメラの概要を示す。</p> <p>また、構内監視カメラは、自然現象等の監視強化のため2号炉原子炉建物屋上、3号炉原子炉建物屋上、通信用無線鉄塔、固体廃棄物貯蔵所C棟屋上及び一矢谷に設置し、津波監視カメラの監視可能範囲を補足する。構内監視カメラの配置を図2.1-3に、表2.1-2に構内監視カメラの概要を示す。</p> <p>津波監視カメラ及び構内監視カメラは、取付け部材、周辺の建物、設備等で死角となるエリアをカバーすることが出来るよう配慮し、配置する。ただし、一部死角となるエリアがあるが、監視可能な領域の監視により、発電用原子炉施設に影響を及ぼす可能性のある自然現象等を十分把握可能である。各々のカメラにて監視可能な発電用原子炉施設及び周辺の構内範囲について、図2.1-4に示す。</p>	<p>備考</p> <p>・申請号炉数の相違 【柏崎 6/7】</p>
<p style="text-align: center;"> : DB範囲</p>	<p style="text-align: center;"> : DB範囲</p>	<p style="text-align: center;"> : DB範囲</p>	

柏崎刈羽原子力発電所 6/7号炉 (2017.12.20)	東海第二発電所 (2018.9.18版)	島根原子力発電所 2号炉	備考
<p>なお、可視光カメラによる監視が期待できない夜間の濃霧発生時や強雨時においては、赤外線カメラによる監視機能についても期待できない状況となることが考えられる。その場合は監視カメラ以外で中央制御室にて監視可能なパラメータを監視することで外部状況の把握に努めつつ、気象等に関する公的機関からの情報も参考とし、原子炉施設に影響を及ぼす可能性がある自然現象等を把握することとする。</p> <p><u>なお、監視カメラのうち、海側に設置された構内監視カメラにおいてはカメラに照明設備が付属装備されており、環境によっては外部状況把握が可能な設計とする。</u></p>	<p>なお、可視光カメラによる監視が期待できない夜間の濃霧発生時や強雨時においては、赤外線カメラによる監視機能についても期待できない状況となることが考えられる。その場合は、津波・構内監視カメラ以外で中央制御室にて監視可能なパラメータを監視することで、外部状況の把握に努めつつ、気象等に関する公的機関からの情報も参考とし、原子炉施設に影響を及ぼす可能性がある自然現象等を把握する。</p>	<p>なお、可視光カメラによる監視が期待できない夜間の濃霧発生時や強雨時においては、赤外線カメラによる監視機能についても期待できない状況となることが考えられる。その場合は、監視カメラ以外で中央制御室にて監視可能なパラメータを監視することで外部状況の把握に努めつつ、気象等に関する公的機関からの情報も参考とし、原子炉施設に影響を及ぼす可能性がある自然現象等を把握することとする。</p>	<p>備考</p> <p>・設備の相違</p> <p>【柏崎6/7】</p> <p>島根2号炉の構内監視カメラは可視光と赤外線のデュアルカメラであり夜間の監視が可能な設計とする</p>
<p style="text-align: center;">□ : DB範囲 :</p>	<p style="text-align: center;">□ : DB範囲 :</p>	<p style="text-align: center;">□ : DB範囲 :</p>	

表2.1-1 津波監視カメラの概要



津波監視カメラ	
外観	
カメラ構成	可視光と赤外線デュアルカメラ
ズーム	デジタルズーム4倍
遠隔可動	上下左右可能 (垂直±90° / 水平360°)
暗視機能	あり(赤外線カメラ)
耐震性	基準地震動に対し機能維持
電源供給	代替交流電源設備から給電可能
風荷重	風速40.1m/secによる荷重を考慮
積雪荷重	積雪167cmによる荷重を考慮
台数	7号炉原子炉建屋屋上主排気筒(6号炉7号炉共用) 2台

表2.1-2 構内監視カメラの概要

構内監視カメラ	
	大湊側高台ヤード南面 6号炉スクリーン海側 及び7号炉スクリーン海側
外観	
カメラ構成	可視光カメラ
ズーム	光学ズーム18倍 光学ズーム12倍
遠隔可動	上下左右可能 (垂直±約90° / 水平360°) 上下左右可能 (上方約15° 下方約60° / 左右約170°)
暗視機能	なし
耐震性	Cクラス
電源供給	常・非常用電源から給電可能
台数	(6号炉7号炉共用) 1台 6号炉スクリーン海側: (6号炉設備) 3台 7号炉スクリーン海側: (7号炉設備) 3台

 : DB範囲

第2.1-1表 津波・構内監視カメラの概要

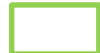
津波・構内監視カメラ	
外観	
カメラ構成	可視光及び赤外線
ズーム	デジタルズーム4倍
遠隔可動	水平可動: 360° (連続), 垂直可動: ±90°
夜間監視	可能(赤外線カメラ)
耐震設計	Sクラス
供給電源	所内常設直流電源設備
風荷重	設計竜巻を考慮した荷重にて設計
積雪荷重, 堆積量	積雪を考慮した荷重及び設置高さにて設計
降下火砕物荷重, 堆積量	降下火砕物を考慮した荷重及び設置高さにて設計
台数	原子炉建屋屋上3台, 防潮堤上部4台



 : DB範囲



表2.1-1 津波監視カメラの概要

津波監視カメラ	
外観	
カメラ構成	可視光と赤外線デュアルカメラ
ズーム	赤外線カメラ: デジタルズーム2, 4倍
遠隔可動	水平可動: 360° 上下可動: ±90°
暗視機能	可能(赤外線カメラ)
耐震設計	Sクラス
供給電源	代替交流電源設備から給電可能
風荷重	風速(30m/s)による荷重を考慮
積雪荷重	積雪(100cm)による荷重を考慮
台数	2号炉排気筒 1台

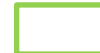

表2.1-2 構内監視カメラの概要

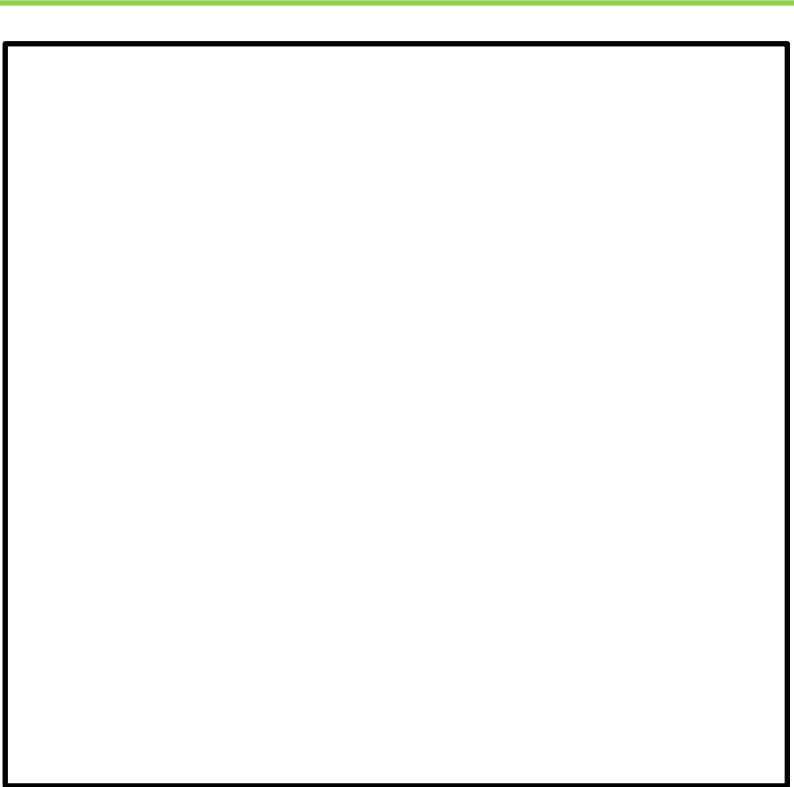
構内監視カメラ	
外観	
カメラ構成	可視光と赤外線デュアルカメラ
ズーム	可視光カメラ: 光学36倍ズーム 電子ズーム12倍ズーム 赤外線カメラ: デジタルズーム2, 4倍
遠隔可動	水平可動: 360° 上下可動: ±90°
暗視機能	可能(赤外線カメラ)
耐震設計	Cクラス
供給電源	常用電源及び非常用電源
台数	通信用無線鉄塔 1台 2号炉原子炉建物屋上 1台 3号炉原子炉建物屋上 1台 固体廃棄物貯蔵所C棟屋上 1台 一矢谷 1台

 : DB範囲

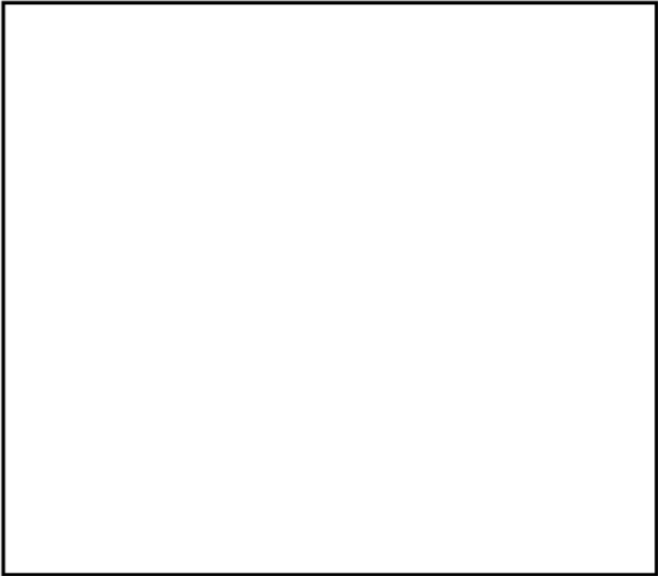
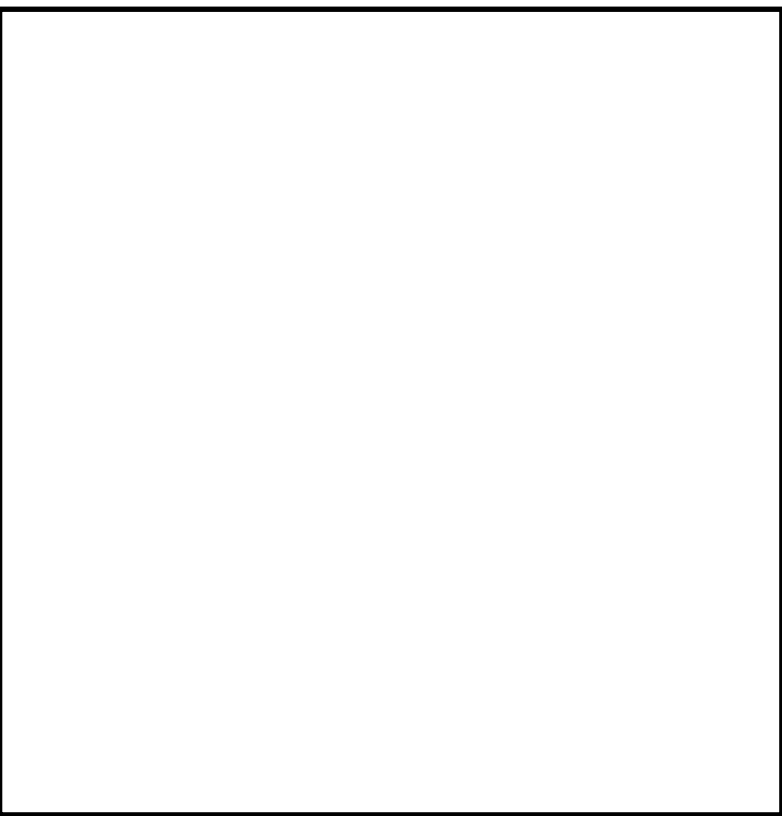
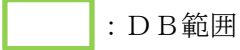
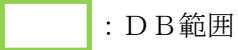
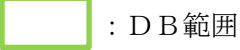
柏崎刈羽原子力発電所 6 / 7号炉 (2017.12.20)	東海第二発電所 (2018.9.18版)	島根原子力発電所 2号炉	備考
		 <p data-bbox="1926 1094 2279 1125" style="text-align: center;">図 2.1-3 監視カメラ配置図</p>	<p data-bbox="2516 1094 2792 1262"> ・設備の相違 【柏崎 6, 7】 島根 2号炉の監視カメラ配置を記載 </p> <p data-bbox="2258 1801 2487 1850" style="text-align: right;">  : DB範囲 </p>

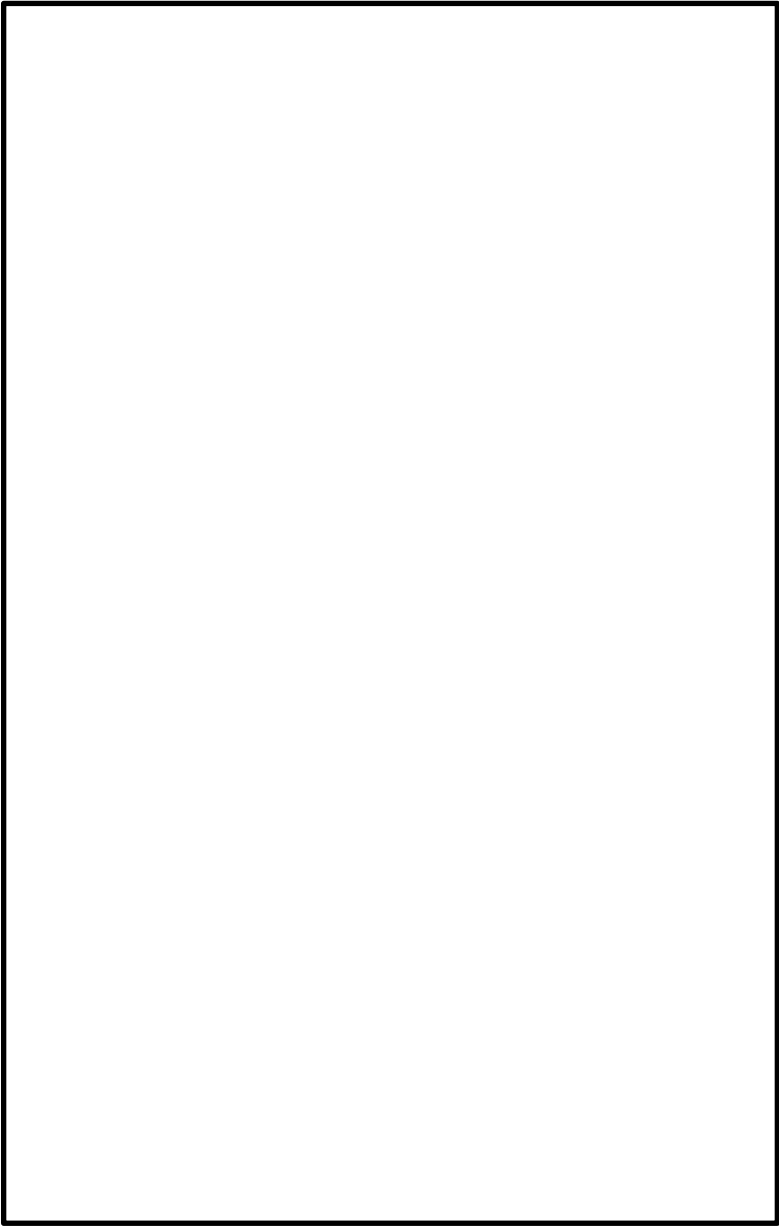
柏崎刈羽原子力発電所 6 / 7号炉 (2017.12.20)	東海第二発電所 (2018.9.18版)	島根原子力発電所 2号炉	備考
 <p data-bbox="142 1545 896 1623">図 2.1-4 6号炉、7号炉原子炉施設と津波監視カメラ（7号炉原子炉建屋屋上主排気筒）の監視可能な画角範囲</p>	 <p data-bbox="1032 869 1564 894">第 2.1-3 図 津波・構内監視カメラの監視可能な範囲</p>	 <p data-bbox="1804 1545 2415 1577">図 2.1-4 津波・構内監視カメラの監視可能な範囲</p>	
			

柏崎刈羽原子力発電所 6 / 7号炉 (2017. 12. 20)	東海第二発電所 (2018. 9. 18 版)	島根原子力発電所 2号炉	備考
 <p data-bbox="142 1543 905 1627">図 2.1-5 6号炉, 7号炉原子炉施設と構内監視カメラ (大湊側高台ヤード南面) の監視可能な画角範囲</p> <p data-bbox="682 1711 905 1764">  : DB 範囲 </p>			

柏崎刈羽原子力発電所 6 / 7号炉 (2017.12.20)	東海第二発電所 (2018.9.18版)	島根原子力発電所 2号炉	備考
<div data-bbox="178 304 890 1417" data-label="Image"> </div> <div data-bbox="133 1585 905 1669" data-label="Caption"> <p>図2.1-6 6号炉, 7号炉原子炉施設と構内監視カメラ (6号炉, 7号炉スクリーン海側) の監視可能な画角範囲</p> </div> <div data-bbox="682 1753 905 1816" data-label="Text"> <p> : DB範囲</p> </div>			



図 2.1-7 津波監視カメラ取り付け概要図



図 2.1-8 構内監視カメラ取り付け概要図

: DB 範囲

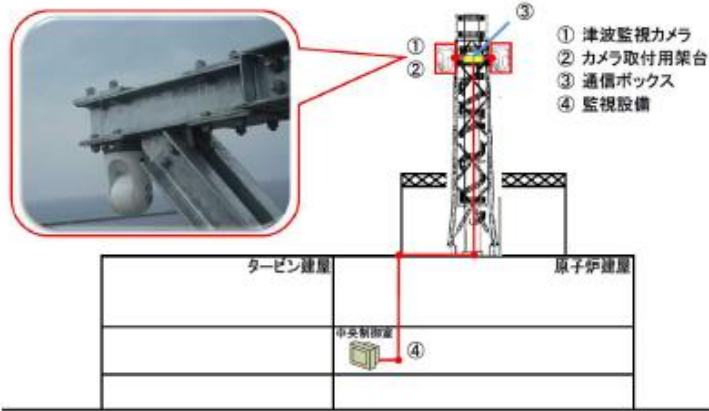

図 2.1-5 津波監視カメラ取付け概略図



図 2.1-6 構内監視カメラ取付け概要図

: DB 範囲

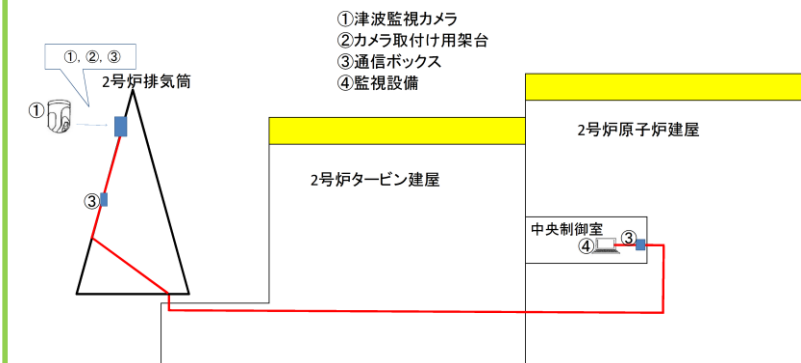
柏崎刈羽原子力発電所 6/7号炉 (2017.12.20)	東海第二発電所 (2018.9.18版)	島根原子力発電所 2号炉	備考
<p>2.1.3 監視カメラ映像サンプル</p> <p>中央制御室において、監視カメラにより監視できる映像のサンプルを図2.1-9及び図2.1-11に示す。</p> <div data-bbox="166 415 890 1457" style="border: 1px solid black; height: 496px; margin: 10px 0;"></div> <p>図 2.1-9 (1/2) 中央制御室からの外部の状況把握イメージ (例) 津波監視カメラ (7号炉原子炉建屋屋上主排気筒) にて新潟市方向海沿い</p> <div data-bbox="682 1751 908 1801" style="border: 1px solid green; width: 30px; height: 20px; display: inline-block; margin-right: 5px;"></div> : DB範囲	<p>2.1.3 津波・構内監視カメラ映像サンプル</p> <p>中央制御室において、津波・構内監視カメラにより監視できる映像のサンプルを第2.1-4図に示す。</p> <p>また、津波・構内監視カメラの撮影方向を第2.1-5図に示す。</p> <div data-bbox="949 415 1673 1545" style="border: 1px solid black; height: 538px; margin: 10px 0;"></div> <div data-bbox="1472 1751 1697 1801" style="border: 1px solid green; width: 30px; height: 20px; display: inline-block; margin-right: 5px;"></div> : DB範囲	<p>2.1.3 監視カメラ映像サンプル</p> <p>中央制御室において、監視カメラにより監視できる映像のサンプルを図2.1-7及び図2.1-8に示す。</p> <div data-bbox="1745 415 2469 1545" style="border: 1px solid black; height: 538px; margin: 10px 0;"></div> <p>図 2.1-7 中央制御室からの外部の状況把握イメージ (例) 津波監視カメラ (2号炉排気筒) にて2号炉取水口方向</p> <div data-bbox="2249 1751 2475 1801" style="border: 1px solid green; width: 30px; height: 20px; display: inline-block; margin-right: 5px;"></div> : DB範囲	

柏崎刈羽原子力発電所 6 / 7号炉 (2017.12.20)	東海第二発電所 (2018.9.18版)	島根原子力発電所 2号炉	備考
 <p data-bbox="133 1585 905 1711">図 2.1-9 (2/2) 中央制御室からの外部の状況把握イメージ (例) 津波監視カメラ (7号炉原子炉建屋屋上主排気筒) にて新潟市方向海沿い</p>		 <p data-bbox="1721 1585 2493 1669">図 2.1-8 中央制御室からの外部の状況把握イメージ (構内監視カメラの映像サンプル) (1 / 2)</p>	
 : DB 範囲		 : DB 範囲	

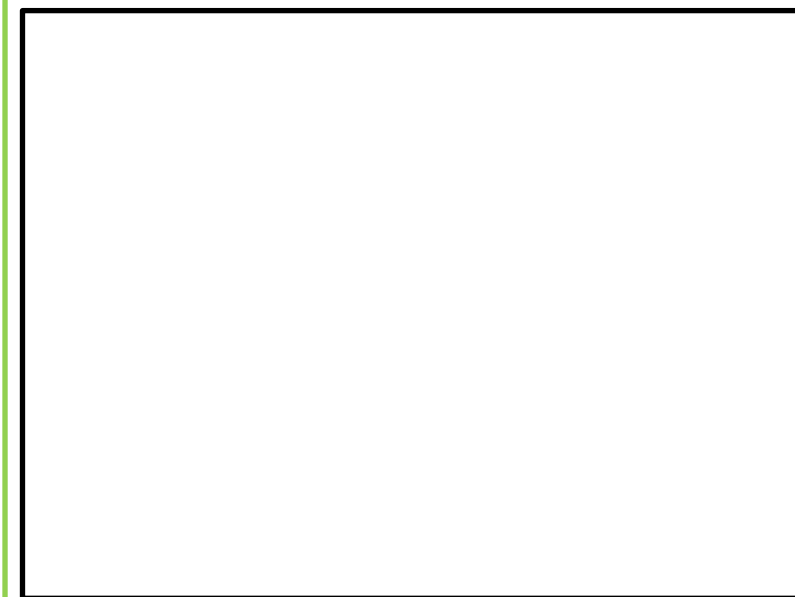
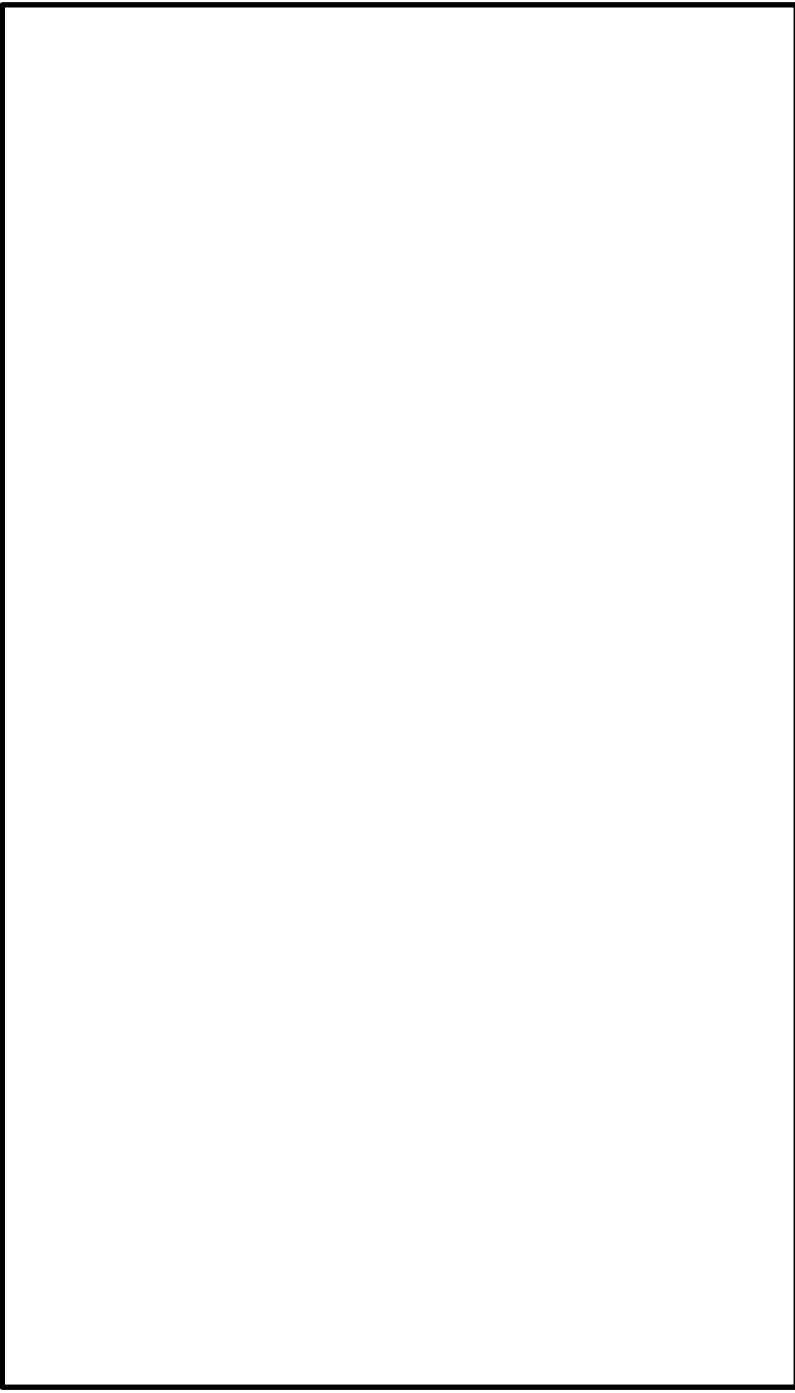
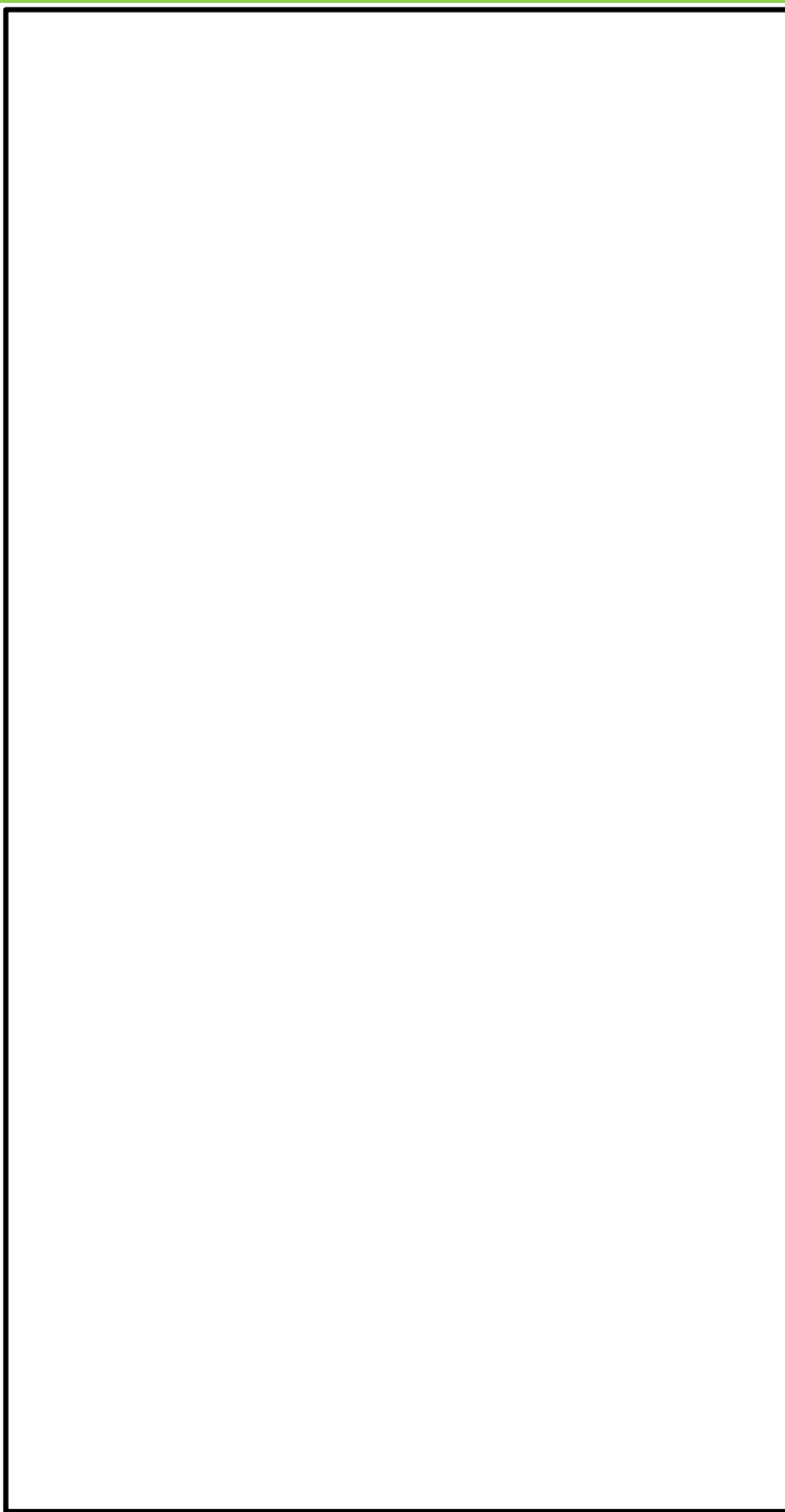
柏崎刈羽原子力発電所 6 / 7号炉 (2017.12.20)	東海第二発電所 (2018.9.18版)	島根原子力発電所 2号炉	備考
		 <p data-bbox="1724 1724 2484 1801">図 2.1-8 中央制御室からの外部の状況把握イメージ (構内監視カメラの映像サンプル) (2 / 2)</p> <p data-bbox="2258 1812 2484 1864">  : DB範囲 </p>	

柏崎刈羽原子力発電所 6 / 7号炉 (2017.12.20)	東海第二発電所 (2018.9.18版)	島根原子力発電所 2号炉	備考
<p>(補足) 「図2.1-9 (1/2) 及び (2/2) 中央制御室からの外部の状況把握イメージ (例) 津波監視カメラ (7号炉原子炉建屋屋上主排気筒) にて新潟市方向」の撮影方角は、下記構内配置図 (図2.1-10) のとおり。</p> <div data-bbox="172 464 893 1142" style="border: 1px solid black; height: 300px; width: 240px; margin: 10px auto;"></div> <p style="text-align: center;">図 2.1-10 津波監視カメラの撮影方角</p>			
<div data-bbox="679 1751 765 1801" style="border: 1px solid green; width: 29px; height: 24px; display: inline-block; margin-right: 5px;"></div> : DB範囲			

柏崎刈羽原子力発電所 6 / 7号炉 (2017.12.20)	東海第二発電所 (2018.9.18版)	島根原子力発電所 2号炉	備考
<div data-bbox="163 331 890 1234" data-label="Image"> </div> <div data-bbox="124 1407 917 1533" data-label="Caption"> <p>図 2.1-11 中央制御室からの外部の状況把握イメージ (例) 津波監視カメラ (7号炉原子炉建屋屋上主排気筒) にて開閉所方向</p> </div> <div data-bbox="667 1801 917 1852" data-label="Text"> <p> : DB範囲</p> </div>			<ul style="list-style-type: none"> ・申請号炉数の相違【柏崎 6/7】

柏崎刈羽原子力発電所 6/7号炉 (2017.12.20)	東海第二発電所 (2018.9.18版)	島根原子力発電所 2号炉	備考
<p>(補足) 「図2.1-11 中央制御室からの外部の状況把握イメージ (例) 津波監視カメラ (7号炉原子炉建屋屋上主排気筒) にて開閉所方向」の撮影方角は、下記構内配置図 (図2.1-12) のとおり。</p> <div data-bbox="142 384 890 1031" style="border: 1px solid black; height: 300px; width: 100%;"></div> <p>図 2.1-12 中央制御室から外の状況を把握する設備の配置図</p> <p>2.1.4 監視カメラにより把握可能な自然現象等 地震, 津波, 及び設置許可基準規則の解釈第6条に記載されている「想定される自然現象」, 「発電用原子炉施設の安全性を損なわせる原因となるおそれがある事象であって人為によるもの (故意によるものを除く。)」のうち, 監視カメラにより把握可能な自然現象等を表2.1-3に示す。</p>	<p>2.1.4 津波・構内監視カメラにより把握可能な自然現象等 地震, 津波並びに「<u>実用発電用原子炉及びその附属施設の位置, 構造及び設備の基準に関する規則の解釈</u>」第6条に記載されている「想定される自然現象」及び「原子炉施設の安全性を損なわせる原因となるおそれがある事象であって人為によるもの (故意によるものを除く。)」のうち, <u>津波・構内監視カメラ</u>により把握可能な自然現象等を第2.1-2表に示す。</p>	<p>2.1.4 監視カメラにより把握可能な自然現象等 地震, 津波並びに設置許可基準規則の解釈第6条に記載されている「想定される自然現象」及び「発電用原子炉施設の安全性を損なわせる原因となるおそれがある事象であって人為によるもの (故意によるものを除く。)」のうち, 監視カメラにより把握可能な自然現象等を表2.1-3に示す。</p>	<p>備考</p> <p>・申請号炉数の相違 【柏崎 6/7】</p>
<div data-bbox="682 1711 771 1764" style="border: 1px solid black; width: 30px; height: 25px; display: inline-block;"></div> : DB 範囲	<div data-bbox="1454 1711 1543 1764" style="border: 1px solid black; width: 30px; height: 25px; display: inline-block;"></div> : DB 範囲	<div data-bbox="2255 1711 2344 1764" style="border: 1px solid black; width: 30px; height: 25px; display: inline-block;"></div> : DB 範囲	

表 2.1-3 監視カメラにより中央制御室で把握可能な自然現象等

自然現象等	第6条選定事象*		地震	津波	把握できる発電用原子炉施設への影響の有無
	自然	人為			
地震			○		地震発生後の発電所構内及び原子炉施設への影響の有無
津波				○	津波襲来の状況や発電所構内及び原子炉施設への影響の有無
洪水					発電所構内の排水状況や原子炉施設への影響の有無
風(台風)	○				風(台風)・竜巻(飛来物含む)による発電所及び原子炉施設への被害状況や設備周辺における影響の有無
竜巻	○				
低温(凍結)	○				設備周辺における凍結影響の有無
降水	○				発電所構内の排水状況や降雨の状況
積雪	○				降雪の有無や発電所構内及び原子炉施設への積雪状況
落雷	○				発電所構内及び原子炉施設周辺の落雷の有無
地滑り	○				豪雨や地下水の浸透、地震に伴う地滑りや土砂崩れの有無や原子炉施設への影響の有無
火山	○				降下火砕物の有無や堆積状況
生物学的事象					海生物(クラゲ等)の来襲による原子炉施設への影響(取水口閉塞等)の有無
飛来物(航空機落下等)					飛来物の有無や構内及び原子炉施設への影響の有無
森林、近隣工場等の火災		○			火災状況、ばい煙の方向確認や発電所構内及び原子炉施設への影響の有無
船舶の衝突		○			発電所港湾施設等に衝突した船舶の状況確認及び原子炉施設への影響の有無

(備考) *1 6条まとめ資料「柏崎刈羽原子力発電所6号及び7号炉 外部からの衝撃による損傷の防止について」参照

*2 柏崎刈羽原子力発電所周辺には氾濫・決壊により影響を及ぼすような河川・湖等はない。また発電所構内の淡水貯水池は基準地震動による地震力で崩壊するおそれはなく、送水配管の一部破損を想定した際にも原子炉施設やアクセスへの影響はない。
(9条まとめ資料「柏崎刈羽原子力発電所6号及び7号炉 内部溢水の影響評価について」、「実用発電用原子炉に係る発電用原子炉設置者の重大事故の発生及び拡大の防止に必要な措置を実施するために必要な技術的能力に係る審査基準」への適合状況についてのうち添付資料1.0.2 可搬型重大事故等対処設備保管場所及びアクセスルートについて)

□ : DB範囲

第 2.1-2 表 津波・構内監視カメラにより中央制御室で把握可能な自然現象等

自然現象等	第6条選定事象*		第4条	第5条	把握できる原子炉施設への影響の有無
	自然	人為			
風(台風)	○				風(台風)・竜巻(飛来物含む)による発電所及び原子炉施設への被害状況や設備周辺における影響の有無
竜巻	○				
降水	○				発電所構内の排水状況や降雨の状況
積雪	○				降雪の有無や発電所構内及び原子炉施設への積雪状況
落雷	○				発電所構内及び原子炉施設周辺の落雷の有無
火山	○				降下火砕物の有無や堆積状況
高潮	○				高潮・津波襲来の状況や発電所構内及び原子炉施設への影響の有無
津波				○	
地震			○		地震発生後の発電所構内及び原子炉施設への影響の有無
外部火災*	○	○			火災状況、ばい煙の方向確認や発電所構内及び原子炉施設への影響の有無
船舶の衝突		○			発電所港湾施設等に衝突した船舶の状況確認及び原子炉施設への影響の有無

※1 6条まとめ資料「東海第二発電所 外部からの衝撃による損傷の防止について」参照

※2 外部火災は「森林火災」及び「近隣工場等の火災」を含む。

□ : DB範囲

表 2.1-3 監視カメラにより中央制御室で把握可能な自然現象等

自然現象等	第6条選定事象*		地震	津波	把握できる原子炉施設への影響の有無
	自然	人為			
監視カメラにより把握できる発電用原子炉施設への影響の有無					監視カメラ以外の設備等による把握手段
地震					地震発生後の発電所構内及び原子炉施設への影響の有無
津波					津波襲来の状況や発電所構内及び原子炉施設への影響の有無
風(台風)					風(台風)・竜巻(飛来物含む)による発電所及び原子炉施設への被害状況や設備周辺における影響の有無
竜巻					
降水					発電所構内の排水状況や原子炉施設への影響の有無
積雪					積雪の有無や発電所構内及び屋外施設への積雪状況
落雷					発電所構内及び原子炉施設周辺の落雷の有無
地滑り					豪雨や地下水の浸透に伴う地滑り及び土石流の有無や原子炉施設への影響の有無
火山					降下火砕物の有無や堆積状況
生物学的事象					海生物(クラゲ等)の来襲による原子炉施設への影響
飛来物(航空機落下)					飛来物の有無や構内及び原子炉施設への影響の有無
外部火災					火災状況、ばい煙の方向確認や発電所構内及び原子炉施設への影響
船舶の衝突					発電所港湾施設等に衝突した船舶の状況確認及び原子炉施設への影響の有無

※1 建物外での状況確認

※2 取水口が閉塞した場合、取水槽水位が下がるため把握可能

□ : DB範囲

・設備の相違
【柏崎6/7,東海第二】
島根2号炉は「監視カメラ以外の設備等による把握手段」も記載

・設備の相違
【柏崎6/7,東海第二】
島根2号炉は「監視カメラ以外の設備等による把握手段」も記載

2.1.5 中央制御室にて把握可能なパラメータ
 自然現象等監視カメラ以外に中央制御室内にて状況把握が可能なパラメータを表2.1-4に示す。

表2.1-4 監視カメラ以外で中央制御室にて監視可能なパラメータ

パラメータ項目	測定レンジ	測定レンジの考え方
大気圧 (原子炉建屋原子炉区域外気差圧)	(6号炉) -2.50~2.50 kPa (7号炉) -1.20~0.30 kPa	台風等により原子炉建屋内外の差圧が大きくなった場合には建屋を保護する必要があることから風影響を把握可能な設計とする。 原子炉建屋原子炉区域外気差圧として、 (6号炉) -1.47~0.49 kPa (7号炉) -0.98~0.2 kPa を把握できる設計とする。
気温	-20.0~40.0℃	観測記録(気象庁アメダス)年超過確率10 ⁻⁴ の値である最低気温-15.2℃、及び最高気温38.8℃が把握できる設計とする。
高温水 (海水温高)	0.0~50.0℃	設計基準温度(海水温高)の30.0℃が把握できる設計としている。
湿度	0~99.9%	—
雨量	0~110.0mm (1時間値)	敷地排水に係る設計降水量である101.3mm (1時間値)を把握できる設計とする。
風向 (標高 20m, 85m, 160m)	全方位	台風等の影響の接近と離散を把握できる設計としている。
風速 (標高 20m, 85m, 160m)	0~60.0m/s (20m) (10分間平均値) 0~30.0m/s (85m, 160m) (10分間平均値)	設計基準風速である標高20m(地上高10m)で40.1m/s (10分間平均値)を把握できるものとする。
取水槽水位	(6号炉) T.M.S.L.-6.5m ~ T.M.S.L.+9.0m (7号炉) T.M.S.L.-5.0m ~ T.M.S.L.+9.0m	津波による水位の低下に対して非常用海水系の取水を確保するため、 常用系ポンプの停止水位及び、非常用海水系ポンプの取水可能水位 (6号炉 T.M.S.L.-5.240, 7号炉 T.M.S.L.-4.920)を把握可能な設計としている。 なお設計基準を超える津波による原子炉施設への影響を把握するための設備としては監視カメラを用いる設計とする。(表2.1-3)
空間線量率 (モニタリング・ポスト 1~9)	10 ¹ ~10 ⁶ nGy/h	「発電用軽水型原子炉施設における事故時の放射線計測に関する審査指針」に定める測定上限値(10 ⁶ nGy/h)を満足する設計とする。

: DB範囲

2.1.5 中央制御室にて把握可能なパラメータ
 津波・構内監視カメラ以外に中央制御室にて把握可能なパラメータを第2.1-3表に示す。

第2.1-3表 津波・構内監視カメラ以外に中央制御室にて把握可能なパラメータ

パラメータ	測定レンジ	測定レンジの考え方
大気温度	-10℃~40℃	測定下限は、凍結リスクが生じる0℃をカバーできる設定とする。
雨量	0~49.5 mm (記録紙印字幅)	積算雨量を記録紙に印字し、50mmを超えると記録紙は再度0mmから印字する。1時間当たりの積算雨量から、1時間雨量(mm/h)を読みとることができる設計とする。
風向 (EL.+18m/EL.+89m/EL.+148m)	0~540° (N~S)	台風等の影響の接近と離散を把握できる設計とする。
風速 (EL.+18m/EL.+89m/EL.+148m)	0~30m/s (10分間平均値)	陸地内部で通常起こりうる風速を測定できる設定とする。
日射量	0~1.2kW/m ²	大気安定度を識別できる設計とする。
放射収支量	0.05kW/m ² ~-0.25kW/m ²	
取水口潮位(新設)	EL.-5.0m~20.0m	津波による水位の低下に対して非常用海水系の取水を確保するため、常用系ポンプの停止水位及び非常用海水系ポンプの取水可能水位(-6.08m)を把握可能な設計とする。
取水ビット水位(新設)	EL.-7.8m~2.3m	なお、設計基準を超える津波による原子炉施設への影響を把握するための設備としては監視カメラを用いる設計とする。(第2.1-3表)
空間線量率 (モニタリング・ポスト A~D)	低レンジ	10 ¹ nGy/h~10 ⁵ nGy/h
	高レンジ	10 ⁻⁸ Gy/h~10 ⁻¹ Gy/h

: DB範囲

2.1.5 中央制御室にて把握可能なパラメータ
 監視カメラ以外に中央制御室内にて状況把握が可能なパラメータを表2.1-4に示す。

表2.1-4 構内監視カメラ以外で中央制御室にて監視可能なパラメータ

パラメータ	測定レンジ	測定レンジの考え方
大気圧	85~110kPa (絶対圧)	台風等による原子炉施設への風影響を把握できる設計としている。
気温	-10~40℃	設計基準温度(低外気温)である-8.7℃が把握できる設計としている。
海水温	0~50℃	設計基準温度(海水温高)である30℃が把握できる設計としている。
湿度	0~100%	—
雨量	0~80 mm	設計基準降水量である77.9mm (1時間値)を把握できる設計としている。
風向 (EL28.5m, EL65m, EL130m)	全方位 (0~540°)	台風等の影響の接近と離散を把握できる設計としている。
風速(水平) (EL28.5m, EL65m, EL130m)	0~60m/s(EL28.5m) (10分間平均値) 0~30m/s (EL65m, EL130m) (10分間平均値)	設計基準風速である30m/s (10分間平均値)を把握できるものとする。
風速(鉛直) (EL.65m, EL.130m)	-10~10m/s (10分間平均値)	
取水槽水位	EL.-9.3~10.7m	基準津波による津波高さ(下降側)であるEL.-7.2mを把握可能な設計としている。 なお、設計基準を超える津波による原子炉施設への影響を把握するための設備としては監視カメラを用いる設計とする。(表2.1-3)
空間線量率 (モニタリングポスト No.1~6)	10 ¹ ~10 ⁸ nGy/h	「発電用軽水型原子炉施設における事故時の放射線計測に関する審査指針」に定める測定上限値(10 ⁸ nGy/h)を満足する設計とする。

: DB範囲

2.2 酸素濃度計等について

2.2.1 酸素濃度・二酸化炭素濃度計の設備概要

外気から中央制御室への空気の取り込みを停止した場合に、酸素濃度、二酸化炭素濃度が事故対策のための活動に支障がない範囲にあることを正確に把握するため、6号炉及び7号炉中央制御室には酸素濃度・二酸化炭素濃度計を各号炉毎に1台配備している。

表 2.2-1 酸素濃度・二酸化炭素濃度計の概要

機器名称及び外観	仕様等	
酸素濃度・二酸化炭素濃度計 	検知原理	二酸化炭素：NDIR（非分散型赤外線） 酸素：ガルバニ式
	検知範囲	二酸化炭素：0.04%~5.00% 酸素：5.0~30.0%
	表示精度	二酸化炭素：±10% 酸素：3%FS
	電源	電源：乾電池（単三×4） 測定可能時間：約20時間 （バッテリー切れの場合、予備を稼働させ、乾電池交換を実施する。）
	台数	6号及び7号炉に各1台 （故障時及び保守点検による待機除外時のバックアップ用として予備1個を保有する。）

 : DB範囲
 : SA範囲

2.2 酸素濃度計及び二酸化炭素濃度計について

2.2.1 酸素濃度計及び二酸化炭素濃度計の設備概要

外気から中央制御室への空気の取り込みを停止した場合に、酸素濃度及び二酸化炭素濃度が事故対策のための活動に支障がない範囲にあることを正確に把握するため、中央制御室に酸素濃度計及び二酸化炭素濃度計を配備する。

酸素濃度計及び二酸化炭素濃度計の概要を第 2.2-1 表に示す。

第 2.2-1 表 酸素濃度計及び二酸化炭素濃度計の概要

名称及び外観	仕様等	
酸素濃度計 	検知原理	ガルバニ式
	検知範囲	0.0~40.0vol%
	表示精度	±0.1vol%
	電源	電源：乾電池（単四×2本） 測定可能時間：約3,000時間 （乾電池切れの場合、乾電池交換を実施する。）
個数	1個（故障時及び保守点検による待機除外時のバックアップ用として予備1個を保有する。）	
二酸化炭素濃度計 	検知原理	NDIR（非分散型赤外線）
	検知範囲	0.0~5.0vol%
	表示精度	±3.0%F.S.
	電源	電源：乾電池（単三×4本） 測定可能時間：約12時間 （乾電池切れの場合、乾電池交換を実施する。）
個数	1個（故障時及び保守点検による待機除外時のバックアップ用として予備1個を保有する。）	

 : DB範囲
 : SA範囲

2.2 酸素濃度計及び二酸化炭素濃度計について

2.2.1 酸素濃度計及び二酸化炭素濃度計の設備概要

外気から中央制御室への空気の取り込みを停止した場合に、酸素濃度及び二酸化炭素濃度が事故対策のための活動に支障がない範囲にあることを正確に把握するため、中央制御室には酸素濃度計及び二酸化炭素濃度計を配備している。

表 2.2-1 酸素濃度計及び二酸化炭素濃度計の概要

機器名称及び外観	仕様等	
酸素濃度計 	検知原理	ガルバニ式
	検知範囲	0.0~25.0vol%
	表示精度	±0.5vol%
	電源	電源：乾電池（単三×2本） 測定可能時間：約15,000時間 （乾電池切れの場合、乾電池交換を実施する。）
個数	1個（故障時及び保守点検による待機除外時のバックアップ用として予備1個を保有する。）	
二酸化炭素濃度計 	検知原理	NDIR（非分散型赤外線）
	検知範囲	0~10,000ppm
	表示精度	±500ppm
	電源	電源：乾電池（単四×2本） 測定可能時間：約7時間 （乾電池切れの場合、乾電池交換を実施する。）
個数	1個（故障時及び保守点検による待機除外時のバックアップ用として予備1個を保有する。）	

 : DB範囲
 : SA範囲

- ・設備の相違
【柏崎 6/7】
①の相違
- ・申請号炉数の相違
【柏崎 6, 7, 東海第二】
- ・設備仕様の相違
【柏崎 6/7, 東海第二】

2.2.2 酸素濃度、二酸化炭素濃度の管理
 酸素濃度・二酸化炭素濃度計による室内酸素濃度、二酸化炭素濃度管理は、労働安全衛生法及びJEAC4622-2009「原子力発電所中央制御室運転員の事故時被ばくに関する規程」に基づき、酸素濃度が18%を下回るおそれがある場合、又は二酸化炭素濃度が0.5%を上回るおそれがある場合に、外気をフィルタにて浄化しながら取り入れる運用としている。

酸素欠乏症等防止規則（一部抜粋）
 （定義）
 第二条 この省令において、次の各号に掲げる用語の意義は、それぞれ当該各号に定めるところによる。
 一 酸素欠乏 空気中の酸素の濃度が十八パーセント未満である状態をいう。
 （換気）
 第五条 事業者は、酸素欠乏危険作業に労働者を従事させる場合は、当該作業を行う場所の空気中の酸素の濃度を十八パーセント以上（第二種酸素欠乏危険作業に係る場所にあつては、空気中の酸素の濃度を十八パーセント以上、かつ、硫化水素の濃度を百万分の十以下）に保つように換気しなければならない。ただし、爆発、酸化等を防止するため換気することができない場合又は作業の性質上換気することが著しく困難な場合は、この限りでない。

酸素濃度	症状等
21%	通常の空気の状態
18%	安全限界だが連続換気が必要
16%	頭痛、吐き気
12%	目まい、筋力低下
8%	失神昏倒、7～8分以内に死亡
6%	瞬時に昏倒、呼吸停止、死亡

（出典：厚生労働省リーフレット「なくそう！酸素欠乏症・硫化水素中毒」）



2.2.2 酸素濃度及び二酸化炭素濃度の管理
 「労働安全衛生法」、JEAC4622-2009「原子力発電所中央制御室運転員等の事故時被ばくに関する規定」及び「鉱山保安法施行規則」を踏まえ、酸素濃度が19%を下回るおそれのある場合又は二酸化炭素濃度が1.0%を上回るおそれのある場合に、外気をフィルタで浄化しながら取り入れる運用とする。なお、法令要求等における酸素濃度及び二酸化炭素濃度の基準値は、以下のとおりである。

「酸素濃度の人体への影響について」を第2.2-2表に、「二酸化炭素濃度の人体への影響について」を第2.2-3表に示す。

(1) 酸素濃度

酸素欠乏症等防止規則（一部抜粋）
 （定義）
 第二条 この省令において、次の各号に掲げる用語の意義は、それぞれ当該各号に定めるところによる。
 一 酸素欠乏 空気中の酸素の濃度が十八パーセント未満である状態をいう。
 （換気）
 第五条 事業者は、酸素欠乏危険作業に労働者を従事させる場合は、当該作業を行う場所の空気中の酸素の濃度を十八パーセント以上（第二種酸素欠乏危険作業に係る場所にあつては、空気中の酸素の濃度を十八パーセント以上、かつ、硫化水素の濃度を百万分の十以下）に保つように換気しなければならない。ただし、爆発、酸化等を防止するため換気することができない場合又は作業の性質上換気することが著しく困難な場合は、この限りでない。

鉱山保安法施行規則（一部抜粋）
 第十六条の二
 一 鉱山労働者が作業し、又は通行する坑内の空気中の酸素含有率は十九パーセント以上とし、炭酸ガス含有率は一パーセント以下とすること。

第2.2-2表 酸素濃度の人体への影響について（〔出典〕厚生労働省ホームページ（抜粋））

酸素濃度	症状等
21%	通常の空気の状態
18%	安全限界だが連続換気が必要
16%	頭痛、吐き気
12%	目まい、筋力低下
8%	失神昏倒、7～8分以内に死亡
6%	瞬時に昏倒、呼吸停止、死亡



2.2.2 酸素濃度及び二酸化炭素濃度の管理
 酸素濃度計及び二酸化炭素濃度計による室内酸素濃度及び二酸化炭素濃度管理は、「労働安全衛生法」、JEAC4622-2009「原子力発電所中央制御室運転員の事故時被ばくに関する規程」に基づき、酸素濃度が18%を下回るおそれがある場合、又は二酸化炭素濃度が0.5%を上回るおそれがある場合に、外気をフィルタにて浄化しながら取り入れる運用としている。

酸素欠乏症等防止規則（一部抜粋）
 （定義）
 第二条 この省令において、次の各号に掲げる用語の意義は、それぞれ当該各号に定めるところによる。
 一 酸素欠乏 空気中の酸素の濃度が十八パーセント未満である状態をいう。
 （換気）
 第五条 事業者は、酸素欠乏危険作業に労働者を従事させる場合は、当該作業を行う場所の空気中の酸素の濃度を十八パーセント以上（第二種酸素欠乏危険作業に係る場所にあつては、空気中の酸素の濃度を十八パーセント以上、かつ、硫化水素の濃度を百万分の十以下）に保つように換気しなければならない。ただし、爆発、酸化等を防止するため換気することができない場合又は作業の性質上換気することが著しく困難な場合は、この限りでない。

酸素濃度	症状等
21%	通常の空気の状態
18%	安全限界だが連続換気が必要
16%	頭痛、吐き気
12%	目まい、筋力低下
8%	失神昏倒、7～8分以内に死亡
6%	瞬時に昏倒、呼吸停止、死亡

（出典：厚生労働省リーフレット「なくそう！酸素欠乏症・硫化水素中毒」）



JEAC4622-2009「原子力発電所中央制御室運転員の事故時被ばくに関する規程」(一部抜粋)

【付属書解説2.5.2】事故時の外気の取り込み

中央制御室換気空調設備の隔離が長期に亘る場合には、中央制御室内のCO₂濃度の上昇による運転員の操作環境の劣化防止のために外気を取り込む場合がある。

(1) 許容CO₂濃度

事務所衛生基準規則(昭和47年労働省令第43号、最終改正平成16年3月30日厚生労働省令第70号)により、事務室内のCO₂濃度は100万分の5000(0.5%)以下と定められており、中央制御室のCO₂濃度もこれに準拠する。したがって、中央制御室居住性の評価にあたっては、上記濃度(0.5%)を許容濃度とする。

 : DB範囲
 : SA範囲

(2) 二酸化炭素濃度

「鉱山保安法施行規則」(一部抜粋)
 第十六条の一
 一 鉱山労働者が作業し、又は通行する坑内の空気の酸素含有率は十九パーセント以上とし、炭酸ガス含有率は一パーセント以下とすること。

JEAC4622-2009「原子力発電所中央制御室運転員等の事故時被ばくに関する規定」(一部抜粋)
 【付属書解説2.5.2】事故時の外気の取り込み
 中央制御室換気空調設備の隔離が長期に亘る場合には、中央制御室内のCO₂濃度の上昇による運転員等の操作環境の劣化防止のために外気を取り込む場合がある。
 (1) 許容CO₂濃度
 事務所衛生基準規則(昭和47年労働省令第43号、最終改正平成16年3月30日厚生労働省令第70号)により、事務室内のCO₂濃度は100万分の5000(0.5%)以下と定められており、中央制御室のCO₂濃度もこれに準拠する。したがって、中央制御室居住性の評価にあたっては、上記濃度(0.5%)を許容濃度とする。

第2.2-3表 二酸化炭素濃度の人体への影響について(〔出典〕消防庁「二酸化炭素消火設備の安全対策について(通知)」平成8年9月20日)

二酸化炭素濃度	症状発現までの暴露時間	人体への影響
< 2%		はっきりした影響は認められない
2%~3%	5~10分	呼吸深度の増加、呼吸数の増加
3%~4%	10~30分	頭痛、めまい、悪心、知覚低下
4%~6%	5~10分	上記症状、過呼吸による不快感
6%~8%	10~60分	意識レベルの低下、その後意識喪失へ進む、ふるえ、けいれんなどの不随意運動を伴うこともある
8%~10%	1~10分	同上
10% <	< 数分	意識喪失、その後短時間で生命の危険あり
30%	8~12呼吸	同上

 : DB範囲
 : SA範囲

JEAC4622-2009「原子力発電所中央制御室運転員の事故時被ばくに関する規程」(一部抜粋)

【付属書解説2.5.2】事故時の外気の取り込み

中央制御室換気空調設備の隔離が長期に亘る場合には、中央制御室内のCO₂濃度の上昇による運転員の操作環境の劣化防止のために外気を取り込む場合がある。

(1) 許容CO₂濃度

事務所衛生基準規則(昭和47年労働省令第43号、最終改正平成16年3月30日厚生労働省令第70号)により、事務室内のCO₂濃度は100万分の5000(0.5%)以下と定められており、中央制御室のCO₂濃度もこれに準拠する。したがって、中央制御室居住性の評価にあたっては、上記濃度(0.5%)を許容濃度とする。

 : DB範囲
 : SA範囲

2.3 汚染の持ち込み防止について

中央制御室には、中央制御室の外側が放射性物質により汚染したような状況下において、中央制御室への汚染の持ち込みを防止するため、モニタリング及び作業服の着替え等を行うためのチェンジングエリアを設ける。

チェンジングエリアは、中央制御室に待機していた要員が、中央制御室外で作業を行った後、再度、中央制御室に入室する際等に利用する。

チェンジングエリアは、要員の被ばく低減の観点からコントロール建屋内、かつ中央制御室陽圧化バウンダリに隣接した場所に設営する。また、チェンジングエリア付近の全照明が消灯した場合を想定し、乾電池内蔵型照明を配備する。中央制御室のチェンジングエリア設営場所及び概略図を図2.3-1に示す。

また、チェンジングエリアの設営は、保安班員2名で、約60分を想定している。チェンジングエリアの設営のタイムチャートを図2.3-2に示す。



図 2.3-1 中央制御室チェンジングエリア設営場所及び概略図

: SA 範囲

2.3 汚染の持ち込み防止について

中央制御室には、中央制御室の外側が放射性物質により汚染したような状況下において、中央制御室への汚染の持ち込みを防止するため、身体汚染検査及び防護具の脱衣等を行うためのチェンジングエリアを設ける。

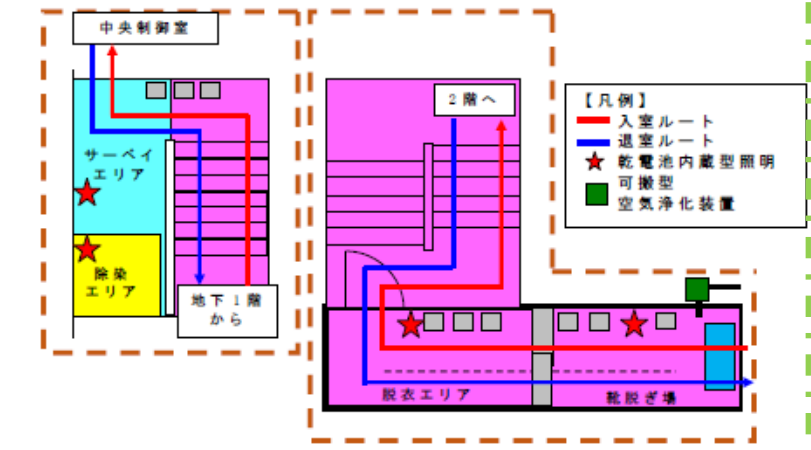
チェンジングエリアは、中央制御室外で作業を行った要員が、中央制御室に入室する際等に利用する。

チェンジングエリアは、要員の被ばく低減の観点から原子炉建屋内で中央制御室バウンダリに隣接した場所である空調機械室内に設営する。また、チェンジングエリア付近の全照明が消灯した場合を想定し、可搬型照明(SA)を配備する。中央制御室のチェンジングエリア設営場所及び概要図を第2.3-1図に示す。

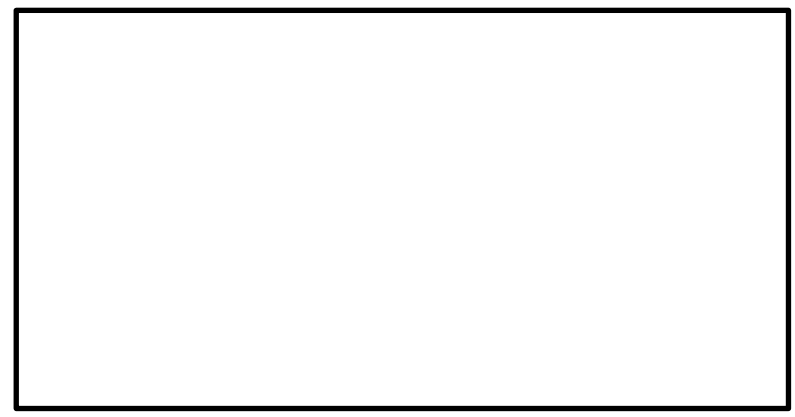

第 2.3-1 図 中央制御室チェンジングエリア設営場所及び概要

図

: SA 範囲

2.3 汚染の持ち込み防止について

中央制御室には、中央制御室の外側が放射性物質により汚染したような状況下において、中央制御室への汚染の持ち込みを防止するため、モニタリング及び作業服の着替え等を行うためのチェンジングエリアを設ける。

チェンジングエリアは、中央制御室に待機していた要員が、中央制御室外で作業を行った後、再度、中央制御室に入室する際等に利用する。

チェンジングエリアは、要員の被ばく低減の観点からタービン建物内、かつ中央制御室正圧化バウンダリに隣接した場所に設営する。また、チェンジングエリア付近の全照明が消灯した場合を想定し、チェンジングエリア用照明を配備する。中央制御室のチェンジングエリア設営場所及び概略図を図2.3-1に示す。

また、チェンジングエリアの設営は、緊急時対策要員2名で、2時間以内を想定している。チェンジングエリアの設営のタイムチャートを図2.3-2に示す。



図 2.3-1 中央制御室チェンジングエリア設営場所及び概略図

: SA 範囲

・運用の相違
【柏崎 6/7, 東海第二】
島根 2号炉は設営時間を2時間と想定
(図 2.3-2 タイムチャートに示す)

柏崎刈羽原子力発電所 6 / 7号炉 (2017.12.20)

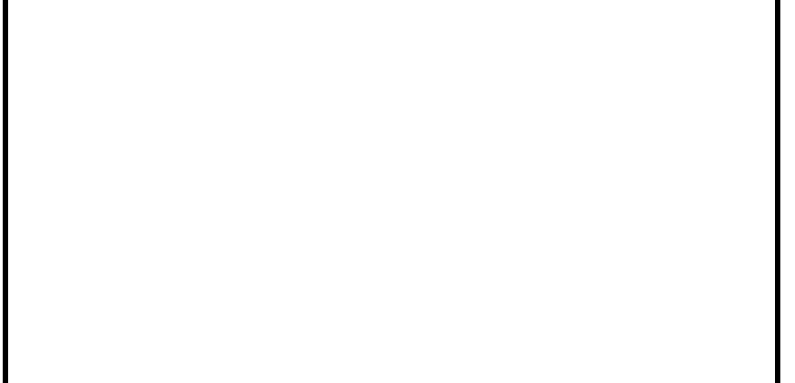
東海第二発電所 (2018.9.18版)

島根原子力発電所 2号炉

備考



図 2.3-2 チェンジングエリアの設営のタイムチャート

： SA 範囲



図 2.3-2 チェンジングエリアの設営のタイムチャート

： SA 範囲

・記載内容の相違
【東海第二】
島根 2号炉及び柏崎は
チェンジングエリアの
設営タイムチャートを
記載

柏崎刈羽原子力発電所 6/7号炉 (2017.12.20)	東海第二発電所 (2018.9.18版)	島根原子力発電所 2号炉	備考
<p>2.4 炉心の著しい損傷が発生した場合に運転員がとどまるための設備について</p> <p>2.4.1 概要</p> <p>炉心の著しい損傷が発生した場合においても中央制御室に運転員がとどまる居住性を確保するため、<u>遮蔽設備及び陽圧化設備を備えた中央制御室及び中央制御室待避室を設置する。</u></p> <p>中央制御室は、6号及び7号炉中央制御室換気空調系の隔離ダンパを閉操作し、中央制御室可搬型陽圧化空調機により、中央制御室換気空調系バウンダリに放射性物質を浄化した外気を供給することで、中央制御室換気空調系バウンダリ全体を陽圧化可能な設計とする。</p> <p>中央制御室待避室は、陽圧化装置により中央制御室換気空調系バウンダリ内の遮蔽に囲まれた気密空間を陽圧化し、外気の流入を一定時間完全に遮断することで、重大事故発生後の格納容器圧力逃がし装置を作動させる際のプルームの影響による運転員の被ばくを低減することが可能な設計とする。</p> <p>中央制御室待避室は炉心の著しい損傷が発生した場合の格納容器圧力逃がし装置を作動させる際の中央制御室内執務の運転員及び現場操作対応の運転員を収容することに加え、<u>重大事故等の事故シーケンスを組み合わせた場合においても、関係する6号及び7号炉運転員数18名に予備要員の余裕を持たせた合計20名を収容可能な設計とし、かつ十分な資機材類を配備する設計とする。</u></p> <p style="text-align: right;">: SA範囲</p>	<p>2.4 重大事故が発生した場合に運転員がとどまるための設備について</p> <p>2.4.1 概要</p> <p>重大事故等が発生した場合においても中央制御室に運転員がとどまるために必要な設備として、<u>遮蔽設備、換気系設備、通信連絡設備、データ表示装置(待避室)、照明設備、酸素濃度計及び二酸化炭素濃度計を中央制御室に設置又は保管する。</u></p> <p>中央制御室は、周囲に遮蔽が設置されており、<u>重大事故等が発生した場合に中央制御室換気系給排気隔離弁により外気との連絡口を遮断し、空気調和機ファン及びフィルタ系ファンによる高粒子フィルタ及びチャコールフィルタを通した閉回路循環方式とし、運転員を過度の被ばくから防護する設計とする。</u></p> <p>原子炉建屋ガス処理系は、原子炉建屋原子炉棟内を負圧に維持するとともに、原子炉格納容器から原子炉建屋原子炉棟内に漏えいした放射性物質を含む気体を非常用ガス処理系排気筒から排気することで、<u>運転員を過度の被ばくから防護する設計とする。</u></p> <p>中央制御室待避室は、中央制御室内に設置し、<u>中央制御室待避室空気ポンプユニットにより中央制御室待避室内の遮蔽に囲まれた空間を正圧化し、外気の流入を一定時間完全に遮断することで、重大事故発生後に格納容器圧力逃がし装置を作動させる際のプルームの影響による運転員の被ばくを低減することが可能な設計とする。</u></p> <p>また、中央制御室待避室は、<u>重大事故時に格納容器圧力逃がし装置を作動させた場合においても、中央制御室にとどまる必要のある最低限の要員である3名を収容可能な設計とする。</u></p> <p style="text-align: right;">: SA範囲</p>	<p>2.4 炉心の著しい損傷が発生した場合に運転員がとどまるための設備について</p> <p>2.4.1 概要</p> <p>炉心の著しい損傷が発生した場合においても中央制御室に運転員がとどまるために必要な設備として、<u>遮蔽設備、換気系設備、通信連絡設備、プラントパラメータ監視装置(中央制御室待避室)、照明設備、酸素濃度計及び二酸化炭素濃度計を中央制御室に設置又は保管する。</u></p> <p>中央制御室は、周囲に遮蔽が設置されており、<u>炉心の著しい損傷が発生した場合に中央制御室換気系給排気隔離弁又は中央制御室外気取入調節弁により外気との連絡口を遮断し、再循環用ファン及びチャコール・フィルタ・ブースタ・ファンによるチャコール・フィルタ・ユニットを通した系統隔離運転若しくは、チャコール・フィルタ・ユニットにより放射性物質を浄化した外気を供給することで中央制御室バウンダリを正圧化する加圧運転を行う事により、運転員を過度の被ばくから防護する設計とする。</u></p> <p>非常用ガス処理系は、<u>原子炉建物原子炉棟内を負圧に維持するとともに、原子炉格納容器から原子炉建物原子炉棟内に漏えいた放射性物質を含む気体を排気筒に沿わせて設ける排気管から排気することで、運転員を過度の被ばくから防護する設計とする。</u></p> <p>中央制御室待避室は、中央制御室内に設置し、<u>中央制御室待避室正圧化装置により中央制御室バウンダリ内の遮蔽に囲まれた気密空間を正圧化し、外気の流入を一定時間完全に遮断することで、重大事故発生後の格納容器フィルタベント系を作動させる際のプルームの影響による運転員の被ばくを低減することが可能な設計とする。</u></p> <p>中央制御室待避室は、炉心の著しい損傷が発生した場合の格納容器フィルタベント系を作動させる際の中央制御室内執務の運転員及び現場操作対応の運転員合計5名を収容可能な設計とし、<u>かつ十分な資機材類を配備する設計としている。(各事故シーケンスにおける運転員の対応要員数については、「3.6 中央制御室待避室の収容性」に示す。)</u></p> <p style="text-align: right;">: SA範囲</p>	<p>備考</p> <ul style="list-style-type: none"> ・運用の相違 【東海第二】 島根2号炉は系統隔離運転と加圧運転どちらも実施可能なように設備及び手順を整備する ・設備の相違 【柏崎6/7】 ②の相違 ・記載方針の相違 【柏崎6/7】 島根2号炉は非常用ガス処理系について記載 【東海第二】 島根2号炉は非常用ガス処理系排気管の設置状況を詳細に記載 ・設計方針の相違 【柏崎6/7, 東海第二】 島根2号炉の対応要員数は「3.6 中央制御室待避室の収容性」に示す5名とする (以下, ④の相違)

柏崎刈羽原子力発電所 6/7号炉 (2017.12.20)	東海第二発電所 (2018.9.18版)	島根原子力発電所 2号炉	備考
<p>(事故シーケンスの組み合わせについては、「3.6事故シーケンスの組み合わせと待避室の収容性」に示す。)</p> <p>また、中央制御室待避室には、<u>酸素濃度・二酸化炭素濃度計</u>、<u>可搬型エリアモニタ</u>を配備することで、居住性確保ができてい ることを常時確認できる設計とする。<u>可搬型蓄電池内蔵型照 明</u>、<u>乾電池内蔵型照明</u>、<u>データ表示装置</u>、<u>通信連絡設備</u>を配備 することで、中央制御室待避室においても継続的にプラントの 監視を行うことが可能な設計とし、<u>必要に応じ中央制御室制御 盤でのプラント操作を行うことができる設計とする。</u></p> <p>中央制御室及び中央制御室待避室の陽圧化設備の系統概要を 図2.4-1に、陽圧化バウンダリを図2.4-2に示す。<u>なお6号炉及び 7号炉中央制御室を構成する、各号炉の上部中央制御室エリア (コントロール建屋2F T.M.S.L. +17.3m) と下部中央制御室エ リア (コントロール建屋1F T.M.S.L. +12.3m) とは、各号炉の中 央制御室換気空調系ダクトにて接続された設計としており、上 部中央制御室・下部中央制御室一体となった中央制御室陽圧化 バウンダリを構成する。</u></p> <p style="text-align: center;"> : SA範囲</p>	<p>中央制御室及び中央制御室待避室は、<u>酸素濃度計及び二酸化 炭素濃度計</u>により、<u>居住性を確保していること</u>の確認が可能な 設計とする。また、中央制御室に保管している<u>可搬型照明 (S A) 及びデータ表示装置 (待避室)</u>を中央制御室待避室に設置 することで、<u>継続的にプラントの監視を行うとともに、通信連 絡設備により外部との連絡を可能とし、必要に応じて中央制御 室制御盤でのプラント操作を行うことができる設計とする。</u></p> <p style="text-align: center;"> : SA範囲</p>	<p>また、中央制御室及び中央制御室待避室には、<u>酸素濃度計、二 酸化炭素濃度計及び電離箱サーベイ・メータ</u>を配備することで、 居住性が確保できていることを常時確認できる設計とする。<u>L.E Dライト (ランタンタイプ)</u>、<u>プラントパラメータ監視装置 (中 央制御室待避室) 及び通信連絡設備</u>を配備することで、中央制御 室待避室においても継続的にプラントの監視を行うことが可能 な設計とする。中央制御室待避室への待避期間中における運 転操作は不要であるが、万一、運転操作が必要となった場合には、必 要な防護具類を着用した上で、中央制御室待避室から退出、制御 盤での操作を行い、操作終了後、速やかに中央制御室待避室へ移 動する。</p> <p>中央制御室換気系及び中央制御室待避室正圧化装置の系統概 要を図2.4-1に、正圧化バウンダリを図2.4-2に示す。</p> <p style="text-align: center;"> : SA範囲</p>	<p>備考</p> <ul style="list-style-type: none"> ・設備の相違 【柏崎 6/7】 ①の相違 ・申請号炉数の相違 【柏崎 6/7】



図 2.4-1 中央制御室及び中央制御室待避室の陽圧化設備 系統概要図



図 2.4-2 中央制御室及び中央制御室待避室の陽圧化バウンダリ 図

 : SA範囲

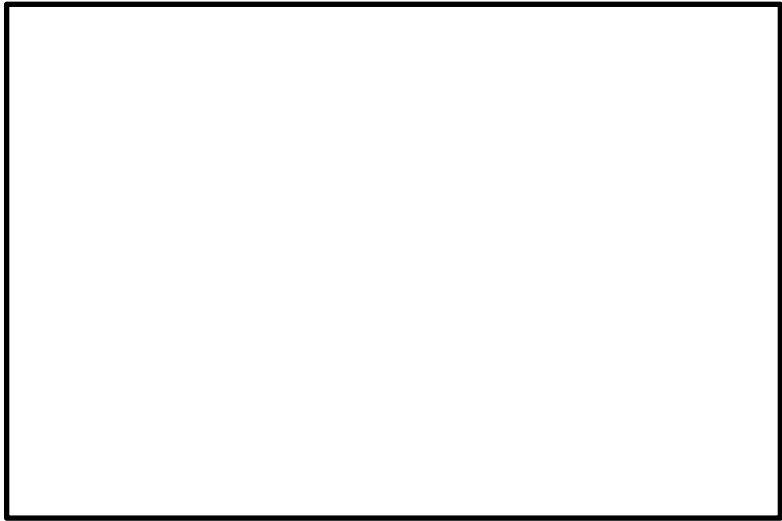

図 2.4-1 中央制御室換気系及び中央制御室待避室正圧化装置 系統概要図



図 2.4-2 中央制御室及び中央制御室待避室の正圧化バウンダリ 図

 : SA範囲

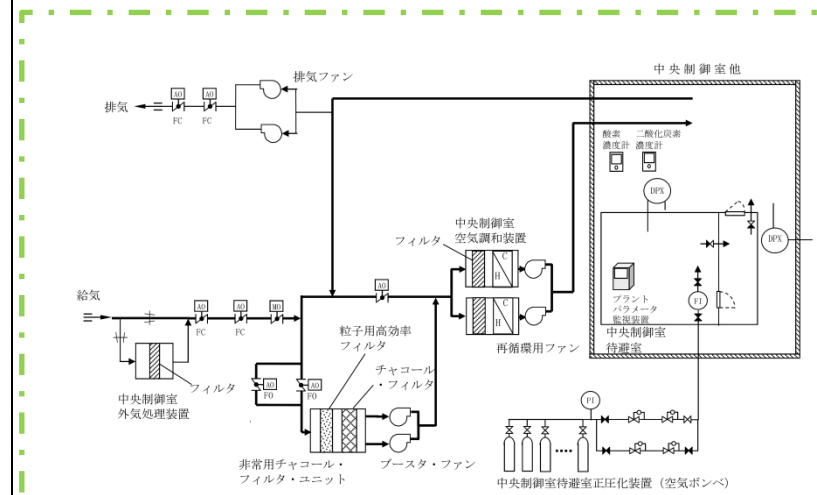
柏崎刈羽原子力発電所 6/7号炉 (2017.12.20)	東海第二発電所 (2018.9.18版)	島根原子力発電所 2号炉	備考
<p>2.4.2 中央制御室及び中央制御室待避室陽圧化バウンダリの設計差圧</p> <p>中央制御室及び中央制御室待避室陽圧化バウンダリは、配置上、動圧の影響を直接受けない屋内に設置されているため、室内へのインリークは隣接区画との温度差によるものと考えられる。</p> <p>低温及び高温の設計基準については、観測記録（気象庁アメダス）年超過確率評価を踏まえ最低気温が最も小さく、及び最高気温が最も大きくなる値を設計基準として定めた。評価の結果、統計的な処理による年超過確率10^{-4}の値として最低気温は-15.2°C、及び最高気温は38.8°Cとなった。</p> <p>中央制御室及び中央制御室待避室陽圧化バウンダリの設計に際しては、重大事故等時の室内の温度を中央制御室のあるコントロール建屋の設計最高温度40°C、隣接区画を年超過確率10^{-4}の値よりも厳しい最低温度-17.0°Cと仮定すると、中央制御室及び中央制御室待避室の階層高さは最大6mであるため、以下のとおり約15Paの圧力差があれば、温度の影響を無視できると考えられる。</p> $\Delta P = \{(-17.0^{\circ}\text{Cの乾き空気密度}) - (+40^{\circ}\text{Cの乾き空気の密度})\} \times \text{階層高さ}$ $= (1.378 - 1.127) \times 6$ $= 1.506 \text{kg/m}^2$ $\approx 15 \text{Pa}$ <p>このため、陽圧化バウンダリの必要差圧は設計裕度を考慮して隣接区画+20Paとする。</p>	<p>2.4.2 中央制御室待避室正圧化バウンダリの設計差圧</p> <p>中央制御室待避室正圧化バウンダリは、配置上、動圧の影響を直接受けない屋内に設置されているため、中央制御室待避室内へのインリークは隣接区画との温度差によるものと考えられる。</p> <p>重大事故等時の中央制御室待避室内の温度を中央制御室の設計最高温度である48.9°C、隣接区画の温度を外気の設計最低温度である-12.7°Cと仮定すると、中央制御室待避室の天井高さは最大約2mであるため、以下のとおり約5.1Pa [gage]の圧力差があれば、温度の影響を無視できると考えられる。</p> $\Delta P = \{(-12.7^{\circ}\text{Cの乾き空気密度} [\text{kg/m}^3]) - (+48.9^{\circ}\text{Cの乾き空気の密度} [\text{kg/m}^3])\} \times \text{天井高さ} [\text{m}]$ $= (1.3555 [\text{kg/m}^3] - 1.0963 [\text{kg/m}^3]) \times 2 [\text{m}]$ $= 0.5184 [\text{kg/m}^2]$ $\approx 5.1 [\text{Pa} [\text{gage}]]$ <p>このため、正圧化バウンダリの必要差圧は、設計裕度を考慮して隣接区画+10Pa [gage]とする。</p>	<p>2.4.2 中央制御室及び中央制御室待避室正圧化バウンダリの設計差圧</p> <p>中央制御室及び中央制御室待避室正圧化バウンダリは、配置上、動圧の影響を直接受けない屋内に設置されているため、室内へのインリークは隣接区画との温度差によるものと考えられる。</p> <p>重大事故等発生時の室内の温度を中央制御室のある制御室建物の設計最高温度40°C、隣接区画を外気の設計最低温度-8.7°Cと仮定すると、中央制御室の階層高さは最大約5.2mであるため、以下のとおり約11Paの圧力差があれば、温度の影響を無視できると考えられる。</p> $\Delta P = \{(-8.7^{\circ}\text{Cの乾き空気密度} [\text{kg/m}^3]) - (40^{\circ}\text{Cの乾き空気密度} [\text{kg/m}^3])\} \times \text{重力加速度} [\text{m/s}^2] \times \text{階層高さ} [\text{m}]$ $= (1.335 [\text{kg/m}^3] - 1.127 [\text{kg/m}^3]) \times 9.8 [\text{m/s}^2] \times 5.2 [\text{m}]$ $= 10.60 [\text{N/m}^2] \approx 11 [\text{Pa}]$ <p>このため、中央制御室正圧化バウンダリの設計差圧は設計裕度を考慮して図 2.4-3 のように、$+20\text{Pa}$以上とする。</p> <div data-bbox="1843 1539 2395 1667" style="border: 1px solid black; padding: 5px; margin: 10px auto; width: fit-content;"> <p style="text-align: center;">外気</p> <div style="border: 1px solid black; padding: 2px; margin: 5px auto; width: 80%;"> <p style="text-align: center;">中央制御室：外気に対して+20Pa以上</p> </div> </div> <p style="text-align: center;">図 2.4-3 中央制御室 正圧化圧力</p>	<p>備考</p> <ul style="list-style-type: none"> ・設計方針の相違 【柏崎 6/7, 東海第二】 6条 自然現象に係る設計基準の考え方の相違 ・設備の相違 【柏崎 6/7, 東海第二】 島根 2号炉の気象条件及び階層高さを適用 ・設計条件の相違 【柏崎 6/7, 東海第二】 島根 2号炉の設計条件を記載 ・評価結果の相違 【柏崎 6/7, 東海第二】 島根 2号炉の設計条件による設計差圧。
: SA範囲	: SA範囲	: SA範囲	

柏崎刈羽原子力発電所 6 / 7号炉 (2017.12.20)	東海第二発電所 (2018.9.18版)	島根原子力発電所 2号炉	備考
---------------------------------	----------------------	--------------	----

また、中央制御室は隣接区画からのインリークを防止し、中央制御室待避室は中央制御室及び隣接区画からのインリークを防止する設計とし、中央制御室及び中央制御室待避室陽圧化バウンダリの設計差圧は図2.4-3のように、中央制御室を20Pa以上40Pa未満、中央制御室待避室を60Pa以上とする。



図 2.4-3 中央制御室及び中央制御室待避室 陽圧化圧力

 : SA 範囲

(This column is empty in the provided image)

また、重大事故等発生時の中央制御室待避室内の温度を中央制御室のある制御建物の設計最高温度 40℃、隣接区画を外気的设计最低温度 -8.7℃、中央制御室待避室の階層高さを約 2.5m と仮定すると、以下のとおり約 6Pa の圧力差があれば、温度の影響を無視できると考えられる。

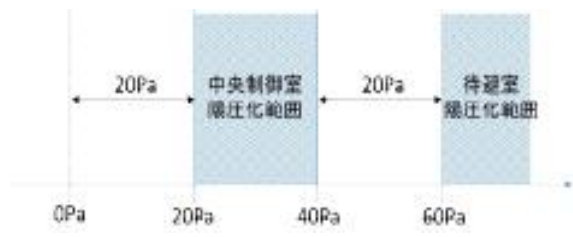
$$\Delta P = \{ (-8.7^{\circ}\text{C} \text{の乾き空気密度 } [\text{kg}/\text{m}^3]) - (40^{\circ}\text{C} \text{の乾き空気密度 } [\text{kg}/\text{m}^3]) \} \times \text{重力加速度 } [\text{m}/\text{s}^2] \times \text{階層高さ}$$

$$= (1.335 [\text{kg}/\text{m}^3] - 1.127 [\text{kg}/\text{m}^3]) \times 9.8 [\text{m}/\text{s}^2] \times 2.5 [\text{m}]$$

$$= 5.1 [\text{N}/\text{m}^2] \approx 6 [\text{Pa}]$$

このため、中央制御室待避室の設計差圧は設計裕度を考慮して図 2.4-4 のように中央制御室に対して +10Pa 以上とする。



図 2.4-4 中央制御室待避室 正圧化圧力

 : SA 範囲

・設備の相違
【柏崎 6/7, 東海第二】
島根 2 号炉は中央制御室待避室の設計差圧を記載

柏崎刈羽原子力発電所 6/7号炉 (2017.12.20)	東海第二発電所 (2018.9.18版)	島根原子力発電所 2号炉	備考
<p>2.4.3 中央制御室の居住性確保</p> <p>(1) 設計方針</p> <p>中央制御室は、放射性物質による室外からの放射線を遮蔽するためコンクリート構造を有している。</p> <p>炉心の著しい損傷が発生した場合には外気取り入れのための隔離ダンパを全閉とし、中央制御室可搬型陽圧化空調機により希ガス以外の放射性物質をろ過した空気にて中央制御室バウンダリ全体を陽圧化することで、重大事故等発生時に中央制御室内へのフィルタを介さない外気の流入を防止可能な設計とする。</p>	<p>2.4.3 中央制御室の居住性確保</p> <p>(1) 設計方針</p> <p>中央制御室は、放射性物質による中央制御室外からの放射線を遮蔽するためコンクリート構造を有している。通常時において、中央制御室換気系は、外気を一部取り入れる再循環方式により空気調整を行っているが、重大事故等時においては、外気取入れのための中央制御室換気系給排気隔離弁を全閉とし、中央制御室換気系を閉回路循環方式とすることで、フィルタを介さない外気の中央制御室内への流入を防止する設計とする。</p> <p>また、原子炉建屋ガス処理系により原子炉建屋原子炉棟内を負圧に維持するとともに、原子炉格納容器から原子炉建屋原子炉棟内に漏えいした放射性物質を含む気体を非常用ガス処理系排気筒から排気することで、運転員を過度の被ばくから防護する設計とする。</p>	<p>2.4.3 中央制御室の居住性確保</p> <p>(1) 設計方針</p> <p>中央制御室は、放射性物質による室外からの放射線を遮蔽するためコンクリート構造を有している。</p> <p>炉心の著しい損傷が発生した場合には、中央制御室換気系により希ガス以外の放射性物質を浄化した空気にて中央制御室バウンダリ全体を正圧化する加圧運転を行うことで、炉心の著しい損傷発生時に中央制御室内へのフィルタを介さない外気の流入を防止可能とするとともに、希ガスの大量放出が想定される格納容器フィルタベント実施時には外気取入れのための中央制御室換気系給排気隔離弁を全閉とし、中央制御室を系統隔離運転とすることで、中央制御室バウンダリを外気から隔離可能な設計とする。</p> <p>また、非常用ガス処理系により原子炉建物原子炉棟内を負圧に維持するとともに、原子炉格納容器から原子炉建物原子炉棟内に漏えいした放射性物質を含む気体を排気筒に沿わせて設ける排気管から排気することで、運転員を過度の被ばくから防護する設計とする。</p>	<p>備考</p> <p>・設備の相違 【柏崎 6, 7】 ②の相違 【東海第二】 島根 2号炉は系統隔離運転と加圧運転どちらも実施可能なように設備及び手順を整備する</p> <p>・記載方針の相違 【柏崎 6/7】 島根 2号炉は非常用ガス処理系について記載。 【東海第二】 島根 2号炉は非常用ガス処理系排気管の設置状況を詳細に記載</p>
<p style="text-align: right;">: SA範囲</p>	<p style="text-align: right;">: SA範囲</p>	<p style="text-align: right;">: SA範囲</p>	

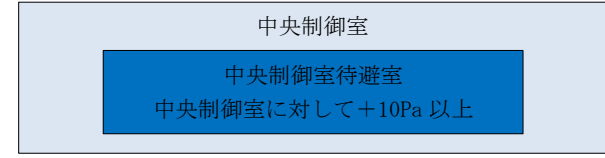
柏崎刈羽原子力発電所 6/7号炉 (2017.12.20)

中央制御室陽圧化バウンダリの出入口には二重扉構造の均圧室を設け、出入りに伴う中央制御室内への放射性物質の侵入を防止する。

炉心の著しい損傷が発生した場合の中央制御室の陽圧化装置の系統概要を図2.4-4に示す。



図2.4-4 中央制御室換気空調系（陽圧化装置）系統概要図（炉心の著しい損傷の発生時、プルーム通過前及びプルーム通過後）

: SA範囲

東海第二発電所 (2018.9.18版)

島根原子力発電所 2号炉

備考

炉心の著しい損傷が発生した場合の中央制御室換気系及び中央制御室待避室正圧化装置の系統概要を図2.4-5に示す。

・設備の相違
【柏崎6,7】
②の相違



図2.4-5 中央制御室換気系及び中央制御室待避室正圧化装置系統概要図（1/2）（炉心の著しい損傷の発生時、プルーム通過前及びプルーム通過後）





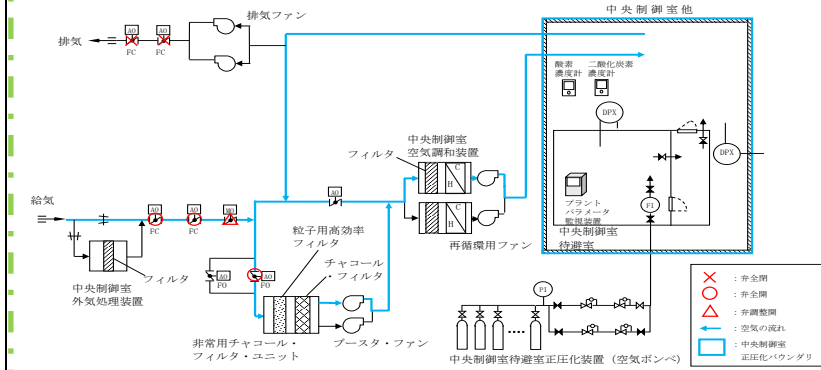

図2.4-5 中央制御室換気系及び中央制御室待避室正圧化装置系統概要図（2/2）（炉心の著しい損傷の発生時、プルーム通過中）

: SA範囲

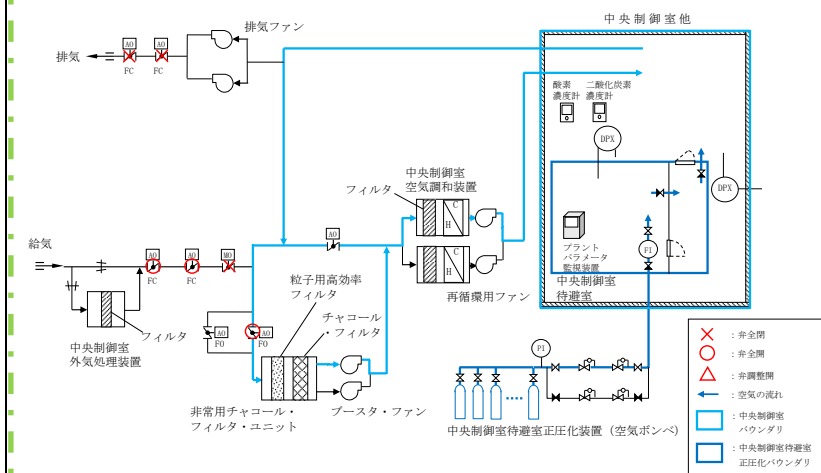
柏崎刈羽原子力発電所 6/7号炉 (2017.12.20)	東海第二発電所 (2018.9.18版)	島根原子力発電所 2号炉	備考
<p>(2) 遮蔽設備 中央制御室の遮蔽設備はコンクリート厚さ <input type="text"/> の建屋躯体と一体となった壁であり、放射性物質のガンマ線による外部被ばくを低減する設計としている。図2.4-5に中央制御室遮蔽位置を、また図2.4-6に中央制御室遮蔽の配置図を示す。</p> <div data-bbox="175 638 890 932" style="border: 1px solid black; height: 140px; width: 241px;"></div> <p style="text-align: center;">図 2.4-5 中央制御室遮蔽の概要 (NS 断面)</p> <div data-bbox="175 1094 890 1457" style="border: 1px solid black; height: 173px; width: 241px;"></div> <p style="text-align: center;">図 2.4-6 中央制御室の遮蔽 配置図</p>	<p>(2) 遮蔽設備 中央制御室の遮蔽設備は、コンクリート厚さ <input type="text"/> の建屋躯体と一体となった壁であり、放射性物質のガンマ線による外部被ばくを低減する設計とする。第2.4-1図に中央制御室遮蔽の配置図を示す。</p> <div data-bbox="940 579 1691 1323" style="border: 1px solid black; height: 354px; width: 253px;"></div> <p style="text-align: center;">第 2.4-1 図 中央制御室遮蔽 配置図</p>	<p>(2) 遮蔽設備 中央制御室の遮蔽設備は建物躯体と一体となった、コンクリート厚さ <input type="text"/> の壁、コンクリート厚さ <input type="text"/> の天井及びコンクリート厚さ <input type="text"/> の床であり、放射性物質のガンマ線による外部被ばくを低減する設計としている。図2.4-6に中央制御室遮蔽位置を、また、図2.4-7に中央制御室遮蔽及び中央制御室待避室遮蔽の配置図を示す。</p> <div data-bbox="1730 579 2481 953" style="border: 1px solid black; height: 178px; width: 253px;"></div> <p style="text-align: center;">図 2.4-6 中央制御室遮蔽の概要 (EW断面)</p> <div data-bbox="1718 1041 2487 1436" style="border: 1px solid black; height: 188px; width: 259px;"></div> <p style="text-align: center;">図 2.4-7 中央制御室遮蔽及び中央制御室待避室遮蔽 配置図</p>	
 : SA範囲	 : SA範囲	 : SA範囲	

柏崎刈羽原子力発電所 6/7号炉 (2017.12.20)	東海第二発電所 (2018.9.18版)	島根原子力発電所 2号炉	備考
<p>(3) 可搬型陽圧化空調機</p> <p>a. 設計風量</p> <p>可搬型陽圧化空調機の設計風量は、中央制御室を陽圧化する必要風量とし、JIS A 2201 送風機による住宅等の気密性能試験方法に基づく気密性能試験を実施し決定した。</p> <p>試験結果を図2.4-7に示す。3回の測定結果から求まる回歸曲線（通気特性式）より、中央制御室内を隣接区画+20Pa以上+40Pa未満の範囲内で陽圧化する必要風量は <input type="text"/> 未満となる。</p> <p>よって、設計風量は上記風量に設計裕度をもった4,500～6,000m³/h（6号炉側から1,125～1,500m³/h/台×2台、7号炉側から1,125～1,500m³/h/台×2台とする。）</p> <div data-bbox="207 1039 863 1411" style="border: 1px solid black; height: 177px; width: 221px; margin: 10px 0;"></div> <p style="text-align: center;">図 2.4-7 中央制御室の気密性能試験結果</p>	<p>(3) 中央制御室換気系</p> <p>中央制御室換気系の系統概要図を、第2.4-2図に示す。</p> <p>重大事故等時において、中央制御室換気系は、高性能粒子フィルタ及びチャコールフィルタを内蔵した中央制御室換気系フィルタユニット並びに中央制御室換気系フィルタ系ファンからなる非常用ラインを設け、外気との連絡口を遮断し、中央制御室換気系フィルタユニットを通る閉回路循環方式とし、運転員を過度の被ばくから防護する設計とする。なお、外気との遮断は、中央制御室換気系給気隔離弁4個及び中央制御室換気系排気隔離弁2個の合計6個により行い、全交流動力電源喪失時にも常設代替交流電源設備である常設代替高圧電源装置からの給電により、中央制御室からスイッチによる操作で弁の閉操作が可能な設計とする。また、中央制御室排煙装置との隔離は、中央制御室換気系排煙装置隔離弁3個により行い、全交流動力電源喪失時にも常設代替交流電源設備である常設代替高圧電源装置からの給電が可能な設計とする。</p> <p>中央制御室換気系は、外気との遮断が長期にわたり、室内の環境条件が悪化した場合には、外気を中央制御室換気系フィルタユニットで浄化しながら取り入れることも可能な設計とする。なお、中央制御室換気系については、常設代替交流電源設備である常設代替高圧電源装置から受電するまでの間は起動しないが、居住性に係る被ばく評価においては、全交流動力電源喪失後、2時間後に起動することを条件として評価しており、居住性を確保できることを確認している。</p> <div data-bbox="1469 1795 1703 1858" style="border: 1px dashed green; width: 79px; height: 30px; margin: 10px 0;"></div> <p style="text-align: center;">: SA範囲</p>	<p>(3) 中央制御室換気系</p> <p>a. 設計風量</p> <p>中央制御室バウンダリ全体を正圧化するために必要となる空気供給量は、中央制御室換気系差圧試験にて測定し決定する。また大気間差圧は、大気基準点と中央制御室バウンダリ内各測定点での気圧を気圧計にて同時測定を行った。計測値は、大気圧基準点高さに補正算出した。</p> <p>試験結果を図2.4-8に示す。中央制御室内を外気より+20Pa以上で正圧化する必要風量は <input type="text"/> m³/h以上となる。よって、必要な空気供給量は上記風量に設計裕度をもった17,500m³/hとする</p> <div data-bbox="1745 871 2484 1543" style="border: 1px solid black; height: 320px; width: 249px; margin: 10px 0;"></div> <p style="text-align: center;">図 2.4-8 中央制御室の気密性能試験結果</p> <div data-bbox="2249 1795 2484 1858" style="border: 1px dashed green; width: 79px; height: 30px; margin: 10px 0;"></div> <p style="text-align: center;">: SA範囲</p>	<p>備考</p> <ul style="list-style-type: none"> ・資料構成の相違 【東海第二】 島根2号炉は設計風量について記載。東海第二が記載している設備概要については、「59条原子炉制御室3.16.2.2.1設備概要(1)遮蔽及び換気設備」に記載。 ・設計条件の相違 【柏崎6,7】 ②の相違

柏崎刈羽原子力発電所 6/7号炉 (2017.12.20)	東海第二発電所 (2018.9.18版)	島根原子力発電所 2号炉	備考																															
<p>上記設計風量を満足する、可搬型陽圧化空調機の定格風量及び設置台数、場所について表2.4-1に示す。</p> <p>表2.4-1 可搬型陽圧化空調機の仕様、及び台数</p> <table border="1" data-bbox="172 457 872 613"> <thead> <tr> <th>項目</th> <th>仕様等</th> </tr> </thead> <tbody> <tr> <td>定格風量及び設置台数</td> <td>1,500 m³/h/台×4台 (予備2台) (6号及び7号炉共用)</td> </tr> <tr> <td>設置場所</td> <td>コントロール棟屋地上1階 6号炉側及び7号炉側</td> </tr> </tbody> </table> <p>b. 可搬型陽圧化空調機のフィルタ性能</p> <p>可搬型陽圧化空調機の高性能フィルタ及び活性炭フィルタの捕集効率を表2.4-2に示す。活性炭フィルタは乾燥剤を封入した密閉容器に保管することで、通常時の捕集性能劣化を防止する設計とする。</p> <p>表2.4-2 可搬型陽圧化空調機のフィルタ捕集効率</p> <table border="1" data-bbox="148 1096 896 1251"> <thead> <tr> <th>種類</th> <th>総合除去効率(%)</th> </tr> </thead> <tbody> <tr> <td>高性能フィルタ</td> <td>99.9(0.3 μm PAO 粒子)</td> </tr> <tr> <td>活性炭フィルタ</td> <td>99.9(相対湿度 85%以下)</td> </tr> </tbody> </table> <p>c. 機器構成</p> <p>可搬型陽圧化空調機の機器概要図を図2.4-8に、可搬型陽圧化空調機の設置及び保管エリアを図2.4-9に示す。可搬型陽圧化空調機はプロワ及び中性能フィルタ、高性能フィルタ、活性炭フィルタから構成し、6号炉及び7号炉中央制御室にフィルタにより浄化した外気を供給することで中央制御室陽圧化バウンダリ全体を陽圧化可能な設計とする。</p> <p style="text-align: right;">: SA 範囲</p>	項目	仕様等	定格風量及び設置台数	1,500 m ³ /h/台×4台 (予備2台) (6号及び7号炉共用)	設置場所	コントロール棟屋地上1階 6号炉側及び7号炉側	種類	総合除去効率(%)	高性能フィルタ	99.9(0.3 μm PAO 粒子)	活性炭フィルタ	99.9(相対湿度 85%以下)	<p>【設備仕様】</p> <ul style="list-style-type: none"> 中央制御室換気系空気調和機ファン <ul style="list-style-type: none"> 台数 1 (予備1) 容量 約42,500m³/h (1台当たり) 中央制御室換気系フィルタ系ファン <ul style="list-style-type: none"> 台数 1 (予備1) 容量 約5,100m³/h (1台当たり) <p>・中央制御室換気系フィルタユニット</p> <p>型式 高性能粒子フィルタ及びチャコールフィルタ内蔵型</p> <p>基数 1 (予備1)</p> <p>粒子除去効率 99.97%以上 (直径0.5 μm以上の粒子)</p> <p>よう素除去効率 (総合除去効率) 97%以上</p> <p style="text-align: right;">: SA 範囲</p>	<p>中央制御室換気系の容量、設置台数及び設置場所について表2.4-1に示す。</p> <p>表2.4-1 中央制御室換気系の仕様及び台数</p> <table border="1" data-bbox="1727 415 2487 735"> <thead> <tr> <th>設備</th> <th>項目</th> <th>仕様等</th> </tr> </thead> <tbody> <tr> <td rowspan="2">再循環用ファン</td> <td>容量及び設置台数</td> <td>120,000m³/h/台×1台 (予備1台)</td> </tr> <tr> <td>設置場所</td> <td>廃棄物処理建物2階</td> </tr> <tr> <td rowspan="2">チャコール・フィルタ・ブースタ・ファン</td> <td>容量及び設置台数</td> <td>32,000m³/h/台×1台 (予備1台)</td> </tr> <tr> <td>設置場所</td> <td>廃棄物処理建物2階</td> </tr> </tbody> </table> <p>b. 中央制御室換気系のフィルタ性能</p> <p>中央制御室換気系の粒子用高効率フィルタ及びチャコール・フィルタの除去効率を表2.4-2に示す。</p> <p>表2.4-2 中央制御室換気系のフィルタ除去効率</p> <table border="1" data-bbox="1727 1050 2487 1188"> <thead> <tr> <th>種類</th> <th>総合除去効率 (%)</th> </tr> </thead> <tbody> <tr> <td>粒子用高効率フィルタ</td> <td>99.9 (0.3 μm 粒子*1)</td> </tr> <tr> <td>チャコール・フィルタ</td> <td>95 (相対湿度 70%以下*2)</td> </tr> </tbody> </table> <p>※1: 日本工業規格 JIS Z 4812-1975 「放射性エアロゾル用高性能エアフィルタ HEPA Filters for Radioactive Aerosols」に基づき設定</p> <p>※2: 非常用チャコール・フィルタ・ユニット入口の空気条件に基づき設定</p> <p>c. 機器構成</p> <p>中央制御室換気系の機器概要図を図2.4-9に、中央制御室換気系の設置エリアを図2.4-10に示す。中央制御室換気系は再循環用ファン、チャコール・フィルタ・ブースタ・ファン及び非常用チャコール・フィルタ・ユニット (粒子用高効率フィルタ及びチャコール・フィルタ) 等から構成し、中央制御室にフィルタにより浄化された空気を供給することで中央制御室バウンダリ全体を正圧化可能な設計とする。</p> <p style="text-align: right;">: SA 範囲</p>	設備	項目	仕様等	再循環用ファン	容量及び設置台数	120,000m ³ /h/台×1台 (予備1台)	設置場所	廃棄物処理建物2階	チャコール・フィルタ・ブースタ・ファン	容量及び設置台数	32,000m ³ /h/台×1台 (予備1台)	設置場所	廃棄物処理建物2階	種類	総合除去効率 (%)	粒子用高効率フィルタ	99.9 (0.3 μm 粒子*1)	チャコール・フィルタ	95 (相対湿度 70%以下*2)	<p>備考</p> <ul style="list-style-type: none"> 設備の相違【柏崎6,7】②の相違 設備の相違【柏崎6/7,東海第二】 設備の相違【柏崎6/7】②の相違 設備の相違【柏崎6/7,東海第二】 記載方針の相違【柏崎6/7,東海第二】島根2号炉は設計条件を記載 記載方針の相違【東海第二】島根2号炉は機器構成を記載。 設備の相違【柏崎6,7】②の相違 申請号炉数の相違【柏崎6/7】
項目	仕様等																																	
定格風量及び設置台数	1,500 m ³ /h/台×4台 (予備2台) (6号及び7号炉共用)																																	
設置場所	コントロール棟屋地上1階 6号炉側及び7号炉側																																	
種類	総合除去効率(%)																																	
高性能フィルタ	99.9(0.3 μm PAO 粒子)																																	
活性炭フィルタ	99.9(相対湿度 85%以下)																																	
設備	項目	仕様等																																
再循環用ファン	容量及び設置台数	120,000m ³ /h/台×1台 (予備1台)																																
	設置場所	廃棄物処理建物2階																																
チャコール・フィルタ・ブースタ・ファン	容量及び設置台数	32,000m ³ /h/台×1台 (予備1台)																																
	設置場所	廃棄物処理建物2階																																
種類	総合除去効率 (%)																																	
粒子用高効率フィルタ	99.9 (0.3 μm 粒子*1)																																	
チャコール・フィルタ	95 (相対湿度 70%以下*2)																																	

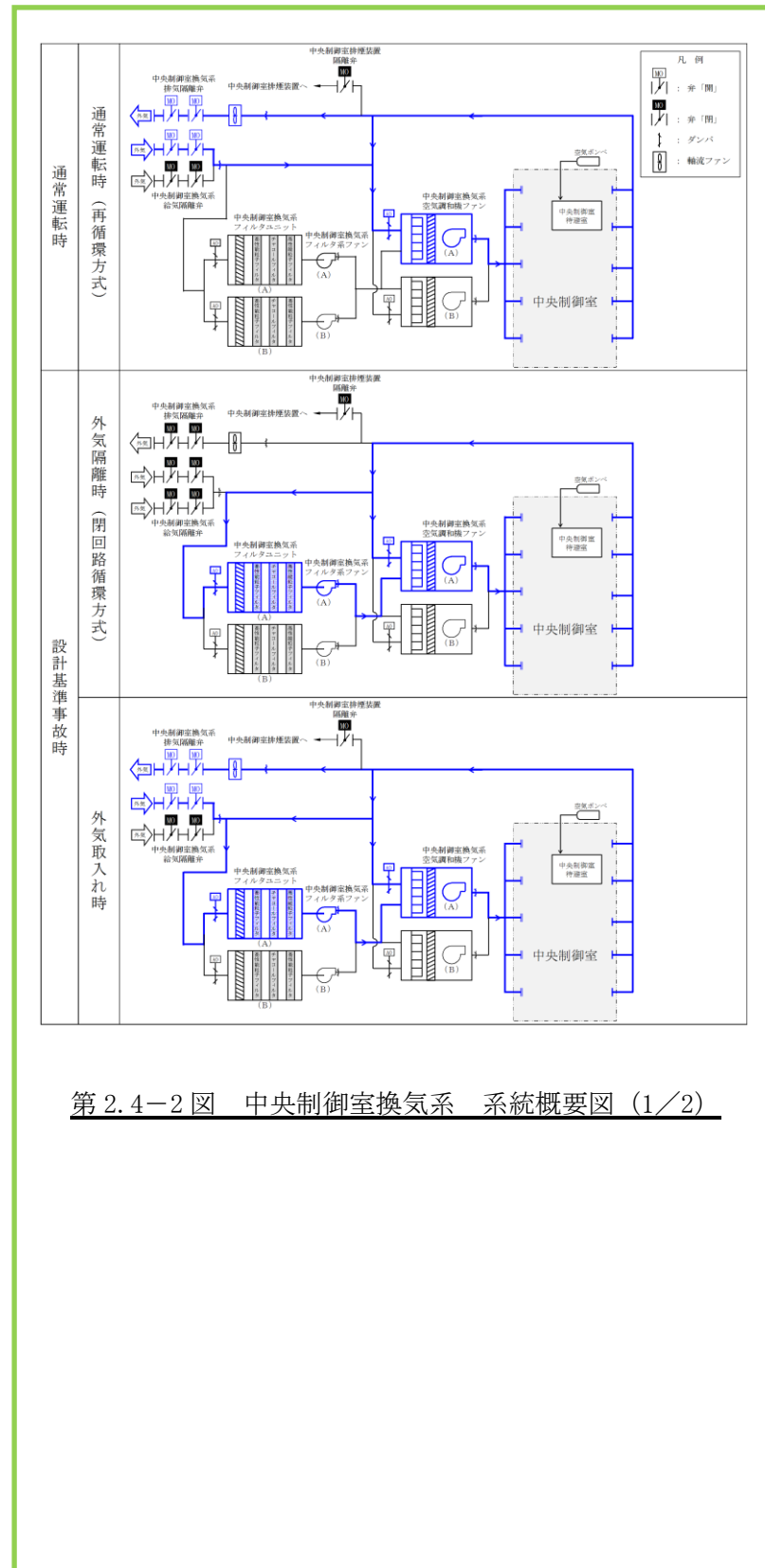

第 2.4-2 図 中央制御室換気系 系統概要図 (1/2)

: DB 範囲

・構成の相違
【東海第二】
 島根 2号炉は中央制御室換気系を SA で使用するときの系統概要図を示している。



図 2.4-8 可搬型陽圧化空調機 機器概要図



図 2.4-9 可搬型陽圧化空調機の設置エリア

: SA範囲

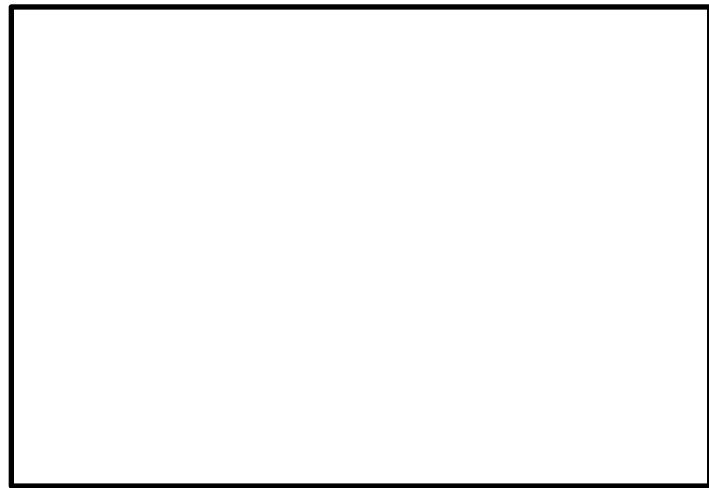

第 2.4-2 図 中央制御室換気系 系統概要図 (2/2)

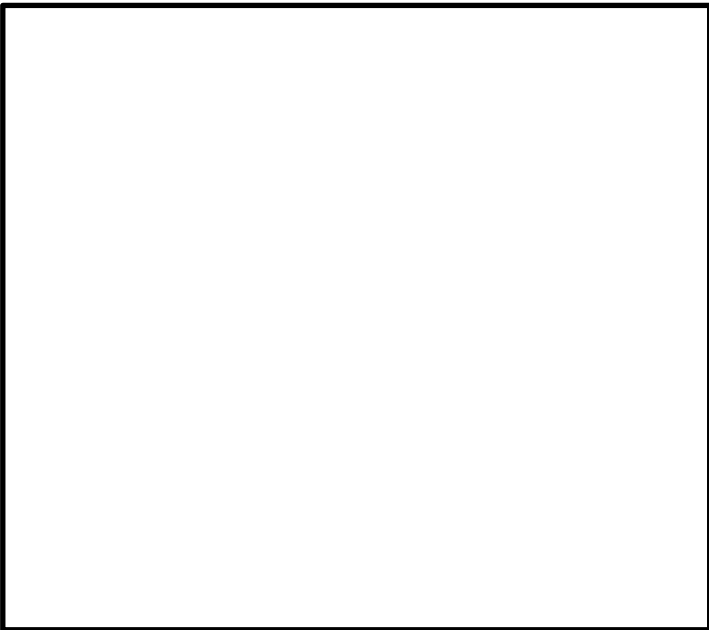
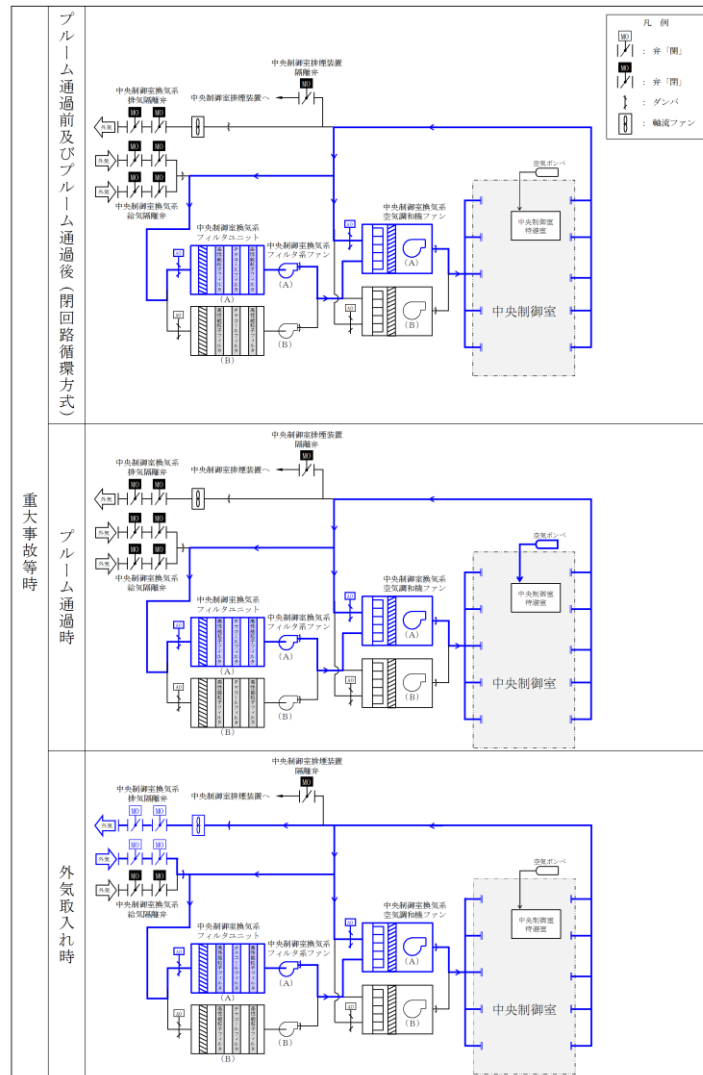
: SA範囲



図 2.4-9 中央制御室換気系 機器概要図



図 2.4-10 中央制御室換気系の設置エリア

: SA範囲

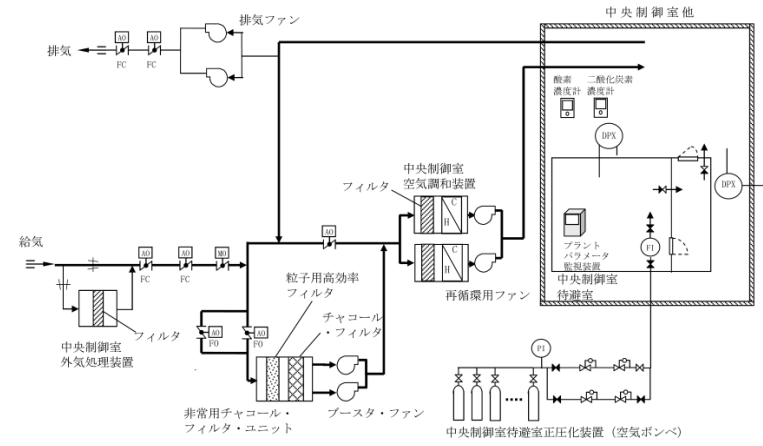
柏崎刈羽原子力発電所 6/7号炉 (2017.12.20)	東海第二発電所 (2018.9.18版)	島根原子力発電所 2号炉	備考
<p><u>6号炉及び7号炉中央制御室を構成する、各号炉の上部中央制御室エリア(コントロール建屋 2F T.M.S.L.+17.3m)と下部中央制御室エリア(コントロール建屋 1F T.M.S.L.+12.3m)とは、各号炉の中央制御室換気空調系ダクトにて接続された設計とする。そのため6号炉及び7号炉中央制御室それぞれにフィルタにより浄化した外気を供給することで、上部中央制御室エリア、下部中央制御室エリアの中央制御室陽圧化バウンダリ全体を陽圧化することができる設計とする。</u></p> <p>(4) <u>中央制御室換気空調系隔離ダンパ</u> 炉心の著しい損傷が発生した場合において、中央制御室を陽圧化するために閉操作する中央制御室換気空調系隔離ダンパの系統概要図を図2.4-10に示す。操作対象の隔離ダンパは、6号炉及び7号炉各々に給気側4弁、排気側2弁の合計12弁あり、全交流動力電源喪失時においても、手動でダンパ閉操作可能な構造となっている。</p> <p><u>中央制御室換気空調系隔離ダンパの配置図を図2.4-11(7号炉)、図2.4-12(6号炉)に示す。隔離ダンパ閉操作は、中央制御室の隣の6号機中央制御室送・排風機室及び7号機中央制御室送・排風機室で実施するためアクセス性に問題はなく、隔離ダンパ閉操作もハンドルを閉側に回す作業のみであり、各号炉運転員2名により30分程度で実施可能な見込みである。</u></p>		<p>d. <u>中央制御室換気系加圧運転操作に係る弁</u> <u>炉心の著しい損傷が発生した場合において、中央制御室バウンダリ全体を正圧化するために操作する弁の系統概要図を図2.4-11に示す。操作対象の弁は、中央制御室外気取入調節弁1弁、中央制御室給気隔離弁2弁あり、全交流動力電源喪失時においても、手動で弁操作可能な構造となっている。</u></p> <p><u>中央制御室換気系弁の配置図を図2.4-12に示す。中央制御室給気隔離弁操作は、廃棄物処理建物2階の非常用チャコール・フィルタ・ユニット室で実施するためアクセス性に問題はなく、開操作もハンドルを開側に回す作業のみであり、現場運転員2名により実施可能な見込みである。また中央制御室外気取入調節弁の操作は、中央制御室制御盤で実施するためアクセス性に問題はなく、中央制御室運転員1名により実施可能な見込みである。</u></p> <p><u>したがって上記の操作は、現場運転員2名及び中央制御室運転員1名にて40分程度で実施可能な見込みである。</u></p>	<p>・設備の相違 【柏崎6/7】 島根2号炉に下部中央制御室はない</p> <p>・記載方針の相違 【東海第二】 島根2号炉は操作ダンパについて記載。</p> <p>・申請号炉数の相違 【柏崎6/7】</p> <p>・設備の相違 【柏崎6/7】 設備構成が異なるため、操作時間等も異なる。</p>
 : SA範囲		 : SA範囲	

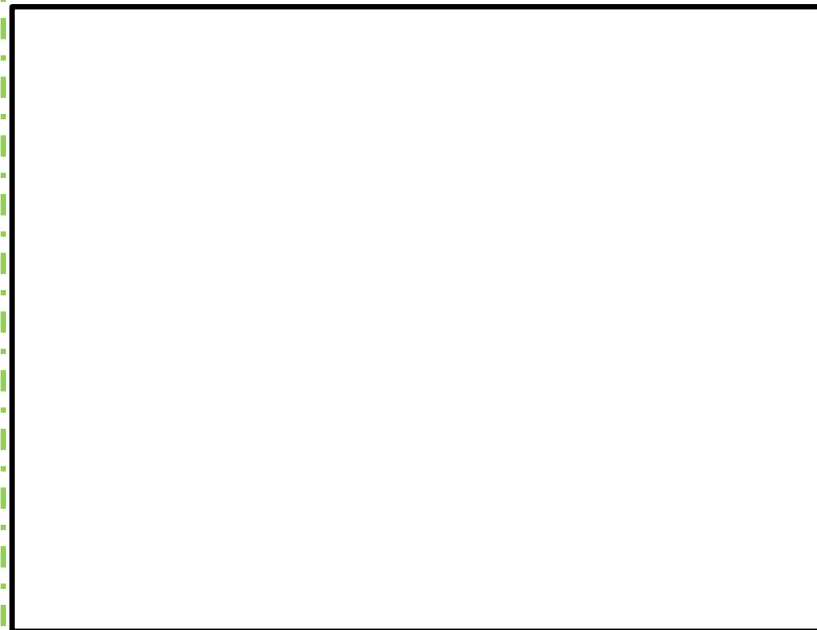

図 2.4-10 中央制御室換気空調系隔離ダンパ 系統概略図



図 2.4-11 中央制御室換気空調系隔離ダンパ 配置図 (7号炉)

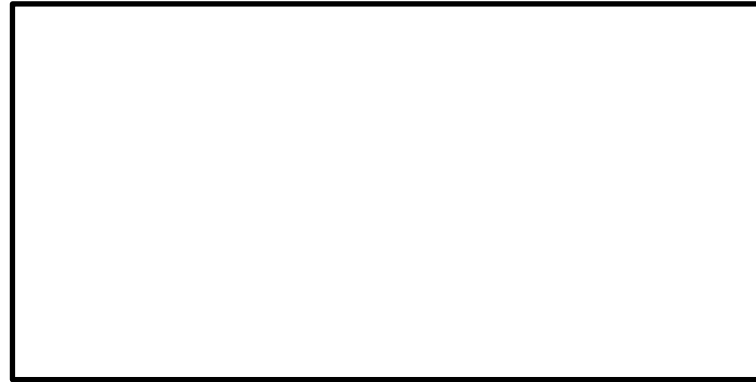

図 2.4-12 中央制御室換気空調系隔離ダンパ 配置図 (6号炉)

: SA範囲



図 2.4-11 中央制御室換気系弁 系統概要図

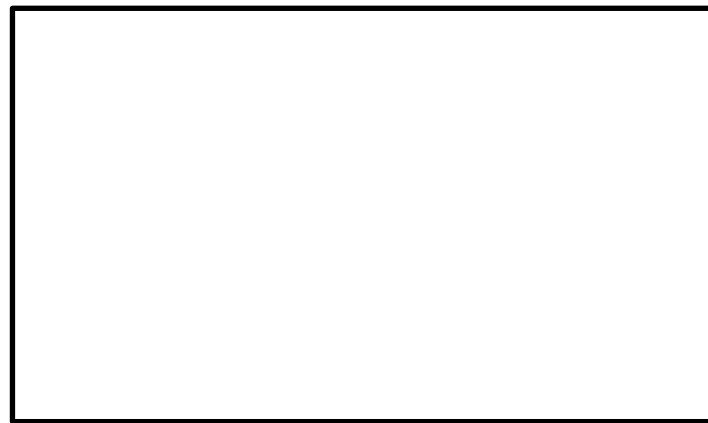

図2.4-12 中央制御室換気系弁 配置図
(原子炉建物地上2階及び地上4階)

: SA範囲

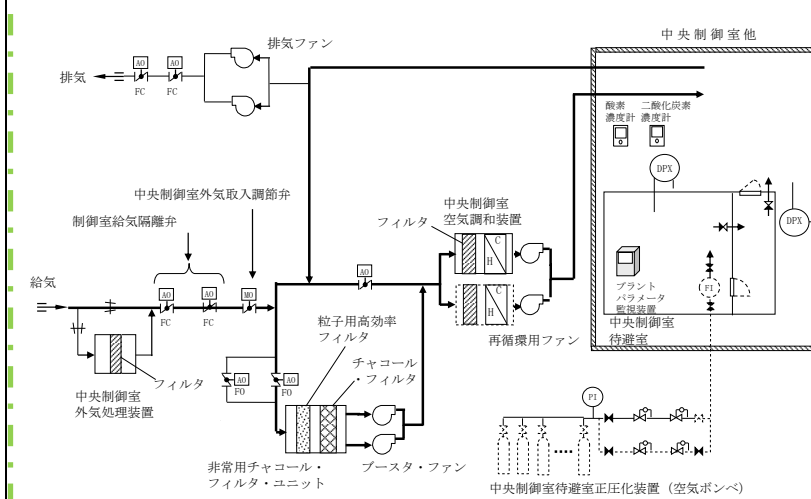
・申請号炉数の相違
【柏崎 6/7】

柏崎刈羽原子力発電所 6 / 7号炉 (2017.12.20)	東海第二発電所 (2018.9.18版)	島根原子力発電所 2号炉	備考
	<p>(4) <u>原子炉建屋ガス処理系</u></p> <p>原子炉建屋ガス処理系は、炉心の著しい損傷が発生した場合においても、原子炉格納容器から漏えいする放射性物質による運転員の被ばくを低減するために設置している。</p> <p>原子炉建屋ガス処理系は、<u>非常用ガス処理系排風機</u>、<u>非常用ガス再循環系排風機</u>、<u>非常用ガス処理系フィルタトレイン</u>、<u>非常用ガス再循環系フィルタトレイン</u>、配管・弁類、計測制御装置等で構成する。</p> <p>原子炉建屋ガス処理系の概要図を第2.4-3図に示す。</p> <p>原子炉建屋ガス処理系は、<u>非常用ガス処理系排風機</u>により原子炉建屋原子炉棟内を負圧に維持するとともに、原子炉格納容器から原子炉建屋原子炉棟内に漏えいした放射性物質を含む気体を<u>非常用ガス処理系排気筒</u>から排気することで、中央制御室の運転員の被ばくを低減する設計とする。</p> <p><u>非常用ガス処理系排風機及び非常用ガス再循環系排風機</u>は、非常用交流電源設備である非常用ディーゼル発電機に加えて、常設代替交流電源設備である常設代替高圧電源装置からの給電が可能な設計とする。</p> <p>また、重大事故等時において、炉心の著しい損傷が発生し、<u>原子炉建屋ガス処理系</u>を起動する際に、<u>ブローアウトパネル</u>を閉止する必要がある場合には、<u>ブローアウトパネル閉止装置</u>を電動で閉操作し、<u>ブローアウトパネル開口部</u>を閉止することで、<u>原子炉建屋原子炉棟</u>の放射性物質の閉じ込め機能を維持し、中央制御室にとどまる運転員を過度の被ばくから防護する設計とする。なお、ブローアウトパネル閉止装置は、人力での閉操作も可能な設計とする。</p> <p>ブローアウトパネル閉止装置は、常設代替交流電源設備である常設代替高圧電源装置から給電が可能な設計とする。</p> <p style="text-align: right;">: SA範囲</p>	<p>(4) <u>非常用ガス処理系及び原子炉建物ブローアウトパネル閉止装置</u></p> <p>非常用ガス処理系は、炉心の著しい損傷が発生した場合においても、原子炉格納容器から漏えいする放射性物質による運転員の被ばくを低減するために設置している。</p> <p>非常用ガス処理系は、<u>非常用ガス処理系排気ファン</u>、<u>前置ガス処理装置</u>、<u>後置ガス処理装置</u>、配管・弁類、計測制御装置等で構成する。</p> <p>非常用ガス処理系の概要図を図2.4-13に示す。</p> <p>非常用ガス処理系は、<u>非常用ガス処理系排気ファン</u>により原子炉建物原子炉棟内を負圧に維持するとともに、原子炉格納容器から原子炉建物原子炉棟内に漏えいした放射性物質を含む気体を<u>排気筒</u>に沿わせて設ける<u>排気管</u>から排気することで、中央制御室の運転員の被ばくを低減する設計とする。</p> <p><u>非常用ガス処理系排気ファン</u>は、非常用交流電源設備である非常用ディーゼル発電機に加えて、常設代替交流電源設備である<u>ガスタービン発電機</u>からの給電が可能な設計とする。</p> <p>また、重大事故等時において、炉心の著しい損傷が発生し、<u>非常用ガス処理系</u>を起動する際に、<u>原子炉建物燃料取替階ブローアウトパネル閉止装置</u>（以下、「ブローアウトパネル閉止装置」という。）を電動で閉操作することで、<u>原子炉建物原子炉棟</u>の放射性物質の閉じ込め機能を維持し、中央制御室にとどまる運転員を過度の被ばくから防護する設計とする。なお、ブローアウトパネル閉止装置は、人力での閉操作も可能な設計とする。</p> <p>ブローアウトパネル閉止装置は、常設代替交流電源設備である<u>ガスタービン発電機</u>から給電が可能な設計とする。</p> <p style="text-align: right;">: SA範囲</p>	<p>・設備の相違 【柏崎6/7】 島根2号炉は非常用ガス処理系及びブローアウトパネル閉止装置により原子炉格納容器から漏えいする空気中の放射性物質の濃度を低減することを記載</p> <p>・設備の相違 【東海第二】 島根2号炉に非常用ガス再循環系に該当する設備はない</p> <p>・記載方針の相違 【東海第二】 島根2号炉は非常用ガス処理系排気管の設置状況を詳細に記載</p> <p>・操作判断基準の相違 【東海第二】 島根2号炉の原子炉建物燃料取替階ブローアウトパネル閉止装置の閉止操作は次の条件が全て成立した場合。 ○原子炉冷却材圧力バウンダリが破損した状況において、漏えい箇所の隔離及び原子炉圧力容器の減圧が完了していること ○非常用ガス処理系が運転中又は起動操作が</p>

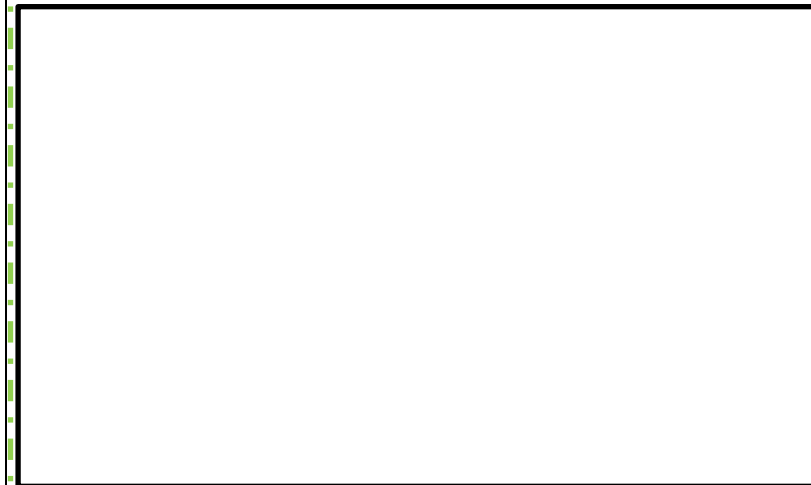
柏崎刈羽原子力発電所 6 / 7号炉 (2017.12.20)	東海第二発電所 (2018.9.18版)	島根原子力発電所 2号炉	備考																						
	<p>【設備仕様】</p> <ul style="list-style-type: none"> ・非常用ガス処理系排風機 <table border="1" data-bbox="982 485 1433 611"> <tr><td>種 類</td><td>遠心型</td></tr> <tr><td>容 量</td><td>3,570m³/h</td></tr> <tr><td>台 数</td><td>1 (予備1)</td></tr> </table> ・非常用ガス再循環系排風機 <table border="1" data-bbox="982 842 1448 968"> <tr><td>種 類</td><td>遠心型</td></tr> <tr><td>容 量</td><td>17,000m³/h</td></tr> <tr><td>台 数</td><td>1 (予備1)</td></tr> </table> ・ブローアウトパネル閉止装置 <table border="1" data-bbox="1032 1066 1314 1104"> <tr><td>個 数</td><td>10</td></tr> </table> <p style="text-align: center;">○ : SA範囲</p>	種 類	遠心型	容 量	3,570m ³ /h	台 数	1 (予備1)	種 類	遠心型	容 量	17,000m ³ /h	台 数	1 (予備1)	個 数	10	<p>【設備仕様】</p> <ul style="list-style-type: none"> ・非常用ガス処理系排気ファン <table border="1" data-bbox="1849 485 2190 611"> <tr><td>種類</td><td>遠心型</td></tr> <tr><td>容量</td><td>4,400m³/h/台</td></tr> <tr><td>台数</td><td>1 (予備1)</td></tr> </table> ・原子炉建物燃料取替階ブローアウトパネル閉止装置 <table border="1" data-bbox="1849 1066 2027 1104"> <tr><td>個数</td><td>2</td></tr> </table> <p style="text-align: center;">○ : SA範囲</p>	種類	遠心型	容量	4,400m ³ /h/台	台数	1 (予備1)	個数	2	<p>必要な状況であること</p> <p>○当直副長が炉心損傷を判断していること</p> <ul style="list-style-type: none"> ・設備の相違 <p>【柏崎6/7】</p> <p>島根2号炉は非常用ガス処理系及びブローアウトパネル閉止装置により原子炉格納容器から漏えいする空気中の放射性物質の濃度を低減するため記載</p> <ul style="list-style-type: none"> ・設備の相違 <p>【東海第二】</p> <p>島根2号炉に非常用ガス再循環系に該当する設備はない</p> <ul style="list-style-type: none"> ・設備の相違 <p>【柏崎6/7】</p> <p>③の相違</p>
種 類	遠心型																								
容 量	3,570m ³ /h																								
台 数	1 (予備1)																								
種 類	遠心型																								
容 量	17,000m ³ /h																								
台 数	1 (予備1)																								
個 数	10																								
種類	遠心型																								
容量	4,400m ³ /h/台																								
台数	1 (予備1)																								
個数	2																								

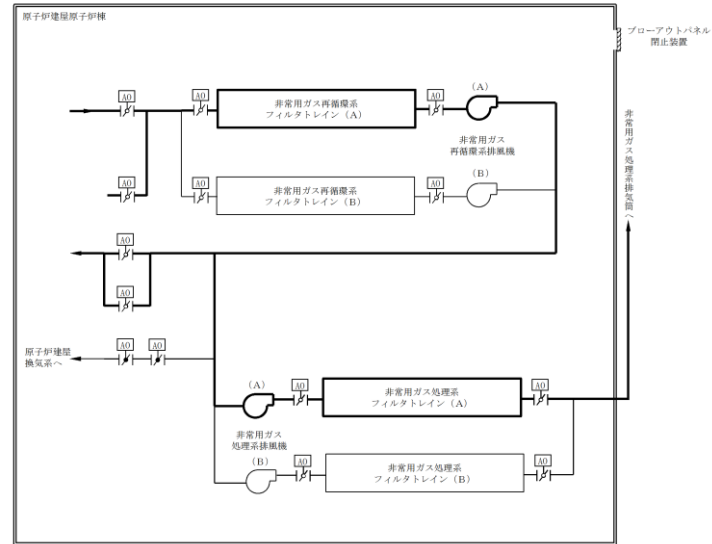

第 2.4-3 図 原子炉建屋ガス処理系 系統概要図



図 2.4-13 非常用ガス処理系 系統概要図

・設備の相違
【柏崎 6/7, 東海第二】

: SA 範囲

: SA 範囲

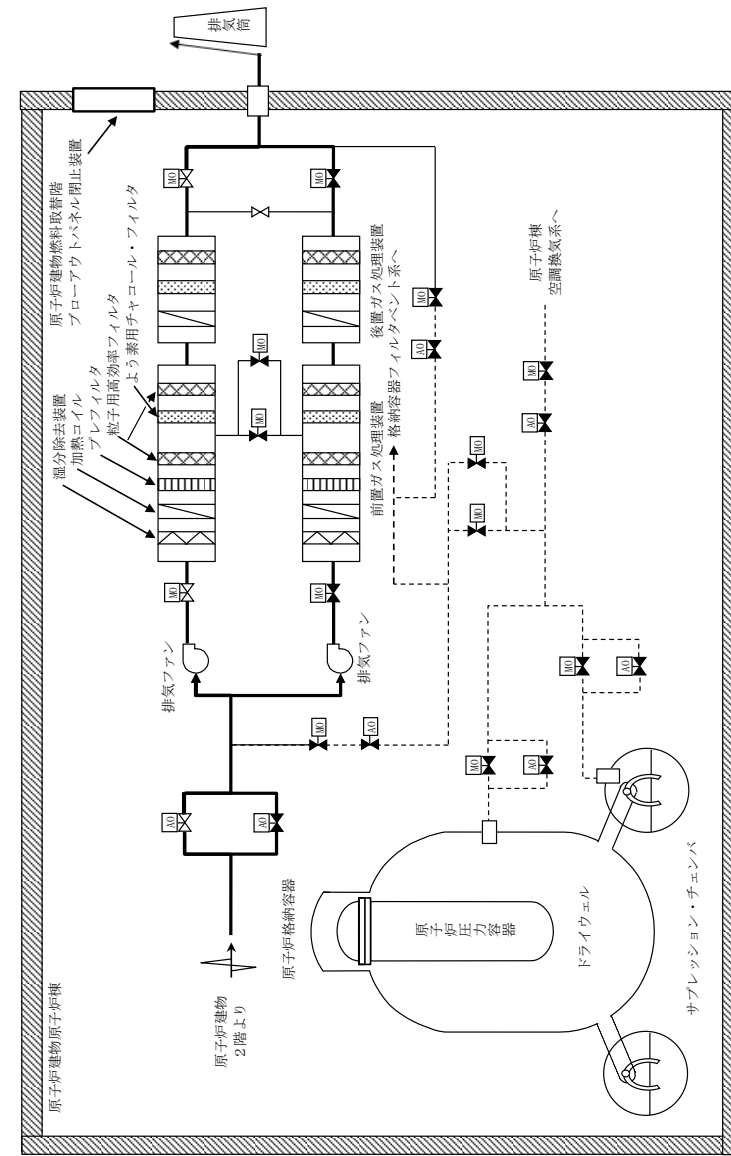
柏崎刈羽原子力発電所 6 / 7号炉 (2017.12.20)	東海第二発電所 (2018.9.18版)	島根原子力発電所 2号炉	備考
<p>2.4.4 中央制御室待避室の居住性確保</p> <p>(1) 設計方針</p> <p>炉心の著しい損傷の発生時に格納容器圧力逃がし装置を作動させる場合においては、中央制御室待避室を陽圧化装置により陽圧化するとともに、中央制御室を可搬型陽圧化空調機により陽圧化する設計とする。これにより、中央制御室バウンダリ内への希ガスを除く放射性物質の流入を低減できる設計とすることで、待避室にとどまる間、中央制御室内に取り込んだ放射性物質からの直接線影響の低減を図るとともに、待避室から中央制御室バウンダリへ出る場合において、マスクを着用しなくても放射性物質の体内への取込みを低減可能な設計とする。</p> <p>中央制御室待避室はコンクリート壁又は鉛等により遮蔽性能を高めた設計とする。また中央制御室待避室は気密性を高めた設計とするとともに、陽圧化装置により中央制御室待避室を陽圧化し、中央制御室待避室内への外気流入を一定時間完全に遮断することで居住性を高めた設計とする。陽圧化装置は、自主対策設備として、屋外から可搬型のカードル式空気ポンプユニットを接続することで、空気ポンプ容量を追加可能な設計とする。</p> <p>ここで、陽圧化の差圧は、中央制御室とコントロール建屋、中央制御室待避室とコントロール建屋の差圧を差圧計により、2.4.2項に示す陽圧化設計圧力値を監視することとし、コントロール建屋と中央制御室との間、及び中央制御室と中央制御室待避室との間の差圧は均圧室の扉を閉めることにより確保する設計とする。</p> <p>なお、中央制御室待避室の陽圧化装置の系統概要を図2.4-13に、カードル式空気ポンプユニットの配置図を図2.4-14に示す。</p>	<p>2.4.4 中央制御室待避室の居住性確保</p> <p>(1) 設計方針</p> <p>中央制御室待避室は、鉛又はコンクリート壁等により遮蔽性能を高めた設計とする。また、中央制御室待避室は、気密性を高めた設計とするとともに、中央制御室待避室空気ポンプユニット(空気ポンプ)により中央制御室待避室を正圧化し、中央制御室待避室内への外気流入を防止することで居住性を高めた設計とする。</p> <p>重大事故発生後に格納容器圧力逃がし装置を作動させる場合においては、中央制御室待避室を中央制御室待避室空気ポンプユニット(空気ポンプ)により正圧化することで、放射性物質の中央制御室待避室内への流入を防ぎ、中央制御室にとどまる運転員の被ばくを低減する設計とする。また、2.4.2項に示す中央制御室待避室正圧化の設計差圧であることを確認するため、中央制御室待避室差圧計を設置する。</p>	<p>2.4.4 中央制御室待避室の居住性確保</p> <p>(1) 設計方針</p> <p>炉心の著しい損傷発生時に格納容器フィルタベント系を作動させる場合においては、中央制御室待避室を空気ポンベにより正圧化するとともに、中央制御室を中央制御室換気系により正圧化することで、中央制御室の遮蔽内への希ガスを除く放射性物質を低減し、中央制御室待避室での滞在中に中央制御室に取り込んだ放射性物質からの直接線影響の低減、及び放射性物質の体内への取り込みを低減可能な設計とする。</p> <p>中央制御室待避室は鉛等により遮蔽性能を高めた設計とする。また、中央制御室待避室は気密性を高めた設計とするとともに、中央制御室待避室正圧化装置により中央制御室待避室を正圧化し、中央制御室待避室内への外気流入を防止することで居住性を高めた設計とする。</p> <p>ここで、正圧化の差圧は、中央制御室と外気、中央制御室待避室と中央制御室の差圧を差圧計により、2.4.2項に示す正圧化設計圧力値を監視することとし、外気と中央制御室との間、及び中央制御室と中央制御室待避室との間の差圧は扉を閉めることにより確保する。</p> <p>なお、中央制御室換気系及び中央制御室待避室正圧化装置の概要を図2.4-14に示す。</p>	<p>備考</p> <ul style="list-style-type: none"> ・設備の相違 【柏崎 6/7, 東海第二】 島根 2号炉は鉛等により十分な遮蔽を確保する(以下⑤の相違) ・運用の相違 【柏崎 6/7】 島根 2号炉は待避室から中央制御室に出る場合はマスクを着用する ・設備の相違 【柏崎 6/7】 島根 2号炉は SA 設備である中央制御室待避室空気ポンベで十分なポンベ容量を確保している(以下、⑥の相違) ・設備の相違 【柏崎 6/7】 島根 2号炉では中央制御室との差圧を監視する ・設備の相違 【柏崎 6/7】 ⑥の相違
<p style="text-align: center;">: SA 範囲</p>	<p style="text-align: center;">: SA 範囲</p>	<p style="text-align: center;">: SA 範囲</p>	



図 2.4-13 中央制御室換気設備の系統概要図 (重大事故発生時, プルーム通過中)



図 2.4-14 カードル式空気ポンベユニット配置場所

: SA 範囲

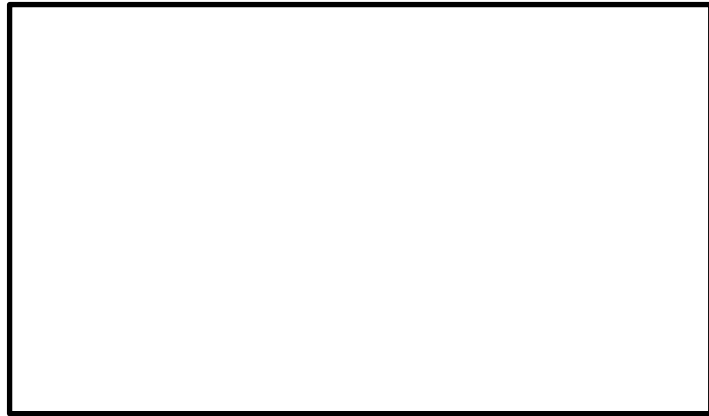

図 2.4-14 中央制御室換気系及び中央制御室待避室正圧化装置の概要図

: SA 範囲

・設備の相違
【柏崎 6/7】
⑥の相違

(2) 収容人数及び設置場所

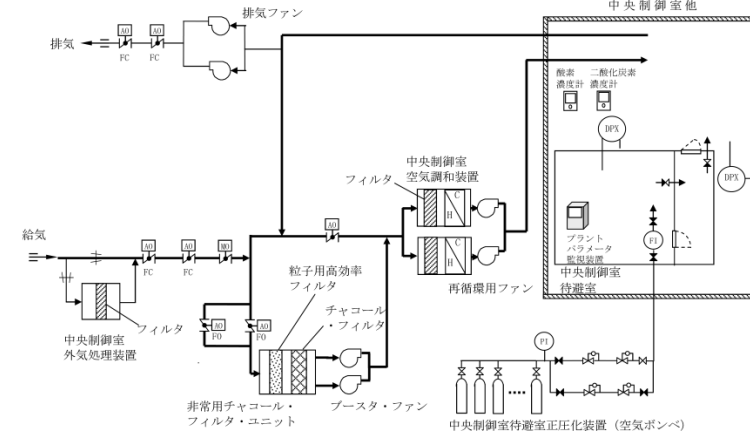
中央制御室待避室の収容人数は、6号炉、7号炉運転員数18名に予備要員の余裕を持たせた合計20名が収容可能な設計とする。中央制御室待避室のレイアウトを図2.4-15に示す。



図 2.4-15 中央制御室待避室 レイアウト

：SA範囲

(2) 収容人数及び設置場所

格納容器圧力逃がし装置作動中は、中央制御室にはプラントの状態監視等に必要な最低限の要員を残すこととしており、中央制御室待避室は3名を収容できる設計とする。

運転員が中央制御室待避室に待避している間、プラントの運転操作は行わないことを基本とするが、操作が必要な事象が発生した場合には即座に対応できるように、中央制御室内に中央制御室待避室を設置する。中央制御室待避室の設置場所を第2.4-4図に、中央制御室待避室の概要図を第2.4-5図に示す。



第 2.4-4 図 中央制御室待避室 設置場所

：SA範囲

(2) 収容人数及び設置場所

中央制御室待避室の収容人数は、中央制御室運転員数5名が収容可能な設計とする。中央制御室待避室のレイアウトを図2.4-15に示す。

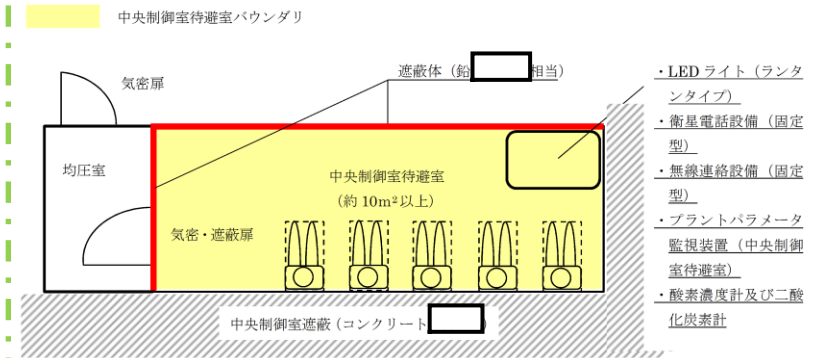

注：レイアウトについては、訓練等で有効性を確認し、適宜見直していく。

図 2.4-15 中央制御室待避室レイアウト

：SA範囲

・申請号炉数の相違
【柏崎6,7】
・設計方針の相違
【柏崎6/7,東海第二】
④の相違

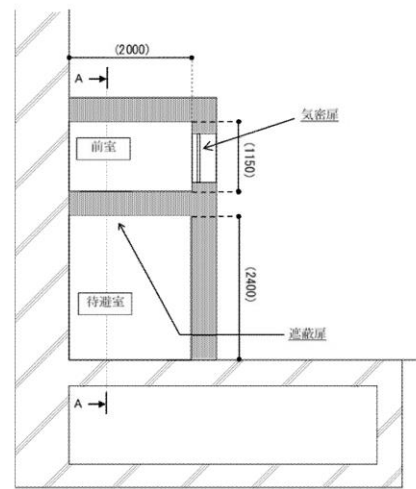

(平面図)

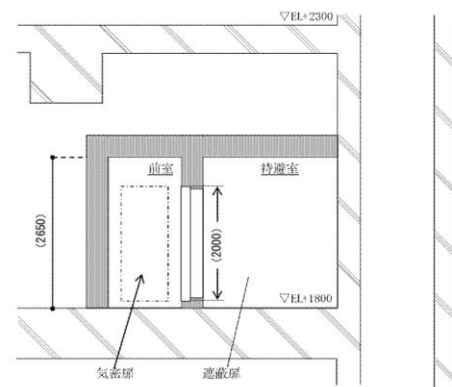

(A-A断面図)

※ ()内は概略寸法 [mm]を示す。
 なお、今後の検討結果等により変更となる可能性がある。

第2.4-5図 中央制御室待避室 概要図

: SA範囲

(3) 遮蔽設備
 中央制御室待避室の壁は、コンクリート mm、若しくはそれと同等以上の遮蔽能力を期待できる鉛壁（一部、可搬遮蔽装置）、若しくはコンクリート・鉛の複合壁とし、放射性物質のガンマ線による外部被ばくを低減する設計とする。概要は図 2.4-15 に示すとおり。

(4) 陽圧化装置
 a. 系統構成
 中央制御室待避室の陽圧化装置の系統概要図を図 2.4-16 に示す。



図 2.4-16 陽圧化装置 系統概要図

: SA 範囲

(3) 遮蔽設備
 中央制御室待避室の壁は、鉛壁 20mm と同等以上の遮蔽能力を期待できるコンクリート壁とし、放射性物質のガンマ線による外部被ばくを低減する設計とする。また、発電機長等が出入りする扉については遮蔽扉を設置する。

(4) 中央制御室待避室空気ポンプユニット
 a. 系統構成
 中央制御室待避室空気ポンプユニットの概要図を第 2.4-6 図に示す。空気ポンベから減圧ユニットを介し、流量計ユニットにより一定流量の空気を中央制御室待避室内へ供給する。中央制御室待避室内は、微差圧調整ダンパにより正圧を維持する。また、中央制御室待避室内が微正圧であることを確認するため、中央制御室待避室差圧計を設置する。

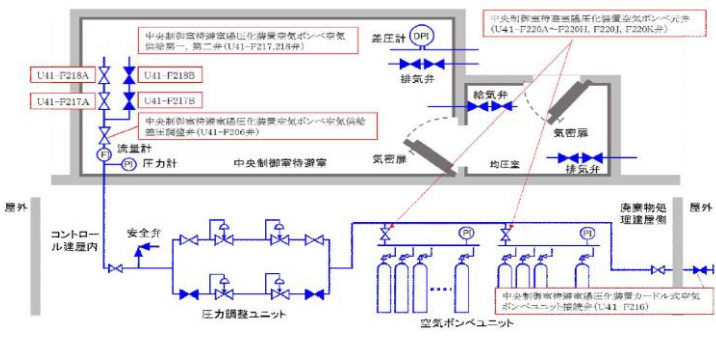
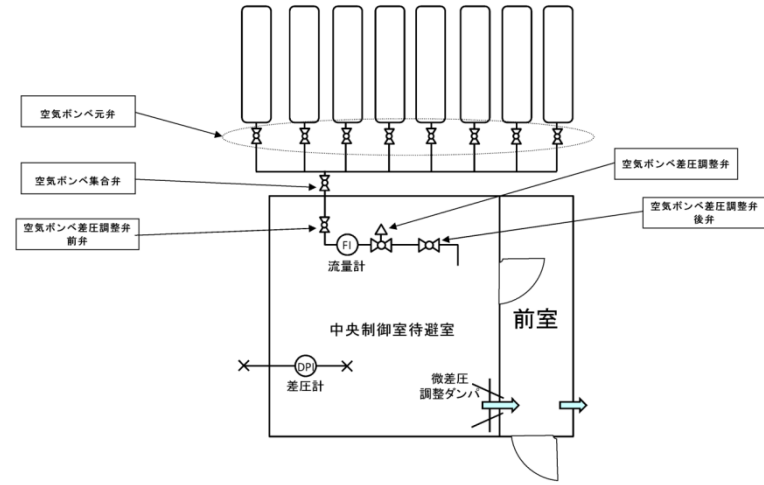

第 2.4-6 図 中央制御室待避室空気ポンプユニット 概要図

: SA 範囲

(3) 遮蔽設備
 中央制御室待避室の壁は、鉛 と同等以上の遮蔽能力を期待できる金属壁とし、放射性物質のガンマ線による外部被ばくを低減する設計とする。また、運転員が出入りする扉については気密性を持った遮蔽扉を設置する。概要は図 2.4-15 に示すとおり。

(4) 中央制御室待避室正圧化装置
 a. 系統構成
 中央制御室待避室正圧化装置の系統概要図を図 2.4-16 に示す。空気ポンベから減圧弁を介し、流量調整弁により一定流量の空気を中央制御室待避室内へ供給する。中央制御室待避室内は、予め開度調整した排気隔離弁により正圧を維持する。また、中央制御室待避室内が微正圧であることを確認するため、中央制御室待避室差圧計を設置する。



図 2.4-16 中央制御室待避室正圧化装置 系統概要図

: SA 範囲

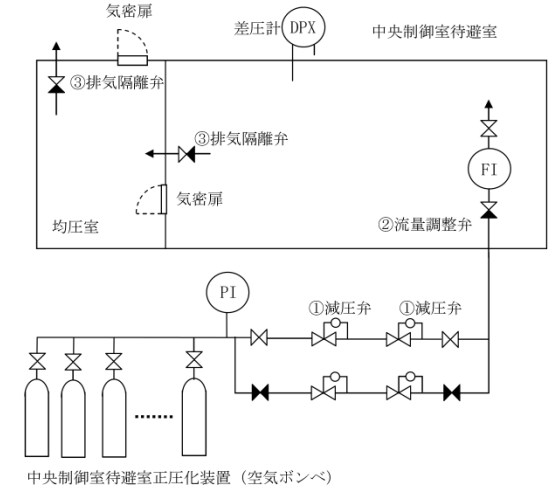

備考

- ・設備の相違
 【柏崎 6/7, 東海第二】
 ⑤の相違
- ・記載方針の相違
 【柏崎 6/7】
 島根 2号炉は待避室内の正圧化概要を記載。

柏崎刈羽原子力発電所 6 / 7号炉 (2017.12.20)	東海第二発電所 (2018.9.18版)	島根原子力発電所 2号炉	備考
<p>b. 必要空気供給量</p> <p>① 二酸化炭素濃度基準に基づく必要換気量</p> <ul style="list-style-type: none"> ・ 収容人数 : n = <u>20名</u> ・ 許容二酸化炭素濃度 : C = <u>0.5%</u> (労働安全衛生規則) <ul style="list-style-type: none"> ・ 大気二酸化炭素濃度 : $C_0 = \underline{0.039\%}$ (標準大気二酸化炭素濃度) ・ 呼吸による二酸化炭素発生量 : $M = 0.022\text{m}^3/\text{h}/\text{人}$ (空気調和・衛生工学便覧の極軽作業の作業程度の吐出し量) ・ 必要換気量 : $Q_1 = 100 \times M \times n / (C - C_0) \text{ m}^3/\text{h}$ (空気調和・衛生工学便覧の二酸化炭素基準の必要換気量) $Q_1 = \underline{100 \times 0.022 \times 20 \div (0.5 - 0.039)}$ $= \underline{95.45}$ $\approx \underline{95.5\text{m}^3/\text{h}}$	<p>b. 必要空気供給量</p> <p>① 二酸化炭素濃度基準に基づく必要換気量</p> <ul style="list-style-type: none"> ・ 収容人数 : n = <u>3名</u> ・ 許容二酸化炭素濃度 : C = <u>0.5 [%]</u> (J E A C 4622-2009) <ul style="list-style-type: none"> ・ 空気ポンベ中の二酸化炭素濃度 : $C_0 = \underline{0.0336 [\%]}$ ・ 呼吸により排出する二酸化炭素量 : $M = 0.022 [\text{m}^3/\text{h}/\text{人}]$ (空気調和・衛生工学便覧の極軽作業の作業程度の吐出し量) ・ 必要換気量 : $Q_1 = 100 \times M \times n / (C - C_0) [\text{m}^3/\text{h}]$ (空気調和・衛生工学便覧の二酸化炭素基準の必要換気量) $Q_1 = \underline{100 \times 0.022 \times 3 \div (0.5 - 0.0336)}$ $= \underline{14.15}$ $\approx \underline{14.2 [\text{m}^3/\text{h}]}$	<p>b. 必要空気供給量</p> <p>① 二酸化炭素濃度基準に基づく必要換気量</p> <ul style="list-style-type: none"> ・ 収容人数 n = <u>5名</u> ・ 許容二酸化炭素濃度 C = <u>1.0%*</u> (鉱山保安法施行規則) <ul style="list-style-type: none"> ・ 空気ポンベ二酸化炭素濃度 $C_0 = \underline{0.03\%}$ (空気調和・衛生工学便覧) ・ 呼吸による二酸化炭素発生量 $M = 0.022\text{m}^3/\text{h}/\text{人}$ (空気調和・衛生工学便覧の極軽作業の作業程度の吐出し量) ・ 必要換気量 $Q_1 = 100 \times M \times n \div (C - C_0) \text{ m}^3/\text{h}$ (空気調和・衛生工学便覧の二酸化炭素基準の必要換気量) $Q_1 = \underline{100 \times 0.022 \times 5 \div (1.0 - 0.03)}$ $= \underline{11.4}$ $\approx \underline{11.4 \text{ m}^3/\text{h}}$	<p>備考</p> <ul style="list-style-type: none"> ・ 設計方針の相違 【柏崎 6/7, 東海第二】 ④の相違 ・ 評価方針の相違 【柏崎 6/7, 東海第二】 待避室は密閉された限られた環境であることから同様に限られた環境下における労働環境を規定している「鉱山保安法施行規則」に定める酸素濃度 19%以上及び二酸化炭素濃度 1%以下を適用 (以下, ⑦の相違) ・ 設計方針の相違 【柏崎 6/7, 東海第二】 島根 2号炉は「空気調和・衛生工学便覧」に記載の空気中の二酸化炭素濃度を使用 ・ 評価結果の相違 【柏崎 6/7, 東海第二】 島根 2号炉の収容人数が待機する場合に必要な空気供給量を記載
: SA範囲	: SA範囲	: SA範囲	

柏崎刈羽原子力発電所 6/7号炉 (2017.12.20)	東海第二発電所 (2018.9.18版)	島根原子力発電所 2号炉	備考
<p>②酸素濃度基準に基づく必要換気量</p> <ul style="list-style-type: none"> ・収容人数：n=20名 ・吸気酸素濃度：a=20.95% (標準大気酸素濃度) ・許容酸素濃度：b=18% (労働安全衛生規則) ・成人の呼吸量：c=0.48m³/h/人 (空気調和・衛生工学便覧) ・乾燥空気換算呼気酸素濃度：d=16.4% (空気調和・衛生工学便覧) ・必要換気量：Q₁=c×(a-d)×n/(a-b) m³/h (空気調和・衛生工学便覧の酸素基準の必要換気量) $Q_1 = \frac{0.48 \times (20.95 - 16.4) \times 20}{20.95 - 18.0}$ $= 14.81$ $\approx 14.9 \text{ m}^3/\text{h}$ <p>以上より、空気ポンベ陽圧化に必要な空気供給量は二酸化炭素濃度基準の <u>95.5m³/h</u> とする。</p>	<p>②酸素濃度基準に基づく必要換気量</p> <ul style="list-style-type: none"> ・収容人数：n=3 [名] ・吸気酸素濃度：a=20.95 [%] (標準大気酸素濃度) ・許容酸素濃度：b=19 [%] (「鉱山保安法施工規則」) ・成人の呼吸量：c=0.48 [m³/h/人] (空気調和・衛生工学便覧) ・乾燥空気換算酸素濃度：d=16.4 [%] (空気調和・衛生工学便覧) ・必要換気量：Q₁=c×(a-d)×n/(a-b) [m³/h] (空気調和・衛生工学便覧の酸素基準の必要換気量) $Q_1 = \frac{0.48 \times (20.95 - 16.4) \times 3}{20.95 - 19.0}$ $= 3.36$ $\approx 3.4 \text{ [m}^3/\text{h]}$ <p>以上より、空気ポンベによる正圧化に必要な空気供給量は二酸化炭素濃度基準の <u>14.2m³/h</u> とする。</p>	<p>② 酸素濃度基準に基づく必要換気量</p> <ul style="list-style-type: none"> ・収容人数 n=5名 ・吸気酸素濃度 a=20.95% (標準大気酸素濃度) ・許容酸素濃度 b=19%* (鉱山保安法施行規則) ・成人の呼吸量 c=0.48m³/h/人 (空気調和・衛生工学便覧) ・乾燥空気換算呼気酸素濃度 d=16.4% (空気調和・衛生工学便覧) ・必要換気量 $Q_1 = \frac{c \times (a - d) \times n}{a - b} \text{ m}^3/\text{h}$ $= \frac{0.48 \times (20.95 - 16.4) \times 5}{20.95 - 19.0}$ $= 5.6 \text{ m}^3/\text{h}$ <p>以上より、空気ポンベ正圧化に必要な空気供給量は二酸化炭素濃度基準の <u>11.4m³/h</u> とする。</p> <p>※ 許容二酸化炭素濃度, 許容酸素濃度 <u>空気ポンベを使用する場合は、希ガス等の放射性物質を含む外気が侵入しないようにするための防護措置であり、中央制御室待避室が密閉された限られた環境であるため、同様に限られた環境下における労働環境を規定している「鉱山保安法施行規則」に定める許容二酸化炭素濃度 1.0%以下、許容酸素濃度 19%以上とする。</u></p>	<p>備考</p> <ul style="list-style-type: none"> ・設計方針の相違 【柏崎 6/7, 東海第二】 ④⑦の相違 ・評価結果の相違 【柏崎 6/7, 東海第二】 島根 2 号炉の収容人数が待機する場合に必要な空気供給量を記載 ・評価方針の相違 【柏崎 6/7】 ⑦の相違
<p style="text-align: right;">: SA 範囲</p>	<p style="text-align: right;">: SA 範囲</p>	<p style="text-align: right;">: SA 範囲</p>	

柏崎刈羽原子力発電所 6/7号炉 (2017.12.20)	東海第二発電所 (2018.9.18版)	島根原子力発電所 2号炉	備考
<p>c. 必要ポンペ本数</p> <p>中央制御室待避室を10時間陽圧化する必要最低限のポンペ本数は二酸化炭素濃度基準換気量の95.5m³/h及びポンペ供給可能空気量5.50m³/本から下記のとおり174本となる。</p> <p>なお、中央制御室待避室においては陽圧化試験を実施し必要ポンペ本数が10時間[*]陽圧化維持するのに十分であることの確認を実施し、予備のポンペ容量について決定する。</p> <ul style="list-style-type: none"> ・ポンペ初期充填圧力：14.7MPa (at35℃) ・ポンペ内容積：46.7L ・圧力調整弁最低制御圧力：0.89MPa ・ポンペ供給可能空気量：5.50m³/本 (at-4℃) <p>以上より、必要ポンペ本数は下記の通り 174 本以上となる。</p> $\frac{95.5\text{m}^3/\text{h}}{5.50\text{m}^3/\text{本}} \times 10 \text{ 時間} = 173.6 \approx 174 \text{ 本}$ <p>※ 格納容器ベントの実施に伴い評価期間中に放出される放射性物質のうち、大部分が放出される期間(数時間)に余裕を持たせ、陽圧化装置による陽圧化時間を10時間と設定</p> <p>d. 空気ポンペ設置エリア</p> <p>空気ポンペの配置を図2.4-17に示す。空気ポンペは、コントロール建屋1階及び廃棄物処理建屋1階に配置し、コントロール建屋2階の中央制御室待避室に空気を供給する。</p> <p style="text-align: right;">: SA範囲</p>	<p>c. 必要ポンペ本数</p> <p>中央制御室待避室は、中央制御室内に流入した放射性物質からの影響を十分に防護できる時間として、ベント開始から5時間正圧化する。</p> <p>中央制御室待避室を5時間正圧化するための必要最低限のポンペ本数は、二酸化炭素濃度基準換気量の14.2m³/h及びポンペ供給可能空気量5.5m³/本から、下記のとおり13本となる。したがって、格納容器圧力逃がし装置作動時、中央制御室待避室内に滞在する運転員(3名)が5時間滞在するために必要な本数は、13本である。なお、中央制御室待避室においては、正圧化試験により必要ポンペ本数が5時間の正圧化を維持するのに十分であることの確認を実施し、予備のポンペ容量について決定する。</p> <ul style="list-style-type: none"> ・ポンペ初期充填圧力：14.7MPa (at35℃) ・ポンペ内容積：46.7L ・ポンペ供給可能空気量：5.5m³/本[*] <p>※ 空気ポンペは、標準圧力14.7MPaで7m³/本であるが、安全側(残圧及び使用温度補正)を考慮し、5.5m³/本とする。</p> <p>以上から、必要なポンペ本数は、下記の計算により、13本となる。</p> $\frac{14.2 \text{ [m}^3/\text{h}]}{5.5 \text{ [m}^3/\text{本}]} \times 5 \text{ [時間]} = 12.9 \approx 13 \text{ [本]}$ <p>d. 中央制御室待避室空気ポンペユニット(空気ポンペ)の設置エリア</p> <p>中央制御室待避室空気ポンペユニット(空気ポンペ)は、中央制御室近傍の原子炉建屋付属棟3階に配置し、中央制御室待避室に空気を供給する。中央制御室待避室空気ポンペユニット(空気ポンペ)の配置図を第2.4-7図に示す。</p> <p style="text-align: right;">: SA範囲</p>	<p>c. 必要ポンペ本数</p> <p>中央制御室待避室を10時間^{*1}正圧化する必要最低限のポンペ本数は、二酸化炭素濃度基準換気量の11.4m³/h及びポンペ供給可能空気量8.0m³/本から下記のとおり15本となる。なお、中央制御室待避室においては、正圧化試験を実施し必要ポンペ本数が10時間^{*1}正圧化維持するのに十分であることの確認を実施し、予備のポンペ容量について決定する。</p> <ul style="list-style-type: none"> ・ポンペ初期充填圧力 19.6MPa (at35℃) ・ポンペ内容積 50.0L ・圧力調整弁最低制御圧力 1.0MPa ・ポンペ供給可能空気量 8.0m³/本 (at 0℃) ・待避中ポンペ使用時間：10時間 ・待避前ポンペ使用時間：20分^{*2} <p>以上より、必要ポンペ本数は下記のとおり15本以上となる。</p> $\frac{11.4\text{m}^3/\text{h}}{8.0\text{m}^3/\text{本}} \times 10 \text{ 時間} \times \frac{20 \text{ 分}}{60} = 14.7 \text{ 本} \approx 15 \text{ 本}$ <p>※1 格納容器ベントの実施に伴い評価期間中に放出される放射性物質のうち、大部分が放出される期間(数時間)に余裕を持たせ、空気ポンペによる正圧化時間を10時間と設定</p> <p>※2 格納容器ベント実施予測時刻の20分前にポンペ使用を開始する。</p> <p>d. 空気ポンペ設置エリア</p> <p>空気ポンペの配置を図2.4-17に示す。空気ポンペは、廃棄物処理建物地上1階及び地上2階に配置し、制御室建物地上4階の中央制御室待避室に空気を供給する。</p> <p style="text-align: right;">: SA範囲</p>	<p>備考</p> <ul style="list-style-type: none"> ・評価方針の相違 【柏崎6/7,東海第二】 島根2号炉の収容人数が待機する場合に必要なポンペ本数及び設置エリアを記載 ・評価条件の相違 【柏崎6/7,東海第二】 空気ポンペ仕様の相違 ・評価結果の相違 【柏崎6/7,東海第二】 ・正圧化時間の相違 【柏崎6/7,東海第二】 ベント実施後の待避時間の相違

柏崎刈羽原子力発電所 6/7号炉 (2017.12.20)	東海第二発電所 (2018.9.18版)	島根原子力発電所 2号炉	備考
<div data-bbox="189 262 839 667" data-label="Image"> </div> <div data-bbox="299 686 736 722" data-label="Caption"> <p>図 2.4-17 空気ポンベ設置 配置図</p> </div> <div data-bbox="189 777 908 993" data-label="Text"> <p>e. <u>カードル式空気ポンベユニット (空気ポンベカードル車)</u> <u>運転員の更なる被ばく線量低減のため、自主対策設備として空気ポンベ陽圧化時間の延長を可能とする空気ポンベカードル車を配備する。空気ポンベカードル車は建屋外から空気ポンベを接続可能な設計とする。</u></p> </div> <div data-bbox="189 1001 908 1218" data-label="Text"> <p><u>カードル式空気ポンベユニットの概念図を図2.4-18に示す。カードル式空気ポンベユニットは、重大事故等発生時において屋外の接続口に高圧ホースを介して接続することで、コントロール建屋内から常設の陽圧化装置側との切替え操作が可能な設計とする。</u></p> </div> <div data-bbox="189 1226 908 1442" data-label="Text"> <p><u>なお、カードル式空気ポンベユニットの空気ポンベは、常設の陽圧化装置の空気ポンベと同等の174本以上の容量を確保可能な設計とする。ポンベユニット必要空気量、必要供給量については、前出2.4.4(4) b.ならびにc.と同様の設計とする。</u></p> </div> <div data-bbox="160 1451 887 1703" data-label="Image"> </div> <div data-bbox="201 1717 828 1755" data-label="Caption"> <p>図 2.4-18 カードル式空気ポンベユニット 概念図</p> </div> <div data-bbox="661 1787 908 1843" data-label="Text"> <p> : SA範囲</p> </div>	<div data-bbox="1020 268 1596 1272" data-label="Image"> </div> <div data-bbox="923 1316 1679 1396" data-label="Caption"> <p>第 2.4-7 図 中央制御室待避室空気ポンベユニット (空気ポンベ) 配置図</p> </div> <div data-bbox="1448 1787 1694 1843" data-label="Text"> <p> : SA範囲</p> </div>	<div data-bbox="1724 268 2466 800" data-label="Image"> </div> <div data-bbox="1869 823 2329 856" data-label="Caption"> <p>図 2.4-17 空気ポンベ設置 配置図</p> </div> <div data-bbox="2243 1787 2490 1843" data-label="Text"> <p> : SA範囲</p> </div>	<p>備考</p> <p>・設備の相違 【柏崎 6/7, 東海第二】 ⑥の相違</p>

e. 正圧達成までに要する時間
 中央制御室待避室を加圧した際に隣接区画に比べて+10Pa [gage] の正圧達成までに要する時間を評価した結果、約3.2秒となった。

(a) 評価モデル
 中央制御室待避室への加圧の評価モデル及び評価式を以下に示す。

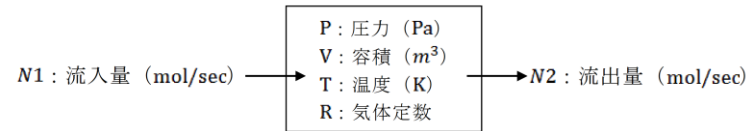

中央制御室待避室における基礎式を以下に示す。

$$\frac{dn}{dt} = \frac{d}{dt} \frac{PV}{RT} = N1 - N2$$

上記基礎式を展開し、単位時間当たりの室内圧力上昇量を求める算出式を導く。この式を用いて微小時間 Δt 後の室圧 $P_{t+\Delta t}$ を繰り返し計算することで、室圧 P の経時変化を求める。

: S A 範囲

e. 正圧達成までに要する時間
 中央制御室待避室を加圧した際に隣接区画に比べて+10Pa [gage] の正圧達成までに要する時間を評価した結果、約2秒となった。

(a) 評価モデル
 中央制御室待避室への加圧の評価モデル及び評価式を以下に示す。

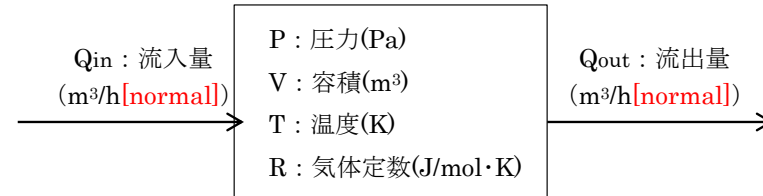

中央制御室待避室加圧における圧力時間変化の式を以下に示す。

$$\frac{dP}{dt} = \frac{RT}{V} \cdot \frac{dn}{dt} = \frac{RT}{V} \left(\frac{P_{atm}}{RT} (Q_{in} - Q_{out}) \right) = \frac{P_{atm}}{V} \cdot (Q_{in} - Q_{out})$$

上記式から、単位時間当たりの待避室圧力上昇量を求め、微小時間 Δt 後の待避室圧力 $P(t+\Delta t)$ を繰り返し計算することで、待避室圧力 $P(t)$ の経時変化を求める。

待避室からの空気流出量 Q_{out} については、ベルヌーイ式により求めることができ、漏えい面積 A は、待避室の設計値に基づき、設定ポンペ流量及び、正圧基準値により求める。

$$P(t + \Delta t) = P(t) + \Delta t \cdot \frac{P_{atm}}{V} \cdot (Q_{in} - Q_{out})$$

$$= P(t) + \Delta t \cdot \frac{P_{atm}}{V} \cdot \left(Q_{in} - A \sqrt{\frac{2(P(t) - P_{atm})}{\rho}} \right)$$

: S A 範囲

・評価結果の相違
【東海第二】

(b) 評価条件

第2.4-1表 中央制御室待避室への加圧の評価条件

項目	記号	単位	中央制御室待避室	備考
大気圧力	P_o	Pa [abs]	101,325	
容積	V	m^3	32	
温度	T	K	293.15	
流入量	N1	m^3/h	14.2	
		mol/sec	0.164	
リーク面積	Λ	m^2	9.06×10^{-4}	流入量と室圧基準より算出 (評価用暫定値)
正圧 (10Pa [gage]) 達成時間	t	sec	1.5	

(c) 圧力の時間変化

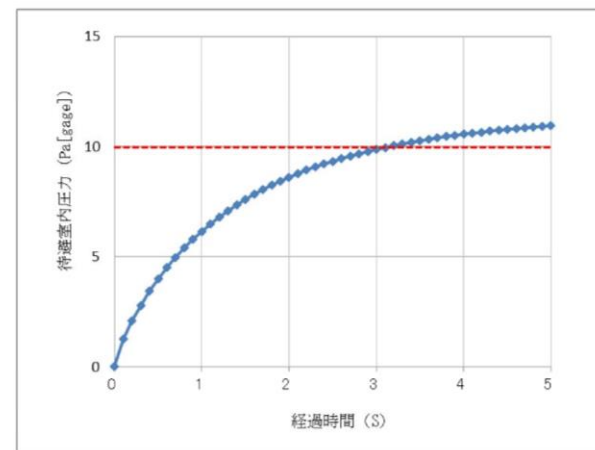

第2.4-8図 中央制御室待避室内圧力の時間変化

： S A 範囲

(b) 評価条件

表 2.4-3 中央制御室待避室への加圧の評価条件

項目	記号	単位	値	備考
大気圧力	P_{atm}	Pa	101325	標準大気圧力
大気密度	ρ	kg/m^3	1.185	25°Cのときの空気密度
容積	V	m^3	30	設計値より
ポンペ流量	Q_{in}	m^3/h	11.4	設計値より
等価漏えい面積	A	m^2		流入量と正圧基準値から算出
正圧基準値	P_{∞}	Pa		評価用暫定値

(c) 正圧化達成時間



図 2.4-18 中央制御室待避室内圧力の時間変化

： S A 範囲

・評価結果の相違
【東海第二】

(5) 中央制御室換気空調系の運転状態比較

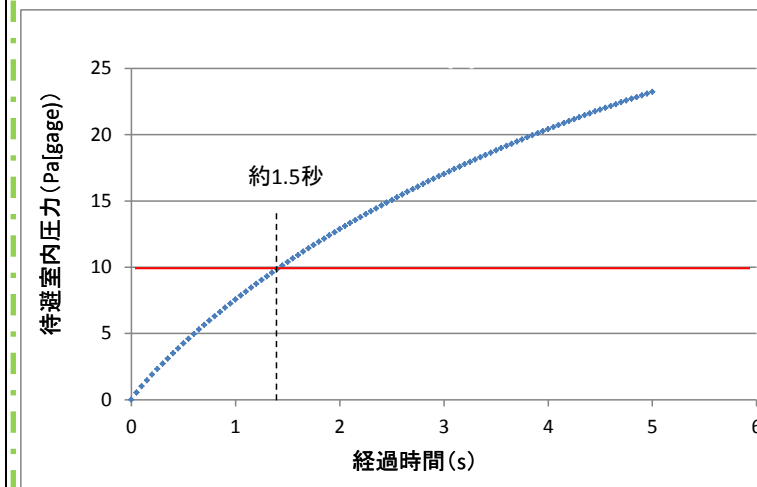
中央制御室の換気空調系の状態について、通常運転時、設計基準事故時、重大事故時の炉心の著しい損傷が発生した場合を比較、図示すると以下のとおりとなる。通常運転時、設計基準事故時の運転モードを、図2.4-19運転モード毎の中央制御室換気空調系系統概略図(1/2)に示す。

(5) 中央制御室換気系の運転状態比較

中央制御室換気系の状態について、通常運転時、設計基準事故時及び重大事故等時を比較し、通常運転時及び設計基準事故時の系統概要図を第2.4-2図(1/2)に、重大事故等時のプルーム通過前後及びプルーム通過時の系統概要図を第2.4-2図(2/2)に示す。

(5) 中央制御室換気系の運転状態比較

中央制御室換気系の状態について、通常運転時、設計基準事故時、重大事故時を比較、図示すると以下のとおりとなる。通常運転時、設計基準事故時の運転モードを図2.4-19運転モード毎の中央制御室換気系系統概要図(1/2)に示す。



図2.4-19 運転モード毎の中央制御室換気空調系系統概略図

(1/2)



図2.4-19 運転モード毎の中央制御室換気系系統概要図(1/2)

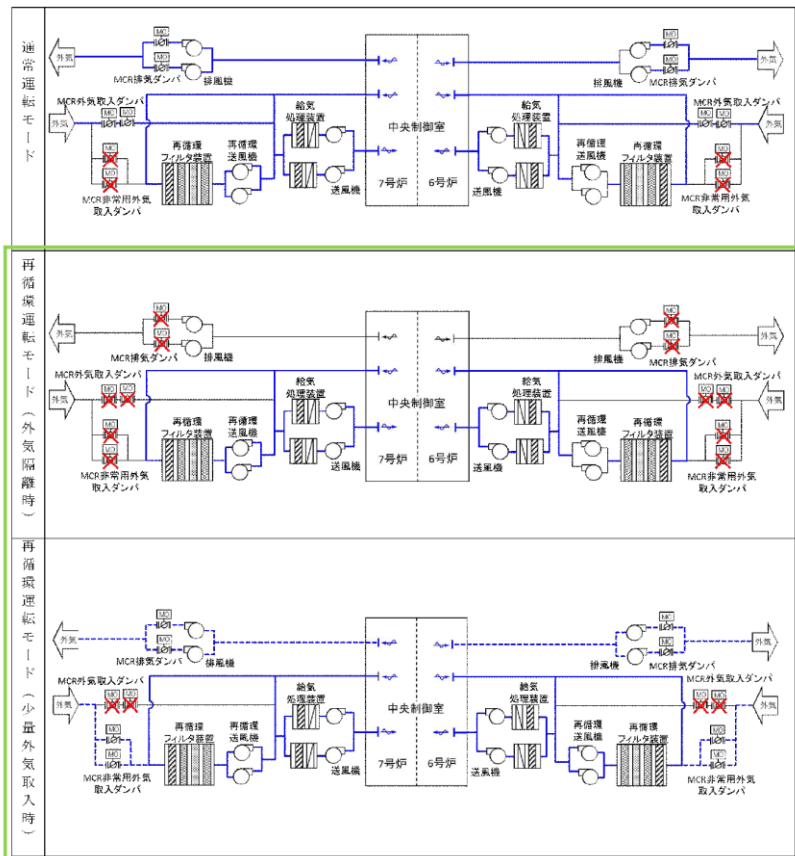

・設備の相違
【柏崎6/7, 東海第二】

柏崎刈羽原子力発電所 6 / 7号炉 (2017.12.20)

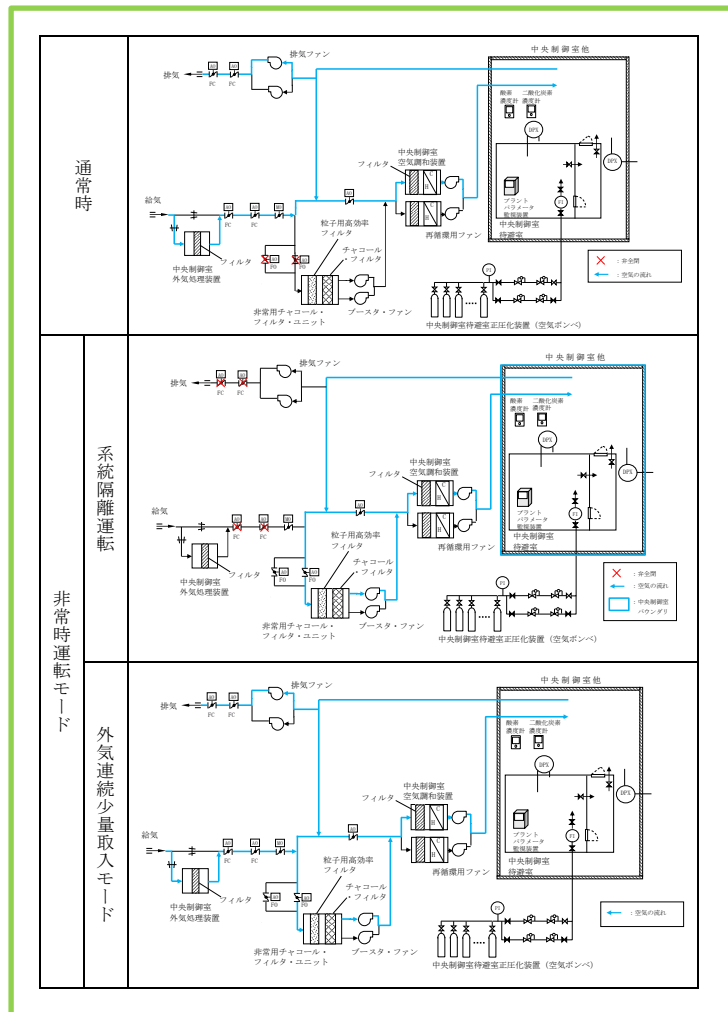
炉心の著しい損傷発生時のブルーム通過前・後、及びブルーム通過中の運転モードを、図2.4-19 運転モード毎の中央制御室換気空調系系統概略図 (2/2) に示す。



図 2.4-19 運転モード毎の中央制御室換気空調系 系統概略図 (2/2)

： SA 範囲

東海第二発電所 (2018.9.18 版)

島根原子力発電所 2号炉

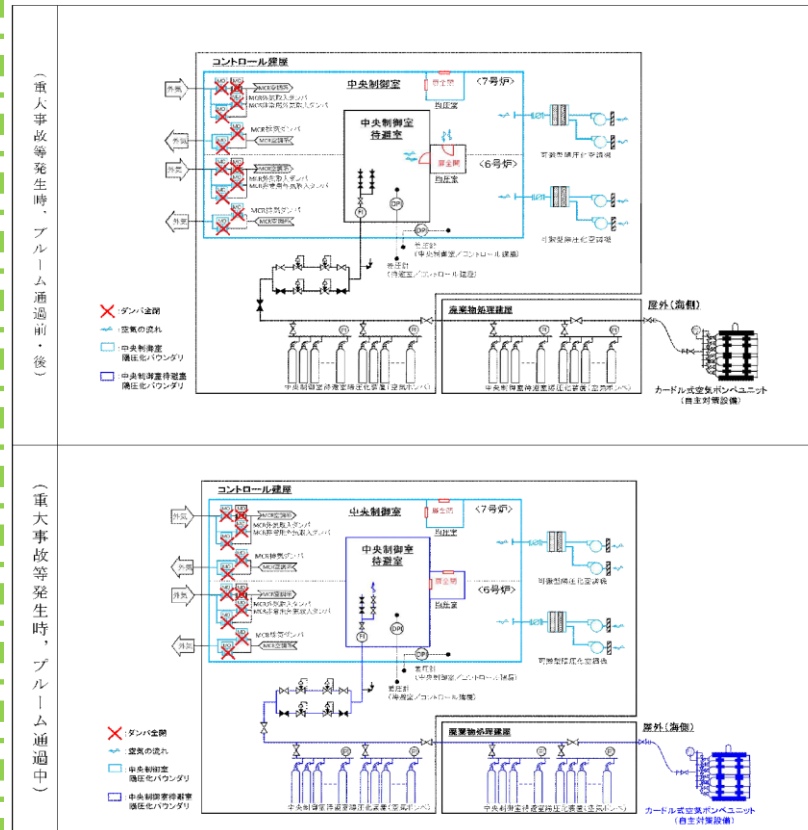
備考

重大事故時のブルーム通過前・後、及びブルーム通過中の運転モードを、図 2.4-19 運転モード毎の中央制御室換気系系統概要図 (2/2) に示す。



図 2.4-19 運転モード毎の中央制御室換気系 系統概要図 (2/2)

： SA 範囲

・設備の相違
【柏崎 6/7, 東海第二】

柏崎刈羽原子力発電所 6 / 7号炉 (2017.12.20)	東海第二発電所 (2018.9.18版)	島根原子力発電所 2号炉	備考
<p>(6) 通信連絡設備</p> <p>中央制御室待避室には、運転員が炉心の著しい損傷発生時の格納容器圧力逃がし装置作動に際して、水素爆発による格納容器の破損防止（格納容器圧力逃がし装置に関するパラメータ）の確認に加え、原子炉格納容器内の状態、使用済燃料プールの状態、水素爆発による原子炉格納容器の破損防止、水素爆発による原子炉建屋の損傷防止を確認できるパラメータを確認できるようデータ表示装置を設置する設計とする。データ表示装置は6号及び7号炉用に1台ずつ設置する。</p> <p>なお、データ表示装置は今後の監視パラメータ追加や表示機能の拡張等を考慮した設計とする。</p> <p>データ表示装置で確認できる主なパラメータを表2.4-3、データ表示装置に関するデータ伝送の概要を図2.4-20に示す。</p> <p>また、衛星電話設備及び無線連絡設備のうち中央制御室に設置する衛星電話設備（常設）及び無線連絡設備（常設）は、中央制御室待避室においても使用できる設計とする。</p> <p>無線連絡設備（常設）及び衛星電話設備（常設）は、6号及び7号炉用に各々1台ずつ使用できる設計とする。</p> <p>中央制御室待避室における通信連絡設備の概要を図2.4-21に示す。</p>	<p>(6) 通信連絡設備</p> <p>中央制御室待避室には、運転員が格納容器圧力逃がし装置の作動に際して、水素爆発による原子炉格納容器の破損防止（格納容器圧力逃がし装置に関するパラメータ）の確認に加え、原子炉格納容器内の状態、使用済燃料プールの状態並びに水素爆発による原子炉格納容器の破損防止及び原子炉建屋の損傷防止を確認できるパラメータを確認できるように、データ表示装置（待避室）を設置する設計とする。中央制御室待避室に設置するデータ表示装置（待避室）は、中央制御室に1式保管する。</p> <p>なお、データ表示装置（待避室）は、今後の監視パラメータ追加や表示機能の拡張等を考慮した設計とする。</p> <p>データ表示装置（待避室）で確認できる主なパラメータを第2.4-2表に、データ表示装置（待避室）に関するデータ伝送の概要を第2.4-9図に示す。</p> <p>また、中央制御室待避室において、運転員が緊急時対策所及び屋外と通信連絡できるように中央制御室待避室に設置する衛星電話設備（可搬型）（待避室）は、中央制御室に1式保管する。</p> <p>中央制御室待避室における通信連絡設備の概要を第2.4-10図に示す。</p>	<p>(6) 通信連絡設備</p> <p>中央制御室待避室には、運転員が炉心の著しい損傷発生時の格納容器フィルタベント系作動に際して、水素爆発による格納容器の破損防止（格納容器フィルタベント系に関するパラメータ）の確認に加え、原子炉格納容器内の状態、使用済燃料プールの状態、水素爆発による格納容器の破損防止、水素爆発による原子炉建物の損傷防止を確認できるパラメータを確認できるようプラントパラメータ監視装置（中央制御室待避室）を設置する設計とする。中央制御室待避室にはプラントパラメータ監視装置（中央制御室待避室）を1台設置する。</p> <p>なお、プラントパラメータ監視装置（中央制御室待避室）は、今後の監視パラメータ追加や表示機能の拡張等を考慮した設計とする。</p> <p>プラントパラメータ監視装置（中央制御室待避室）で確認できる主なパラメータを表2.4-4に、プラントパラメータ監視装置に関するデータ伝送の概要を図2.4-20に示す。</p> <p>また、衛星電話設備及び無線通信設備のうち衛星電話設備（固定型）及び無線通信設備（固定型）は、中央制御室及び中央制御室待避室用に設け使用できる設計とする。</p> <p>中央制御室待避室における通信連絡設備の概要を図2.4-21に示す。</p>	<p>備考</p> <p>・申請号炉数の相違【柏崎6/7】</p> <p>・申請号炉数の相違【柏崎6/7】</p>
<p style="text-align: right;">: SA範囲</p>	<p style="text-align: right;">: SA範囲</p>	<p style="text-align: right;">: SA範囲</p>	

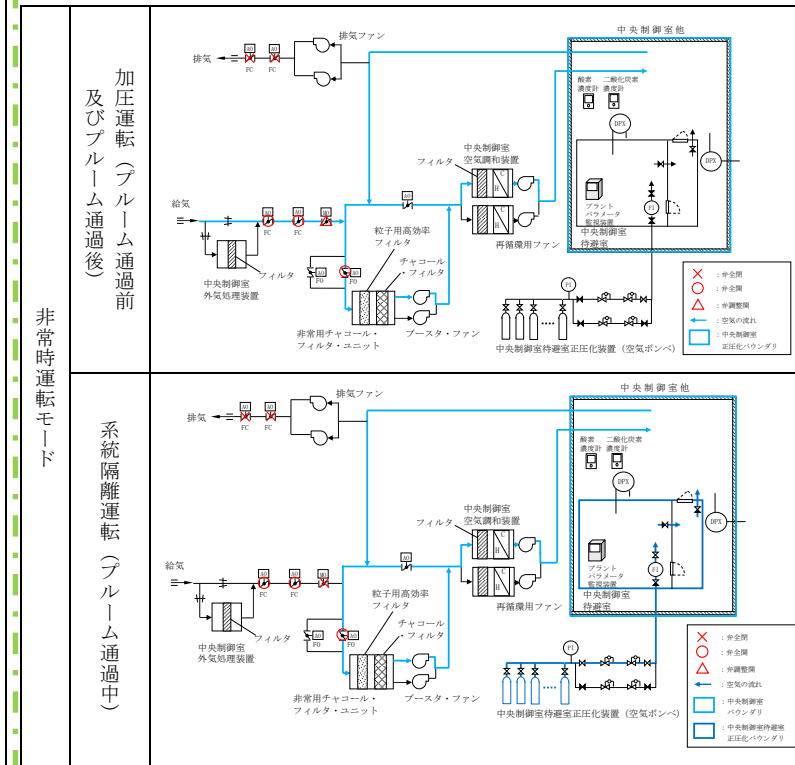
表 2.4-3 データ表示装置で確認できる主なパラメータ (6号及び7号炉共通)

目的	対象パラメータ	
炉心反応度の状態確認	中性子束	
炉心冷却の状態確認	原子炉水位	
	原子炉圧力	
	原子炉冷却材温度	
	高圧炉心注水系統流量	
	原子炉隔離時冷却系統流量	
	高圧代替注水系統流量	
	残留熱除去系統流量	
	原子炉圧力容器温度	
	復水補給水系統流量 (原子炉圧力容器)	
	復水貯蔵槽水位	
	非常用ディーゼル発電機の給電状態	
	非常用高圧母線電圧	
	格納容器内の状態確認	格納容器内圧力
		格納容器内温度
格納容器内水素濃度, 酸素濃度		
格納容器内雰囲気放射線レベル		
サブプレッション・チェンバ・プール水位		
格納容器下部水位		
格納容器スプレイ弁閉閉状態		
残留熱除去系統流量		
復水補給水系統流量 (原子炉格納容器)		
放射能隔離の状態確認	原子炉格納容器隔離の状態	
	排気筒放射線レベル	
使用済燃料プールの状態確認	使用済燃料貯蔵プール水位・温度 (SA)	
	使用済燃料貯蔵プール水位・温度 (SA広域)	
水素爆発による格納容器の破損防止確認	フィルタ装置入口圧力	
	フィルタ装置水位	
	フィルタ装置	
	フィルタ装置出口放射線モニタ	
水素爆発による原子炉建屋の損傷防止確認	フィルタ装置金属フィルタ差圧	
	原子炉建屋内水素ガス濃度	

 : SA範囲

第 2.4-2 表 データ表示装置 (待避室) で確認できる主なパラメータ

目的	対象パラメータ	
炉心反応度の状態確認	出力領域計装 起動領域計装	
炉心冷却の状態確認	原子炉水位	
	原子炉圧力	
	原子炉冷却材温度	
	高圧炉心スプレイ系統流量	
	低圧代替注水系統原子炉注水流量	
	原子炉隔離時冷却系統流量	
	高圧代替注水系統流量	
	残留熱除去系統流量	
	原子炉圧力容器温度	
	非常用ディーゼル発電機の給電状態	
	非常用高圧母線電圧	
	原子炉格納容器内の状態確認	格納容器内圧力
		格納容器内温度
		格納容器内水素濃度, 酸素濃度
格納容器内雰囲気放射線レベル		
サブプレッション・プール水位		
格納容器下部水位		
格納容器スプレイ弁閉閉状態		
残留熱除去系統流量		
放射能隔離の状態確認	原子炉格納容器隔離の状態	
	主排気筒放射線レベル	
使用済燃料プールの状態確認	使用済燃料プール水位・温度	
水素爆発による原子炉格納容器の破損防止確認	フィルタ装置入口圧力	
	フィルタ装置水位	
	フィルタ装置入口水素濃度	
水素爆発による原子炉建屋の損傷防止確認	フィルタ装置出口放射線モニタ	
	原子炉建屋内水素ガス濃度	

 : SA範囲

表 2.4-4 プラントパラメータ監視装置 (中央制御室待避室) で確認できる主なパラメータ

目的	主なパラメータ
炉心反応度の状態確認	中性子束
炉心冷却の確認	原子炉水位 (広帯域) (燃料域)
	原子炉圧力
	原子炉圧力容器温度 (SA)
	高圧炉心スプレイポンプ出口流量
	原子炉隔離時冷却ポンプ出口流量
	残留熱除去ポンプ出口流量
	代替注水流量
	非常用ディーゼル発電機の給電状態
格納容器内の状態確認	非常用高圧母線電圧
	ドライウエル圧力 (SA)
	ドライウエル温度 (SA)
	格納容器内水素濃度, 酸素濃度
	格納容器内雰囲気放射線モニタ
	サブプレッション・プール水位 (SA)
	ベダスタル水位
放射能隔離の状態確認	残留熱代替除去系格納容器スプレイ流量
	代替注水流量
環境の状態確認	格納容器隔離の状態
	排気筒放射線レベル
使用済燃料プールの状態確認	モニタリング・ポストの指示
	気象情報
水素爆発による格納容器の破損防止確認	燃料プール水位 (SA)
	燃料プール水位・温度 (SA)
水素爆発による原子炉建物の損傷防止確認	第1ベントフィルタ出口水素濃度
	第1ベントフィルタ出口放射線モニタ (高レンジ)
水素爆発による原子炉建物の損傷防止確認	原子炉建物水素濃度

 : SA範囲



図 2.4-20 データ表示装置 (待避室) に関するデータ伝送の概要



図 2.4-21 中央制御室待避室における通信連絡設備の概要 (6号炉及び7号炉各々)

: SA範囲

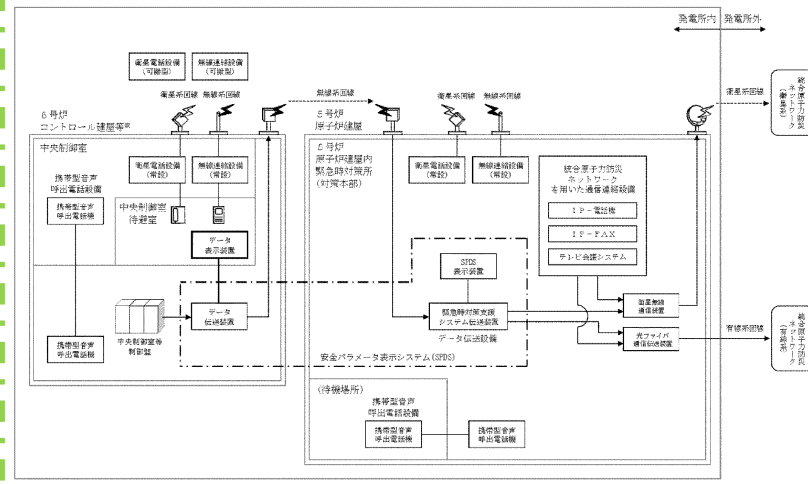

第 2.4-9 図 データ表示装置 (待避室) に関するデータ伝送の概要

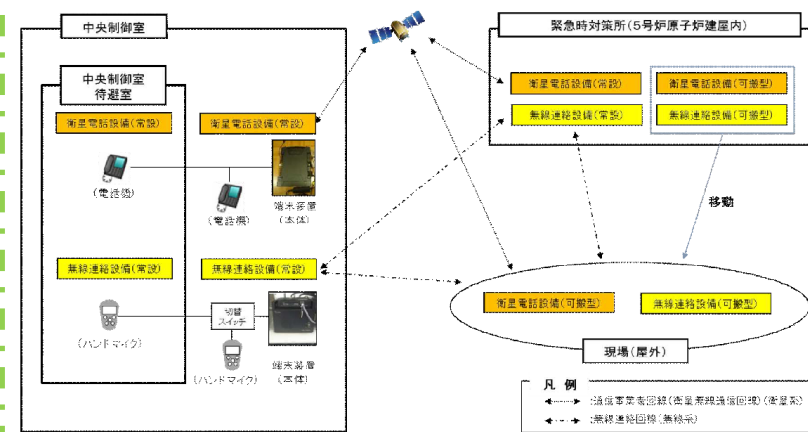
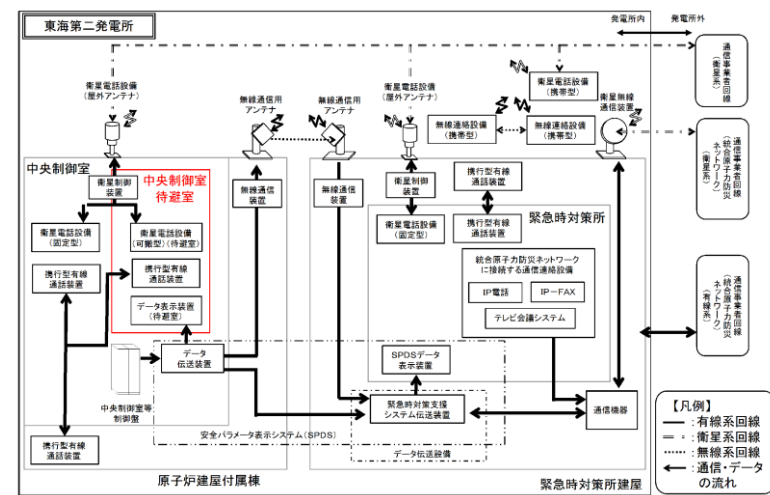
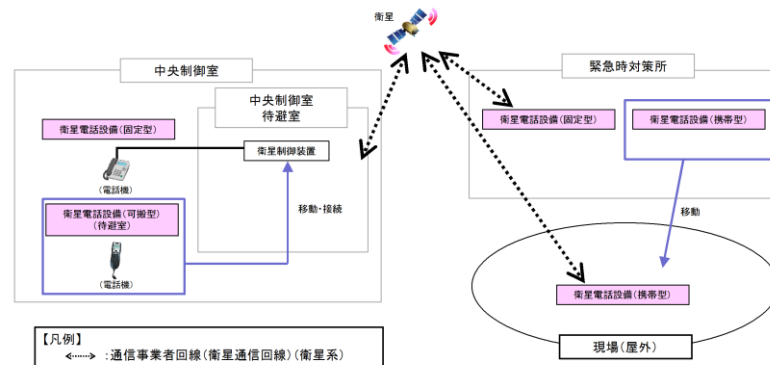

第 2.4-10 図 中央制御室待避室における通信連絡設備の概要

: SA範囲



図 2.4-20 プラントパラメータ監視装置 (中央制御室待避室) のデータ伝送 概要図



図 2.4-21 中央制御室待避室における通信連絡設備の概要

: SA範囲

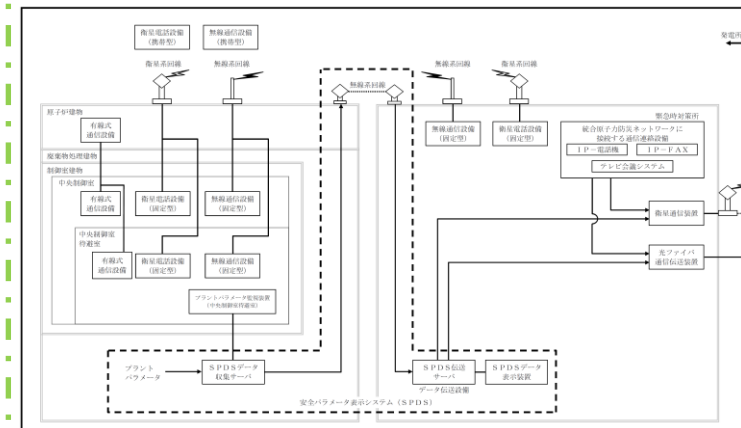
・設備の相違
【柏崎6,7,東海第二】
島根2号炉は通信連絡設備として固定型の衛星電話及び無線通信設備を設置する

(7) 中央制御室待避室のその他設備・資機材
 中央制御室待避室には、炉心の著しい損傷発生時の格納容器圧力逃し装置作動時において運転員がとどまれるようにするため、可搬型蓄電池内蔵型照明、乾電池内蔵型照明、酸素濃度・二酸化炭素濃度計、可搬型エリアモニタを配備する。
 中央制御室待避室にとどまり必要な監視等を行うのに必要な照度を有するものを、可搬型蓄電池内蔵型照明を3台、乾電池内蔵型照明を2台配備する。表2.4-4に中央制御室待避室に配備している可搬型照明を示す。

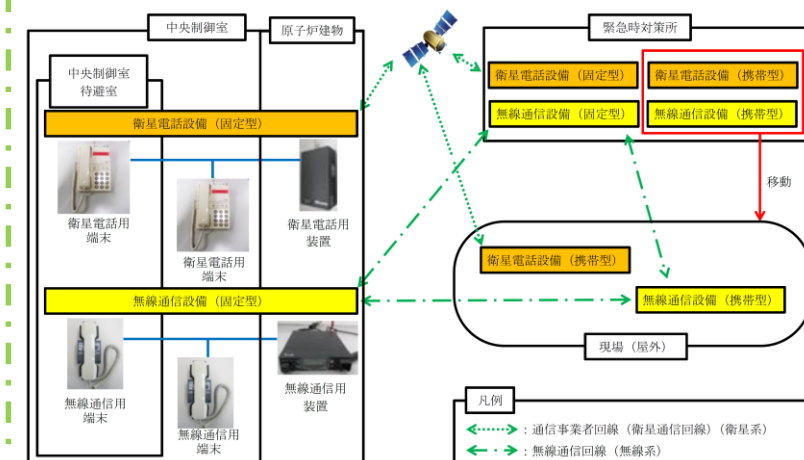
表 2.4-4 中央制御室待避室に配備する可搬型照明

機器名称及び外観	保管場所	数量	仕様
	中央制御室	3台 (予備1台)	・定格電圧：交流100V ・点灯可能時間：12時間以上
	中央制御室	中央制御室待避室2台 (故障時及び保守点検による待機除外時のバックアップ用として中央制御室の予備3台と共用する。)	電源：乾電池 (単一×3) 点灯可能時間：約72時間 (消灯した場合、予備を点灯させ、乾電池交換を実施する。)

酸素濃度・二酸化炭素濃度計は中央制御室待避室の居住環境の基準値の範囲を測定できるものを、1台配備する。表2.4-5に中央制御室待避室に配備する酸素濃度・二酸化炭素濃度計を示す。

表 2.4-5 中央制御室待避室に配備する酸素濃度・二酸化炭素濃度計

機器名称及び外観	仕様等										
	<table border="1"> <tr> <td>検知原理</td> <td>二酸化炭素：NDIR (非分散型赤外線) 酸素：ガルバニ式</td> </tr> <tr> <td>検知範囲</td> <td>二酸化炭素：0.04%~5.00% 酸素：5.0~20.0%</td> </tr> <tr> <td>表示精度</td> <td>二酸化炭素：±10%Rd 酸素：±0.5%</td> </tr> <tr> <td>電源</td> <td>電源：乾電池 (単三×4) 測定可能時間：約20時間 (バッテリー切れの場合、予備を稼働させ、乾電池交換を実施する。)</td> </tr> <tr> <td>個数</td> <td>1台 (故障時及び保守点検による待機除外時のバックアップ用として予備1台を保有する。)</td> </tr> </table>	検知原理	二酸化炭素：NDIR (非分散型赤外線) 酸素：ガルバニ式	検知範囲	二酸化炭素：0.04%~5.00% 酸素：5.0~20.0%	表示精度	二酸化炭素：±10%Rd 酸素：±0.5%	電源	電源：乾電池 (単三×4) 測定可能時間：約20時間 (バッテリー切れの場合、予備を稼働させ、乾電池交換を実施する。)	個数	1台 (故障時及び保守点検による待機除外時のバックアップ用として予備1台を保有する。)
検知原理	二酸化炭素：NDIR (非分散型赤外線) 酸素：ガルバニ式										
検知範囲	二酸化炭素：0.04%~5.00% 酸素：5.0~20.0%										
表示精度	二酸化炭素：±10%Rd 酸素：±0.5%										
電源	電源：乾電池 (単三×4) 測定可能時間：約20時間 (バッテリー切れの場合、予備を稼働させ、乾電池交換を実施する。)										
個数	1台 (故障時及び保守点検による待機除外時のバックアップ用として予備1台を保有する。)										

： SA 範囲

(7) 中央制御室待避室のその他設備・資機材
 格納容器圧力逃し装置作動時において、運転員が中央制御室待避室にとどまれるようにするため、中央制御室待避室用として可搬型照明 (SA)、酸素濃度計、二酸化炭素濃度計及び電離箱サーベイメータを配備する。
 運転員が中央制御室待避室にとどまり必要な監視等を行うために必要な照度を有するものとして、可搬型照明 (SA)を1個配備する。第2.4-3表に中央制御室待避室用の可搬型照明を示す。

第 2.4-3 表 中央制御室待避室用可搬型照明

名称及び外観	保管場所	数量	仕様
	中央制御室	1個 (予備1個 (中央制御室の予備1個と共用))	(AC) 100V~240V 点灯時間： 片面 24時間 両面 12時間

酸素濃度計及び二酸化炭素濃度計は、中央制御室待避室の居住環境の基準値の範囲を測定できるものを、それぞれ1個配備する。第2.4-4表に中央制御室待避室に配備する酸素濃度計及び二酸化炭素濃度計を示す。

第 2.4-4 表 酸素濃度計及び二酸化炭素濃度計の概要

名称及び外観	仕様等										
	<table border="1"> <tr> <td>検知原理</td> <td>ガルバニ式</td> </tr> <tr> <td>検知範囲</td> <td>0.0~40.0vol%</td> </tr> <tr> <td>表示精度</td> <td>±0.1vol%</td> </tr> <tr> <td>電源</td> <td>電源：乾電池 (単四×2本) 測定可能時間：約3,000時間 (乾電池切れの場合、乾電池交換を実施する。)</td> </tr> <tr> <td>個数</td> <td>1個 (故障時及び保守点検による待機除外時のバックアップ用として予備1個を保有する。)</td> </tr> </table>	検知原理	ガルバニ式	検知範囲	0.0~40.0vol%	表示精度	±0.1vol%	電源	電源：乾電池 (単四×2本) 測定可能時間：約3,000時間 (乾電池切れの場合、乾電池交換を実施する。)	個数	1個 (故障時及び保守点検による待機除外時のバックアップ用として予備1個を保有する。)
検知原理	ガルバニ式										
検知範囲	0.0~40.0vol%										
表示精度	±0.1vol%										
電源	電源：乾電池 (単四×2本) 測定可能時間：約3,000時間 (乾電池切れの場合、乾電池交換を実施する。)										
個数	1個 (故障時及び保守点検による待機除外時のバックアップ用として予備1個を保有する。)										
	<table border="1"> <tr> <td>検知原理</td> <td>NDIR (非分散型赤外線)</td> </tr> <tr> <td>検知範囲</td> <td>0.0~5.0vol%</td> </tr> <tr> <td>表示精度</td> <td>±3.0%F.S.</td> </tr> <tr> <td>電源</td> <td>電源：乾電池 (単三×4本) 測定可能時間：約12時間 (乾電池切れの場合、乾電池交換を実施する。)</td> </tr> <tr> <td>個数</td> <td>1個 (故障時及び保守点検による待機除外時のバックアップ用として予備1個を保有する。)</td> </tr> </table>	検知原理	NDIR (非分散型赤外線)	検知範囲	0.0~5.0vol%	表示精度	±3.0%F.S.	電源	電源：乾電池 (単三×4本) 測定可能時間：約12時間 (乾電池切れの場合、乾電池交換を実施する。)	個数	1個 (故障時及び保守点検による待機除外時のバックアップ用として予備1個を保有する。)
検知原理	NDIR (非分散型赤外線)										
検知範囲	0.0~5.0vol%										
表示精度	±3.0%F.S.										
電源	電源：乾電池 (単三×4本) 測定可能時間：約12時間 (乾電池切れの場合、乾電池交換を実施する。)										
個数	1個 (故障時及び保守点検による待機除外時のバックアップ用として予備1個を保有する。)										

： SA 範囲

(7) 中央制御室待避室のその他設備・資機材
 中央制御室待避室には、炉心の著しい損傷発生時の格納容器フィルタベント系作動時において運転員がとどまれるようにするため、LEDライト (ランタンタイプ)、酸素濃度計、二酸化炭素濃度計及び電離箱サーベイメータを配備する。
 中央制御室待避室にとどまり必要な監視等を行うのに必要な照度を有する照明として、LEDライト (ランタンタイプ)を2個配備する。表2.4-5に中央制御室待避室に配備しているLEDライト (ランタンタイプ)を示す。

表 2.4-5 中央制御室待避室に配備するLEDライト (ランタンタイプ)

機器名称及び外観	保管場所	数量	仕様
	中央制御室	2個	電源：乾電池 (単三) 点灯可能時間：約29時間

酸素濃度計及び二酸化炭素濃度計は、中央制御室待避室の居住環境の基準値の範囲を測定できるものを1個配備する。表2.4-6に中央制御室待避室に配備する酸素濃度計及び二酸化炭素濃度計を示す。

表 2.4-6 中央制御室待避室に配備する酸素濃度計及び二酸化炭素濃度計

機器名称及び外観	仕様等										
	<table border="1"> <tr> <td>検知原理</td> <td>ガルバニ式</td> </tr> <tr> <td>検知範囲</td> <td>0.0~25.0vol%</td> </tr> <tr> <td>表示精度</td> <td>±0.5vol%</td> </tr> <tr> <td>電源</td> <td>乾電池 (単三×2本) 測定可能時間：約15,000時間 (乾電池切れの場合、乾電池交換を実施する。)</td> </tr> <tr> <td>個数</td> <td>1個 (故障時及び保守点検による待機除外時のバックアップ用として予備1個を保有する。)</td> </tr> </table>	検知原理	ガルバニ式	検知範囲	0.0~25.0vol%	表示精度	±0.5vol%	電源	乾電池 (単三×2本) 測定可能時間：約15,000時間 (乾電池切れの場合、乾電池交換を実施する。)	個数	1個 (故障時及び保守点検による待機除外時のバックアップ用として予備1個を保有する。)
検知原理	ガルバニ式										
検知範囲	0.0~25.0vol%										
表示精度	±0.5vol%										
電源	乾電池 (単三×2本) 測定可能時間：約15,000時間 (乾電池切れの場合、乾電池交換を実施する。)										
個数	1個 (故障時及び保守点検による待機除外時のバックアップ用として予備1個を保有する。)										
	<table border="1"> <tr> <td>検知原理</td> <td>NDIR (非分散型赤外線)</td> </tr> <tr> <td>検知範囲</td> <td>0~10,000ppm</td> </tr> <tr> <td>表示精度</td> <td>±500ppm</td> </tr> <tr> <td>電源</td> <td>乾電池 (単四×2本) 測定可能時間：約7時間 (乾電池切れの場合、乾電池交換を実施する。)</td> </tr> <tr> <td>個数</td> <td>1個 (故障時及び保守点検による待機除外時のバックアップ用として予備1個を保有する。)</td> </tr> </table>	検知原理	NDIR (非分散型赤外線)	検知範囲	0~10,000ppm	表示精度	±500ppm	電源	乾電池 (単四×2本) 測定可能時間：約7時間 (乾電池切れの場合、乾電池交換を実施する。)	個数	1個 (故障時及び保守点検による待機除外時のバックアップ用として予備1個を保有する。)
検知原理	NDIR (非分散型赤外線)										
検知範囲	0~10,000ppm										
表示精度	±500ppm										
電源	乾電池 (単四×2本) 測定可能時間：約7時間 (乾電池切れの場合、乾電池交換を実施する。)										
個数	1個 (故障時及び保守点検による待機除外時のバックアップ用として予備1個を保有する。)										

： SA 範囲

・設備の相違
 【柏崎6/7】
 ①の相違
 ・資機材の相違
 【柏崎6/7, 東海第二】
 島根2号炉はLEDランタン2個を配備し監視に必要な照度を確保する
 ・設備の相違
 【柏崎6/7】
 ①の相違
 ・設備の相違
 【柏崎6/7, 東海第二】
 島根2号炉は酸素濃度計及び二酸化炭素濃度計を各2個(うち1個は予備)配備する

柏崎刈羽原子力発電所 6/7号炉 (2017.12.20)	東海第二発電所 (2018.9.18版)	島根原子力発電所 2号炉	備考
<p>2.5 重大事故等時の電源設備について</p> <p>中央制御室には、炉心の著しい損傷が発生した場合においても運転員がとどまるために必要な設備(図2.5-1に示す空調及び図2.5-2に示す照明)を設置している。これらの設備については、重大事故等が発生した場合にも、図2.5-3に示すとおり常設代替交流電源設備である第一ガスタービン発電機(以下、単に「ガスタービン発電機」という)からの給電が可能な設計とする。</p> <p>ガスタービン発電機の容量は、中央制御室の居住性(炉心の著しい損傷)に係る被ばく評価で想定する格納容器破損モードのうち、中央制御室の運転員の被ばくの観点から結果が最も厳しくなる事故収束に成功した事故シーケンスとして、<u>冷却材喪失時に非常用炉心冷却系の機能及び全交流動力電源が喪失(以下、大LOCA+注水機能喪失+全交流動力電源喪失)</u>に対して、表2.5-1に示すとおり十分な電源供給容量を確保している。</p> <p>照明については、全交流動力電源喪失発生からガスタービン発電機による給電が開始されるまでの間、図2.5-4に示す<u>直流非常灯</u>に加え、<u>12時間以上無電源で点灯する蓄電池内蔵型照明</u>を配備しており、ガスタービン発電機から給電を再開するまでの間(事故発生後70分以内)の照明は確保できる。</p> <p>ガスタービン発電機による給電が開始された後については、<u>中央制御室内の非常用照明</u>にて照明は確保できる。なお、中央制御室の全照明が消灯した場合には、<u>可搬型蓄電池内蔵型照明</u>により、必要な照度を確保可能な設計とする。</p> <p>また、運転員のシミュレーション訓練において全交流動力電源喪失を想定した訓練により、<u>直流非常灯</u>下で対応操作ができることを確認しているとともに、<u>中央制御室内の非常用照明</u>が使用できない場合にも必要な照度を確保できるよう、<u>可搬型蓄電池内蔵型照明</u>を配備する。仮にこれら照明が活用できない場合のため、<u>ランタンタイプLEDライト</u>、<u>ヘッドライト等の乾電池内蔵型照明</u>を中央制御室に備えており、それらも活用した訓練を実施している。</p> <p>空調については、ガスタービン発電機が起動するまでの間は起動しないが、被ばく評価において、<u>必要な居住性が確保</u>されていることを確認している。</p>	<p>2.5 重大事故等時の電源設備について</p> <p>中央制御室には、重大事故等が発生した場合においても運転員がとどまるために必要な設備(第2.5-1図に示す換気設備及び第2.5-2図に示す照明設備)を設置している。これらの設備については、重大事故等時においても、第2.5-3図に示すとおり、常設代替交流電源設備である常設代替高圧電源装置からの給電を可能とする。</p> <p>常設代替高圧電源装置の容量は、中央制御室の居住性(重大事故等)に係る被ばく評価で想定する格納容器破損モードのうち、中央制御室の運転員の被ばくの観点から結果が最も厳しくなる事故収束に成功した事故シーケンスである「<u>大破断LOCA+高圧炉心冷却失敗+低圧炉心冷却失敗</u>」に全交流動力電源喪失の重畳を考慮した場合に対して、第2.5-1表に示すとおり、十分な電源供給容量を確保する。</p> <p>照明については、全交流動力電源喪失発生から常設代替高圧電源装置による給電が開始されるまでの間、第2.5-4図に示す<u>直流非常灯</u>に加え、<u>12時間以上無充電で点灯する可搬型照明(SA)</u>を配備しており、常設代替高圧電源装置から給電を再開するまでの間(事故発生後95分以内)の照明を確保する。</p> <p>常設代替高圧電源装置による給電が開始された後については、中央制御室内の非常用照明にて照明は確保できる。一方、中央制御室の全照明が消灯した場合には、常設代替高圧電源装置から給電する可搬型照明(SA)により、必要な照度を確保する。</p> <p>また、中央制御室内の非常用照明が使用できない場合にも必要な照度を確保できるように、可搬型照明(SA)を配備する。仮に、これらの照明が活用できない場合のため、ランタン、ヘッドライト等の乾電池内蔵型照明を中央制御室に保管する。</p> <p>換気設備は、常設代替高圧電源装置が起動するまでの間は起動しないが、居住性に係る被ばく評価においては、中央制御室換気系及び原子炉建屋ガス処理系の起動操作時間を考慮し、全交流動力電源喪失後、2時間後に起動することを条件として評価しており、居住性を確保できることを確認している。</p>	<p>2.5 重大事故等時の電源設備について</p> <p>中央制御室には、炉心の著しい損傷が発生した場合においても運転員がとどまるために必要な設備(図2.5-1に示す空調及び図2.5-2に示す照明)を設置している。これらの設備については、重大事故等が発生した場合にも、図2.5-3に示すとおり常設代替交流電源設備であるガスタービン発電機からの給電を可能とする。</p> <p>ガスタービン発電機の容量は、中央制御室の居住性(炉心の著しい損傷)に係る被ばく評価で想定する格納容器破損モードのうち、中央制御室の運転員の被ばくの観点から結果が最も厳しくなる事故収束に成功した事故シーケンスである「<u>冷却材喪失(大破断LOCA)+ECCS注水機能喪失+全交流動力電源喪失</u>」に対して、表2.5-1に示すとおり十分な電源供給容量を確保している。</p> <p>照明については、全交流動力電源喪失発生からガスタービン発電機による給電が開始されるまでの間、図2.5-4に示す<u>直流非常灯</u>に加え、<u>満充電から4.5時間無充電で点灯するLEDライト(三脚タイプ)</u>を配備しており、ガスタービン発電機から給電を再開するまでの間(事故発生後70分以内)の照明は確保できる。</p> <p>ガスタービン発電機による給電が開始された後については、<u>非常用照明</u>にて照明は確保できる。一方、中央制御室の全照明が消灯した場合には、ガスタービン発電機から給電する<u>LEDライト(三脚タイプ)</u>により必要な照度を確保する。</p> <p>また、中央制御室内の<u>非常用照明</u>及び<u>直流非常灯</u>が使用できない場合にも必要な照度を確保できるよう、<u>LEDライト(三脚タイプ)</u>を配備する。仮にこれら照明が活用できない場合のため、<u>LEDライト(ランタンタイプ)</u>及び<u>ヘッドライト</u>を中央制御室に備えており、それらも活用した訓練を実施している。</p> <p>換気設備は、ガスタービン発電機が起動するまでの間は起動しないが、居住性に係る被ばく評価においては、中央制御室換気系の起動時間を考慮し、全交流動力電源喪失後2時間後に起動することを条件として評価しており、居住性を確保できることを確認している。</p>	<p>備考</p> <p>・設備の相違</p> <p>【柏崎6/7,東海第二】 島根2号炉は直流非常灯,電源内蔵型照明,LEDライト(三脚タイプ)により停電中の必要な照度を確保可能。また,LEDライト(三脚タイプ)は常設代替電源設備から受電可能である</p>
<p style="text-align: right;">□ : SA範囲</p>	<p style="text-align: right;">□ : SA範囲</p>	<p style="text-align: right;">□ : SA範囲</p>	



図 2.5-1 中央制御室空調設備の概要 (重大事故等時)

： SA 範囲

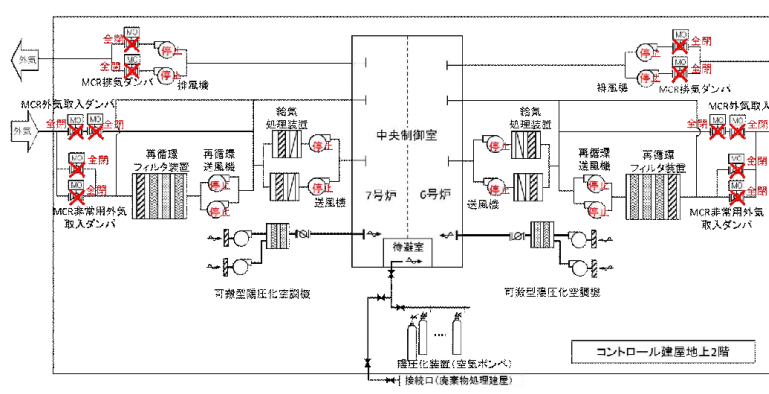
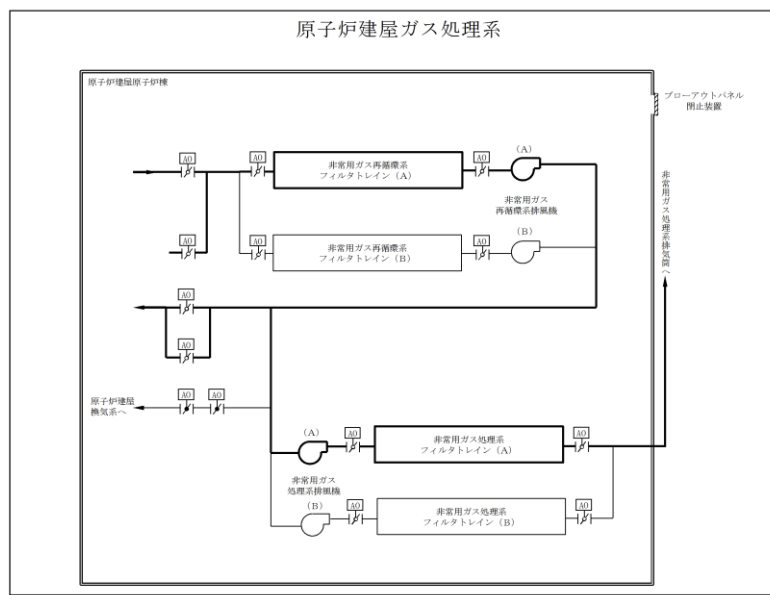
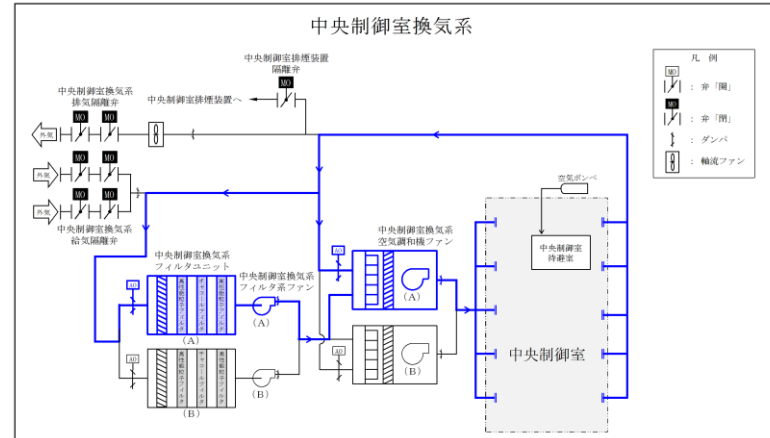

第 2.5-1 図 重大事故等時に運転員がとどまるために必要な換気設備

： SA 範囲



図 2.5-1 中央制御室換気系の概要 (重大事故発生時, プルーフ通過前後)

： SA 範囲

・設備の相違
【柏崎 6/7, 東海第二】

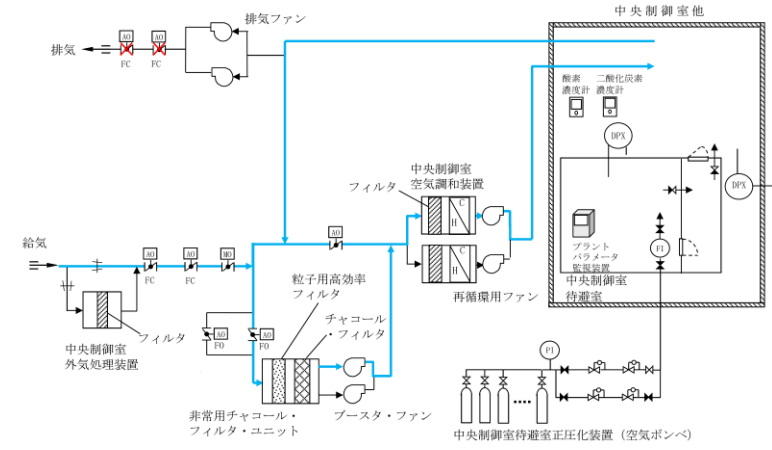

図 2.5-2 中央制御室照明設備の概要

: SA範囲

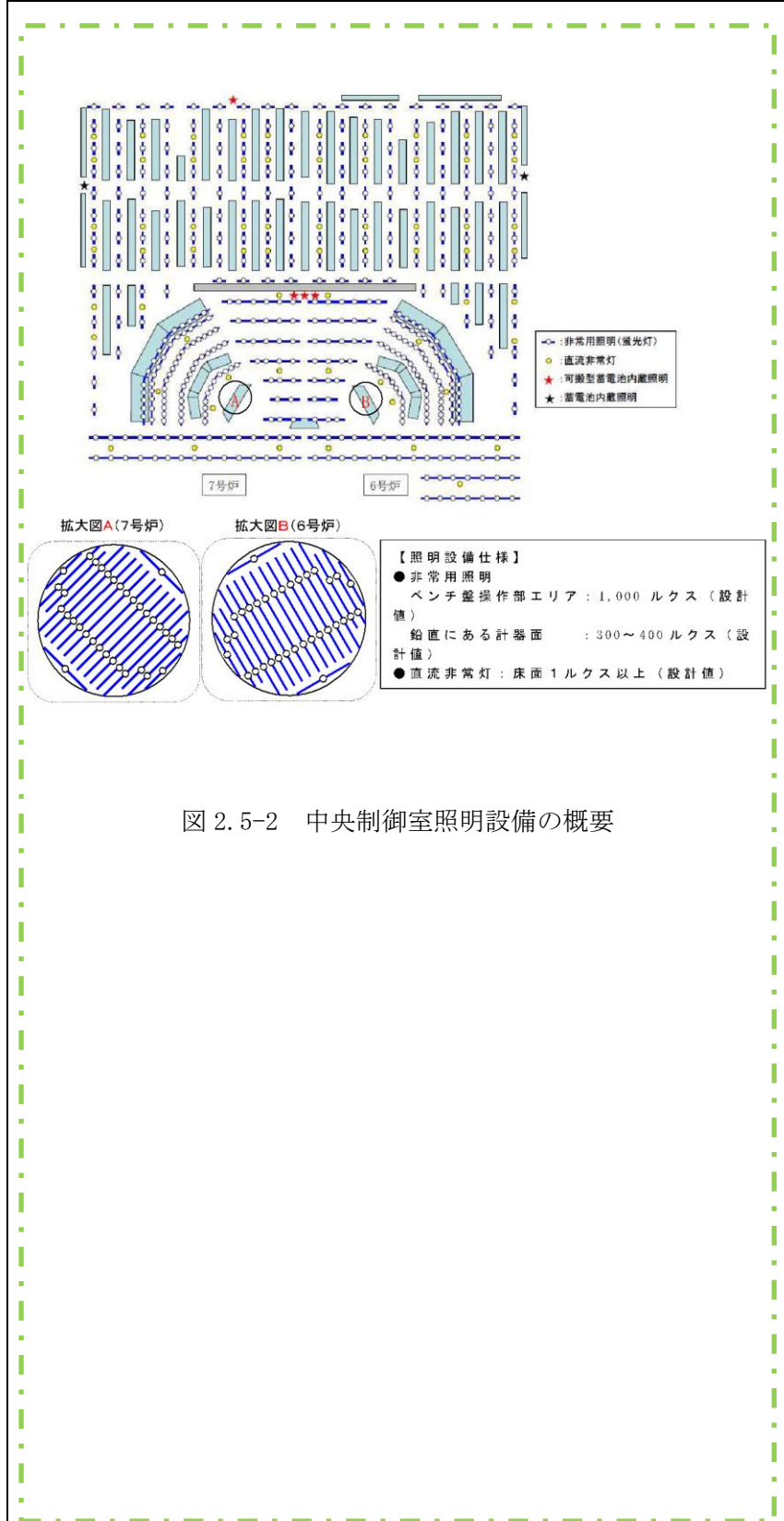

第 2.5-2 図 中央制御室照明設備の概要

: SA範囲



図 2.5-2 中央制御室照明設備の概要

: SA範囲

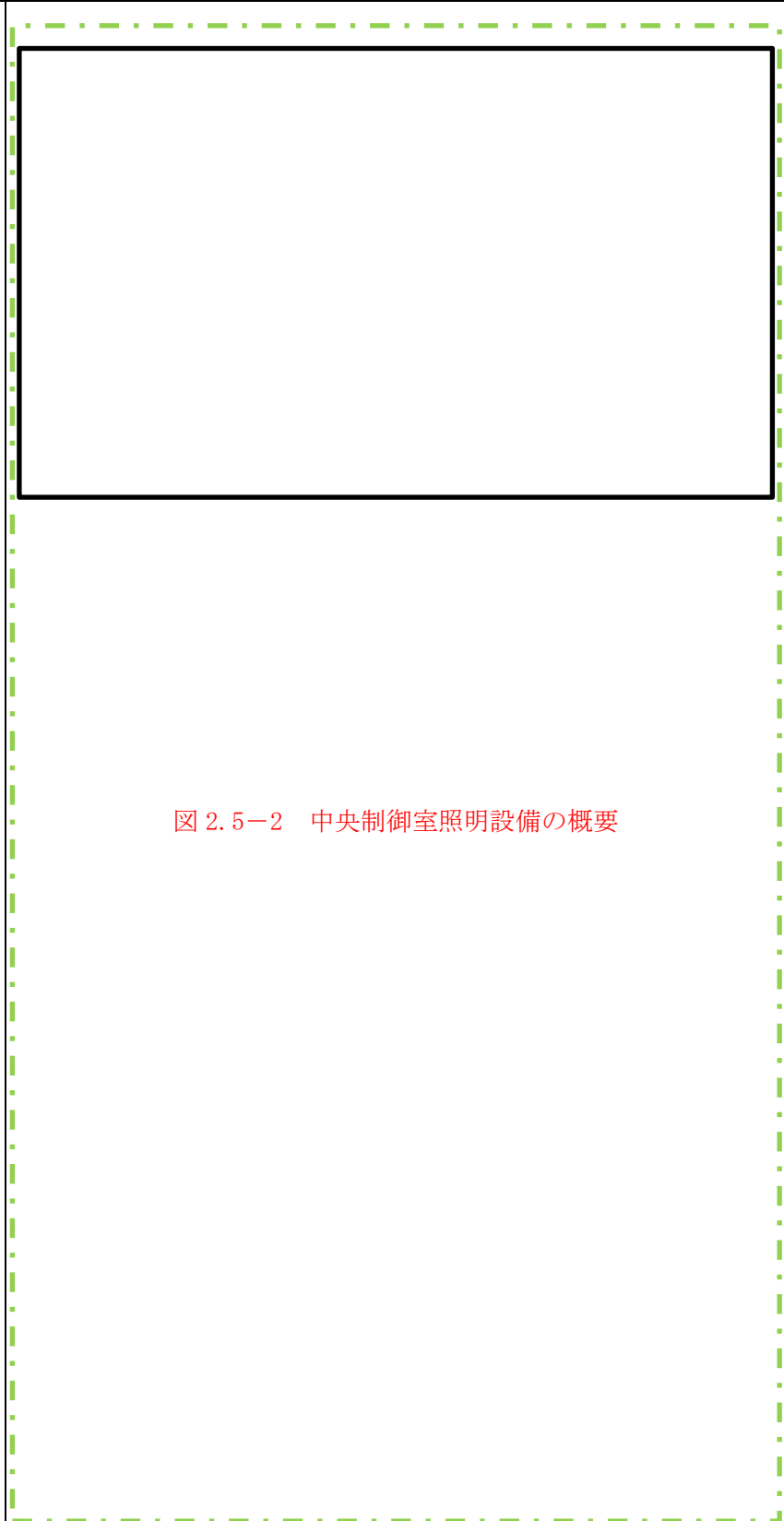

図 2.5-3 6号炉中央制御室 給電系統概要図 (重大事故等時)

: SA範囲

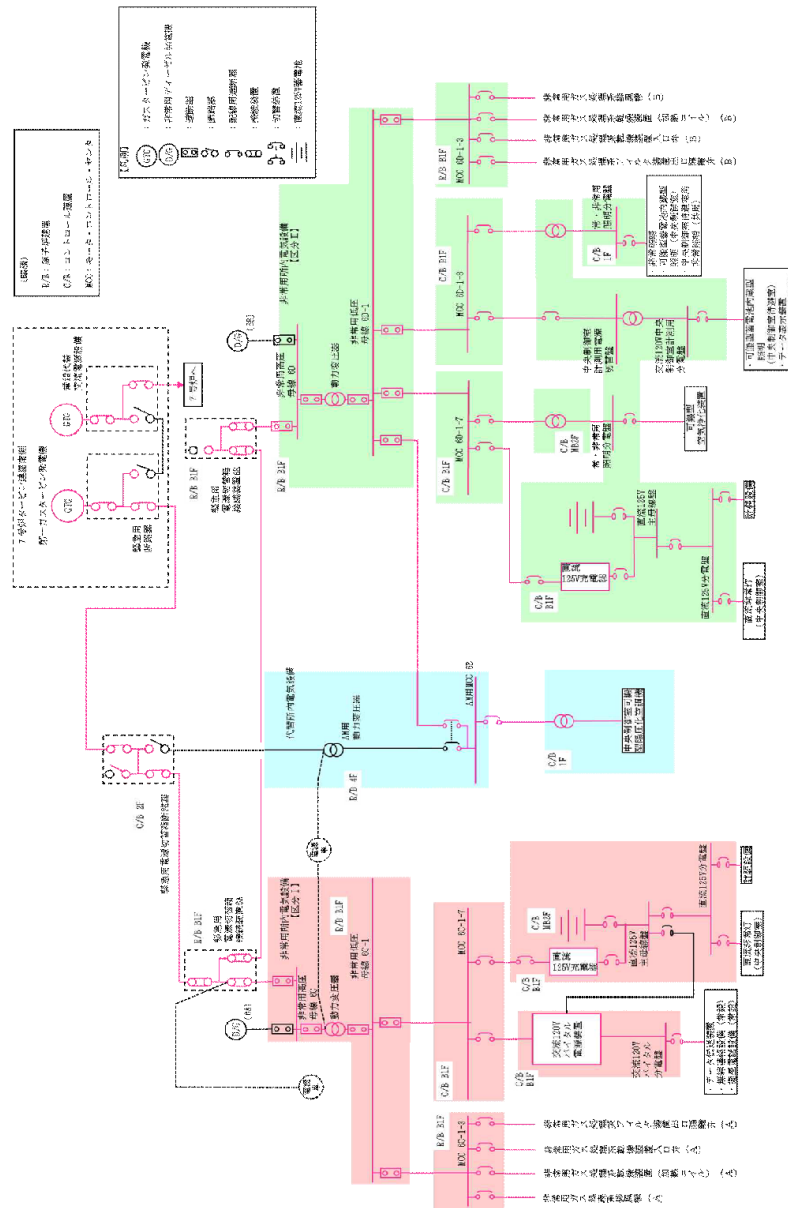
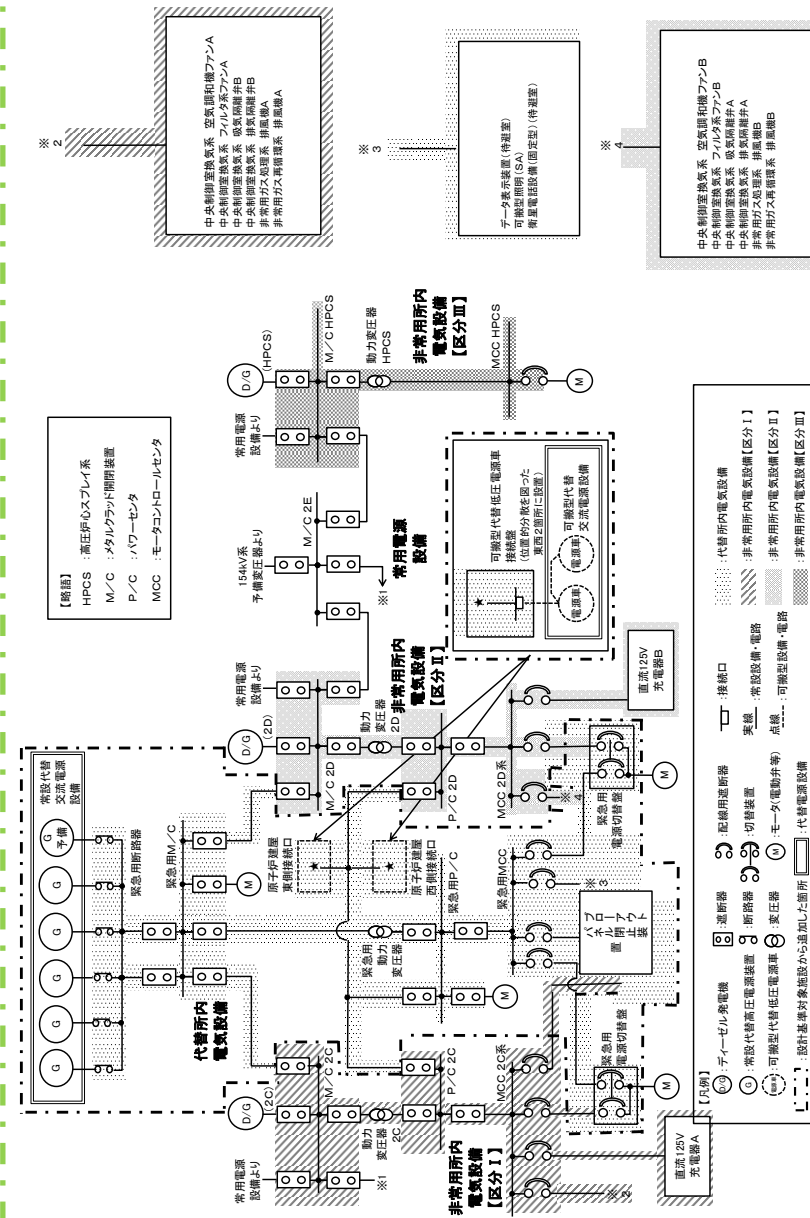

第 2.5-3 図 中央制御室 給電系統概要図 (重大事故等時)

: SA範囲



図 2.5-3 常設代替交流電源構成図

: SA範囲

・設備の相違
【柏崎 6/7, 東海第二】

柏崎刈羽原子力発電所 6 / 7号炉 (2017. 12. 20)

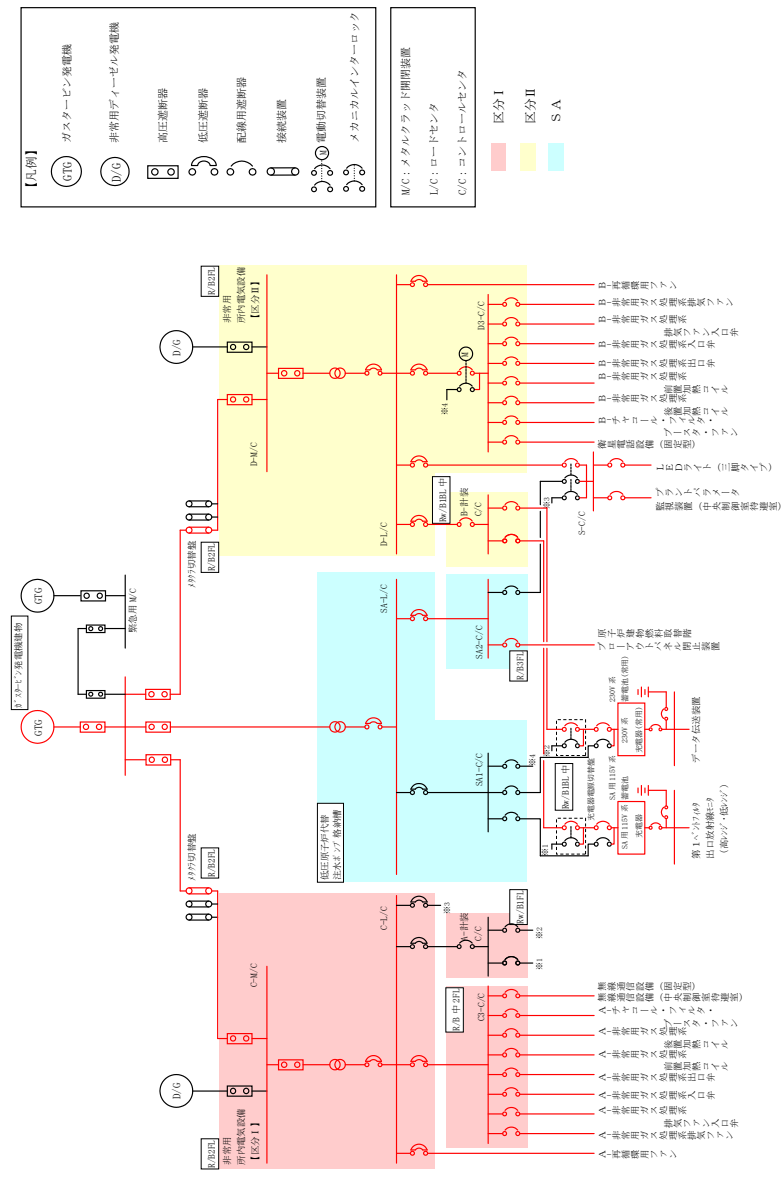
東海第二発電所 (2018. 9. 18 版)

島根原子力発電所 2号炉

備考



図 2.5-4 7号炉中央制御室 給電系統概要図 (重大事故等時)

： S A 範囲

・ 申請号炉数の相違
【柏崎 6/7】

柏崎刈羽原子力発電所 6/7号炉 (2017.12.20)

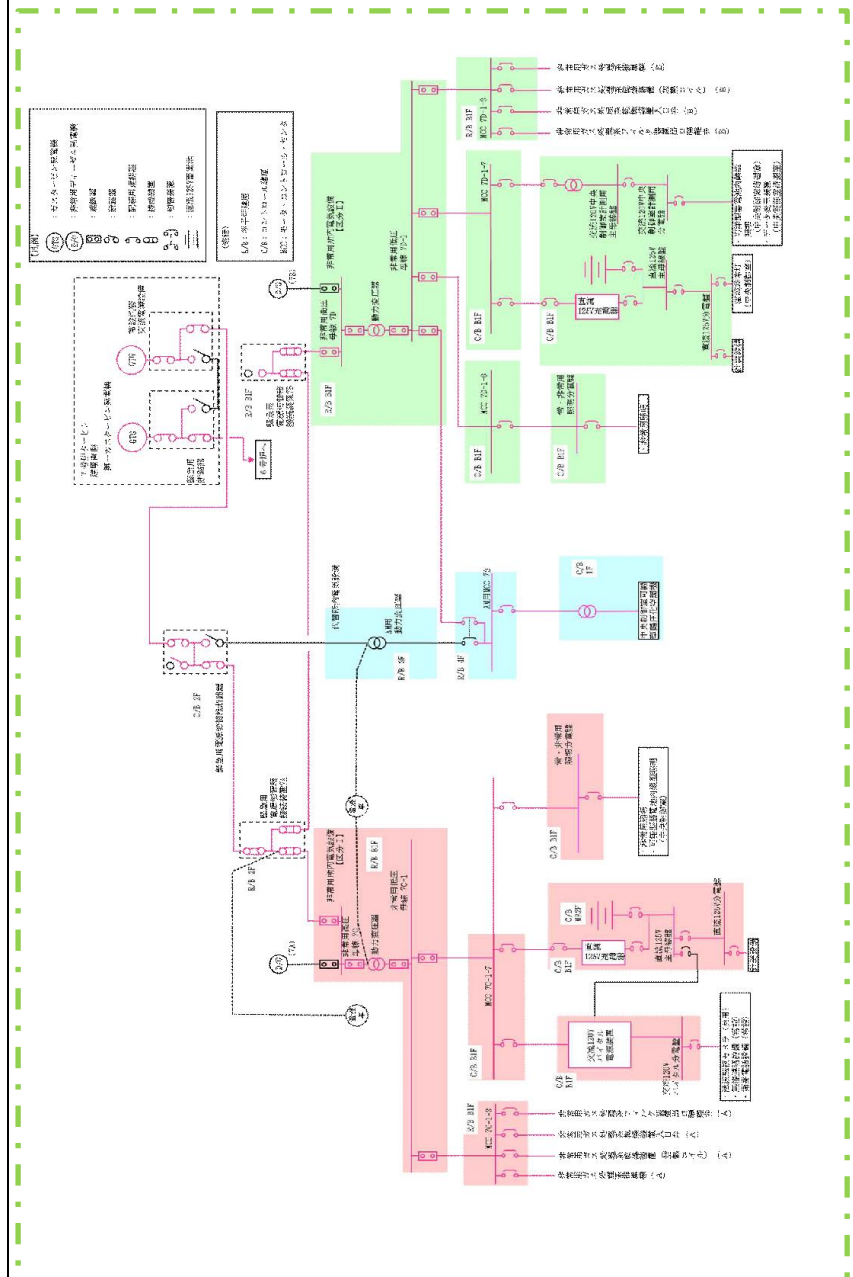
表 2.5-1 ガスタービン発電機(連続定格容量 2,950kW)の最大所要負荷

負荷	6号炉	7号炉
(1) 中央制御室可搬型陽圧化空調機	3kW	3kW
(2) 交流 120V 中央制御室計測用分電盤 A, B 非常用照明	約 100kW	約 100kW
(3) 直流 125V 充電器盤 A	約 94kW	約 94kW
(4) 直流 125V 充電器盤 A-2	約 56kW	約 56kW
(5) AM 用直流 125V 充電器盤	約 41kW	約 41kW
(6) 直流 125V 充電器盤 B	約 98kW	約 98kW
(7) 復水移送ポンプ (2台)	110kW	110kW
(8) 残留熱除去系ポンプ※	540kW	540kW
(9) 燃料プール冷却浄化ポンプ	90kW	110kW
(9) 非常用ガス処理系排風機等	約 37kW	約 20kW
(10) その他機器	約 111kW	約 114kW
小計	約 1,280kW	約 1,286kW
計	約 2,566kW	

※「大LOCA+注水機能喪失+全交流動力電源喪失」において不要であるが、保守的に容量としては見込む。なお、電源車からの給電時は不要である。



(通常点灯状態) (直流非常灯照明点灯状態)

図 2.5-5 非常灯照明下で中央制御室の状況

○ : SA 範囲

東海第二発電所 (2018.9.18 版)

第 2.5-1 表 常設代替高圧電源装置 (連続定格容量 5,520kW) の所要負荷

負荷	負荷容量
① 緊急用母線自動起動負荷 ・緊急用直流125V充電器 ・その他負荷	約 217kW
② 常設低圧代替注水系ポンプ	約 190kW
③ 常設低圧代替注水系ポンプ	約 190kW
④ 非常用母線 2 C 自動起動負荷 ・直流125V充電器 A ・非常用照明 ・120/240V計装用主母線盤 2 A ・その他負荷	約 569kW
⑤ 非常用母線 2 D 自動起動負荷 ・直流125V充電器 B ・非常用照明 ・120/240V計装用主母線盤 2 B ・その他負荷	約 415kW
⑥ 非常用ガス再循環系排風機 非常用ガス処理系排風機 その他負荷	約 106kW
⑦ 中央制御室換気系空調和機ファン 中央制御室換気系フィルタ系ファン その他負荷	約 236kW
⑧ 蓄電池室排気ファン その他負荷	約 162kW
⑨ ほう酸水注入ポンプ	約 37kW
⑩ 緊急用海水ポンプ その他負荷	約 514kW
⑪ 代替燃料プール冷却系ポンプ	約 30kW
計	約 2,666kW



(通常点灯状態) (直流非常灯点灯状態)

第 2.5-4 図 非常灯照明下での中央制御室の状況

○ : SA 範囲

島根原子力発電所 2号炉

表 2.5-1 ガスタービン発電機 (4,800kW (6,000kVA)) の最大所要負荷

起動順序	主要機器	負荷容量 (kW)
①	ガスタービン発電機付帯設備	約 111
②	代替所内電気設備負荷 (自動投入負荷)	約 18
③	低圧原子炉代替注水ポンプ	約 210
④	低圧原子炉代替注水設備非常用送風機	約 15
⑤	充電器, 非常用照明, 非常用ガス処理系他 (D系高圧母線自動投入負荷)	約 512
⑥	格納容器水素濃度 (SA), 格納容器酸素濃度 (SA) 監視設備	約 20
⑦	A-中央制御室送風機	約 180
⑧	A-中央制御室非常用再循環送風機	約 30
⑨	A-中央制御室冷凍機	約 300
⑩	充電器, 非常用照明, 非常用ガス処理系他 (C系高圧母線自動投入負荷)	約 329
⑪	A-淡水ポンプ (移動式代替熱交換設備)	約 110
⑫	B-淡水ポンプ (移動式代替熱交換設備)	約 110
⑬	B-燃料プール冷却水ポンプ	約 110
	計	約 2,055

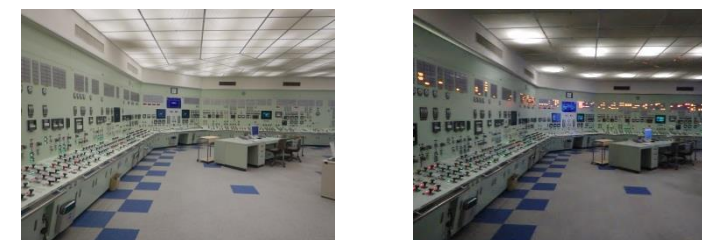

(通常点灯状態) (直流非常灯点灯状態)

図 2.5-4 直流非常灯照明下での中央制御室のイメージ (シミュレータの点灯例)

○ : SA 範囲

備考
・設備の相違
【柏崎 6/7, 東海第二】
島根 2 号炉の最も厳しい事故シーケンスに対する電源供給量を適用

(1) 可搬型蓄電池内蔵型照明を用いた場合の監視操作について

中央制御室の照明が全て消灯した場合に使用する可搬型蓄電池内蔵型照明は、6号及び7号炉にて3台使用する設計とする。数量はシミュレーション施設を用いて、監視操作に必要な照度を確保できることを確認のうえ決定している。可搬型蓄電池内蔵型照明を操作箇所に応じて向きを変更することにより、さらに照度を確保できることを確認している。

仮に可搬型蓄電池内蔵型照明が活用できない場合のため、乾電池内蔵型照明を中央制御室に備えており、それらも活用した訓練を実施している。

表2.5-2に中央制御室に配備している可搬型蓄電池内蔵型照明及び乾電池内蔵型照明の概要を示す。

表 2.5-2 中央制御室に配備している可搬型蓄電池内蔵型照明及び乾電池内蔵型照明

機器名称及び外観	保管場所	数量	仕様
	中央制御室	3台 (予備1台)	・定格電圧：交流100V ・点灯可能時間：12時間以上
	中央制御室	20台 (6号炉、7号炉共用) (中央制御室対応として 中央制御室主盤+17.5台 +中央制御室裏盤+3.710台 +中央制御室待避室2台 +予備3台)	電源：乾電池 (単三×3) 点灯可能時間：約12時間 (消灯した場合、予備を点灯させ、乾電池交換を実施する。) ※乾電池内蔵型照明はバッテリー給電方式であることから発電設備の状況に依らず活用可能であるが、代替交流電源からの給電が可能な設計となっていないことから自主配備の資機材として位置づける。
	中央制御室	4台 (6号炉、7号炉共用) (ランタンタイプLEDの補助)	電源：乾電池 (単三×6) 点灯可能時間：約30時間 ※乾電池内蔵型照明はバッテリー給電方式であることから発電設備の状況に依らず活用可能であるが、代替交流電源からの給電が可能な設計となっていないことから自主配備の資機材として位置づける。
	中央制御室	100台 (6号炉及び7号炉の運転員全員に配備)	電源：乾電池 (単三×1) 点灯可能時間：約8時間 (管区区域での作業可能な10時間点灯できるように予備乾電池を持参する。) ※乾電池内蔵型照明はバッテリー給電方式であることから発電設備の状況に依らず活用可能であるが、代替交流電源からの給電が可能な設計となっていないことから自主配備の資機材として位置づける。

 : SA範囲

(1) 可搬型照明 (SA)を用いた場合の監視操作について

中央制御室の照明が全て消灯した場合に使用する可搬型照明 (SA) は、3個使用する。個数は、シミュレーション施設を用いて監視操作に必要な照度を確保できることを確認している。操作箇所に応じて可搬型照明 (SA) の向きを変更することにより、更に照度を確保できることを確認している。

仮に可搬型照明 (SA) が活用できない場合のため、乾電池内蔵型照明を中央制御室に保管する。

第2.5-2表に中央制御室に配備している可搬型照明 (SA) 及び乾電池内蔵型照明の概要を示す。

第2.5-2表 中央制御室に配備している可搬型照明 (SA) 及び乾電池内蔵型照明の概要

名称及び外観	保管場所	数量	仕様
	中央制御室	3個 (予備1個(中央制御室待避室の予備1個と共用))	(AC) 100V-240V 点灯時間： 片面 20~24時間 両面 10~12時間
	中央制御室	16個 (予備4個)	電池：単一電池4本 点灯時間：約45時間
	中央制御室	7個 (予備7個)	電池：単三電池3本 点灯時間：約12時間

 : SA範囲

(1) LEDライト (三脚タイプ)を用いた場合の監視操作について

中央制御室の照明が全て消灯した場合に使用するLEDライト (三脚タイプ) は、2個使用する。個数はシミュレーション施設を用いて監視操作に必要な照度を確保できることを確認している。LEDライト (三脚タイプ) を操作箇所に応じて向きを変更することにより、さらに照度を確保できることを確認している。

仮にLEDライト (三脚タイプ) が活用できない場合のため、LEDライト (ランタンタイプ) 及びヘッドライトを中央制御室に備えており、それらも活用した訓練を実施している。

表2.5-2に中央制御室に配備しているLEDライト (三脚タイプ)、LEDライト (ランタンタイプ) 及びヘッドライトの概要を示す。

表 2.5-2 中央制御室に配備しているLEDライト (三脚タイプ)、LEDライト (ランタンタイプ) 及びヘッドライト

機器名称及び外観	保管場所	数量	仕様
	中央制御室 前通路	3個 (中央制御室主盤エリア2個+予備1個)	電源：蓄電池 点灯可能時間： 4.5時間以上
	中央制御室	12個 (中央制御室対応として中央制御室執務机6個+中央制御室待避室2個+予備4個)	電源：乾電池 (単三×3) 点灯可能時間： 約29時間 ※連続して作業可能なように予備乾電池を持参する。
	中央制御室	11個 (当直運転員分7個+予備4個)	電源：乾電池 (単四×3) 点灯可能時間： 約20時間 ※連続して作業可能なように予備乾電池を持参する。

 : SA範囲

・申請号炉数及び資機材の相違

【柏崎6/7, 東海第二】
島根2号炉は仮にLEDライト (三脚タイプ) が活用できない場合のためLEDライト (ランタンタイプ) 及びヘッドライトを配備し活用訓練を行っている

柏崎刈羽原子力発電所 6/7号炉 (2017.12.20)	東海第二発電所 (2018.9.18版)	島根原子力発電所 2号炉	備考
-------------------------------	----------------------	--------------	----

可搬型蓄電池内蔵型照明の照度は、図2.5-6 に示すとおり大型表示盤から約15mの机位置に設置した場合で、直流照明の設計値である照度（1ルクス）に対し、大型表示盤表面で約20ルクスの照度を確認し、監視操作が可能なことを確認している。



(※貼付画像については、印刷仕上がり時に照明確認時点と同様の雰囲気となるよう補正を施してあります。)



図 2.5-6 シミュレーション施設における可搬型蓄電池内蔵型照明確認状況

○ : SA範囲

可搬型照明（SA）の照度は、第2.5-5図に示すとおり、主制御盤から約6mの位置に設置した場合で、直流照明の実測値である照度（20ルクス以上）に対し、室内照明全消灯状態にて主制御盤垂直部平均で約20ルクス以上の照度を確認し、監視操作が可能なことを確認している。

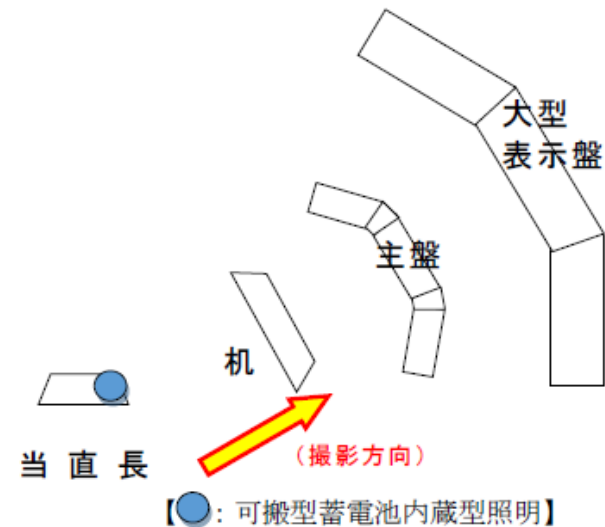

画像については、印刷仕上がり時に照明確認時点と同様の雰囲気となるよう補正を施してあります。

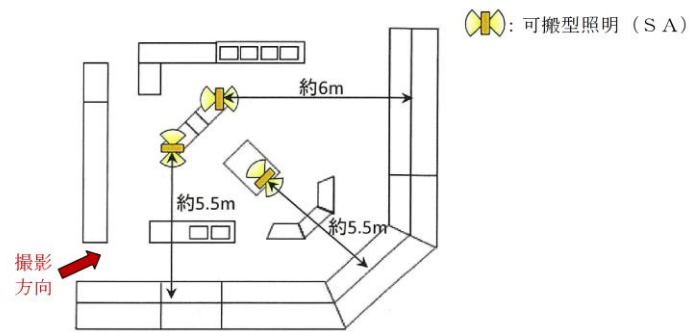

第 2.5-5 図 シミュレーション施設における可搬型照明（SA）確認状況

○ : SA範囲

LEDライト（三脚タイプ）の照度は、図2.5-5に示すとおり、制御盤から約2mの位置に設置した場合で、直流非常灯の設計値である照度（ベンチ盤操作部エリア：50ルクス）に対し、室内照明全消灯状態にて操作を行う盤面で50ルクス以上の照度を確認し、監視操作が可能なことを確認している。



図 2.5-5 シミュレーション施設におけるLEDライト（三脚タイプ）確認状況

○ : SA範囲

・設備の相違
【柏崎6/7, 東海第二】
島根2号炉ではシミュレーション施設により監視操作が可能なことを確認している

柏崎刈羽原子力発電所 6/7号炉 (2017.12.20)	東海第二発電所 (2018.9.18版)	島根原子力発電所 2号炉	備考
<p>同様に、重大事故等対処のための追加安全対策設備等を配置した裏盤について、図2.5-7に示すとおり可搬型蓄電池内蔵型照明の照度は盤から約1mの位置に設置した場合で、制御盤表面で約10ルクスの照度を確認し、監視操作が可能であることを確認している。</p>	<p>中央制御室の照明が全て消灯した場合、裏盤についての監視操作は、乾電池内蔵型照明を運転員が装着して行う。(第2.5-6図参照)</p> <p>乾電池内蔵型照明の照度は、室内照明全消灯時に運転員が装着した状態で、直流照明の実測値である照度(20ルクス以上)に対し、監視計器及び操作部で600ルクス以上の照度を確保し、監視操作が可能であることを確認している。</p>	<p>重大事故等対処のための追加安全対策設備の制御盤は、中央制御室内の制御盤エリアに配置されており、制御盤と同程度の照度が確保される。図2.5-6に示すとおりLEDライト(三脚タイプ)の照度は盤から約1mの位置に設置した場合で盤表面で330ルクスの照度を確保し監視操作が可能であることを確認している。</p>	<p>備考</p> <ul style="list-style-type: none"> ・制御盤配置の相違 【柏崎6/7,東海第二】 島根2号炉ではSA操作盤は制御盤エリアに配置され制御盤エリアと同等の照度が確保されている
			
<p>(※貼付画像については、印刷仕上がり時に照明確認時点と同様の雰囲気となるよう補正を施してあります。)</p>	<p>(シミュレーション施設におけるヘッドライト使用状況)</p>	<p>(LEDライト(三脚タイプ)使用状況)</p>	
 <p>【●: 可搬型蓄電池内蔵型照明】</p>  <p>(上記撮影を逆方向から撮影、右端が照明設備)</p>	<p>第2.5-6図 乾電池内蔵型照明使用イメージ</p>	<p>図2.5-6 LEDライト(三脚タイプ)使用イメージ</p>	
<p>図2.5-7 裏盤における可搬型蓄電池内蔵型照明確認状況</p> <p style="text-align: right;">: SA範囲</p>	<p style="text-align: right;">: SA範囲</p>	<p style="text-align: right;">: SA範囲</p>	

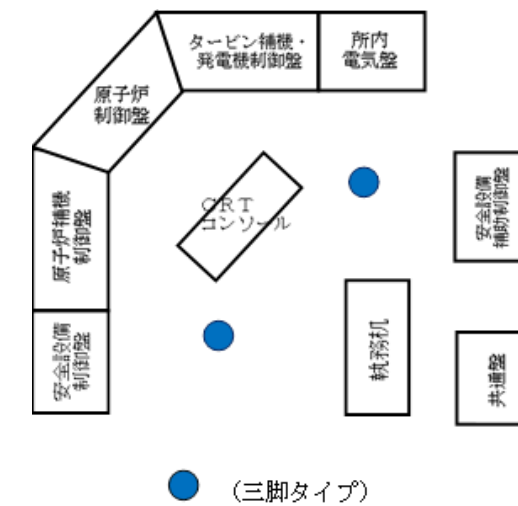
柏崎刈羽原子力発電所 6/7号炉 (2017.12.20)	東海第二発電所 (2018.9.18版)	島根原子力発電所 2号炉	備考																		
<p>3. 添付資料</p> <p>3.1 中央制御室待避室の運用について</p> <p>原子炉格納容器圧力逃がし装置作動前から作動後にわたっての、中央制御室待避室の運用を以下にまとめる。図3.1-1に原子炉格納容器圧力逃がし装置作動と中央制御室及び中央制御室待避室換気空調設備の運用の概要を示す。</p> <p>(1) 原子炉格納容器圧力逃がし装置作動前（待避前）</p> <p>運転員等は炉心の著しい損傷が発生した場合において、原子炉格納容器圧力逃がし装置を作動させる必要があると判断された場合、中央制御室待避室を使用するため、以下設備、資機材の運用準備を行う。</p> <p>表 3.1-1 中央制御室待避室の運用準備</p> <table border="1" data-bbox="172 892 878 1285"> <tr> <td>居住性設備</td> <td>・可搬型陽圧化空調機を用いることにより、中央制御室パウダリ全体が陽圧化されていること ・中央制御室待避室の遮蔽設備の設置 ・中央制御室待避室の空調隔離ダンパの閉止 ・中央制御室待避室の酸素濃度・二酸化炭素濃度計、可搬型エリアモニタの配置、電源入 ・陽圧化装置による中央制御室待避室の加圧</td> </tr> <tr> <td>監視設備</td> <td>・6号炉、7号炉のデータ表示装置（待避室）電源入</td> </tr> <tr> <td>通信連絡設備</td> <td>・現場要員や緊急時対策所との通信連絡のための、6号炉、7号炉各々の無線連絡設備（常設）、衛星電話設備（常設）の準備（通話確認）</td> </tr> </table>	居住性設備	・可搬型陽圧化空調機を用いることにより、中央制御室パウダリ全体が陽圧化されていること ・中央制御室待避室の遮蔽設備の設置 ・中央制御室待避室の空調隔離ダンパの閉止 ・中央制御室待避室の酸素濃度・二酸化炭素濃度計、可搬型エリアモニタの配置、電源入 ・陽圧化装置による中央制御室待避室の加圧	監視設備	・6号炉、7号炉のデータ表示装置（待避室）電源入	通信連絡設備	・現場要員や緊急時対策所との通信連絡のための、6号炉、7号炉各々の無線連絡設備（常設）、衛星電話設備（常設）の準備（通話確認）	<p>3. 添付資料</p> <p>3.1 中央制御室待避室の運用について</p> <p>格納容器圧力逃がし装置作動前から作動後にわたる中央制御室待避室の運用を以下にまとめる。第3.1-1図に格納容器圧力逃がし装置作動並びに中央制御室及び中央制御室待避室における換気設備の運用の概要を示す。</p> <p>(1) 格納容器圧力逃がし装置作動前（待避前）</p> <p>発電長等は、重大事故等時において、格納容器圧力逃がし装置を作動させる必要があると判断された場合、中央制御室待避室を使用するため、第3.1-1表に示す設備及び資機材の運用準備を行う。</p> <p>第3.1-1表 中央制御室待避室の運用準備</p> <table border="1" data-bbox="940 865 1685 1199"> <tr> <td>居住性対策設備</td> <td>・中央制御室待避室空気ボンベユニットによる中央制御室待避室の加圧 ・酸素濃度計、二酸化炭素濃度計及び可搬型照明（SA）の配置及び電源入</td> </tr> <tr> <td>監視設備</td> <td>・データ表示装置（待避室）の配置及び電源入</td> </tr> <tr> <td>通信連絡設備</td> <td>・通信連絡設備の切替及び通話確認</td> </tr> </table>	居住性対策設備	・中央制御室待避室空気ボンベユニットによる中央制御室待避室の加圧 ・酸素濃度計、二酸化炭素濃度計及び可搬型照明（SA）の配置及び電源入	監視設備	・データ表示装置（待避室）の配置及び電源入	通信連絡設備	・通信連絡設備の切替及び通話確認	<p>3. 添付資料</p> <p>3.1 中央制御室待避室の運用について</p> <p>格納容器フィルタベント系作動前から作動後にわたっての中央制御室待避室の運用を以下にまとめる。図3.1-1に格納容器フィルタベント系作動と中央制御室換気系及び中央制御室待避室正圧化装置の運用の概要を示す。</p> <p>(1) 格納容器フィルタベント系作動前（待避前）</p> <p>運転員等は炉心の著しい損傷が発生した場合において、格納容器フィルタベント系を作動させる必要があると判断された場合、中央制御室待避室を使用するため、表3.1-1に示す設備、資機材の運用準備を行う。</p> <p>表 3.1-1 中央制御室換気系運転モード切替操作及び中央制御室待避室の運用準備</p> <table border="1" data-bbox="1730 907 2487 1451"> <tr> <td>居住性対策設備</td> <td>・中央制御室換気系運転モードの加圧運転から系統隔離運転への切替 ・中央制御室待避室の酸素濃度計、二酸化炭素濃度計、電離箱サーベイ・メータの配置、準備 ・中央制御室待避室正圧化装置による中央制御室待避室の加圧</td> </tr> <tr> <td>監視設備</td> <td>・プラントパラメータ監視装置（中央制御室待避室）の電源入</td> </tr> <tr> <td>通信連絡設備</td> <td>・現場運転員や緊急時対策要員との通信連絡のための無線通信設備（固定型）の準備（通話確認）</td> </tr> </table>	居住性対策設備	・中央制御室換気系運転モードの加圧運転から系統隔離運転への切替 ・中央制御室待避室の酸素濃度計、二酸化炭素濃度計、電離箱サーベイ・メータの配置、準備 ・中央制御室待避室正圧化装置による中央制御室待避室の加圧	監視設備	・プラントパラメータ監視装置（中央制御室待避室）の電源入	通信連絡設備	・現場運転員や緊急時対策要員との通信連絡のための無線通信設備（固定型）の準備（通話確認）	<p>備考</p> <p>・設備の相違 【柏崎6/7, 東海第二】 島根2号炉は、ベントに伴うプルーム通過中は加圧運転から系統隔離運転に切り替える</p>
居住性設備	・可搬型陽圧化空調機を用いることにより、中央制御室パウダリ全体が陽圧化されていること ・中央制御室待避室の遮蔽設備の設置 ・中央制御室待避室の空調隔離ダンパの閉止 ・中央制御室待避室の酸素濃度・二酸化炭素濃度計、可搬型エリアモニタの配置、電源入 ・陽圧化装置による中央制御室待避室の加圧																				
監視設備	・6号炉、7号炉のデータ表示装置（待避室）電源入																				
通信連絡設備	・現場要員や緊急時対策所との通信連絡のための、6号炉、7号炉各々の無線連絡設備（常設）、衛星電話設備（常設）の準備（通話確認）																				
居住性対策設備	・中央制御室待避室空気ボンベユニットによる中央制御室待避室の加圧 ・酸素濃度計、二酸化炭素濃度計及び可搬型照明（SA）の配置及び電源入																				
監視設備	・データ表示装置（待避室）の配置及び電源入																				
通信連絡設備	・通信連絡設備の切替及び通話確認																				
居住性対策設備	・中央制御室換気系運転モードの加圧運転から系統隔離運転への切替 ・中央制御室待避室の酸素濃度計、二酸化炭素濃度計、電離箱サーベイ・メータの配置、準備 ・中央制御室待避室正圧化装置による中央制御室待避室の加圧																				
監視設備	・プラントパラメータ監視装置（中央制御室待避室）の電源入																				
通信連絡設備	・現場運転員や緊急時対策要員との通信連絡のための無線通信設備（固定型）の準備（通話確認）																				
<p style="text-align: right;">: SA範囲</p>	<p style="text-align: right;">: SA範囲</p>	<p style="text-align: right;">: SA範囲</p>																			

柏崎刈羽原子力発電所 6/7号炉 (2017.12.20)	東海第二発電所 (2018.9.18版)	島根原子力発電所 2号炉	備考
<p>(2) <u>原子炉格納容器圧力逃がし装置作動中 (待避中)</u> 運転員等は、<u>原子炉格納容器圧力逃がし装置作動開始後</u>、速やかに中央制御室待避室に移動し、出入口扉を閉めるとともに、中央制御室待避室に施設する<u>中央制御室待避室内外差圧計器</u>を確認し、中央制御室待避室へ適切に空気が供給され、中央制御室待避室内が<u>陽圧化</u>されていることを確認する。また<u>酸素濃度・二酸化炭素濃度計</u>により酸素濃度及び二酸化炭素濃度（酸素濃度が<u>18%</u>以上であること、二酸化炭素濃度が<u>0.5%</u>以下であること）を確認するとともに、<u>中央制御室待避室の放射線量率を可搬型エリアモニタにて監視する</u>。</p> <p>中央制御室待避室にとどまっている間にも、<u>6号及び7号炉のデータ表示装置 (待避室)</u>を用いることで、<u>原子炉格納容器圧力逃がし装置作動状況はじめとしたプラントの監視が可能な設計とする</u>。また中央制御室待避室に<u>通信連絡設備を設置し</u>、緊急時対策所本部等との連絡が常時可能な設計とする。中央制御室待避室にこれら設備を設置することで、中央制御室制御盤エリアに居るとき同様、タイムリーな監視操作が可能な設計とする。</p> <p>なお、中央制御室待避室にとどまっている間に中央制御室制御盤エリアに出る際には、<u>中央制御室制御盤エリアの放射線量率を可搬型エリアモニタで確認した上で</u>、必要な放射線防護装備、個人線量管理措置を施した上で、中央制御室制御盤エリアに出ることになる。そのために必要な資機材等を中央制御室待避室に備える設計とする。</p> <p>(3) <u>原子炉格納容器圧力逃がし装置作動後 (待避解除)</u> 運転員等は、<u>原子炉格納容器圧力逃がし装置作動に伴うプルーム通過後</u>は、中央制御室制御盤エリアの放射線量率を<u>可搬型エリアモニタで確認した上で</u>、緊急時対策所本部との協議の上、中央制御室制御盤エリアでの対応を再開する。</p>	<p>(2) <u>格納容器圧力逃がし装置作動中 (待避中)</u> 発電長等は、<u>格納容器圧力逃がし装置作動開始後</u>、速やかに中央制御室待避室に移動し、出入口扉を閉める。中央制御室待避室に施設する<u>中央制御室待避室差圧計</u>を確認し、中央制御室待避室へ適切に空気が供給され、正圧化されていることを確認する。また、<u>酸素濃度計及び二酸化炭素濃度計</u>により酸素濃度及び二酸化炭素濃度（酸素濃度が<u>19%</u>以上であること、二酸化炭素濃度が<u>0.5%</u>以下であること）を確認するとともに、<u>中央制御室待避室の放射線量率を電離箱サーベイメータにて監視する</u>。</p> <p>発電長等は、中央制御室待避室に待避している間にも、<u>データ表示装置 (待避室)</u>を用いることで、<u>格納容器圧力逃がし装置の作動状況等のプラント状態の監視を行う</u>。また、中央制御室待避室には<u>通信連絡設備を設置し</u>、緊急時対策所との連絡が常時可能とする。</p> <p>なお、中央制御室待避室に待避している間の<u>運転操作は不要であるが</u>、万一、中央制御室での運転操作が必要となった場合には、<u>中央制御室の放射線量率を電離箱サーベイメータで確認した上で</u>、災害対策本部の指示の下、<u>必要な放射線防護装備及び個人線量計管理措置を施した上で</u>、中央制御室に<u>出て、運転操作を行い</u>、<u>速やかに中央制御室待避室に移動する</u>。そのために必要な資機材は、中央制御室待避室に配備する。</p> <p>(3) <u>格納容器圧力逃がし装置作動後 (待避解除)</u> 発電長等は、<u>格納容器圧力逃がし装置作動に伴うプルーム放出後</u>、中央制御室の放射線量率を<u>電離箱サーベイメータで確認した上で</u>、災害対策本部との協議の上、必要な防護装備を着用し、中央制御室待避室における待避を解除し、中央制御室での対応を再開する。</p>	<p>(2) <u>格納容器フィルタベント系作動中 (待避中)</u> 運転員等は、<u>格納容器フィルタベント系作動開始後</u>、速やかに中央制御室待避室に移動し、出入口扉を閉めるとともに、中央制御室待避室に施設する<u>差圧計</u>を確認し、中央制御室待避室へ適切に空気が供給され、中央制御室待避室内が<u>正圧化</u>されていることを確認する。また、<u>酸素濃度計、二酸化炭素濃度計</u>により酸素濃度及び二酸化炭素濃度（酸素濃度が<u>19%</u>以上であること、二酸化炭素濃度が<u>1.0%</u>以下であること）を確認するとともに、<u>中央制御室待避室の放射線量率を電離箱サーベイ・メータにて監視する</u>。</p> <p>中央制御室待避室にとどまっている間にも、<u>プラントパラメータ監視装置 (中央制御室待避室)</u>を用いることで、<u>格納容器フィルタベント系作動状況をはじめとしたプラントの監視が可能な設計とする</u>。また、中央制御室待避室内に<u>通信連絡設備を設置し</u>、緊急時対策本部等との連絡が常時可能な設計とする。中央制御室待避室にこれら設備を設置することで、中央制御室制御盤エリアに居るとき同様、タイムリーな監視操作が可能な設計とする。</p> <p>なお、中央制御室待避室にとどまっている間に中央制御室制御盤エリアに出る際には、<u>必要な放射線防護装備、個人線量管理措置を施した上で</u>、中央制御室制御盤エリアに出ることになる。そのために必要な資機材等を中央制御室待避室に備える設計とする。</p> <p>(3) <u>格納容器フィルタベント系作動後 (待避解除)</u> 運転員等は、<u>格納容器フィルタベント系作動に伴うプルーム放出後</u>は、中央制御室制御盤エリアの放射線量率を<u>電離箱サーベイ・メータで確認した上で</u>、緊急時対策本部との協議の上、中央制御室制御盤エリアでの対応を再開する。</p>	<p>備考</p> <ul style="list-style-type: none"> ・設備の相違 【柏崎 6/7】 ①の相違 ・設計方針の相違 【柏崎 6/7, 東海第二】 ⑦の相違 ・申請号炉数の相違 【柏崎 6/7】
<p style="text-align: right;">: SA 範囲</p>	<p style="text-align: right;">: SA 範囲</p>	<p style="text-align: right;">: SA 範囲</p>	



図 3.1-1 原子炉格納容器圧力逃がし装置作動と中央制御室及び中央制御室待避室換気空調設備の運用の概要

： SA 範囲

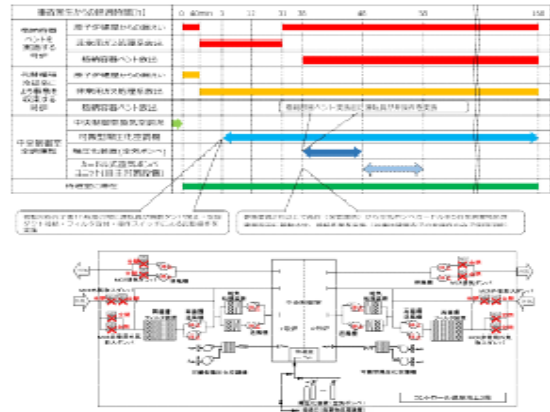
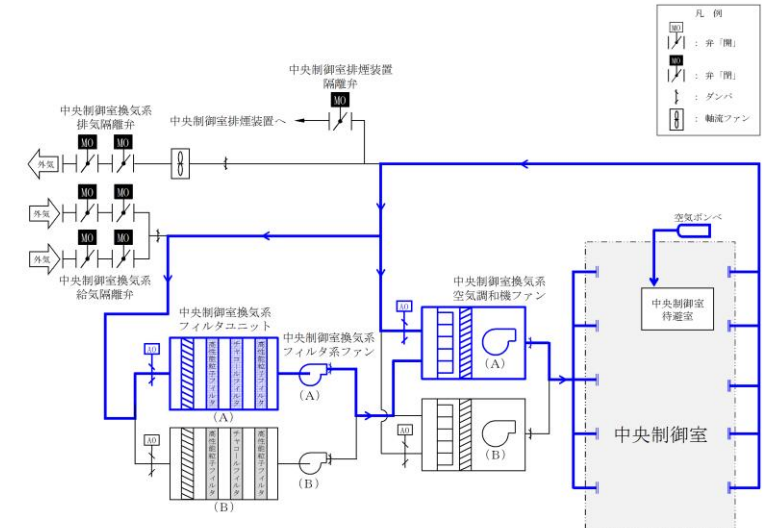
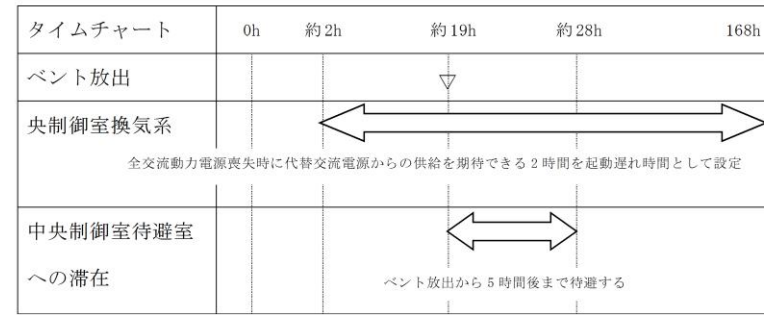

第 3.1-1 図 格納容器圧力逃がし装置作動並びに中央制御室及び中央制御室待避室における換気設備の運用の概要

： SA 範囲



図 3.1-1 格納容器フィルタベント系作動と中央制御室及び中央制御室待避室正圧化装置の運用の概要

： SA 範囲

・設備の相違
【柏崎 6/7, 東海第二】
②, ⑥の相違

3.2 配備する資機材の数量について

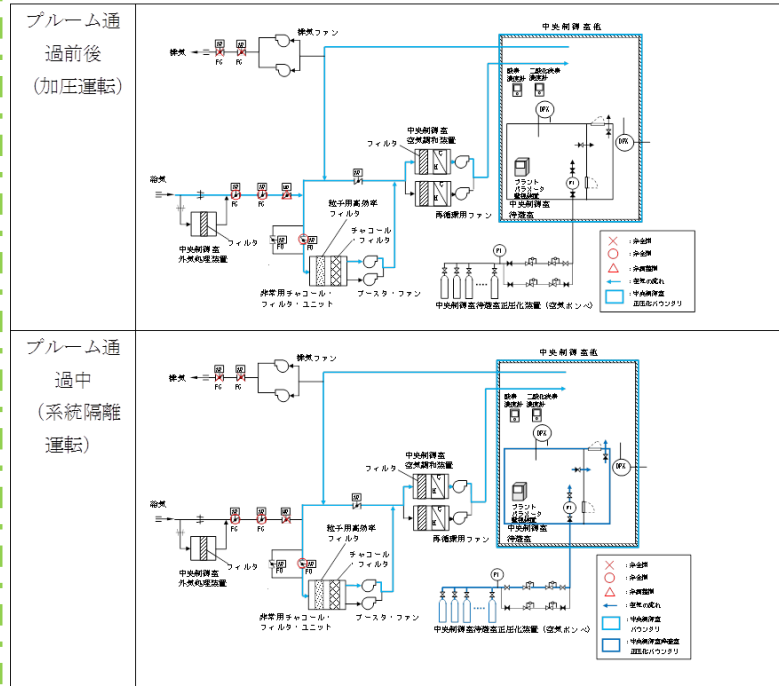
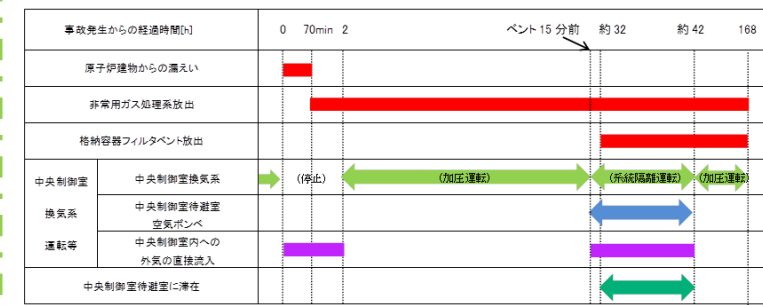
(1) 放射線防護資機材等

中央制御室に配備する放射線防護資機材等の内訳を表 3.2-1及び表3.2-2に示す。なお、放射線防護資機材等は、汚染が付着しないようビニール袋等であらかじめ養生し、配備する。

表 3.2-1 防護具

品名	配備数 (6号及び7号炉共用) ※7		
	5号炉原子炉建屋内 緊急時対策所	中央制御室	構内 (参考)
不織布カバーオール	1,890着※1	420着※8	約5,000着
靴下	1,890足※1	420足※8	約5,000足
帽子	1,890着※1	420着※8	約5,000着
綿手袋	1,890双※1	420双※8	約5,000双
ゴム手袋	3,780双※2	840双※9	約15,000双
ろ過式呼吸用保護具 (以下内訳)	810個※5	180個※10	約2,050個
電動ファン付き全面マスク	80個※15	20個※17,23	約50個
全面マスク	730個※16	160個※18	約2,000個
チャコールフィルタ (以下内訳)	1,890組※1	420組※8	約2,500組
電動ファン付き全面マスク用	560組※19	140組※21,23	約500組
全面マスク用	1,330組※20	280組※22	約2,000組
アノラック	945着※4	210着※11	約3,000着
汚染区域用靴	40足※5	10足※12	約300足
高線量対応防護服 (タンクステンベスト)	14着※6	—	10着
セルフエアセット※13	4台	4台	約100台
酸素呼吸器※14	—	5台	約20台

※1: 180名 (1~7号炉対応の緊急時対策要員164名+自衛消防隊10名+余裕、以下同様) ×7日×1.5倍
 ※2: ※1×2
 ※3: 180名×3日 (除染による再使用を考慮) ×1.5倍
 ※4: 180名×7日×1.5倍×50% (年間降水日数を考慮)
 ※5: 80名 (1~7号炉対応の現場復旧班要員65名+保安班要員15名) ×0.5 (現場要員の半数)
 ※6: 14名 (ブルーム直後に対応する現場復旧班要員14名)
 ※7: 予備を含む (今後、訓練等で見直しを行う)
 ※8: 20名 (6号及び7号炉運転員18名+余裕) ×2交替×7日×1.5倍
 ※9: ※8×2
 ※10: 20名 (6号及び7号炉運転員18名+余裕) ×2交替×3日 (除染による再使用を考慮) ×1.5倍
 ※11: 20名 (6号及び7号炉運転員18名+余裕) ×2交替×7日×1.5倍×50% (年間降水日数を考慮)
 ※12: 20名 (6号及び7号炉運転員18名+余裕) ×0.5 (現場要員の半数)
 ※13: 初期対応用3台+予備1台
 ※14: インターフェイスシステム LOCA等対応用4台+予備1台
 ※15: 80名 (1~7号炉対応の現場復旧班要員65名+保安班要員15名)
 ※16: ※3-※15
 ※17: 20名 (6号及び7号炉運転員18名+余裕)
 ※18: ※10-※17
 ※19: ※15×7日
 ※20: ※1-※19
 ※21: ※17×7日
 ※22: ※8-※21
 ※23: 中央制御室の被ばく評価において、運転員が交替する場合の入退域時に電動ファン付き全面マスクを着用するとして評価していることから、交替の拠点となる後方支援拠点にも同数配備する。

： SA範囲

3.2 配備する資機材の数量について

(1) 放射線防護資機材等

中央制御室に配備する放射線防護資機材等の内訳を第3.2-1表及び第3.2-2表に示す。なお、放射線防護資機材等は、汚染が付着しないようにビニール袋等であらかじめ養生し、配備する。

第3.2-1表 放射線防護具類

品名	配備数※1	
	緊急時対策所建屋	中央制御室※2
タイベック	1,166着※3	17着※15
靴下	2,332足※4	34足※16
帽子	1,166個※5	17個※17
綿手袋	1,166双※6	17双※18
ゴム手袋	2,332双※7	34双※19
全面マスク	333個※8	17個※17
チャコールフィルタ	2,332個※9	34個※20
アノラック	462着※10	17着※15
長靴	132足※11	9足※21
胴長靴	12足※12	9足※21
遮蔽ベスト	15着※13	—
自給式呼吸用保護具	—	9式※22
バックバック	66個※14	17個※17

※1 今後、訓練等で見直しを行う。
 ※2 運転員等は交替のために中央制御室に向かう際に、緊急時対策所建屋より防護具類を持参する。
 ※3 111名 (要員数) ×7日×1.5倍=1,165.5着→1,166着
 ※4 111名 (要員数) ×7日×2倍 (2足を1セットで使用) ×1.5倍=2,331足→2,332足
 ※5 111名 (要員数) ×7日×1.5倍=1,165.5個→1,166個
 ※6 111名 (要員数) ×7日×1.5倍=1,165.5双→1,166双
 ※7 111名 (要員数) ×7日×2倍 (2足を1セットで使用) ×1.5倍=2,331双→2,332双
 ※8 111名 (要員数) ×2日 (3日目以降は除染にて対応) ×1.5倍=333個
 ※9 111名 (要員数) ×7日×2倍 (2個を1セットで使用) ×1.5倍=2,331個→2,332個

： SA範囲

3.2 配備する資機材の数量について

(1) 放射線防護資機材等

中央制御室に配備する放射線防護資機材等の内訳を表 3.2-1及び表3.2-2に示す。なお、放射線防護資機材等は、汚染が付着しないようビニール袋等であらかじめ養生し、配備する。

表 3.2-1 放射線防護資機材

品名	保管数※	考え方
汚染防護服	210着	10名 (1, 2号炉運転員9名+余裕, 以下同様) ×2交替×7日×1.5 (余裕) =210
靴下	210足	10名×2交替×7日×1.5 (余裕) =210
帽子	210着	10名×2交替×7日×1.5 (余裕) =210
綿手袋	210双	10名×2交替×7日×1.5 (余裕) =210
ゴム手袋	420双	10名×2交替×7日×1.5 (余裕) ×2=420
ろ過式呼吸用保護具 (以下内訳)	90個	10名×2交替×3日 (除染による再使用を考慮) ×1.5 (余裕) =90
電動ファン付き全面マスク	10個	10名
全面マスク	80個	90-10=80
チャコールフィルタ (以下内訳)	210個	10名×2交替×7日×1.5 (余裕) =210
電動ファン付き全面マスク用	70個	10名×7日=70
全面マスク用	140個	210-70=140
被水防護服	105着	10名×2交替×7日×1.5 (余裕) ×50% (年間降水日数を考慮) =105
作業用長靴	10足	10名
セルフエアセット	4台	初期対応用3台+予備1台
酸素呼吸器	3台	インターフェイスシステム LOCA等対応用2台+予備1台

※予備を含む (今後、訓練等で見直しを行う。)

： SA範囲

・資機材の相違
 【柏崎6/7, 東海第二】
 島根2号炉は考え方に示す人数と積上げ方法により必要な資器材配備する

柏崎刈羽原子力発電所 6 / 7号炉 (2017.12.20)	東海第二発電所 (2018.9.18版)	島根原子力発電所 2号炉	備考
	<p>※10 44名 (現場の災害対策要員から自衛消防隊員を除いた数) ×7日×1.5倍=462着</p> <p>※11 44名 (現場の災害対策要員から自衛消防隊員を除いた数) ×2倍 (現場での交替を考慮) ×1.5倍 (基本再使用, 必要により除染) =132足</p> <p>※12 4名 (重大事故等対応要員4名:放水砲対応) ×2倍 (現場での交替を考慮) ×1.5倍 (基本再使用, 必要により除染) =12足</p> <p>※13 10名 (重大事故等対応要員10名:放水砲, アクセスルート確保, 電源確保, 水源確保対応) ×1.5倍 (基本再使用, 必要により除染) =15着</p> <p>※14 44名 (現場の災害対策要員から自衛消防隊員を除いた数) ×1.5倍=66個</p> <p>※15 11名 (中央制御室要員数) ×1.5倍=16.5→17着</p> <p>※16 11名 (中央制御室要員数) ×2倍 (2足を1セットで使用) ×1.5倍=33足→34足</p> <p>※17 11名 (中央制御室要員数) ×1.5倍=16.5→17個</p> <p>※18 11名 (中央制御室要員数) ×1.5倍=16.5→17双</p> <p>※19 11名 (中央制御室要員数) ×2倍 (2双を1セットで使用) ×1.5倍=33双→34双</p> <p>※20 11名 (中央制御室要員数) ×2倍 (2個を1セットで使用) ×1.5倍=33個→34個</p> <p>※21 6名 (運転員 (現場) 3名+重大事故対応要員3名:屋内現場対応) ×1.5倍=9足</p> <p>※22 6名 (運転員 (現場) 3名+重大事故対応要員3名:屋内現場対応) ×1.5倍=9式</p> <p>・放射線防護具類の配備数の妥当性の確認について</p> <p>【中央制御室】</p> <p>中央制御室には初動対応に必要な数量を配備することとし, 初動対応以降は交代要員が中央制御室に向かう際に, 緊急時対策所建屋より防護具類を持参することに対応する。</p> <p>中央制御室の要員数は11名であり, 運転員等 (中央制御室) 4名と運転員 (現場) 3名, 情報班員1名, 重大事故等対応要員3名で構成する。このうち, 運転員等 (現場) は, 1回現場に行くことを想定する。また, 全要員の交替時の防護具類を考慮する。</p> <p>タイベック, 帽子及び綿手袋の配備数は, 以下のとおり, 上記を踏まえ算出した必要数を上回っており妥当である。</p> <p>11名×1回 (交替時) +3名×1回 (現場) =14 < 17</p> <p>靴下及びゴム手袋は, 二重にして使用し, チャコールフィルタは, 2個装着して使用する。靴下等の配備数は, 以下のとおり, 必要数を上回っており妥当である。</p> <p>(11名×1回 (交替時) +3名×1回 (現場)) ×2倍=28 < 34</p> <p>全面マスク及びバックパックは, 再使用するため, 必要数は11個であり, 配備数 (17個) が必要数を上回っており, 妥当である。</p> <p>長靴, 胴長靴及び自給式呼吸用保護具は, それぞれ想定する使用者数を上回るよう設定しており, 妥当である (※11, ※12, ※21及び※22参照)。</p>		

： S A 範囲

柏崎刈羽原子力発電所 6/7号炉 (2017.12.20)	東海第二発電所 (2018.9.18版)	島根原子力発電所 2号炉	備考
<p>・1.5倍の妥当性の確認について</p> <p>【5号炉原子炉建屋内緊急時対策所】</p> <p>第2次緊急態勢時(1日目), 1~7号炉対応の要員は緊急時対策要員 164名+自衛消防隊 10名であり, 機能班要員 84名, 現場要員 80名及び自衛消防隊 10名で構成されている。このうち, 本部要員は, 5号炉原子炉建屋内緊急時対策所を陽圧化することにより, 防護具類を着用する必要がないが, 全要員は12時間に1回交替するため, 2回の交替分を考慮する。また, 現場要員 80名は, 1日に6回現場に行くことを想定する。自衛消防隊は火災現場には消防服で出向し, 防護具類を着用する必要がないため考慮しない。</p> <p>ブルーム通過以降(2日目以降), 1~7号炉対応の要員は緊急時対策要員111名+5号炉運転員8名であり, 機能班要員54名, 現場要員57名及び5号炉運転員8名で構成されている。このうち, 本部要員は, 5号炉原子炉建屋内緊急時対策所を陽圧化することにより, 防護具類を着用する必要がないが, 全要員は7日目以降に1回交替するため, 1回の交替分を考慮する。また, 現場要員は1日に2回現場に行くことを想定する。自衛消防隊は火災現場には消防服で出向し, 防護具類を着用する必要がないため考慮しない。</p> <p>$174名 \times 2交替 + 80名 \times 6回 + 119名 + 65名 \times 2回 \times 6日 = 1,727着 < 1,890着$</p> <p>【中央制御室】</p> <p>要員数18名は, 運転員(中央制御室)7名と運転員(現場)11名で構成されている。運転員は2交替を考慮し, 交替時の1回着用を想定する。また, 運転員(現場)は, 1回現場に行くことを想定している。</p> <p>$18名 \times 1回 \times 2交代 \times 7日 + 11名 \times 1回 \times 2交代 \times 7日 = 406着 < 420着$</p> <p>上記想定により, 重大事故等発生時に, 交替等で中央制御室に複数の班がいる場合を考慮しても, 初動対応として十分な数量を確保している。</p> <p>なお, いずれの場合も防護具類が不足する場合は, 構内より適宜運搬することにより補充する。</p> <p style="text-align: right;">: SA範囲</p>		<p>・1.5倍の妥当性の確認について</p> <p>【中央制御室】</p> <p>要員数9名は, 運転員(中央制御室)5名と運転員(現場)4名で構成されている。このうち, 運転員(中央制御室)は, 中央制御室内を正圧化することにより, 防護具類を着用する必要がない。ただし, 運転員は2交替を考慮し, 交替時の1回着用を想定する。また, 運転員(現場)は, 1回現場に行くことを想定している。</p> <p>$9名 \times 1回 \times 2交替 \times 7日 + 4名 \times 1回 \times 2交替 \times 7日 = 182着 < 210着$</p> <p>上記想定により, 重大事故等発生時に, 交替等で中央制御室に複数の班がいる場合を考慮しても, 初動対応として十分な数量を確保している。</p> <p>なお, いずれの場合も防護具類が不足する場合は, 構内より適宜運搬することにより補充する。</p> <p style="text-align: right;">: SA範囲</p>	<p>・体制及び運用の相違</p> <p>【柏崎6/7】</p> <p>島根の自衛消防隊は, 火災発生時以外は復旧班として活動を行うため, 防護具類が必要となる現場要員に含める。</p>

表 3.2-2 計測器 (被ばく管理, 汚染管理)

品名		配備台数 ^{※5}
		中央制御室 (6号及び7号炉共用)
個人線量計	電子式線量計	70台 ^{※1}
	ガラスバッジ	70台 ^{※1}
GM汚染サーベイメータ		3台 ^{※2}
電離箱サーベイメータ		2台 ^{※3}
可搬型エリアモニタ		3台 ^{※4}

※1: 20名 (6号及び7号炉運転員18名) + 46名 (引継班, 日勤班, 作業管理班) + 余裕
 ※2: 中央制御室のモニタリング及びチェンジングエリアにて使用
 ※3: 中央制御室のモニタリングに使用
 ※4: 各エリアにて使用。設置のタイミングは, チェンジングエリア設営判断と同時 (原子力災害対策特別措置法第10条特定事象)
 ※5: 予備を含む (今後, 訓練等で見直しを行う。)

(2) 飲食料等

中央制御室に配備する飲食料等の内訳を表 3.2-3 に示す。
 なお, 飲食料等は, 汚染が付着しないようビニール袋等であらかじめ養生し, 配備する。

表 3.2-3 飲食料等

品名		配備数 ^{※4}
		中央制御室 (6号及び7号炉共用)
飲食料等		
・食料		420食 ^{※1}
・飲料水 (1.5リットル)		280本 ^{※2}
簡易トイレ		1式
ヨウ素剤		320錠 ^{※3}

※1: 20名 (6号及び7号炉運転員18名+余裕) × 7日 × 3食
 ※2: 20名 (6号及び7号炉運転員18名+余裕) × 7日 × 2本
 ※3: 20名 (6号及び7号炉運転員18名+余裕) × 8錠 (初日2錠+2日目以降1錠/日 × 6日)
 ※4: 予備を含む (今後, 訓練等で見直しを行う。)

: SA範囲

第 3.2-2 表 放射線計測器 (被ばく管理・汚染管理) の配備数

品名	配備数 ^{※1}	
	緊急時対策所建屋	中央制御室
個人線量計	333台 ^{※3}	33台 ^{※8}
GM汚染サーベイメータ	5台 ^{※4}	3台 ^{※9}
電離箱サーベイメータ	5台 ^{※5}	3台 ^{※10}
緊急時対策所エリアモニタ	2台 ^{※6}	—
可搬型モニタリングポスト ^{※2}	2台 ^{※6}	—
ダストサンブラ ^{※2}	2台 ^{※7}	2台 ^{※7}

※1 今後, 訓練等で見直しを行う
 ※2 緊急時対策所の可搬型モニタリング・ポストについては「監視測定設備」の可搬型モニタリング・ポストと兼用する。
 ※3 111名 (要員数) × 2台 (交替時) × 1.5倍 = 333台
 ※4 身体の汚染検査用に3台+2台 (予備) = 5台
 ※5 現場作業等用に4台+1台 (予備) = 5台
 ※6 加圧判断用に1台+1台 (予備) = 2台
 ※7 室内のモニタリング用に1台+1台 (予備) = 2台
 ※8 11名 (中央制御室要員数) × 2台 (交替時) × 1.5倍 = 33台
 ※9 身体の汚染検査用に2台+1台 (予備) = 3台
 ※10 現場作業等用に2台+1台 (予備) = 3台

(2) 飲食料等

中央制御室に配備する飲食料等の内訳を第3.2-3表に示す。なお, 飲食料等は, 汚染が付着しないようビニール袋等であらかじめ養生し, 配備する。

第 3.2-3 表 飲食料等

品名	配備数 ^{※1}
飲食料等	
・食料	231食 ^{※2}
・飲料水 (1.5リットル)	154本 ^{※3}
簡易トイレ	1式
安定ヨウ素剤	154錠 ^{※4}

※1 今後, 訓練等で見直しを行う。
 ※2 11名 (中央制御室運転員7名+情報連絡要員1名+運転対応要員3名) × 7日 × 3食 = 231食
 ※3 11名 (中央制御室運転員7名+情報連絡要員1名+運転対応要員3名) × 7日 × 2本 = 154本
 ※4 11名 (中央制御室運転員7名+情報連絡要員1名+運転対応要員3名) × (初日2錠+2日目以降1錠/日 × 2交替) = 154錠

: SA範囲

表 3.2-2 放射線計測器

品名		配備台数 ^{※6}
		中央制御室
個人線量計	電子式線量計	10台 ^{※1}
	ガラスバッジ	10個 ^{※1}
GM汚染サーベイ・メータ		3台 ^{※2}
電離箱サーベイ・メータ		2台 ^{※3}
可搬式エリア放射線モニタ		3台 ^{※4}
ダストサンブラ		2台 ^{※5}

※1: 10名 (1, 2号炉運転員9名+余裕)
 ※2: 中央制御室内外モニタリング用1台+チェンジングエリア用1台+予備1台
 ※3: 中央制御室内外モニタリング用1台+予備1台
 ※4: 中央制御室内用1台+チェンジングエリア用1台+予備1台 (設置のタイミングは, チェンジングエリア設営判断と同時 (原子力災害対策特別措置法第10条特定事象))
 ※5: 室内のモニタリング用1台+予備1台
 ※6: 今後, 訓練等で見直しを行う。

(2) 飲食料等

中央制御室に配備する飲食料等の内訳を表 3.2-3 に示す。
 なお, 飲食料等は, 汚染が付着しないようビニール袋等であらかじめ養生し, 配備する。

表 3.2-3 飲食料等

品名		配備数 ^{※4}
		中央制御室
飲食料		
・食料		210食 ^{※1}
・飲料水 (1.5リットル)		140本 ^{※2}
簡易トイレ		1式
安定ヨウ素剤		160錠 ^{※3}

※1: 10名 (1, 2号炉運転員9名+余裕, 以下同様) × 7日 × 3食
 ※2: 10名 × 7日 × 2本
 ※3: 10名 × 8錠 (初日2錠+2日目以降1錠/日 × 6日) × 2交替
 ※4: 予備を含む (今後, 訓練等で見直しを行う。)

: SA範囲

・資機材の相違
 【柏崎 6/7, 東海第二】
 島根 2号炉は※に示す想定人数及び使用方法により必要な台数を配備する

・配備数の相違
 【柏崎 6/7, 東海第二】
 島根 2号炉は※に示す想定人数及び使用方法により必要な数を配備する

柏崎刈羽原子力発電所 6/7号炉 (2017.12.20)	東海第二発電所 (2018.9.18版)	島根原子力発電所 2号炉	備考
<p>3.3 チェンジングエリアについて</p> <p>(1) チェンジングエリアの基本的な考え方</p> <p>チェンジングエリアの設営に当たっては、「実用発電用原子炉及びその附属施設の位置、構造及び設備の基準に関する規則の解釈」第59条第1項（運転員が原子炉制御室にとどまるための設備）並びに「実用発電用原子炉及びその附属設備の技術基準に関する規則の解釈」第74条第1項（運転員が原子炉制御室にとどまるための設備）に基づき、原子炉制御室の外側が放射性物質により汚染したような状況下において、原子炉制御室への汚染の持ち込みを防止するため、モニタリング及び作業服の着替え等を行うための区画を設けることを基本的な考え方とする。</p> <p>なお、チェンジングエリアは6号及び7号炉共用とする。</p> <p>(実用発電用原子炉及びその附属設備の技術基準に関する規則の解釈第74条第1項（運転員が原子炉制御室にとどまるための設備）抜粋)</p> <div data-bbox="172 966 884 1165" style="border: 1px solid black; padding: 5px;"> <p>原子炉制御室の外側が放射性物質により汚染したような状況下において、原子炉制御室への汚染の持ち込みを防止するため、モニタリング及び作業服の着替え等を行うための区画を設けること。</p> </div>	<p>3.3 チェンジングエリアについて</p> <p>(1) チェンジングエリアの基本的な考え方</p> <p>チェンジングエリアの設営に当たっては、「実用発電用原子炉及びその附属施設の位置、構造及び設備の基準に関する規則の解釈」第59条第1項（運転員が原子炉制御室にとどまるための設備）及び「実用発電用原子炉及びその附属施設の技術基準に関する規則の解釈」第74条第1項（運転員が原子炉制御室にとどまるための設備）に基づき、中央制御室の外側が放射性物質により汚染したような状況下において、中央制御室への汚染の持ち込みを防止するため、身体の汚染検査及び防護具の脱衣等を行うための区画を設けることを基本的な考え方とする。</p>	<p>3.3 チェンジングエリアについて</p> <p>(1) チェンジングエリアの基本的な考え方</p> <p>チェンジングエリアの設営にあたっては、「実用発電用原子炉及びその附属施設の位置、構造及び設備の基準に関する規則の解釈」第59条第1項（運転員が原子炉制御室にとどまるための設備）並びに「実用発電用原子炉及びその附属設備の技術基準に関する規則の解釈」第74条第1項（運転員が原子炉制御室にとどまるための設備）に基づき、原子炉制御室の外側が放射性物質により汚染したような状況下において、原子炉制御室への汚染の持ち込みを防止するため、モニタリング及び作業服の着替え等を行うための区画を設けることを基本的な考え方とする。</p> <p>(実用発電用原子炉及びその附属設備の技術基準に関する規則の解釈第74条第1項（運転員が原子炉制御室にとどまるための設備）抜粋)</p> <div data-bbox="1736 966 2478 1165" style="border: 1px solid black; padding: 5px;"> <p>原子炉制御室の外側が放射性物質により汚染したような状況下において、原子炉制御室への汚染の持ち込みを防止するため、モニタリング及び作業服の着替え等を行うための区画を設けること。</p> </div>	<p>備考</p> <p>・申請号炉数の相違 【柏崎 6/7】</p>
 : SA範囲	 : SA範囲	 : SA範囲	

(2) **チェンジングエリアの概要**
 チェンジングエリアは、脱衣エリア、サーベイエリア、除染エリアからなり、中央制御室陽圧化バウンダリに隣接するとともに、要員の被ばく低減の観点からコントロール建屋内に設営する。概要は表3.3-1のとおり。

(2) **チェンジングエリアの概要**
 チェンジングエリアは、脱衣エリア、サーベイエリア、除染エリア及びクリーンエリアからなり、原子炉建屋付属棟内かつ中央制御室バウンダリに隣接した場所に設営する。

(2) **チェンジングエリアの概要**
 チェンジングエリアは、脱衣エリア、サーベイエリア及び除染エリアからなり、要員の被ばく低減の観点からタービン建物内、かつ中央制御室正圧化バウンダリに隣接した場所に設営する。概要は、表3.3-1のとおり。

・運用及び設備の相違
【東海第二】
 島根2号炉は、可搬式空気浄化装置によるエリア内の浄化及び定期定期なエリア内の環境測定により汚染流入を防止
【柏崎6/7,東海第二】
 島根2号炉のタービン建物内は中央制御室バウンダリに隣接する
 ・設備の相違
【柏崎6/7,東海第二】
 島根2号炉のチェンジングエリアは、パネル取付ユニット方式を採用

表 3.3-1 チェンジングエリアの概要

項目	理由
設営場所 コントロール建屋 地下1階～2階 東側エリア	中央制御室の外側が放射性物質により汚染したような状況下において、中央制御室への汚染の持ち込みを防止するため、モニタリング及び作業服の着替え等を行うための区画を設ける。
設営形式 エアータント	設営の容易さ及び迅速化の観点から、エアータントを採用する。
手順着手の判断基準	原子力災害対策特別措置法第10条特定事象が発生した後、保安班長が、事象進展の状況（格納容器周囲放射線レベル計（CAMS）等により炉心損傷を判断した場合等）、参集済みの要員数及び保安班が実施する作業の優先順位を考慮して、チェンジングエリア設営を行うと判断した場合。
実施者 保安班	チェンジングエリアを速やかに設営できるよう定期的に訓練を行っている保安班が設営を行う。

第 3.3-1 表にチェンジングエリアの概要を示す。

設営場所 原子炉建屋付属棟4階 空調機械室	<ul style="list-style-type: none"> 中央制御室の外側が放射性物質により汚染したような状況下において、中央制御室への汚染の持ち込みを防止するため、身体の汚染検査及び防護具の脱衣等を行うための区画を設ける。 空調機械室内への搬入口は地震、竜巻等でも開放せず、事故発生時でも外部の風雨の影響を防止できる構造とする。
設営形式 テントハウス (一部、通路区画化)	<ul style="list-style-type: none"> 通路にテントハウスを設営し、テントハウス内は厚付シート壁等により区画化する。
手順着手の判断基準 原子力災害対策特別措置法第10条特定事象が発生し、災害対策本部長の指示があった場合	<ul style="list-style-type: none"> 中央制御室の外側が放射性物質により汚染するようなおそれが発生した場合、チェンジングエリアの設営を行う。 事故進展の状況、参集済みの要員数等を考慮して放射線管理班が実施する作業の優先順位を判断し、速やかに設営を行う。
実施者 放射線管理班	<ul style="list-style-type: none"> チェンジングエリアを速やかに設営できるように、定期的に訓練を行っている放射線管理班員が参集した後に設営を行う。







表 3.3-1 チェンジングエリアの概要

項目	理由
設営場所 タービン建物 運転員控室前通路	中央制御室の外側が放射性物質により汚染したような状況下において、中央制御室への汚染の持ち込みを防止するため、モニタリング及び作業服の着替え等を行うための区画を設ける。
設営形式 パネル取付ユニット方式	設営の容易さ及び迅速化の観点から、パネル取付ユニット方式を採用する。
手順着手の判断基準	原子力災害対策特別措置法第10条特定事象が発生した後、緊急時対策本部が、事象進展の状況、参集済みの要員数及び緊急時対策要員が実施する作業の優先順位を考慮して、チェンジングエリア設営を行うと判断した場合。
実施者 緊急時対策要員	チェンジングエリアを速やかに設営できるよう定期的に訓練を行っている緊急時対策要員が設営を行う。

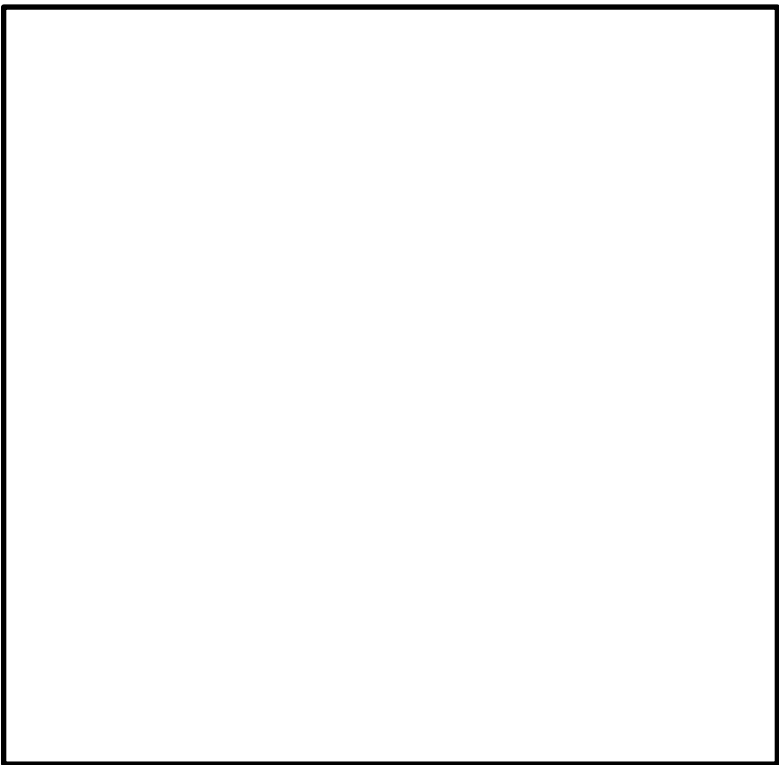
： SA 範囲

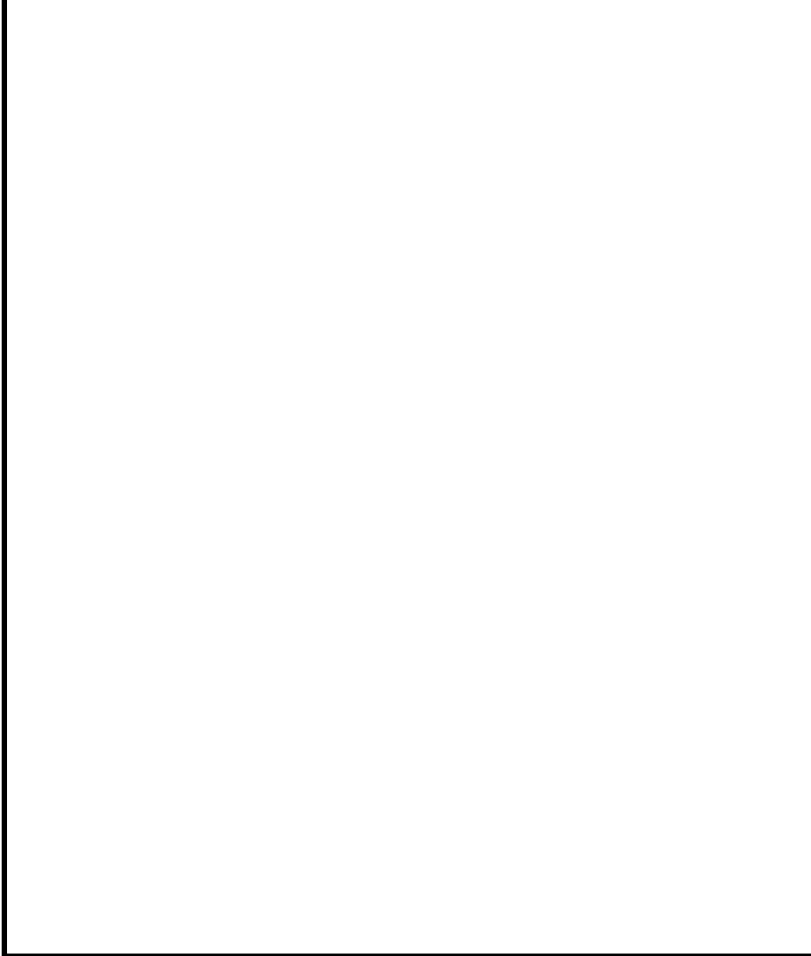
： SA 範囲

： SA 範囲

柏崎刈羽原子力発電所 6/7号炉 (2017.12.20)	東海第二発電所 (2018.9.18版)	島根原子力発電所 2号炉	備考
<p>(3) チェンジングエリアの設営場所及び屋内のアクセスルート チェンジングエリアは、<u>中央制御室陽圧化バウンダリ</u>に隣接した場所に設置する。チェンジングエリアの設営場所及び屋内のアクセスルートは、<u>図3.3-1</u>のとおり。</p> 	<p>(3) チェンジングエリアの設営場所及びアクセスルート チェンジングエリアは、<u>中央制御室バウンダリ</u>に隣接した場所に設置する。チェンジングエリアの設営場所及びアクセスルートは、<u>第3.3-1図</u>及び<u>第3.3-2図</u>のとおり。なお、<u>通常時のルートであるサービス建屋側へアクセスするルートは使用せず、耐震性が確保された原子炉建屋内のルートを設定する。</u>作業員は、<u>放射線防護具を着用し、チェンジングエリアから中央制御室へのアクセスする。</u>原子炉建屋付属棟における中央制御室へのアクセスルートの設定図を<u>第3.3-3図</u>に示す。作業員が携行する資機材（携行型有線通話装置、電離箱サーベイメータ、電動ドライバ等）については、<u>バックパックに入れて携行することで、携行時の負担を軽減する。</u></p> 	<p>(3) チェンジングエリアの設営場所及びアクセスルート チェンジングエリアは、<u>中央制御室正圧化バウンダリ</u>に隣接した場所に設置する。チェンジングエリアの設営場所及びアクセスルートは、<u>図3.3-1</u>のとおり。</p> 	
<p>図3.3-1 中央制御室チェンジングエリアの設営場所及び屋内のアクセスルート</p>	<p>第3.3-1図 中央制御室チェンジングエリアの設営場所</p>	<p>図3.3-1 チェンジングエリアの設営場所及びアクセスルート</p>	
 : SA範囲	 : SA範囲	 : SA範囲	

(通行状態のイメージ)

① ② ③ ④

傾斜約70° 幅約90cm

既設の梯子は撤去

中央制御室への気密扉

第 3.3-2 図 中央制御室へのアクセスルートの概要図

→ 中央制御室へ向かう動線 (同一フロア内移動)
 - - -> 中央制御室へ向かう動線 (階段移動)

※ 3層ケーブルラックと新設壁の直結部はシール施工し、気密性を確保する。

第 3.3-3 図 中央制御室へのアクセスルート設定図

: SA範囲

柏崎刈羽原子力発電所 6/7号炉 (2017.12.20)	東海第二発電所 (2018.9.18版)	島根原子力発電所 2号炉	備考
<p>(4) チェンジングエリアの設営 (考え方, 資機材)</p> <p>a. 考え方</p> <p>中央制御室への放射性物質の持ち込みを防止するため、図3.3-2の設営フローに従い、図3.3-3のとおりチェンジングエリアを設営する。チェンジングエリアの設営は、保安班員2名で、約60分を想定する。なお、チェンジングエリアが速やかに設営できるよう定期的に訓練を行い、設営時間の短縮及び更なる改善を図ることとしている。</p> <p>チェンジングエリアの設営は、原子力防災組織の緊急時対策要員(夜間及び休日(平日の勤務時間帯以外))の保安班2名、又は参集要員(10時間後までに参集)のうち、チェンジングエリアの設営に割り当てることができる要員で行う。設営の着手は、保安班長が、原子力災害対策特別措置法第10条特定事象が発生した後、事象進展の状況(格納容器雰囲気放射線レベル計(CAMS)等により炉心損傷を判断した場合等)、参集済みの要員数及び保安班が実施する作業の優先順位を考慮して判断し、速やかに実施する。</p>  <p>図 3.3-2 チェンジングエリア設営フロー</p>	<p>(4) チェンジングエリアの設営 (考え方, 資機材)</p> <p>a. 考え方</p> <p>中央制御室への放射性物質の持ち込みを防止するため、第3.3-4図の設営フローに従い、第3.3-5図のとおり、チェンジングエリアを設営する。チェンジングエリアの設営は、放射線管理班員2名で、初期運用開始に必要なサーベイエリア及び除染エリアの設営に約60分、さらに脱衣エリアの設営に約80分の合計140分を想定している。なお、チェンジングエリアが速やかに設営できるように定期的に訓練を行い、設営時間の短縮及び更なる改善を図ることとしている。夜間・休日に事故が発生した場合の参集までの時間を考慮しても、約3時間後にはチェンジングエリアの初期運用を開始することが可能である。</p> <p>チェンジングエリアの設営は、原子力防災組織の要員の放射線管理班における重大事故等対応要員4名のうち、チェンジングエリアの設営に割り当てることができる要員で行う。設営の着手は、原子力災害対策特別措置法第10条特定事象が発生し、災害対策本部長の指示があった場合に実施する。</p>  <p>第 3.3-4 図 チェンジングエリアの設営フロー</p>	<p>(4) チェンジングエリアの設営 (考え方, 資機材)</p> <p>a. 考え方</p> <p>中央制御室への放射性物質の持ち込みを防止するため、図3.3-2の設営フローに従い、図3.3-3のとおりチェンジングエリアを設営する。チェンジングエリアの設営は、放射線管理班員2名で、2時間以内を想定する。チェンジングエリアが速やかに設営できるよう定期的に訓練を行い、設営時間の短縮及び更なる改善を図ることとしている。</p> <p>チェンジングエリアの設営は、原子力防災組織の緊急時対策要員の放射線管理班員2名をチェンジングエリアの設営に割り当て行う。設営の着手は、当直長が、原子力災害対策特別措置法第10条特定事象が発生したと判断した後、事象進展の状況(格納容器雰囲気放射線モニター(CAMS)等により炉心損傷を判断した場合等)、参集済みの要員数及び放射線管理班が実施する作業の優先順位を考慮して判断し、速やかに実施する。</p>  <p>図 3.3-2 チェンジングエリア設営フロー</p>	<p>備考</p> <p>・想定時間及び体制の相違</p> <p>【柏崎 6/7, 東海第二】 島根 2号炉は設営時間を2時間としているが訓練等により速やかな設営を行う</p> <p>【東海第二】 島根 2号炉は、夜間・休日に設営が必要な場合、常駐する放射線管理班が設営を行う((11)放射線管理班の緊急時対応のケーススタディに示す)</p> <p>・設備の相違</p> <p>【柏崎 6/7, 東海第二】 島根 2号炉のチェンジングエリアは、パネル取付ユニット方式を採用</p>
: SA範囲	: SA範囲	: SA範囲	



図 3.3-3 中央制御室チェンジングエリア



第 3.3-5 図 中央制御室チェンジングエリア

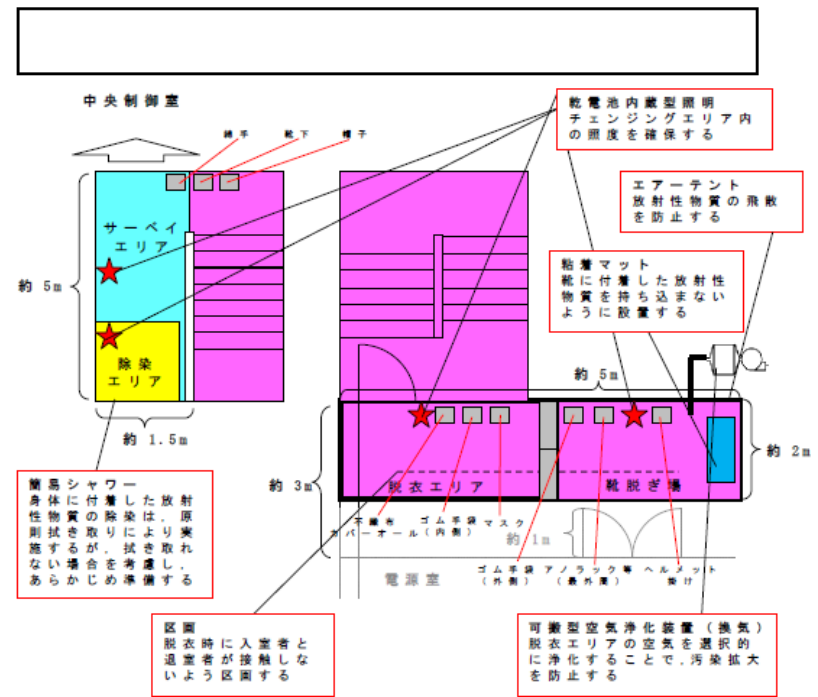
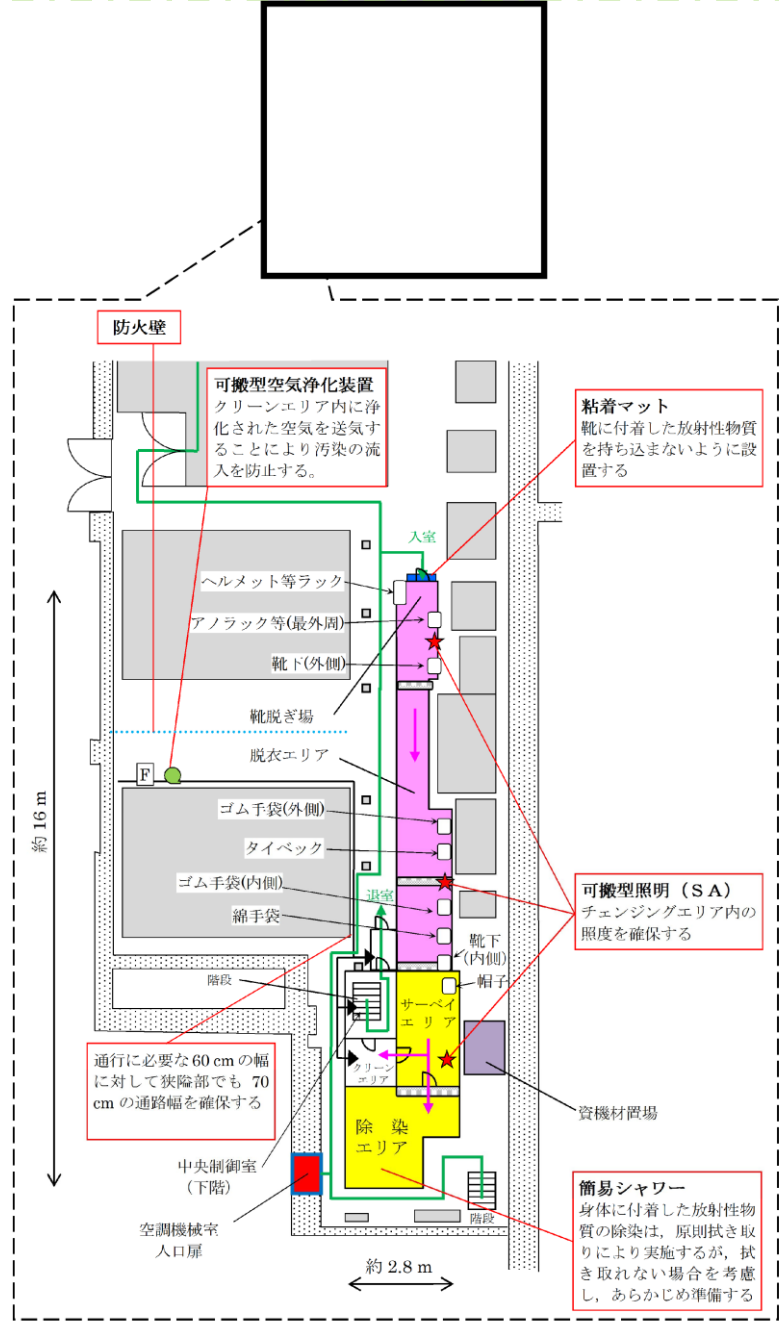

図 3.3-3 中央制御室チェンジングエリア

b. チェンジングエリア用資機材
 チェンジングエリア用資機材については、運用開始後のチェンジングエリアの補修や汚染によるシート張替え等も考慮して、表3.3-2のとおりとする。チェンジングエリア用資機材は、チェンジングエリア付近に保管する。

： SA 範囲

b. チェンジングエリア用資機材
 チェンジングエリア用資機材については、運用開始後のチェンジングエリアの補修や汚染によるシート張替え等も考慮し、第3.3-2表のとおりとする。チェンジングエリア用資機材は、チェンジングエリア付近に保管する。

： SA 範囲

b. チェンジングエリア用資機材
 チェンジングエリア用資機材については、運用開始後のチェンジングエリアの補修や汚染によるシート張替え等も考慮して、表3.3-2のとおりとする。チェンジングエリア用資機材は、チェンジングエリア付近に保管する。

： SA 範囲

・設備の相違
 【柏崎6/7, 東海第二】
 島根2号炉のチェンジングエリアは、パネル取付ユニット方式を採用

表 3.3-2 中央制御室チェンジングエリア用資機材

名称	数量 (6号及び7号炉共用)	根拠
エアータント	1式	チェンジングエリア設営に必要な数量
養生シート	2巻	
バリア	2個	
フェンス	4枚	
粘着マット	2枚	
ポリ袋	20枚	
テープ	2巻	
ウエス	1箱	
ウェットティッシュ	2巻	
はさみ	1個	
マジック	2本	
簡易シャワー	1式	
簡易タンク	1式	
トレイ	1個	
バケツ	2個	
可搬型空気浄化装置	1台(予備1台)	
乾電池内蔵型照明	4台(予備1台)	

(5) チェンジングエリアの運用

(出入管理, 脱衣, 汚染検査, 除染, 着衣, 要員に汚染が確認された場合の対応, 廃棄物管理, チェンジングエリアの維持管理)

a. 出入管理

チェンジングエリアは, 中央制御室の外側が放射性物質により汚染したような状況下において, 中央制御室に待機していた要員が, 中央制御室外で作業を行った後, 再度, 中央制御室に入室する際等に利用する。中央制御室外は, 放射性物質により汚染しているおそれがあることから, 中央制御室外で活動する要員は防護具を着用し活動する。

チェンジングエリアのレイアウトは図3.3-3のとおりであり, チェンジングエリアには下記の①から③のエリアを設けることで中央制御室内への放射性物質の持ち込みを防止する。

： S A 範囲

第3.3-2表 チェンジングエリア用資機材

分類	名称	数量 ^{※1}	
チェンジングエリア設営用	テントハウス	7張 ^{※2}	
	バリア	6個 ^{※3}	
	簡易シャワー	1式 ^{※2}	
	簡易水槽	1個 ^{※2}	
	バケツ	1個 ^{※2}	
	水タンク	1式 ^{※2}	
	可搬型空気浄化装置	2台 ^{※4}	
	消耗品	はさみ, カッター	各3本 ^{※5}
		筆記用具	2式 ^{※6}
養生シート		2巻 ^{※7}	
粘着マット		2枚 ^{※8}	
脱衣収納袋		8個 ^{※9}	
難燃袋		84枚 ^{※10}	
難燃テープ		12巻 ^{※11}	
クリーンウエス		5缶 ^{※12}	
吸水シート		93枚 ^{※13}	

※1 今後, 訓練等で見直しを行う。
 ※2 エリアの設営に必要な数量
 ※3 各エリア間の4個×1.5倍=6個
 ※4 1台×1.5倍=1.5→2台
 ※5 設置作業用, 脱衣用及び除染用の3本
 ※6 サーベイエリア用及び除染エリア用の2式
 ※7 44.0m² (床及び壁の養生面積) × 2 (補修張替え等) ÷ 90m² / 巻 × 1.5倍 = 1.5→2巻
 ※8 1枚 (設置箇所数) × 1.5倍 = 1.5→2枚
 ※9 8個 (設置箇所数, 修繕しながら使用)
 ※10 8枚 / 日 × 7日 × 1.5倍 = 84枚
 ※11 58.4m (養生エリアの外周距離) × 2 (シートの継ぎ接ぎ対応) × 2 (補修張替え等) ÷ 30m / 巻 × 1.5倍 = 11.7→12巻
 ※12 11名 (中央制御室要員数) × 7日 × 2交替 × 8枚 (マスク, 長靴, 両手及び身体の拭き取りに各2枚) ÷ 300枚 / 缶 = 4.1→5缶
 ※13 簡易シャワーの排水をシートに吸水させることで固体廃棄物として処理する。
 11名 (要員数) × 7日 × 4缶 (1回除染する際の排水量) ÷ 5缶 (シート1枚の吸水量) × 1.5倍 = 92.4→93枚

(5) チェンジングエリアの運用 (出入管理, 脱衣, 汚染検査, 除染, 着衣, 廃棄物管理, チェンジングエリアの維持管理)

a. 出入管理

チェンジングエリアは, 中央制御室の外側が放射性物質により汚染したような状況下において, 中央制御室外で作業を行った要員が, 中央制御室に入室する際に利用する。中央制御室外は, 放射性物質により汚染しているおそれがあることから, 中央制御室外で活動する要員は, 防護具を着用し活動する。

チェンジングエリアのレイアウトは, 第3.3-5図のとおりであり, チェンジングエリアには, 下記の①から④のエリアを設けることで, 中央制御室内への放射性物質の持ち込みを防止する。

： S A 範囲

表 3.3-2 中央制御室チェンジングエリア用資機材

名称	数量 ^{※1}	根拠
チェンジングエリア区画資材	1式	チェンジングエリア設営に必要な数量
養生シート	2巻 ^{※2}	
バリア	4個 ^{※3}	
粘着マット	4枚 ^{※4}	
装備回収箱	6個 ^{※5}	
ヘルメット掛け	1式	
ポリ袋	200枚 ^{※6}	
テープ	12巻 ^{※7}	
ウエス	1箱 ^{※8}	
ウェットティッシュ	5個 ^{※9}	
はさみ	1個	
マジック	2本	
簡易テント	1台 ^{※10}	
簡易シャワー	1台	
簡易タンク	1台	
トレイ	1個	
バケツ	2個	
可搬式空気浄化装置	1式	
チェンジングエリア用照明	2個	

※1 今後, 訓練等で見直しを行う。
 ※2 約35m² (床, 壁の養生面積) × 3 (エリア全面張替え1回分+補修張替え等) ÷ 90m² / 巻 × 1.5倍 = 2巻 (養生シート損傷, 汚染時等)
 ※3 4個 (各エリア間設置箇所数)
 ※4 2枚 (設置箇所数) × 2 (汚染時の交換用) = 4枚
 ※5 6個 (設置箇所数)
 ※6 6枚 (設置箇所) × 3枚 / 日 (1日交換回数) × 7日 × 1.5倍 = 189枚 → 200枚
 ※7 約80m (養生エリアの外周距離) × 3 (エリア全面張替え1回分+補修張替え等) ÷ 30m / 巻 × 1.5倍 = 12巻 (養生シート損傷, 汚染時等)
 ※8 1,200枚 / 箱 (除染等)
 ※9 120枚 / 個 (除染等)
 ※10 960mm × 960mm × 1,600mm (除染エリア設置)



(5) チェンジングエリアの運用 (出入管理, 脱衣, 汚染検査, 除染, 着衣, 要員に汚染が確認された場合の対応, 廃棄物管理, チェンジングエリアの維持管理)

a. 出入管理

チェンジングエリアは, 中央制御室の外側が放射性物質により汚染したような状況下において, 中央制御室に待機していた要員が, 中央制御室外で作業を行った後, 再度, 中央制御室に入室する際等に利用する。中央制御室外は, 放射性物質により汚染しているおそれがあることから, 中央制御室外で活動する要員は防護具を着用し活動する。

チェンジングエリアのレイアウトは図3.3-3のとおりであり, チェンジングエリアには, 下記①から③のエリアを設けることで, 中央制御室内への放射性物質の持ち込みを防止する。

： S A 範囲

柏崎刈羽原子力発電所 6/7号炉 (2017.12.20)	東海第二発電所 (2018.9.18版)	島根原子力発電所 2号炉	備考
<p>① 脱衣エリア 防護具を適切な順番で脱衣するエリア。</p> <p>② サーベイエリア 防護具を脱衣した要員の身体や物品のサーベイを行うエリア。汚染が確認されなければ中央制御室内へ移動する。</p> <p>③ 除染エリア サーベイエリアにて汚染が確認された際に除染を行うエリア。</p> <p>b. 脱衣 チェンジングエリアにおける防護具の脱衣手順は以下のとおり。</p> <ul style="list-style-type: none"> 脱衣エリアの靴脱ぎ場で、<u>汚染区域用靴</u>、ヘルメット、ゴム手袋外側、<u>アノラック</u>等を脱衣する。 脱衣エリアで、<u>不織布カバーオール</u>、ゴム手袋内側、マスク、帽子、靴下、<u>綿手袋</u>を脱衣する。 <p>なお、チェンジングエリアでは、<u>保安班員</u>が要員の脱衣状況を適宜確認し、指導、助言、<u>防護具の脱衣の補助</u>を行う。</p> <p>c. 汚染検査 チェンジングエリアにおける汚染検査手順は以下のとおり。</p>	<p>① 脱衣エリア ・防護具を適切な順番で脱衣するエリア</p> <p>② サーベイエリア ・防護具を脱衣した要員の身体や物品の汚染検査を行うエリア ・汚染が確認されなければ中央制御室内へ移動する。</p> <p>③ 除染エリア ・サーベイエリアにて汚染が確認された際に、除染を行うエリア</p> <p>④ <u>クリーンエリア</u> ・<u>扉付シート壁により区画することで、サーベイエリア等からの汚染の流入を防止するエリア</u></p> <p>b. 脱衣 チェンジングエリアにおける防護具の脱衣手順は、以下のとおり。</p> <ul style="list-style-type: none"> 脱衣エリアの靴脱ぎ場で、<u>安全靴</u>、ヘルメット及び<u>アノラック</u>、靴下（外側）を脱衣する。 脱衣エリア前室で、<u>ゴム手袋（外側）</u>、<u>タイバック</u>等を脱衣する。 脱衣エリア後室で、<u>ゴム手袋（内側）</u>、<u>綿手袋及び靴下（内側）</u>を脱衣する。 <u>マスク及び帽子を着用したまま、サーベイエリアへ移動する。</u> <p>なお、チェンジングエリアでは、放射線管理班員は、要員の脱衣状況について適宜確認し、指導、助言及び防護具の脱衣の補助を行う。</p> <p>c. 汚染検査 チェンジングエリアにおける汚染検査等の手順は、以下のとおり。</p>	<p>①脱衣エリア 防護具を適切な順番で脱衣するエリア。</p> <p>②サーベイエリア 防護具を脱衣した要員の身体や物品のサーベイを行うエリア。 汚染が確認されなければ中央制御室側へ移動する。</p> <p>③除染エリア サーベイエリアにて汚染が確認された際に除染を行うエリア。</p> <p>b. 脱衣 チェンジングエリアにおける防護具の脱衣手順は以下のとおり。</p> <ul style="list-style-type: none"> 脱衣エリア入口で、<u>安全靴</u>、ヘルメット、<u>被水防護服</u>及び<u>ゴム手袋外側</u>を脱衣する。 脱衣エリアで<u>汚染防護服</u>、ゴム手袋内側、マスク、帽子、靴下及び<u>綿手袋</u>を脱衣する。 <p>なお、チェンジングエリアでは、<u>放射線管理班員</u>が要員の脱衣状況を適宜確認し、指導、助言及び防護具の脱衣の補助を行う。</p> <p>c. 汚染検査 チェンジングエリアにおける汚染検査手順は以下のとおり。</p>	<p>備考</p> <ul style="list-style-type: none"> 運用の相違 【東海第二】 島根2号炉は、可搬式空気浄化装置によるエリア内の浄化及び定期的なエリア内の環境測定により汚染流入を防止する
 : SA範囲	 : SA範囲	 : SA範囲	

柏崎刈羽原子力発電所 6/7号炉 (2017.12.20)	東海第二発電所 (2018.9.18版)	島根原子力発電所 2号炉	備考
<p>・脱衣後、サーベイエリアに移動する。</p> <p>・サーベイエリアにて汚染検査を受ける。</p> <p>・汚染基準を満足する場合は、中央制御室へ入室する。 汚染基準を<u>超える</u>場合は、除染エリアに移動する。</p> <p>なお、<u>保安班員</u>でなくても汚染検査ができるように汚染検査の手順について図示等を行う。また、<u>保安班員</u>は汚染検査の状況について、適宜確認し、指導、助言をする。</p> <p>d. 除染</p> <p>サーベイエリア内で重大事故等に対処する要員の汚染が確認された場合は、サーベイエリアに隣接した除染エリアで重大事故等に対処する要員の除染を行う。</p> <p>重大事故等に対処する要員の除染については、クリーンウエスでの拭き取りによる除染を基本とするが、拭き取りにて除染ができない場合も想定し、汚染箇所への水洗によって除染が行えるよう簡易シャワーを設ける。</p> <p>チェンジングエリアにおける除染手順は以下のとおり。</p> <ul style="list-style-type: none"> ・汚染検査にて汚染基準を<u>超える</u>場合は、除染エリアに移動する。 ・汚染箇所をウェットティッシュで拭き取りする。 ・再度汚染箇所について汚染検査する。 ・汚染基準を<u>超える</u>場合は、簡易シャワーで除染する。 (簡易シャワーでも汚染基準を<u>超える</u>場合は、汚染箇所を養生し、再度除染ができる施設へ移動する。) <p style="text-align: right;">: SA範囲</p>	<p>① <u>サーベイエリアにて、マスク及び帽子を着用した状態の頭部の汚染検査を受ける。</u></p> <p>② <u>汚染基準を満足する場合には、マスク及び帽子を脱衣し、全身の汚染検査を受ける。</u></p> <p>③ <u>汚染基準を満足する場合には、脱衣後のマスクを持参し、クリーンエリアを通過して中央制御室へ入室する。</u></p> <p>④ <u>②又は③の汚染検査において、汚染基準を満足しない場合には、除染エリアに移動する。</u></p> <p>なお、<u>放射線管理班員</u>は、<u>放射線管理班員</u>でなくても汚染検査ができるように、汚染検査の手順について図示等を行う。また、<u>放射線管理班員</u>は、<u>汚染検査の状況</u>について適宜確認し、指導及び助言を行う。</p> <p>d. 除染</p> <p>サーベイエリア内で重大事故等に対処する要員の汚染が確認された場合は、サーベイエリアに隣接した除染エリアで重大事故等に対処する要員の除染を行う。</p> <p>重大事故等に対処する要員の除染については、クリーンウエスでの拭き取りによる除染を基本とするが、拭き取りにて除染ができない場合も想定し、汚染箇所への水洗によって除染が行えるよう簡易シャワーを設ける。</p> <p>チェンジングエリアにおける除染手順は、以下のとおり。</p> <ul style="list-style-type: none"> ・汚染検査にて汚染基準を満足しない場合には、除染エリアに移動する。 ・汚染箇所をクリーンウエスで拭き取りする。 ・再度汚染箇所について汚染検査する。 ・汚染基準を満足しない場合には、簡易シャワーで除染する。 (マスク及び帽子を除く) ・簡易シャワーでも汚染基準を満足しない場合には、汚染箇所を養生し、再度除染ができる施設へ移動する。 <p style="text-align: right;">: SA範囲</p>	<p>・<u>脱衣後、サーベイエリアに移動する。</u></p> <p>・サーベイエリアにて汚染検査を受ける。</p> <p>・汚染基準を満足する場合は、中央制御室へ入室する。 汚染基準を<u>満足しない</u>場合は、除染エリアに移動する。</p> <p>なお、<u>放射線管理班員</u>でなくても汚染検査ができるように汚染検査の手順について図示等を行う。また、<u>放射線管理班員</u>は汚染検査の状況について、<u>適宜確認し、指導、助言</u>をする。</p> <p>d. 除染</p> <p>チェンジングエリアにおける除染手順は以下のとおり。</p> <ul style="list-style-type: none"> ・汚染検査にて汚染基準を満足しない場合は、除染エリアに移動する。 ・汚染箇所をウェットティッシュで拭き取りする。 ・再度汚染箇所について汚染検査する。 ・汚染基準を<u>満足しない</u>場合は、簡易シャワーで除染する。 ・簡易シャワーでも汚染基準を<u>満足しない</u>場合は、汚染箇所を養生し、再度除染ができる施設へ移動する。 <p style="text-align: right;">: SA範囲</p>	<p>備考</p> <p>・体制の相違 【柏崎 6/7】</p>

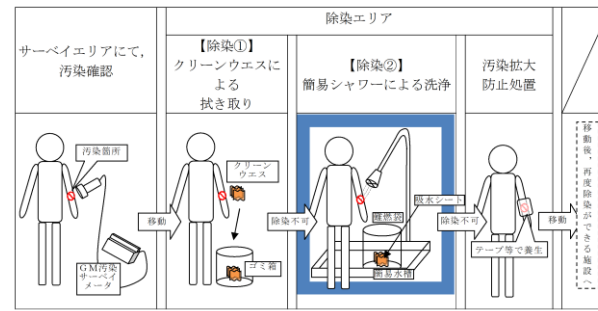

第 3.3-6 図 除染及び汚染水処理イメージ図

: SA 範囲

e. 着衣
 防護具の着衣手順は以下のとおり。

- 中央制御室内で、綿手袋、靴下、帽子、不織布カバーオール、マスク、ゴム手袋内側、ゴム手袋外側等を着衣する。
- チェンジングエリアの靴脱ぎ場で、ヘルメット、汚染区域用靴等を着用する。
- 保安班員は、要員の作業に応じて、アノラック等の着用を指示する。

f. 要員に汚染が確認された場合の対応

サーベイエリア内で要員の汚染が確認された場合は、サーベイエリアに隣接した除染エリアで要員の除染を行う。

要員の除染については、ウェットティッシュでの拭き取りによる除染を基本とするが、拭き取りにて除染できない場合も想定し、汚染箇所への水洗によって除染が行えるよう簡易シャワーを設ける。

簡易シャワーで発生した汚染水は、図3.3-4のとおり必要に応じてウエスへ染み込ませる等により固体廃棄物として処理する。



図 3.3-4 除染及び汚染水処理イメージ図

○ : SA範囲

e. 着衣
 防護具の着衣手順は、以下のとおり。

- 中央制御室内で、綿手袋、靴下内側、靴下外側、帽子、タイバック、マスク、ゴム手袋内側、ゴム手袋外側等を着衣する。
- チェンジングエリアの靴脱ぎ場で、ヘルメット及び靴を着用する。
- 放射線管理班は、要員の作業に応じて、アノラック等の着用を指示する。

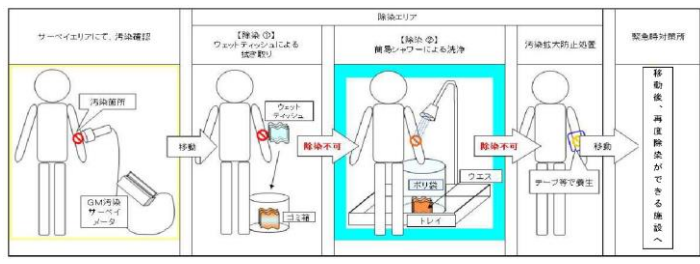
f. 重大事故等に対処する要員に汚染が確認された場合の対応

簡易シャワーで発生した汚染水は、第3.3-6図のとおり、必要に応じて吸水シートへ染み込ませる等により固体廃棄物として処理する。

○ : SA範囲

e. 着衣
 防護具の着衣手順は以下のとおり。

- 中央制御室内で、綿手袋、靴下、帽子、汚染防護服、全面マスク、ゴム手袋内側及びゴム手袋外側等を着衣する。
- 脱衣エリア出口でヘルメット、安全靴等を着用する。
- 放射線管理班員は、要員の作業に応じて、被水防護服等の着用を指示する。

f. 要員に汚染が確認された場合の対応

サーベイエリア内で要員の汚染が確認された場合は、サーベイエリアに隣接した除染エリアで要員の除染を行う。

要員の除染については、ウェットティッシュでの拭き取りによる除染を基本とするが、拭き取りにて除染できない場合も想定し、汚染箇所への水洗によって除染が行えるよう簡易シャワーを設ける。

簡易シャワーで発生した汚染水は、図3.3-4のとおり必要に応じてウエスへ染み込ませる等により固体廃棄物として処理する。







図 3.3-4 除染及び汚染水処理イメージ図

○ : SA範囲

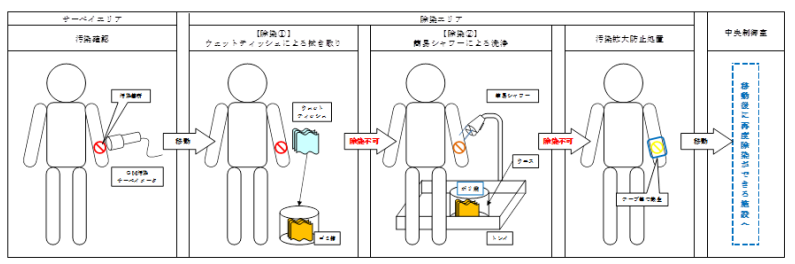
・体制の相違
 【柏崎 6/7, 東海第二】

柏崎刈羽原子力発電所 6 / 7号炉 (2017.12.20)	東海第二発電所 (2018.9.18版)	島根原子力発電所 2号炉	備考
<p>g. 廃棄物管理</p> <p>中央制御室外で活動した要員が脱衣した防護具については、チェンジングエリア内に<u>留め置く</u>とチェンジングエリア内の線量率の上昇及び汚染拡大へつながる要因となることから、適宜チェンジングエリア外に持ち出しチェンジングエリア内の線量率の上昇及び汚染拡大防止を図る。</p> <p>h. チェンジングエリアの維持管理</p> <p>保安班員は、チェンジングエリア内の表面汚染密度、線量率及び空气中放射性物質濃度を定期的(1回/日以上)に測定し、放射性物質の異常な流入や拡大がないことを確認する。</p> <p>プルーム通過後にチェンジングエリアの出入管理を再開する際には、表面汚染密度、線量率及び空气中放射性物質濃度の測定を実施し、必要に応じチェンジングエリアの除染を実施する。なお、測定及び除染を行った要員は、脱衣エリアにて脱衣を行う。</p>	<p>g. 廃棄物管理</p> <p>中央制御室外で活動した要員が脱衣した防護具については、チェンジングエリア内にとどめて置くとチェンジングエリア内の線量当量率の上昇及び汚染拡大につながる要因となることから、適宜チェンジングエリア外に持ち出し、チェンジングエリア内の線量当量率の上昇及び汚染拡大防止を図る。</p> <p>h. チェンジングエリアの維持管理</p> <p>放射線管理班員は、チェンジングエリア内の表面汚染密度、線量当量率及び空气中放射性物質濃度を定期的(1回/日以上)に測定し、放射性物質の異常な流入や拡大がないことを確認する。</p>	<p>g. 廃棄物管理</p> <p>中央制御室外で活動した要員が脱衣した防護具については、チェンジングエリア内にとどめておくとチェンジングエリア内の線量当量率の上昇及び汚染拡大へつながる要因となることから、適宜チェンジングエリア外に持ち出し、<u>チェンジングエリア内の線量当量率の上昇及び汚染拡大防止を図る。</u></p> <p>h. チェンジングエリアの維持管理</p> <p>放射線管理班員は、<u>床・壁等の養生の確認を実施し、養生シート等に損傷が生じている場合は、補修を行う。</u></p> <p>チェンジングエリア内の表面汚染密度、線量当量率及び空气中放射性物質濃度を定期的(1回/日以上)に測定し、放射性物質の異常な流入や拡大がないことを確認する。</p> <p><u>プルーム通過後にチェンジングエリアの出入管理を再開する際には、表面汚染密度、線量当量率及び空气中放射性物質濃度の測定を実施し、必要に応じチェンジングエリアの除染を実施する。なお、測定及び除染を行った要員は、脱衣エリアにて脱衣を行う。</u></p>	
 : SA範囲	 : SA範囲	 : SA範囲	

(6) チェンジングエリアに係る補足事項

a. 可搬型空気浄化装置

チェンジングエリアには、更なる被ばく低減のため、可搬型空気浄化装置を1台設置する。可搬型空気浄化装置は、最も汚染が拡大するおそれのある脱衣エリアの空気を吸い込み浄化するように配置し、脱衣エリアを換気することで、中央制御室外で活動した要員の脱衣による汚染拡大を防止する。

中央制御室内への汚染持込防止を目的とした可搬型空気浄化装置による換気ができていることの確認は、チェンジングエリアのエアテント生地がしぼむ状態になっているかどうかを目視する等により確認する。可搬型空気浄化装置は、脱衣エリアを換気できる風量とし、仕様等を図3.3-5に示す。

なお、中央制御室はブルーム通過時には、原則出入りしない運用とすることから、チェンジングエリアについても、ブルーム通過時は、原則利用しないこととする。したがって、チェンジングエリア用の可搬型空気浄化装置についてもブルーム通過時には運用しないことから、可搬型空気浄化装置のフィルタが高線量化することでの居住性への影響はない。

ただし、可搬型空気浄化装置は長期的に運用する可能性があることから、フィルタの線量が高くなることも想定し、本体（フィルタ含む）の予備を1台設ける。なお、交換したフィルタ等は、線源とならないようチェンジングエリアから遠ざけて保管する。



図 3.3-5 可搬型空気浄化装置の仕様等

: SA範囲

(6) チェンジングエリアの汚染拡大防止について

c. 可搬型空気浄化装置

更なる汚染拡大防止対策として、チェンジングエリアに設置する可搬型空気浄化装置の仕様等を第3.3-10図に示す。

可搬型空気浄化装置による送気が正常に行われていることの確認は、可搬型空気浄化装置に取り付ける吹き流しの動きを目視で確認することで行う。

なお、中央制御室は、原子炉格納容器圧力逃がし装置の操作直後には、原則出入りしない運用とすることから、チェンジングエリアについても、原則利用しないこととする。したがって、チェンジングエリア用の可搬型空気浄化装置についてもこの間は運用しないことから、可搬型空気浄化装置のフィルタが高線量化することによる居住性への影響はない。

ただし、可搬型空気浄化装置は、長期的に運用する可能性があることから、フィルタの線量が高くなることを想定し、本体（フィルタ含む）の予備を1台設ける。なお、交換したフィルタ等は、線源とならないようチェンジングエリアから遠ざけて保管する。

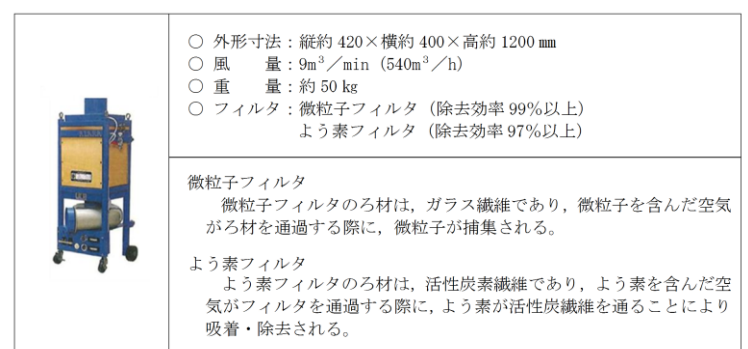

第 3.3-10 図 可搬型空気浄化装置の仕様等

: SA範囲

(6) チェンジングエリアに係る補足事項

a. 可搬式空気浄化装置

チェンジングエリアには、更なる被ばく低減のため、可搬式空気浄化装置を1台設置する。可搬式空気浄化装置は、放射性物質を取り除いた外気をチェンジングエリア内に供給することで正圧化し、放射性物質の流入を防止する。

可搬式空気浄化装置による送気が正常に行われていることの確認は、可搬式空気浄化装置に取り付ける吹き流しの動きを目視により行う。可搬式空気浄化装置の仕様等を図3.3-5に示す。

なお、中央制御室はブルーム通過時には、原則出入りしない運用とすることから、チェンジングエリアについても、ブルーム通過時は、原則利用しないこととする。したがって、チェンジングエリア用の可搬式空気浄化装置についてもブルーム通過時には運用しないことから、可搬式空気浄化装置のフィルタが高線量化することでの居住性への影響はない。

ただし、可搬式空気浄化装置は長期的に運用する可能性があることから、フィルタの線量が高くなることも想定し、本体（フィルタ含む）の予備を1台設ける。なお、交換したフィルタ等は、線源とならないようチェンジングエリアから遠ざけて保管する。



図 3.3-5 可搬式空気浄化装置の仕様等

: SA範囲

・設備の相違

【柏崎 6/7, 東海第二】

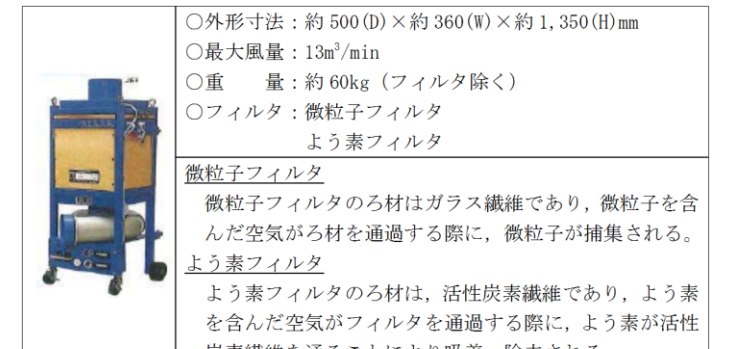
島根 2号炉は、可搬式空気浄化装置により放射性物質を取り除いた外気をチェンジングエリア内に連続して供給（加圧）することで、放射性物質流入を防止

・設備の相違

【柏崎 6/7, 東海第二】



柏崎刈羽原子力発電所 6/7号炉 (2017.12.20)	東海第二発電所 (2018.9.18版)	島根原子力発電所 2号炉	備考
<p>b. <u>チェンジングエリアの設営状況</u></p> <p>チェンジングエリアは、<u>靴脱ぎ場及び脱衣エリアの空間をエアーテントにより区画する。エアーテントの外観は図3.3-6のとおりであり、高圧ポンベにより約3分間送風することで、展張することが可能である。なお、展張は手動及びブロワによる送風も可能な設計とする。</u></p> <p>チェンジングエリア内面は、<u>必要に応じて汚染の除去の容易さの観点から養生シートを貼ることとし、一時閉鎖となる時間を短縮している。</u></p> <p>また、<u>エアーテントに損傷が生じた際は、速やかに補修が行えるよう補修用の資機材を準備する。</u></p>	<p>a. <u>汚染拡大防止の考え方</u></p> <p><u>テントハウスは、各テントハウスの接続部等をテープ養生することで、テントハウス外からの汚染の持ち込みを防止する設計とする。また、テントハウスの出入口等を扉付シート壁で区画することで、中央制御室への汚染の持ち込みを防止する。</u></p> <p><u>チェンジングエリアには、更なる汚染拡大防止対策として、可搬型空気浄化装置を1台設置する。</u></p> <p>b. <u>チェンジングエリアの区画</u></p> <p><u>チェンジングエリアは、テントハウスの出入口、サーベイエリア及びクリーンエリア、除染エリアは扉付のシート壁により区画し、テントの接続部は放射性物質の外部からの流入を防止する設計とする。テントハウスの外観及び設置状況（イメージ）は、第3.3-7図のとおりであり、テントハウスの仕様は、第3.3-3表のとおりである。また、第3.3-8図は、テントハウスの設置状況（イメージ）であり、図中①～⑦の各テントハウス間は、ファスナーを用いて接続する。なお、各テントハウス間の接続は、第3.3-9図のとおりに行う。</u></p> <p><u>中央制御室へアクセスする階段の周囲（階段室及び前後室）は、扉付のシート壁により二重に区画した上で、二重のシート扉は同時に開けない運用とし、テント床面開口部周囲を難燃テープでシールすることで、中央制御室側への空気の流入を防止する。</u></p> <p>チェンジングエリア内面には、<u>汚染除去の容易さの観点から、必要に応じて養生シートを貼ることとし、一時閉鎖となる時間を短縮する。</u></p> <p>さらに、<u>チェンジングエリア内には、靴等に付着した放射性物質を持ち込まないように粘着マットを設置する。</u></p>	<p>b. <u>チェンジングエリアの設営状況</u></p> <p>チェンジングエリアは、<u>区画資材により区画する。チェンジングエリアの外観は、図3.3-6のとおりであり、チェンジングエリア区画資材の仕様は表3.3-3のとおりである。</u></p> <p>チェンジングエリア内面は、<u>汚染の除去の容易さの観点から、必要に応じて養生シートを貼ることとし、一時閉鎖となる時間を短縮している。</u></p> <p>更に、<u>チェンジングエリア内には、靴等に付着した放射性物質を持ち込まないように粘着マットを設置する。</u></p> <p><u>また、チェンジングエリア区画資材に損傷が生じた際は、速やかに補修が行えるよう補修用の資機材を準備する。</u></p>	<p>備考</p> <ul style="list-style-type: none"> ・設備の相違 【柏崎6/7,東海第二】 島根2号炉のチェンジングエリアは、パネル取付ユニット方式を採用 ・設備の相違 【柏崎6/7,東海第二】 島根2号炉のチェンジングエリアは、パネル取付ユニット方式を採用
 : SA範囲	 : SA範囲	 : SA範囲	



図 3.3-6 エアーテントの外観



第 3.3-7 図 テントハウスの外観 (イメージ)

第 3.3-3 表 テントハウスの仕様

項目	仕様
サイズ	幅 1.0~2.8m×奥行 0.9m~3.6m×高さ 2.3m 程度
本体重量	40 kg 程度 ^{※1}
サイズ (折り畳み時)	80 cm×140 cm×40 cm 程度 ^{※1}
送風時間 (専用プロフ) ^{※2}	約 2 分 ^{※1}
構造	7 張りのテントハウスを連結して組み立て

※1 幅 2m×奥行 2m×高さ 2.4m のテントハウスでの数値

※2 手動及び高圧ポンペを用いた送風による展開も可能な設計とする。



図 3.3-6 チェンジングエリアの外観

表 3.3-3 チェンジングエリア区画資材の仕様

サイズ (設営時)	幅 1.5m×奥行 3.5m×高さ 2.0m 程度 (脱衣エリア)
	幅 2.0m×奥行 3.0m×高さ 2.0m 程度 (サーバイエリア)
	幅 1.5m×奥行 1.5m×高さ 2.0m 程度 (除染エリア)
サイズ (保管時)	幅 1.0m×奥行 1.5m×高さ 2.0m 程度
本体重量	約 200kg (総重量)
材質	軽量アルミフレーム, 中空ポリカーボネートボード

・設備の相違
【柏崎 6/7, 東海第二】
 島根 2 号炉のチェンジングエリアは, パネル取付ユニット方式を採用

: SA 範囲

: SA 範囲

: SA 範囲

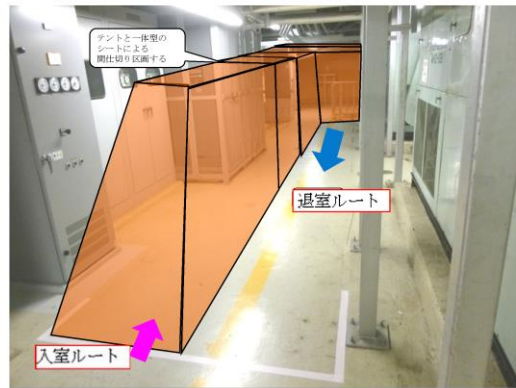
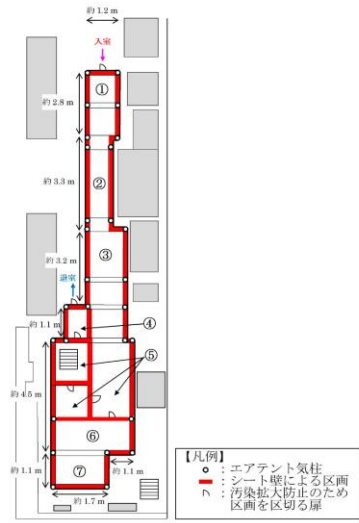



第3.3-8図 テントハウスの設置状況 (イメージ)



第3.3-9図 各テントハウス間の接続 (イメージ)

： S A 範囲

柏崎刈羽原子力発電所 6/7号炉 (2017.12.20)	東海第二発電所 (2018.9.18版)	島根原子力発電所 2号炉	備考
<p>c. チェンジングエリアへの空気の流れ</p> <p>中央制御室チェンジングエリアは、一定の気密性が確保された<u>コントロール建屋</u>内に設置し、<u>図3.3-7</u>のように、<u>汚染の区分ごとにエリアを区画し、汚染を管理する。</u></p> <p>また、更なる被ばく低減のため、<u>可搬型空気浄化装置</u>を1台設置する。<u>可搬型空気浄化装置は、脱衣を行うホットエリアの空気を吸い込み浄化し、ホットエリアを換気することで脱衣による汚染拡大を防止するとともに、チェンジングエリア周辺を循環運転することによりチェンジングエリア周辺の放射性物質を低減する。</u></p> <p>図3.3-7のようにチェンジングエリア内に空気の流れをつくることで脱衣による汚染拡大を防止する。</p>	<p>d. チェンジングエリアへの空気の流れ</p> <p>チェンジングエリアは、<u>第3.3-11図</u>のように、<u>汚染の区分ごとに空間を区画し、汚染を管理する。</u></p> <p>また、更なる<u>汚染拡大防止</u>のために設置する<u>可搬型空気浄化装置</u>により、<u>中央制御室へアクセスする階段室及びその前後室に浄化された空気を送り込むことで、中央制御室へ放射性物質が流入することを防止する。</u></p> <p><u>第3.3-11図及び第3.3-12図</u>のとおり、チェンジングエリア内に空気の流れを作ること、<u>中央制御室への汚染の持ち込みを防止する。</u>なお、<u>テントハウス出入口は、カーテンシートとすることで、外部への空気の流れを確保する。</u></p>	<p>c. チェンジングエリアへの空気の流れ</p> <p>中央制御室チェンジングエリアは、一定の気密性が確保された<u>タービン建物</u>内に設置し、<u>図3.3-7</u>のように、<u>汚染の区分ごとにエリアを区画し、汚染を管理する。</u></p> <p>また、更なる被ばく低減のため、<u>可搬式空気浄化装置</u>を1台設置する。</p> <p>可搬式空気浄化装置は、<u>放射性物質を取り除いた外気をチェンジングエリア内に供給することで正圧化し、放射性物質の流入を防止する。</u></p> <p><u>図3.3-7</u>のように<u>脱衣エリア及び除染エリアの空気がサーベイエリアへ流入しないよう、可搬式空気浄化装置から各エリアに供給する風量を調整し、チェンジングエリア内に空気の流れをつくることで、中央制御室内に汚染を持ち込まないよう管理する。</u></p>	<p>備考</p> <p>・設備の相違</p> <p>【柏崎6/7,東海第二】 設置場所の相違</p>
 : SA範囲	 : SA範囲	 : SA範囲	



図 3.3-7 中央制御室チェンジングエリアの空気の流れ

： SA 範囲

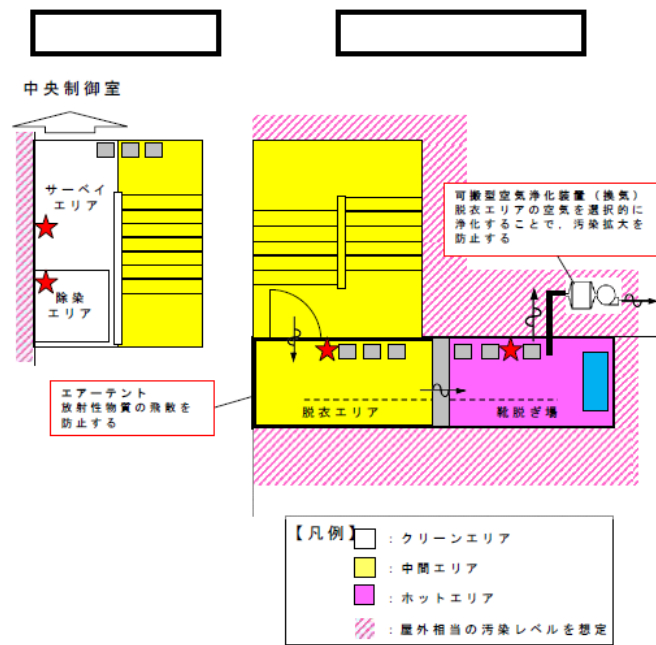
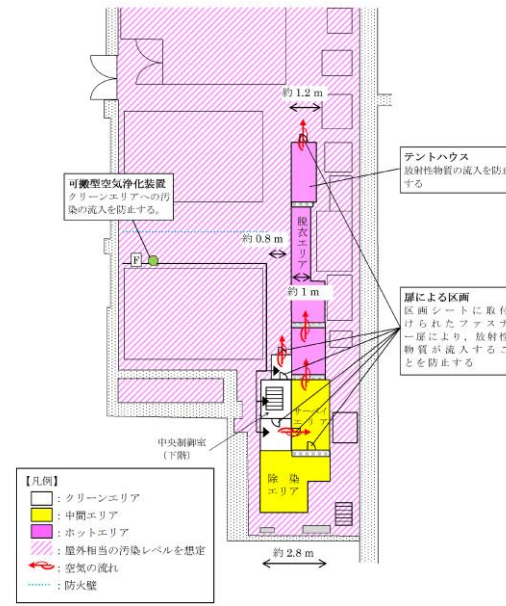

第 3.3-11 図 中央制御室チェンジングエリアの空気の流れ

： SA 範囲







図 3.3-7 チェンジングエリアの空気の流れ

： SA 範囲

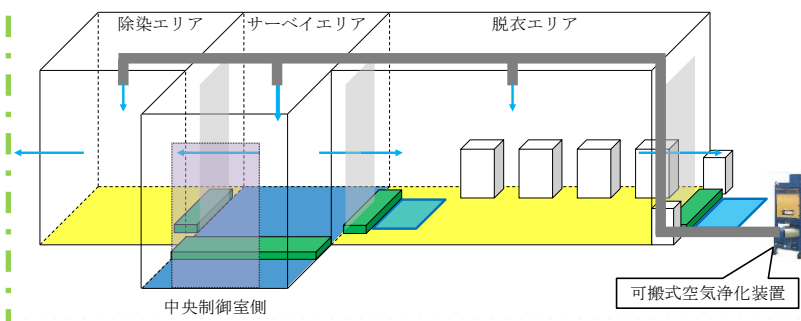
・設備の相違
【柏崎 6/7, 東海第二】
概要図の相違

柏崎刈羽原子力発電所 6/7号炉 (2017.12.20)	東海第二発電所 (2018.9.18版)	島根原子力発電所 2号炉	備考
<p>d. <u>チェンジングエリアでのクロスコンタミ防止について</u></p> <p>中央制御室に入室しようとする要員に付着した汚染が、他の要員に伝播することがないようサーベイエリアにおいて要員の汚染が確認された場合は、汚染箇所を養生するとともに、サーベイエリア内に汚染が移行していないことを確認する。</p> <p>サーベイエリア内に汚染が確認された場合は、一時的にチェンジングエリアを閉鎖するが、速やかに養生シートを張り替える等により、要員の出入りに大きな影響は与えないようにする。</p> <p>ただし、中央制御室から緊急に現場に行く必要がある場合は、張り替え途中であっても、退室する要員は防護具を着用していることから、退室することは可能である。</p> <p>また、<u>中央制御室への入室の動線と退室の動線を分離</u>することで、脱衣時の接触を防止する。なお、中央制御室から退室する要員は、防護具を着用しているため、中央制御室に入室しようとする要員と接触したとしても、汚染が身体に付着することはない。</p>	<p>e. <u>チェンジングエリアでのクロスコンタミ防止について</u></p> <p>中央制御室に入室しようとする要員に付着した汚染が他の要員に伝播することがないように、サーベイエリアにおいて要員の汚染が確認された場合には、汚染箇所を養生するとともにサーベイエリア内に汚染が<u>拡大</u>していないことを確認する。</p> <p>サーベイエリア内に汚染が確認された場合には、速やかに養生シートを張り替える等により、要員の出入りに<u>極力</u>影響を与えないようにする。</p> <p>また、<u>チェンジングエリア内は一方通行とし、扉付シート壁により、入域ルート側の汚染が退域エリアに伝播することを防止する。さらに脱衣エリアでは一人ずつ脱衣を行う運用とすることで、脱衣する要員同士の接触を防止する。</u></p>	<p>d. <u>チェンジングエリアでのクロスコンタミ防止について</u></p> <p>中央制御室に入室しようとする要員に付着した汚染が、他の要員に伝播することがないようサーベイエリアにおいて要員の汚染が確認された場合は、汚染箇所を養生するとともに、サーベイエリア内に汚染が<u>移行</u>していないことを確認する。</p> <p>サーベイエリア内に汚染が確認された場合は、<u>一時的にチェンジングエリアを閉鎖するが、速やかに養生シートを張り替える等により、要員の出入りに大きな影響を与えないようにする。</u></p> <p>ただし、<u>中央制御室から緊急に現場に行く必要がある場合は、張り替え途中であっても、退室する要員は防護具を着用していることから、退室することは可能である。</u></p> <p>また、<u>脱衣エリアでは一人ずつ脱衣を行う運用とすることで、脱衣する要員同士の接触を防止する。なお、中央制御室から退室する要員は、防護具を着用しているため、中央制御室に入室しようとする要員と接触したとしても、汚染が身体に付着することはない。</u></p>	<p>備考</p> <p>・運用の相違</p> <p>【柏崎6/7】</p> <p>島根2号炉は、動線は分離せず要員1人ずつ脱衣を実施</p>
 : SA範囲	 : SA範囲	 : SA範囲	

(7) 汚染の管理基準
 表3.3-3のとおり、状況に応じた汚染の管理基準を運用する。
 ただし、サーベイエリアのバックグラウンドに応じて、表3.3-3の管理基準での運用が困難となった場合は、バックグラウンドと識別できる値を設定する。
表 3.3-3 汚染の管理基準

状況	汚染の管理基準	根拠等
状況① 屋外(発電所構内全般)へ少量の放射性物質が漏えい又は放出されるような原子力災害時	1,300cpm (4Bq/cm ²)	法令に定める表面汚染密度限度(アルファ線を放出しない放射性同位元素の表面汚染密度限度) : 40Bq/cm ² の1/10
状況② 大規模プルームが放出されるような原子力災害時	40,000cpm (120Bq/cm ²)	原子力災害対策指針におけるOIL4に準拠
	13,000cpm (40Bq/cm ²)	原子力災害対策指針におけるOIL4【1ヶ月後の値】に準拠

(8) 中央制御室におけるマスク着用の要否について
炉心損傷の判断後に運転員が中央制御室に滞在する場合、又は現場作業を実施する際に全面マスク等を着用する。

： S A 範囲

(7) 汚染の管理基準
 第3.3-4表のとおり、状況に応じた汚染の管理基準を運用する。ただし、サーベイエリアのバックグラウンドに応じて、第3.3-4表の管理基準での運用が困難となった場合は、バックグラウンドと識別できる値を設定する。

第 3.3-4 表 汚染の管理基準

状況	汚染の管理基準	根拠等
状況① 屋外(発電所構内全般)へ少量の放射性物質が漏えい又は放出されるような原子力災害時	1,300 cpm (4 Bq/cm ² 相当)	法令に定める表面汚染密度限度(アルファ線を放出しない放射性同位元素の表面汚染密度限度 : 40 Bq/cm ² の1/10)
状況② 大規模プルームが放出されるような原子力災害時	13,000 cpm (40 Bq/cm ² 相当)	原子力災害対策指針におけるOIL4【1ヶ月後の値】に準拠
	40,000 cpm (120 Bq/cm ² 相当)	原子力災害対策指針におけるOIL4に準拠

： S A 範囲

(7) 汚染の管理基準
 表3.3-4のとおり、状況に応じた汚染の管理基準を運用する。ただし、サーベイエリアのバックグラウンドに応じて、表3.3-4の管理基準での運用が困難となった場合は、バックグラウンドと識別できる値を設定する。

表 3.3-4 汚染の管理基準

状況	汚染の管理基準 ^{*1}	根拠等
状況① 屋外(発電所構内全般)へ少量の放射性物質が漏えい又は放出されるような原子力災害時	1,300cpm ^{*2}	法令に定める表面汚染密度限度(アルファ線を放出しない放射性同位元素の表面汚染密度限度) : 40Bq/cm ² の1/10
状況② 大規模プルームが放出されるような原子力災害時	40,000cpm ^{*3}	原子力災害対策指針におけるOIL4に準拠
	13,000cpm ^{*4}	原子力災害対策指針におけるOIL4【1ヶ月後の値】に準拠

※1 : 計測器の仕様や構成により係数率が異なる場合は、計測器毎の数値を確認しておく。また、測定する場所のバックグラウンドに留意する必要がある。
 ※2 : 4 Bq/cm²相当。
 ※3 : 120Bq/cm²相当。バックグラウンドが高い状況化に適用。バックグラウンドの影響が相対的に小さくなる数値のうち、最低の水準(バックグラウンドのノイズに信号が埋まらないレベルとして3倍程度の余裕を見込む水準)として設定(13,000×3≒40,000cpm)。
 ※4 : 40Bq/cm²相当(放射性ヨウ素の吸入により小児の甲状腺等価線量が100mSvに相当する内部被ばくをもたらすと想定される体表面密度)。

(8) 中央制御室におけるマスク着用の要否について
中央制御室内は、中央制御室換気系により正圧化することで希ガス以外の放射性物質の流入防止対策は行っているが、表3.3-5のとおりヨウ素の一部を除去しきれないため、全面マスク等の着用が必要となる。

表 3.3-5 中央制御室換気系のフィルタ除去効率

種類	総合除去効率 (%)
粒子用高効率フィルタ	99.9 (0.3μm粒子 ^{*1})
チャコール・フィルタ	95 (相対湿度70%以下 ^{*2})

※1 : 日本工業規格 JIS Z 4812-1975「放射性エアロゾル用高性能エアフィルタ HEPA Filters for Radioactive Aerosols」に基づき設定
 ※2 : 非常用チャコール・フィルタ・ユニット入口の空気条件に基づき設定

： S A 範囲

備考
 ・運用の相違
 【東海第二】
 島根2号炉はヨウ素の一部を除去しきれないことから全面マスク等を着用する
 ・記載方針の相違
 【柏崎6/7, 東海第二】
 島根2号炉は設計条件を記載

(9) 乾電池内蔵型照明
 チェンジングエリア設置場所付近の全照明が消灯した場合に乾電池内蔵型照明を使用する。乾電池内蔵型照明は、脱衣、汚染検査、除染時に必要な照度を確保するために表3.3-4に示す数量及び仕様とする。

表 3.3-4 チェンジングエリアの乾電池内蔵型照明

保管場所	数量	仕様
中央制御室	4台 (予備1台)	電源：乾電池 (単一×3) 点灯可能時間：約72時間 (消灯した場合、予備を点灯させ、乾電池交換を実施する。)



: SA範囲

(8) 可搬型照明 (SA)
 チェンジングエリア設置場所付近の全照明が消灯した場合に使用する可搬型照明 (SA) は、チェンジングエリアの設置、脱衣、汚染検査及び除染時に必要な照度を確保するために、3個 (予備1個) を使用する。可搬型照明 (SA) の仕様を第3.3-5表に示す。

第 3.3-5 表 チェンジングエリアの可搬型照明 (SA)

名称及び外観	保管場所	数量	仕様
可搬型照明 (SA) 	原子炉建屋付属棟4階 空調機械室	4個 (予備1個含む)	(AC) 100V-240V 点灯時間： 片面 20~24時間 両面 10~12時間

チェンジングエリア内は、第3.3-13図に示すように、設置する可搬型照明 (SA) により5ルクス以上の照度が確保可能であり、問題なく設営、運用等が行えることを確認している。

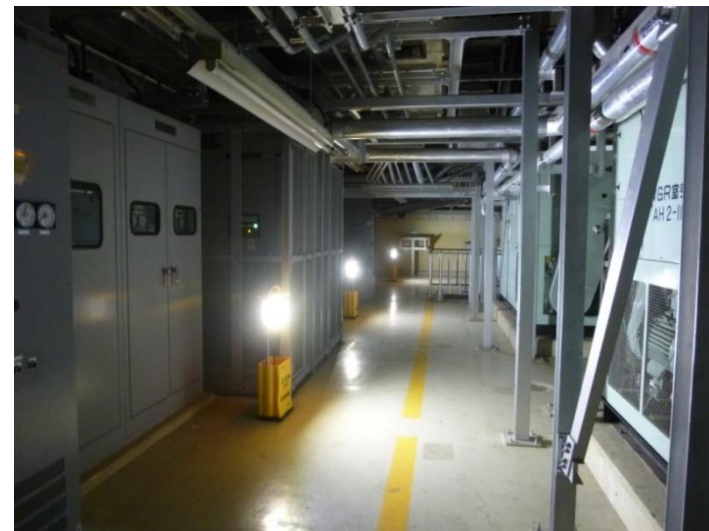

第 3.3-13 図 チェンジングエリア設置場所における可搬型照明 (SA) 確認状況

: SA範囲

(9) チェンジングエリア用照明
 チェンジングエリア設置場所付近の全照明が消灯した場合に使用するチェンジングエリア用照明は、チェンジングエリアの設置、脱衣、汚染検査、除染時に必要な照度を確保するために表3.3-6に示す数量及び仕様とする。

表 3.3-6 チェンジングエリア用照明

外観図	保管場所	数量	仕様
チェンジングエリア用照明 	中央制御室 前通路	2個 (予備1個)	電源：蓄電池 点灯可能時間：満充電から4.5時間

: SA範囲

・設備の相違
【柏崎6/7, 東海第二】
 島根2号炉はLED照明を使用する

柏崎刈羽原子力発電所 6/7号炉 (2017.12.20)	東海第二発電所 (2018.9.18版)	島根原子力発電所 2号炉	備考
<p>(10) <u>チェンジングエリアのスペースについて</u></p> <p>中央制御室における現場作業を行う運転員は、<u>2名1組で4組を想定し、同時に8名の運転員がチェンジングエリア内に収容できる設計とする。チェンジングエリアに同時に8名の要員が来た場合、全ての要員が中央制御室に入りきるまで約21分であり、全ての要員が汚染している場合でも約36分であることを確認している。</u></p> <p>また、仮に想定人数以上の要員が同時にチェンジングエリアに来た場合でも、チェンジングエリアは建屋内に設置しており、屋外での待機はなく不要な被ばくを防止することができる。</p> <p>(11) <u>保安班の緊急時対応のケーススタディー</u></p> <p><u>保安班は、チェンジングエリアの設置以外に、緊急時対策所の可搬型陽圧化空調機運転(60分)、可搬型エリアモニタの設置(20分)、可搬型モニタリングポストの設置(最大435分)、可搬型気象観測装置の設置(90分)を行うことを想定している。これら対応項目の優先順位については、保安班長が状況に応じ判断する。以下にタイムチャートの例を示す。なお、緊急時対策所のチェンジングエリアは、北東側ルートを設営した場合(90分)を想定する。</u></p> <p>例えば、平日の勤務時間帯に事故が発生した場合(ケース①)には、<u>全ての対応を並行して実施することになる。</u></p> <p>また、夜間及び休日(平日の勤務時間帯以外)に事故が発生した場合で、原子力災害対策特別措置法第10条発生直後から周辺環境が汚染してしまうような事象が発生した場合(ケース②)は、原子力防災組織の緊急時対策要員の保安班2名で、チェンジングエリアの設営を優先し、次に可搬型モニタリングポスト等の設置を行うことになる。</p>	<p>(9) <u>チェンジングエリアのスペースについて</u></p> <p>中央制御室における現場作業を行う運転員等は、<u>2名1組で2組を想定し、同時に4名の運転員等がチェンジングエリア内に収容できる設計とする。チェンジングエリアに同時に4名の要員が来た場合、全ての要員が中央制御室に入りきるまで約14分(1人目の脱衣に6分+その後、順次汚染検査2分×4名)と設定し、全ての要員が汚染している場合でも、除染が完了し中央制御室に入りきるまで約22分と設定しており、訓練によりこれを下回る時間で退城できることを確認している。</u></p> <p>また、仮に想定人数以上の要員が同時にチェンジングエリアに来た場合でも、チェンジングエリアは、建屋内に設置しているため、屋外での待機はなく、不要な被ばくを防止することができる。</p> <p>(10) <u>放射線管理班の緊急時対応のケーススタディー</u></p> <p>放射線管理班は、チェンジングエリアの設置以外に、緊急時対策所可搬型エリアモニタの設置(10分)、可搬型モニタリング・ポストの設置(最大475分)及び可搬型気象観測設備の設置(80分)を行うことを<u>技術的能力にて説明</u>している。これら対応項目の優先順位については、放射線管理班長が状況に応じて判断する。</p> <p>例えば、平日<u>昼間に事故が発生した場合(ケース①)には、放射線管理班員4名にて緊急時対策所可搬型エリアモニタ、可搬型モニタリング・ポスト及び可搬型気象観測設備の設置を優先し、その後チェンジングエリアの設置作業を行う。</u></p> <p>夜間・休祭日に事故が発生した場合(ケース②)には、<u>放射線管理班員2名にて緊急時対策所可搬型エリアモニタ、可搬型モニタリング・ポスト(緊急時対策所加圧判断用)及び可搬型気象観測設備の設置を行い、その後、参集した要員がチェンジングエリアの設置を行う。要員参集後(発災から2時間後)、参集した放射線管理班員にてチェンジングエリアの設置作業を行うことで、平日昼間のケースと同等の時間で設置を行える。なお、チェンジングエリアの運用については、エリア使用の都度、放射線管理班</u></p>	<p>(10) <u>チェンジングエリアのスペースについて</u></p> <p>中央制御室における現場作業を行う運転員は、<u>2名1組で2組を想定し、同時に4名の運転員がチェンジングエリア内に収容できる設計とする。チェンジングエリアに同時に4名の要員が来た場合、全ての要員が中央制御室に入りきるまで16分(脱衣2分、汚染検査2分×4人)であり、全ての要員が汚染している場合でも除染が完了し中央制御室に入りきるまで36分(脱衣2分、汚染検査2分、除染3分、汚染検査2分×4人)であることを確認している。</u></p> <p>また、仮に想定人数以上の要員が同時にチェンジングエリアに来た場合でも、チェンジングエリアは建物内に設置しており、屋外での待機はなく、不要な被ばくを防止することができる。</p> <p>(11) <u>放射線管理班の緊急時対応のケーススタディー</u></p> <p><u>放射線管理班は、中央制御室チェンジングエリアの設置以外に、緊急時対策所の可搬式エリア放射線モニタの設置(20分以内)、可搬式モニタリング・ポストの設置(最大6時間30分以内)、可搬式気象観測装置の設置(3時間10分以内)、緊急時対策所チェンジングエリアの設営(20分以内)を行うことを想定している。これら対応項目の優先順位については、放射線管理班長が状況に応じ判断する。以下にタイムチャートの例を示す。</u></p> <p>例えば、平日の勤務時間帯に事故が発生した場合(ケース①)には、<u>全ての対応を並行して実施することになる。</u></p> <p>また、夜間及び休日昼間(平日の勤務時間帯以外)に事故が発生した場合で、原子力災害対策特別措置法第10条特定事象発生直後から周辺環境が汚染してしまうような事象が発生した場合(ケース②)は、原子力防災組織の緊急時対策要員の放射線管理班2名で、チェンジングエリアの設営を優先し、次に可搬式モニタリング・ポスト等の設置を行うことになる。</p>	<p>備考</p> <p>・体制及び運用の相違 【柏崎6/7,東海第二】</p> <p>・体制及び運用の相違 【柏崎6/7,東海第二】</p> <p>・設備の相違 【柏崎6/7】 島根2号炉は、緊急時対策所入口にチェンジングエリアを常時設置</p> <p>・運用の相違 【東海第二】 島根2号炉は、周辺環境が汚染してしまうような事象が発生した場合、中央制御室のチェンジングエリアの設営を優先</p> <p>・体制の相違 【柏崎6/7】</p>
: SA範囲	: SA範囲	: SA範囲	

柏崎刈羽原子力発電所 6 / 7号炉 (2017.12.20)	東海第二発電所 (2018.9.18版)	島根原子力発電所 2号炉	備考
	<p>(11) <u>チェンジングエリア設置前の汚染の持ち込み防止について</u></p> <p>夜間・休祭日は、参集要員によりチェンジングエリアの設置を行う可能性があるが、事象発生からチェンジングエリアの初期運用の開始※¹まで3時間程度※²要する場合が考えられる。その場合において、チェンジングエリアの初期運用開始までは、下記の対応により中央制御室への過度な汚染の持ち込みを防止する。</p> <ul style="list-style-type: none"> ▶ 運転員等は、自ら汚染検査を実施し、必要に応じ除染（クリーンウエスによる拭取り）を行った上で、中央制御室に入室する。 ▶ 放射線管理班員は、チェンジングエリアの初期運用開始に必要なサーベイエリア及び除染エリアを設営後、運転員等の再検査を実施し、必要に応じて除染（クリーンウエスでの拭き取り又は簡易シャワーによる水洗）を行う。また、放射線管理班員は、中央制御室内の環境測定を行う。 ▶ <u>中央制御室とチェンジングエリアの間に設置する気密扉により中央制御室バウンダリを区画する。</u> ▶ 仮に中央制御室に汚染が持ち込まれた場合でも、中央制御室換気系により中央制御室内を浄化することで、中央制御室の居住性を確保する。 <p>詳細な手順は (5) チェンジングエリアの運用に従う。</p> <p>※1 <u>サーベイエリア、除染エリア及びクリーンエリアの設営</u></p> <p>※2 <u>2時間（参集時間）+1時間（サーベイエリア及び除染エリアの設営）</u></p> <p style="text-align: right;">: SA範囲</p>	<p>(12) <u>チェンジングエリア設置前の汚染の持ち込み防止について</u></p> <p>チェンジングエリアの運用開始までに、事象発生から2時間程度要するため、チェンジングエリアの運用開始までは、下記の対応により中央制御室への過度な汚染の持ち込みを防止する。</p> <ul style="list-style-type: none"> ▶ <u>運転員は、自ら汚染検査を実施し、必要に応じ除染（ウェットティッシュによる拭取り）を行った上で、中央制御室に入室する。</u> ▶ <u>放射線管理班員は、チェンジングエリアの運用開始に必要な脱衣エリア、サーベイエリア及び除染エリアを設営後、運転員の再検査を実施し、必要に応じ除染（ウェットティッシュでの拭き取り又は簡易シャワーによる水洗）を行う。また、中央制御室内の環境測定を行う。</u> ▶ <u>なお、仮に中央制御室に汚染が持ち込まれた場合でも、中央制御室換気系により中央制御室内を浄化することで、中央制御室の居住性を確保する。</u> <p>詳細な手順は「(5) <u>チェンジングエリアの運用</u>」に従う。</p> <p style="text-align: right;">: SA範囲</p>	<p>・体制及び運用の相違 【東海第二】</p> <p>・設備の相違 【東海第二】 島根2号炉は、気密扉を設置しない</p>

柏崎刈羽原子力発電所 6/7号炉 (2017.12.20)	東海第二発電所 (2018.9.18版)	島根原子力発電所 2号炉	備考
<p>3.4 中央制御室への地震及び火災等の影響</p> <p>地震、津波、自然災害（竜巻等）、及び火災、溢水について、中央制御室に影響を与える事象を抽出し、対応について整理した。</p> <p>中央制御室に影響を与える可能性のある事象として、表3.4-1に示す起因事象（内部火災、内部溢水、地震等）と同時にもたらされる環境条件が考えられるが、いずれの場合でも中央制御室での運転操作に影響を与えることはない。</p> <p>中央制御室における主な対応を以下に示す。</p> <p>○ 地震</p> <p>6号炉及び7号炉中央制御室の大型表示盤付近で被災した場合、運転員は制御盤への誤接触、運転員自身の転倒を防止するため、制御盤の手摺にて安全を確保するとともに警報発信状況等の把握に努める。また地震時においても運転員が必要な監視操作を行うことができるよう、中央制御室は基準地震動Ssに対し耐震性を有するコントロール建屋2階に設置するとともに、制御盤は必要な耐震性を有する設計とする。</p> <p>○ 津波</p> <p>6号炉及び7号炉中央制御室を設置する敷地における基準津波の最高水位はT.M.S.L.+8.3m程度である。6号炉及び7号炉中央制御室を設置しているコントロール建屋は敷地高さT.M.S.L.+12mに施設されており、また6号炉及び7号炉中央制御室はコントロール建屋2階フロア（T.M.S.L.+17.3m）に設置している。このことより、6号炉及び7号炉中央制御室及びアクセスルートは基準津波の影響を受けない設計とする。</p>	<p>3.4 中央制御室への地震及び火災等の影響</p> <p>地震、自然災害（竜巻等）、火災及び溢水について、中央制御室に影響を与える事象を抽出し、対応について整理した。</p> <p>中央制御室に影響を与える可能性のある事象として、第3.4-1表に示す起因事象（内部火災、内部溢水、地震等）と同時にもたらされる環境条件が考えられるが、いずれの場合でも中央制御室での運転操作に影響を与えることはない。</p> <p>中央制御室における主な対応を以下に示す。</p> <p>(1) 地震</p> <p>中央制御室及び制御盤は、耐震Sクラスの原子炉建屋付属棟内に設置し、基準地震動による地震力に対し必要となる機能が喪失しない設計とする。また、制御盤は床等に固定することにより、地震発生時においても運転操作に影響を与えない設計とする。さらに、制御盤に手すりを設置するとともに、天井照明設備には落下防止措置を講じることにより、地震発生時における運転員の安全確保及び制御盤上の操作器への誤接触防止が可能な設計とする。</p>	<p>3.4 中央制御室への地震及び火災等の影響</p> <p>地震、津波、自然災害（竜巻等）、及び火災、溢水について、中央制御室に影響を与える事象を抽出し、対応について整理した。</p> <p>中央制御室に影響を与える可能性のある事象として、表3.4-1に示す起因事象（内部火災、内部溢水、地震等）と同時にもたらされる環境条件が考えられるが、いずれの場合でも中央制御室での運転操作に影響を与えることはない。</p> <p>中央制御室における主な対応を以下に示す。</p> <p>○地震</p> <p>中央制御室の制御盤エリア付近で被災した場合、運転員は制御盤への誤接触、自身の転倒を防止するため、制御盤の手摺にて安全を確保するとともに警報発信状況等の把握に努める。また、地震時においても運転員が必要な監視操作を行うことができるよう、中央制御室は耐震Sクラスの制御室建物4階に設置するとともに、制御盤は必要な耐震性を有する設計としている。</p> <p>○津波</p> <p>中央制御室を設置する敷地に対して基準津波の最高水位はEL11.8m程度である。中央制御室を設置している制御室建物は敷地高さEL15mに施設されており、また、中央制御室は制御室建物4階（EL16.9m）に設置している。このことにより、中央制御室及びアクセスルートは基準津波の影響を受けない設計としている。</p>	<p>備考</p> <ul style="list-style-type: none"> ・申請号炉数の相違【柏崎6/7】 ・施設の相違【柏崎6/7,東海第二】 ・記載方針の相違【東海第二】 島根2号炉は津波の影響について記載 ・申請号炉数の相違【柏崎6/7】
<p style="text-align: right;">□ : DB範囲</p>	<p style="text-align: right;">□ : DB範囲</p>	<p style="text-align: right;">□ : DB範囲</p>	

柏崎刈羽原子力発電所 6 / 7号炉 (2017.12.20)	東海第二発電所 (2018.9.18版)	島根原子力発電所 2号炉	備考
<p>○ 火災 中央制御室にて火災が発生した場合は運転員が火災状況を確認できる設計とし、初期消火を行うことができるよう消火器を設置している。 また、中央制御室外で発生した火災に対しても、中央制御室の機能に影響を与えない設計とする。</p> <p>○ 溢水 中央制御室には溢水源は存在しないことを確認している。 万一、火災が発生したとしても、運転員が火災状況を確認し、消火器にて初期消火を行うこととしているため、消火活動に伴う内部溢水による影響はない。 また、中央制御室外で発生した溢水に対しても、中央制御室の機能に影響を与えない設計とする。</p>	<p>(2) 火災 中央制御室にて火災が発生した場合は運転員が火災状況を確認できる設計とし、初期消火を行うことができるように、消火器を設置する。 また、中央制御室外で発生した火災に対しても、中央制御室の機能に影響を与えない設計とする。</p> <p>(3) 溢水 中央制御室内には溢水源がない設計とする。 万一、火災が発生したとしても、運転員が火災状況を確認し、消火器にて初期消火を行うこととしているため、消火活動に伴う内部溢水による影響はない。 また、中央制御室外で発生した溢水に対しても、中央制御室の機能に影響を与えない設計とする。</p>	<p>○火災 中央制御室にて火災が発生した場合は、運転員が火災状況を確認できる設計とし、初期消火を行うことができるよう消火器を設置している。 また、中央制御室外で発生した火災に対しても、中央制御室の機能に影響を与えない設計としている。</p> <p>○溢水 中央制御室には溢水源は存在しないことを確認している。 万一、火災が発生したとしても、運転員が火災状況を確認し、消火器にて初期消火を行うこととしているため、消火活動に伴う内部溢水による影響はない。 また、中央制御室外で発生した溢水に対しても、中央制御室の機能に影響を与えない設計としている。</p>	
<p style="text-align: right;">□ : DB 範囲</p>	<p style="text-align: right;">□ : DB 範囲</p>	<p style="text-align: right;">□ : DB 範囲</p>	

表 3.4-1 中央制御室に同時にもたらされる環境条件への対応 (1/2)

起回事象	同時にもたらされる中央制御室の環境条件	中央制御室での運転操作に与える影響
内部火災 (地震起因含む)	火災による中央制御室内設備の機能喪失	中央制御室にて火災が発生しても速やかに消火できるよう、「運転員が火災状況を確認し、二酸化炭素消火器にて初期消火を行う」ことを規定類に定めることとしているため、中央制御室の機能は維持される。 (詳細については、設置許可基準規則第8条「火災による損傷の防止」に関する適合状況説明資料を参照)
内部溢水 (地震起因含む)	溢水による中央制御室内設備の機能喪失	中央制御室には溢水源がないことを確認している。火災が発生したとしても、「運転員が火災状況を確認し、二酸化炭素消火器にて初期消火を行う」ことを規定類に定めることとしているため、内部溢水による影響がないことを確認している。蒸気配管破断が発生した場合も、漏えいした蒸気の影響がないことを確認している。 (詳細については、設置許可基準規則第9条「溢水による損傷の防止等」に関する適合状況説明資料を参照)
地震	地震時の誤接触等による誤操作	地震発生時の対応として「運転員は地震が発生した場合、制御盤から離れて誤接触を防止するとともに、制御盤の手摺にて身体の安全確保に努める」ことを規定類に定めることとしている。
風 (台風) 竜巻	外部電源喪失による照明等の所内電源の喪失	外部電源喪失においても、中央制御室の照明は、ディーゼル発電機から給電され ^{※1} 、蓄電池からの給電により点灯する直流非常灯も備えており、機能が喪失することはない。また、蓄電池を内蔵した可搬型照明を備えており、機能が喪失することはない。 (詳細については、設置許可基準規則第11条「安全避難通路等」に関する適合状況説明資料を参照)
低温 (凍結)		※非常用ディーゼル発電機は各自然現象に対して、外部電源喪失の有無によらず健全性が確保されることを確認している。地震：設計基準地震動に対して、耐震Sクラス設計であるため、健全性が確保される。 風 (台風)：設計基準の風速による風圧に対して、外殻その他による防護で健全性が確保されることを確認。 竜巻：設計基準の竜巻風速による複合荷重 (風圧、気圧差、飛来物衝撃力) に対して、外殻その他による防護で健全性が確保されることを確認。 低温 (凍結)：原子炉建屋換気空調設備により温度制御されているため、本体設備への影響はない。屋外タンクに貯蔵されている軽油については、凍結等が発生しないことを確認。 降水：設計基準の降水に対して、外殻その他による防護で健全性が確保されることを確認。 積雪：設計基準の積雪による堆積荷重に対して、外殻その他による防護で健全性が確保されることを確認。 落雷：設計基準の雷撃電流値に対して、避雷針や保安器等による防護で健全性が確保されることを確認。 地滑り：地滑りに対して、近傍の斜面から離隔距離を確保することにより健全性が確保されることを確認。 (次頁に続く)
降水		
積雪		
落雷		
地滑り		

□ : DB 範囲

第 3.4-1 表 中央制御室に同時にもたらされる環境条件への対応 (1/3)

起回事象	同時にもたらされる中央制御室の環境条件	中央制御室での運転操作に与える影響
内部火災 (地震起因含む)	火災による中央制御室内設備の機能喪失	中央制御室にて火災が発生しても速やかに消火できるように、「運転員が火災状況を確認し、粉末消火器又は二酸化炭素消火器にて初期消火を行う」ことを社内規定類に定めることとし、中央制御室の機能を維持する。(詳細については、「設置許可基準規則」第8条「火災による損傷の防止」に関する審査資料を参照)
内部溢水 (地震起因含む)	溢水による中央制御室内設備の機能喪失	中央制御室内には溢水源がない設計とする。火災が発生したとしても、「運転員が火災状況を確認し、粉末消火器又は二酸化炭素消火器にて初期消火を行う」ことを社内規定類に定めることとし、消火水による溢水の影響がない設計とする。蒸気配管破断が発生した場合も、漏えいした蒸気の影響がない設計とする。(詳細については、「設置許可基準規則」第9条「溢水による損傷の防止等」に関する審査資料を参照)
地震	余震	中央制御室は、原子炉建屋付属棟 (耐震Sクラス) に設置し、基準地震動による地震力に対して機能を喪失しない設計とする。 中央制御室の照明ルーバーに対して、落下防止措置を講じている。 余震時には、運転員は運転員机又は制御盤のデスク部下端に掴まることで体勢を維持し、指示計、記録計等による原子炉施設の監視を行うことができる。今後、余震時における運転員の更なる安全確保を考慮し、制御盤に手すりを設置する。

第 3.4-1 表 中央制御室に同時にもたらされる環境条件への対応 (2/3)

起回事象	同時にもたらされる中央制御室の環境条件	中央制御室での運転操作に与える影響
地震	外部電源喪失による照明等の所内電源の喪失	外部電源喪失においても、中央制御室の照明は、非常用ディーゼル発電機から給電され ^{※1} 、蓄電池からの給電により点灯する直流非常灯も備え、機能が喪失することはない。また、蓄電池内蔵型照明を備え、機能が喪失しない設計とする。(詳細については、「設置許可基準規則」第11条「安全避難通路等」に関する審査資料を参照) ※1 非常用ディーゼル発電機は、各自然現象に対して健全性を確保する設計とする。
竜巻・風 (台風)		地震：基準地震動に対して耐震Sクラス設計であるため、健全性を確保する。 竜巻：設計基準の竜巻による複合荷重 (風圧、気圧差、飛来物衝撃力) に対して外殻その他による防護で健全性を確保する。 風：設計基準の風 (台風) による風圧に対して外殻その他による防護で健全性を確保する。
積雪		積雪：設計基準の積雪による堆積荷重に対して外殻その他による防護で健全性を確保する。
落雷		落雷：設計基準の雷撃電流値に対して外殻その他による防護で健全性を確保する。
外部火災 (森林火災)		外部火災：防火帯の内側に設置することにより延焼を防止し、熱影響に対しては隔離距離の確保により健全性を確保する。また、ばい煙の侵入に対してフィルタによる防護で健全性を確保する。
火山		火山：想定する降下火砕物の堆積荷重に対して外殻その他による防護で健全性を確保する。また、下火砕物の侵入に対してフィルタによる防護で健全性を確保する。
外部火災 (森林火災)		ばい煙や有毒ガスの発生による中央制御室内環境への影響
火山		降下火砕物による中央制御室内環境への影響

□ : DB 範囲

表 3.4-1 中央制御室に同時にもたらされる環境条件への対応 (1/2)

起回事象	同時にもたらされる中央制御室の環境条件	中央制御室での操作性 (操作の容易性) を確保するための設計方針
内部火災 (地震起因含む)	火災による中央制御室内設備の機能喪失	中央制御室にて火災が発生しても速やかに消火できるよう、「運転員が火災状況を確認し、ハロン消火器又は二酸化炭素消火器にて初期消火を行う」ことを社内規定類に定めることとし、中央制御室の機能を維持する。(詳細については、設置許可基準規則第8条「火災による損傷の防止」に関する適合状況説明資料を参照)
内部溢水 (地震起因含む)	溢水による中央制御室内設備の機能喪失	中央制御室には溢水源がない設計とする。火災が発生したとしても、「運転員が火災状況を確認し、ハロン消火器又は二酸化炭素消火器にて初期消火を行う」ことを社内規定類に定めることとし、消火水による溢水の影響がない設計とする。蒸気配管破断が発生した場合も、漏えいした蒸気の影響がない設計とする。(詳細については、設置許可基準規則第9条「溢水による損傷の防止等」に関する適合状況説明資料を参照)
地震	余震	地震発生時の対応として「運転員は地震が発生した場合、制御盤から離れて操作器への誤接触を防止するとともに、制御盤の手摺にて身体の安全確保に努める」ことを社内規定類に定める。 外部電源喪失においても、中央制御室の照明は、ディーゼル発電機から給電され ^{※1} 、蓄電池からの給電により点灯する非常用直流照明も備え、機能が喪失しない設計とする。(詳細については、設置許可基準規則第11条「安全避難通路等」に関する適合状況説明資料を参照) ※1 ディーゼル発電機は各自然現象に対して健全性が確保される設計とする。
竜巻・風 (台風)	外部電源喪失 (全交流動力電源喪失含む)	地震：設計基準地震動に対して、耐震Sクラス設計とする。 竜巻：設計基準の竜巻風速による複合荷重 (風圧力による荷重、気圧差による荷重、飛来物による衝撃荷重) に対して、外殻その他による防護で健全性を確保する。 風 (台風)：設計基準の風速による風圧に対して、外殻その他による防護で健全性を確保する。 積雪：設計基準の積雪による堆積荷重に対して、外殻その他による防護で健全性を確保する。 落雷：設計基準の雷撃電流値に対して、避雷針や保安器等による防護で健全性を確保する。 森林火災：防火帯の内側に設置することにより延焼を防止し、熱影響に対して健全性を確保する。また、ばい煙に対してもフィルタにより健全性を確保する。図3.4-1に運転モード毎の中央制御室換気系の系統概要図を示す。 火山：設計基準の火山灰の堆積荷重に対して、外殻その他による防護で健全性を確保する。また、給気系はフィルタ交換等により閉塞せず健全性を確保する。
積雪		
落雷		
外部火災 (森林火災)	外部火災 (森林火災)	中央制御室の空調換気設備について、中央制御室給排気隔離弁を閉止し、系統隔離運転を行うことで外気を遮断することから、中央制御室内環境への影響はない。 (詳細については、設置許可基準規則第6条「外部からの衝撃による損傷の防止 (外部火災)」、設置許可基準規則第6条「外部からの衝撃による損傷の防止 (火山)」に関する適合状況説明資料を参照)
火山	火山	降下火砕物による中央制御室内環境への影響

□ : DB 範囲

・設備の相違
【柏崎 6/7, 東海第二】

表 3.4-1 中央制御室に同時にもたらされる環境条件への対応 (2/2)

起回事象	同時にもたらされる中央制御室の環境条件	中央制御室での運転操作に与える影響
火山	外部電源喪失による照明等の所内電源の喪失	(前頁の続き) 火山：設計基準の降下火砕物の堆積荷重に対して、外部その他による防護で健全性が確保されることを確認。また、給気系はフィルタ交換等により閉塞せず健全性が確保されることを確認。 生物学的事象：海生物に対して、除塵装置その他による防護で健全性が確保されることを確認。また、小動物の侵入に対して、外部となる建屋貫通部への止水処置等による防護で健全性が確保されることを確認。 森林火災：防火帯の内側にあるため延焼せず、熱影響を評価して健全性が確保されることを確認。また、ばい煙に対してはフィルタにより健全性が確保されることを確認。 有毒ガス：設備へ影響を与える事象ではないため、健全性が確保されることを確認。 船舶の衝突：船舶の侵入に対して、カーテンウォールその他による防護で健全性が確保されることを確認。 電磁的障害：電磁的障害による擾乱に対して、健全性が確保されることを確認。
生物学的事象		
外部火災 (森林火災)		
低温 (凍結)	低温による中央制御室内設備が凍結することによる機能喪失	中央制御室の換気空調設備により温度制御されているため、中央制御室への影響はない。 (詳細については、設置許可基準規則第6条「外部からの衝撃による損傷の防止 (低温)」に関する適合状況説明資料を参照)
火山	降下火砕物による中央制御室内換気設備への影響	外部の状況を監視カメラ等で確認し、中央制御室内に有毒ガス・降下火砕物等が流入する可能性がある場合、及び中央制御室内において有毒ガスが流入したことを煙や臭いで確認した場合等は、中央制御室の空調系を手動で再循環運転へ切り替えることで外気を遮断することから、中央制御室への影響はない。この場合の酸素濃度・二酸化炭素濃度への影響を【補足1】、【補足2】に示す。ただし、影響が長期化する場合は、必要に応じて一時的に外気を取り入れて換気する。 図3.4-1に運転モード毎の中央制御室換気空調系の系統概略図を示す。
外部火災 (森林火災) 有毒ガス	ばい煙や有毒ガスの発生による中央制御室内換気設備への影響	なお、外部火災時の有毒ガスについては、6/7号炉中央制御室外気取入口における濃度がIDLH (急性の毒性限界濃度 (30分曝露によって生命及び健康に対する即時の危険な影響を与える曝露レベルの濃度限度値)) 以下となるため、外気遮断運転の有無によらず問題とはならない。 外部火災以外の有毒ガスについても、敷地外有毒ガス及び敷地内屋内貯蔵有毒物質が影響を及ぼすことなく、敷地内屋外設備からの有毒ガス、窒素ガスの濃度は外気取入口において判定基準以下となるため、同様に外気遮断運転の有無によらず問題とはならない。 (詳細については、設置許可基準規則第6条「外部からの衝撃による損傷の防止 (外部火災)」、設置許可基準規則第6条「外部からの衝撃による損傷の防止 (有毒ガス)」、設置許可基準規則第6条「外部からの衝撃による損傷の防止 (火山)」に関する適合状況説明資料を参照)

□ : DB 範囲

第 3.4-1 表 中央制御室に同時にもたらされる環境条件への対応 (3/3)

起回事象	同時にもたらされる中央制御室の環境条件	中央制御室での運転操作に与える影響
外部火災 (森林火災)	ばい煙や有毒ガス発生による中央制御室内環境への影響	中央制御室換気系について、中央制御室換気系給気隔離弁及び中央制御室換気系排気隔離弁を閉止し、閉回路循環方式とすることにより外気を遮断することから、中央制御室内環境への影響はない。この場合の酸素濃度及び二酸化炭素濃度への影響を【補足1】及び【補足2】に示す。ただし、影響が長期化する場合は、必要に応じて一次的に外気を取り入れて換気する。第2.4-2図に運転モードごとの中央制御室換気系の系統概略図を示す。 なお、外部火災時の有毒ガスについては、中央制御室外気取入口における濃度がIDLH (急性の毒性限界濃度 (30分曝露によって生命及び健康に対する即時の危険な影響を与える曝露レベルの濃度限度値)) 以下となるため、外気遮断運転の有無によらず問題とはならない。 外部火災以外の有毒ガスについても、敷地外有毒ガス及び敷地内屋内貯蔵有毒物質が影響を及ぼすことなく、敷地内屋外設備からの有毒ガス及び窒素ガスの濃度は、外気取入口において判定基準以下となるため、同様に外気遮断運転の有無によらず問題とはならない。(詳細については、「設置許可基準規則」第6条 (外部からの衝撃による損傷の防止 (外部火災))、外部からの衝撃による損傷の防止 (有毒ガス) 及び外部からの衝撃による損傷の防止 (火山)) に関する審査資料を参照)
火山	降下火砕物による中央制御室内環境への影響	
凍結	低温による中央制御室内環境への影響	中央制御室換気系により環境温度が維持される環境温度が維持されるため、中央制御室内環境への影響はない。(詳細については、「設置許可基準規則」第6条 (外部からの衝撃による損傷の防止 (凍結)) に関する審査資料を参照)

□ : DB 範囲

表 3.4-1 中央制御室に同時にもたらされる環境条件への対応 (2/2)

起回事象	同時にもたらされる中央制御室の環境条件	中央制御室での操作性 (操作の容易性) を確保するための設計方針
火山	降下火砕物による中央制御室内環境への影響	
低温	低温による中央制御室内への影響	中央制御室の空調換気設備により環境温度が維持されるため、中央制御室内環境への影響はない。 (詳細については、設置許可基準規則第6条「外部からの衝撃による損傷の防止 (低温)」に関する適合状況説明資料を参照)

□ : DB 範囲

・設備の相違
【柏崎 6/7, 東海第二】



図 3.4-1 運転モード毎の中央制御室換気空調系 系統概略図

図 3.4-1 運転モード毎の中央制御室換気系 系統概要図

□ : DB 範囲

□ : DB 範囲

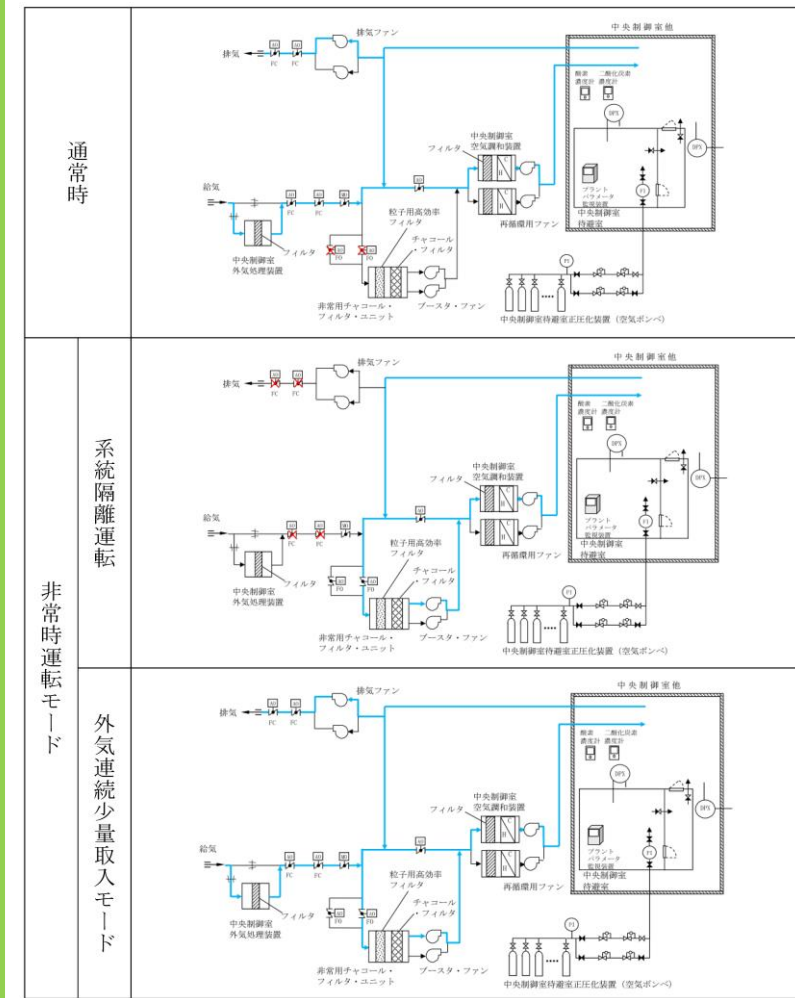
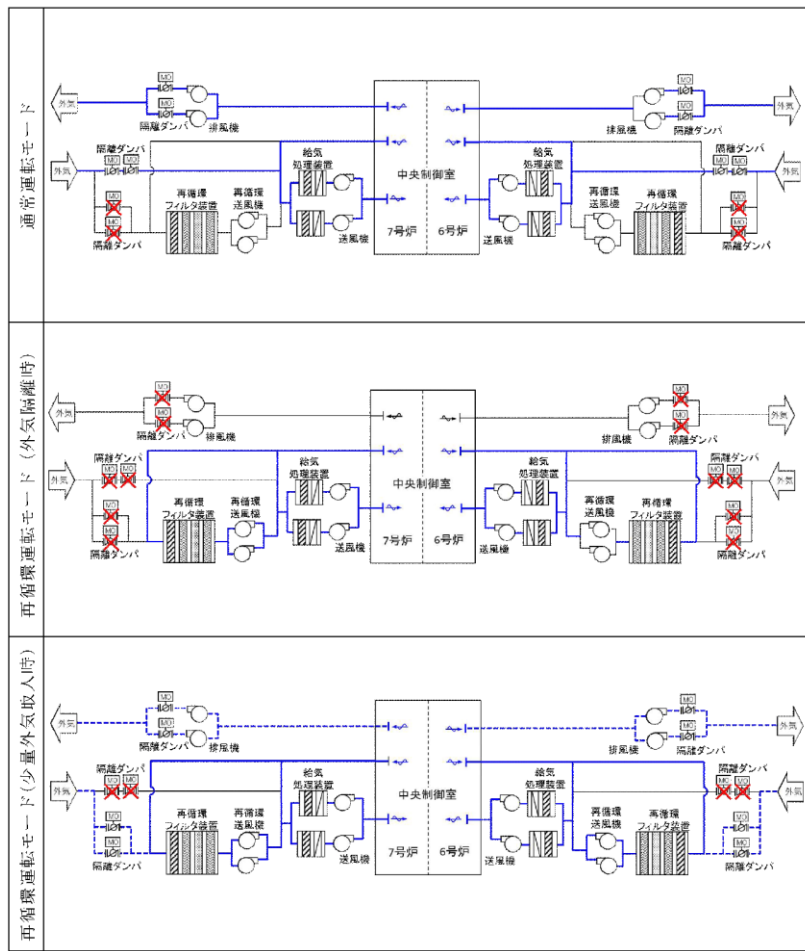
- ・設備の相違
【柏崎 6/7】
 - ・資料構成の相違
【東海第二】
- 東海第二は図 2.4-2 に同様の系統概要図を記載

柏崎刈羽原子力発電所 6/7号炉 (2017.12.20)	東海第二発電所 (2018.9.18版)	島根原子力発電所 2号炉	備考
<p>【補足 1】外気隔離時の中央制御室の酸素濃度及び二酸化炭素濃度の評価について (設計基準事故時)</p> <p>1. 概要 「実用発電用原子炉及びその附属施設の技術基準に関する規則の解釈」第38条、第13項に規定する「換気設備の隔離その他の適切な防護措置」として、中央制御室換気空調設備は、隔離ダンパを閉操作することにより外気から遮断し再循環運転とすることができる。 設計基準事故が発生時において、隔離ダンパを閉操作し、外気から隔離した場合の中央制御室の居住性について、以下の通り評価した。</p> <p>2. 評価 外気隔離時の中央制御室内に滞在する運転員の操作環境の悪化防止のため、酸素濃度及び二酸化炭素濃度について評価を行った。</p> <p>(1) 酸素濃度 「空気調和・衛生工学便覧 空気設備篇」に基づき、酸素濃度について評価した。</p> <p>a. 評価条件</p> <ul style="list-style-type: none"> ・滞在人員 18名 ・中央制御室バウンダリ容積 20,800m³ ・空気流入率：0.1回/h (2010年3月16日～17日に実施した中央制御室空気流入率測定試験結果 A系：0.30±0.006回/h, B系：0.25±0.006回/hも基に保守的に設定) ・初期酸素濃度：20.95% ・1人当たりの呼吸量は、事故時の運転操作を想定し、歩行時の呼吸量を適用し、24l/minとする。 ・一人当たりの酸素消費量は呼気の酸素濃度を16.4%として、65.52L/hとする。 	<p>【補足 1】外気隔離時の中央制御室の酸素及び二酸化炭素濃度の評価について (設計基準事故時)</p> <p>1. 概要 「実用発電用原子炉及びその附属施設の技術基準に関する規則の解釈」第38条第13項に規定する「換気設備の隔離その他の適切な防護措置」として、中央制御室換気系は、隔離弁を閉操作することにより外気から遮断し閉回路循環方式とすることができる。 設計基準事故時において、隔離弁を閉操作し、外気から隔離した場合の中央制御室の居住性について、以下のとおり評価した。</p> <p>2. 評価 外気隔離時の中央制御室内に滞在する運転員の操作環境の悪化防止のため、酸素濃度及び二酸化炭素濃度について評価を行った。</p> <p>(1) 酸素濃度</p> <p>a. 評価条件 「空気調和・衛生工学便覧 第14版 3空気調和設備編」及び「原子力発電所中央制御室運転員の事故時被ばくに関する規程 (J E A C 4622-2009)」に基づき評価した。</p> <ul style="list-style-type: none"> ・滞在人員：7名 ・中央制御室バウンダリ容積：2,700m³ ・初期酸素濃度：20.95% ・空気流入率：0.4回/h (平成27年2月25日～26日に実施した中央制御室空気流入率測定試験結果 A系：0.468回/h (±0.015), B系：0.435回/h (±0.015)を基に設定) ・1人当たりの呼吸量は、事故時の運転操作を想定し、歩行時の呼吸量を適用して、24L/min/人とする。 ・1人当たりの酸素消費量は、呼気酸素濃度を16.40%として、1.092L/min/人 (=0.06552m³/h/人) 	<p>【補足 1】系統隔離運転時の中央制御室の酸素濃度及び二酸化炭素濃度の評価について (設計基準事故時)</p> <p>1. 概要 「実用発電用原子炉及びその附属施設の技術基準に関する規則」第38条第5項二に規定する「換気設備の隔離その他の適切な防護措置」として、中央制御室換気系は、中央制御室給排気隔離弁を閉操作することにより外気から遮断し、系統隔離運転とすることができる。 設計基準事故の発生時において、中央制御室給排気隔離弁を閉操作し、外気から隔離した場合の中央制御室の居住性について、以下のとおり評価した。</p> <p>2. 評価 外気隔離時の中央制御室内に滞在する運転員の操作環境の悪化防止のため、酸素濃度及び二酸化炭素濃度について評価を行った。</p> <p>(1) 酸素濃度 「空気調和・衛生工学便覧 空気調和設備編」に基づき、酸素濃度について評価した。</p> <p>a. 評価条件</p> <ul style="list-style-type: none"> ・滞在人員 9名 ・中央制御室バウンダリ容積 17,150m³ ・空気流入率 0.01回/h (2017年8月2日に実施した中央制御室空気流入率測定試験結果 0.082+0.003回/hを基に保守的に設定) ・初期酸素濃度 20.95% (標準大気の酸素濃度) ・1人当たりの呼吸量は、事故時の運転操作を想定し、歩行時の呼吸量を適用し、24L/minとする。 ・1人当たりの酸素消費量は、呼気の酸素濃度を16.4%として65.52L/hとする。 	<p>備考</p> <p>・評価条件の相違 【柏崎6/7, 東海第二】 島根2号炉の中央制御室に滞在する人数を基に評価</p>
<p style="text-align: right;">□ : DB範囲</p>	<p style="text-align: right;">□ : DB範囲</p>	<p style="text-align: right;">□ : DB範囲</p>	

・許容酸素濃度は18%以上 (労働安全衛生法から)

b. 評価結果
 上記評価条件から求めた酸素濃度は表1のとおりであり、720時間外気隔離した場合においても、中央制御室内に滞在する運転員の操作環境に影響を与えない。

表1 外気隔離時の酸素濃度 (設計基準事故時)

時間	12時間	24時間	36時間	96時間	168時間	720時間
酸素濃度	20.91%	20.89%	20.89%	20.89%	20.89%	20.89%

: DB範囲

・1時間当たりの酸素消費量は、
 $0.45864 \text{ [m}^3/\text{h}] = 0.06552 \text{ [m}^3/\text{h}/\text{人}] \times 7 \text{ [名]}$

・許容酸素濃度：19%以上 (「鉱山保安法施行規則」より)

b. 酸素濃度の計算式
 中央制御室の平衡状態における酸素濃度の計算式を以下に示す。

$$C_{\infty} = C_0 - \{M / (N \cdot V)\}$$

M : 室内酸素消費量 [m³/h]
 V : 中央制御室バウンダリ体積 [m³]
 C_∞ : 平衡状態における室内の酸素濃度 [-]
 C₀ : 外気の酸素濃度 [-]
 N : 空気流入率 [回/h]

c. 酸素濃度評価結果

$$C_{\infty} = 0.2095 - \{0.45864 / (0.4 \times 2,700)\}$$

$$= 0.209075 \approx 20.90\%$$

以上のとおり、閉回路循環方式の中央制御室の酸素濃度は、19%以上を満足しているため、中央制御室での作業環境に影響を与えない。

: DB範囲

・許容酸素濃度は18%以上 (労働安全衛生法酸素欠乏症等防止規則から)

b. 評価結果
 上記評価条件から求めた酸素濃度は表1のとおりであり、720時間外気隔離した場合においても、中央制御室内に滞在する運転員の操作環境に影響を与えない。

表1 系統隔離時の酸素濃度 (設計基準事故時)

時間	12時間	24時間	36時間	96時間	168時間	720時間
酸素濃度	20.91%	20.87%	20.84%	20.73%	20.67%	20.60%

: DB範囲

・適用基準の相違
 【東海第二】
 島根2号炉は酸素欠乏症等防止規定から許容酸素濃度を規定している

・評価結果の相違
 【柏崎6/7, 東海第二】

柏崎刈羽原子力発電所 6/7号炉 (2017.12.20)	東海第二発電所 (2018.9.18版)	島根原子力発電所 2号炉	備考																												
<p>(2) 二酸化炭素濃度 「空気調和・衛生工学便覧 空気設備篇」に基づき、二酸化炭素濃度について評価した。</p> <p>a. 評価条件</p> <ul style="list-style-type: none"> ・滞在人員 <u>18名</u> ・中央制御室バウンダリ容積 <u>20,800m³</u> ・空気流入率：<u>0.1回/h</u> (2010年3月16日～17日に実施した中央制御室空気流入率測定試験結果 A系：<u>0.30±0.006回/h</u>, B系：<u>0.25±0.006回/h</u>も基に保守的に設定) ・初期二酸化炭素濃度：<u>0.039%</u> ・1人当りの二酸化炭素吐出量は、事故時の運転操作を想定し、中等作業時の吐出量を適用して0.046m³/hとする。 ・許容二酸化炭素濃度は0.5%以下(労働安全衛生法から) <p>b. 評価結果 上記評価条件から求めた二酸化炭素濃度は表2の通りであり、720時間外気隔離した場合においても、中央制御室内に滞在する運転員の操作環境に影響を与えない。</p> <p>表2 外気隔離時の二酸化炭素濃度(設計基準事故時)</p> <table border="1" data-bbox="184 1333 884 1453"> <thead> <tr> <th>時間</th> <th>12時間</th> <th>24時間</th> <th>36時間</th> <th>96時間</th> <th>168時間</th> <th>720時間</th> </tr> </thead> <tbody> <tr> <td>二酸化炭素濃度</td> <td>0.06%</td> <td>0.076%</td> <td>0.078%</td> <td>0.079%</td> <td>0.079%</td> <td>0.079%</td> </tr> </tbody> </table>	時間	12時間	24時間	36時間	96時間	168時間	720時間	二酸化炭素濃度	0.06%	0.076%	0.078%	0.079%	0.079%	0.079%	<p>(2) 二酸化炭素濃度</p> <p>a. 評価条件</p> <p>「空気調和・衛生工学便覧 第14版 3空気調和設備編」及び「原子力発電所中央制御室運転員の事故時被ばくに関する規程(JEAC4622-2009)」に基づき評価した。</p> <ul style="list-style-type: none"> ・滞在人員：<u>7名</u> ・中央制御室バウンダリ容積：<u>2,700m³</u> ・初期二酸化炭素濃度：<u>0.03%</u> ・空気流入率：<u>0.4回/h</u>(平成27年2月25日～26日に実施した中央制御室空気流入率測定試験結果 A系：<u>0.468回/h(±0.015)</u>, B系：<u>0.435回/h(±0.015)</u>を基に設定) ・1人当たりの二酸化炭素吐出量は、事故時の運転操作を想定し、中等作業での吐出量を適用して、0.046[m³/h/人]とする。 ・1時間当たりの二酸化炭素吐出量は、0.322[m³/h]=0.046[m³/h/人]×7[名] ・許容二酸化炭素濃度は、0.5%以下 <p>b. 二酸化炭素の計算式 中央制御室の平衡状態における二酸化炭素の計算式を以下に示す。</p> $C_{\infty} = C_0 + \{M / (N \cdot V)\}$ <p>M : 室内二酸化炭素発生量 [m³/h] V : 中央制御室バウンダリ体積 [m³] C_∞ : 平衡状態における室内の二酸化炭素濃度 [-] C₀ : 外気の二酸化炭素濃度 [-] N : 空気流入率 [回/h]</p> <p>c. 評価結果</p> $C_{\infty} = 0.0003 + \{0.322 / (0.4 \times 2,700)\}$ $= 0.000599 \approx 0.06\%$ <p>以上のとおり、閉回路循環方式の中央制御室の二酸化炭素濃度は、0.5%以下を満足しているため、中央制御室での作業環境に影響を与えない。</p>	<p>(2) 二酸化炭素濃度 「空気調和・衛生工学便覧 空気調和設備編」に基づき、二酸化炭素濃度について評価した。</p> <p>a. 評価条件</p> <ul style="list-style-type: none"> ・滞在人員 <u>9名</u> ・中央制御室バウンダリ容積 <u>17,150m³</u> ・空気流入率 <u>0.01回/h</u> (2017年8月2日に実施した中央制御室空気流入率測定試験結果 <u>0.082+0.003回/h</u>を基に保守的に設定) ・初期二酸化炭素濃度 <u>0.03%</u>(標準大気中の二酸化炭素濃度) ・1人当たりの二酸化炭素吐出量は、事故時の運転操作を想定し、中等作業時の吐出量を適用して0.046m³/hとする。 ・許容二酸化炭素濃度は0.5%以下(JEAC4622-2009から) <p>b. 評価結果 上記評価条件から求めた二酸化炭素濃度は表2のとおりであり、720時間系統隔離した場合においても、中央制御室内に滞在する運転員の操作環境に影響を与えない。</p> <p>表2 系統隔離時の二酸化炭素濃度(設計基準事故時)</p> <table border="1" data-bbox="1727 1270 2493 1453"> <thead> <tr> <th>時間</th> <th>12時間</th> <th>24時間</th> <th>36時間</th> <th>96時間</th> <th>168時間</th> <th>720時間</th> </tr> </thead> <tbody> <tr> <td>二酸化炭素濃度</td> <td>0.06%</td> <td>0.09%</td> <td>0.11%</td> <td>0.18%</td> <td>0.23%</td> <td>0.28%</td> </tr> </tbody> </table>	時間	12時間	24時間	36時間	96時間	168時間	720時間	二酸化炭素濃度	0.06%	0.09%	0.11%	0.18%	0.23%	0.28%	<p>備考</p> <ul style="list-style-type: none"> ・評価条件の相違 【柏崎6/7, 東海第二】 島根2号炉の中央制御室に滞在する人数を基に評価 ・評価結果の相違 【柏崎6/7, 東海第二】
時間	12時間	24時間	36時間	96時間	168時間	720時間																									
二酸化炭素濃度	0.06%	0.076%	0.078%	0.079%	0.079%	0.079%																									
時間	12時間	24時間	36時間	96時間	168時間	720時間																									
二酸化炭素濃度	0.06%	0.09%	0.11%	0.18%	0.23%	0.28%																									
<p style="text-align: right;">□ : DB範囲</p>	<p style="text-align: right;">□ : DB範囲</p>	<p style="text-align: right;">□ : DB範囲</p>																													

柏崎刈羽原子力発電所 6/7号炉 (2017.12.20)	東海第二発電所 (2018.9.18版)	島根原子力発電所 2号炉	備考
<p>【補足2】外気隔離時の中央制御室の酸素濃度及び二酸化炭素濃度の評価について</p> <p>(重大事故時)</p> <p>1. 概要</p> <p>「実用発電用原子炉及びその附属施設の技術基準に関する規則の解釈」第38条、第13項に規定する「換気設備の隔離その他の適切な防護措置」として、重大事故発生時において中央制御室換気空調設備は全停止及び隔離ダンパを閉操作し、中央制御室陽圧化空調機により外気を浄化した空気により中央制御室バウンダリを陽圧化する設計としている。</p> <p>重大事故が発生時において、空調全停止中央制御室バウンダリを陽圧化した場合の中央制御室の居住性について、以下のとおり評価した。</p> <p>2. 評価</p> <p>外気隔離時の中央制御室内に滞在する運転員の操作環境の悪化防止のため、酸素濃度及び二酸化炭素濃度について評価を行った。</p> <p>(1) 酸素濃度</p> <p>「空気調和・衛生工学便覧 空気設備篇」に基づき、酸素濃度について評価した。</p> <p>a. 評価条件</p> <ul style="list-style-type: none"> ・滞在人員 20名 ・中央制御室バウンダリ容積 20,800m³ ・換気量：4,500m³/h (中央制御室可搬型陽圧化空調機の設計風量4,500～6,000m³/hより保守的に4,500m³/hと設定) ・初期酸素濃度：20.95% ・1人当たりの呼吸量は、事故時の運転操作を想定し、歩行時の呼吸量を適用し、24l/minとする。 	<p>【補足2】外気隔離時の中央制御室の酸素及び二酸化炭素濃度の評価について</p> <p>(重大事故時)</p> <p>1. 概要</p> <p>「実用発電用原子炉及びその附属施設の技術基準に関する規則の解釈」第38条第13項に規定する「換気設備の隔離その他の適切な防護措置」として、中央制御室換気系は、隔離弁を閉操作することにより外気から遮断し、閉回路循環方式とすることができる。</p> <p>重大事故時において、隔離弁を閉操作し、外気から隔離した場合の中央制御室の居住性について、以下のとおり評価した。</p> <p>2. 評価</p> <p>外気隔離時の中央制御室内に滞在する運転員の操作環境の悪化防止のため、酸素濃度及び二酸化炭素濃度について評価を行った。</p> <p>(1) 酸素濃度</p> <p>a. 評価条件</p> <p>「空気調和・衛生工学便覧 第14版 3空気調和設備編」及び「原子力発電所中央制御室運転員の事故時被ばくに関する規程（J E A C 4622-2009）」に基づき評価した。</p> <ul style="list-style-type: none"> ・滞在人員：11名 ・中央制御室バウンダリ容積：2,700m³ ・初期酸素濃度：20.95% ・空気流入率：0.4回/h（平成27年2月25日～26日に実施した中央制御室空気流入率測定試験結果 A系：0.468回/h（±0.015）、B系：0.435回/h（±0.015）を基に設定） ・1人当たりの呼吸量は、事故時の運転操作を想定し、歩行時の呼吸量を適用して、24L/min/人とする。 	<p>【補足2】加圧運転時の中央制御室の酸素濃度及び二酸化炭素濃度の評価について</p> <p>(重大事故時)</p> <p>1. 概要</p> <p>「実用発電用原子炉及びその附属施設の技術基準に関する規則」第38条第5項に規定する「換気設備の隔離その他の適切な防護措置」として、重大事故発生時において、中央制御室換気系の中央制御室排気隔離弁を閉操作及び中央制御室給気隔離弁を開操作し、チャコール・フィルタ・ブースタ・ファン及び再循環用ファンにより外気を浄化した空気によって中央制御室バウンダリを正圧化する設計としている。</p> <p>重大事故が発生時において、加圧運転を実施し中央制御室バウンダリを正圧化した場合の中央制御室の居住性について、以下のとおり評価した。</p> <p>2. 評価</p> <p>加圧運転時の中央制御室内に滞在する運転員の操作環境の悪化防止のため、酸素濃度及び二酸化炭素濃度について評価を行った。</p> <p>(1) 酸素濃度</p> <p>「空気調和・衛生工学便覧 空気調和設備編」に基づき、酸素濃度について評価した。</p> <p>a. 評価条件</p> <ul style="list-style-type: none"> ・滞在人員 9名 ・中央制御室バウンダリ容積：17,150m³ ・換気量：[]m³/h (中央制御室換気系の設計風量17,500m³より保守的に、中央制御室内を外気より+20Pa以上で正圧化する必要風量 []m³/hと設定) ・初期酸素濃度：20.95%（空気調和・衛生工学便覧から） ・1人当たりの呼吸量は、事故時の運転操作を想定し、歩行時の呼吸量を適用し、24L/minとする。 	<p>備考</p> <ul style="list-style-type: none"> ・手順の相違 【柏崎6/7】 ②の相違 ・運用の相違 【東海第二】 島根2号炉は外気を給気して正圧化を実施するため、閉回路循環方式とは異なる ・評価条件の相違 【柏崎6/7, 東海第二】 ②の相違 ・評価条件の相違 【柏崎6/7, 東海第二】 島根2号炉の中央制御室に滞在する人数・バウンダリ容積、換気量を基に評価。東海第二は循環運転のためインリークによる空気流入を仮定。
<p style="text-align: right;">[] : SA範囲</p>	<p style="text-align: right;">[] : SA範囲</p>	<p style="text-align: right;">[] : SA範囲</p>	

柏崎刈羽原子力発電所 6/7号炉 (2017.12.20)	東海第二発電所 (2018.9.18版)	島根原子力発電所 2号炉	備考																								
<p>・一人当たりの酸素消費量は呼気の酸素濃度を16.4%として、65.52L/hとする。</p> <p>・許容酸素濃度は18%以上（労働安全衛生法から）</p> <p>b. 評価結果 上記評価条件から求めた酸素濃度は表1の通りであり、168時間外気隔離した場合においても、中央制御室内に滞在する運転員の操作環境に影響を与えない。</p> <p>表1 外気隔離時の酸素濃度（重大事故時）</p> <table border="1" data-bbox="142 705 896 802"> <thead> <tr> <th>時間</th> <th>12時間</th> <th>24時間</th> <th>36時間</th> <th>96時間</th> <th>168時間</th> </tr> </thead> <tbody> <tr> <td>酸素濃度</td> <td>20.92%</td> <td>20.92%</td> <td>20.92%</td> <td>20.92%</td> <td>20.92%</td> </tr> </tbody> </table>	時間	12時間	24時間	36時間	96時間	168時間	酸素濃度	20.92%	20.92%	20.92%	20.92%	20.92%	<p>・1人当たりの酸素消費量は、呼気酸素濃度を16.40%として、1.092L/min/人 (=0.06552m³/h/人)</p> <p>・1時間当たりの酸素消費量は、0.72072 [m³/h] =0.06552 [m³/h/人] ×11 [名]</p> <p>・許容酸素濃度：19%以上（「鉱山保安法施行規則」より）</p> <p>b. 酸素濃度の計算式 中央制御室の平衡状態における酸素濃度の計算式を以下に示す。</p> $C_{\infty} = C_0 - \{M / (N \cdot V)\}$ <p>M : 室内酸素消費量 [m³/h] V : 中央制御室バウンダリ体積 [m³] C_∞ : 平衡状態における室内の酸素濃度 [-] C₀ : 外気の酸素濃度 [-] N : 空気流入率 [回/h]</p> <p>c. 酸素濃度評価結果</p> $C_{\infty} = 0.2095 - \{0.72072 / (0.4 \times 2,700)\}$ $= 0.208166 \approx 20.81\%$ <p>以上のとおり、閉回路循環方式の中央制御室の酸素濃度は、19%以上を満足しているため、中央制御室での作業環境に影響を与えない。</p>	<p>・1人当たりの酸素消費量は呼気の酸素濃度を16.4%として、65.52L/hとする。</p> <p>・許容酸素濃度は18%（労働安全衛生法酸素欠乏症等防止規則から）</p> <p>b. 評価結果 上記評価条件から求めた酸素濃度は表1の通りであり、168時間加圧運転した場合においても、中央制御室内に滞在する運転員の操作環境に影響を与えない。</p> <p>表1 隔離運転時の酸素（加圧運転時）</p> <table border="1" data-bbox="1730 684 2484 823"> <thead> <tr> <th>時間</th> <th>12時間</th> <th>24時間</th> <th>36時間</th> <th>96時間</th> <th>168時間</th> </tr> </thead> <tbody> <tr> <td>酸素濃度</td> <td>20.94%</td> <td>20.94%</td> <td>20.94%</td> <td>20.94%</td> <td>20.94%</td> </tr> </tbody> </table>	時間	12時間	24時間	36時間	96時間	168時間	酸素濃度	20.94%	20.94%	20.94%	20.94%	20.94%	<p>備考</p> <p>・評価結果の相違 【柏崎6/7, 東海第二】</p>
時間	12時間	24時間	36時間	96時間	168時間																						
酸素濃度	20.92%	20.92%	20.92%	20.92%	20.92%																						
時間	12時間	24時間	36時間	96時間	168時間																						
酸素濃度	20.94%	20.94%	20.94%	20.94%	20.94%																						
<p style="text-align: right;">: SA範囲</p>	<p style="text-align: right;">: SA範囲</p>	<p style="text-align: right;">: SA範囲</p>																									

柏崎刈羽原子力発電所 6/7号炉 (2017.12.20)	東海第二発電所 (2018.9.18版)	島根原子力発電所 2号炉	備考																								
<p>(2) 二酸化炭素濃度</p> <p>「空気調和・衛生工学便覧 空気設備篇」に基づき、二酸化炭素濃度について評価した。</p> <p>a. 評価条件</p> <ul style="list-style-type: none"> ・滞在人員 <u>20</u>名 ・中央制御室バウンダリ容積 <u>20,800m³</u> ・換気量：<u>4,500m³/h</u> (中央制御室可搬型陽圧化空調機の設計風量4,500～6,000m³/hより保守的に4,500m³/hと設定) ・初期二酸化炭素濃度：0.039% ・1人当りの二酸化炭素吐出量は、事故時の運転操作を想定し、中等作業時の吐出量を適用して0.046m³/hとする。 ・許容二酸化炭素濃度は0.5%以下(労働安全衛生法から) <p>b. 評価結果</p> <p>上記評価条件から求めた二酸化炭素濃度は表2の通りであり、168時間外気隔離した場合においても、中央制御室内に滞在する運転員の操作環境に影響を与えない。</p> <p>表2 外気隔離時の二酸化炭素濃度(重大事故時)</p> <table border="1" data-bbox="142 1388 887 1520"> <thead> <tr> <th>時間</th> <th>12時間</th> <th>24時間</th> <th>36時間</th> <th>96時間</th> <th>168時間</th> </tr> </thead> <tbody> <tr> <td>二酸化炭素濃度</td> <td>0.058%</td> <td>0.060%</td> <td>0.060%</td> <td>0.060%</td> <td>0.060%</td> </tr> </tbody> </table> <p style="text-align: right;">: SA範囲</p>	時間	12時間	24時間	36時間	96時間	168時間	二酸化炭素濃度	0.058%	0.060%	0.060%	0.060%	0.060%	<p>(2) 二酸化炭素濃度</p> <p>a. 評価条件</p> <p>「空気調和・衛生工学便覧 第14版 3 空気調和設備編」及び「原子力発電所中央制御室運転員の事故時被ばくに関する規程(JEAC4622-2009)」に基づき評価した。</p> <ul style="list-style-type: none"> ・滞在人員：<u>11</u>名 ・中央制御室バウンダリ容積：<u>2,700m³</u> ・初期二酸化炭素濃度：0.03% ・空気流入率：0.4回/h(平成27年2月25日～26日に実施した中央制御室空気流入率測定試験結果 A系：0.468回/h(±0.015), B系：0.435回/h(±0.015)を基に設定) ・1人当りの二酸化炭素吐出量は、事故時の運転操作を想定し、中等作業での吐出量を適用して、0.046[m³/h/人]とする。 ・1時間当たりの二酸化炭素吐出量は、0.506[m³/h] = 0.046[m³/h/人] × 11[名] ・許容二酸化炭素濃度は、0.5%以下 <p>b. 二酸化炭素の計算式</p> <p>中央制御室の平衡状態における二酸化炭素の計算式を以下に示す。</p> $C_{\infty} = C_0 + \{M / (N \cdot V)\}$ <p>M : 室内二酸化炭素発生量 [m³/h] V : 中央制御室バウンダリ体積 [m³] C_∞ : 平衡状態における室内の二酸化炭素濃度 [-] C₀ : 外気の二酸化炭素濃度 [-] N : 空気流入率 [回/h]</p> <p>c. 評価結果</p> $C_{\infty} = 0.0003 + \{0.506 / (0.4 \times 2700)\}$ $= 0.000769 \approx 0.08\%$ <p>以上のとおり、閉回路循環方式の中央制御室の二酸化炭素濃度は、0.5%以下を満足しているため、中央制御室での作業環境に影響を与えない。</p> <p style="text-align: right;">: SA範囲</p>	<p>(2) 二酸化炭素濃度</p> <p>「空気調和・衛生工学便覧 空気調和設備編」に基づき、二酸化炭素濃度について評価した。</p> <p>a. 評価条件</p> <ul style="list-style-type: none"> ・滞在人員 <u>9</u>名 ・中央制御室バウンダリ容積：<u>17,150m³</u> ・換気量：<u> </u>m³/h (中央制御室換気系の設計風量17,500m³より保守的に、中央制御室内を外気より+20Pa以上で正圧化する必要風量<u> </u>m³/hと設定) ・初期二酸化炭素濃度：0.03% (空気調和・衛生工学便覧から) ・1人当りの二酸化炭素吐出量は、事故時の運転操作を想定し、中等作業時の吐出量を適用して0.046m³/hとする。 ・許容二酸化炭素濃度は0.5%以下(JEAC4622-2009から) <p>b. 評価結果</p> <p>上記評価条件から求めた二酸化炭素濃度は表2の通りであり、168時間加圧運転した場合においても、中央制御室内に滞在する運転員の操作環境に影響を与えない。</p> <p>表2 隔離運転時の二酸化炭素濃度(加圧運転時)</p> <table border="1" data-bbox="1739 1398 2493 1539"> <thead> <tr> <th>時間</th> <th>12時間</th> <th>24時間</th> <th>36時間</th> <th>96時間</th> <th>168時間</th> </tr> </thead> <tbody> <tr> <td>二酸化炭素濃度</td> <td>0.033%</td> <td>0.033%</td> <td>0.033%</td> <td>0.033%</td> <td>0.033%</td> </tr> </tbody> </table> <p style="text-align: right;">: SA範囲</p>	時間	12時間	24時間	36時間	96時間	168時間	二酸化炭素濃度	0.033%	0.033%	0.033%	0.033%	0.033%	<p>備考</p> <ul style="list-style-type: none"> ・評価条件の相違【柏崎6/7, 東海第二】 島根2号炉の中央制御室に滞在する人数・バウンダリ容積, 換気量を基に評価。東海第二は循環運転のためインリークによる空気流入を仮定。 ・評価結果の相違【柏崎6/7, 東海第二】
時間	12時間	24時間	36時間	96時間	168時間																						
二酸化炭素濃度	0.058%	0.060%	0.060%	0.060%	0.060%																						
時間	12時間	24時間	36時間	96時間	168時間																						
二酸化炭素濃度	0.033%	0.033%	0.033%	0.033%	0.033%																						

柏崎刈羽原子力発電所 6 / 7号炉 (2017.12.20)	東海第二発電所 (2018.9.18版)	島根原子力発電所 2号炉	備考
		<p>【補足3】系統隔離運転から加圧運転への切替え操作のうち、中央制御室給気隔離弁を現場にて全開操作する必要性について（重大事故時）</p> <p>1. 概要</p> <p>SA時の中央制御室換気系の運用にあたっては、給気隔離弁を全開状態に維持する必要があるが、換気系隔離信号の発生により給気隔離弁が自動で全閉し系統構成を阻害することがないよう、現場にて手動ハンドルにより中央制御室給気隔離弁を強制的に全開状態としたうえで、中央制御室外気取入調節弁を中央制御室から手動操作し、調整開にして加圧運転へ、また、全閉にして系統隔離運転へ切り替えることが可能な設計としている。</p> <p>2. 中央制御室給気隔離弁及び中央制御室外気取入調節弁の設計及び運用について</p> <p>(1) 中央制御室給気隔離弁（図1の①）</p> <p>中央制御室給気隔離弁は空気作動式で通常時全開（フェイルクローズ設計）としており、放射線異常高等の換気系隔離信号が発生した場合、自動で全閉し、通常運転（外気取入運転）から系統隔離運転に切り替わる設計としている。</p> <p>駆動源喪失が想定されるSA時は、フェイルクローズ設計のため給気隔離弁は全閉となっており、中央制御室からの開操作ができず、系統構成を系統隔離運転から加圧運転へ切り替えるためには、現場にて給気隔離弁を全開操作する必要がある。駆動部に設けている手動ハンドルによる給気隔離弁の強制開操作は、アクチュエータによる動作より優先されるため、確実に当該弁の全開状態を維持し、加圧運転を継続することが可能である。</p> <p>(2) 中央制御室外気取入調節弁（図1の②）</p> <p>中央制御室外気取入調節弁は、電気作動式で通常時全開としており、中央制御室からの手動操作により開閉可能な設計としている。</p> <p>中央制御室外気取入調節弁は、常設代替交流電源設備からの給電が可能な設計としているため、SA時に、中央制御室からの手動操作により、流量調整のため調整開にして加圧運転へ、又は、全閉にして系統隔離運転へ切り替えることが可能である。</p> <p style="text-align: right;">: SA範囲</p>	<p>・運用の相違 [柏崎6/7, 東海第二] 島根2号炉はSA時に現場にて弁操作を行う。</p>

3.5 中央制御室待避室のデータ表示装置(待避室)で確認できるパラメータ

表 3.5-1 データ表示装置(待避室)で確認できるパラメータ

目的	対象パラメータ
炉心反応度の状態確認	APRM平均値
	APRM(A)
	APRM(B)
	APRM(C)
	APRM(D)
	SRNM(A) 対数計数率出力
	SRNM(B) 対数計数率出力
	SRNM(C) 対数計数率出力
	SRNM(D) 対数計数率出力
	SRNM(E) 対数計数率出力
	SRNM(F) 対数計数率出力
	SRNM(G) 対数計数率出力
	SRNM(H) 対数計数率出力
	SRNM(J) 対数計数率出力
	SRNM(L) 対数計数率出力
	SRNM(A) 計数率高減
	SRNM(B) 計数率高減
	SRNM(C) 計数率高減
	SRNM(D) 計数率高減
	SRNM(E) 計数率高減
SRNM(F) 計数率高減	
SRNM(G) 計数率高減	
SRNM(H) 計数率高減	
SRNM(J) 計数率高減	
SRNM(L) 計数率高減	
炉心冷却の状態確認	原子炉圧力(広帯域)(BV)
	原子炉圧力(A)
	原子炉圧力(B)
	原子炉圧力(C)
	原子炉圧力(SA)
	原子炉水位(広帯域)PBV
	原子炉水位(広帯域)(A)
	原子炉水位(広帯域)(C)
	原子炉水位(広帯域)(F)
	原子炉水位(燃料域)PBV
	原子炉水位(燃料域)(A)
	原子炉水位(燃料域)(B)
	原子炉水位(SA)(ワイド)
	原子炉水位(SA)(ナロー)
	炉水温度 PBV
逃し安全弁 開	

： SA範囲

3.5 中央制御室待避室のデータ表示装置で確認できるパラメータ

第 3.5-1 表 データ表示装置(待避室)で確認できるパラメータ (1/6)

目的	対象パラメータ	SPDSパラメータ	ERSS伝送パラメータ(※1)	バックアップ対象パラメータ
炉心反応度の状態確認	平均出力領域計装 平均	○	○	-
	平均出力領域計装 A	○	○	○
	平均出力領域計装 B	○	○	○
	平均出力領域計装 C	○	○	-
	平均出力領域計装 D	○	○	-
	平均出力領域計装 E	○	○	-
	平均出力領域計装 F	○	○	-
	起動領域計装 A	○	○	○
	起動領域計装 B	○	○	○
	起動領域計装 C	○	○	○
	起動領域計装 D	○	○	○
	起動領域計装 E	○	○	○
	起動領域計装 F	○	○	○
	起動領域計装 G	○	○	○
	起動領域計装 H	○	○	○
	直流±24V 中性子モニタ用分電盤電圧	○	○	○
	ほう酸水注入ポンプ吐出圧力	○	○	○
	炉心冷却の状態確認	原子炉水位(狭帯域)	○	○
原子炉水位(広帯域)		○	○	○
原子炉水位(燃料域)		○	○	○
原子炉水位(SA広帯域)		○	○	○
原子炉水位(SA燃料域)		○	○	○
原子炉圧力		○	○	○
原子炉圧力(SA)		○	○	○
高圧炉心スプレイ系系統流量		○	○	○
低圧炉心スプレイ系系統流量		○	○	○
原子炉隔離時冷却系系統流量		○	○	○
残留熱除去系系統流量A		○	○	○
残留熱除去系系統流量B		○	○	○
残留熱除去系系統流量C	○	○	○	
逃がし安全弁出口温度	○	○	-	
原子炉再循環ポンプ入口温度	○	○	-	
原子炉給水流量	○	○	-	

※1: ERSS伝送パラメータは既設SPDSのERSS伝送パラメータ及び既設SPDSから追加したパラメータのうち、プラント状態を把握する主要なパラメータをERSSへ伝送する。
原子力事業者防災業務計画の改定に合わせ、必要に応じ適宜見直ししていく。

： SA範囲

3.5 中央制御室待避室内のプラントパラメータ監視装置(中央制御室待避室)で確認できるパラメータ

表 3.5-1 プラントパラメータ監視装置(中央制御室待避室)で確認できるパラメータ(1/6)

目的	対象パラメータ
炉心反応度の状態確認	APRM(平均値)
	平均出力領域計装 CH1
	平均出力領域計装 CH2
	平均出力領域計装 CH3
	平均出力領域計装 CH4
	平均出力領域計装 CH5
	平均出力領域計装 CH6
	中性子源領域計装 CH21
	中性子源領域計装 CH22
	中性子源領域計装 CH23
	中性子源領域計装 CH24
	IRMレベル CH11
	IRMレベル CH12
	IRMレベル CH13
	IRMレベル CH14
	IRMレベル CH15
	IRMレベル CH16
	IRMレベル CH17
IRMレベル CH18	
炉心冷却の状態確認	原子炉圧力
	A-原子炉圧力
	B-原子炉圧力
	原子炉圧力(SA)
	原子炉水位(広帯域)
	A-原子炉水位(広帯域)
	B-原子炉水位(広帯域)
	原子炉水位(燃料域)
	A-原子炉水位(燃料域)
	B-原子炉水位(燃料域)
	原子炉水位(狭帯域)
	原子炉水位(SA)
	A SR弁 開
	B SR弁 開
	C SR弁 開
D SR弁 開	
E SR弁 開	
F SR弁 開	
G SR弁 開	
H SR弁 開	
J SR弁 開	
K SR弁 開	
L SR弁 開	
M SR弁 開	

： SA範囲

・設備の相違
【柏崎6/7,東海第二】

6号炉 (2/7)

第3.5-1表 データ表示装置(待避室)で確認できるパラメータ (2/6)

表3.5-1 プラントパラメータ監視装置(中央制御室待避室)で確認できるパラメータ(2/6)

・設備の相違
【柏崎6/7,東海第二】

目的	対象パラメータ
炉心冷却の状態確認	HPCF (B) 系統流量
	HPCF (C) 系統流量
	RCIC系統流量
	高圧代替注水系統流量
	RHR (A) 系統流量
	RHR (B) 系統流量
	RHR (C) 系統流量
	残留熱除去系熱交換器 (A) 入口温度
	残留熱除去系熱交換器 (B) 入口温度
	残留熱除去系熱交換器 (C) 入口温度
	残留熱除去系熱交換器 (A) 出口温度
	残留熱除去系熱交換器 (B) 出口温度
	残留熱除去系熱交換器 (C) 出口温度
	残留熱除去系熱交換器 (A) 入口冷却水流量
	残留熱除去系熱交換器 (B) 入口冷却水流量
	残留熱除去系熱交換器 (C) 入口冷却水流量
	原子炉補機冷却水系統 (A) 系統流量
	原子炉補機冷却水系統 (B) 系統流量
	原子炉補機冷却水系統 (C) 系統流量
	6.9kV 6A1母線電圧
	6.9kV 6A2母線電圧
	6.9kV 6B1母線電圧
	6.9kV 6B2母線電圧
	6.9kV 6SA1母線電圧
	6.9kV 6SA2母線電圧
	6.9kV 6SB1母線電圧
	6.9kV 6SB2母線電圧
	6.9kV 6C母線電圧
	6.9kV 6D母線電圧
	6.9kV 6E母線電圧
	D/G 6A 遮断器 投入
	D/G 6B 遮断器 投入
	D/G 6C 遮断器 投入
	原子炉圧力容器温度 (原子炉圧力容器下線上部温度)
	復水補給水系統流量 (原子炉圧力容器) (RPV注水流量)
	復水貯蔵槽水位 (SA)

目的	対象パラメータ	SPDS パラメータ	ERSS伝 送パラメータ (※1)	バックアップ 対象パラメータ
炉心冷却の状態確認	原子炉圧力容器温度	○	○	○
	残留熱除去系熱交換器入口温度	○	○	○
	高圧代替注水系統流量	○	○	○
	低圧代替注水系統原子炉注水流量 (常設ライン用)	○	○	○
	低圧代替注水系統原子炉注水流量 (常設ライン狭帯域用)	○	○	○
	低圧代替注水系統原子炉注水流量 (可搬ライン用)	○	○	○
	低圧代替注水系統原子炉注水流量 (可搬ライン狭帯域用)	○	○	○
	代替循環冷却系原子炉注水流量	○	○	○
	代替淡水貯槽水位	○	○	○
	西側淡水貯槽水位	○	○	○
	M/C 2A-1電圧	○	○	-
	M/C 2A-2電圧	○	○	-
	M/C 2B-1電圧	○	○	-
	M/C 2B-2電圧	○	○	-
	M/C 2C電圧	○	○	○
	M/C 2D電圧	○	○	○
	M/C HPCS電圧	○	○	○
	D/G 2C遮断器(660)閉	○	○	-
	D/G 2D遮断器(670)閉	○	○	-
	HPCS D/G遮断器(680)閉	○	○	-
	圧力容器フランジ温度	○	○	-
	125V系蓄電池A系電圧	○	○	○
	125V系蓄電池B系電圧	○	○	○
125V系蓄電池HPCS系電圧	○	○	○	
緊急用直流125V主母線電圧	○	○	○	
緊急用M/C電圧	○	○	○	
緊急用P/C電圧	○	○	○	
原子炉格納容器内の状態確認	格納容器雰囲気放射線モニタ(D/W)(A)	○	○	○
	格納容器雰囲気放射線モニタ(D/W)(B)	○	○	○
	格納容器雰囲気放射線モニタ(S/C)(A)	○	○	○
	格納容器雰囲気放射線モニタ(S/C)(B)	○	○	○
	ドライウエル圧力 (広帯域)	○	○	○
ドライウエル圧力 (狭帯域)	○	○	○	
ドライウエル圧力	○	○	○	

※1: ERSS伝送パラメータは既設SPDSのERSS伝送パラメータ及び既設SPDSから追加したパラメータのうち、プラント状態を把握する主要なパラメータをERSSへ伝送する。
原子力事業者防災業務計画の改定に合わせ、必要に応じ適宜見直ししていく。

目的	対象パラメータ	
炉心冷却の状態確認	高圧炉心スプレイポンプ出口流量	
	高圧炉心スプレイポンプ出口圧力	
	低圧炉心スプレイポンプ出口流量	
	低圧炉心スプレイポンプ出口圧力	
	原子炉隔離時冷却ポンプ出口流量	
	原子炉隔離時冷却ポンプ出口圧力	
	高圧原子炉代替注水流量	
	A-残留熱除去ポンプ出口流量	
	B-残留熱除去ポンプ出口流量	
	C-残留熱除去ポンプ出口流量	
	A-残留熱除去ポンプ出口圧力	
	B-残留熱除去ポンプ出口圧力	
	C-残留熱除去ポンプ出口圧力	
	残留熱代替注水系統原子炉注水流量	
	A-残留熱除去系熱交換器入口温度	
	B-残留熱除去系熱交換器入口温度	
	A-残留熱除去系熱交換器出口温度	
	B-残留熱除去系熱交換器出口温度	
	A-残留熱除去系熱交換器冷却水流量	
	B-残留熱除去系熱交換器冷却水流量	
	6.9KV 系統電圧 (A)	
	6.9KV 系統電圧 (B)	
	6.9KV 系統電圧 (C)	
	6.9KV 系統電圧 (D)	
	6.9KV 系統電圧 (HPCS)	
	A-D/G受電しゃ断器閉	
	B-D/G受電しゃ断器閉	
	A-原子炉圧力容器温度 (SA)	
	B-原子炉圧力容器温度 (SA)	
	A-低圧原子炉代替注水ポンプ出口圧力	
	B-低圧原子炉代替注水ポンプ出口圧力	
	A-低圧原子炉代替注水流量	
	B-低圧原子炉代替注水流量	
	A-低圧原子炉代替注水流量 (狭帯域用)	
	B-低圧原子炉代替注水流量 (狭帯域用)	
	低圧原子炉代替注水槽水位	
	HPCS-D/G受電しゃ断器閉	
	緊急用M/C電圧	
	SA-L/C電圧	
	A-再循環ポンプ入口温度	
	B-再循環ポンプ入口温度	
	原子炉格納容器内の状態確認	A-格納容器雰囲気放射線モニタ (ドライウエル)
		B-格納容器雰囲気放射線モニタ (ドライウエル)
A-格納容器雰囲気放射線モニタ (サブプレッション・チェンバ)		
B-格納容器雰囲気放射線モニタ (サブプレッション・チェンバ)		

○ : SA範囲

○ : SA範囲

○ : SA範囲

6号炉 (3/7)

目的	対象パラメータ
格納容器内の状態確認	CAMS (A) D/W放射能
	CAMS (B) D/W放射能
	CAMS (A) S/C放射能
	CAMS (B) S/C放射能
	ドライウエル圧力 (広帯域) (最大)
	格納容器内圧力 (D/W)
	サブプレッション・チェンバ圧力 (最大)
	格納容器内圧力 (S/C)
	RPVベロシールド周辺温度 (最大)
	サブプレッションプール水位 BV
	サブプレッション・チェンバ・プール水位
	サブプレッション・チェンバ気体温度
	S/P水温度 (最大)
	サブプレッション・チェンバ・プール水温度 (中間上部)
	サブプレッション・チェンバ・プール水温度 (中間下部)
	サブプレッション・チェンバ・プール水温度 (下部)
	CAMS (A) 水素濃度
	CAMS (B) 水素濃度
	格納容器内水素濃度 (SA) (D/W)
	格納容器内水素濃度 (SA) (S/C)
	CAMS (A) 酸素濃度
	CAMS (B) 酸素濃度
	CAMS (A) サンプル切替 (D/W)
	CAMS (B) サンプル切替 (D/W)
	RHR (A) 系統流量
	RHR (B) 系統流量
	RHR (C) 系統流量
	RHR格納容器冷却ライン隔離弁B 全開以外
	RHR格納容器冷却ライン隔離弁C 全開以外
	残留熱除去系ポンプ (A) 吐出圧力
	残留熱除去系ポンプ (B) 吐出圧力
	残留熱除去系ポンプ (C) 吐出圧力
	ドライウエル雰囲気温度 (上部ドライウエルフランジ部雰囲気温度)
ドライウエル雰囲気温度 (下部ドライウエルリターンライン上部雰囲気温度)	
復水補給水流量 (原子炉格納容器) (ドライウエル注水流量)	

: SA範囲

第3.5-1表 データ表示装置 (待避室) で確認できるパラメータ (3/6)

目的	対象パラメータ	SPDSパラメータ	ERSS伝送パラメータ (※1)	バックアップ対象パラメータ
原子炉格納容器内の状態確認	サブプレッション・チェンバ圧力	○	○	○
	サブプレッション・プール圧力	○	○	—
	ドライウエル雰囲気温度	○	○	○
	サブプレッション・プール水温度 (平均値)	○	○	○
	サブプレッション・プール水温度	○	○	○
	サブプレッション・プール雰囲気温度	○	○	○
	サブプレッション・チェンバ雰囲気温度	○	○	○
	サブプレッション・プール水位	○	○	○
	格納容器雰囲気水素濃度 (D/W)	○	○	—
	格納容器雰囲気水素濃度 (S/C)	○	○	—
	格納容器雰囲気酸素濃度 (D/W)	○	○	—
	格納容器雰囲気酸素濃度 (S/C)	○	○	—
	格納容器内水素濃度 (SA)	○	○	○
	格納容器内酸素濃度 (SA)	○	○	○
	低圧代替注水系格納容器スプレイ流量 (常設ライン用)	○	○	○
	低圧代替注水系格納容器スプレイ流量 (可搬ライン用)	○	○	○
	低圧代替注水系格納容器下部注水流量	○	○	○
	代替循環冷却系格納容器スプレイ流量	○	○	○
	格納容器下部水位	○	○	○
	格納容器下部水温	○	○	○
	常設高圧代替注水系ポンプ吐出圧力	○	○	○
	常設低圧代替注水系ポンプ吐出圧力	○	○	○
	代替循環冷却系ポンプ吐出圧力	○	○	○
	原子炉隔離時冷却ポンプ吐出圧力	○	○	○
	高圧炉心スプレイ系ポンプ吐出圧力	○	○	○
	残留熱除去系ポンプ吐出圧力	○	○	○
	低圧炉心スプレイ系ポンプ吐出圧力	○	○	○
	代替循環冷却系ポンプ入口温度	○	○	○
	残留熱除去系熱交換器出口温度	○	○	○
	残留熱除去系海水系系統流量	○	○	○
	緊急用海水系流量 (残留熱除去系熱交換器)	○	○	○
	緊急用海水系流量 (残留熱除去系補機)	○	○	○

※1: ERSS伝送パラメータは既設SPDSのERSS伝送パラメータ及び既設SPDSから追加したパラメータのうち、プラント状態を把握する主要なパラメータをERSSへ伝送する。
原子力事業者防災業務計画の改定に合わせ、必要に応じて適宜見直ししていく。

: SA範囲

表3.5-1 プラントパラメータ監視装置 (中央制御室待避室) で確認できるパラメータ (3/6)

目的	対象パラメータ
原子炉格納容器内の状態確認	ドライウエル圧力 (広域)
	A-ドライウエル圧力 (SA)
	B-ドライウエル圧力 (SA)
	A-サブプレッション・チェンバ圧力 (SA)
	B-サブプレッション・チェンバ圧力 (SA)
	サブプレッション・プール水位
	サブプレッション・プール水位 (SA)
	A-サブプレッション・チェンバ温度 (SA)
	B-サブプレッション・チェンバ温度 (SA)
	サブプレッション・プール水温度 (MAX)
	A-サブプレッション・プール水温度 (SA)
	B-サブプレッション・プール水温度 (SA)
	A-格納容器水素濃度
	B-格納容器水素濃度
	格納容器水素濃度 (SA)
	A-格納容器酸素濃度
	B-格納容器酸素濃度
	格納容器酸素濃度 (SA)
	A-CAMSドライウエル選択
	B-CAMSドライウエル選択
	ドライウエル温度 (トップヘッド部)
	A-ドライウエル温度 (SA) (上部)
	B-ドライウエル温度 (SA) (上部)
	A-ドライウエル温度 (SA) (中部)
	B-ドライウエル温度 (SA) (中部)
	A-ドライウエル温度 (SA) (下部)
	B-ドライウエル温度 (SA) (下部)
	ベデスタル水位 (コリウムシールド上表面 +0.1m)
	ベデスタル水位 (コリウムシールド上表面 +1.2m)
	A-ベデスタル水位 (コリウムシールド上表面 +2.4m)
	B-ベデスタル水位 (コリウムシールド上表面 +2.4m)
	代替注水流量 (常設)
	A-格納容器代替スプレイ流量
	B-格納容器代替スプレイ流量
	A-ベデスタル代替注水流量
	B-ベデスタル代替注水流量
	A-ベデスタル代替注水流量 (狭帯域用)
	B-ベデスタル代替注水流量 (狭帯域用)
	残留熱代替除去系格納容器スプレイ流量
	A-ベデスタル温度 (SA)
	B-ベデスタル温度 (SA)
	A-ベデスタル水温度 (SA)
	B-ベデスタル水温度 (SA)
	A-残留熱代替除去ポンプ出口圧力
	B-残留熱代替除去ポンプ出口圧力
	ドライウエル水位 (格納容器底面 -3m)
	ドライウエル水位 (格納容器底面 -1m)
	ドライウエル水位 (格納容器底面 +1m)

: SA範囲

・設備の相違
【柏崎 6/7, 東海第二】

6号炉 (4/7)

第3.5-1表 データ表示装置(待避室)で確認できるパラメータ (4/6)

表3.5-1 プラントパラメータ監視装置(中央制御室待避室)で確認できるパラメータ(4/6)

目的	対象パラメータ
格納容器内の状態確認	復水移送ポンプ(A)吐出圧力
	復水移送ポンプ(B)吐出圧力
	復水移送ポンプ(C)吐出圧力
	復水補給水系温度(代替循環冷却)
	格納容器下部水位(ベグスタル水位高(2a))
	格納容器下部水位(ベグスタル水位高(2a))
	格納容器下部水位(ベグスタル水位高(1a))
	復水補給水系流量(原子炉格納容器)(ベグスタル注水流量)
放射能隔離の状態確認	排気管排気放射能(1C)(最大)
	排気管排気(SCIN)放射能(A)
	排気管排気(SCIN)放射能(B)
	主蒸気管放射能高(スクラム)区分(1)
	主蒸気管放射能高(スクラム)区分(2)
	主蒸気管放射能高(スクラム)区分(3)
	主蒸気管放射能高(スクラム)区分(4)
	PCIS隔離 内側
	PCIS隔離 外側
	MSIV(内側) 閉
	主蒸気内側隔離弁(A) 全開以外
	主蒸気内側隔離弁(B) 全開以外
	主蒸気内側隔離弁(C) 全開以外
	主蒸気内側隔離弁(D) 全開以外
	MSIV(外側) 閉
	主蒸気外側隔離弁(A) 全開以外
	主蒸気外側隔離弁(B) 全開以外
	主蒸気外側隔離弁(C) 全開以外
主蒸気外側隔離弁(D) 全開以外	
環境の情報確認	SGTS(A)作動(1系)
	SGTS(B)作動(1系)
	SGTS排ガス放射能(1C)(最大)
	SGTS排ガス(SCIN)放射能(A)
	SGTS排ガス(SCIN)放射能(B)

目的	対象パラメータ	SPDSパラメータ	ERSS伝送パラメータ(※1)	バックアップ対象パラメータ
原子炉格納容器内の状態確認	残留熱除去系 A注入弁全開	○	○	—
	残留熱除去系 B注入弁全開	○	○	—
	残留熱除去系 C注入弁全開	○	○	—
	格納容器内スプレイ弁A(全開)	○	○	—
	格納容器内スプレイ弁B(全開)	○	○	—
	格納容器内スプレイ弁C(全開)	○	○	—
放射能隔離の状態確認	主排気筒放射線モニタA	○	○	—
	主排気筒放射線モニタB	○	○	—
	主排気筒モニタ(高レンジ)	○	○	—
	主蒸気管放射線モニタ(A)	○	○	○
	主蒸気管放射線モニタ(B)	○	○	○
	主蒸気管放射線モニタ(C)	○	○	○
	主蒸気管放射線モニタ(D)	○	○	○
	排ガス放射能(プレホールドアップ)A	○	○	—
	排ガス放射能(プレホールドアップ)B	○	○	—
	NS4内側隔離	○	○	—
	NS4外側隔離	○	○	—
	主蒸気内側隔離弁A全開	○	○	—
	主蒸気内側隔離弁B全開	○	○	—
	主蒸気内側隔離弁C全開	○	○	—
	主蒸気内側隔離弁D全開	○	○	—
	主蒸気外側隔離弁A全開	○	○	—
	主蒸気外側隔離弁B全開	○	○	—
	主蒸気外側隔離弁C全開	○	○	—
主蒸気外側隔離弁D全開	○	○	—	
環境の情報確認	SGTS A作動	○	○	—
	SGTS B作動	○	○	—
	SGTSモニタ(高レンジ)A	○	○	—
	SGTSモニタ(高レンジ)B	○	○	—
	SGTSモニタ(低レンジ)A	○	○	—
	SGTSモニタ(低レンジ)B	○	○	—

※1: ERSS伝送パラメータは既設SPDSのERSS伝送パラメータ及び既設SPDSから追加したパラメータのうち、プラント状態を把握する主要なパラメータをERSSへ伝送する。
原子力事業者防災業務計画の改定に合わせ、必要に応じ適宜見直ししていく。

目的	対象パラメータ	
放射能隔離の状態確認	排気筒高レンジモニタ	
	排気筒低レンジモニタ(Ach)	
	排気筒低レンジモニタ(Bch)	
	主蒸気管放射線異常高トリップA1	
	主蒸気管放射線異常高トリップB1	
	主蒸気管放射線異常高トリップA2	
	主蒸気管放射線異常高トリップB2	
	格納容器内側隔離	
	格納容器外側隔離	
	A-主蒸気内側隔離弁全開	
	B-主蒸気内側隔離弁全開	
	C-主蒸気内側隔離弁全開	
	D-主蒸気内側隔離弁全開	
	A-主蒸気外側隔離弁全開	
	B-主蒸気外側隔離弁全開	
	C-主蒸気外側隔離弁全開	
	D-主蒸気外側隔離弁全開	
	環境の状態確認	A-SGT自動起動
		B-SGT自動起動
		SGTS高レンジモニタ
		SGTS低レンジモニタ(Ach)
		SGTS低レンジモニタ(Bch)
		A-原子炉建物外気差圧
		B-原子炉建物外気差圧
C-原子炉建物外気差圧		
D-原子炉建物外気差圧		
中央制御室外気差圧		
放水路水モニタ		
モニタリング・ポスト#1H		
モニタリング・ポスト#2H		
モニタリング・ポスト#3H		
モニタリング・ポスト#4H		
モニタリング・ポスト#5H		
モニタリング・ポスト#6H		
モニタリング・ポスト#1L(10分間平均)		
モニタリング・ポスト#2L(10分間平均)		
モニタリング・ポスト#3L(10分間平均)		
モニタリング・ポスト#4L(10分間平均)		
モニタリング・ポスト#5L(10分間平均)		
モニタリング・ポスト#6L(10分間平均)		
風向(28.5m-U)		
風向(130M-D, 10分間平均風向)		
風速(28.5m-U)		
風速(130M-D, 10分間平均風速)		
大気安定度(10分間平均)		

・設備の相違
【柏崎6/7,東海第二】

 : SA範囲

 : SA範囲

 : SA範囲

6号炉 (5/7)

目的	対象パラメータ
非常用炉心冷却系 (ECC S) の状態等	ADS A 作動
	ADS B 作動
	RCIC 作動
	HPCFポンプ (B) 起動
	HPCFポンプ (C) 起動
	RHRポンプ (A) 起動
	RHRポンプ (B) 起動
	RHRポンプ (C) 起動
	RHR注入弁 (A) 全開以外
	RHR注入弁 (B) 全開以外
	RHR注入弁 (C) 全開以外
	全制御棒全挿入
	給排水流量
	使用済燃料貯蔵プール水位・温度 (SA) (使用済燃料貯蔵プールエリア雰囲気温度)
使用済燃料貯蔵プール水位・温度 (SA) (使用済燃料貯蔵プール温度(燃料ラック上端+6000mm))	
使用済燃料貯蔵プール水位・温度 (SA) (使用済燃料貯蔵プール温度(燃料ラック上端+5000mm))	
使用済燃料貯蔵プール水位・温度 (SA) (使用済燃料貯蔵プール温度(燃料ラック上端+4000mm))	
使用済燃料貯蔵プール水位・温度 (SA) (使用済燃料貯蔵プール温度(燃料ラック上端+3000mm))	
使用済燃料貯蔵プール水位・温度 (SA) (使用済燃料貯蔵プール温度(燃料ラック上端+2000mm))	
使用済燃料貯蔵プール水位・温度 (SA) (使用済燃料貯蔵プール温度(燃料ラック上端+1000mm))	
使用済燃料貯蔵プール水位・温度 (SA) (使用済燃料貯蔵プール温度(燃料ラック上端))	
使用済燃料貯蔵プール水位・温度 (SA) (使用済燃料貯蔵プール温度(燃料ラック上端-1000mm))	
使用済燃料貯蔵プール放射線モニタ (低レンジ)	
使用済燃料貯蔵プール放射線モニタ (高レンジ)	

○ : SA範囲

第3.5-1表 データ表示装置 (待避室) で確認できるパラメータ (5/6)

目的	対象パラメータ	SPDSパラメータ	ERSS伝送パラメータ(※1)	バックアップ対象パラメータ
環境の情報確認	耐圧強化ベント系放射線モニタ	○	○	○
	放水口モニタ(T-2)	○	○	-
	モニタリング・ポスト(A)	○	○	-
	モニタリング・ポスト(B)	○	○	-
	モニタリング・ポスト(C)	○	○	-
	モニタリング・ポスト(D)	○	○	-
	モニタリング・ポスト(A)広域レンジ	○	○	-
	モニタリング・ポスト(B)広域レンジ	○	○	-
	モニタリング・ポスト(C)広域レンジ	○	○	-
	モニタリング・ポスト(D)広域レンジ	○	○	-
	大気安定度 10分値	○	○	-
	18m ベクトル平均風向 10分値	○	○	-
	71m ベクトル平均風向 10分値	○	○	-
	140m ベクトル平均風向 10分値	○	○	-
18m ベクトル平均風速 10分値	○	○	-	
71m ベクトル平均風速 10分値	○	○	-	
140m ベクトル平均風速 10分値	○	○	-	

※1: ERSS伝送パラメータは既設SPDSのERSS伝送パラメータ及び既設SPDSから追加したパラメータのうち、プラント状態を把握する主要なパラメータをERSSへ伝送する。原子力事業者防災業務計画の改定に合わせて、必要に応じ適宜見直ししていく。

○ : SA範囲

表3.5-1 プラントパラメータ監視装置 (中央制御室待避室) で確認できるパラメータ (5/6)

目的	対象パラメータ
環境の状態確認	可搬式モニタリング・ポストNo.1
	可搬式モニタリング・ポストNo.2
	可搬式モニタリング・ポストNo.3
	可搬式モニタリング・ポストNo.4
	可搬式モニタリング・ポストNo.5
	可搬式モニタリング・ポストNo.6
	可搬式モニタリング・ポストNo.7
	可搬式モニタリング・ポストNo.8
	可搬式モニタリング・ポストNo.9
	可搬式モニタリング・ポストNo.10
	可搬式モニタリング・ポストNo.11
	可搬式モニタリング・ポストNo.12
風向 (可搬)	
風速 (可搬)	
大気安定度 (可搬)	
非常用炉心冷却系 (ECC S) の状態等確認	A-ADS作動
	B-ADS作動
	RCICポンプ作動
	HPCSポンプ作動
	A-RHRポンプ作動
	B-RHRポンプ作動
	C-RHRポンプ作動
	RHR MV222-4A 全閉
	RHR MV222-4B 全閉
	RHR MV222-5A 全閉
	RHR MV222-5B 全閉
	RHR MV222-5C 全閉
全制御棒全挿入	
A-給水流量	
B-給水流量	
LPCSポンプ作動	
モードSW運転	
燃料プールの状態確認	燃料プール水位・温度 (SA) (使用済燃料貯蔵ラック上端+6710mm)
	燃料プール水位・温度 (SA) (使用済燃料貯蔵ラック上端+5800mm)
	燃料プール水位・温度 (SA) (使用済燃料貯蔵ラック上端+4500mm)
	燃料プール水位・温度 (SA) (使用済燃料貯蔵ラック上端+2000mm)
	燃料プール水位・温度 (SA) (使用済燃料貯蔵ラック上端レベル)
	燃料プール水位・温度 (SA) (使用済燃料貯蔵ラック上端-1000mm)
	燃料プール水位・温度 (SA) (燃料プール温度)
	燃料プール水位 (SA)
	燃料プールエリア放射線モニタ (低レンジ) (SA)
	燃料プールエリア放射線モニタ (高レンジ) (SA)

○ : SA範囲

・設備の相違
【柏崎6/7, 東海第二】

6号炉 (6/7)

目的	対象パラメータ
使用済燃料プールの状態確認	使用済燃料貯蔵プール水位・温度 (SA広域) (使用済燃料貯蔵プールエリア雰囲気温度)
	使用済燃料貯蔵プール水位・温度 (SA広域) (使用済燃料貯蔵プール温度(燃料ラック上層 +6750mm))
	使用済燃料貯蔵プール水位・温度 (SA広域) (使用済燃料貯蔵プール温度(燃料ラック上層 +6500mm))
	使用済燃料貯蔵プール水位・温度 (SA広域) (使用済燃料貯蔵プール温度(燃料ラック上層 +6000mm))
	使用済燃料貯蔵プール水位・温度 (SA広域) (使用済燃料貯蔵プール温度(燃料ラック上層 +5500mm))
	使用済燃料貯蔵プール水位・温度 (SA広域) (使用済燃料貯蔵プール温度(燃料ラック上層 +5000mm))
	使用済燃料貯蔵プール水位・温度 (SA広域) (使用済燃料貯蔵プール温度(燃料ラック上層 +4000mm))
	使用済燃料貯蔵プール水位・温度 (SA広域) (使用済燃料貯蔵プール温度(燃料ラック上層 +3000mm))
	使用済燃料貯蔵プール水位・温度 (SA広域) (使用済燃料貯蔵プール温度(燃料ラック上層 +2000mm))
	使用済燃料貯蔵プール水位・温度 (SA広域) (使用済燃料貯蔵プール温度(燃料ラック上層 +1000mm))
	使用済燃料貯蔵プール水位・温度 (SA広域) (使用済燃料貯蔵プール温度(燃料ラック上層))
	使用済燃料貯蔵プール水位・温度 (SA広域) (使用済燃料貯蔵プール温度(燃料ラック上層 -1000mm))
	使用済燃料貯蔵プール水位・温度 (SA広域) (使用済燃料貯蔵プール温度(燃料ラック上層 -3000mm))
	使用済燃料貯蔵プール水位・温度 (SA広域) (使用済燃料貯蔵プール温度(プール底部付近))

○ : SA範囲

第3.5-1表 データ表示装置(待避室)で確認できるパラメータ

(6/6)

目的	対象パラメータ	SPDSパラメータ	ERSS伝送パラメータ(※1)	バックアップ対象パラメータ
使用済燃料プールの状態確認	使用済燃料プール水位・温度 (SA広域)	○	○	○
	使用済燃料プール温度 (SA)	○	○	○
	使用済燃料プール温度 使用済燃料プールエリア放射線モニタ (高レンジ・低レンジ)	○	○	○
水素爆発による格納容器の破損防止確認	フィルタ装置出口放射線モニタ (高レンジ・低レンジ)	○	○	○
	フィルタ装置入口水素濃度	○	○	○
	フィルタ装置圧力	○	○	○
水素爆発による原子炉建屋の損傷防止確認	フィルタ装置水位	○	○	○
	フィルタ装置スクラビング水温度	○	○	○
	原子炉建屋水素濃度	○	○	○
非常用炉心冷却系(ECCS)の状態等	静的触媒式水素再結合器動作監視装置	○	○	○
	自動減圧系 A 作動	○	○	-
	自動減圧系 B 作動	○	○	-
	非常用窒素供給系供給圧力	○	○	○
	非常用窒素供給系高圧窒素ポンベ圧力	○	○	○
	非常用逃がし安全弁駆動系供給圧力	○	○	○
	非常用逃がし安全弁駆動系高圧窒素ポンベ圧力	○	○	○
	原子炉隔離時冷却系ポンプ起動	○	○	-
	高圧炉心スプレイ系ポンプ起動	○	○	-
	高圧炉心スプレイ系注入弁全開	○	○	-
	低圧炉心スプレイ系ポンプ起動	○	○	-
	低圧炉心スプレイ系注入弁全開	○	○	-
	残留熱除去系ポンプA起動	○	○	-
	残留熱除去系ポンプB起動	○	○	-
	残留熱除去系ポンプC起動	○	○	-
	残留熱除去系A注入弁全開	○	○	-
残留熱除去系B注入弁全開	○	○	-	
残留熱除去系C注入弁全開	○	○	-	
全制御棒全挿入	○	○	-	
津波監視	取水ビット水位計	○	○	○
	潮位計	○	○	○

※1: ERSS伝送パラメータは既設SPDSのERSS伝送パラメータ及び既設SPDSから追加したパラメータのうち、プラント状態を把握する主要なパラメータをERSSへ伝送する。
原子力事業者防災業務計画の改定に合わせ、必要に応じ適宜見直ししていく。

○ : SA範囲

表3.5-1 プラントパラメータ監視装置(中央制御室待避室)で

確認できるパラメータ(6/6)

目的	対象パラメータ
水素爆発による原子炉格納容器の破損防止確認	A-第1ベントフィルタ出口水素濃度
	B-第1ベントフィルタ出口水素濃度
	A-第1ベントフィルタ出口放射線モニタ (高レンジ)
	B-第1ベントフィルタ出口放射線モニタ (高レンジ)
	第1ベントフィルタ出口放射線モニタ (低レンジ)
	A-スクラバ容器圧力
	B-スクラバ容器圧力
	C-スクラバ容器圧力
	D-スクラバ容器圧力
	A1-スクラバ容器水位
	A2-スクラバ容器水位
	B1-スクラバ容器水位
	B2-スクラバ容器水位
	C1-スクラバ容器水位
	C2-スクラバ容器水位
	D1-スクラバ容器水位
D2-スクラバ容器水位	
A-スクラバ容器温度	
B-スクラバ容器温度	
C-スクラバ容器温度	
D-スクラバ容器温度	
水素爆発による原子炉建物の損傷防止確認	A-原子炉建物水素濃度 (燃料取替階)
	B-原子炉建物水素濃度 (燃料取替階)
	原子炉建物水素濃度 (非常用ガス処理系吸込口)
	原子炉建物水素濃度 (所員用エアロック室)
	原子炉建物水素濃度 (SRV補修室)
	原子炉建物水素濃度 (CRD補修室)
	原子炉建物水素濃度 (トラス室)
	D-静的触媒式水素処理装置入口温度
D-静的触媒式水素処理装置出口温度	
S-静的触媒式水素処理装置入口温度	
S-静的触媒式水素処理装置出口温度	

○ : SA範囲

・設備の相違
【柏崎6/7,東海第二】

6号炉 (7/7)

目的	対象パラメータ	
水素爆発による格納容器の破損防止機能	フィルタ装置水素濃度 (格納容器圧力逃がし装置水素濃度)	
	フィルタ装置水素濃度 (フィルタベント装置出口水素濃度)	
	フィルタ装置出口放射線モニタ (A)	
	フィルタ装置出口放射線モニタ (B)	
	フィルタ装置入口圧力	
	フィルタ装置水位 (A)	
	フィルタ装置水位 (B)	
	フィルタ装置スクラバ水 pH	
	フィルタ装置金属フィルタ差圧	
	耐圧強化ベント系放射線モニタ (A)	
	耐圧強化ベント系放射線モニタ (B)	
	水素爆発による原子炉建屋の損傷防止機能	原子炉建屋水素濃度 (R/Bオベフロ水素濃度A)
		原子炉建屋水素濃度 (R/Bオベフロ水素濃度B)
原子炉建屋水素濃度 (上部ドライウエル所員用エアロック)		
原子炉建屋水素濃度 (上部ドライウエル機器搬入用ハッチ)		
原子炉建屋水素濃度 (サブプレッション・チェンバ出入口)		
原子炉建屋水素濃度 (下部ドライウエル所員用エアロック)		
原子炉建屋水素濃度 (下部ドライウエル機器搬入用ハッチ)		
静的触媒式水素再結合器 動作監視装置 (北側PAR吸気濃度)		
静的触媒式水素再結合器 動作監視装置 (北側PAR排気濃度)		
静的触媒式水素再結合器 動作監視装置 (南側PAR吸気濃度)		
静的触媒式水素再結合器 動作監視装置 (南側PAR排気濃度)		

・設備の相違
【柏崎 6/7】

: SA範囲

7号炉 (1 / 7)

目的	対象パラメータ
炉心反応度の状態確認	APRM (平均値)
	APRM (A)
	APRM (B)
	APRM (C)
	APRM (D)
	SRNM (A) 計数率
	SRNM (B) 計数率
	SRNM (C) 計数率
	SRNM (D) 計数率
	SRNM (E) 計数率
	SRNM (F) 計数率
	SRNM (G) 計数率
	SRNM (H) 計数率
	SRNM (J) 計数率
	SRNM (L) 計数率
	SRNM A 計数率高差
	SRNM B 計数率高差
	SRNM C 計数率高差
	SRNM D 計数率高差
	SRNM E 計数率高差
	SRNM F 計数率高差
	SRNM G 計数率高差
	SRNM H 計数率高差
SRNM J 計数率高差	
SRNM L 計数率高差	
炉心冷却の状態確認	原子炉圧力 A
	原子炉圧力 (A)
	原子炉圧力 (B)
	原子炉圧力 (C)
	原子炉圧力 (SA)
	原子炉水位 (W) A
	原子炉水位 (広帯域) (A)
	原子炉水位 (広帯域) (C)
	原子炉水位 (広帯域) (F)
	原子炉水位 (F)
	原子炉水位 (燃料域) (A)
	原子炉水位 (燃料域) (B)
	原子炉水位 (SA) (ワイド)
	原子炉水位 (SA) (ナロー)
	CUW再生熱交換器入口温度
SRV開 (CRT)	

： SA範囲

・申請号炉数の相違
(以下7ページにおいて同じ)
【柏崎6/7】

7号炉 (2 / 7)

目的	対象パラメータ
	HPCF (B) 系統流量
	HPCF (C) 系統流量
	RCIC 系統流量
	高压代替注水系統流量
	RHR (A) 系統流量
	RHR (B) 系統流量
	RHR (C) 系統流量
	残留熱除去系熱交換器 (A) 入口温度
	残留熱除去系熱交換器 (B) 入口温度
	残留熱除去系熱交換器 (C) 入口温度
	残留熱除去系熱交換器 (A) 出口温度
	残留熱除去系熱交換器 (B) 出口温度
	残留熱除去系熱交換器 (C) 出口温度
	残留熱除去系熱交換器 (A) 入口冷却水流量
	残留熱除去系熱交換器 (B) 入口冷却水流量
	残留熱除去系熱交換器 (C) 入口冷却水流量
	原子炉補機冷却水系 (A) 系統流量
	原子炉補機冷却水系 (B) 系統流量
	原子炉補機冷却水系 (C) 系統流量
	6.9kV 7A1 母線電圧
	6.9kV 7A2 母線電圧
	6.9kV 7B1 母線電圧
	6.9kV 7B2 母線電圧
	6.9kV 6SA1 母線電圧
	6.9kV 6SA2 母線電圧
	6.9kV 6SB1 母線電圧
	6.9kV 6SB2 母線電圧
	6.9kV 7C 母線電圧
	6.9kV 7D 母線電圧
	6.9kV 7E 母線電圧
	M/C 7C D/G 受電遮断器閉
	M/C 7D D/G 受電遮断器閉
	M/C 7E D/G 受電遮断器閉
	原子炉圧力容器温度 (RPV 下機上部温度)
	復水補給水系流量 (原子炉圧力容器) (RHR (A) 注入配管流量)
	復水貯蔵槽水位 (SA)

炉心冷却の
状態確認

： SA 範囲

7号炉 (3 / 7)

目的	対象パラメータ
格納容器内の状態確認	格納容器内蒸気放射線モニタ (A) D/W
	格納容器内蒸気放射線モニタ (B) D/W
	格納容器内蒸気放射線モニタ (A) S/C
	格納容器内蒸気放射線モニタ (B) S/C
	ドライウエル圧力 (W)
	格納容器内圧力 (D/W)
	S/C圧力 (最大値)
	格納容器内圧力 (S/C)
	D/W温度 (最大値)
	S/P水温度最大値
	S/P水位 (W) (最大値)
	サブプレッション・チェンバ・プール水位
	サブプレッション・チェンバ気体温度
	サブプレッション・チェンバ・プール水温度 (中間上部)
	サブプレッション・チェンバ・プール水温度 (中間下部)
	サブプレッション・チェンバ・プール水温度 (下部)
	格納容器内水素濃度 (A)
	格納容器内水素濃度 (B)
	格納容器内水素濃度 (SA) (D/W)
	格納容器内水素濃度 (SA) (S/C)
	格納容器内酸素濃度 (A)
	格納容器内酸素濃度 (B)
	CAMS (A) D/W測定中
	CAMS (B) D/W測定中
	CAMS (A) S/C測定中
	CAMS (B) S/C測定中
	RHR (A) 系統流量
	RHR (B) 系統流量
	RHR (C) 系統流量
	PCVスプレイ弁 (B) 全開
	PCVスプレイ弁 (C) 全開
	残留熱除去系ポンプ (A) 吐出圧力
	残留熱除去系ポンプ (B) 吐出圧力
残留熱除去系ポンプ (C) 吐出圧力	
ドライウエル蒸気温度 (上部D/W内蒸気温度)	
ドライウエル蒸気温度 (下部D/W内蒸気温度)	

 : SA範囲

7号炉 (4 / 7)

目的	対象パラメータ
蒸餾容器内の状態確認	復水補給水系流量 (原子炉蒸餾容器) (RHR (B) 注入配管流量)
	復水移送ポンプ (A) 吐出圧力
	復水移送ポンプ (B) 吐出圧力
	復水移送ポンプ (C) 吐出圧力
	復水補給水系温度 (代替循環冷却)
	蒸餾容器下部水位 (D/W下部水位 (3a))
	蒸餾容器下部水位 (D/W下部水位 (2a))
	蒸餾容器下部水位 (D/W下部水位 (1a))
放射能区域の状態確認	復水補給水系流量 (原子炉蒸餾容器) (下部D/W注水流量)
	排気筒放射線モニタ (IC) 最大値
	排気筒放射線モニタ (SCIN) A
	排気筒放射線モニタ (SCIN) B
	区分I主蒸気管放射能高
	区分II主蒸気管放射能高
	区分III主蒸気管放射能高
	区分IV主蒸気管放射能高
	PCIS隔離 内側
	PCIS隔離 外側
	主蒸気内側隔離弁 全弁全開
	主蒸気内側隔離弁 (A) 全開
	主蒸気内側隔離弁 (B) 全開
	主蒸気内側隔離弁 (C) 全開
	主蒸気内側隔離弁 (D) 全開
	主蒸気外側隔離弁 全弁全開
	主蒸気外側隔離弁 (A) 全開
	主蒸気外側隔離弁 (B) 全開
	主蒸気外側隔離弁 (C) 全開
	主蒸気外側隔離弁 (D) 全開
環境の情報確認	SGTS (A) 作動
	SGTS (B) 作動
	SGTS放射線モニタ (IC) 最大値
	SGTS排ガス放射線モニタ (SCIN) A
	SGTS排ガス放射線モニタ (SCIN) B

 : SA範囲

7号炉 (5 / 7)

目的	対象パラメータ
非常用炉心冷却系 (ECCS) の状態等	ADS A 作動
	ADS B 作動
	RCIC 起動状態 (CRT)
	HPCFポンプ (B) 起動
	HPCFポンプ (C) 起動
	RHRポンプ (A) 起動
	RHRポンプ (B) 起動
	RHRポンプ (C) 起動
	RHR注入弁 (A) 全開
	RHR注入弁 (B) 全開
	RHR注入弁 (C) 全開
	全制御棒全挿入
	全給水流量
	使用済燃料プールの状態確認
使用済燃料貯蔵プール水位・温度 (SA) (使用済燃料貯蔵プール温度 (燃料ラック上端+6000mm))	
使用済燃料貯蔵プール水位・温度 (SA) (使用済燃料貯蔵プール温度 (燃料ラック上端+5000mm))	
使用済燃料貯蔵プール水位・温度 (SA) (使用済燃料貯蔵プール温度 (燃料ラック上端+4000mm))	
使用済燃料貯蔵プール水位・温度 (SA) (使用済燃料貯蔵プール温度 (燃料ラック上端+3000mm))	
使用済燃料貯蔵プール水位・温度 (SA) (使用済燃料貯蔵プール温度 (燃料ラック上端+2000mm))	
使用済燃料貯蔵プール水位・温度 (SA) (使用済燃料貯蔵プール温度 (燃料ラック上端+1000mm))	
使用済燃料貯蔵プール水位・温度 (SA) (使用済燃料貯蔵プール温度 (燃料ラック上端))	
使用済燃料貯蔵プール水位・温度 (SA) (使用済燃料貯蔵プール温度 (燃料ラック上端-1000mm))	
使用済燃料貯蔵プール放射線モニタ (低レンジ)	
使用済燃料貯蔵プール放射線モニタ (高レンジ)	

 : SA範囲

7号炉 (6 / 7)

目的	対象パラメータ
使用済燃料プールの状態確認	使用済燃料貯蔵プール水位・温度 (S A 広域) (使用済燃料貯蔵プールエリア雰囲気温度)
	使用済燃料貯蔵プール水位・温度 (S A 広域) (使用済燃料貯蔵プール温度(燃料ラック上層 +6750mm))
	使用済燃料貯蔵プール水位・温度 (S A 広域) (使用済燃料貯蔵プール温度(燃料ラック上層 +6500mm))
	使用済燃料貯蔵プール水位・温度 (S A 広域) (使用済燃料貯蔵プール温度(燃料ラック上層 +6000mm))
	使用済燃料貯蔵プール水位・温度 (S A 広域) (使用済燃料貯蔵プール温度(燃料ラック上層 +5500mm))
	使用済燃料貯蔵プール水位・温度 (S A 広域) (使用済燃料貯蔵プール温度(燃料ラック上層 +5000mm))
	使用済燃料貯蔵プール水位・温度 (S A 広域) (使用済燃料貯蔵プール温度(燃料ラック上層 +4000mm))
	使用済燃料貯蔵プール水位・温度 (S A 広域) (使用済燃料貯蔵プール温度(燃料ラック上層 +3000mm))
	使用済燃料貯蔵プール水位・温度 (S A 広域) (使用済燃料貯蔵プール温度(燃料ラック上層 +2000mm))
	使用済燃料貯蔵プール水位・温度 (S A 広域) (使用済燃料貯蔵プール温度(燃料ラック上層 +1000mm))
	使用済燃料貯蔵プール水位・温度 (S A 広域) (使用済燃料貯蔵プール温度(燃料ラック上層))
	使用済燃料貯蔵プール水位・温度 (S A 広域) (使用済燃料貯蔵プール温度(燃料ラック上層 -1000mm))
	使用済燃料貯蔵プール水位・温度 (S A 広域) (使用済燃料貯蔵プール温度(燃料ラック上層 -3000mm))
	使用済燃料貯蔵プール水位・温度 (S A 広域) (使用済燃料貯蔵プール温度(プール底部付近))

 : S A 範囲

7号炉 (7/7)

目的	対象パラメータ	
水素爆発による箱納容器の破損防止確認	フィルタ装置水素濃度 (箱納容器圧力逃がし装置水素濃度)	
	フィルタ装置水素濃度 (フィルタベント装置出口水素濃度)	
	フィルタ装置出口放射線モニタ (A)	
	フィルタ装置出口放射線モニタ (B)	
	フィルタ装置入口圧力	
	フィルタ装置水位 (A)	
	フィルタ装置水位 (B)	
	フィルタ装置スクラバ水pH	
	フィルタ装置金属フィルタ差圧	
	耐圧強化ベント系放射線モニタ (A)	
	耐圧強化ベント系放射線モニタ (B)	
	水素爆発による原子炉建屋の損傷防止確認	原子炉建屋水素濃度 (R/Bオベフロ水素濃度A)
		原子炉建屋水素濃度 (R/Bオベフロ水素濃度B)
原子炉建屋水素濃度 (上部ドライウエル所員用エアロック)		
原子炉建屋水素濃度 (上部ドライウエル機器搬入用ハッチ)		
原子炉建屋水素濃度 (サブプレッション・チェンバ出入口)		
原子炉建屋水素濃度 (下部ドライウエル所員用エアロック)		
原子炉建屋水素濃度 (下部ドライウエル機器搬入用ハッチ)		
静的触媒式水素再結合器 動作監視装置 (北側PAR吸気濃度)		
静的触媒式水素再結合器 動作監視装置 (北側PAR排気濃度)		
静的触媒式水素再結合器 動作監視装置 (南側PAR吸気濃度)		
静的触媒式水素再結合器 動作監視装置 (南側PAR排気濃度)		

 : SA範囲

柏崎刈羽原子力発電所 6/7号炉 (2017.12.20)	東海第二発電所 (2018.9.18版)	島根原子力発電所 2号炉	備考																						
<p>3.6 事故シーケンスの組み合わせと待避室の収容性</p> <p>重大事故等が発生した場合においても中央制御室に運転員がとどまる居住性を確保するため、中央制御室待避室を設置している。</p> <p>中央制御室待避室は、<u>重大事故等に対応する要員がとどまることができなければならない</u>。そのため、中央制御室待避室の設計は<u>収容可能人数を「20名」としている</u>。その内訳を表3.6-1に示す。</p> <p>表 3.6-1 中央制御室収容人数設計内訳</p> <table border="1" data-bbox="284 653 700 898"> <tr><td>当直長</td><td>1名</td></tr> <tr><td>当直副長</td><td>2名</td></tr> <tr><td>運転員</td><td>12名</td></tr> <tr><td>消火対応要員</td><td>3名</td></tr> <tr><td>予備</td><td>2名</td></tr> <tr><td>合計</td><td>20名</td></tr> </table> <p style="text-align: center;">: SA範囲</p>	当直長	1名	当直副長	2名	運転員	12名	消火対応要員	3名	予備	2名	合計	20名	<p>3.6 中央制御室待避室の内部寸法について</p> <p>(1) 中央制御室待避室に待避する要員数の考え方</p> <p>中央制御室待避室には、<u>3名の運転員が待避することとしている</u>。この要員数を設定した考え方を以下に示す。</p> <p>① <u>待避前に中央制御室で行う以下の運転操作に必要な要員数を確保する。</u></p> <ul style="list-style-type: none"> ➢ <u>格納容器スプレイ停止, 原子炉注水流量の調整及び格納容器ベント操作を, SA操作盤において, 指揮者(発電長)1名及び操作者(運転員A)1名で実施する。</u> ➢ <u>中央制御室待避室の正圧化操作を操作者(運転員B)1名で実施する。</u> <p>したがって、待避前に中央制御室で行う運転操作に必要な要員数は<u>3名</u>である。</p> <p>② 運転員が中央制御室待避室に待避している間は、運転員による運転操作を実施する必要はなく、データ表示装置(待避室)によるプラントパラメータの監視及び衛星電話設備又は携行型有線通話装置による通信連絡を行うこととしており、①に必要な要員数に含まれる。</p> <p>③ 原子炉施設保安規定の定めにより、中央制御室には<u>3名の運転員が常駐する必要がある</u>。</p> <p>以上の条件から、中央制御室待避室の収容要員数を指揮者(発電長)1名及び操作者(運転員A及び運転員B)2名の計<u>3名</u>に設定する。</p> <p style="text-align: center;">: SA範囲</p>	<p>3.6 中央制御室待避室の収容性</p> <p>(1) <u>中央制御室待避室に待避する要員数の考え方</u></p> <p><u>重大事故等が発生した場合においても中央制御室に運転員がとどまる居住性を確保するため、中央制御室待避室を設置している。</u></p> <p>中央制御室待避室は、重大事故時の<u>格納容器ベント実施時に、運転員がとどまることができなければならない</u>。そのため、中央制御室待避室の設計は<u>収容可能人数を「5名」としている</u>。内訳を表3.6-1に示す。</p> <p>表 3.6-1 中央制御室待避室収容人数設計内訳</p> <table border="1" data-bbox="1813 684 2398 915"> <tr><td>当直長</td><td>1名</td></tr> <tr><td>当直副長</td><td>1名</td></tr> <tr><td>運転員(中央制御室)</td><td>1名</td></tr> <tr><td>運転員(現場)</td><td>2名</td></tr> <tr><td>合計</td><td>5名</td></tr> </table> <p>なお、<u>運転員が中央制御室待避室に待避している間は、運転員による運転操作を実施する必要はなく、プラントパラメータ監視装置(中央制御室待避室)によるプラントパラメータの監視及び衛星電話設備(固定型)、無線通信設備(固定型)又は有線式通信設備による連絡を行うこととしており表3.6-1の要員数に含まれる。</u></p> <p style="text-align: center;">: SA範囲</p>	当直長	1名	当直副長	1名	運転員(中央制御室)	1名	運転員(現場)	2名	合計	5名	<p>備考</p> <p>・設備の相違</p> <p>【柏崎6/7, 東海第二】</p> <p>島根2号炉では、当直長、当直副長、中央制御室運転員各1名の他、フィルタベント操作を現場で行った場合の現場運転員2名の計5名を収容できる設計とする。</p>
当直長	1名																								
当直副長	2名																								
運転員	12名																								
消火対応要員	3名																								
予備	2名																								
合計	20名																								
当直長	1名																								
当直副長	1名																								
運転員(中央制御室)	1名																								
運転員(現場)	2名																								
合計	5名																								

柏崎刈羽原子力発電所 6/7号炉 (2017.12.20)	東海第二発電所 (2018.9.18版)	島根原子力発電所 2号炉	備考
<p><u>また、複数号炉の同一中央制御室であるため、重大事故等の事故シーケンスが合わさった場合においても対応が可能である必要がある。そのため、事故シーケンスの組み合わせによる運転員の対応要員数を評価した。</u></p> <p>評価条件として、<u>6号炉において「雰囲気圧力・温度による静的負荷(格納容器過圧・過温破損)(代替循環冷却を使用しない場合)」(以下、「大LOCA」とする)の発生を想定し、7号炉側を事故シーケンス組合せとして、有効性評価における他の事故シナリオを想定した。</u></p> <p>なお、全交流動力電源喪失シナリオは4シナリオあるが、<u>6号炉の原子炉格納容器ベント操作時における対応要員数が変わらないため「全交流動力電源喪失(外部電源喪失+DG喪失)」で代表する。「格納容器雰囲気直接加熱(DCH)」「原子炉圧力容器外の溶融燃料-冷却材相互作用(FCI)」「溶融炉心・コンクリート相互作用(MCCI)」の3シナリオについては「雰囲気圧力・温度による静的負荷(格納容器過圧・過温破損)(代替循環冷却を使用する場合)」で実施する代替循環冷却系を使用した対応と同じであり、「停止中の反応度誤投入」シナリオは、事故の終息が短時間で終了するため対象外とした。</u></p> <p>事故シーケンスの組み合わせによる運転員の対応要員数を表3.6-2に示す。</p> <p><u>事故シーケンスの組み合わせを考慮しても、運転員の対応要員数は最大で「15名」であり、消火活動要員を含めても「18名」であり、中央制御室待避室の設計「20名」により十分対応可能である。</u></p> <p><u>6号炉の原子炉格納容器ベント操作時の7号炉側の作業への影響について表3.6-3に整理した。</u></p> <p><u>また、図3.6-1~14にて事故シーケンス組み合わせ毎の作業時間抜粋を示す。</u></p> <p style="text-align: right;">: SA範囲</p>		<p>また、<u>重大事故等の事故シーケンス毎の運転員の対応要員数を評価した。</u></p> <p>評価条件として、「<u>雰囲気圧力・温度による静的負荷(格納容器過圧・過温破損)(残留熱代替除去系を使用しない場合)</u>」(以下、「大LOCA」とする)の事故シナリオを想定した。</p> <p>なお、全交流動力電源喪失シナリオは4シナリオあるが、対応要員数が変わらないため「<u>全交流動力電源喪失(外部電源喪失+DG失敗)</u>」で代表する。「<u>格納容器雰囲気直接加熱(DCH)」「原子炉圧力容器外の溶融燃料-冷却材相互作用(FCI)」「溶融炉心・コンクリート相互作用(MCCI)」の3シナリオについては「雰囲気圧力・温度による静的負荷(格納容器過圧・過温破損)(残留熱代替除去系を使用する場合)」で実施する残留熱代替除去系を使用した対応と同じであり、「停止中の反応度誤投入」シナリオは、事故の終息が短時間で終了するため対象外とした。</u></p> <p>事故シーケンス毎における運転員の対応要員数を表3.6-2に示す。</p> <p>また、<u>図3.6-1, 2にて中央制御室待避室を使用する事故シーケンスの作業時間抜粋を示す。</u></p> <p style="text-align: right;">: SA範囲</p>	<p>備考</p> <p>・申請号炉数の相違 【柏崎6/7】</p> <p>・記載方針の相違 【柏崎6/7】</p> <p>島根2号炉は中央制御室待避室を使用する事故シーケンスのタイムチャートを記載</p>

表 3.6-2 事故シーケンス組合せによる運転員の対応要員数

6号炉事故シーケンス	7号炉事故シーケンス	対応要員数			消火要員	合計
		当直長	6号炉対応	7号炉対応		
大 LOCA	高圧・低圧注水機能喪失	1名	7名	5名	3名	16名
	高圧注水・減圧機能喪失	1名	7名	5名	3名	16名
	全交流動力電源喪失	1名	7名	7名	3名	18名
	崩壊熱除去機能喪失 (取水機能喪失)	1名	7名	7名	3名	18名
	崩壊熱除去機能喪失 (残留熱除去系機能喪失)	1名	7名	5名	3名	16名
	原子炉停止機能喪失	1名	7名	3名	3名	14名
	LOCA 時注水機能喪失	1名	7名	5名	3名	16名
	格納容器バイパス (インターフェイス LOCA)	1名	7名	7名	3名	18名
	大 LOCA (代替循環冷却を使用する場合)	1名	7名	7名	3名	18名
	想定事故 1		1名	7名	2名	13名
	想定事故 2		1名	7名	4名	15名
	停止中崩壊熱除去機能喪失		1名	7名	4名	15名
	停止中全交流動力電源喪失		1名	7名	4名	15名
	停止中原子炉冷却材の流出		1名	7名	4名	15名

※事故シーケンスの組み合わせを考慮しても、運転員の対応要員数は最大で「15名」であり、消火活動要員を含めても「18名」となることから、中央制御室待避室の設計「20名」により十分対応可能である。

: SA 範囲

表 3.6-2 各事故シーケンスにおける運転員の対応人数

事故シーケンス	対応要員数			合計
	当直長	当直副長	運転員	
高圧・低圧注水機能喪失	1名	1名	3名	5名
高圧注水・減圧機能喪失	1名	1名	1名	3名
全交流動力電源喪失 (外部電源喪失 + DG 失敗)	1名	1名	5名	7名
崩壊熱除去機能喪失 (取水機能喪失)	1名	1名	5名	7名
崩壊熱除去機能喪失 (残留熱除去系機能喪失)	1名	1名	3名	5名
原子炉停止機能喪失	1名	1名	4名	6名
LOCA 時注水機能喪失	1名	1名	4名	6名
格納容器バイパス (インターフェイス LOCA)	1名	1名	3名	5名
大 LOCA (残留熱代替除去系を使用する場合)	1名	1名	5名	7名
大 LOCA (残留熱代替除去系を使用しない場合)	1名	1名	5名 (2名)*	7名 (2名)*
想定事故 1	1名	1名	1名	3名
想定事故 2	1名	1名	3名	5名
停止中崩壊熱除去機能喪失	1名	1名	1名	3名
停止中全交流動力電源喪失	1名	1名	3名	5名
停止中原子炉冷却材の流出	1名	1名	3名	5名

※()内の数値はベント実施前までに、緊急時対策所へ移動する人員数

: SA 範囲

・体制の相違
【柏崎 6/7】
島根 2号炉の各事故シーケンスにおける対応人数を記載

柏崎刈羽原子力発電所 6 / 7号炉 (2017.12.20)	東海第二発電所 (2018.9.18版)	島根原子力発電所 2号炉	備考
	<p>(2) 中央制御室待避室内の必要スペースの考え方</p> <p>中央制御室待避室内で行う作業は、データ表示装置によるプラントパラメータの監視、衛星電話等による通信連絡のみであり、広い作業スペースは不要であることから、以下の条件を考慮して中央制御室待避室の必要寸法を検討する。</p> <ul style="list-style-type: none"> ▶ 運転員 <u>3名</u> が着席して待機するために必要なスペース ▶ <u>データ表示装置</u>、<u>衛星電話</u>及び<u>可搬型照明</u>を配置するためのスペース ▶ 待避室内圧力調整用の配管・バルブの設置及び操作スペース ▶ 携行型有線通話装置接続箱の設置スペース <p>運転員が椅子に座った姿勢で待機するために必要なスペースを1名当たり 500mm×1,200mm とすると、中央制御室待避室の必要寸法は <u>2,000mm×1,200mm</u> となる。</p> <p>(3) 中央制御室待避室の居住性向上</p> <p>中央制御室待避室の必要寸法として <u>2,000mm×1,200mm</u> を設定するが、中央制御室待避室の居住性を向上させるため、以下を実施する。</p> <ul style="list-style-type: none"> ▶ 外部との通信手段の確保 (衛星電話設備/携行型有線通話装置) ▶ 十分な照度の確保 (可搬型照明 (SA)) ▶ 天井高を高く設定することで、室内空間を広くする ▶ 鉛ガラスの窓の設置 <p>これに加えて、更なる居住性向上のため、中央制御室待避室の床面積を必要寸法における床面積の2倍に拡大する。</p> <p style="text-align: right;">: SA範囲</p>	<p>(2) 中央制御室待避室内の必要スペースの考え方</p> <p>中央制御室待避室内で行う作業は、<u>プラントパラメータ監視装置 (中央制御室待避室)</u> によるプラントパラメータの監視、<u>衛星電話設備 (固定型)</u> 又は<u>無線通信設備 (固定型)</u> による通信連絡のみであり、広い作業スペースは不要であることから、以下の条件を考慮して中央制御室待避室の必要寸法を検討する。</p> <ul style="list-style-type: none"> ▶ 運転員 <u>5名</u> が着席して待機するために必要なスペース ▶ <u>プラントパラメータ監視装置 (中央制御室待避室)</u>、<u>LED照明 (ランタンタイプ)</u>、<u>酸素濃度計</u>、<u>二酸化炭素濃度計</u>及び<u>有線式通信設備の専用接続端子</u>を配置するためのスペース ▶ 待避室内圧力調整用の配管・バルブの設置及び操作スペース <p>運転員が椅子に座った姿勢で待機するために必要なスペースを1名当たり 500mm×1,200mm とすると、中央制御室待避室の必要寸法は <u>3,000mm×1,200mm</u> となる。</p> <p>(3) 中央制御室待避室の居住性向上</p> <p>中央制御室待避室の必要寸法として <u>3,000mm×1,200mm</u> を設定するが、中央制御室待避室の居住性を向上させるため、以下を実施する。</p> <ul style="list-style-type: none"> ▶ 外部との通信手段の確保 (衛星電話設備 (固定型) /無線通信設備 (固定型) /有線式通信設備) ▶ 十分な照度の確保 (LED照明 (ランタンタイプ)) ▶ 天井高を高く設定することで、室内空間を広くする (2,000mm) <p>これに加えて、更なる居住性向上のため、中央制御室待避室の床面積を必要寸法における床面積の2倍以上に拡大する。</p> <p style="text-align: right;">: SA範囲</p>	<p>・待避人員数の相違</p> <p>【東海第二】</p> <p>島根2号炉では、当直長、当直副長、中央制御室運転員各1名の他、フィルタベント操作を現場で行った場合の現場運転員2名の計5名を収容できる設計とする。</p> <p>・設備の相違</p> <p>【東海第二】</p> <p>収容人員数の相違による寸法の相違</p>

(4) 中央制御室待避室のレイアウト

これまでの検討結果を反映した中央制御室待避室のレイアウト図を第 3.6-1 図に示す。中央制御室待避室は、必要十分なスペースを確保する設計とする。

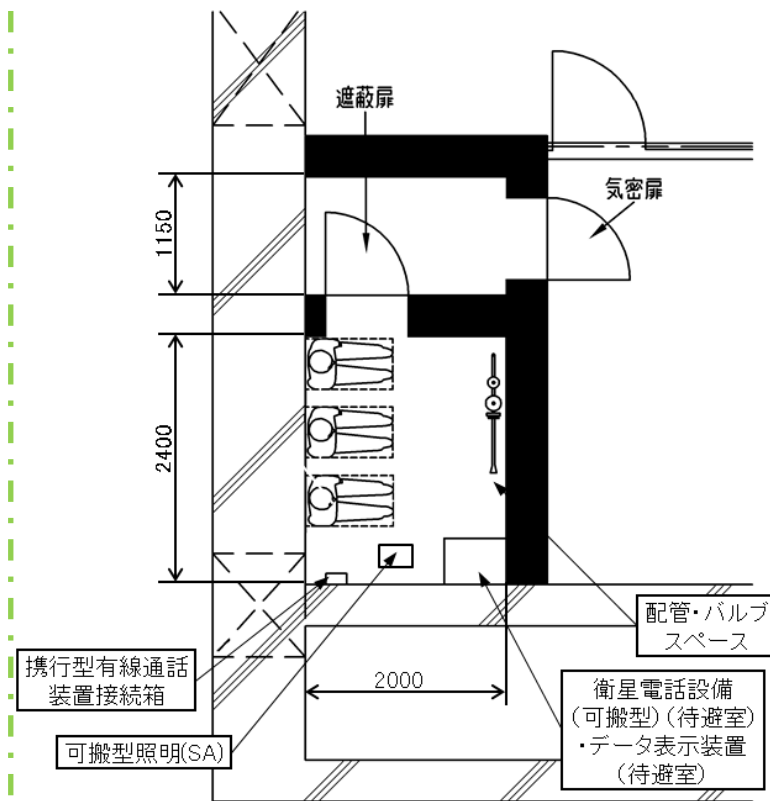

第 3.6-1 図 中央制御室待避室レイアウト図

 : SA範囲

(4) 中央制御室待避室のレイアウト

これまでの検討結果を反映した中央制御室待避室のレイアウト図は図 2.4-15 に示している。また、中央制御室待避室の寸法は、6,000mm×2,000mm と必要十分なスペースを確保する設計とする。

 : SA範囲

表 3.6-3 6号炉原子炉格納容器ベントによる影響 (1/5)

6号炉 事故シナシ	7号炉 事故シナシ	6号炉原子炉格納容器ベント操作時の7号炉側作業への影響	
大 LOCA	高圧・低圧注水 機能喪失	【7号炉運転員への影響】 原子炉水位を低圧代替注水系（常設）により維持しているため原子炉注入弁の操作が必要になるが、待避室への待避前に原子炉注水量を調整することにより中央制御室での操作頻度を少なくすることができる 【緊急時対策要員への影響】 復水貯蔵槽への補給を実施しているが、既に通常水位まで回復していることから、6号炉原子炉格納容器ベント前に補給を停止して待避することが可能 フィルタ装置水位調整等については、6号炉原子炉格納容器ベント前に水位調整を実施することで対応可能。また、炉心損傷前の原子炉格納容器ベントであるため、耐圧強化ベントに切り替えることも可能	影響なし
	高圧注水・減圧 機能喪失	【7号炉運転員への影響】 残留熱除去系による原子炉停止時冷却モードを実施しているため、流量調整は不要であり、6号炉の原子炉格納容器ベントによる影響はない 【緊急時対策要員への影響】 緊急時対策要員を必要としないシナリオであるため影響はない	影響なし
	全交流動力電源 喪失	【7号炉運転員への影響】 原子炉水位を低圧代替注水系（常設）により維持しており、残留熱除去系による格納容器スプレイを実施しているため、原子炉注入弁及び格納容器スプレイ弁の操作が必要になる。残留熱除去系による循環冷却を実施することにより中央制御室での操作頻度を少なくすることができる 【緊急時対策要員への影響】 復水貯蔵槽への補給を実施しているが、既に通常水位まで回復していることから、6号炉原子炉格納容器ベント前に補給を停止して待避することが可能 代替原子炉補機冷却系運転のために、電源車等への給油を行うが、要員の交替又は運転が期待できるタービン建屋大物搬入口に配置する等の被ばく低減対応が可能。また、残留熱除去系を停止して、再度原子炉格納容器ベントによる格納容器除熱を実施することも可能	影響なし

表 3.6-3 6号炉原子炉格納容器ベントによる影響 (2/5)

6号炉 事故シナシ	7号炉 事故シナシ	6号炉原子炉格納容器ベント操作時の7号炉側作業への影響	
大 LOCA	蒸気熱除去 機能喪失 (取水機能喪失)	【7号炉運転員への影響】 原子炉水位を低圧代替注水系（常設）により維持しているため原子炉注入弁の操作が必要になるが、待避室への待避前に原子炉注水量を調整することにより中央制御室での操作頻度を少なくすることができる 【緊急時対策要員への影響】 復水貯蔵槽への補給を実施しているが、既に通常水位まで回復していることから、6号炉原子炉格納容器ベント前に補給を停止して待避することが可能 代替原子炉補機冷却系運転のために、電源車等への給油を行うが、要員の交替又は運転が期待できるタービン建屋大物搬入口に配置する等の被ばく低減対応が可能。また、残留熱除去系を停止して、再度原子炉格納容器ベントによる格納容器除熱を実施することも可能	影響なし
	蒸気熱除去 機能喪失 (残留熱除去系 機能喪失)	【7号炉運転員への影響】 原子炉水位を高圧炉心注水系により維持しているため原子炉注入弁の操作が必要になるが、低圧代替注水系（常設）に切り替えることにより中央制御室での操作頻度を少なくすることができる 【緊急時対策要員への影響】 復水貯蔵槽への補給を実施しているが、既に通常水位まで回復していることから、6号炉原子炉格納容器ベント前に補給を停止して待避することが可能 フィルタ装置水位調整等については、6号炉原子炉格納容器ベント前に水位調整を実施することで対応可能。また、炉心損傷前の原子炉格納容器ベントであるため、耐圧強化ベントに切り替えることも可能	影響なし
	原子炉停止 機能喪失	【7号炉運転員への影響】 原子炉水位を高圧炉心注水系により維持しているため原子炉注入弁の操作が必要になるが、残留熱除去系による原子炉停止時冷却モードに切り替えることにより中央制御室での操作頻度を少なくすることができる 【緊急時対策要員への影響】 緊急時対策要員を必要としないシナリオであるため影響はない	影響なし

表 3.6-3 6号炉原子炉格納容器ベントによる影響 (3/5)

6号炉 事故シナシ	7号炉 事故シナシ	6号炉原子炉格納容器ベント操作時の7号炉側作業への影響	
大 LOCA	LOCA 時注水機能喪失	【7号炉運転員への影響】 原子炉水位を低圧代替注水系（常設）により維持しているため原子炉注入弁の操作が必要になるが、待避室への待避前に原子炉注水量を調整することにより中央制御室での操作頻度を少なくすることができる 【緊急時対策要員への影響】 復水貯蔵槽への補給を実施しているが、既に通常水位まで回復していることから、6号炉原子炉格納容器ベント前に補給を停止して待避することが可能 フィルタ装置水位調整等については、6号炉原子炉格納容器ベント前に水位調整を実施することで対応可能。また、炉心損傷前の原子炉格納容器ベントであるため、耐圧強化ベントに切り替えることも可能	影響なし
	格納容器バイパス (イナ-フォイア LOCA)	【7号炉運転員への影響】 原子炉水位を高圧炉心注水系により維持しているため原子炉注入弁の操作が必要になるが、残留熱除去系による原子炉停止時冷却モードに切り替えることにより中央制御室での操作頻度を少なくすることができる 【緊急時対策要員への影響】 緊急時対策要員を必要としないシナリオであるため影響はない	影響なし
	大 LOCA (代替循環冷却を使用 する場合)	【7号炉運転員への影響】 代替循環冷却により原子炉および格納容器の除熱を実施しており中央制御室での操作は不要 【緊急時対策要員への影響】 代替原子炉補機冷却系運転のために、電源車等への給油を行うが、要員の交替又は運転が期待できるタービン建屋大物搬入口に配置する等の被ばく低減対応が可能。	影響なし

： SA 範囲

・申請号炉数の相違
【柏崎 6/7】

・申請号炉数の相違
【柏崎 6/7】

・申請号炉数の相違
【柏崎 6/7】

表 3.6-3 6号炉原子炉格納容器ベントによる影響 (4/5)

6号炉 事故シナリオ	7号炉 事故シナリオ	6号炉原子炉格納容器ベント操作時の7号炉側作業への影響	
大 LOCA	想定事故 1	<p>【7号炉運転員への影響】 使用済燃料プールへの可搬型注水ポンプによる蒸発量に応じた注水により使用済燃料プール水位を維持しているが、通常水位まで回復することにより6号炉原子炉格納容器ベント前に補給を停止して待避することが可能</p> <p>【緊急時対策要員への影響】 使用済燃料プールへの可搬型注水ポンプによる補給を実施しているが、通常水位まで回復することにより6号炉原子炉格納容器ベント前に補給を停止して待避することが可能</p>	影響なし
	想定事故 2	<p>【7号炉運転員への影響】 使用済燃料プールへの可搬型注水ポンプによる蒸発量に応じた注水により使用済燃料プール水位を維持しているが、通常水位まで回復することにより6号炉原子炉格納容器ベント前に補給を停止して待避することが可能</p> <p>【緊急時対策要員への影響】 使用済燃料プールへの可搬型注水ポンプによる補給を実施しているが、通常水位まで回復することにより6号炉原子炉格納容器ベント前に補給を停止して待避することが可能</p>	影響なし
	停止中残熱除去機能喪失	<p>【7号炉運転員への影響】 残熱除去系による原子炉停止時冷却モードを実施しているため、流量調整は不要であり、6号炉の原子炉格納容器ベントによる影響はない</p> <p>【緊急時対策要員への影響】 緊急時対策要員を必要としないシナリオであるため影響はない</p>	影響なし

表 3.6-3 6号炉原子炉格納容器ベントによる影響 (5/5)

6号炉 事故シナリオ	7号炉 事故シナリオ	6号炉原子炉格納容器ベント操作時の7号炉側作業への影響	
大 LOCA	停止中全交流動力電源喪失	<p>【7号炉運転員への影響】 残熱除去系による原子炉停止時冷却モードを実施しているため、流量調整は不要であり、6号炉の原子炉格納容器ベントによる影響はない</p> <p>【緊急時対策要員への影響】 代替原子炉補機冷却系運転のために、電源車等への給油を行うが、要員の交替又は遮蔽が期待できるタービン建屋大物搬入口に配置する等の被ばく低減対応が可能。また、6号炉の原子炉格納容器ベント開始前に代替原子炉補機冷却および残熱除去系を停止して、再度過がし安全弁による原子炉減圧維持および復水格納ポンプによる低圧代替注水を実施することも可能</p>	影響なし
	停止中原子炉冷却材の流出	<p>【7号炉運転員への影響】 残熱除去系による原子炉停止時冷却モードを実施しているため、流量調整は不要であり、6号炉の原子炉格納容器ベントによる影響はない</p> <p>【緊急時対策要員への影響】 緊急時対策要員を必要としないシナリオであるため影響はない</p>	影響なし

・申請号炉数の相違
【柏崎 6/7】

・申請号炉数の相違
【柏崎 6/7】

: SA範囲

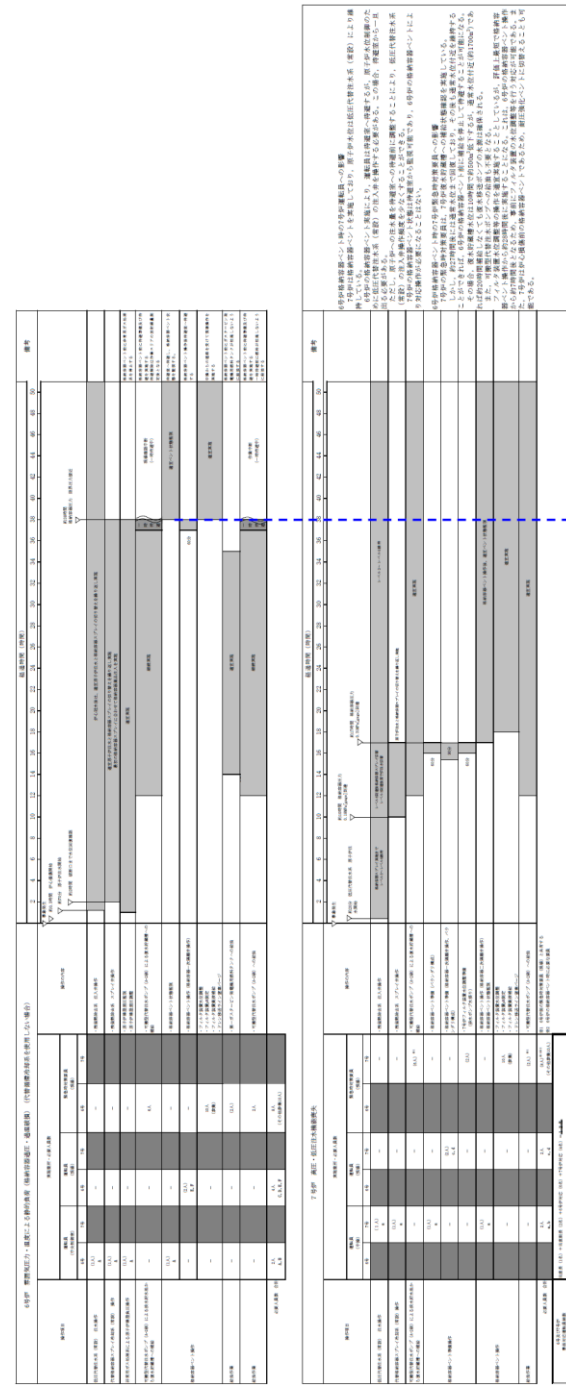

: SA範囲

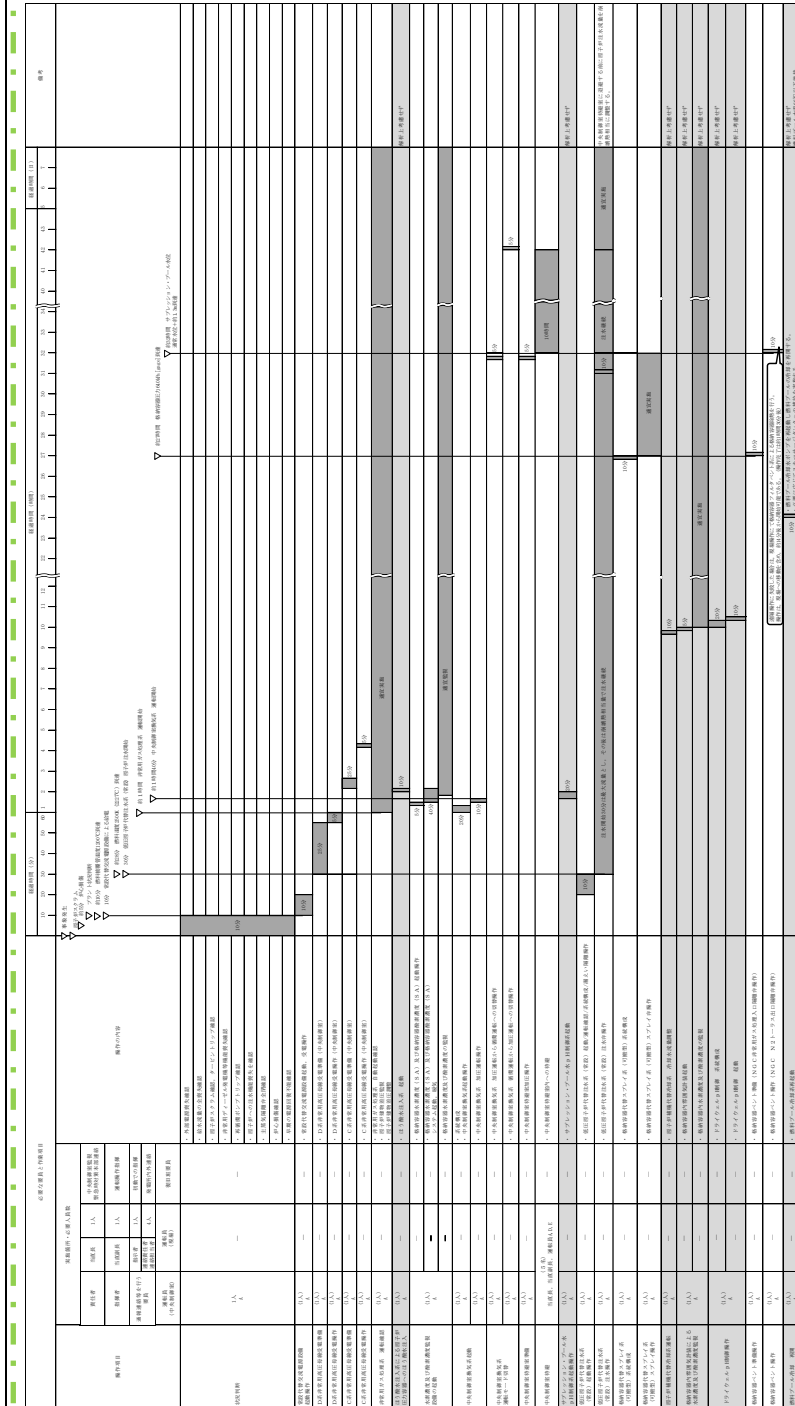

: SA範囲

・記載方針の相違
 【柏崎6/7, 東海第二】
 島根2号炉は中央制御室待避室を使用する事故シーケンスのタイムチャートを記載 (図 3.6-1 図 3.6-2)

・記載方針の相違
【柏崎6/7, 東海第二】
 島根2号炉は中央制御室待避室を使用する事故シーケンスのタイムチャートを記載(図3.6-1 図3.6-2)



図 3.6-2 「大LOCA+高圧・低圧注水機能喪失+全交流動力電源喪失」シーケンス (現場運転員)

： SA 範囲

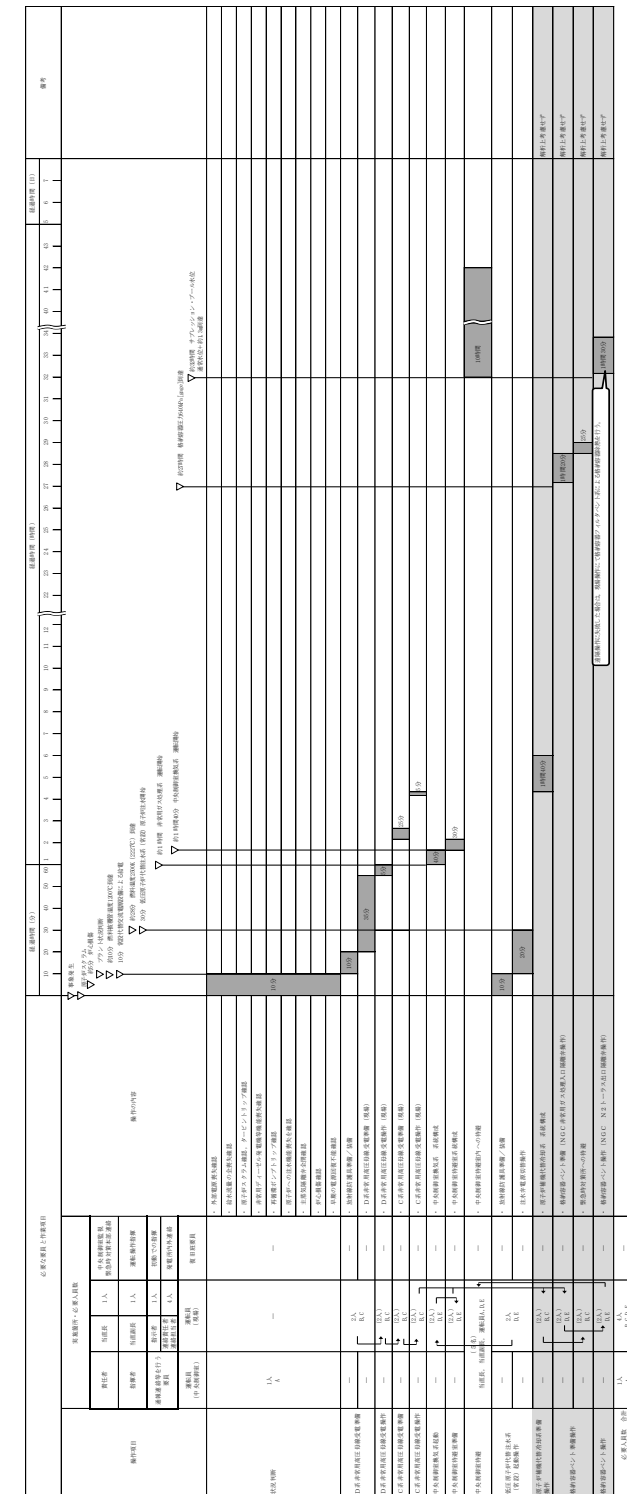
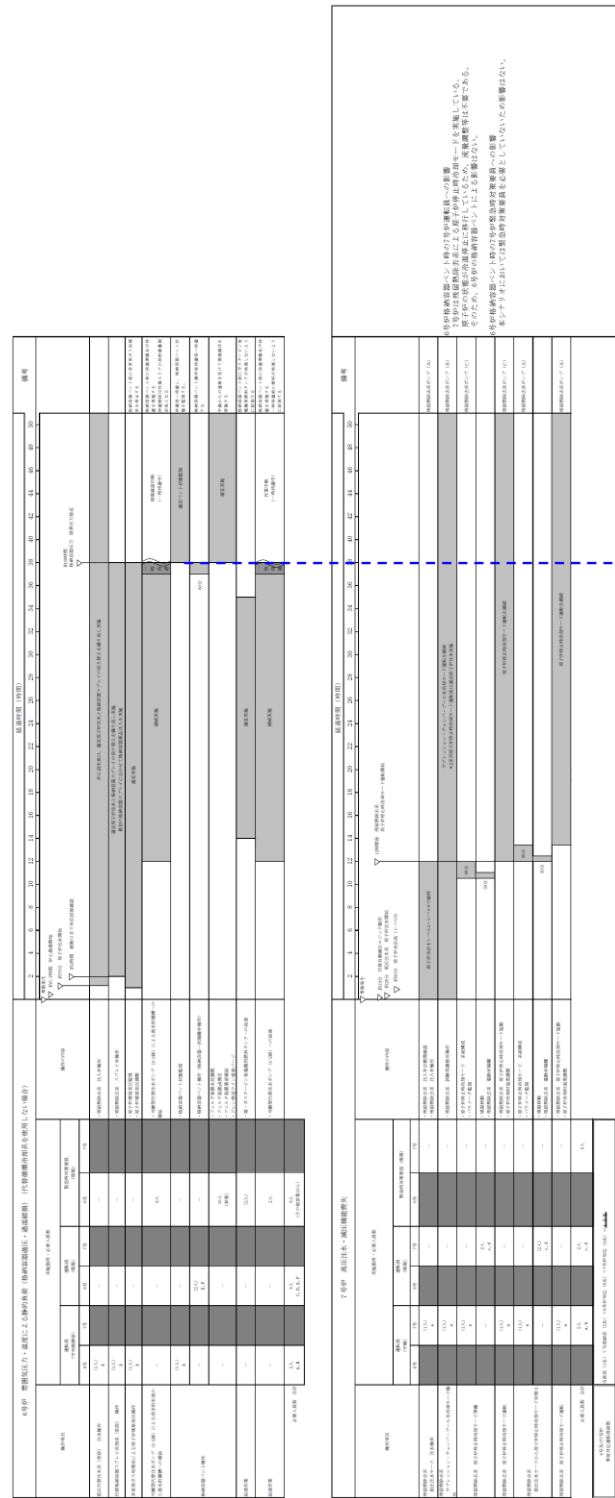

： SA範囲

・記載方針の相違
【柏崎6/7, 東海第二】
 島根2号炉は中央制御室待避室を使用する事故シーケンスのタイムチャートを記載(図3.6-1 図3.6-2)



図 3.6-3 大LOCA+全交流動力電源喪失

： SA範囲

・記載方針の相違
【柏崎 6/7, 東海第二】
 島根 2号炉は中央制御室待避室を使用する事故シーケンスのタイムチャートを記載 (図 3.6-1 図 3.6-2)

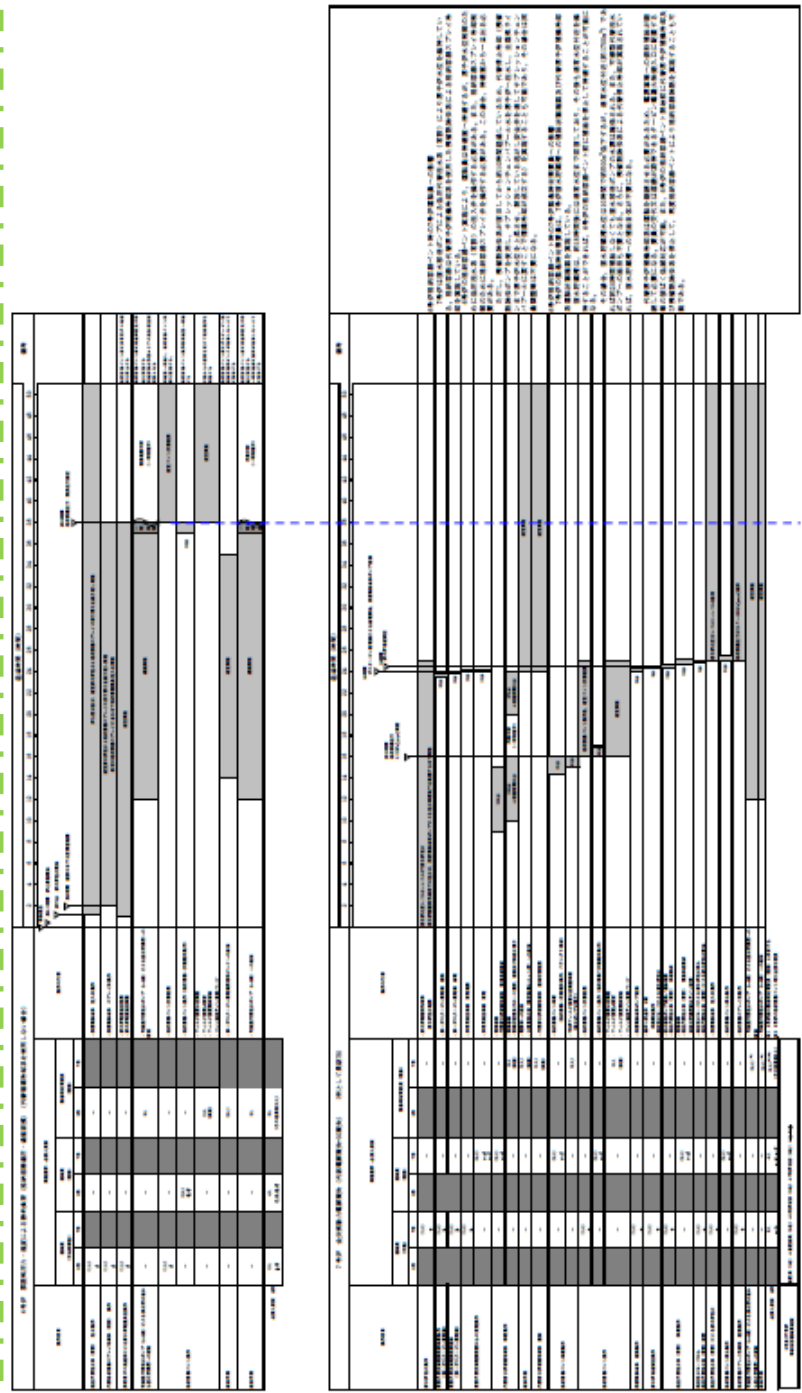

図 3.6-4 大OCA+崩壊熱除去機能喪失 (取水機能喪失)
: SA範囲

・記載方針の相違
【柏崎6/7, 東海第二】
島根2号炉は中央制御室待避室を使用する事故シーケンスのタイムチャートを記載 (図3.6-1 図3.6-2)

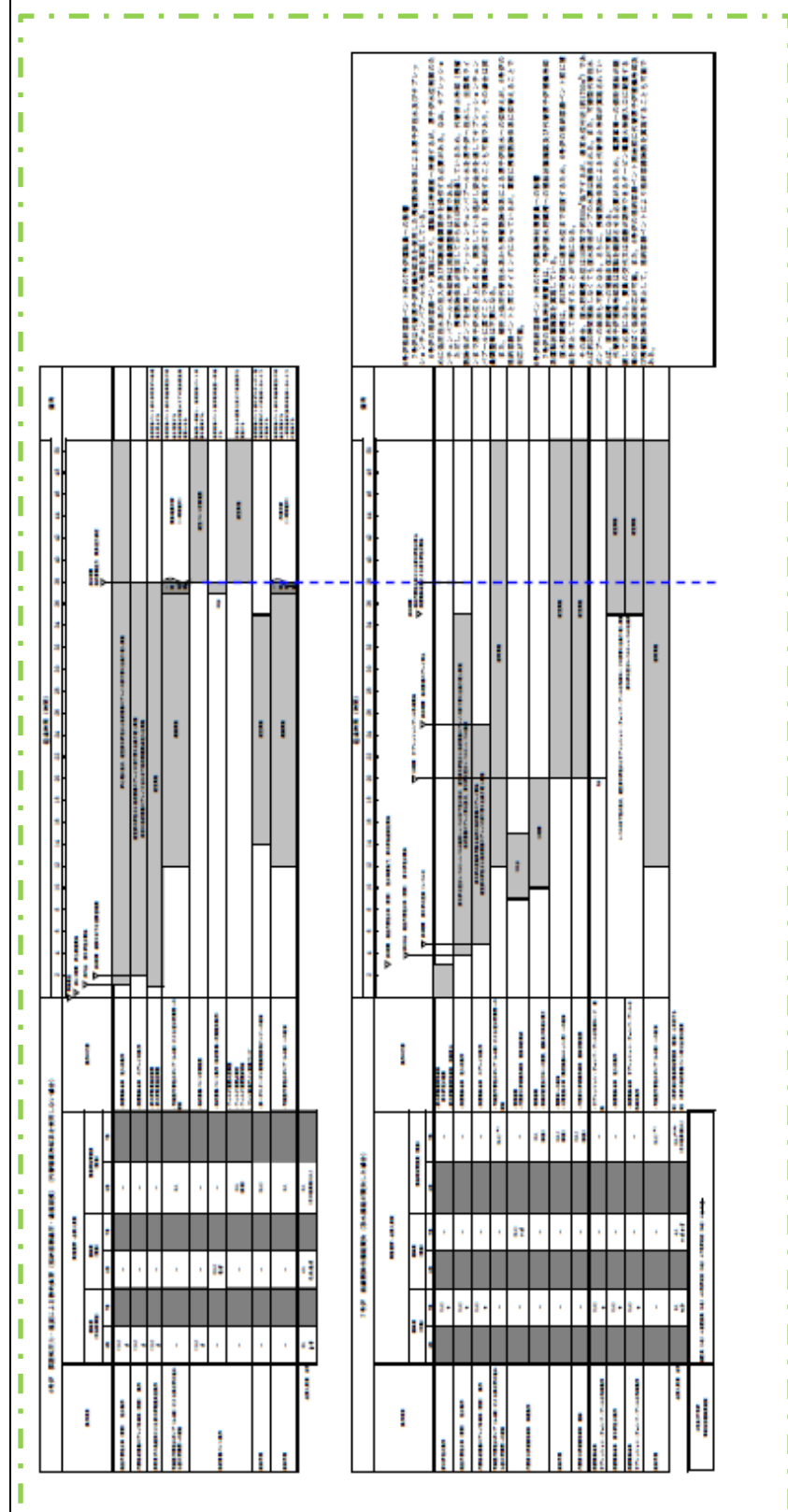

図 3.6-5 大LOCA+崩壊熱除去機能喪失 (残留熱除去系が故障した場合)

: SA範囲

・記載方針の相違
【柏崎 6/7, 東海第二】
 島根 2号炉は中央制御室待避室を使用する事故シーケンスのタイムチャートを記載 (図 3.6-1 図 3.6-2)

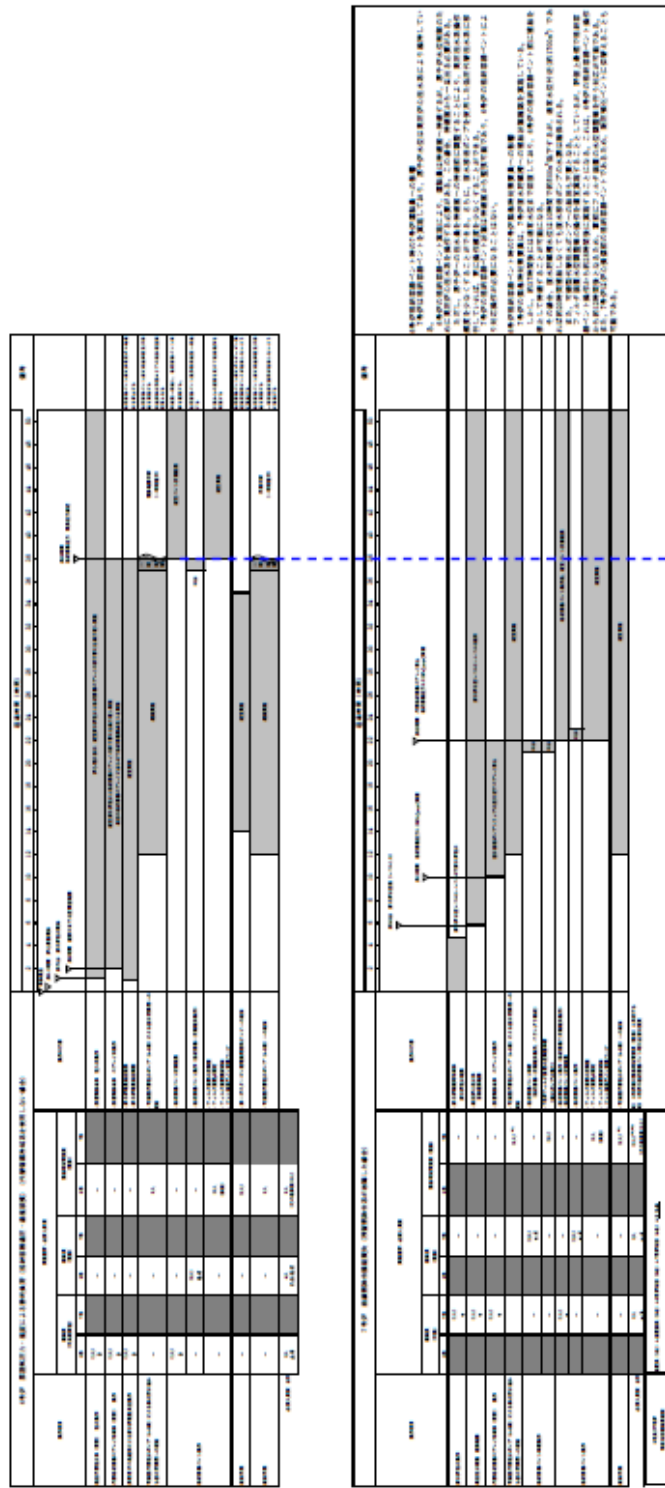

図 3.6-6 大LOCA+原子炉停止機能喪失

： SA範囲

・記載方針の相違
【柏崎 6/7, 東海第二】
 島根 2号炉は中央制御室待避室を使用する事故シーケンスのタイムチャートを記載 (図 3.6-1 図 3.6-2)

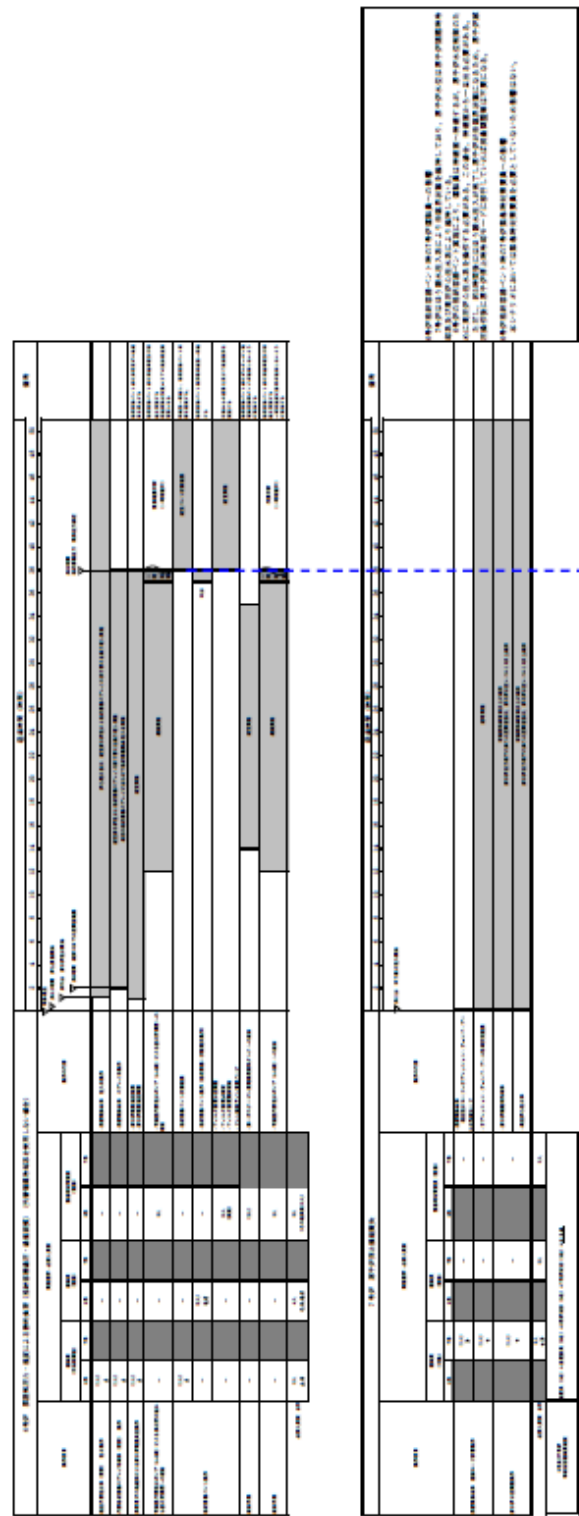

図 3.6-7 大LOCA+LOCA時注水機能喪失

: SA範囲

・記載方針の相違
【柏崎 6/7, 東海第二】
 島根 2号炉は中央制御室待避室を使用する事故シーケンスのタイムチャートを記載 (図 3.6-1 図 3.6-2)

柏崎刈羽原子力発電所 6 / 7号炉 (2017. 12. 20)

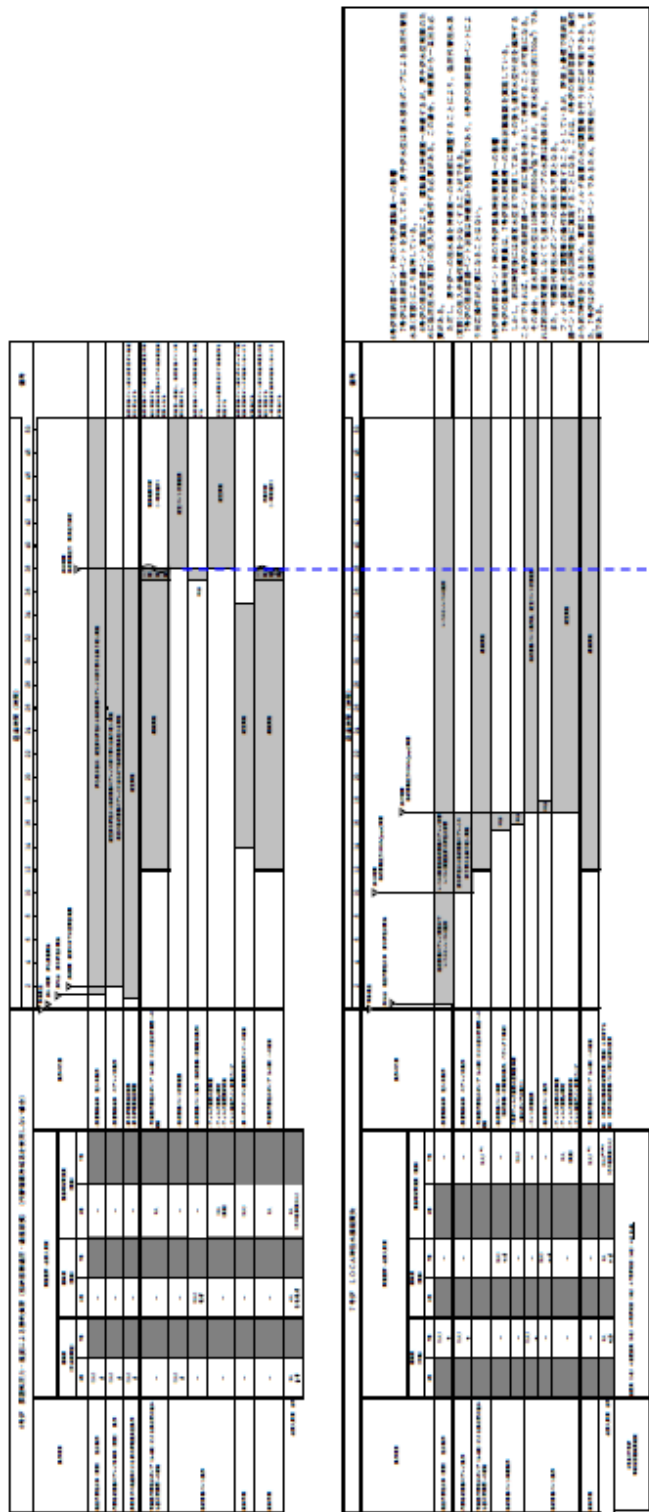
東海第二発電所 (2018. 9. 18 版)

島根原子力発電所 2号炉

備考



図 3.6-8 大LOCA+格納容器バイパス (インターフェイスシステムLOCA)

: SA範囲

・記載方針の相違
【柏崎 6/7, 東海第二】
 島根 2号炉は中央制御室待避室を使用する事故シーケンスのタイムチャートを記載 (図 3.6-1 図 3.6-2)

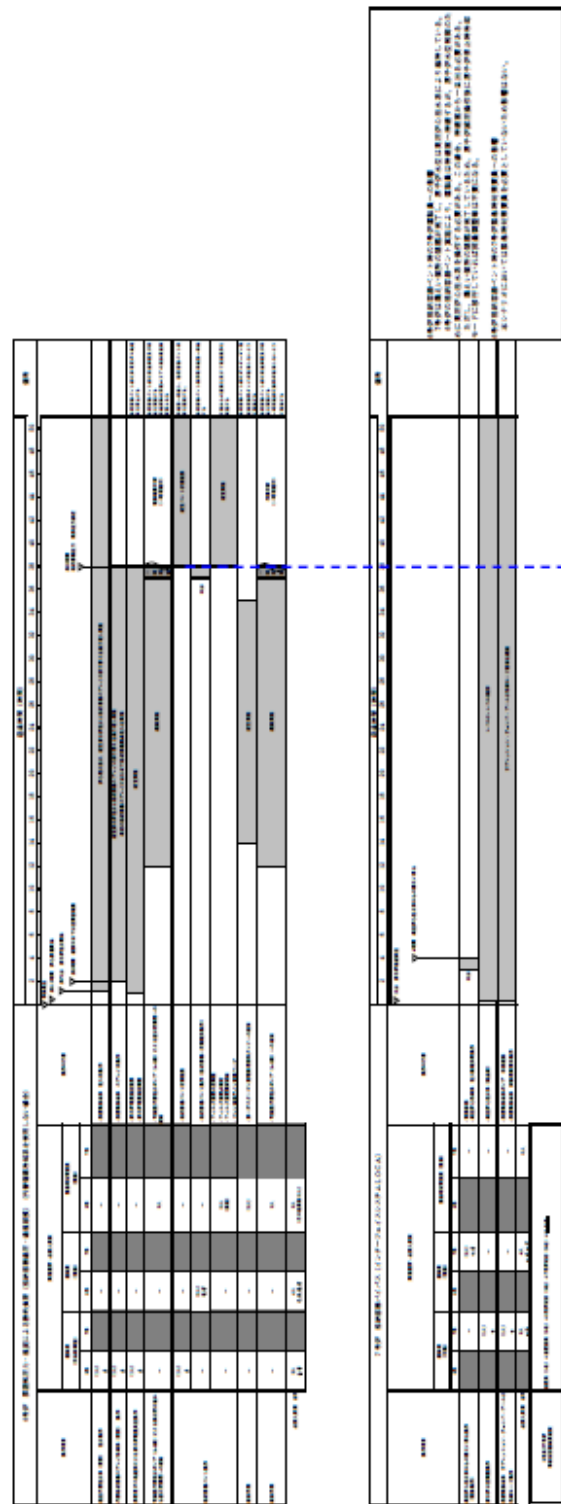

図 3.6-9 大LOCA+大LOCA (代替循環冷却を使用する場合)

: SA範囲

・記載方針の相違
【柏崎 6/7, 東海第二】
 島根 2 号炉は中央制御室待避室を使用する事故シーケンスのタイムチャートを記載 (図 3.6-1 図 3.6-2)

柏崎刈羽原子力発電所 6 / 7号炉 (2017. 12. 20)

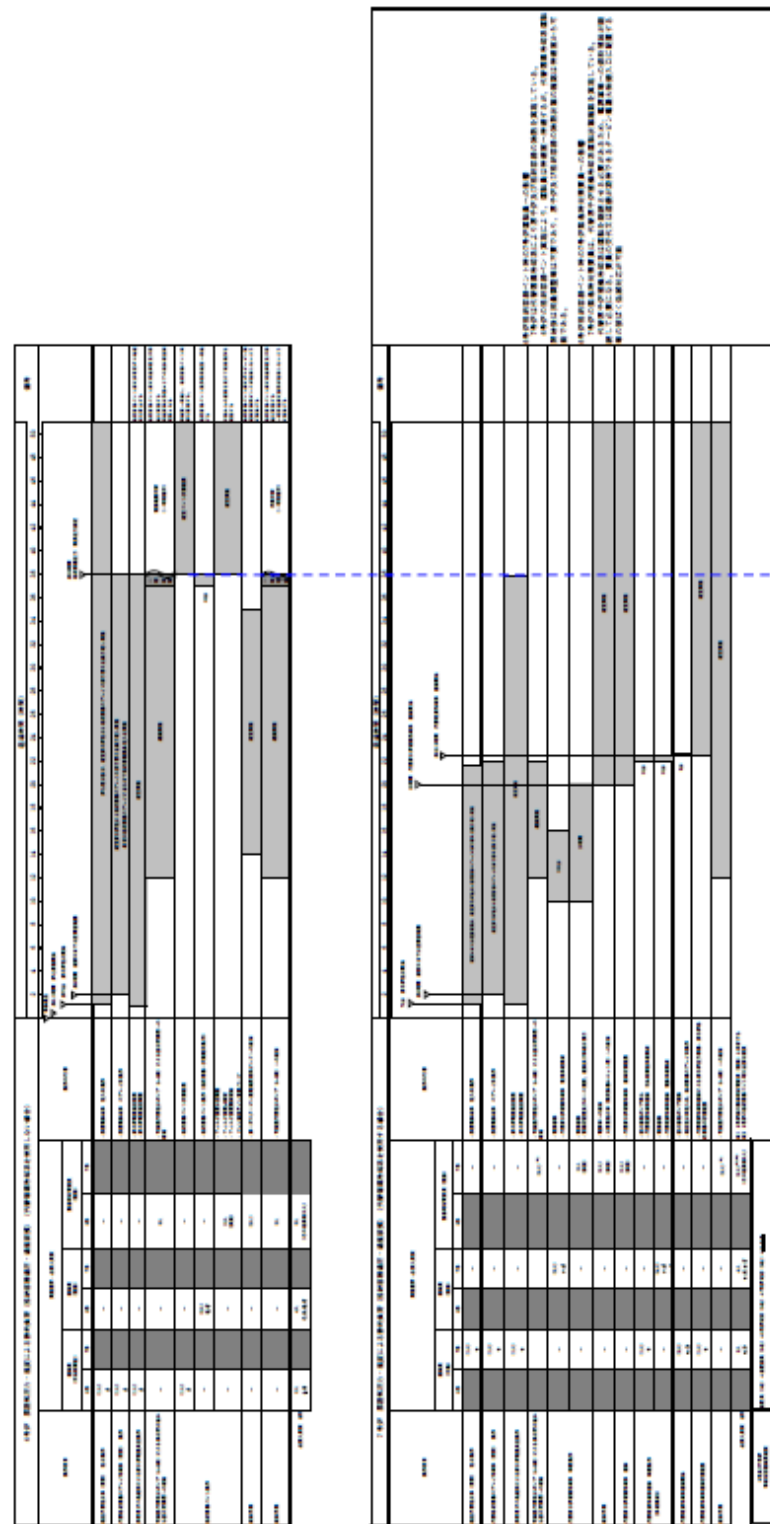
東海第二発電所 (2018. 9. 18 版)

島根原子力発電所 2号炉

備考

・記載方針の相違
【柏崎 6/7, 東海第二】
 島根 2号炉は中央制御室待避室を使用する事故シーケンスのタイムチャートを記載 (図 3.6-1 図 3.6-2)



図 3.6-10 大LOCA+想定事故1

: SA範囲

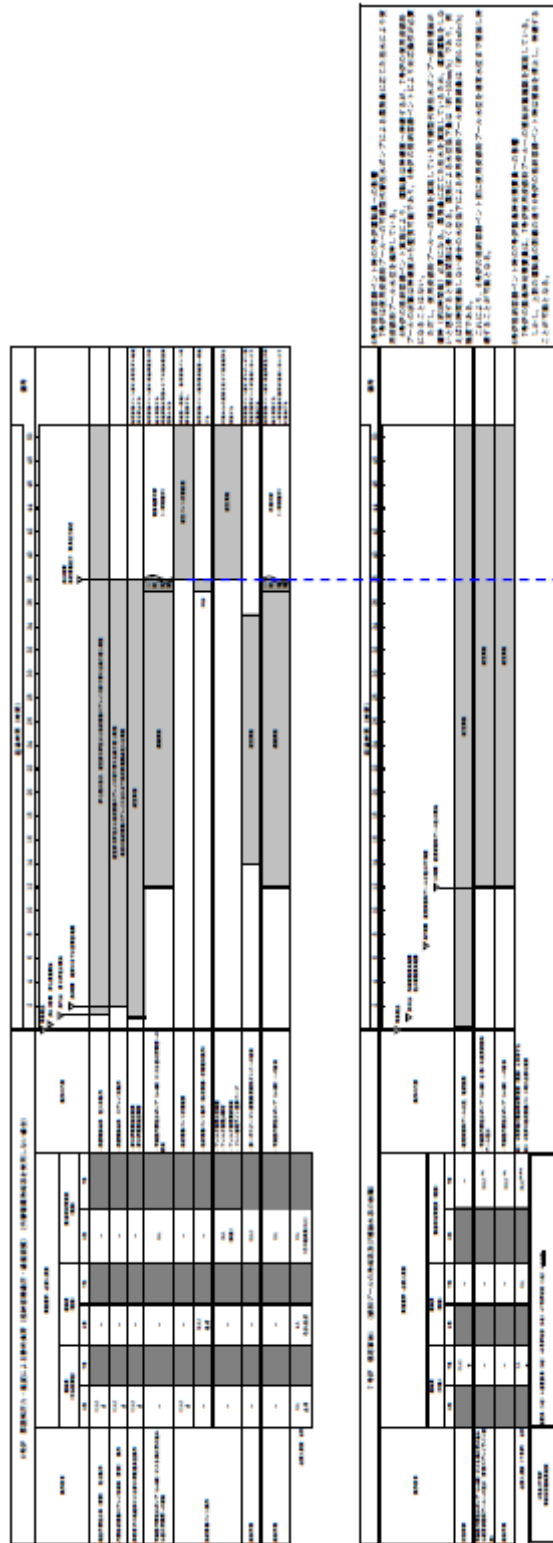

図 3.6-11 大LOCA+想定事故2

: SA範囲

・記載方針の相違
【柏崎 6/7, 東海第二】
 島根 2号炉は中央制御室待避室を使用する事故シーケンスのタイムチャートを記載 (図 3.6-1 図 3.6-2)

柏崎刈羽原子力発電所 6 / 7号炉 (2017.12.20)

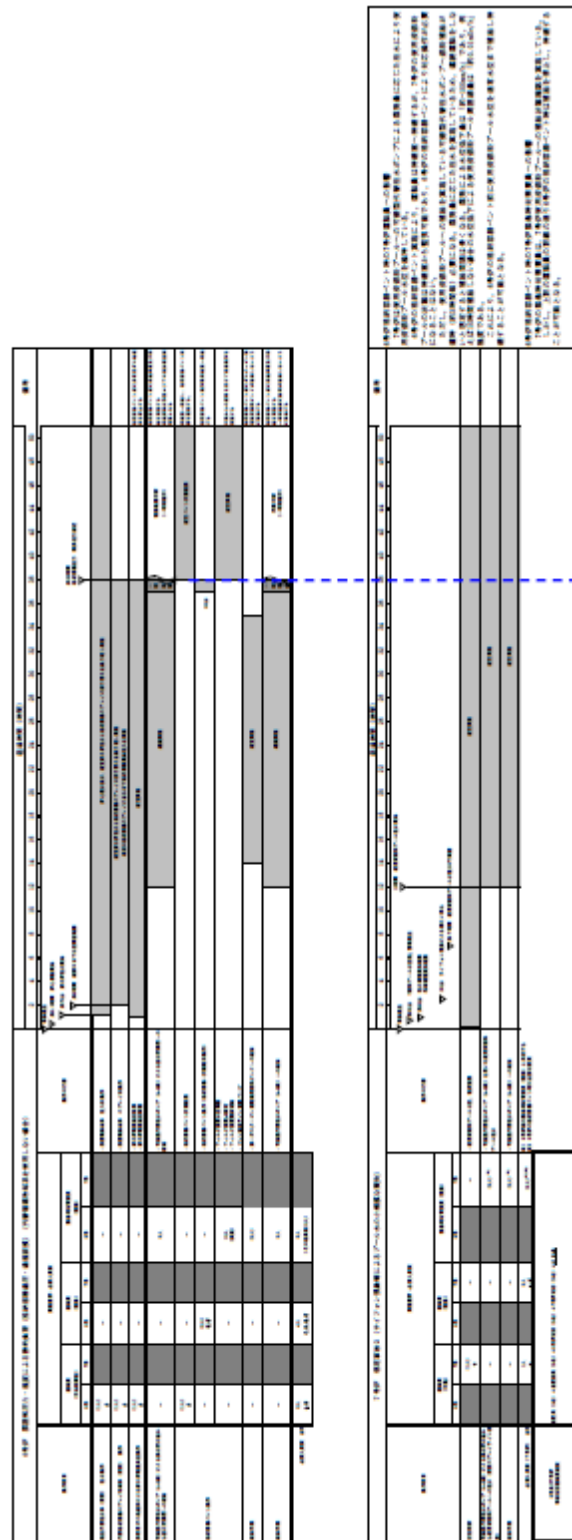
東海第二発電所 (2018.9.18版)

島根原子力発電所 2号炉

備考



図 3.6-12 大LOCA+停止中の崩壊熱除去機能喪失

: SA範囲

・記載方針の相違
【柏崎 6/7, 東海第二】
 島根 2号炉は中央制御室待避室を使用する事故シーケンスのタイムチャートを記載 (図 3.6-1 図 3.6-2)

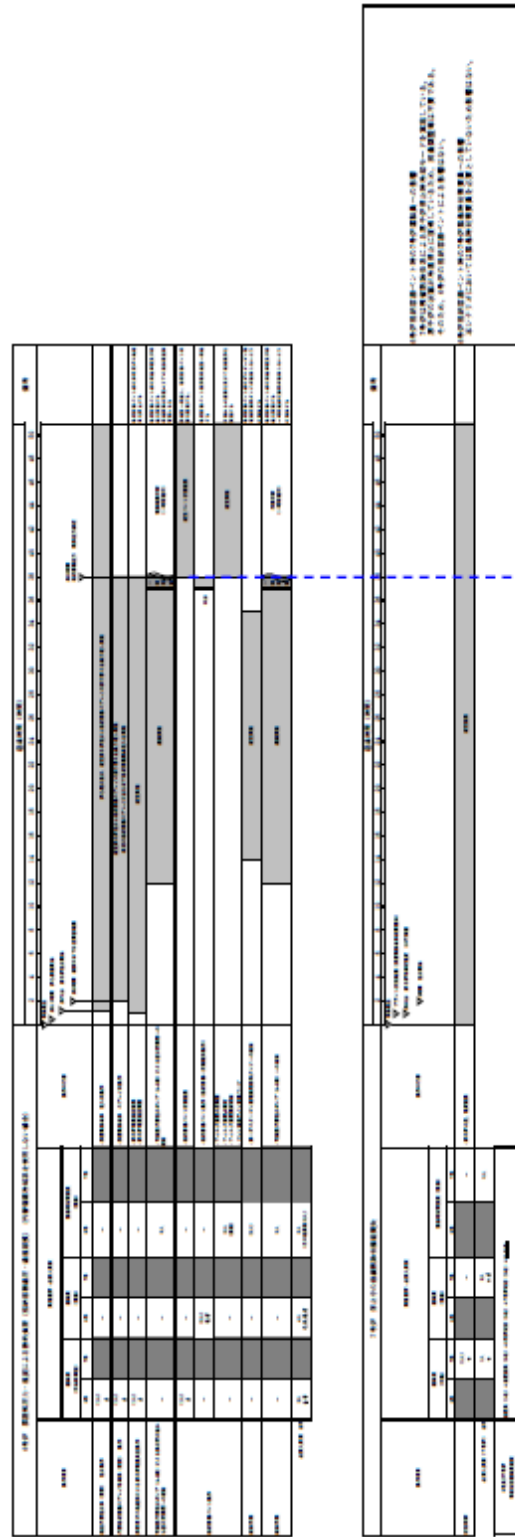

図 3.6-13 大LOCA+停止中の全交流動力電源喪失

: SA範囲

・記載方針の相違
【柏崎6/7, 東海第二】
 島根2号炉は中央制御室待避室を使用する事故シーケンスのタイムチャートを記載(図3.6-1 図3.6-2)

柏崎刈羽原子力発電所 6 / 7号炉 (2017.12.20)

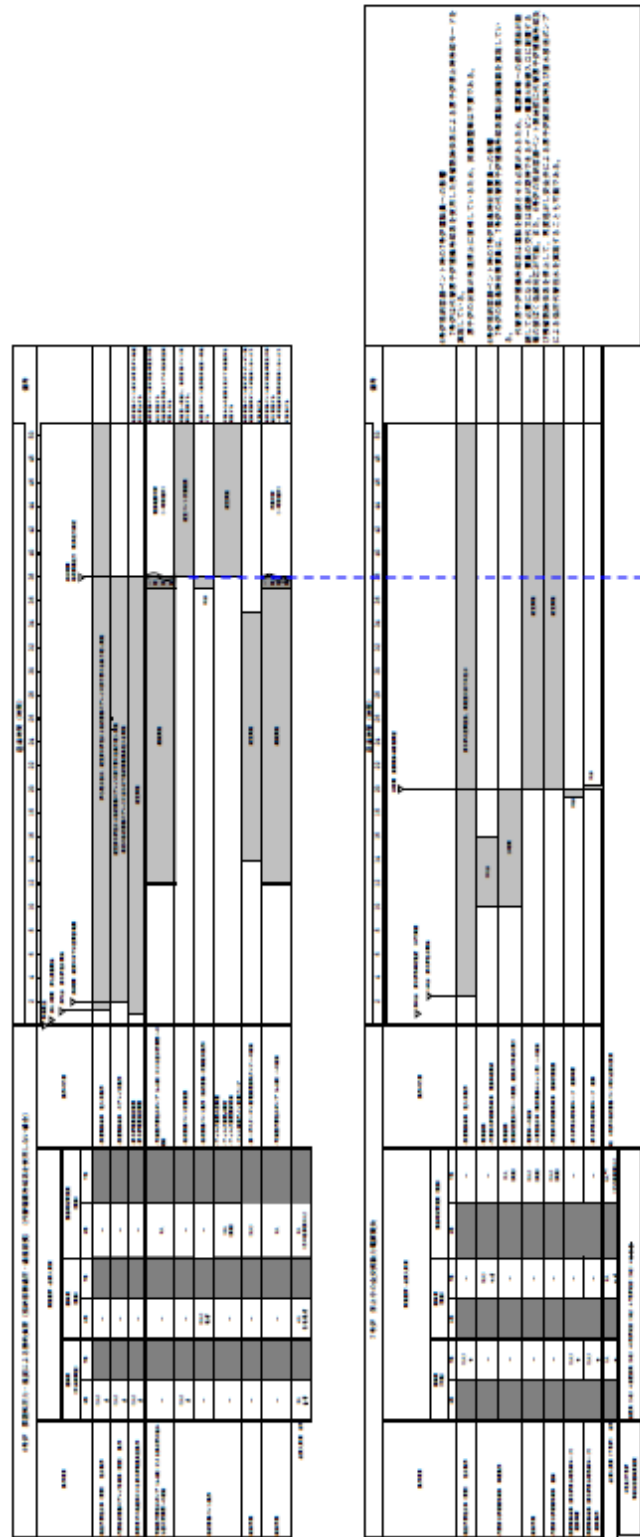
東海第二発電所 (2018.9.18版)

島根原子力発電所 2号炉

備考



図 3.6-14 大LOCA+停止中の原子炉冷却材の流出

: SA範囲

・記載方針の相違
【柏崎 6/7, 東海第二】
 島根 2号炉は中央制御室待避室を使用する事故シーケンスのタイムチャートを記載 (図 3.6-1 図 3.6-2)

柏崎刈羽原子力発電所 6/7号炉 (2017.12.20)	東海第二発電所 (2018.9.18版)	島根原子力発電所 2号炉	備考
<p>3.7 申請前号炉の中央制御室の居住性評価について</p> <p>柏崎刈羽原子力発電所6号及び7号炉において炉心の著しい損傷が発生した場合における申請前号炉(1~5号炉)の中央制御室の居住性評価について以下に示す。なお、6号及び7号炉で炉心の著しい損傷が発生した場合において、5号炉の運転員は自号炉の中央制御室から5号炉原子炉建屋内緊急時対策所に移動し5号炉の監視業務等を行う設計としていることから、5号炉に関しては中央制御室を居住性評価の対象とせず、5号炉原子炉建屋内緊急時対策所の居住性について検討を行った。</p> <p>居住性評価に当たっては、「実用発電用原子炉に係る重大事故時の制御室及び緊急時対策所の居住性に係る被ばく評価に関する審査ガイド」(以下「審査ガイド」という。)を参照した。</p> <p>図3.7-1に柏崎刈羽原子力発電所1~7号炉中央制御室の配置図を示す。</p>  <p>図 3.7-1 柏崎刈羽原子力発電所 1~7号炉中央制御室 配置図</p> <p>(1) 居住性評価の前提条件</p> <p>想定事象は、6号及び7号炉中央制御室の居住性(炉心の著しい損傷)に係る被ばく評価と同様に以下のとおりとした。</p> <p>-6号又は7号炉のいずれかが「大破断LOCA時に非常用炉心冷却系の機能及び全交流動力電源が喪失するシーケンス」で、格納容器圧力逃がし装置を用いた格納容器ベントを実施する。</p> <p>-6号又は7号炉の残る1つが「大破断LOCA時に非常用炉心冷却系の機能及び全交流動力電源が喪失するシーケンス」で、代替循環冷却系により事象を収束する。</p> <p style="text-align: right;">: SA範囲</p>		<p>3.7 申請前号炉の中央制御室の居住性評価について</p> <p>島根原子力発電所2号炉において、炉心の著しい損傷が発生した場合の格納容器ベント実施時における運転終了号炉(1号炉)の運転員は、自号炉の中央制御室から緊急時対策所に移動し1号炉の監視業務等を行う設計としていることから、1号炉に関しては、2号炉の運転員の被ばく評価結果(補足説明資料 59-11 参照)に包絡されるため、申請前号炉の中央制御室の居住性評価の対象外とした。</p> <p style="text-align: right;">: SA範囲</p>	<p>備考</p> <p>・申請号炉数及び申請前号炉の運用の相違【柏崎 6/7】</p>

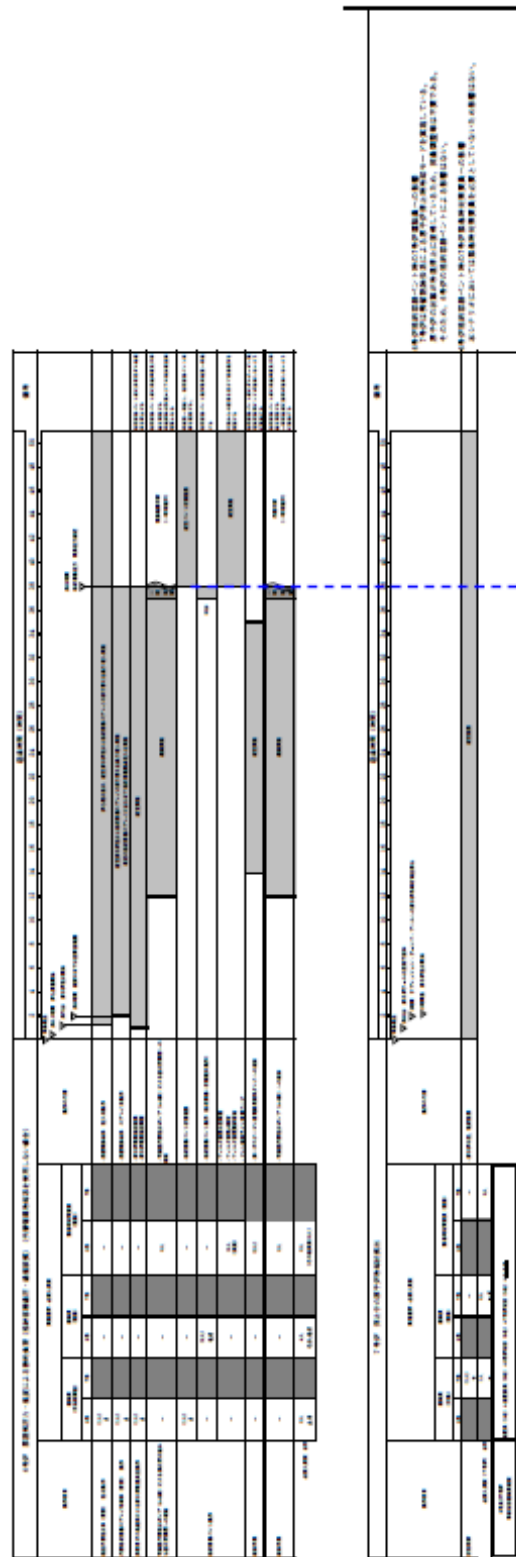
柏崎刈羽原子力発電所 6/7号炉 (2017.12.20)	東海第二発電所 (2018.9.18版)	島根原子力発電所 2号炉	備考
<p><u>居住性評価においては、6号及び7号炉のうち1～4号炉の中央制御室により近接している7号炉において、格納容器ベントを実施することを想定した。また、5号炉の中央制御室の運転員は5号炉原子炉建屋内緊急時対策所に待避することを前提に、上述の想定事象における5号炉原子炉建屋内緊急時対策所の居住性を検討対象とした。</u></p> <p><u>なお、被ばく評価に用いる大気中への放出放射線エネルギー及び放射性物質の大気拡散の評価は、補足説明資料59-11「原子炉制御室の居住性に係る被ばく評価について2.中央制御室の居住性（炉心の著しい損傷）に係る被ばく評価について」で示す方法と同様の方法にて実施した。</u></p> <p><u>(2) 1～4号炉中央制御室の居住性について</u></p> <p><u>1～4号炉の中央制御室における居住性評価の評価結果を表3.7-1に示す。1～4号炉の運転員は、各号炉の中央制御室内にとどまることとする。また中央制御室内ではマスクを着用するものとし、着用時間は1時間当たり0.9時間と想定した。さらに運転員の交替は考慮しないものとして、評価を行った。</u></p> <p><u>評価の結果、最も被ばく量が大きくなるのは4号炉中央制御室の運転員であり、約54mSv/7日間となる。</u></p> <p><u>なお、1～4号炉の中央制御室に対しては、6号及び7号炉で炉心の著しい損傷が発生した場合においても自号炉にとどまることができるよう、以下の放射線防護資機材を配備する設計とする。</u></p> <p>○ <u>放射線防護資機材等の配備</u></p> <ul style="list-style-type: none"> ・ <u>チェン징グエリアの設置、マスク着脱時等に使用するクリーンエリアの設置、マスク・着替え等放射線防護資機材の配備、水・食料の配備</u> ・ <u>酸素濃度計、二酸化炭素濃度計、可搬型エリアモニタ、可搬型照明の配備</u> <p style="text-align: right;">: SA範囲</p>			<p>備考</p> <p>・申請前号炉の運用の相違【柏崎6/7】</p>

表3.7-1 1~4号炉中央制御室の居住性に係る被ばく評価結果※1
 (7号炉格納容器ベント実施時) (運転員の交替を考慮しない場合)

被ばく経路	実効線量 (mSv/7日間) 6号及び7号炉からの寄与の合計			
	1号炉	2号炉	3号炉	4号炉
① 原子炉建屋内の放射線による中央制御室内での外部被ばく	0.1以下	0.1以下	0.1以下	0.1以下
② 放射性雲中の放射線による中央制御室内での外部被ばく	約 1.0×10^{-1}	約 1.2×10^{-1}	約 9.9×10^{-1}	約 1.2×10^0
③ 外気から取り込まれた放射性物質による中央制御室内での被ばく※2	約 2.5×10^1	約 3.1×10^1	約 3.8×10^1	約 5.2×10^1
(内訳) 内部被ばく※3	約 2.1×10^1	約 2.5×10^1	約 3.1×10^1	約 4.3×10^1
外部被ばく	約 4.2×10^0	約 5.8×10^0	約 6.9×10^0	約 9.2×10^0
④ 大気中に放出され地表面に沈着した放射性物質からの放射線による中央制御室内での外部被ばく	0.1以下	0.1以下	0.1以下	0.1以下
実効線量 (=①+②+③+④)	約26	約31	約39	約54

※1 評価手法は「補足資料59-1 原子炉制御室の居住性に係る被ばく評価について2. 中央制御室の居住性(炉心の著しい損傷)に係る被ばく評価について」で示す方法と同様の方法にて実施
 ※2 中央制御室換気空調系は空調機停止及び隔離弁閉止し、外気が0.5回/hで中央制御室内に流入するものと仮定
 ※3 マスクの防護係数としてPF50、着用時間は1時間当たり0.9時間と想定

： SA範囲

・申請前号炉の運用の相違【柏崎 6/7】

柏崎刈羽原子力発電所 6/7号炉 (2017.12.20)	東海第二発電所 (2018.9.18版)	島根原子力発電所 2号炉	備考
<p>(3) <u>5号炉中央制御室の居住性について</u></p> <p><u>5号炉中央制御室は図3.7-1に示すとおり、6号及び7号炉に近接しているため6号及び7号炉の発災時に環境の悪化の影響を受けやすい。このため、6号及び7号炉で炉心の著しい損傷が発生した場合においては、5号炉の運転員は中央制御室から5号炉原子炉建屋内緊急時対策所に待避する設計としている。</u></p> <p><u>5号炉原子炉建屋内緊急時対策所の居住性設備は、6号及び7号炉中央制御室^{※1}の遮蔽設備及び空調設備と同等以上の性能を有する設計とし、福島第一原子力発電所事故と同等の事象の発生を想定した場合においても、必要な居住性が確保される設計としている。^{※2}</u></p> <p><u>そのため、前述(1)の想定事象が発生した場合においても、5号炉中央制御室の運転員が滞在する5号炉原子炉建屋内緊急時対策所の居住性は確保される設計とする。</u></p> <p>※1 「<u>補足説明資料59-11 原子炉制御室の居住性に係る被ばく評価について</u>」において、6号及び7号炉中央制御室の居住性が審査ガイドの判断基準である「<u>運転員の実効線量が7日間で100mSvを超えないこと</u>」を満足することを確認している</p> <p>※2 「<u>61条緊急時対策所の補足説明資料61-10 緊急時対策所の居住性に係る被ばく評価について</u>」を参照</p> <p>なお、5号炉原子炉建屋内緊急時対策所においては、5号炉運転員が業務を継続できるよう、プラント監視等のための設備を配置し、また1～4号炉同様、放射線防護資機材を配備する設計とする。</p> <p>○ <u>5号炉原子炉建屋内緊急時対策所にてプラント監視、通信連絡が実施できる設備の設置</u></p> <ul style="list-style-type: none"> ・<u>デジタル記録計等を用いたプラントパラメータの遠隔監視機器・手順整備</u> ・<u>現場との通信連絡設備配備</u> <p style="text-align: right;">: SA範囲</p>			<p>備考</p> <p>・申請前号炉の運用の相違【柏崎 6/7】</p>

柏崎刈羽原子力発電所 6 / 7号炉 (2017.12.20)	東海第二発電所 (2018.9.18版)	島根原子力発電所 2号炉	備考
<p>○ <u>放射線防護資機材等の配備</u></p> <ul style="list-style-type: none"> ・ <u>チェンジングエリアの設置, マスク着脱時等に使用するクリーンエリアの設置, マスク・着替え等放射線防護資機材の配備, 水・食料の配備</u> ・ <u>酸素濃度計, 二酸化炭素濃度計, 可搬型エリアモニタ, 可搬型照明の配備</u> <p>4. <u>まとめ</u></p> <p><u>以上より, 中央制御室の運転員の滞在場所 (1~4号炉中央制御室及び5号炉原子炉建屋内緊急時対策所) の設置や放射線防護資機材配備等により, 申請前各号炉においても, 6号及び7号炉で炉心の著しい損傷が発生した場合に必要な居住性 (7日間100mSvを超えない) が確保される設計であることを確認した。</u></p>			
 : SA範囲			

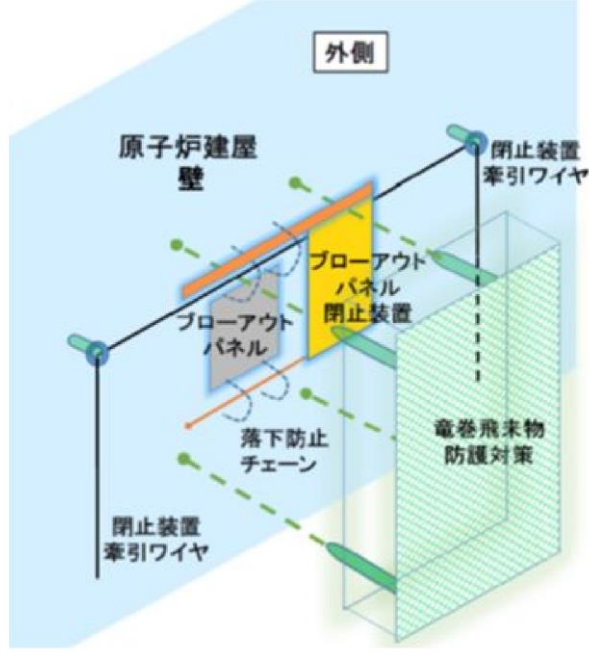
柏崎刈羽原子力発電所 6 / 7号炉 (2017.12.20)	東海第二発電所 (2018.9.18版)	島根原子力発電所 2号炉	備考
	<p>3.7 ブローアウトパネルに係る設計方針</p> <p>(1) ブローアウトパネル閉止装置</p> <p>原子炉建屋外側ブローアウトパネルの開放状態で炉心損傷した場合、各開口部に対応するブローアウトパネル閉止装置を速やかに閉止し、原子炉建屋の気密性が確保できる設計とする。気密性の高いJ I S等級（A4等級）の建具を用いることで、閉止時には原子炉建屋の負圧を確保する。また、遠隔及び手動による閉止機能を設置することにより、万一、電源がない状態でも閉止機能を維持する設計とする。なお、閉止機能は、以下のとおりである。詳細は、今後の詳細設計にて決定する。</p> <ul style="list-style-type: none"> ・遠隔閉止：電動扉方式（S A電源負荷） ・手動閉止：スライド扉にワイヤを取付け、これをウィンチで牽引することで閉止 <p>ブローアウトパネル閉止装置の概要図を第3.7-1図に示す。</p> <p>※1 A4等級：J I S A 1561に規定される気密性等級線に合致する気密性能を有するもの</p>  <p>第3.7-1図 ブローアウトパネル閉止装置 概要図</p>		<p>備考</p> <ul style="list-style-type: none"> ・資料構成の相違 <p>島根2号炉は59条補足説明資料にてブローアウトパネル閉止装置の設計方針を記載。</p>

柏崎刈羽原子力発電所 6 / 7号炉 (2017.12.20)	東海第二発電所 (2018.9.18版)	島根原子力発電所 2号炉	備考
	<p>(2) 竜巻飛来物防護対策 ブローアウトパネル閉止装置の開閉機能及び原子炉建屋外側ブローアウトパネルの開放機能に干渉しないように、防護ネット（40mmメッシュ）を設置する。防護ネットは、原子炉建屋外側ブローアウトパネル正面のみならず、上下左右にも設置し、極力、原子炉建屋外壁との間隙を防護する設計とする。なお、詳細は、今後の詳細設計にて決定する。</p> <p>(3) ブローアウトパネル強制開放装置 原子炉建屋内側から、油圧ジャッキにより原子炉建屋外側ブローアウトパネルを強制的に開放する装置を設置する。油圧配管は、屋内に敷設し、屋外に設置する油圧発生装置と接続する。また、開放機構を原子炉建屋内に設置し、ブローアウトパネル閉止装置及び竜巻飛来物防護対策の防護ネットとの干渉を回避する設計とする。なお、作動液も含め、詳細は、今後の詳細設計にて決定する。 油圧ジャッキ設置イメージを第3.7-2図に、ブローアウトパネル開閉前後イメージを第3.7-3図に示す。</p> <div data-bbox="1041 1102 1584 1583" data-label="Diagram"> </div> <p>第3.7-2図 油圧ジャッキ設置イメージ</p>		

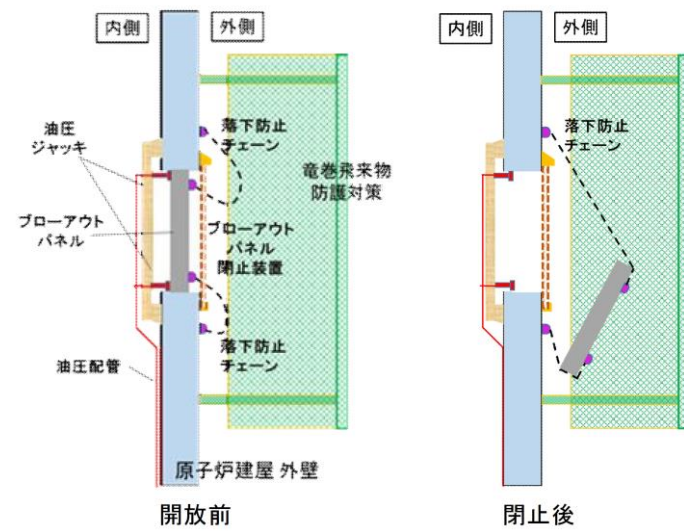

第3.7-3図 ブロアアウトパネル開閉前後イメージ

(4) ブロアアウトパネル開閉状態表示

原子炉建屋外側ブロアアウトパネルの各パネルにはリミットスイッチを設置し、開放したパネルを中央制御室にて特定できる設計とする。なお、詳細は、今後の詳細設計にて決定する。

ブロアアウトパネル開閉状態表示の概要図を第3.7-4図に示す。

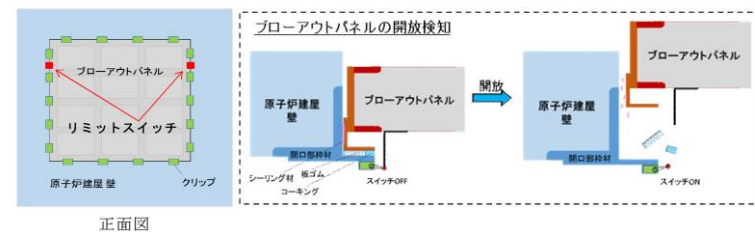

第3.7-4図 ブロアアウトパネル開閉状態表示 概要図

(5) ブロアアウトパネル閉止装置開閉状態表示

ブロアアウトパネル閉止装置についてもリミットスイッチを設置し、スライド扉の開閉状態を中央制御室にて特定できる設計とする。なお、詳細は、今後の設計により決定する。

ブロアアウトパネル閉止装置開閉状態表示の概要を第3.7-5図に示す。

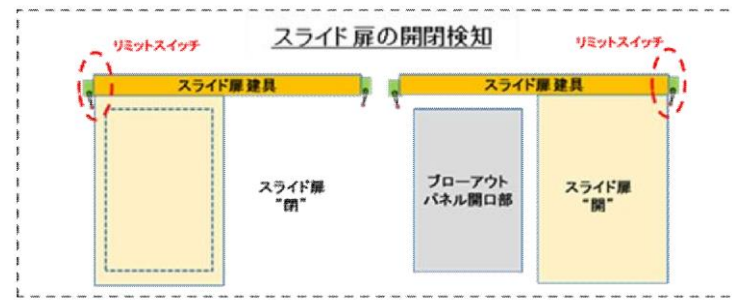

第3.7-5図 ブローアウトパネル閉止装置開閉状態表示 概要図

【参考】原子炉建屋気密性確保の成立性について

ブローアウトパネル閉止装置には、J I S A 1516「建具の気密性試験方法」の気密性等級線A4等級に合致する扉を設置することにより、原子炉建屋の気密性を確保する。なお、以下に示すように、A4等級の扉の許容漏えい量と原子炉建屋ガス処理系の排気容量から、原子炉建屋気密性が確保できることを以下に確認した。なお、詳細は、今後の詳細設計にて決定する。

- ◆設計上の気密要求である圧力差 63Pa [gage] において、
A4等級ドア 1m² 当たりの通気量は、12.6m³/h
- ◆ブローアウトパネル 12枚の開口面積合計は、186.51m²
- ◆ブローアウトパネル 12枚が全て開放し、当該パネル全てを再閉止した後の1h当たりの通気量は、2,350.02m³/h
- ◆SGTSの排風機の容量は、3,570m³/hであり、上記の通気量を大きく上まわる。(十分に負圧達成が可能)

A4等級扉イメージを第3.7-6図に、気密等級線図(A4等級)を第3.7-7図に示す。



第3.7-6図 A4等級扉イメージ

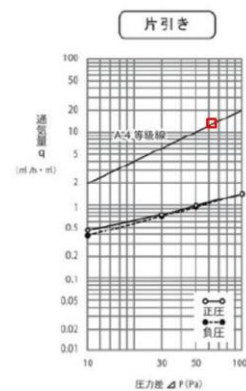

第3.7-7図 気密等級線図(A4等級)